

**Certification Report on**

**Specific Absorption Rate (SAR)  
Experimental Analysis**

**Sharewave, Inc.**

**Power Wave 2.4G Radio**

**Date: 07 May, 1999**



**This report shall not be reproduced, except in full,  
without the express written approval of APREL Laboratories.**

**CERTIFICATION REPORT (REVISED)**

Subject: **Specific Absorption Rate (SAR) Experimental Analysis**

Product: **ShareWave Power Wave 2.4G Radio**

Client: **ShareWave, Inc.**

Address: **5175 Hillside Circle  
El Dorado Hills  
CA 95762**

Project #: **SHWB-PowerWave Rev.2-3174**

Prepared by: **APREL Laboratories  
51 Spectrum Way  
Nepean, Ontario  
K2R 1E6**

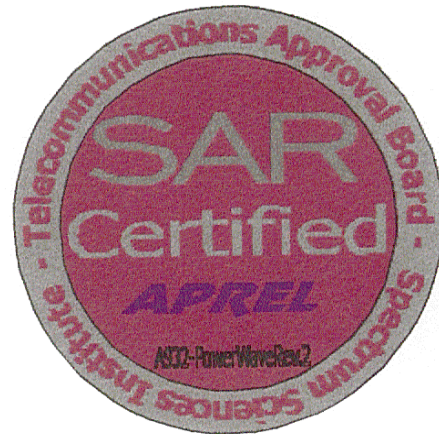

Submitted by Paul A. Cardinal Date: 07 May 99  
Dr. Paul G. Cardinal  
Director, Laboratories

Approved by J. J. Wojcik Date: May 7/99  
Dr. Jacek J. Wojcik, P. Eng.

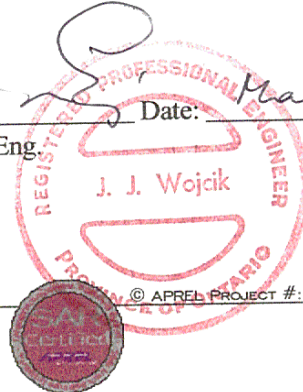

**CERTIFICATION REPORT (REVISED)**

Subject: **Specific Absorption Rate (SAR) Experimental Analysis**

Product: **ShareWave Power Wave 2.4G Radio**

Client: ShareWave, Inc.

Address: 5175 Hillsdale Circle  
El Dorado Hills  
CA 95762



Project #: SHWB-PowerWave Rev.2-3174

Prepared by: APREL Laboratories  
51 Spectrum Way  
Nepean, Ontario  
K2R 1E6

Submitted by \_\_\_\_\_ Date: \_\_\_\_\_  
Dr. Paul G. Cardinal  
Director, Laboratories

Approved by \_\_\_\_\_ Date: \_\_\_\_\_  
Dr. Jacek J. Wojcik, P. Eng.



FCC ID: N9PSW1-2450  
Applicant: ShareWave, Inc.  
Equipment: Digital Radio  
Model: Power Wave 2.4G Radio  
Standard: FCC 96 –326, Guidelines for Evaluating the Environmental Effects of Radio-Frequency Radiation

## ENGINEERING SUMMARY

This report contains the results of the engineering evaluation performed on a ShareWave Power Wave 2.4G Radio. The measurements were carried out in accordance with FCC 96-326. The Power Wave 2.4G Radio was evaluated for its maximum power level of Power Level of 20.4 dBm (110 mW).

The digital radio was tested at high, middle, and low frequencies, on both sides of the transmitting structure (“paddle”) with the maximum SAR coinciding with the peak performance RF output power of channel 1 (low, 2425 MHz) on the inside surface of the paddle. Test data and graphs are presented in this report.

Based on the test results, it is certified that the product meets the requirements as set forth in the above specifications, for uncontrolled RF exposure environment.



## TABLE OF CONTENTS

1. Introduction.....	4
2. Applicable Documents .....	4
3. Equipment Under Test .....	4
4. Test Equipment .....	5
5. Test Methodology .....	5
6. Test Results.....	6
6.1. Transmitter Characteristics .....	6
6.2. SAR Measurements.....	6
7. Conclusion.....	9
Appendix A.....	10
Appendix B.....	16
Appendix C .....	17
Appendix D.....	18
Appendix E.....	22



## 1. INTRODUCTION

Tests were conducted to determine the Specific Absorption Rate (SAR) of a sample of a ShareWave Power Wave 2.4G Radio. These tests were conducted at APREL Laboratories' facility located at 51 Spectrum Way, Nepean, Ontario, Canada. A view of the SAR measurement setup can be seen in Appendix A Figure 2. This report describes the results obtained.

## 2. APPLICABLE DOCUMENTS

The following documents are applicable to the work performed:

- 1) FCC 96-326, Guidelines for Evaluating the Environmental Effects of Radio-Frequency Radiation
- 2) ANSI/IEEE C95.1-1992, IEEE Standard for Safety Levels with Respect to Human Exposure to Radio Frequency Electromagnetic Fields, 3 kHz to 300 GHz.
- 3) ANSI/IEEE 95.3-1992, IEEE Recommended Practice for the Measurement of Potentially Hazardous Electromagnetic Fields – RF and Microwave.
- 4) OET Bulletin 65 (Edition 97-01) Supplement C (Edition 97-01), "Evaluating Compliance with FCC Guidelines for Human Exposure to Radio Frequency Electromagnetic Fields".

## 3. EQUIPMENT UNDER TEST

- ShareWave Model Power Wave 2.4G Radio, (sample 1)

The transmission antenna consists of a patch centred on a printed circuit board, and is positioned inside the movable plastic housing. The antenna specifications supplied by the manufacturer can be found in Appendix B.



#### 4. TEST EQUIPMENT

- Narda 8021B miniature E-field probe, s/n 04007, Asset # 301339
- CRS Robotics A255 articulated robot arm, s/n RA2750, Asset # 301355
- CRS Robotics C500 robotic system controller, s/n RC584, Asset # 201354
- R&S NRVS power meter, s/n 864268/017, Asset # 100851
- APREL F-2 flat manikin, s/n 001
- Tissue Recipe and Calibration Requirements, APREL procedure SSI/DRB-TP-D01-033

#### 5. TEST METHODOLOGY

1. The test methodology utilised in the certification of the Power Wave 2.4G Radio complies with the requirements of FCC 96-326 and ANSI/IEEE C95.3-1992.
2. The E-field is measured with a small isotropic probe (output voltage proportional to  $E^2$ ).
3. The probe is moved precisely from one point to the next using the robot (10 mm increments for wide area scanning, 5 mm increments for zoom scanning, and 2.5 mm increments for the final depth profile measurements).
4. The probe travels in the homogeneous liquid simulating human tissue. Appendix D contains information about the recipe and properties of the simulated tissue used for these measurements.
5. The liquid is contained in a manikin simulating a portion of the human body.
6. The Power Wave 2.4G Radio is positioned in such a way that it either touches the bottom of the phantom with either the outside or the inner side of the transmitting paddle.
7. All tests were performed with the highest power available from the sample Power Wave 2.4G Radio, under transmit conditions.

More detailed descriptions of the test method is given in Section 6 when appropriate.





## 6. TEST RESULTS

### 6.1. TRANSMITTER CHARACTERISTICS

The Power Wave 2.4G digital radio receives its power from the power supply to which it is connected. The radio, computer board, and power supply used in the setup are shown in Appendix A, Figure 1. Consequently, the digital radio's output power will not be dependent on the power usage under test conditions. The following table shows the conducted RF power measured for each of the three transmitting channels before starting the SAR measurements:

Channel		HP Power Meter	Adapter Cable Loss	Power at Antenna Feedpoint
#	Frequency			
	(MHz)	(dBm)	(dB)	(dBm)
1	2425	19.8	0.6	20.4
2	2440	18.3	0.6	18.9
3	2455	18.7	0.6	19.3

### 6.2. SAR MEASUREMENTS

- 1) RF exposure is expressed as a Specific Absorption Rate (SAR). SAR is calculated from the E-field, measured in a grid of test points as shown in Appendix A Figure 3. SAR is expressed as RF power per kilogram of mass, averaged in 1 cubic centimetre of tissue.
- 2) The ShareWave Power Wave 2.4G Radio was put into test mode for the SAR measurements by application software running from an EPROM, supplied by ShareWave, to control the channel (L, M, H, 2425 MHz, 2440 MHz, 2455 MHz, respectively) and maximum operating power (nominally 19.5 dBm).
- 3) Figure 4 in Appendix A shows a contour plot of the SAR measurements for the ShareWave Power Wave 2.4G Radio sample operating on the low channel. The



presented values were taken 2.5 mm into the simulated tissue from the Flat Phantom's solid inner surface. Figure 2 in Appendix A shows the phantom used in the measurements. The separation was 0 mm for the data presented in Figure 4. The axis of the antenna-housing is aligned with the  $y = 0$  cm gridline, with the radio housing butting up against the phantom wall. A grid is shown inside the phantom indicating the orientation of the x-y grid used, with the origin (0,0) half way up the right hand side. The x-axis is positive towards the left and the y-axis is positive towards the bottom.

A different presentation of the same data is shown in Appendix A Figure 5. This is a surface plot, where the measured SAR values provide the vertical dimension, which is useful as a visualisation aid.

Wide area scans were also performed for the middle (2) and high (3) channels. The peak single point SAR for these scans were:

Channel		Highest Local SAR (W/kg)
	(MHz)	
Low (1)	2425	1.28
Middle (2)	2440	1.00
High (3)	2455	1.22

- 4) Area scan data was then obtained at 12.5 mm into the simulated brain tissue on the low channel. These measurements are presented as a contour plot in Appendix A Figure 6 and surface plot in Figure 7.

Figure 8 shows an overlay of the antenna-housing's outline, superimposed onto the contour plot previously shown as Figure 4.

Figures 4 and 7 show that there is a dominant peak, in the contour plots, that diminishes in magnitude with depth into the tissue simulation.

- 5) The low channel (1) SAR peak was then explored on a refined 0.5 cm grid in three dimensions. Appendix A Figures 9, 10, and 11 show the measurements made at 2.5, 7.5 and 12.5 mm respectively. The SAR value averaged over  $1 \text{ cm}^3$  was determined from these measurements by averaging the 27 points ( $3 \times 3 \times 3$ ) comprising a  $1 \text{ cm}^3$  cube. The maximum SAR value measured averaged over  $1 \text{ cm}^3$  was determined from these measurements to be  $0.553 \text{ W/kg}$ .
- 6) To extrapolate the maximum SAR value averaged over  $1 \text{ cm}^3$  to the inner surface of the head phantom a series of measurements were made at a few (x,y) co-ordinates

within the refined grid as a function of depth, with 2.5 mm spacing. Appendix A Figure 12 shows the data gathered and the exponential curves fit to them (Microsoft Excel 97). The average exponential coefficient was determined to be  $(-0.1016 \pm 0.0020)/\text{mm}$ .

The distance from the probe tip to the inner surface of the head phantom for the lowest point is 2.5 mm. The distance from the probe tip to the tip of the measuring dipole within the Narda 8021B miniature RF probe is 7 mm. The total extrapolation distance is 9.5 mm, the sum of these two.

Applying the exponential coefficient over the 9.5 mm to the maximum SAR value average over  $1 \text{ cm}^3$  that was determined previously, we obtain **the maximum SAR value at the surface averaged over  $1 \text{ cm}^3$  of 1.452 W/kg**.



## 7. CONCLUSION

The maximum Specific Absorption Rate (SAR) averaged over 1 g, determined at 2425 MHz (channel 1, low), of the ShareWave, Inc. Model Power Wave 2.4G Radio, is 1.452 W/kg. The overall margin of uncertainty for this measurement is  $\pm 12.7\%$ . The SAR limit given in the FCC 96-326 safety guideline is 1.6 W/kg. This unit as tested and as it will be marketed, is found to be compliant with this requirement



## APPENDIX A



Figure 1

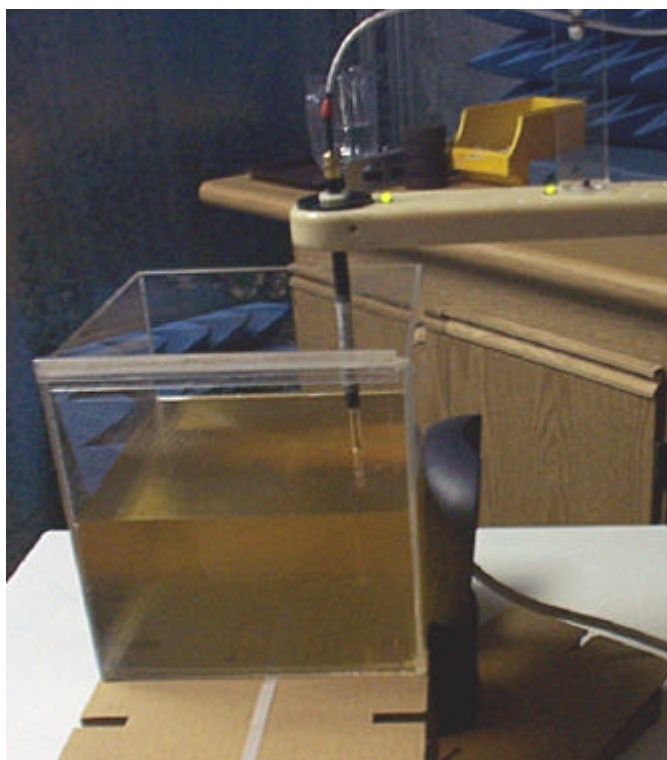

Figure 2

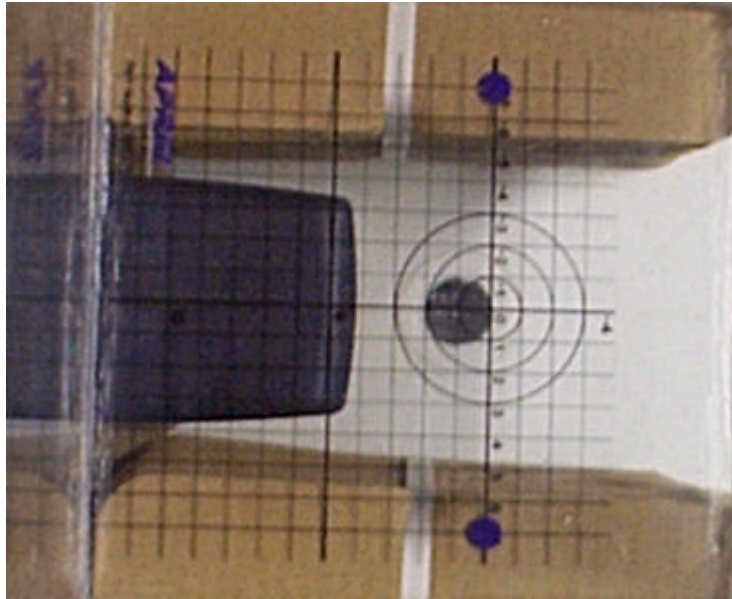

Figure 3

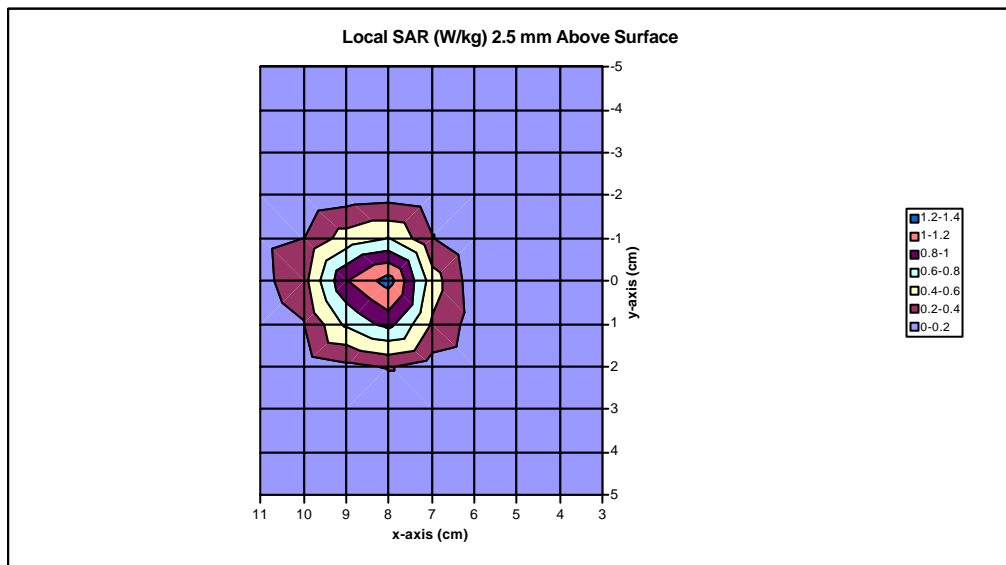

Figure 4



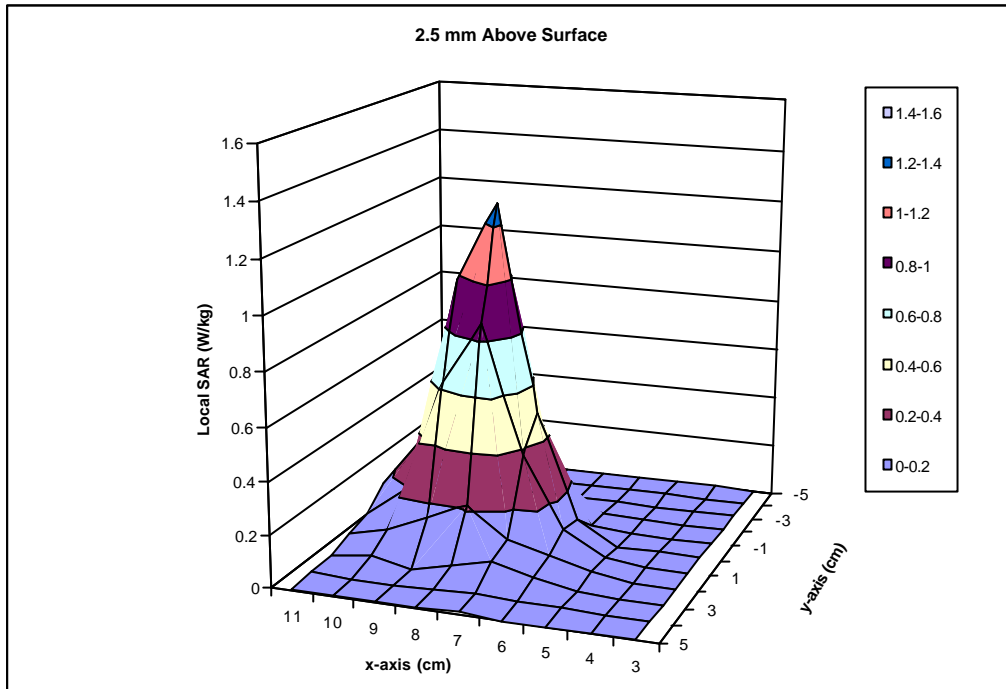

Figure 5

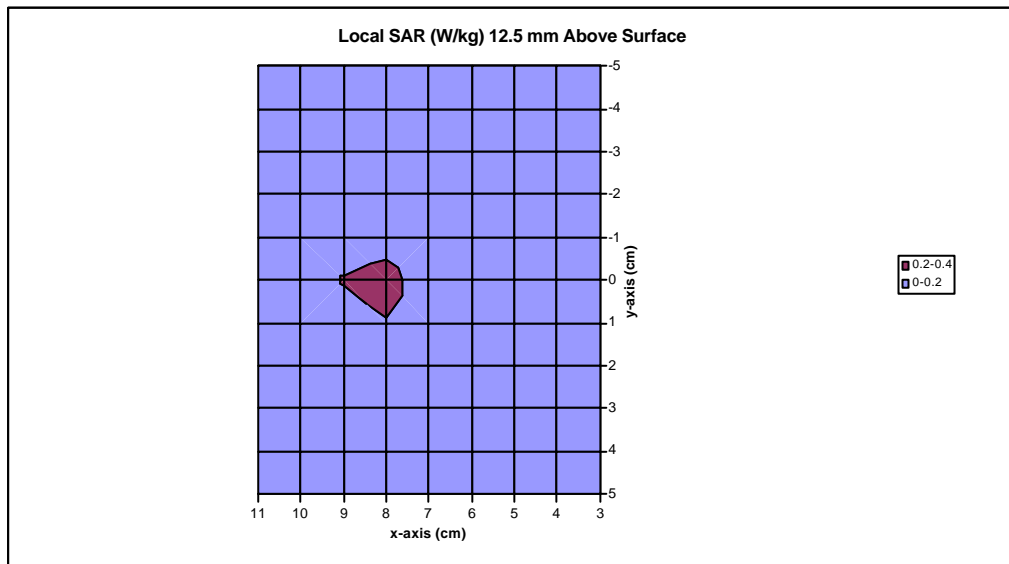

Figure 6



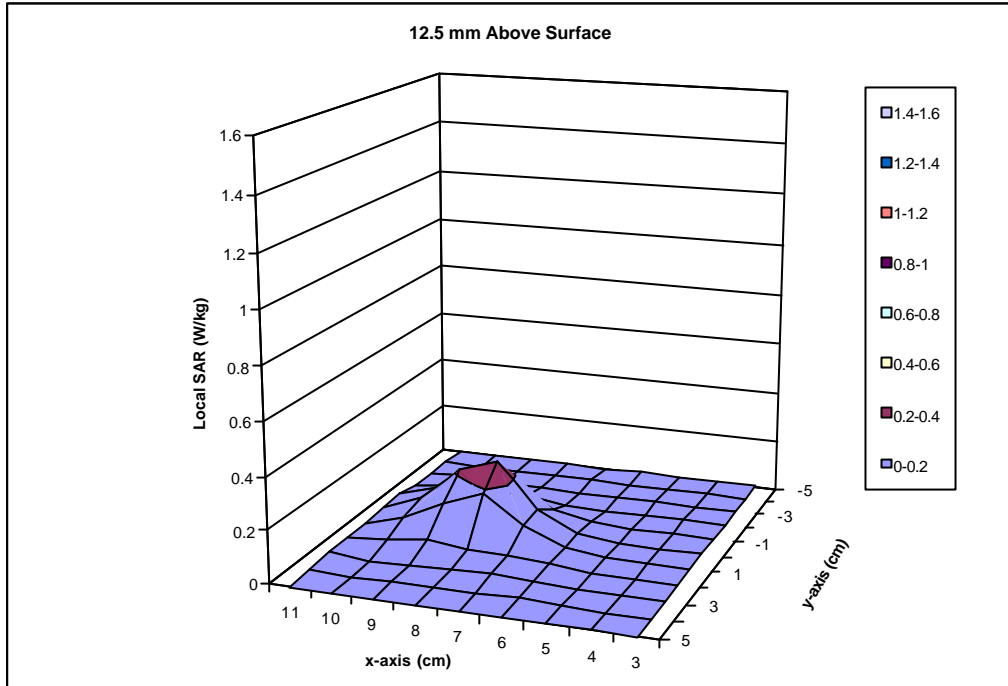

Figure 7

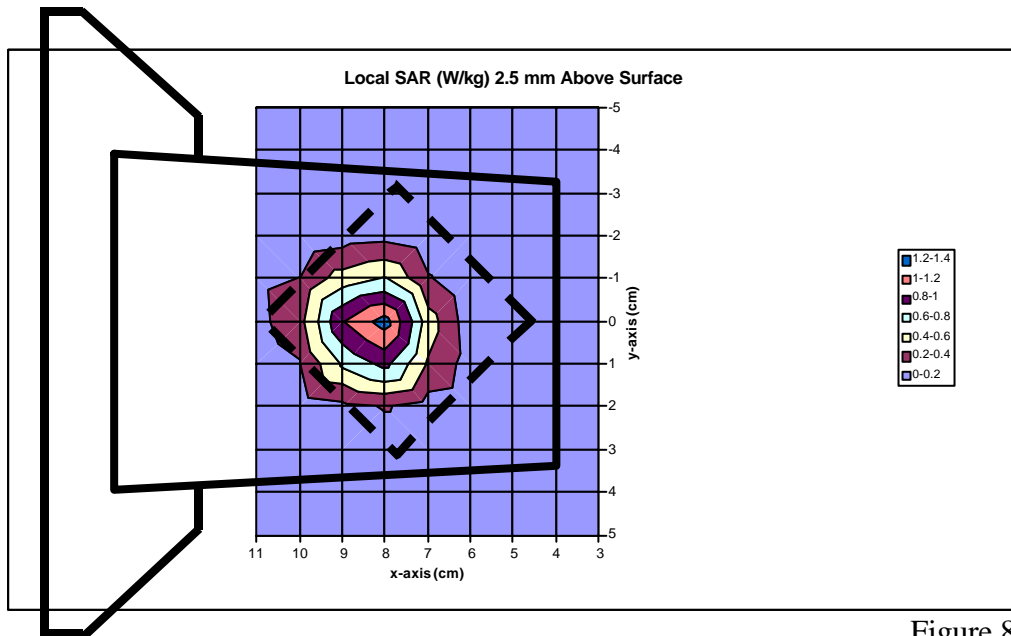

Figure 8





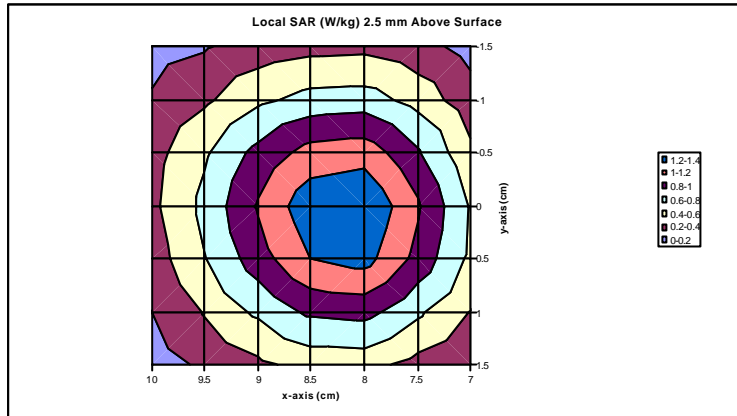

Figure 9

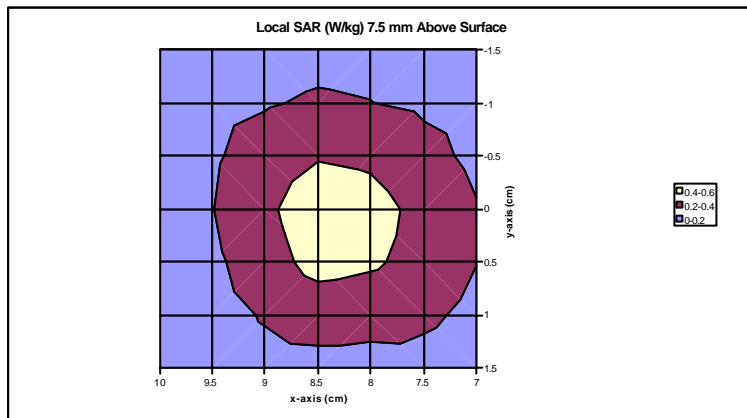

Figure 10

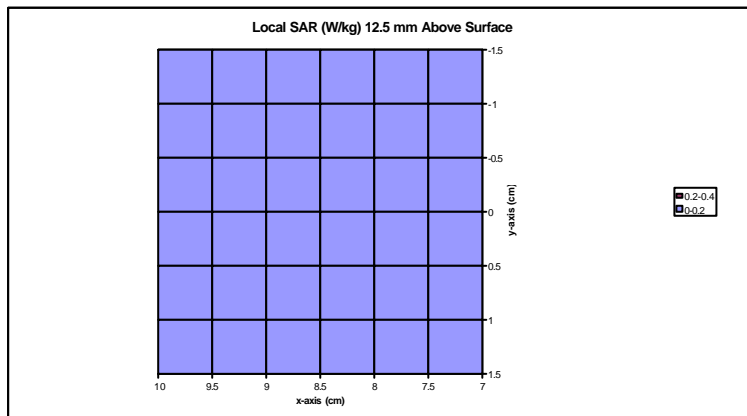

Figure 11



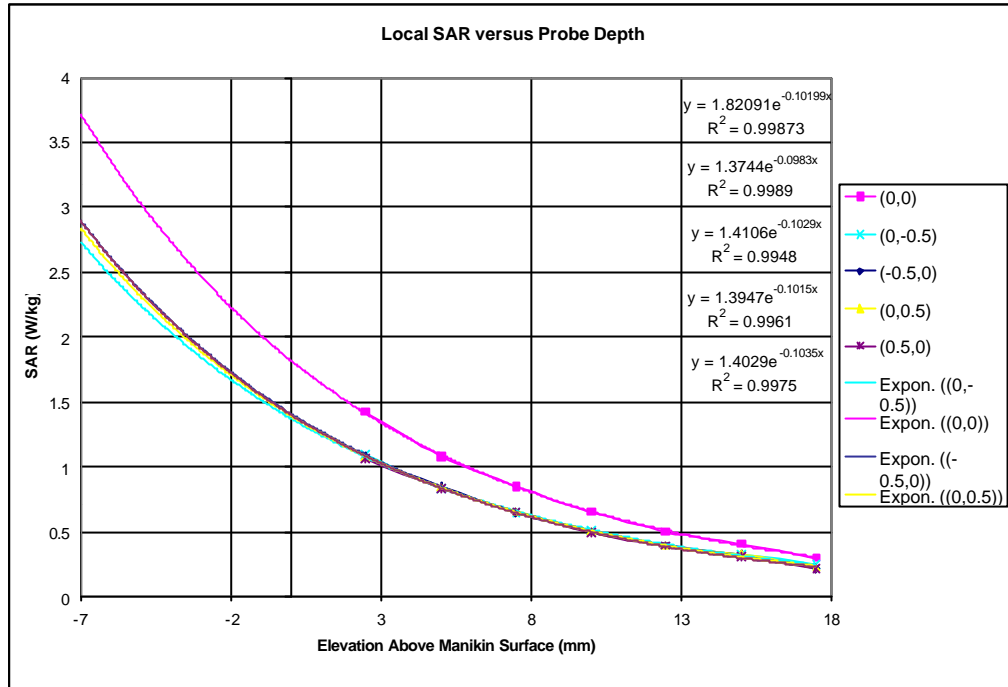

Figure 12



## APPENDIX B

### Manufacturer's Antenna Specifications



SHAREWAVE, INC

P/N: 200-0115-001

"ASSY, ANTENNA"

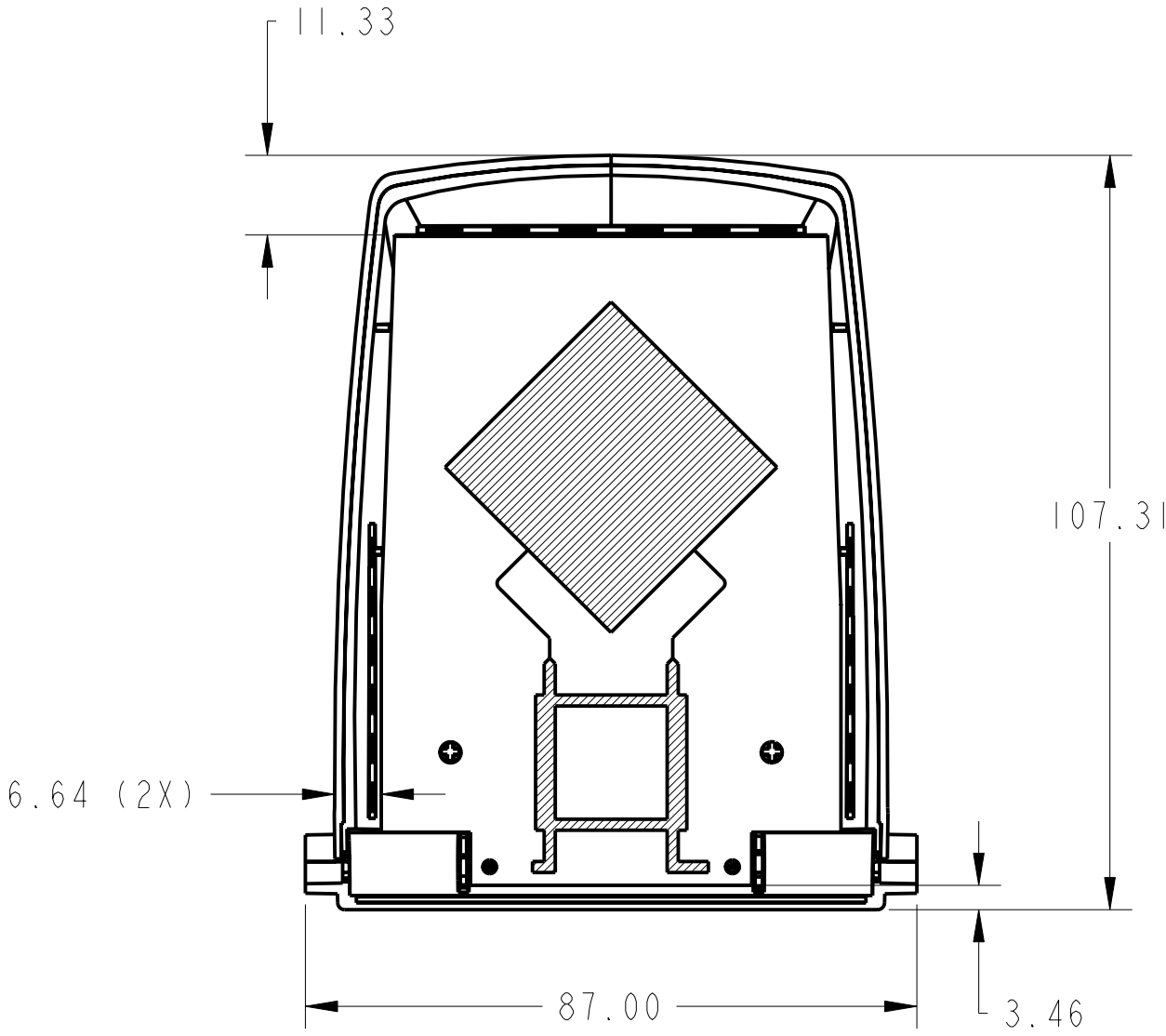

ALL DIMENSIONS IN MILLIMETERS

## APPENDIX C

### Uncertainty Budget

<b>Uncertainties Contributing to the Overall Uncertainty</b>		
<b>Type of Uncertainty</b>	<b>Specific to</b>	<b>Uncertainty</b>
Power variation due to battery condition	phone	0.0%
Extrapolation due to curve fit of SAR vs dept phone		4.0%
Extrapolation due to depth measurement	setup	5.0%
Conductivity	setup	6.0%
Density	setup	3.3%
Tissue enhancement factor	setup	7.0%
Voltage measurement	setup	3.7%
Probe sensitivity factor	setup	3.5%
		<b>12.7% RSS</b>



## APPENDIX D

### Simulated Tissue Material Properties

De-ionised water	73.8%
Di-ethylene Glycol Monobutyl Ether	26.2%
Mass density, $\rho$	0.953g/ml. (The density used to determine SAR from the measurements was the recommended 1040 kg/m <sup>3</sup> , found in Appendix C of Supplement C to OET Bulletin 65, Edition 97-01.)

Dielectric parameters of the tissue material were determined using a Hewlett Packard 8510 network analyzer, a Hewlett Packard 809B Slotted Line Carriage, and an APREL SLP-001 Slotted Line Probe. The dielectric properties are :

	APREL	OET 65 Supplement C	$\Delta / \%$
Dielectric constant, $\epsilon_r$	56.85	53.6	+6.1
Conductivity, $\sigma$ [S/m]	18.5	18.1	+2.2
Tissue conversion factor, $\gamma$	4.7	-	-



Measurement of Conductivity before the SAR Measurements:

The used conductivity for the SAR is the average of the conductivity measurements done before and after the SAR test.

SIMULATION FLUID# 26% Glycol  
CALIBRATION DATE 30-Apr-99  
CALIBRATED BY Heike  
Frequency Range 1GHz-2.5GHz  
Frequency Calibrated 2450 MHz  
Tissue Type

Position [cm]	Amplitude [dBm]	Phase [deg]
0	-35.21	-107.62
0.5	-37.34	147.45
1	-39.49	32.94
1.5	-41.5	-77.2
2	-43.6	167.87
2.5	-45.71	54.1
3	-47.6	-62.4
3.5	-49.68	-162.65
$\Delta$ dB <sub>1</sub>	-8.39	$\Delta$ deg <sub>1</sub>
$\Delta$ dB <sub>2</sub>	-8.37	$\Delta$ deg <sub>2</sub>
$\Delta$ dB <sub>3</sub>	-8.11	$\Delta$ deg <sub>3</sub>
$\Delta$ dB <sub>4</sub>	-8.18	$\Delta$ deg <sub>4</sub>
$\Delta$ dB <sub>AVG</sub> [dB]	-8.26	$\Delta$ deg <sub>AVG</sub> [deg]
dB <sub>AVG</sub> ( $\alpha$ <sub>AVG</sub> ) [dB/cm]	-4.13	deg <sub>AVG</sub> ( $\beta$ <sub>AVG</sub> ) [deg/cm]
( $\alpha$ <sub>AVG</sub> ) [NP/cm]	-0.47562773	( $\beta$ <sub>AVG</sub> ) [rad/cm]
f [Hz]	2.45E+09	
$\mu$ [H/cm]	1.25664E-08	
$\epsilon_0$ [F/cm]	8.854E-14	
$\epsilon_r$	57.54	
$\sigma$ effective [S/m]	1.93	

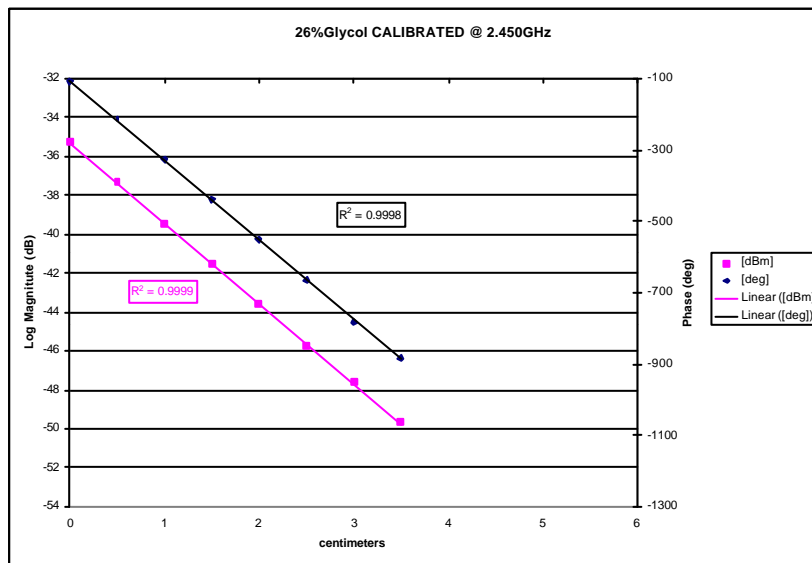

Measurement of Conductivity after the SAR Measurements:

SIMULATION FLUID # **26% Glycol**  
 CALIBRATION DATE **30-Apr-99**  
 CALIBRATED BY **Heike**  
 Frequency Range **1GHz-2.5GHz**  
 Frequency Calibrated **2450 MHz**  
 Tissue Type

Position [cm]	Amplitude [dBm]	Phase [deg]
0	-34.29	-106.2
0.5	-36.26	142.91
1	-38.28	29.55
1.5	-40.22	-81.73
2	-42.08	166.5
2.5	-44.04	57.47
3	-45.83	-53.47
3.5	-47.79	-161.25
$\Delta$ dB <sub>1</sub>	-7.79	$\Delta$ deg <sub>1</sub>
$\Delta$ dB <sub>2</sub>	-7.78	$\Delta$ deg <sub>2</sub>
$\Delta$ dB <sub>3</sub>	-7.55	$\Delta$ deg <sub>3</sub>
$\Delta$ dB <sub>4</sub>	-7.57	$\Delta$ deg <sub>4</sub>
$\Delta$ dB <sub>AVG</sub> [dB]	-7.67	$\Delta$ deg <sub>AVG</sub> [deg]
dB <sub>AVG</sub> ( $\alpha$ AVG) [dB/cm]	-3.84	deg <sub>AVG</sub> ( $\beta$ AVG) [deg/cm]
( $\alpha$ AVG) [NP/cm]	-0.441665	( $\beta$ AVG) [rad/cm]
f [Hz]	<b>2.45E+09</b>	
$\mu$ [H/cm]	<b>1.257E-08</b>	
$\epsilon_0$ [F/cm]	<b>8.854E-14</b>	
$\epsilon_r$	56.15	
$\sigma$ effective [S/m]	1.77	

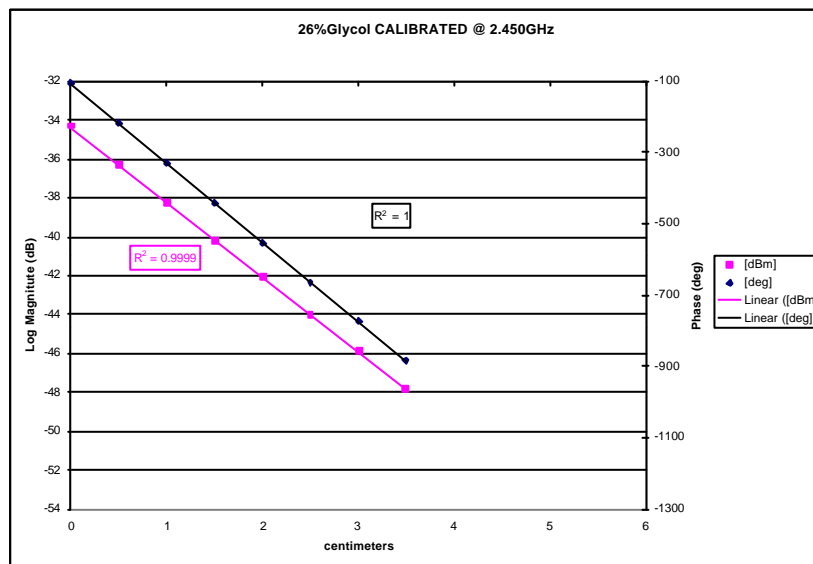



2450 MHz Data (Heike & Tony) BRAIN

						delta T	Sum	Thermal
RF Power			Ch0	Ch1	Ch2	(30 sec)	V/EI	SAR
W	dBm	R&S	uV	uV	uV	deg. C		W/kg
0.187932	22.74	-16.46	103	537	417	0.0083	1332.91	0.77
0.368129	25.66	-13.54	120	969	757	0.022	2331.29	2.04
0.562341	27.5	-11.7	134	1423	1111	0.0298	3371.5	2.76
0.751623	28.76	-10.44	151	1885	1477	0.0598	4440.91	5.53

Directional Coupler factor 19.2 dB (Asset 100251 cal file data (Janusz, 21 Jul 96))  
Additional inline attenuation 20 dB

Sensitivity (e) 0.55 0.54 0.51 - Sensor Sensitivity in mV/(mW/cm<sup>2</sup>)  
η = 1.50 e 0.825 0.81 0.765

Density 0.953 g/cm<sup>3</sup> 953 kg/m<sup>3</sup> - Tony + Heike 7 May 99  
Conductivity 18.5 mS/cm 1.85 S/m - 30 April 99 HW  
Heat Capacity (c) 2.775 J/C/g 2775 J/C/kg - average of Balzano (2.7) and Kuster (2.85) values  
Exposure Time 30 seconds 30 seconds  
Slope of Measure Voltage (m) 5497.2 uV/W 0.0055 V/W  
- standard error or m 38.6108 uV/W 3.9E-05 V/W 0.7%  
Slope of Measure Temp Change (m) 0.08613 CW 0.08613 CW  
- standard error or m 0.01714 CW 0.01714 CW 19.9%

Tissue Conversion Factor (k) 4.7

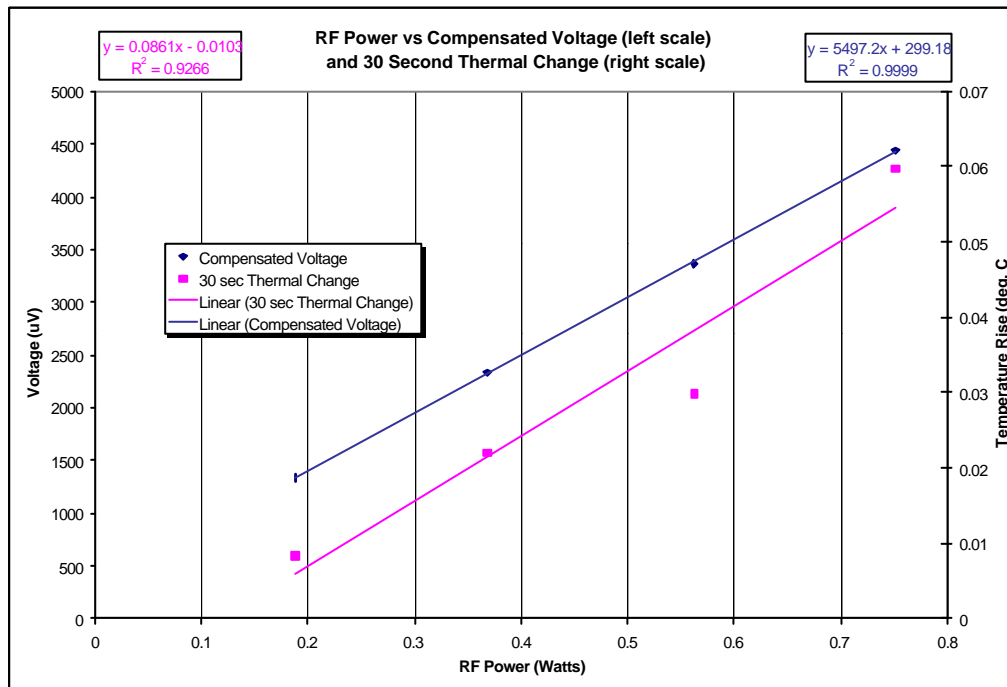

## APPENDIX E

### Validation Scan

