

FCC PART 15.247

TEST REPORT

For

Lierda Science & Technology Group Co., Ltd

Lierda Building, 425 Dengyun Road, Hangzhou, China

FCC ID: N8NLS4WF0459

Report Type: Original Report	Product Type: IOT WiFi Module
Test Engineer: Chris Wang	<i>Chris. Wang</i>
Report Number: RKS160620001-00C	
Report Date: 2016-09-26	
Reviewed By: EMC Manager	Jesse Huang
Prepared By: Bay Area Compliance Laboratories Corp. (Kunshan) Chenghu Road, Kunshan Development Zone No.248, Kunshan, Jiangsu, China Tel: +86-0512-86175000 Fax: +86-0512-88934268 www.baclcorp.com.cn	<i>Jesse. Huang</i>

Note: This test report is prepared for the customer shown above and for the equipment described herein. It may not be duplicated or used in part without prior written consent from Bay Area Compliance Laboratories Corp.

TABLE OF CONTENTS

GENERAL INFORMATION.....	4
PRODUCT DESCRIPTION FOR EQUIPMENT UNDER TEST (EUT).....	4
OBJECTIVE.....	4
RELATED SUBMITTAL(S)/GRANT(S).....	4
TEST METHODOLOGY.....	4
TEST FACILITY.....	5
SYSTEM TEST CONFIGURATION.....	6
DESCRIPTION OF TEST CONFIGURATION.....	6
EQUIPMENT MODIFICATIONS.....	6
EUT EXERCISE SOFTWARE.....	6
SUPPORT EQUIPMENT LIST AND DETAILS.....	7
EXTERNAL I/O CABLE.....	7
BLOCK DIAGRAM OF TEST SETUP.....	7
SUMMARY OF TEST RESULTS.....	8
FCC§15.247 (i), §1.1310& §2.1091 –MAXIMUM PERMISSIBLE EXPOSURE (MPE).....	9
APPLICABLE STANDARD.....	9
FCC §15.203 - ANTENNA REQUIREMENT.....	10
APPLICABLE STANDARD.....	10
ANTENNA CONNECTOR CONSTRUCTION.....	10
FCC §15.207 (a) – AC LINE CONDUCTED EMISSIONS.....	11
APPLICABLE STANDARD.....	11
MEASUREMENT UNCERTAINTY.....	11
EUT SETUP.....	11
EMI TEST RECEIVER SETUP.....	12
TEST PROCEDURE.....	12
TEST EQUIPMENT LIST AND DETAILS.....	12
CORRECTED FACTOR & MARGIN CALCULATION.....	12
TEST RESULTS SUMMARY.....	13
TEST DATA.....	13
FCC §15.209, §15.205 & §15.247(d) - SPURIOUS EMISSIONS.....	16
APPLICABLE STANDARD.....	16
MEASUREMENT UNCERTAINTY.....	16
EUT SETUP.....	16
EMI TEST RECEIVER & SPECTRUM ANALYZER SETUP.....	17
TEST PROCEDURE.....	17
TEST EQUIPMENT LIST AND DETAILS.....	18
CORRECTED AMPLITUDE & MARGIN CALCULATION.....	18
TEST RESULTS SUMMARY.....	18
TEST DATA.....	19
FCC §15.247(a) (2) – 6 dB EMISSION BANDWIDTH.....	29
APPLICABLE STANDARD.....	29
TEST PROCEDURE.....	29
TEST EQUIPMENT LIST AND DETAILS.....	29
TEST DATA.....	29
FCC §15.247(b) (3) - MAXIMUM CONDUCTED OUTPUT POWER.....	35

APPLICABLE STANDARD	35
TEST PROCEDURE	35
TEST EQUIPMENT LIST AND DETAILS.....	35
TEST DATA	35
FCC §15.247(d) – 100 kHz BANDWIDTH OF FREQUENCY BAND EDGE.....	38
APPLICABLE STANDARD	38
TEST PROCEDURE	38
TEST EQUIPMENT LIST AND DETAILS.....	38
TEST DATA	38
FCC §15.247(e) - POWER SPECTRAL DENSITY	42
APPLICABLE STANDARD	42
TEST PROCEDURE	42
TEST EQUIPMENT LIST AND DETAILS.....	42
TEST DATA	42

GENERAL INFORMATION

Product Description for Equipment under Test (EUT)

The Lierda Science & Technology Group Co., Ltd's product, model number: LSD4WF0459-01D0 (FCC ID: N8NLS4WF0459) or the "EUT" in this report is a WiFi Module, which was measured approximately: 18mm(L)x25mm(W)x3.0mm(H). rated input voltage: DC3.3V.

**All measurement and test data in this report was gathered from production sample serial number: 20160530006.*

(Assigned by BACL, Kunshan). The EUT supplied by the applicant was received on 2016-05-30.

Objective

This report is prepared on behalf of Lierda Science & Technology Group Co., Ltd in accordance with Part 2-Subpart J, Part 15-Subparts A, B and C of the Federal Communication Commissions rules.

The tests were performed in order to determine compliance with FCC Part 15, Subpart C, and section 15.203, 15.205, 15.207, 15.209 and 15.247 rules.

Related Submittal(s)/Grant(s)

N/A

Test Methodology

All measurements contained in this report were conducted with ANSI C63.10-2013, American National Standard of Procedures for Compliance Testing of Unlicensed Wireless Devices and FCC KDB558074 D01 DTS Meas Guidance v03r05.

All emissions measurement was performed at Bay Area Compliance Laboratories Corp. (Kunshan). The radiated testing was performed at an antenna-to-EUT distance of 3 meters.

Measurement uncertainty with RF radiated emission is 5.91 dB for 30MHz-1GHz.and 4.92 dB for above 1GHz, 1.95dB for conducted measurement.

Test Facility

The test site used by Bay Area Compliance Laboratories Corp. (Kunshan) to collect test data is located on the Chenghu Lake Road, Kunshan Development Zone No.248, Kunshan, Jiangsu, China

Test site at Bay Area Compliance Laboratories Corp. (Kunshan) has been fully described in reports submitted to the Federal Communication Commission (FCC). The details of these reports have been found to be in compliance with the requirements of Section 2.948 of the FCC Rules on November 06, 2014. The facility also complies with the radiated and AC line conducted test site criteria set forth in ANSI C63.4.

The Federal Communications Commission has the reports on file and is listed under FCC Registration No.: 815570. The test site has been approved by the FCC for public use and is listed in the FCC Public Access Link (PAL) database.

SYSTEM TEST CONFIGURATION

Description of Test Configuration

For 802.11b, 802.11g and 802.11n-HT20 mode, 11 channels are provided to testing:

Channel	Frequency (MHz)	Channel	Frequency (MHz)
1	2412	8	2447
2	2417	9	2452
3	2422	10	2457
4	2427	11	2462
5	2432	/	/
6	2437	/	/
7	2442	/	/

EUT was tested with Channel 1, 6 and 11.

Equipment Modifications

No modification was made to the EUT tested.

EUT Exercise Software

Radio Tool GUI & CCS UniFlash - CC3xxx Edition

The worst condition was performed under:
802.11b: Data rate: 1 Mbps, Power level: 16
802.11g: Data rate: 6 Mbps, Power level: 12
802.11n-HT20: Data rate: MCS0, Power level: 11

Support Equipment List and Details

Manufacturer	Description	Model	Serial Number
DELL	PC	GX620	D65874152
USB To UART Board	Debug Board	UTDB	B10065

External I/O Cable

Cable Description	Length (m)	From/Port	To
cable	No	USB To UART Board	EUT

Block Diagram of Test Setup

For conducted emission

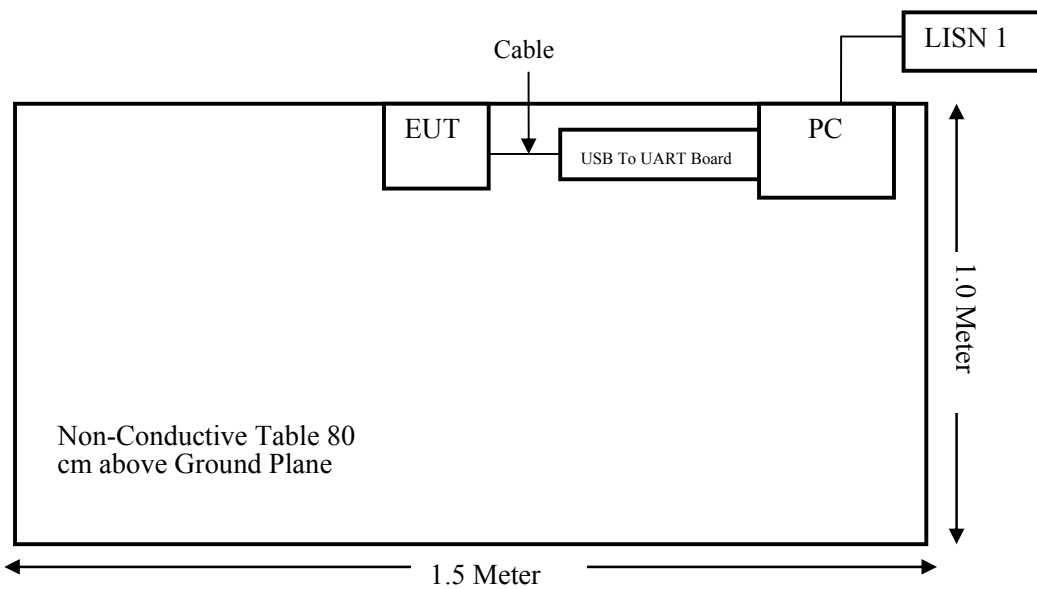

SUMMARY OF TEST RESULTS

FCC Rules	Description of Test	Result
§15.247 (i), §1.1310& §2.1091	MAXIMUM PERMISSIBLE EXPOSURE (MPE)	Compliance
§15.203	Antenna Requirement	Compliance
§15.207 (a)	AC Line Conducted Emissions	Compliance
§15.247(d)	Spurious Emissions at Antenna Port	Compliance
§15.205, §15.209, §15.247(d)	Spurious Emissions	Compliance
§15.247 (a)(2)	6 dB Emission Bandwidth	Compliance
§15.247(b)(3)	Maximum Conducted Output Power	Compliance
§15.247(d)	100 kHz Bandwidth of Frequency Band Edge	Compliance
§15.247(e)	Power Spectral Density	Compliance

FCC§15.247 (i), §1.1310& §2.1091 –MAXIMUM PERMISSIBLE EXPOSURE (MPE)

Applicable Standard

According to subpart 15.247(i)and subpart §1.1310, systems operating under the provisions of this section shall be operated in a manner that ensures that the public is not exposed to radio frequency energy level in excess of the Commission’s guidelines.

Limits for Maximum Permissible Exposure (MPE) (§1.1310, §2.1091)

(B) Limits for General Population/Uncontrolled Exposure				
Frequency Range (MHz)	Electric Field Strength (V/m)	Magnetic Field Strength (A/m)	Power Density (mW/cm²)	Averaging Time (minutes)
0.3-1.34	614	1.63	*(100)	30
1.34-30	824/f	2.19/f	*(180/f ²)	30
30-300	27.5	0.073	0.2	30
300-1500	/		f/1500	30
1500-100,000	/		1.0	30

f = frequency in MHz; * = Plane-wave equivalent power density;

According to §1.1310 and §2.1091 RF exposure is calculated.

Calculated Formulary:

Predication of MPE limit at a given distance

$S = PG/4 \pi R^2$ = power density (in appropriate units, e.g. mW/cm²);

P = power input to the antenna (in appropriate units, e.g., mW);

G = power gain of the antenna in the direction of interest relative to an isotropic radiator, the power gain factor, is normally numeric gain;

R = distance to the center of radiation of the antenna (appropriate units, e.g., cm);

Calculated Data:

Mode	Frequency (MHz)	Antenna Gain		Target Power		Evaluation Distance (cm)	Power Density (mW/cm²)	MPE Limit (mW/cm²)
		(dBi)	(numeric)	(dBm)	(mW)			
802.11b	2437	0.2	1.047	11.63	14.55	20	0.003	1.0
802.11g	2437	0.2	1.047	8.24	6.67	20	0.001	1.0
802.11n HT20	2437	0.2	1.047	6.21	4.18	20	0.001	1.0

Result: The device meet FCC MPE at 20 cm distance

FCC §15.203 - ANTENNA REQUIREMENT

Applicable Standard

According to § 15.203, an intentional radiator shall be designed to ensure that no antenna other than that furnished by the responsible party shall be used with the device. The use of a permanently attached antenna or of an antenna that uses a unique coupling to the intentional radiator shall be considered sufficient to comply with the provisions of this section. The manufacturer may design the unit so that a broken antenna can be replaced by the user, but the user of a standard antenna jack or electrical connector is prohibited. The structure and application of the EUT were analyzed to determine compliance with section §15.203 of the rules. §15.203 state that the subject device must meet the following criteria:

- a. Antenna must be permanently attached to the unit.
- b. Antenna must use a unique type of connector to attach to the EUT.

Unit must be professionally installed, and installer shall be responsible for verifying that the correct antenna is employed with the unit.

And according to FCC 47 CFR section 15.247 (b), if the transmitting antennas of directional gain greater than 6dBi are used, the power shall be reduced by the amount in dB that the directional gain of the antenna exceeds 6 dBi.

Antenna Connector Construction

The EUT has an IPEX connector antenna for wifi, which the antenna gain is 0.2 dBi, fulfill the requirement of this section. Please refer to the EUT photos.

Result: Compliance.

FCC §15.207 (a) – AC LINE CONDUCTED EMISSIONS

Applicable Standard

FCC§15.207

Measurement Uncertainty

Input quantities to be considered for conducted disturbance measurements may be receiver reading, attenuation of the connection between LISN and receiver, LISN voltage division factor, LISN VDF frequency interpolation and receiver related input quantities, etc.

Based on CISPR 16-4-2:2011, the expended combined standard uncertainty of conducted disturbance test at Bay Area Compliance Laboratories Corp. (Kunshan) is shown as below. And the uncertainty will not be taken into consideration for the test data recorded in the report.

Port	Expanded Measurement uncertainty
AC Mains	3.26 dB (k=2, 95% level of confidence)
CAT 3	3.70 dB (k=2, 95% level of confidence)
CAT 5	3.86 dB (k=2, 95% level of confidence)
CAT 6	4.64 dB (k=2, 95% level of confidence)

EUT Setup

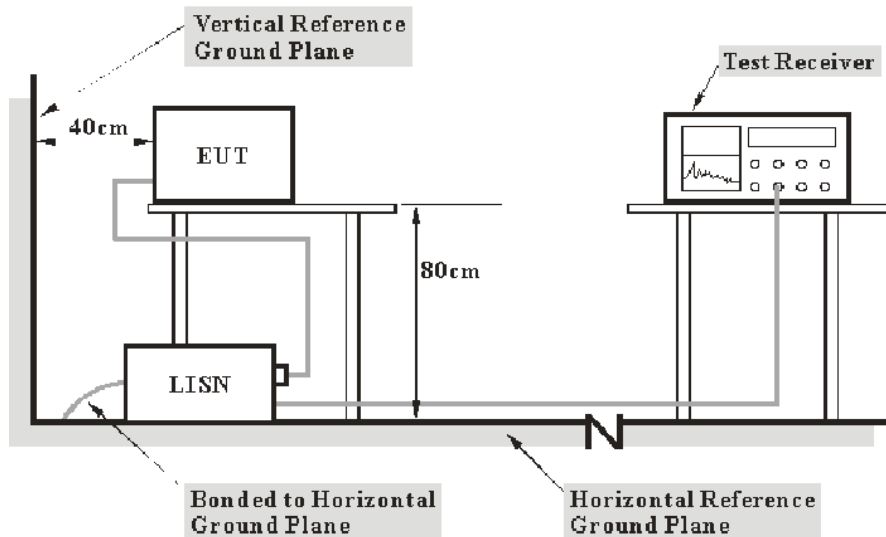

- Note: 1. Support units were connected to second LISN.
 2. Both of LISNs (AMN) 80 cm from EUT and at the least 80 cm from other units and other metal planes support units.

The setup of EUT is according with per ANSI C63.10-2013 measurement procedure. The specification used was with the FCC Part 15.207 limits.

The adapter was connected to a 120 VAC/60 Hz power source.

EMI Test Receiver Setup

The EMI test receiver was set to investigate the spectrum from 150 kHz to 30 MHz.

During the conducted emission test, the EMI test receiver was set with the following configurations:

Frequency Range	IF B/W
150 kHz – 30 MHz	9 kHz

Test Procedure

During the conducted emission test, the adapter was connected to the outlet of the LISN.

Maximizing procedure was performed on the six (6) highest emissions of the EUT.

All data was recorded in the Quasi-peak and average detection mode.

Test Equipment List and Details

Manufacturer	Description	Model	Serial Number	Calibration Date	Calibration Due Date
Rohde & Schwarz	EMI Test Receiver	ESCS30	934115/007	2015-11-12	2016-11-11
Rohde & Schwarz	LISN	ESH3-Z5	862770/011	2015-11-12	2016-11-11
Rohde & Schwarz	LISN	ESH3-Z5	892239/018	2016-07-04	2017-07-03
FCC	ISN	FCC-TLISN-T8-02	20376	2016-06-23	2017-06-22
MICRO-COAX	Coaxial line	UFB-293B-1-0480-50X50	97F0173	2015-10-01	2016-10-01
Rohde & Schwarz	CE Test software	EMC 32	V 09.10.0	--	--

* **Statement of Traceability:** Bay Area Compliance Laboratories Corp. (Kunshan) attests that all calibrations have been performed in accordance to requirements that traceable to National Primary Standards and International System of Units (SI).

Corrected Factor & Margin Calculation

The Corrected factor is calculated by adding LISN VDF (Voltage Division Factor), Cable Loss and Transient Limiter Attenuation. The basic equation is as follows:

$$\text{Correction Factor} = \text{LISN VDF} + \text{Cable Loss}$$

The “**Margin**” column of the following data tables indicates the degree of compliance with the applicable limit. For example, a margin of 7 dB means the emission is 7 dB below the limit. The equation for margin calculation is as follows:

$$\text{Margin} = \text{Limit} - \text{Corrected Amplitude}$$

Test Results Summary

According to the recorded data in following table, the EUT complied with the FCC Part 15.207, the worst margin reading as below:

7.12dB at 4.915000 MHz in the **Line** conducted mode

Refer to CISPR16-4-2:2011 and CISPR 16-4-1:2009, the measured level complies with the limit if

$$L_m + U_{(L_m)} \leq L_{lim} + U_{cispr}$$

In BAACL, $U_{(L_m)}$ is less than U_{cispr} , if L_m is less than L_{lim} , it implies that the EUT complies with the limit.

Test Data

Environmental Conditions

Temperature:	23 °C
Relative Humidity:	56 %
ATM Pressure:	101.0 kPa

The testing was performed by Chris Wang on 2016-09-01.

Test Mode: Transmitting

AC 120V/60 Hz, Line

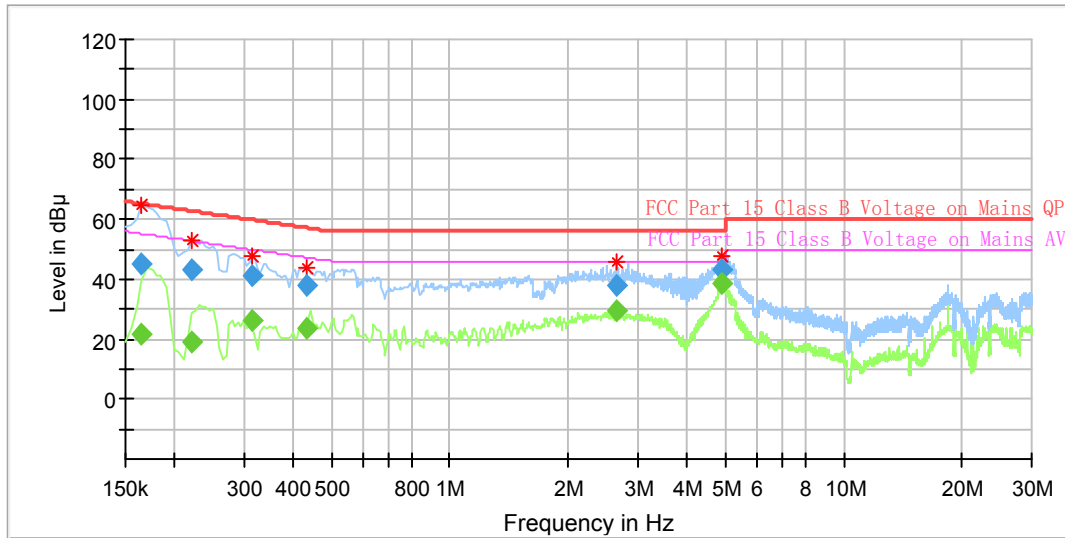

Frequency (MHz)	QuasiPeak (dBµV)	Average (dB µ V)	Bandwidth (kHz)	Line	Corr. (dB)	Margin (dB)	Limit (dBµV)	Comment
0.165000	---	21.56	9.000	L1	11.0	33.65	55.21	Compliance
0.165000	44.84	---	9.000	L1	11.0	20.37	65.21	Compliance
0.220000	---	19.22	9.000	L1	11.0	33.60	52.82	Compliance
0.220000	42.92	---	9.000	L1	11.0	19.90	62.82	Compliance
0.315000	---	26.51	9.000	L1	11.0	23.33	49.84	Compliance
0.315000	41.35	---	9.000	L1	11.0	18.49	59.84	Compliance
0.435000	---	23.73	9.000	L1	11.0	23.43	47.16	Compliance
0.435000	37.98	---	9.000	L1	11.0	19.18	57.16	Compliance
2.650000	---	29.48	9.000	L1	11.2	16.52	46.00	Compliance
2.650000	37.95	---	9.000	L1	11.2	18.05	56.00	Compliance
4.915000	---	38.88	9.000	L1	11.3	7.12	46.00	Compliance
4.915000	43.24	---	9.000	L1	11.3	12.76	56.00	Compliance

AC 120V/60 Hz, Neutral

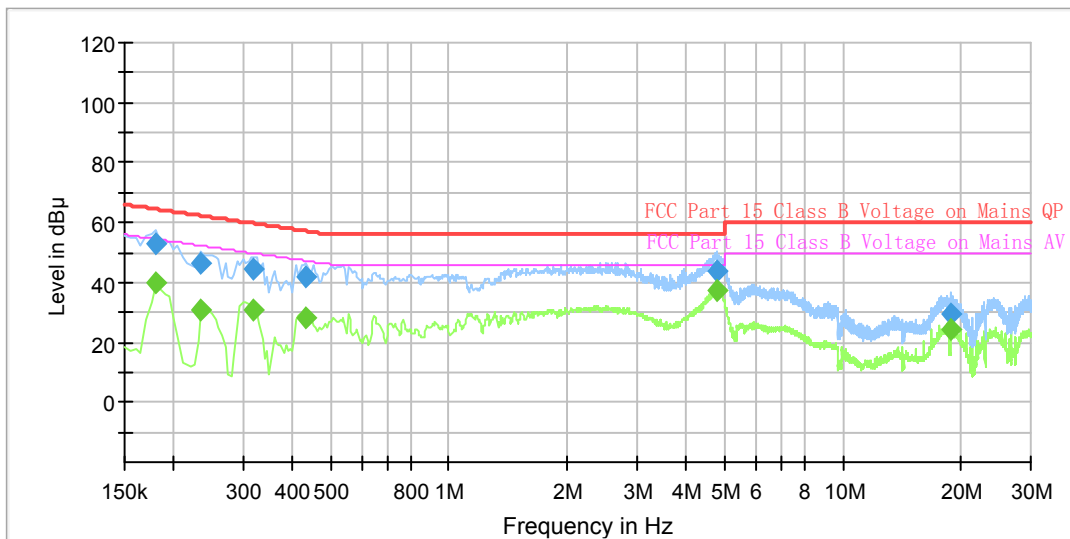

Frequency (MHz)	QuasiPeak (dBµV)	Average (dB µ V)	Bandwidth (kHz)	Line	Corr. (dB)	Margin (dB)	Limit (dBµV)	Comment
0.180000	---	40.00	9.000	N	11.0	14.49	54.49	Compliance
0.180000	52.83	---	9.000	N	11.0	11.66	64.49	Compliance
0.235000	---	30.78	9.000	N	11.0	21.49	52.27	Compliance
0.235000	46.31	---	9.000	N	11.0	15.96	62.27	Compliance
0.320000	---	31.10	9.000	N	11.0	18.61	49.71	Compliance
0.320000	44.39	---	9.000	N	11.0	15.32	59.71	Compliance
0.435000	---	28.10	9.000	N	11.0	19.06	47.16	Compliance
0.435000	41.76	---	9.000	N	11.0	15.40	57.16	Compliance
4.780000	---	37.25	9.000	N	11.4	8.75	46.00	Compliance
4.780000	43.56	---	9.000	N	11.4	12.44	56.00	Compliance
18.810000	---	24.23	9.000	N	11.4	25.77	50.00	Compliance
18.810000	29.65	---	9.000	N	11.4	30.35	60.00	Compliance

- Note:**
 1) Corr.=LISN VDF (Voltage Division Factor) + Cable Loss
 2) Corrected Amplitude = Reading + Corr.
 3) Margin = Limit –Corrected Amplitude

FCC §15.209, §15.205 & §15.247(d) - SPURIOUS EMISSIONS

Applicable Standard

FCC §15.247 (d); §15.209; §15.205;

Measurement Uncertainty

All measurements involve certain levels of uncertainties, especially in field of EMC. The factors contributing to uncertainties are spectrum analyzer, cable loss, antenna factor calibration, antenna directivity, antenna factor variation with height, antenna phase center variation, antenna factor frequency interpolation, measurement distance variation, site imperfections, mismatch (average), and system repeatability.

Based on CISPR 16-4-2:2011, the expanded combined standard uncertainty of radiation emissions at Bay Area Compliance Laboratories Corp. (Kunshan) is 5.91 dB for 30MHz-1GHz and 4.92 dB for above 1GHz, 1.95dB for conducted measurement at antenna port. And the uncertainty will not be taken into consideration for the test data recorded in the report

EUT Setup

Below 1 GHz:

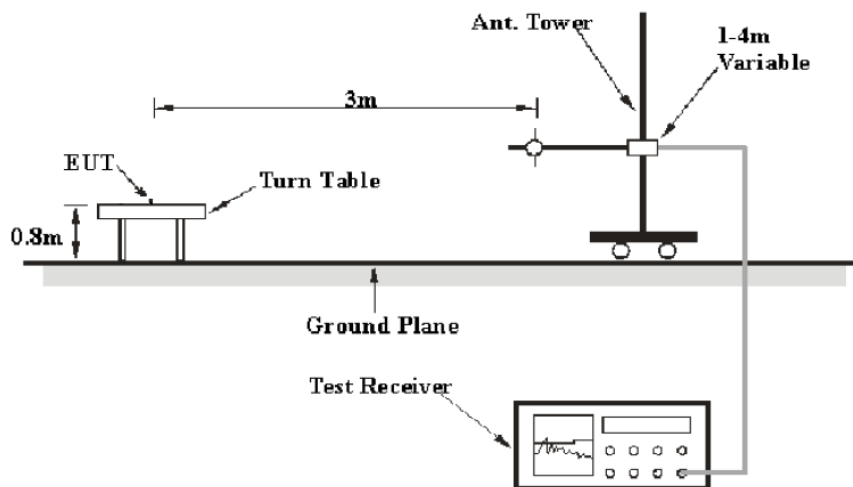

Above 1GHz:

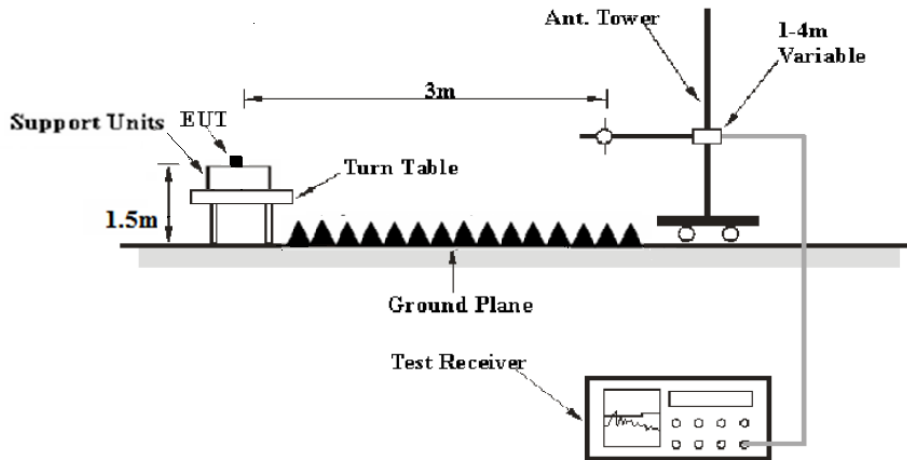

The radiated emission tests were performed in the 3 meters test site, using the setup accordance with the ANSI C63.10-2013. The specification used was the FCC 15.209, and FCC 15.247 limits.

EMI Test Receiver & Spectrum Analyzer Setup

The system was investigated from 30 MHz to 25 GHz.

During the radiated emission test, the EMI test receiver & Spectrum Analyzer Setup were set with the following configurations:

Frequency Range	RBW	Video B/W	IF B/W	Detector
30 MHz – 1000 MHz	100 kHz	300 kHz	120 kHz	QP
Above 1 GHz	1MHz	3 MHz	/	PK
	1MHz	10 Hz	/	Ave.

Test Procedure

Maximizing procedure was performed on the highest emissions to ensure that the EUT complied with all installation combinations.

Data was recorded in Quasi-peak detection mode for frequency range of 30 MHz-1 GHz, peak and Average detection modes for frequencies above 1 GHz.

Test Equipment List and Details

Manufacturer	Description	Model	Serial Number	Calibration Date	Calibration Due Date
Sonoma Instrument	Amplifier	330	171377	2015-09-16	2016-09-15
Rohde & Schwarz	EMI Test Receiver	ESCI	100195	2015-11-12	2016-11-11
Sunol Sciences	Broadband Antenna	JB3	A090314-2	2015-11-07	2016-11-06
ETS	Horn Antenna	3115	6229	2015-11-07	2016-11-06
EMCO	Horn Antenna	3116	9510-2384	2015-11-07	2016-11-06
Rohde & Schwarz	SIGNAL ANALYZER	FSV40	101116	2016-07-04	2017-07-03
Rohde & Schwarz	Signal Analyzer	FSIQ26	100048	2015-11-12	2016-11-11
Mini	Pre-amplifier	ZVA-183-S+	857001418	2015-09-16	2016-09-15
DUCOMMUN	Pre-amplifier	ALN-22093530-01	990147	2015-09-16	2016-09-15
champrotek	Chamber	Chamber A	1#	2015-09-17	2016-09-16
R&S	Auto test Software	EMC32	V 09.10.0	-	-
BACL	RF cable	KS-LAB-012	KS-LAB-012	2015-12-16	2016-12-15
BACL	RF cable	KS-LAB-010	KS-LAB-010	2015-12-16	2016-12-15

* **Statement of Traceability:** Bay Area Compliance Laboratories Corp. (Kunshan) attests that all calibrations have been performed in accordance to requirements that traceable to National Primary Standards and International System of Units (SI).

Corrected Amplitude & Margin Calculation

The Corrected Amplitude is calculated by adding the Antenna Factor and Cable Loss, and subtracting the Amplifier Gain from the Meter Reading. The basic equation is as follows:

$$\text{Corrected Amplitude} = \text{Meter Reading} + \text{Antenna Factor} + \text{Cable Loss} - \text{Amplifier Gain}$$

The “**Margin**” column of the following data tables indicates the degree of compliance with the applicable limit. For example, a margin of 7dB means the emission is 7dB below the limit. The equation for margin calculation is as follows:

$$\text{Margin} = \text{Limit} - \text{Corrected Amplitude}$$

Test Results Summary

According to the recorded data in following table, the EUT complied with the FCC Title 47, Part 15, Subpart C, section 15.205, 15.209 and 15.247.

5.70 dB at 156.342500 MHz in the Horizontal polarization

Refer to CISPR16-4-2:2011 and CISPR 16-4-1:2009, the measured level complies with the limit if

$$L_m + U_{(L_m)} \leq L_{\text{lim}} + U_{\text{cispr}}$$

In BACL, $U_{(L_m)}$ is less than U_{cispr} , if L_m is less than L_{lim} , it implies that the EUT complies with the limit.

Test Data

Environmental Conditions

Temperature:	24 °C
Relative Humidity:	60 %
ATM Pressure:	101.0 kPa

The testing was performed by Chris Wang on 2016-08-29&2016-09-02.

30 MHz-1 GHz:

EUT operation mode: Transmitting

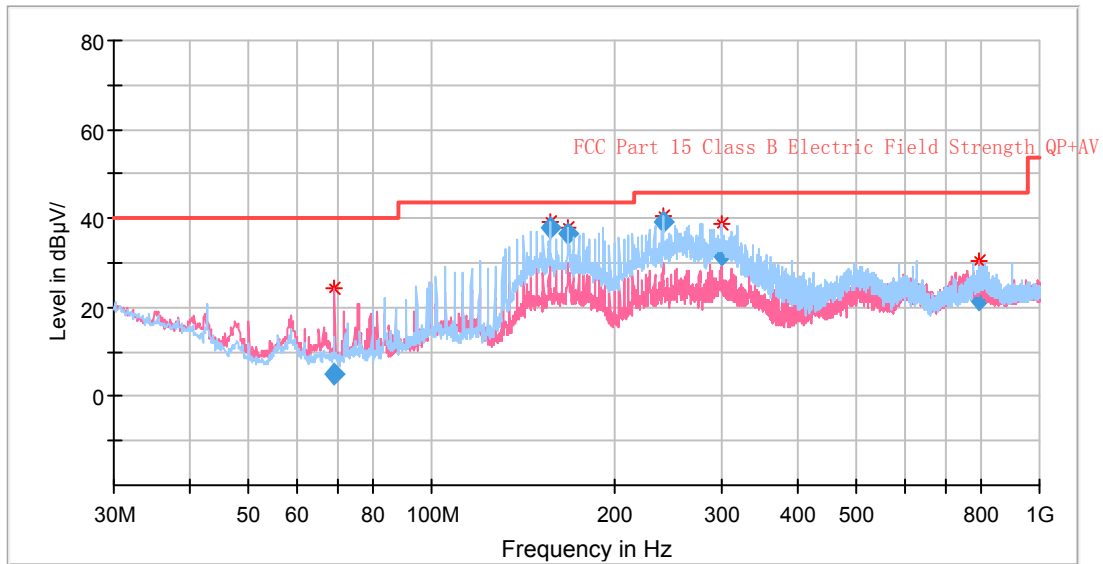

Frequency (MHz)	Receiver		Turntable Degree	Rx Antenna		Corrected Factor (dB)	Corrected Amplitude (dBµV/m)	FCC Part 15.247/205/209	
	Reading (dBµV)	Detector (PK/QP/Ave.)		Height (cm)	Polar (H/V)			Limit (dB µ V/m)	Margin (dB)
69.285000	22.10	QP	348.0	199.0	V	-17.1	5.00	40.00	35.00
156.342500	50.10	QP	17.0	199.0	H	-12.3	37.80	43.50	5.70
167.255000	48.90	QP	171.0	199.0	H	-12.2	36.70	43.50	6.80
240.005000	51.16	QP	185.0	101.0	H	-12.1	39.06	46.00	6.94
300.751250	41.99	QP	172.0	101.0	H	-10.4	31.59	46.00	14.41
793.996250	23.66	QP	90.0	101.0	V	-1.9	21.76	46.00	24.24

1GHz-25GHz

EUT operation mode: Transmitting

802.11b Mode

Frequency (MHz)	Receiver		Turntable Degree	Rx Antenna		Corrected Factor (dB)	Corrected Amplitude (dBµV/m)	FCC Part 15.247/205/209	
	Reading (dBµV)	Detector (PK/QP/Ave.)		Height (cm)	Polar (H/V)			Limit (dB µ V/m)	Margin (dB)
Low Channel (2412 MHz)									
2412	91.62	PK	54.0	150.0	V	4.9	96.52	/	/
2412	86.52	Ave	54.0	150.0	V	4.9	91.42	/	/
2412	91.04	PK	193.0	150.0	H	4.9	95.94	/	/
2412	85.58	Ave	193.0	150.0	H	4.9	90.48	/	/
2390	41.48	PK	325.0	200.0	H	4.9	46.38	74	27.62
2390	27.08	Ave	325.0	200.0	H	4.9	31.98	54	22.02
2400	24.47	Ave	104.0	150.0	H	4.9	29.37	54	24.63
2400	38.58	PK	104.0	150.0	H	4.9	43.48	74	30.52
3215	47.89	PK	177.0	150.0	H	7.4	55.29	74	18.71
3215	39.88	Ave	177.0	150.0	H	7.4	47.28	54	6.72
4824	32.34	PK	189.0	150.0	V	13.4	45.74	74	28.26
4824	17.97	Ave	189.0	150.0	V	13.4	31.37	54	22.63
7236	15.93	Ave	15.0	200.0	H	19.8	35.73	54	18.27
7236	30.33	PK	15.0	200.0	H	19.8	50.13	74	23.87
Middle Channel (2437 MHz)									
2437	93.42	PK	188.0	150.0	V	4.9	98.32	/	/
2437	87.89	Ave	188.0	150.0	V	4.9	92.79	/	/
2437	92.78	PK	226.0	200.0	H	4.9	97.68	/	/
2437	87.53	Ave	226.0	200.0	H	4.9	92.43	/	/
3249	43.64	PK	282.0	150.0	V	7.5	51.14	74	22.86
3249	34.61	Ave	282.0	150.0	V	7.5	42.11	54	11.89
4068	35.81	PK	80.0	150.0	V	10.3	46.11	74	27.89
4068	20.87	Ave	80.0	150.0	V	10.3	31.17	54	22.83
4874	33.05	PK	216.0	150.0	V	13.6	46.65	74	27.35
4874	18.45	Ave	216.0	150.0	V	13.6	32.05	54	21.95
6669	21.24	Ave	320.0	200.0	H	17.9	39.14	54	14.86
6669	35.54	PK	320.0	200.0	H	17.9	53.44	74	20.56
7311	31.54	PK	52.0	150.0	H	20.0	51.54	74	22.46
7311	16.70	Ave	52.0	150.0	H	20.0	36.70	54	17.30

Frequency (MHz)	Receiver		Turntable Degree	Rx Antenna		Corrected Factor (dB)	Corrected Amplitude (dBµV/m)	FCC Part 15.247/205/209	
	Reading (dBµV)	Detector (PK/QP/Ave.)		Height (cm)	Polar (H/V)			Limit (dBµV/m)	Margin (dB)
High Channel (2462 MHz)									
2462	93.67	PK	77.0	150.0	V	5.0	98.67	/	/
2462	89.21	Ave	77.0	150.0	V	5.0	94.21	/	/
2462	93.81	PK	240.0	150.0	H	5.0	98.81	/	/
2462	88.99	Ave	240.0	150.0	H	5.0	93.99	/	/
2483.5	44.66	PK	235.0	200.0	H	5.0	49.66	74	24.34
2483.5	30.55	Ave	235.0	200.0	H	5.0	35.55	54	18.45
2490	33.48	Ave	310.0	150.0	H	5.0	38.48	54	15.52
2490	46.62	PK	310.0	150.0	H	5.0	51.62	74	22.38
4109	21.63	Ave	15.0	200.0	H	10.5	32.13	54	21.87
4109	35.66	PK	15.0	200.0	H	10.5	46.16	74	27.84
4924	20.4	Ave	0.0	200.0	V	13.8	34.20	54	19.80
4924	34.49	PK	0.0	200.0	V	13.8	48.29	74	25.71
7386	16.71	Ave	310.0	200.0	V	20.2	36.91	54	17.09
7386	30.83	PK	310.0	200.0	V	20.2	51.03	74	22.97

802.11g Mode

Frequency (MHz)	Receiver		Turntable Degree	Rx Antenna		Corrected Factor (dB)	Corrected Amplitude (dBµV/m)	FCC Part 15.247/205/209	
	Reading (dBµV)	Detector (PK/QP/Ave.)		Height (cm)	Polar (H/V)			Limit (dBµV/m)	Margin (dB)
Low Channel (2412 MHz)									
2412	89.55	PK	30.0	100.0	V	4.9	94.45	/	/
2412	84.32	Ave	30.0	100.0	V	4.9	89.22	/	/
2412	88.24	PK	134.0	150.0	H	4.9	93.14	/	/
2412	82.67	Ave	134.0	150.0	H	4.9	87.57	/	/
2390	26.01	Ave	243.0	150.0	H	4.9	30.91	54	23.09
2390	54.6	PK	243.0	150.0	H	4.9	59.50	74	14.50
2400	38.75	PK	241.0	150.0	H	4.9	43.65	74	30.35
2400	21.62	Ave	241.0	150.0	H	4.9	26.52	54	27.48
3216	32.40	Ave	0.0	150.0	H	7.4	39.80	54	14.20
3216	47.61	PK	0.0	150.0	H	7.4	55.01	74	18.99
4824	32.21	PK	4.0	200.0	V	13.4	45.61	74	28.39
4824	18.52	Ave	4.0	200.0	V	13.4	31.92	54	22.08
7236	30.44	PK	174.0	200.0	H	19.8	50.24	74	23.76
7236	16.66	Ave	174.0	200.0	H	19.8	36.46	54	17.54

Frequency (MHz)	Receiver		Turntable Degree	Rx Antenna		Corrected Factor (dB)	Corrected Amplitude (dBµV/m)	FCC Part 15.247/205/209	
	Reading (dBµV)	Detector (PK/QP/Ave.)		Height (cm)	Polar (H/V)			Limit (dBµV/m)	Margin (dB)
Middle Channel (2437 MHz)									
2437	91.57	PK	99.0	150.0	V	4.9	96.47	/	/
2437	85.64	Ave	99.0	150.0	V	4.9	90.54	/	/
2437	90.72	PK	301.0	150.0	H	4.9	95.62	/	/
2437	84.81	Ave	301.0	150.0	H	4.9	89.71	/	/
3072	40.37	PK	27.0	150.0	V	7.0	47.37	74	26.63
3072	34.81	Ave	27.0	150.0	V	7.0	41.81	54	12.19
3249	30.28	Ave	164.0	150.0	H	7.5	37.78	54	16.22
3249	45.41	PK	164.0	150.0	H	7.5	52.91	74	21.09
4874	17.89	Ave	105.0	150.0	V	13.6	31.49	54	22.51
4874	32.51	PK	105.0	150.0	V	13.6	46.11	74	27.89
6680	21.28	Ave	331.0	150.0	H	17.9	39.18	54	14.82
6680	35.22	PK	331.0	150.0	H	17.9	53.12	74	20.88
7311	30.60	PK	79.0	200.0	V	20.0	50.60	74	23.40
7311	16.70	Ave	79.0	200.0	V	20.0	36.70	54	17.30
High Channel (2462 MHz)									
2462	92.35	PK	134.0	200.0	V	5.0	97.35	/	/
2462	86.87	Ave	134.0	200.0	V	5.0	91.87	/	/
2462	91.21	PK	244.0	150.0	H	5.0	96.21	/	/
2462	85.81	Ave	244.0	150.0	H	5.0	90.81	/	/
2483.5	26.89	Ave	293.0	150.0	H	5.0	31.89	54	22.11
2483.5	54.16	PK	293.0	150.0	H	5.0	59.16	74	14.84
2490	24.72	Ave	302.0	150.0	H	5.0	29.72	54	24.28
2490	43.43	PK	302.0	150.0	H	5.0	48.43	74	25.57
3072	33.26	Ave	26.0	150.0	V	7.0	40.26	54	13.74
3072	39.78	PK	26.0	150.0	V	7.0	46.78	74	27.22
4924	36.94	PK	279.0	150.0	H	13.8	50.74	74	23.26
4924	19.49	Ave	279.0	150.0	H	13.8	33.29	54	20.71
7386	31.11	PK	5.0	200.0	V	20.2	51.31	74	22.69
7386	16.73	Ave	5.0	200.0	V	20.2	36.93	54	17.07

802.11n-HT20 Mode

Frequency (MHz)	Receiver		Turntable Degree	Rx Antenna		Corrected Factor (dB)	Corrected Amplitude (dBµV/m)	FCC Part 15.247/205/209	
	Reading (dBµV)	Detector (PK/QP/Ave.)		Height (cm)	Polar (H/V)			Limit (dBµV/m)	Margin (dB)
Low Channel (2412 MHz)									
2412	93.89	PK	248.0	200.0	V	4.9	98.79	/	/
2412	89.00	Ave	248.0	200.0	V	4.9	93.90	/	/
2412	92.94	PK	22.0	200.0	H	4.9	97.84	/	/
2412	77.46	Ave	22.0	200.0	H	4.9	82.36	/	/
2390	39.09	PK	146.0	150.0	H	4.9	43.99	74	30.01
2390	21.24	Ave	146.0	150.0	H	4.9	26.14	54	27.86
2400	52.69	PK	40.0	150.0	H	4.9	57.59	74	16.41
2400	23.95	Ave	40.0	150.0	H	4.9	28.85	54	25.15
3215	46.37	PK	221.0	150.0	H	7.4	53.77	74	20.23
3215	29.41	Ave	221.0	150.0	H	7.4	36.81	54	17.19
4824	32.7	PK	184.0	200.0	V	13.4	46.10	74	27.90
4824	18.53	Ave	184.0	200.0	V	13.4	31.93	54	22.07
7236	16.68	Ave	95.0	200.0	H	19.8	36.48	54	17.52
7236	30.48	PK	95.0	200.0	H	19.8	50.28	74	23.72
Middle Channel (2437 MHz)									
2437	92.87	PK	47.0	200.0	V	4.9	97.77	/	/
2437	87.72	Ave	47.0	200.0	V	4.9	92.62	/	/
2437	91.67	PK	210.0	200.0	H	4.9	96.57	/	/
2437	86.59	Ave	210.0	200.0	H	4.9	91.49	/	/
3062	19.22	Ave	31.0	150.0	H	7.0	26.22	54	27.78
3062	35.85	PK	31.0	150.0	H	7.0	42.85	74	31.15
3248	26.48	Ave	126.0	150.0	H	7.5	33.98	54	20.02
3248	42.51	PK	126.0	150.0	H	7.5	50.01	74	23.99
4874	32.09	PK	359.0	150.0	H	13.6	45.69	74	28.31
4874	18.48	Ave	359.0	150.0	H	13.6	32.08	54	21.92
6669	35.84	PK	226.0	200.0	H	17.9	53.74	74	20.26
6669	21.62	Ave	226.0	200.0	H	17.9	39.52	54	14.48
7311	16.71	Ave	154.0	150.0	V	20.0	36.71	54	17.29
7311	30.94	PK	154.0	150.0	V	20.0	50.94	74	23.06

Frequency (MHz)	Receiver		Turntable Degree	Rx Antenna		Corrected Factor (dB)	Corrected Amplitude (dBµV/m)	FCC Part 15.247/205/209	
	Reading (dBµV)	Detector (PK/QP/Ave.)		Height (cm)	Polar (H/V)			Limit (dBµV/m)	Margin (dB)
High Channel (2462 MHz)									
2462	92.39	PK	237.0	150.0	V	5.0	97.39	/	/
2462	87.56	Ave	237.0	150.0	V	5.0	92.56	/	/
2462	93.40	PK	55.0	150.0	H	5.0	98.40	/	/
2462	87.78	Ave	55.0	150.0	H	5.0	92.78	/	/
2483.5	25.79	Ave	227.0	150.0	H	5.0	30.79	54	23.21
2483.5	51.99	PK	227.0	150.0	H	5.0	56.99	74	17.01
2490	40.59	PK	223.0	150.0	H	5.0	45.59	74	28.41
2490	22.08	Ave	223.0	150.0	H	5.0	27.08	54	26.92
3276	20.43	Ave	338.0	150.0	H	7.6	28.03	54	25.97
3276	34.71	PK	338.0	150.0	H	7.6	42.31	74	31.69
4924	32.23	PK	234.0	150.0	V	13.8	46.03	74	27.97
4924	17.92	Ave	234.0	150.0	V	13.8	31.72	54	22.28
7386	31.00	PK	132.0	200.0	V	20.2	51.20	74	22.80
7386	16.71	Ave	132.0	200.0	V	20.2	36.91	54	17.09

Spurious Emissions at Antenna Port

802.11b Low Channel

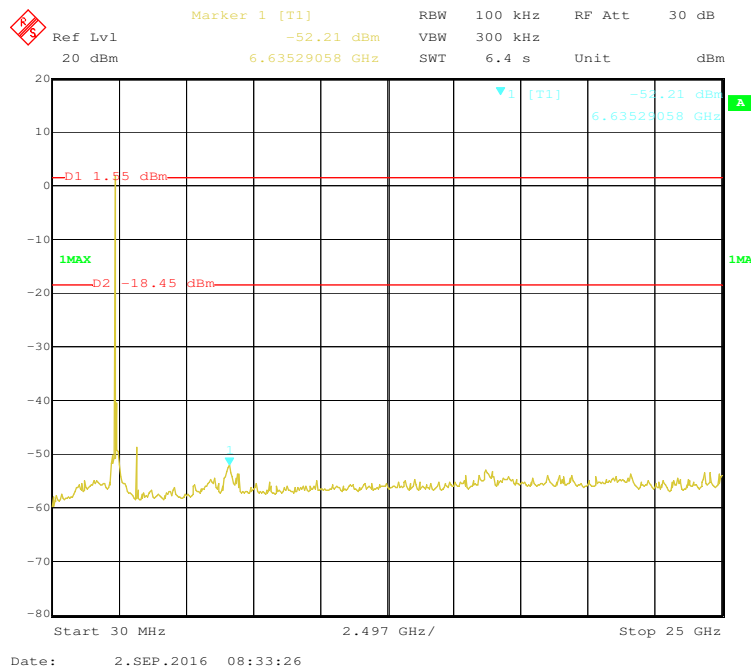

802.11b Middle Channel

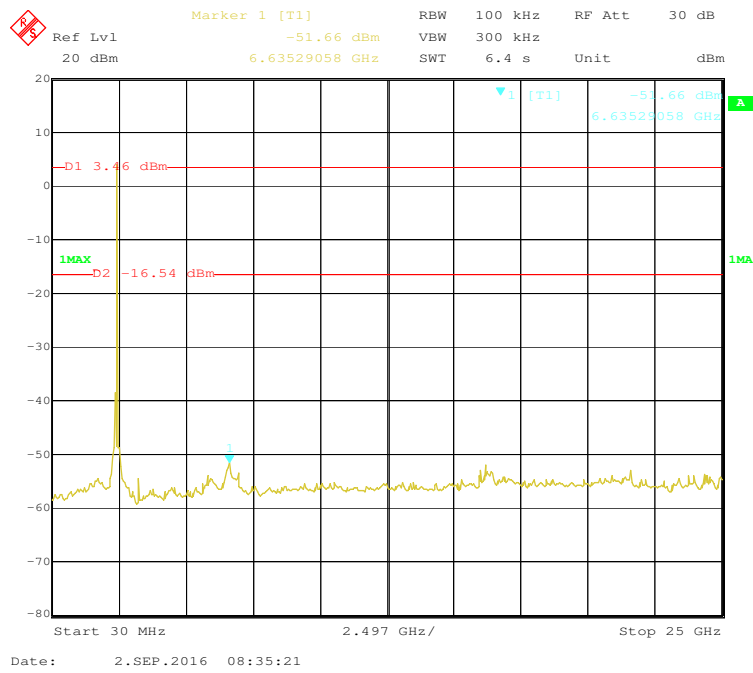

802.11b High Channel

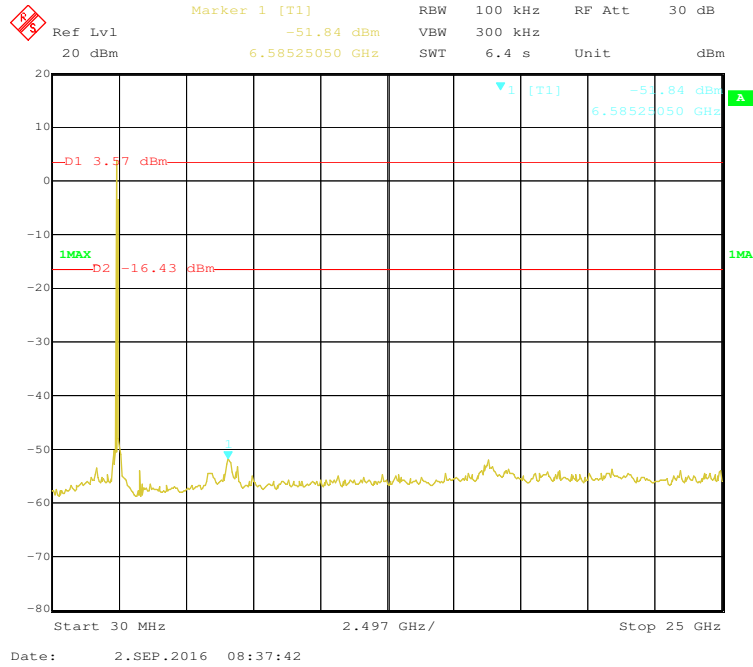

802.11n-HT20 Middle Channel

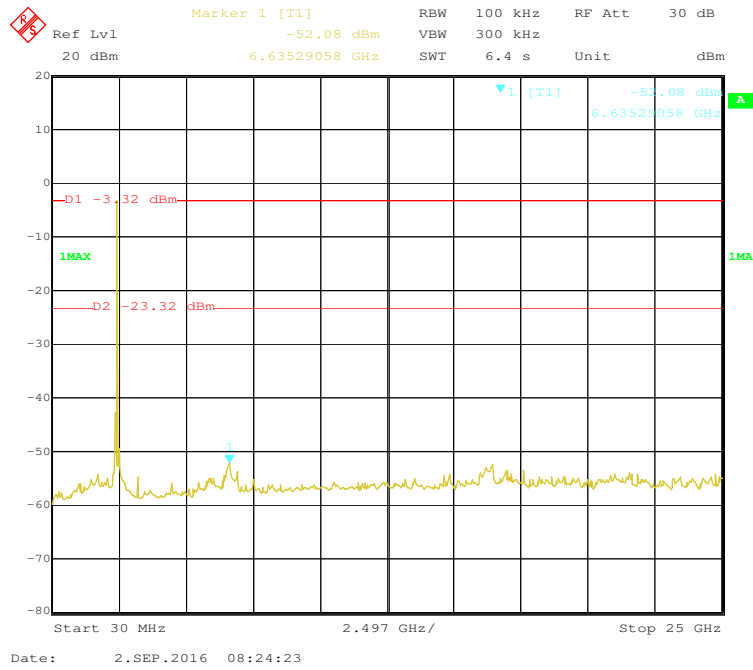

802.11n-HT20 High Channel

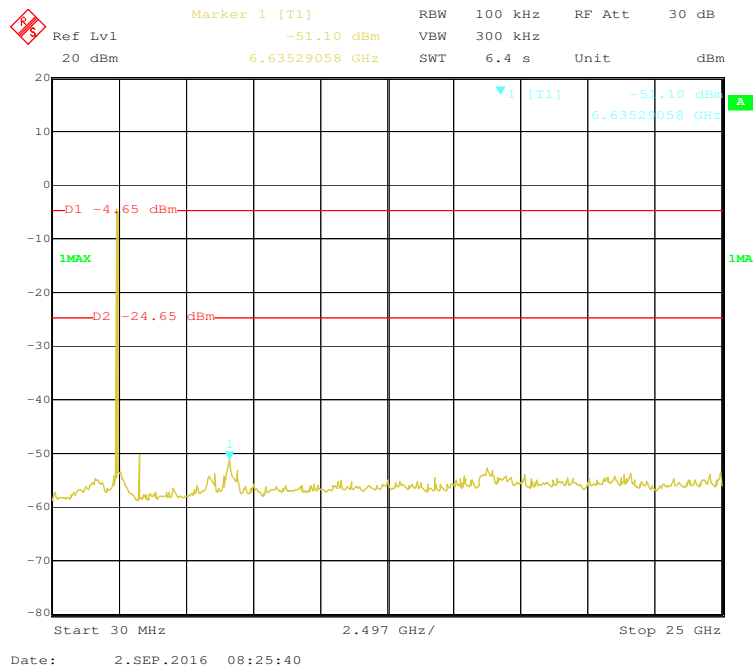

FCC §15.247(a) (2) – 6 dB EMISSION BANDWIDTH

Applicable Standard

Systems using digital modulation techniques may operate in the 902–928 MHz, 2400–2483.5 MHz, and 5725–5850 MHz bands. The minimum 6 dB bandwidth shall be at least 500 kHz.

Test Procedure

1. Check the calibration of the measuring instrument using either an internal calibrator or a known signal from an external generator.
2. Position the EUT without connection to measurement instrument. Turn on the EUT and connect it to measurement instrument. Then set it to any one convenient frequency within its operating range. Set a reference level on the measuring instrument equal to the highest peak value.
3. Measure the frequency difference of two frequencies that were attenuated 6 dB from the reference level. Record the frequency difference as the emission bandwidth.
4. Repeat above procedures until all frequencies measured were complete.

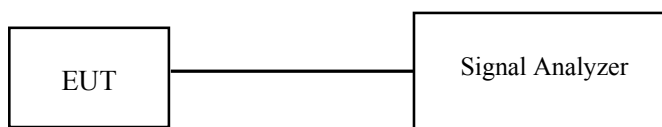

Test Equipment List and Details

Manufacturer	Description	Model	Serial Number	Calibration Date	Calibration Due Date
Rohde & Schwarz	SIGNAL ANALYZER	FSV40	101116	2016-07-04	2017-07-03
BACL	RF cable	KS-LAB-012	KS-LAB-012	2015-12-16	2016-12-15

* **Statement of Traceability:** Bay Area Compliance Laboratories Corp. (Kunshan) attests that all calibrations have been performed in accordance to requirements that traceable to National Primary Standards and International System of Units (SI).

Test Data

Environmental Conditions

Temperature:	24 °C
Relative Humidity:	55 %
ATM Pressure:	101.0 kPa

The testing was performed by Chris Wang on 2016-08-24.

Test Result: Pass.

Please refer to the following tables and plots.

EUT operation mode: Transmitting

Channel	Frequency (MHz)	6 dB Emission Bandwidth (MHz)	Limit (kHz)
802.11b mode			
Low	2412	8.86	≥ 500
Middle	2437	8.86	≥ 500
High	2462	8.86	≥ 500
802.11g mode			
Low	2412	16.50	≥ 500
Middle	2437	16.47	≥ 500
High	2462	16.53	≥ 500
802.11n-HT20 mode			
Low	2412	17.76	≥ 500
Middle	2437	17.71	≥ 500
High	2462	17.71	≥ 500

802.11b Low Channel

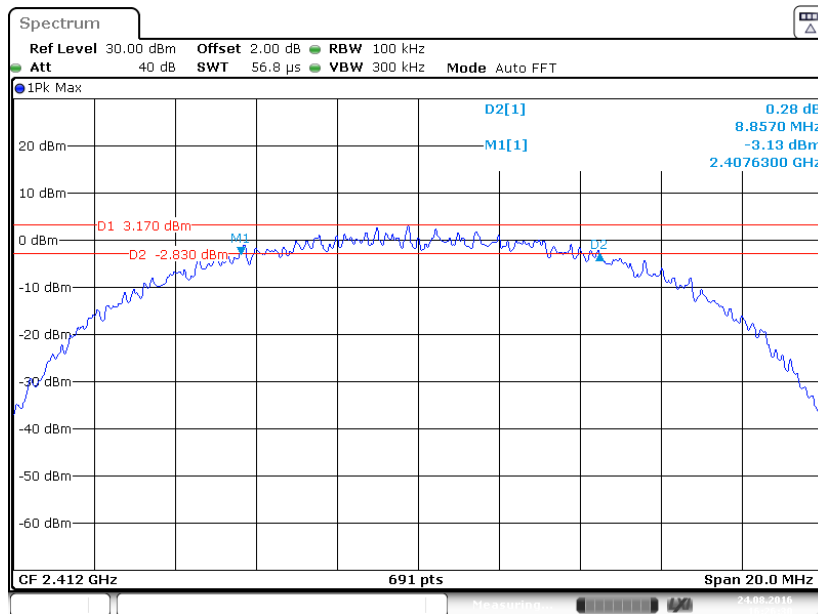

Date: 24 AUG 2016 16:26:31

802.11b Middle Channel

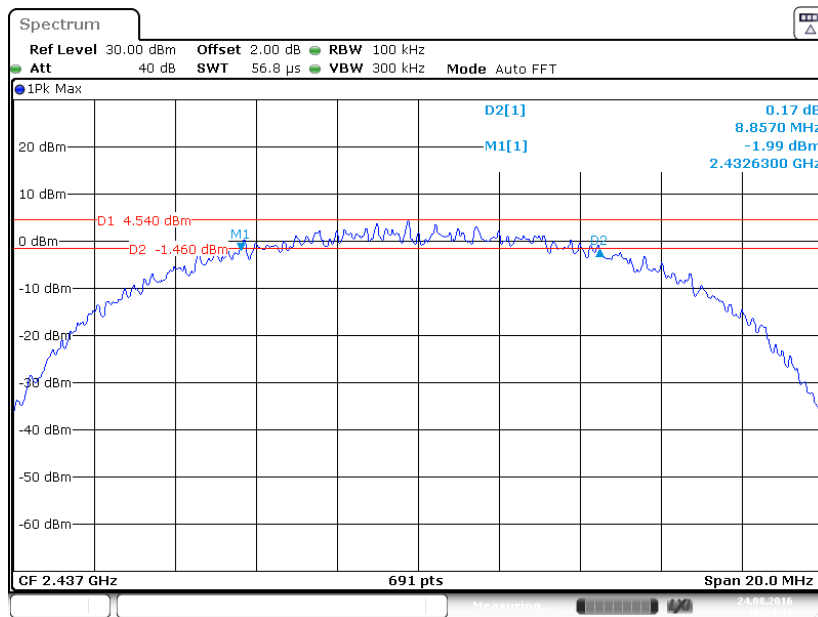

Date: 24.AUG.2016 16:34:31

802.11b High Channel

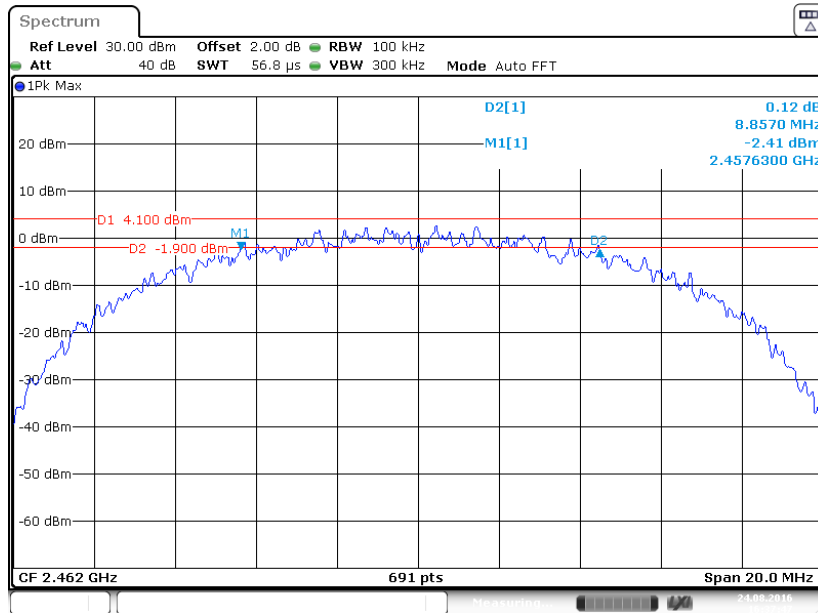

Date: 24.AUG.2016 16:37:47

802.11g Low Channel

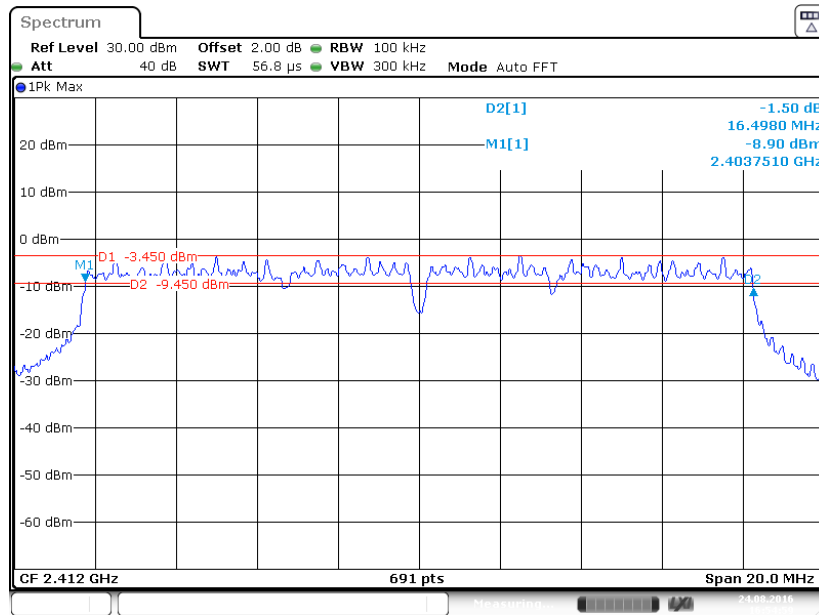

Date:24.AUG.2016 16:55:00

802.11g Middle Channel

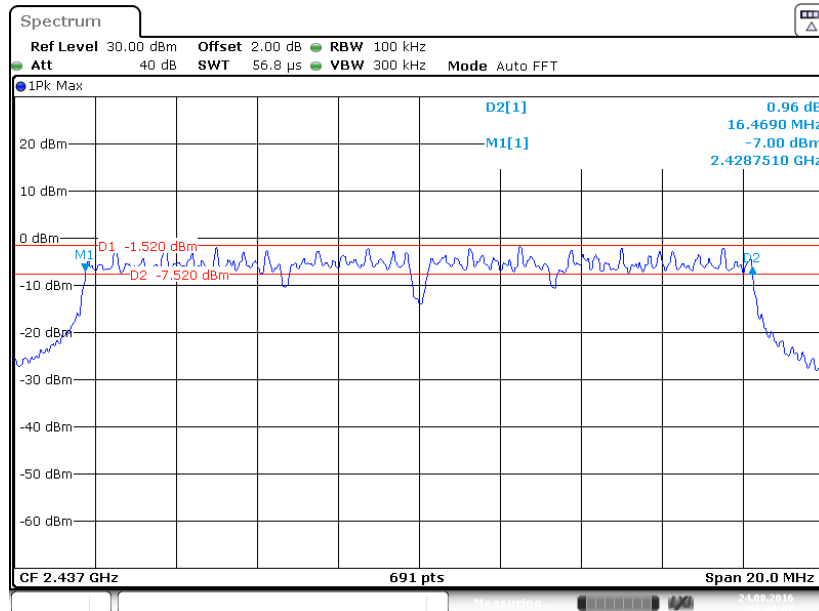

Date:24.AUG.2016 16:48:08

802.11g High Channel

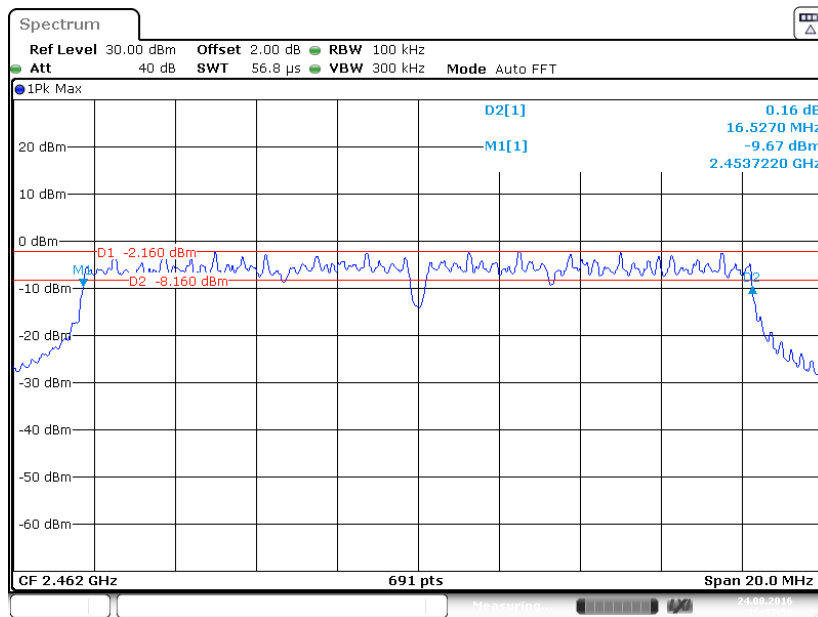

Date:24.AUG.2016 16:43:58

802.11n-HT20 Low Channel

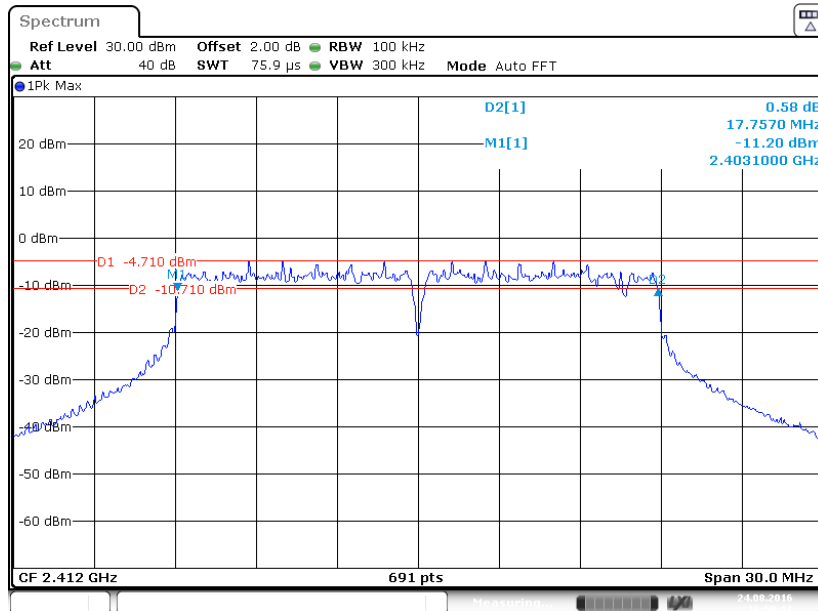

Date:24.AUG.2016 16:59:12

802.11n-HT20 Middle Channel

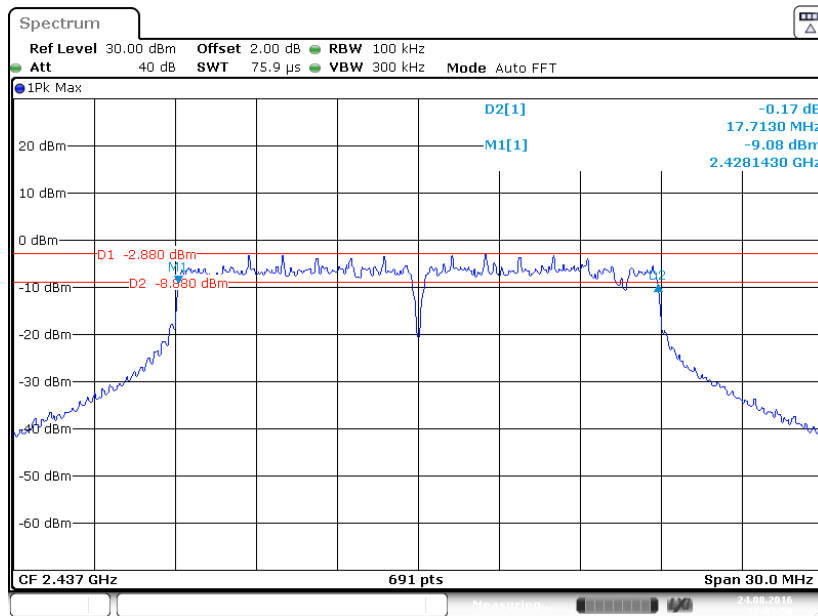

Date: 24.AUG.2016 17:03:51

802.11n-HT20 High Channel

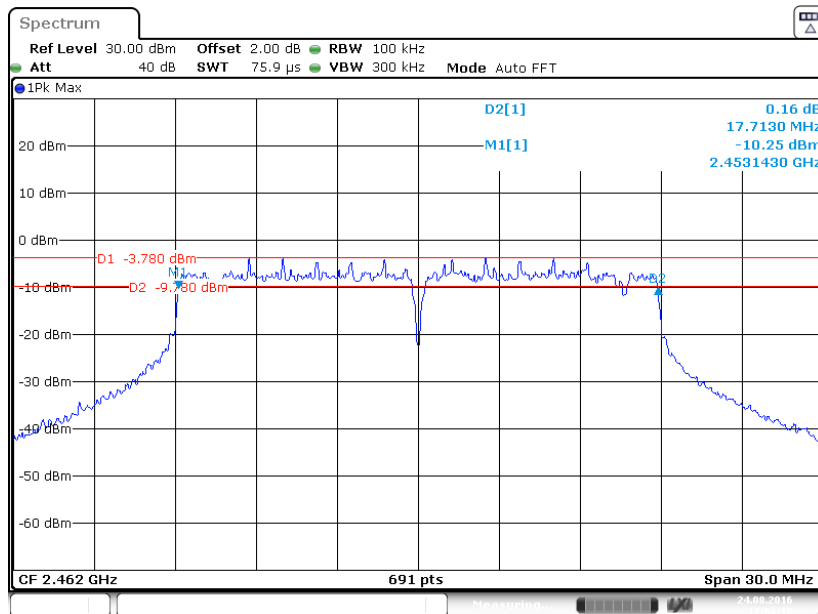

Date: 24.AUG.2016 17:06:18

FCC §15.247(b) (3) - MAXIMUM CONDUCTED OUTPUT POWER

Applicable Standard

According to FCC §15.247(b) (3), for systems using digital modulation in the 902-928 MHz, 2400-2483.5 MHz, and 5725-5850 MHz bands: 1 Watt. As an alternative to a peak power measurement, compliance with the one Watt limit can be based on a measurement of the maximum conducted output power. Maximum Conducted Output Power is defined as the total transmit power delivered to all antennas and antenna elements averaged across all symbols in the signaling alphabet when the transmitter is operating at its maximum power control level. Power must be summed across all antennas and antenna elements. The average must not include any time intervals during which the transmitter is off or is transmitting at a reduced power level. If multiple modes of operation are possible (e.g., alternative modulation methods), the maximum conducted output power is the highest total transmit power occurring in any mode.

Test Procedure

1. Place the EUT on a bench and set it in transmitting mode.
2. Remove the antenna from the EUT and then connect a low loss RF cable from the antenna port to one test equipment.
3. Add a correction factor to the display.

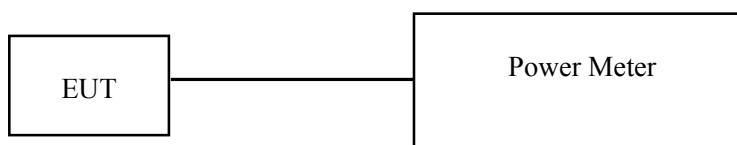

Test Equipment List and Details

Manufacturer	Description	Model	Serial Number	Calibration Date	Calibration Due Date
Rohde & Schwarz	OSP120 BASE UNIT	OSP120	101247	2016-07-04	2017-07-03
Rohde & Schwarz	Power Sensor	NRP-Z91	200014	2015-08-01	2017-07-31
BACL	RF cable	KS-LAB-012	KS-LAB-012	2015-12-16	2016-12-15

* **Statement of Traceability:** Bay Area Compliance Laboratories Corp. (Kunshan) attests that all calibrations have been performed in accordance to requirements that traceable to National Primary Standards and International System of Units (SI).

Test Data

Environmental Conditions

Temperature:	24 °C
Relative Humidity:	55 %
ATM Pressure:	101.0 kPa

The testing was performed by Chris Wang on 2016-09-26.

EUT operation mode: Transmitting

Channel	Frequency (MHz)	Max Conducted Peak Output Power (dBm)	Reading (dBm)	Corrected Factor 10log(1/x) (dB)	Conducted Average Output Power	Limit (dBm)	Result
802.11b							
Low	2412	13.93	9.43	0.23	9.66	30	Pass
Middle	2437	15.47	11.40	0.23	11.63	30	Pass
High	2462	15.21	11.21	0.23	11.44	30	Pass
802.11g							
Low	2412	10.55	6.03	0.47	6.50	30	Pass
Middle	2437	12.39	7.77	0.47	8.24	30	Pass
High	2462	11.17	6.65	0.47	7.12	30	Pass
802.11n-HT20							
Low	2412	9.06	4.04	0.51	4.55	30	Pass
Middle	2437	10.80	5.70	0.51	6.21	30	Pass
High	2462	10.12	5.11	0.51	5.62	30	Pass

Note: x is the duty cycle. For 802.11b: x=0.948 802.11g: x=0.897 802.11n20: x0.889
 Conducted Average Output Power= Reading+ Corrected Factor
 The reading value is reading from the test software.

802.11b Mode Middle Channel

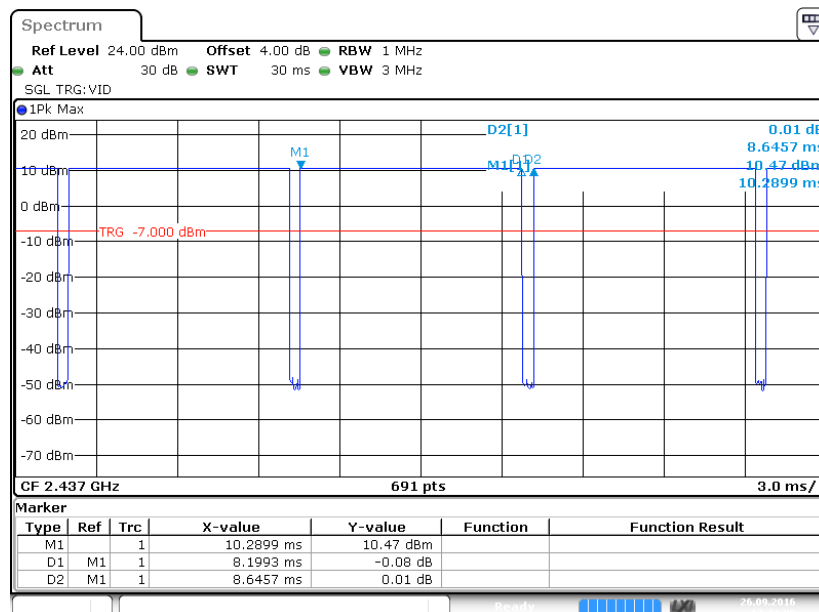

Date: 26_SEP_2016 17:44:05

802.11g Mode Middle Channel

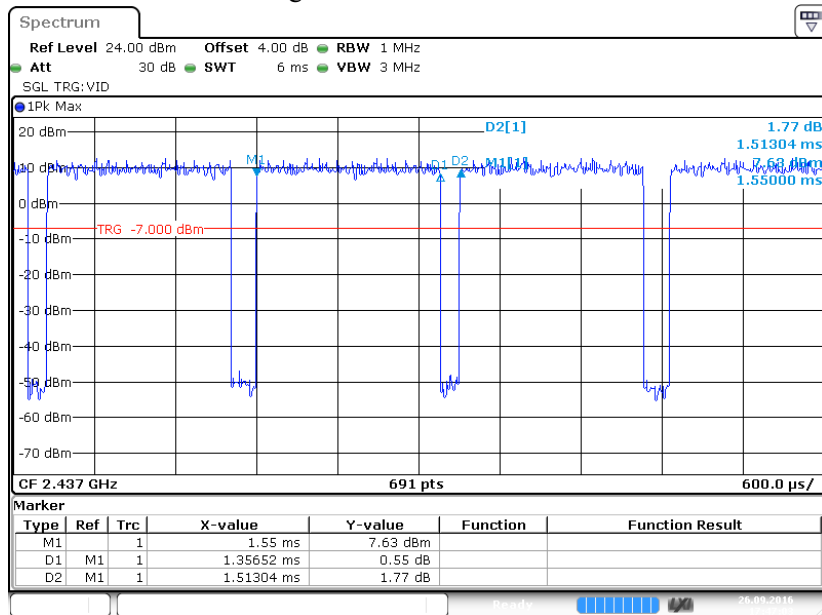

802.11n20 Mode Middle Channel

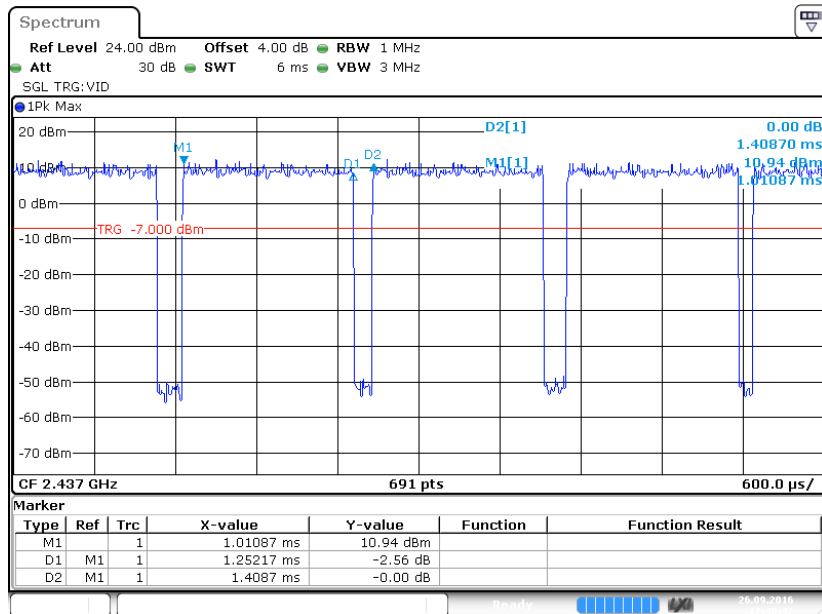

FCC §15.247(d) – 100 kHz BANDWIDTH OF FREQUENCY BAND EDGE

Applicable Standard

In any 100 kHz bandwidth outside the frequency band in which the spread spectrum or digitally modulated intentional radiator is operating, the radio frequency power that is produced by the intentional radiator shall be at least 20 dB below that in the 100 kHz bandwidth within the band that contains the highest level of the desired power, based on either an RF conducted or a radiated measurement, provided the transmitter demonstrates compliance with the peak conducted power limits. If the transmitter complies with the conducted power limits based on the use of RMS averaging over a time interval, as permitted under paragraph (b)(3) of this section, the attenuation required under this paragraph shall be 30 dB instead of 20 dB. Attenuation below the general limits specified in §15.209(a) is not required. In addition, radiated emissions which fall in the restricted bands, as defined in §15.205(a), must also comply with the radiated emission limits specified in §15.209(a) (see §15.205(c)).

Test Procedure

1. Check the calibration of the measuring instrument using either an internal calibrator or a known signal from an external generator.
2. Position the EUT without connection to measurement instrument. Turn on the EUT and connect its antenna terminal to measurement instrument via a low loss cable. Then set it to any one measured frequency within its operating range, and make sure the instrument is operated in its linear range.
3. Set RBW to 100 kHz and VBW of spectrum analyzer to 300 kHz with a convenient frequency span including 100 kHz bandwidth from band edge.
4. Measure the highest amplitude appearing on spectral display and set it as a reference level. Plot the graph with marking the highest point and edge frequency.
5. Repeat above procedures until all measured frequencies were complete.

Test Equipment List and Details

Manufacturer	Description	Model	Serial Number	Calibration Date	Calibration Due Date
Rohde & Schwarz	FSV40 Signal Analyzer	FSV40	101116	2016-07-04	2017-07-03
BACL	TS 8997 Cable-01	T-KS-EMC086	T-KS-EMC086	2015-12-10	2016-12-09

* **Statement of Traceability:** Bay Area Compliance Laboratories Corp. (Kunshan) attests that all calibrations have been performed in accordance to requirements that traceable to National Primary Standards and International System of Units (SI).

Test Data

Environmental Conditions

Temperature:	24 °C
Relative Humidity:	55 %
ATM Pressure:	101.0 kPa

The testing was performed by Chris Wang on 2016-08-24.

EUT operation mode: Transmitting

Please refer to the following table and plots.

802.11b: Band Edge, Left Side

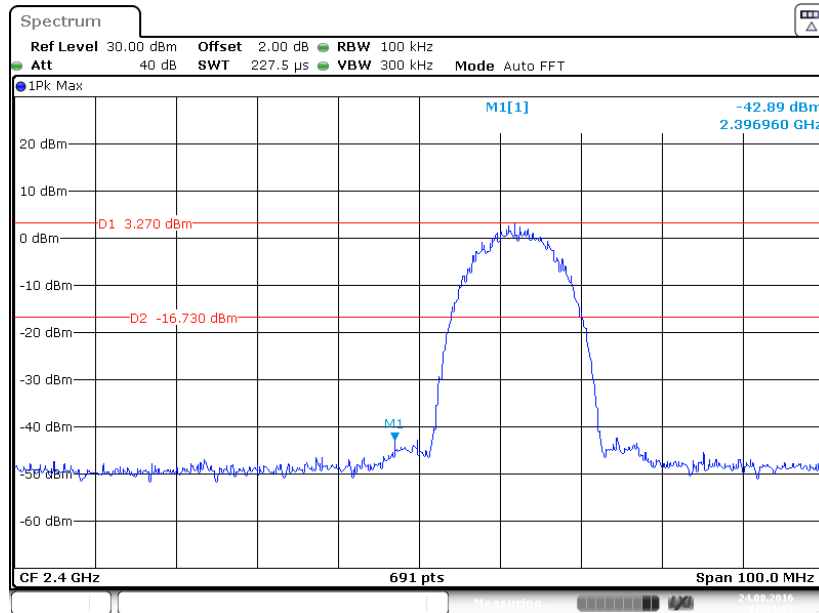

802.11b: Band Edge, Right Side

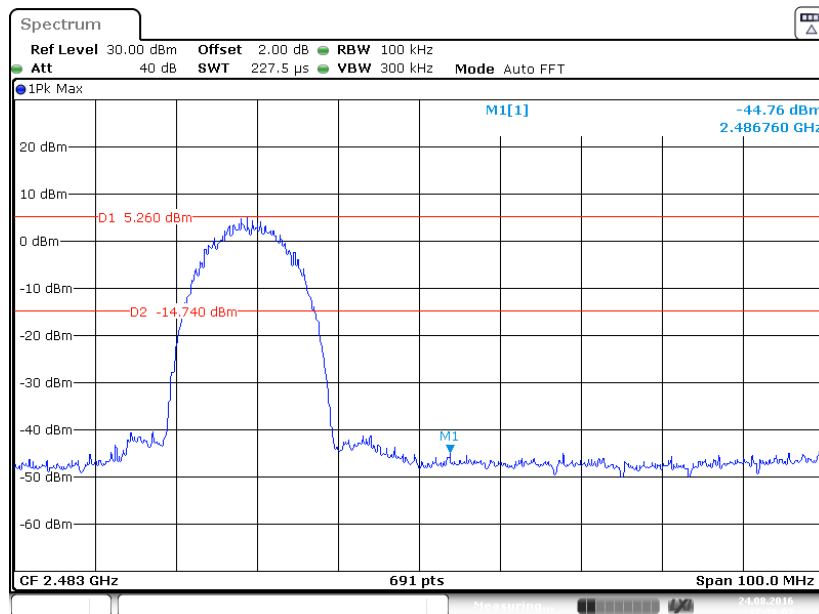

802.11g: Band Edge, Left Side

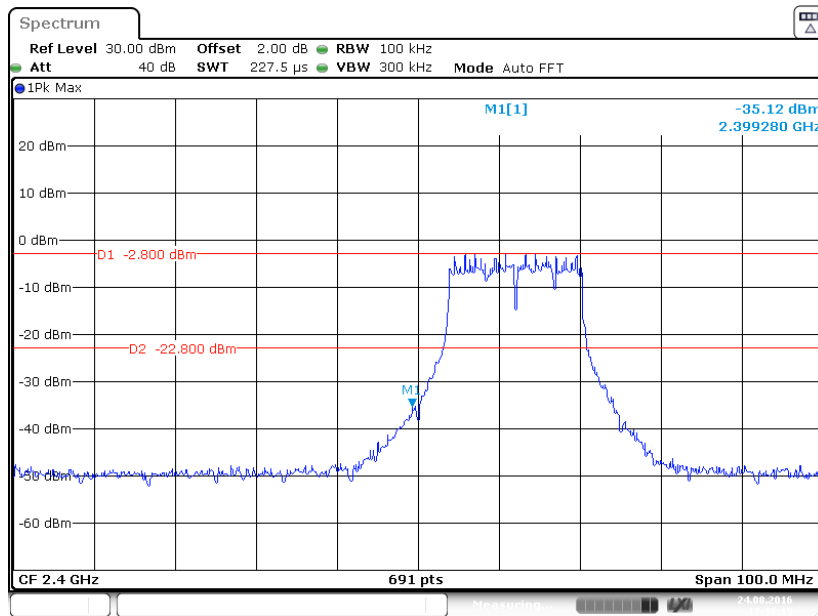

802.11g: Band Edge, Right Side

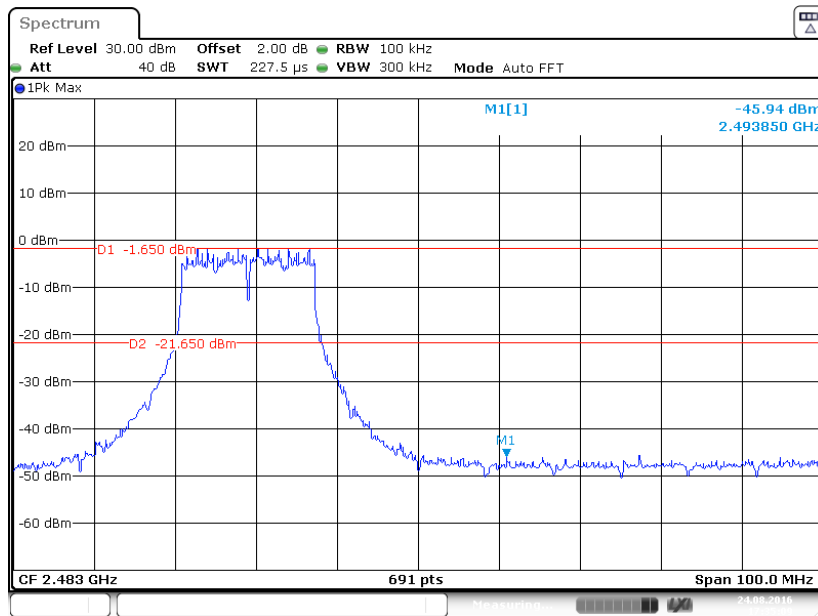

802.11n-HT20: Band Edge, Left Side

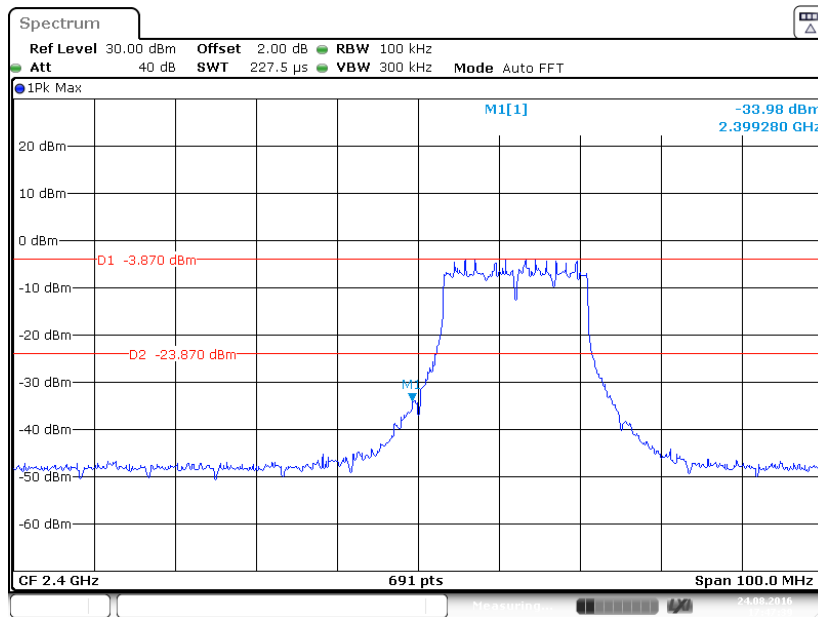

Date: 24.AUG.2016 17:47:39

802.11n-HT20: Band Edge, Right Side

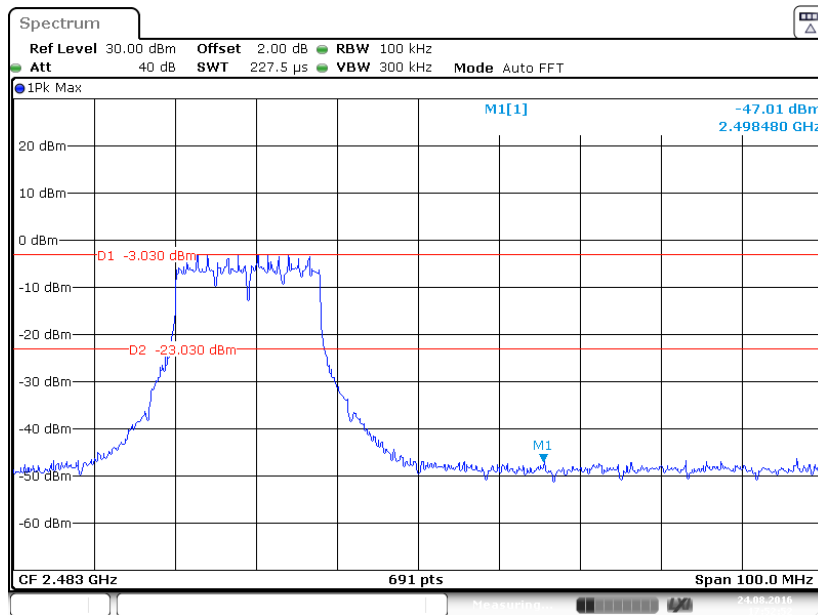

Date: 24.AUG.2016 17:52:52

FCC §15.247(e) - POWER SPECTRAL DENSITY

Applicable Standard

For digitally modulated systems, the power spectral density conducted from the intentional radiator to the antenna shall not be greater than 8 dBm in any 3 kHz band during any time interval of continuous transmission. This power spectral density shall be determined in accordance with the provisions of paragraph (b) of this section. The same method of determining the conducted output power shall be used to determine the power spectral density.

Test Procedure

According to KDB558074 D01 DTS Meas Guidance v03r05.

1. Use this procedure when the maximum peak conducted output power in the fundamental emission is used to demonstrate compliance.
2. Set the RBW to: $3\text{kHz} \leq \text{RBW} \leq 100\text{ kHz}$.
3. Set the VBW $\geq 3 \times \text{RBW}$.
4. Set the span to 1.5 times the DTS bandwidth.
5. Detector = peak.
6. Sweep time = auto couple.
7. Trace mode = max hold.
8. Allow trace to fully stabilize.
9. Use the peak marker function to determine the maximum amplitude level within the RBW.
10. If measured value exceeds limit, reduce RBW (no less than 3 kHz) and repeat.

Test Equipment List and Details

Manufacturer	Description	Model	Serial Number	Calibration Date	Calibration Due Date
Rohde & Schwarz	SIGNAL ANALYZER	FSV40	101116	2016-07-04	2017-07-03
BACL	RF cable	KS-LAB-012	KS-LAB-012	2015-12-16	2016-12-15

* **Statement of Traceability:** Bay Area Compliance Laboratories Corp. (Kunshan) attests that all calibrations have been performed in accordance to requirements that traceable to National Primary Standards and International System of Units (SI).

Test Data

Environmental Conditions

Temperature:	24 °C
Relative Humidity:	55 %
ATM Pressure:	101.0 kPa

The testing was performed by Chris Wang on 2016-08-25.

EUT operation mode: Transmitting

Test Result: Pass

Channel	Frequency (MHz)	PSD (dBm/3kHz)	Limit (dBm/3kHz)
802.11b mode			
Low	2412	-8.64	≤8
Middle	2437	-7.67	≤8
High	2462	-7.70	≤8
802.11g mode			
Low	2412	-16.73	≤8
Middle	2437	-15.16	≤8
High	2462	-15.82	≤8
802.11n-HT20 mode			
Low	2412	-19.10	≤8
Middle	2437	-17.60	≤8
High	2462	-17.67	≤8

Power Spectral Density, 802.11b Low Channel

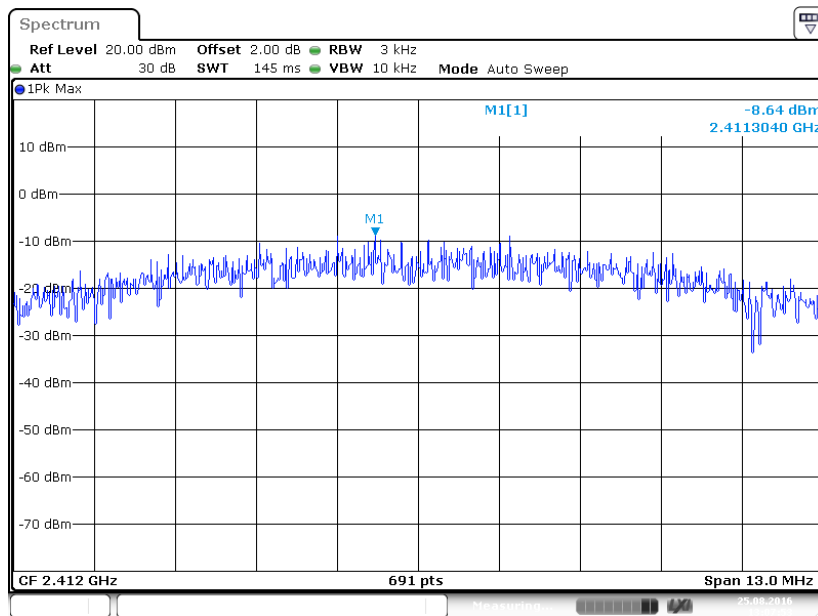

Power Spectral Density, 802.11b Middle Channel

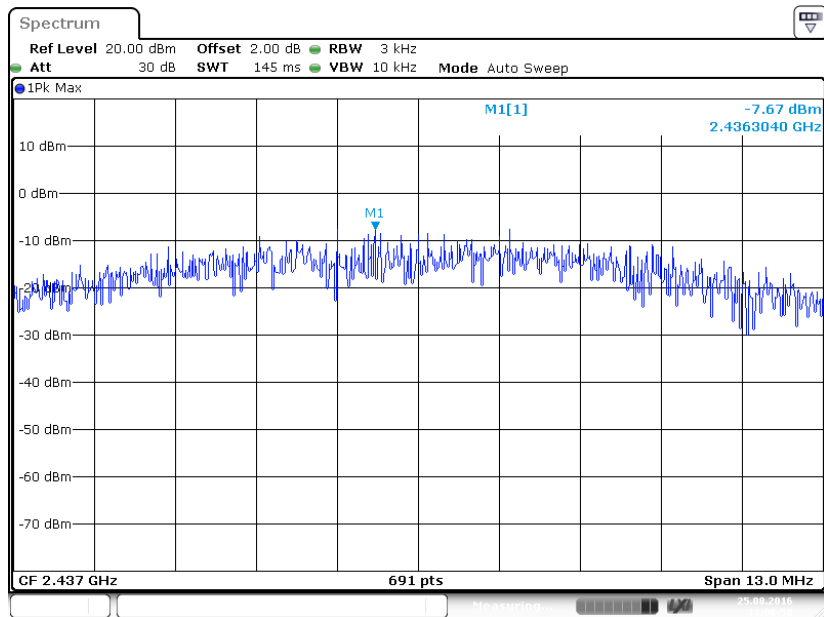

Date: 25 AUG 2016 13:06:50

Power Spectral Density, 802.11b High Channel

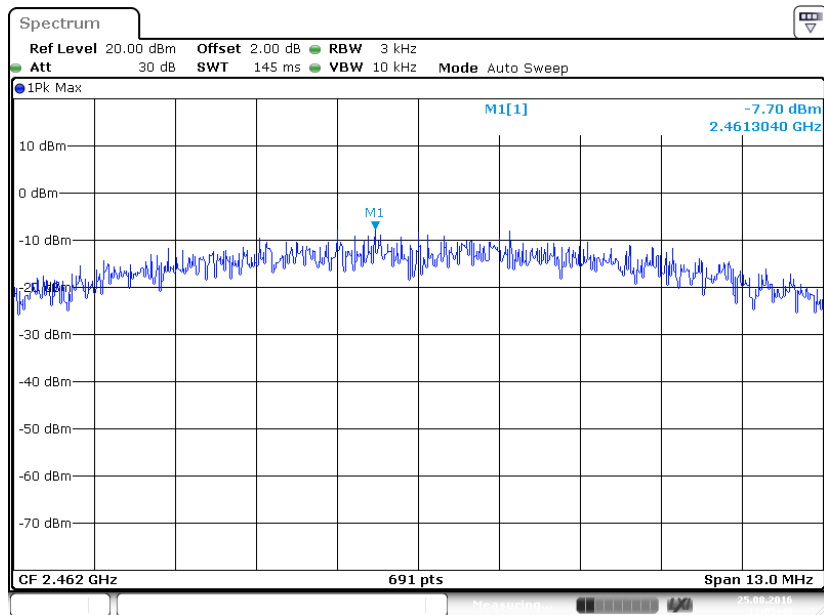

Date: 25 AUG 2016 13:05:50

Power Spectral Density, 802.11g Low Channel

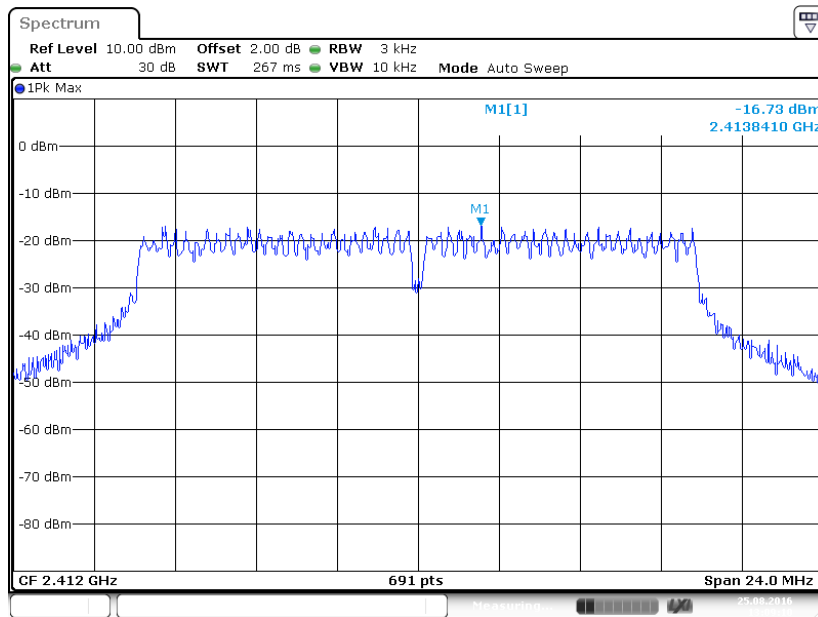

Date: 25.AUG.2016 13:09:10

Power Spectral Density, 802.11g Middle Channel

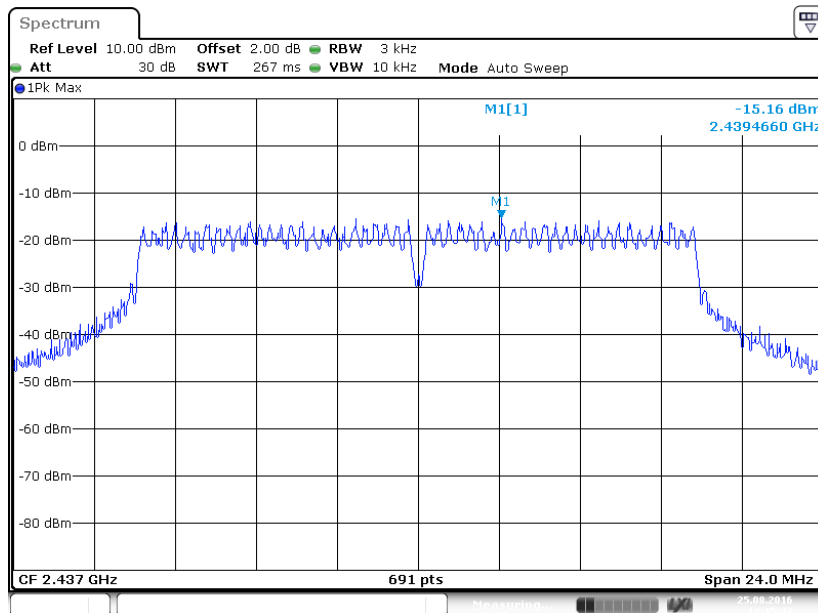

Date: 25.AUG.2016 13:15:42

Power Spectral Density, 802.11g High Channel

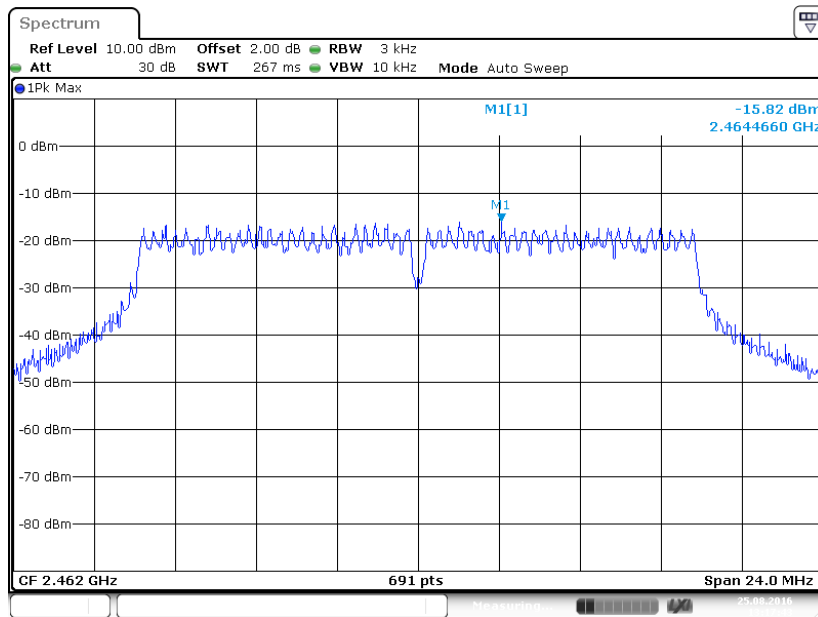

Date: 25 AUG 2016 13:17:44

Power Spectral Density, 802.11n-HT20 Low Channel

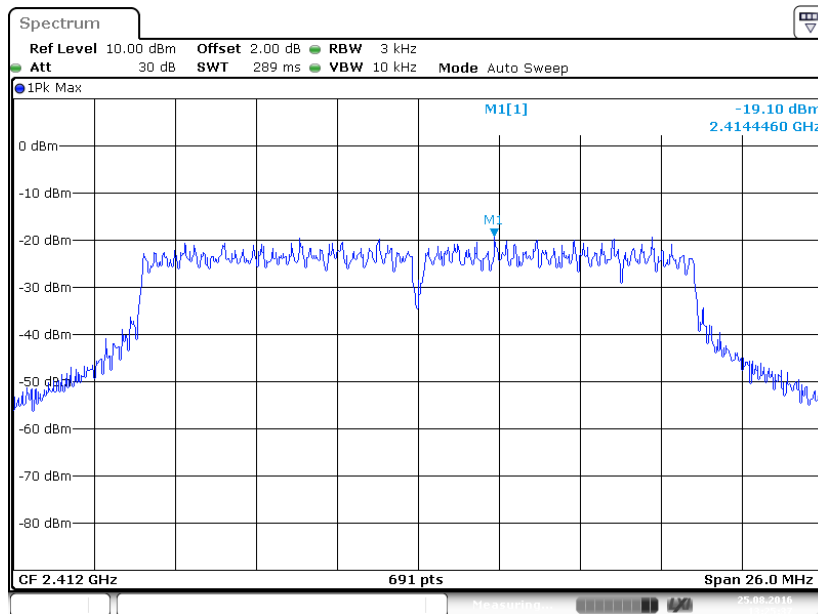

Date: 25 AUG 2016 13:25:37

Power Spectral Density, 802.11n-HT20 Middle Channel

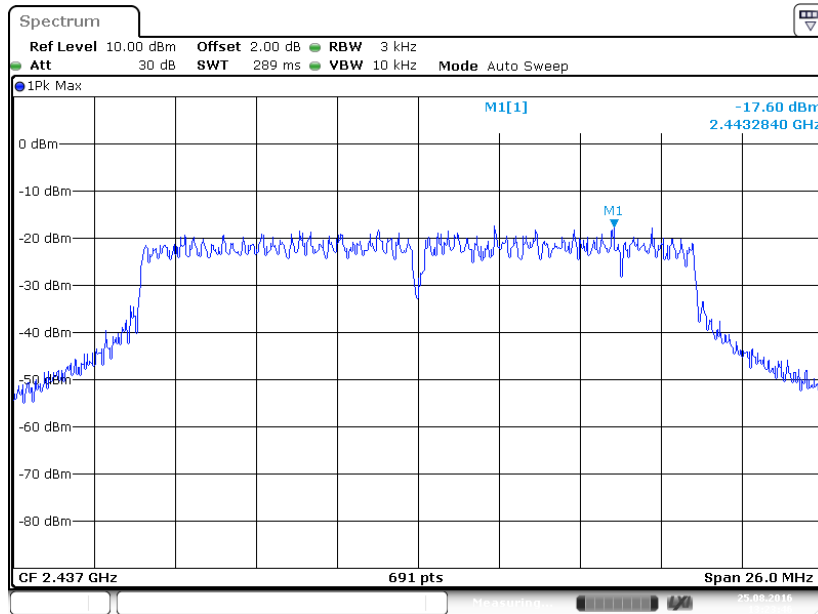

Date: 25 AUG 2016 13:23:47

Power Spectral Density, 802.11n-HT20 High Channel

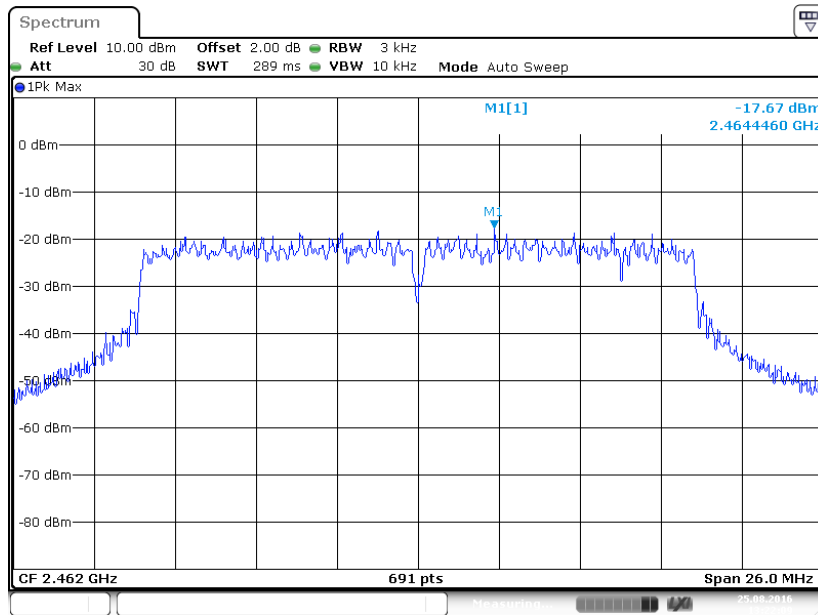

Date: 25 AUG 2016 13:22:09

***** END OF REPORT *****