



FCC RADIO TEST REPORT

FCC ID : N89-NM3531
Equipment : 802.11a/b/g/n/ac BT5.0 combo NGFF M.2 2230 card
Brand Name : CyberTAN
Model Name : NM353-1
Applicant : CyberTAN Technology Inc.
No. 99, Park Avenue III Science-based Industrial
Park Hsinchu Taiwan 308
Manufacturer : CyberTAN Technology Inc.
No. 99, Park Avenue III Science-based Industrial
Park Hsinchu Taiwan 308
Standard : 47 CFR FCC Part 15.247

The product was received on Apr. 03, 2018, and testing was started from Apr. 10, 2018 and completed on Apr. 26, 2018. We, SPORTON INTERTIONAL INC. EMC & Wireless Communications Laboratory, would like to declare that the tested sample has been evaluated in accordance with the procedures given in FCC Public Notice DA 00-705 and shown compliance with the applicable technical standards.

The report must not be used by the client to claim product certification, approval, or endorsement by TAF or any agency of government.

The test results in this report apply exclusively to the tested model / sample. Without written approval of SPORTON INTERTIONAL INC. EMC & Wireless Communications Laboratory, the test report shall not be reproduced except in full.

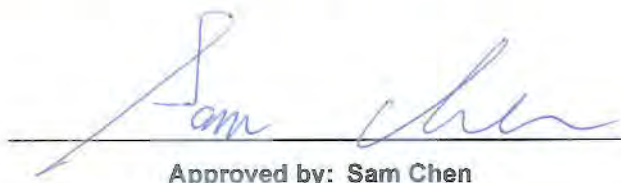

Approved by: Sam Chen

SPORTON INTERTIONAL INC. EMC & Wireless Communications Laboratory
No. 52, Huaya 1st Rd., Guishan Dist., Taoyuan City, Taiwan (R.O.C.)



Table of Contents

History of this test report.....4

Summary of Test Result.....5

1 General Description6

1.1 Information.....6

1.2 Testing Applied Standards9

1.3 Testing Location Information.....9

1.4 Measurement Uncertainty9

2 Test Configuration of EUT10

2.1 Test Channel Mode10

2.2 The Worst Case Measurement Configuration.....11

2.3 EUT Operation during Test12

2.4 Accessories12

2.5 Support Equipment.....13

2.6 Test Setup Diagram14

3 Transmitter Test Result16

3.1 AC Power-line Conducted Emissions16

3.2 20dB Bandwidth and Carrier Frequency Separation.....18

3.3 Maximum Conducted Output Power19

3.4 Number of Hopping Frequencies and Hopping Bandedge20

3.5 Time of Occupancy (Dwell Time)21

3.6 Emissions in Non-restricted Frequency Bands22

3.7 Emissions in Restricted Frequency Bands.....23

4 Test Equipment and Calibration Data26

Appendix A. Test Results of AC Power-line Conducted Emissions

Appendix B. Test Results of 20dB Bandwidth AND Carrier Frequency Separation

Appendix C. Test Results of Maximum Conducted Output Power

Appendix D. Test Results of Number of Hopping Frequencies and Hopping Bandedge

Appendix E. Test Results of Time of Occupancy (Dwell Time)

Appendix F. Test Results of Emissions in Non-restricted Frequency Bands

Appendix G. Test Results of Emissions in Restricted Frequency Bands



Appendix H. Test Results of Radiated Emission Co-location

Appendix I. Test Photos

Photographs of EUT v01



Summary of Test Result

Report Clause	Ref Std. Clause	Test Items	Result (PASS/FAIL)	Remark
1.1.2	15.203	Antenna Requirement	PASS	-
3.1	15.207	AC Power-line Conducted Emissions	PASS	-
3.2	15.247(a)	20dB Bandwidth	PASS	-
3.2	15.247(a)	Carrier Frequency Separation	PASS	-
3.3	15.247(b)	Maximum Conducted Output Power	PASS	-
3.4	15.247(a)	Number of Hopping Frequencies and Hopping Band edge	PASS	-
3.5	15.247(a)	Time of Occupancy (Dwell Time)	PASS	-
3.6	15.247(d)	Emissions in Non-restricted Frequency Bands	PASS	-
3.7	15.247(d)	Emissions in Restricted Frequency Bands	PASS	-

Reviewed by: **Sam Chen**
Report Producer: **Sandy Chuang**



1 General Description

1.1 Information

1.1.1 RF General Information

Frequency Range (MHz)	Bluetooth Version	Ch. Frequency (MHz)	Channel Number
2400-2483.5	BR / EDR	2402-2480	0-78 [79]

Band	Mode	BWch (MHz)	Nant
2.4-2.4835GHz	BT-BR(1Mbps)	1	1TX
2.4-2.4835GHz	BT-EDR(2Mbps)	1	1TX
2.4-2.4835GHz	BT-EDR(3Mbps)	1	1TX

Note:

- ◆ Bluetooth BR uses a GFSK (1Mbps).
- ◆ Bluetooth EDR uses a combination of $\pi/4$ -DQPSK (2Mbps) and 8DPSK (3Mbps).
- ◆ Bluetooth BR/EDR uses as a system using FHSS modulation.
- ◆ BWch is the nominal channel bandwidth.
- ◆ Nss-Min is the minimum number of spatial streams.
- ◆ Nant is the number of outputs. e.g., 2(2, 3) means have 2 outputs for port 2 and port 3. 2 means have 2 outputs for port 1 and port 2.



1.1.2 Antenna Information

Ant.	Port	Brand	Model Name	Antenna Type	Connector	Gain (dBi)		
						2.4GHz WLAN	5GHz WLAN	Bluetooth
1	1	INPAQ	WA-P-LB-01-213	Dipole Antenna	I-PEX	2.92	3.99	2.92
2	2	INPAQ	WA-P-LB-02-564	Dipole Antenna	I-PEX	2.82	4.00	-

Note: 1. The EUT has two antennas.

Note: 2. Ant. 1 supports WLAN and Bluetooth, Ant. 2 supports WLAN only.

<For 2.4GHz Band>

For IEEE 802.11b mode (1TX/2RX)

The EUT supports 1TX/2RX function, and it supports TX diversity function.

Both Port 1 and Port 2 could be used as transmitting antenna, but only one of them will be used at one time. Port 1 and Port 2 could receive simultaneously.

Port 2 generated the worst case than Port 1, so it is tested and recorded in the report.

For IEEE 802.11g/n mode (2TX/2RX)

Port 1 and Port 2 can be used as transmitting/receiving antenna.

Port 1 and Port 2 could transmit/receive simultaneously.

<For 5GHz Band>

For IEEE 802.11a/n/ac mode (2TX/2RX)

Port 1 and Port 2 can be used as transmitting/receiving antenna.

Port 1 and Port 2 could transmit/receive simultaneously.

<For Bluetooth function>

For bluetooth mode (1TX/1RX):

Only Port 1 can be used as transmitting/receiving antenna.



1.1.3 Mode Test Duty Cycle

Mode	DC	DCF(dB)	T(s)	VBW(Hz) $\geq 1/T$
BT-BR(1Mbps)	0.306	5.143	382.5u	3k
BT-EDR(2Mbps)	0.758	1.203	2.89m	1k
BT-EDR(3Mbps)	0.726	1.391	2.835m	1k

1.1.4 EUT Operational Condition

EUT Power Type	From host system
Test Software Version	Hyper Terminal 5.1.2600.0



1.2 Testing Applied Standards

According to the specifications of the manufacturer, the EUT must comply with the requirements of the following standards:

- ◆ 47 CFR FCC Part 15
- ◆ FCC Public Notice DA 00-705
- ◆ FCC KDB 412172 D01 v01r01

1.3 Testing Location Information

Testing Location		
<input type="checkbox"/>	HWA YA	ADD : No. 52, Hwa Ya 1st Rd., Kwei-Shan Hsiang, Tao Yuan Hsien, Taiwan, R.O.C. TEL : 886-3-327-3456 FAX : 886-3-318-0055
<input checked="" type="checkbox"/>	JHUBEI	ADD : No.8, Lane 724, Bo-ai St., Jhubei City, HsinChu County 302, Taiwan, R.O.C. TEL : 886-3-656-9065 FAX : 886-3-656-9085

Test Condition	Test Site No.	Test Engineer	Test Environment	Test Date
RF Conducted	TH01-CB	Brian Sun / Caster Chang / Justin Liu	22°C / 54%	Apr. 15, 2018~ Apr. 23, 2018
Radiated	03CH01-CB	Ekko Hsieh / Gino Huang	23.5°C / 49%	Apr. 10, 2018~ Apr. 26, 2018
AC Conduction	CO01-CB	GN Hou	23°C / 58%	Apr. 24, 2018

Test site Designation No. TW0006 with FCC.

Test site registered number IC 4086D with Industry Canada.

1.4 Measurement Uncertainty

ISO/IEC 17025 requires that an estimate of the measurement uncertainties associated with the emissions test results be included in the report. The measurement uncertainties given below are based on a 95% confidence level (based on a coverage factor (k=2))

Test Items	Uncertainty	Remark
Conducted Emission (150kHz ~ 30MHz)	3.2 dB	Confidence levels of 95%
Radiated Emission (30MHz ~ 1,000MHz)	3.6 dB	Confidence levels of 95%
Radiated Emission (1GHz ~ 18GHz)	3.7 dB	Confidence levels of 95%
Radiated Emission (18GHz ~ 40GHz)	3.5 dB	Confidence levels of 95%
Conducted Emission	1.7 dB	Confidence levels of 95%
Output Power Measurement	1.33 dB	Confidence levels of 95%
Bandwidth Measurement	9.74 x10 ⁻⁸	Confidence levels of 95%



2 Test Configuration of EUT

2.1 Test Channel Mode

Mode	PowerSetting
BT-BR(1Mbps)	-
2402MHz	08
2440MHz	08
2480MHz	08
BT-EDR(2Mbps)	-
2402MHz	08
2440MHz	08
2480MHz	08
BT-EDR(3Mbps)	-
2402MHz	08
2440MHz	08
2480MHz	08



2.2 The Worst Case Measurement Configuration

The Worst Case Mode for Following Conformance Tests	
Tests Item	AC power-line conducted emissions
Condition	AC power-line conducted measurement for line and neutral
Operating Mode	CTX
1	2.4GHz
2	5GHz
3	Bluetooth
For operating mode 1 is the worst case and it was record in this test report.	

The Worst Case Mode for Following Conformance Tests	
Tests Item	20dB Bandwidth Carrier Frequency Separation Maximum Conducted Output Power Number of Hopping Frequencies Hopping Bandedge Time of Occupancy (Dwell Time) Emissions in Non-restricted Frequency Bands
Test Condition	Conducted measurement at transmit chains

The Worst Case Mode for Following Conformance Tests	
Tests Item	Emissions in Restricted Frequency Bands
Test Condition	Radiated measurement If EUT consist of multiple antenna assembly (multiple antenna are used in EUT regardless of spatial multiplexing MIMO configuration), the radiated test should be performed with highest antenna gain of each antenna type.
Operating Mode < 1GHz	CTX
Radiated Emissions above 1GHz test was performed at its 3-axis (X-axis, Y-axis and Z-axis). Y-axis was the worst case, so Radiated Emission test below 1GHz will follow this same configuration.	
1	2.4GHz in Y-axis
2	5GHz in Y-axis
3	Bluetooth in Y-axis
For operating mode 1 is the worst case and it was record in this test report.	
Operating Mode > 1GHz	CTX
Radiated Emissions above 1GHz test was performed at its 3-axis (X-axis, Y-axis and Z-axis). Y-axis was the worst case, so test will follow this same configuration.	
1	CTX + Bluetooth in Y-axis



The Worst Case Mode for Following Conformance Tests	
Tests Item	Simultaneous Transmission Analysis - Radiated Emission Co-location
Test Condition	Radiated measurement
Operating Mode	Normal Link
1	WLAN 5GHz+ Bluetooth

Refer to Appendix H for Radiated Emission Co-location.

The Worst Case Mode for Following Conformance Tests	
Tests Item	Simultaneous Transmission Analysis - Co-location RF Exposure Evaluation
Operating Mode	
1	WLAN 5GHz+ Bluetooth

Refer to Sporton Test Report No.: FA832852 for Co-location RF Exposure Evaluation.

2.3 EUT Operation during Test

The EUT was programmed to be in continuously transmitting mode.

2.4 Accessories

N/A



2.5 Support Equipment

For Test Site No: C001-CB

Support Equipment				
No.	Equipment	Brand Name	Model Name	FCC ID
1	Test fixture	CyberTAN	T32X010CT00	N/A
2	NB	DELL	E6220	N/A
No.	Equipment	Brand Name	Model Name	FCC ID
3	Adapter	DEE VAN ENTERPRISE CO., LTD.	DSA-12PFU-05 FUS 050200	N/A

For Test Site No: 03CH01-CB and TH01-CB

Support Equipment				
No.	Equipment	Brand Name	Model Name	FCC ID
1	NB	DELL	E4300	DoC
2	Test fixture	CyberTAN	T32X010CT00	N/A
No.	Equipment	Brand Name	Model Name	FCC ID
3	Adapter	DEE VAN ENTERPRISE CO., LTD.	DSA-12PFU-05 FUS 050200	N/A



2.6 Test Setup Diagram

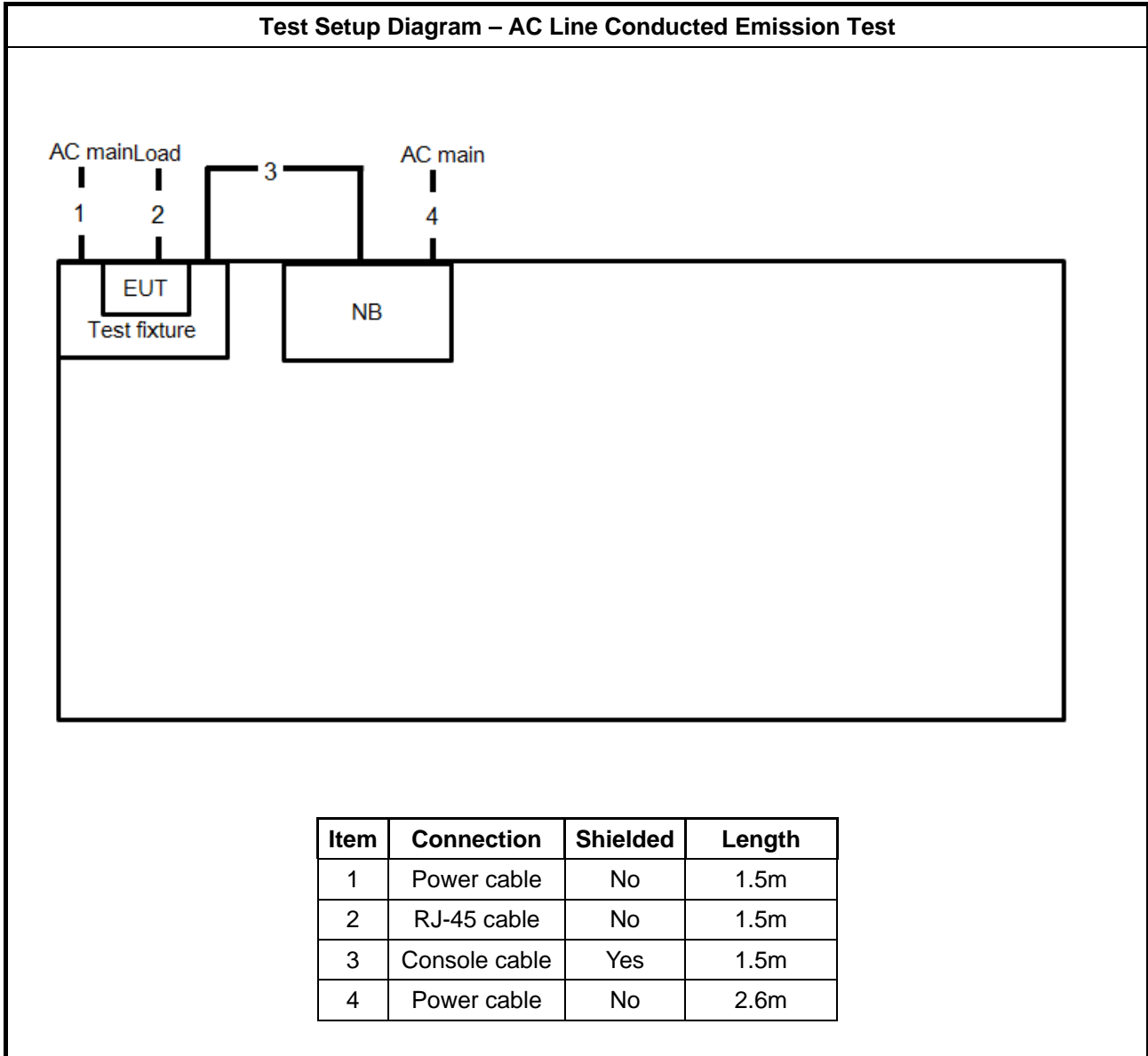



Test Setup Diagram - Radiated Test

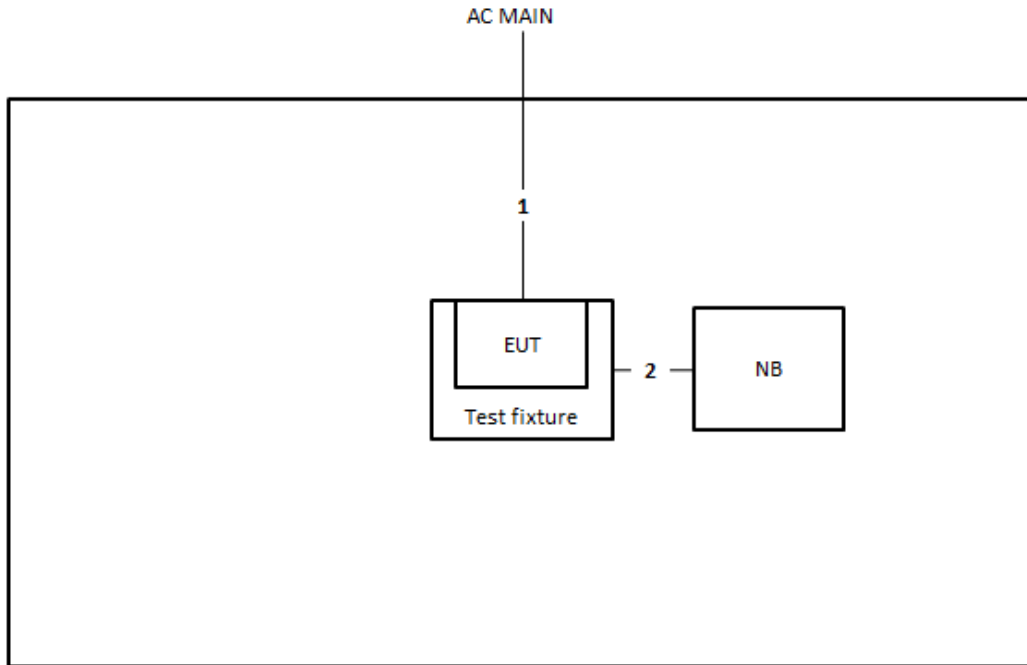

Item	Connection	Shielded	Length
1	Power cable	No	1.5m
2	Console cable	Yes	0.6m



3 Transmitter Test Result

3.1 AC Power-line Conducted Emissions

3.1.1 AC Power-line Conducted Emissions Limit

AC Power-line Conducted Emissions Limit		
Frequency Emission (MHz)	Quasi-Peak	Average
0.15-0.5	66 - 56 *	56 - 46 *
0.5-5	56	46
5-30	60	50

Note 1: * Decreases with the logarithm of the frequency.

3.1.2 Measuring Instruments

Refer a test equipment and calibration data table in this test report.

3.1.3 Test Procedures

Test Method
▪ Refer as ANSI C63.10-2013, clause 6.2 for AC power-line conducted emissions.

3.1.4 Test Setup

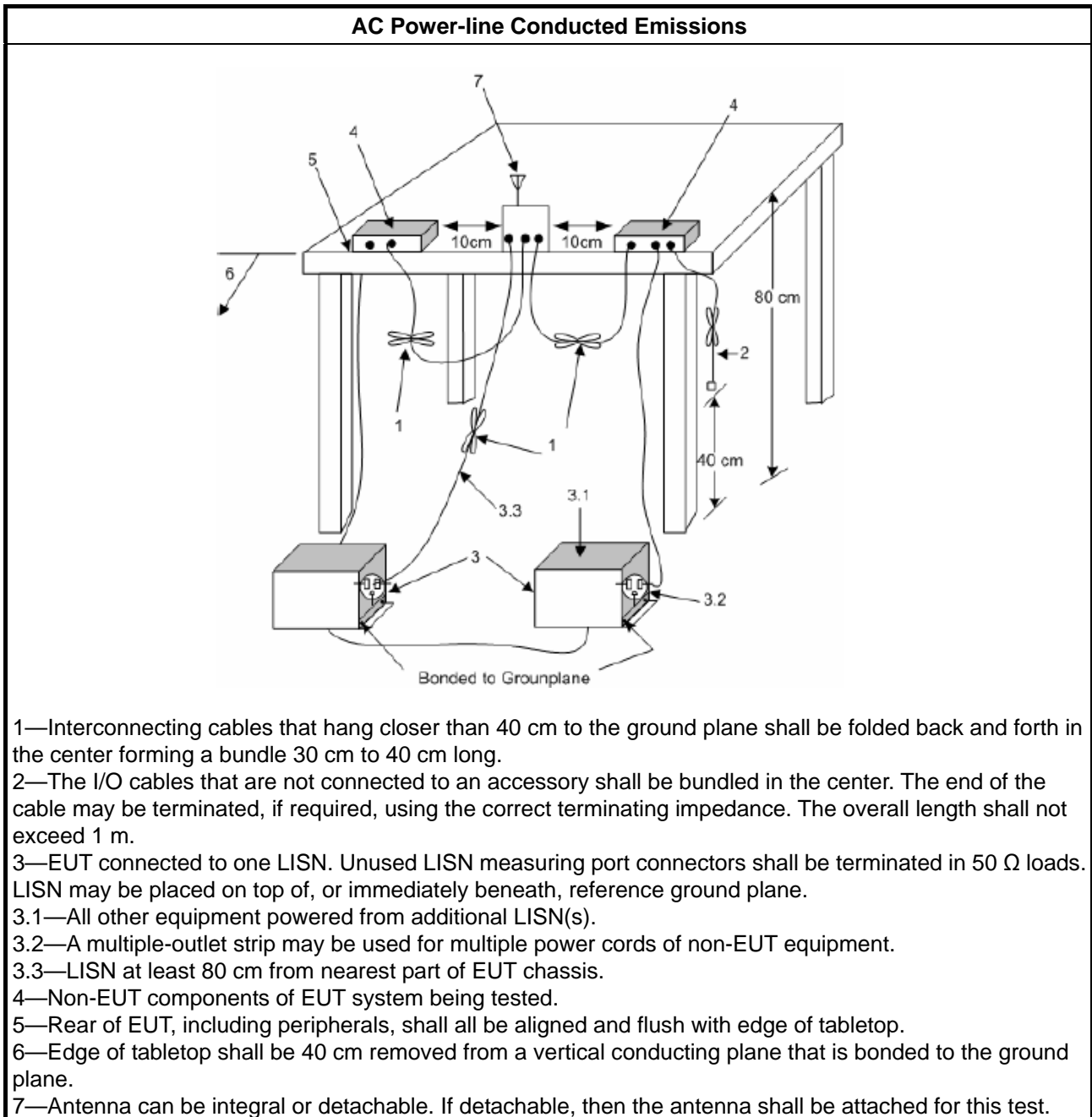

3.1.5 Test Result of AC Power-line Conducted Emissions

Refer as Appendix A

3.2 20dB Bandwidth and Carrier Frequency Separation

3.2.1 20dB Bandwidth and Carrier Frequency Separation Limit

20dB Bandwidth and Carrier Frequency Separation Limit for Frequency Hopping Systems	
<ul style="list-style-type: none"> 902-928 MHz Band: <ul style="list-style-type: none"> $N \geq 50$ and $ChS \geq \text{MAX}$ (20 dB bandwidth, 25 kHz); 20 dB bandwidth \leq 250 kHz. $50 > N \geq 25$ and $ChS \geq \text{MAX}$ (20 dB bandwidth, 25 kHz); 20 dB bandwidth $>$ 250 kHz. 2400-2483.5 MHz Band: <ul style="list-style-type: none"> $N \geq 75$ and $ChS \geq \text{MAX}$ (20 dB bandwidth, 25 kHz). $75 > N \geq 15$ and $ChS \geq \text{MAX}$ (20 dB bandwidth 2/3, 25 kHz). 5725-5850 MHz Band: <ul style="list-style-type: none"> $N \geq 75$ and $ChS \geq \text{MAX}$ (20 dB bandwidth, 25 kHz); 20 dB bandwidth \leq 1 MHz. 	
N: Number of Hopping Frequencies; ChS: Hopping Channel Separation	

3.2.2 Measuring Instruments

Refer a test equipment and calibration data table in this test report.

3.2.3 Test Procedures

Test Method
<ul style="list-style-type: none"> Refer as FCC Public Notice DA 00-705, clause 6.9.1 for 20 dB bandwidth measurement. Refer as FCC Public Notice DA 00-705, clause 7.8.2 for carrier frequency separation measurement.

3.2.4 Test Setup

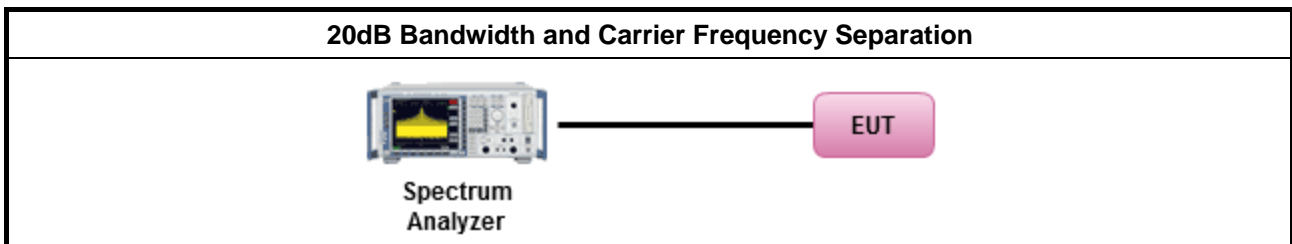

3.2.5 Test Result of 20dB Bandwidth

Refer as Appendix B

3.2.6 Test Result of Carrier Frequency Separation

Refer as Appendix B

3.3 Maximum Conducted Output Power

3.3.1 Maximum Conducted Output Power Limit

Maximum Conducted Output Power Limit	
<ul style="list-style-type: none"> 902-928 MHz Band: 	
	<ul style="list-style-type: none"> N ≥ 50; Power 30dBm; EIRP 36dBm
	<ul style="list-style-type: none"> 50 > N ≥ 25; Power 24dBm; EIRP 30dBm
<ul style="list-style-type: none"> 2400-2483.5 MHz Band: 	
	<ul style="list-style-type: none"> N ≥ 75; Power 30dBm; EIRP 36dBm
	<ul style="list-style-type: none"> 75 > N ≥ 15; Power 21dBm; EIRP 27dBm
<ul style="list-style-type: none"> 5725-5850 MHz Band: 	
	<ul style="list-style-type: none"> N ≥ 75; Power 30dBm; EIRP 36dBm
N: Number of Hopping Frequencies	

3.3.2 Measuring Instruments

Refer a test equipment and calibration data table in this test report.

3.3.3 Test Procedures

Test Method
<ul style="list-style-type: none"> Refer as FCC Public Notice DA 00-705, clause 7.8.5 for output power measurement.

3.3.4 Test Setup

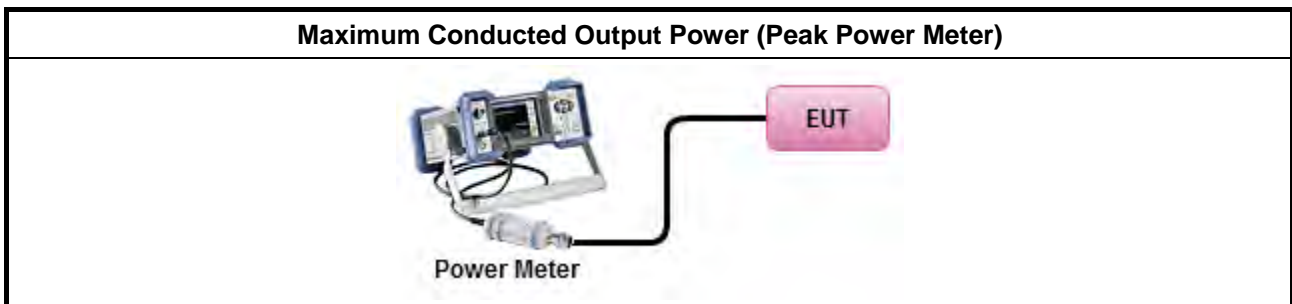

3.3.5 Test Result of Maximum Conducted Output Power

Refer as Appendix C

3.4 Number of Hopping Frequencies and Hopping Bandedge

3.4.1 Number of Hopping Frequencies Limit

Number of Hopping Frequencies Limit	
▪	902-928 MHz Band:
	▪ $N \geq 50$ and $ChS \geq MAX$ (20 dB bandwidth, 25 kHz); 20 dB bandwidth \leq 250 kHz.
	▪ $50 > N \geq 25$ and $ChS \geq MAX$ (20 dB bandwidth, 25 kHz); 20 dB bandwidth $>$ 250 kHz.
▪	2400-2483.5 MHz Band:
	▪ $N \geq 75$ and $ChS \geq MAX$ (20 dB bandwidth, 25 kHz).
	▪ $75 > N \geq 15$ and $ChS \geq MAX$ (20 dB bandwidth 2/3, 25 kHz).
▪	5725-5850 MHz Band:
	▪ $N \geq 75$ and $ChS \geq MAX$ (20 dB bandwidth, 25 kHz); 20 dB bandwidth \leq 1 MHz.
N: Number of Hopping Frequencies; ChS : Hopping Channel Separation	

3.4.2 Hopping Bandedge Limit

Refer clause 3.6.1 and clause 3.7.1

3.4.3 Measuring Instruments

Refer a test equipment and calibration data table in this test report.

3.4.4 Test Procedures

Test Method
▪ Refer as FCC Public Notice DA 00-705 , clause 7.8.3 for number of hopping frequencies measurement.
▪ Refer as FCC Public Notice DA 00-705 , clause 7.8.6 for hopping frequencies Bandedge measurement.

3.4.5 Test Setup

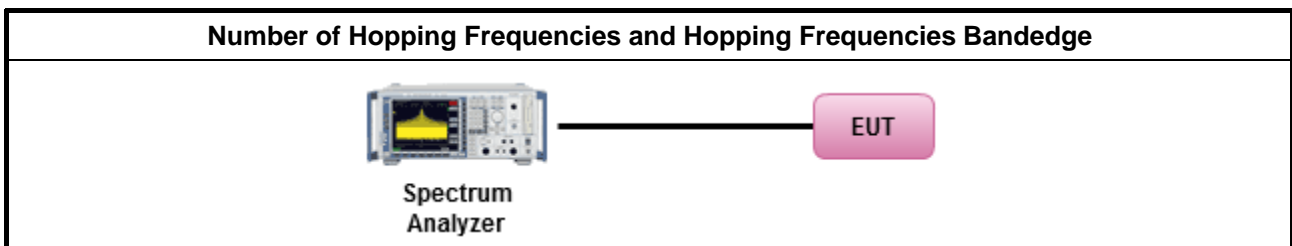

3.4.6 Test Result of Number of Hopping Frequencies

Refer as Appendix D

3.4.7 Test Result of Number of Hopping Frequencies Bandedge

Refer as Appendix D

3.5 Time of Occupancy (Dwell Time)

3.5.1 Time of Occupancy (Dwell Time) Limit

20dB Bandwidth and Carrier Frequency Separation Limit for Frequency Hopping Systems	
<ul style="list-style-type: none"> 902-928 MHz Band: 	
	<ul style="list-style-type: none"> N ≥ 50; 0.4s in 20s period
	<ul style="list-style-type: none"> 50 > N ≥ 25; 0.4s in 10s period
<ul style="list-style-type: none"> 2400-2483.5 MHz Band: 	
	<ul style="list-style-type: none"> N ≥ 75; 0.4s in N x 0.4 period
	<ul style="list-style-type: none"> 75 > N ≥ 15; 0.4s in N x 0.4 period
<ul style="list-style-type: none"> 5725-5850 MHz Band: 	
	<ul style="list-style-type: none"> N ≥ 75; 0.4s in 30s period
N: Number of Hopping Frequencies	

3.5.2 Measuring Instruments

Refer a test equipment and calibration data table in this test report.

3.5.3 Test Procedures

Test Method	
<ul style="list-style-type: none"> Refer as FCC Public Notice DA 00-705, clause 7.8.4 for dwell time measurement. 	
<ul style="list-style-type: none"> Bluetooth ACL packets can be 1, 3, or 5 time slots. Following as dwell time. Operate DH5 at maximum dwell time and maximum duty cycle. 	
	<ul style="list-style-type: none"> The DH5 packet can cover up to 5 time slots. Operate DH5 at maximum dwell time and maximum duty cycle. A maximum length packet has duration of 5 time slots. The hopping rate is 1600 hops/second so the maximum dwell time is 5/1600 seconds, or 3.125ms. DH5 Packet permit maximum $1600 / 79 / 6 = 3.37$ hops per second in each channel.

3.5.4 Test Setup

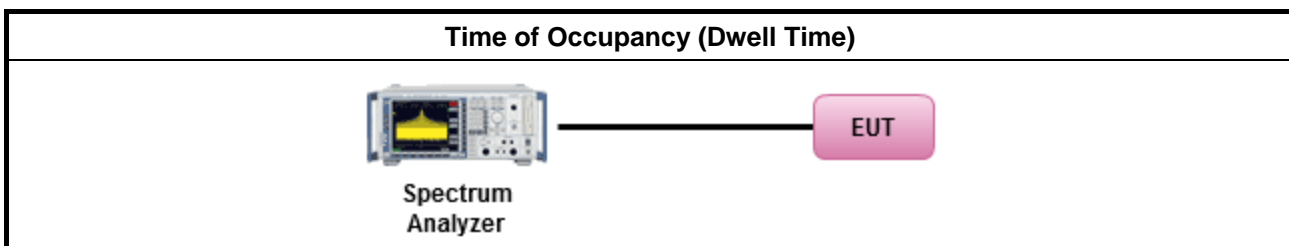

3.5.5 Test Result of Time of Occupancy (Dwell Time)

Refer as Appendix E

3.6 Emissions in Non-restricted Frequency Bands

3.6.1 Emissions in Non-restricted Frequency Bands Limit

Un-restricted Band Emissions Limit	
RF output power procedure	Limit (dB)
Peak output power procedure	20

Note 1: If the peak output power procedure is used to measure the fundamental emission power to demonstrate compliance to requirements, then the peak conducted output power measured within any 100 kHz outside the authorized frequency band shall be attenuated by at least 20 dB relative to the maximum measured in-band peak PSD level.

3.6.2 Measuring Instruments

Refer a test equipment and calibration data table in this test report.

3.6.3 Test Procedures

Test Method
<ul style="list-style-type: none"> Refer as FCC Public Notice DA 00-705, clause 7.8.8 for unwanted emissions into non-restricted bands.

3.6.4 Test Setup

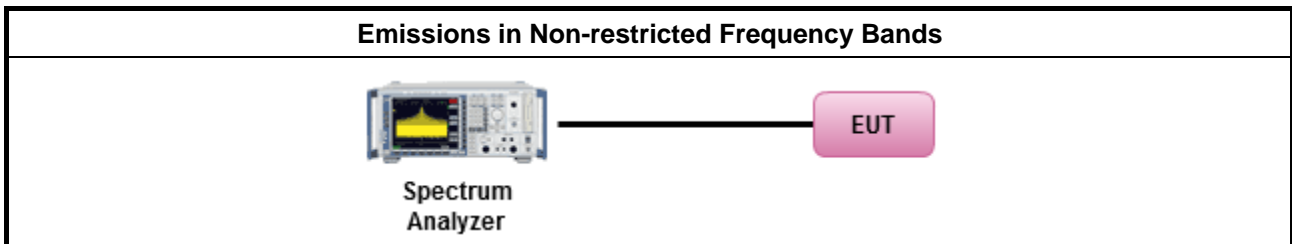

3.6.5 Test Result of Emissions in Non-restricted Frequency Bands

Refer as Appendix F



3.7 Emissions in Restricted Frequency Bands

3.7.1 Emissions in Restricted Frequency Bands Limit

Restricted Band Emissions Limit			
Frequency Range (MHz)	Field Strength (uV/m)	Field Strength (dBuV/m)	Measure Distance (m)
0.009~0.490	2400/F(kHz)	48.5 - 13.8	300
0.490~1.705	24000/F(kHz)	33.8 - 23	30
1.705~30.0	30	29	30
30~88	100	40	3
88~216	150	43.5	3
216~960	200	46	3
Above 960	500	54	3

Note 1: Test distance for frequencies at or above 30 MHz, measurements may be performed at a distance other than the limit distance provided they are not performed in the near field and the emissions to be measured can be detected by the measurement equipment. When performing measurements at a distance other than that specified, the results shall be extrapolated to the specified distance using an extrapolation factor of 20 dB/decade (inverse of linear distance for field-strength measurements, inverse of linear distance-squared for power-density measurements).

Note 2: Test distance for frequencies at below 30 MHz, measurements may be performed at a distance closer than the EUT limit distance; however, an attempt should be made to avoid making measurements in the near field. When performing measurements below 30 MHz at a closer distance than the limit distance, the results shall be extrapolated to the specified distance by either making measurements at a minimum of two or more distances on at least one radial to determine the proper extrapolation factor or by using the square of an inverse linear distance extrapolation factor (40 dB / decade). The test report shall specify the extrapolation method used to determine compliance of the EUT.

Note 3: Using the distance of 1m during the test for above 18 GHz, and the test value to correct for the distance factor at 3m.

3.7.2 Measuring Instruments

Refer a test equipment and calibration data table in this test report.

3.7.3 Test Procedures

Test Method	
<ul style="list-style-type: none"> The average emission levels shall be measured in [hopping duty factor]. 	
<ul style="list-style-type: none"> Refer as ANSI C63.10; clause 6.9.2.2 band-edge testing shall be performed at the lowest frequency channel and highest frequency channel within the allowed operating band. 	
<ul style="list-style-type: none"> For the transmitter unwanted emissions shall be measured using following options below: <ul style="list-style-type: none"> Refer as ANSI C63.10, clause 4.1.4.2.1 QP value. Refer as ANSI C63.10, clause 4.1.4.2.2 measurement procedure peak. Refer as ANSI C63.10, clause 4.1.4.2.4 average value of hopping pulsed emissions. 	

3.7.4 Test Setup

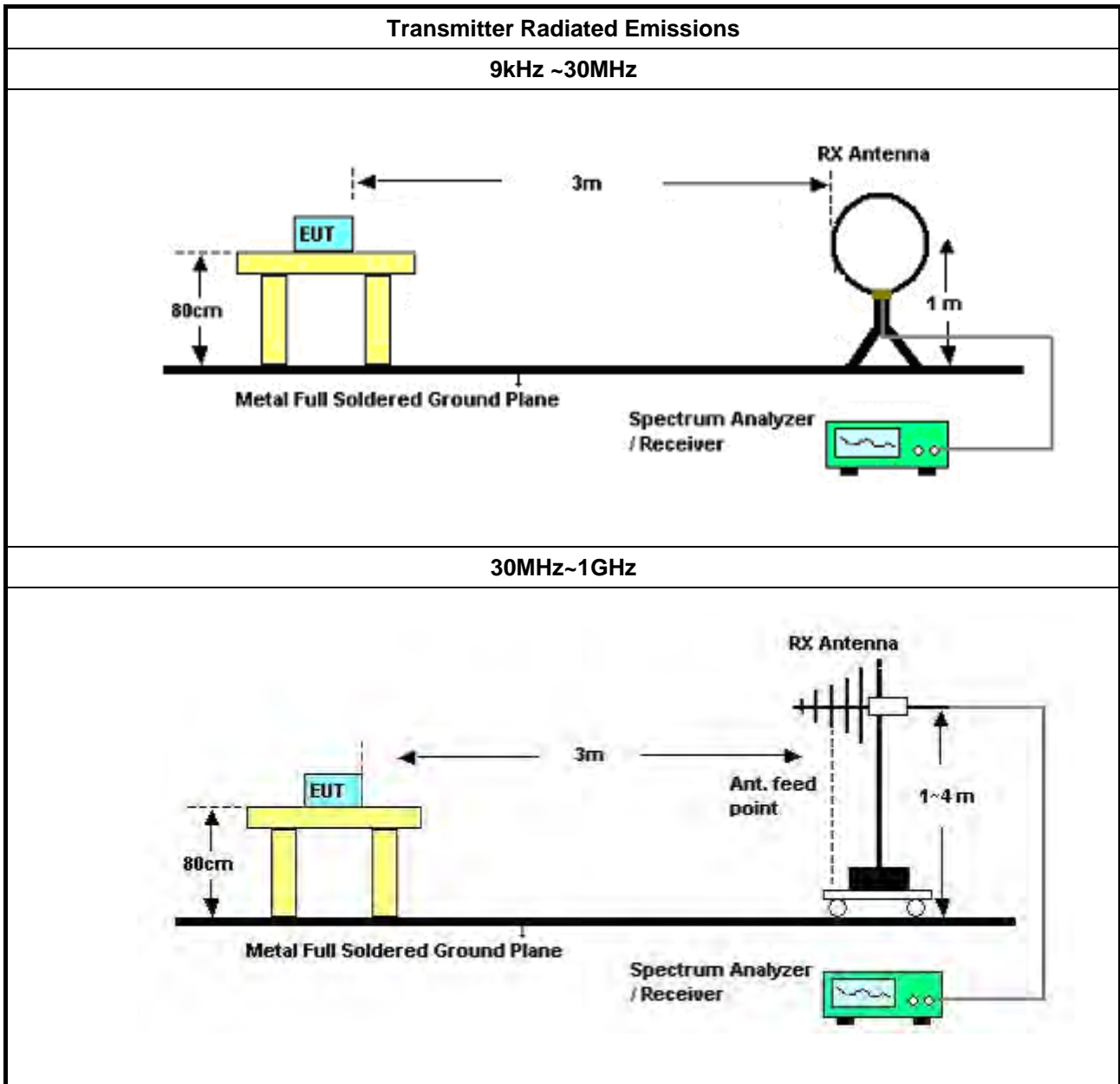

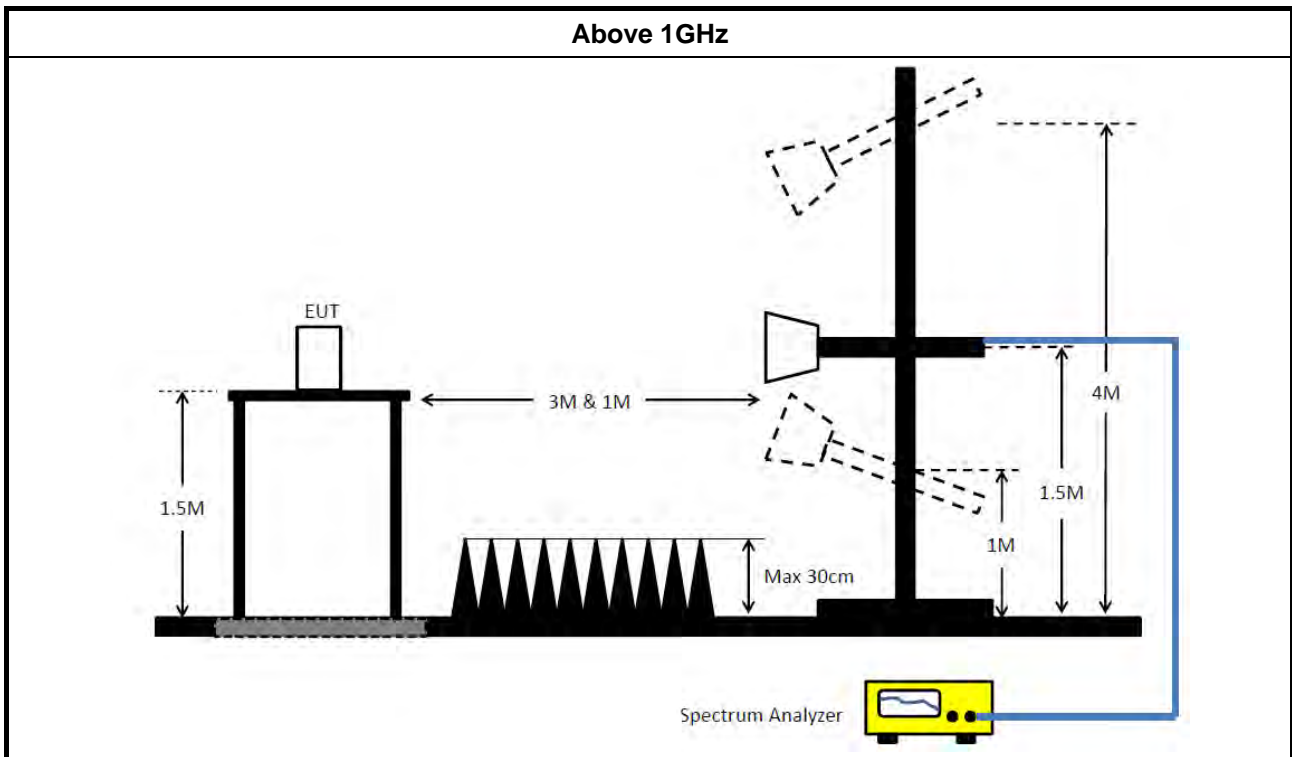

3.7.5 Transmitter Radiated Unwanted Emissions (Below 30MHz)

All amplitude of spurious emissions that are attenuated by more than 20 dB below the permissible value has no need to be reported.

The radiated emissions were investigated from 9 kHz or the lowest frequency generated within the device, up to the 10 harmonic or 40 GHz, whichever is appropriate.

3.7.6 Transmitter Radiated Unwanted Emissions

Refer as Appendix G



4 Test Equipment and Calibration Data

Instrument	Manufacturer	Model No.	Serial No.	Characteristics	Calibration Date	Calibration Due Date	Remark
EMI Receiver	Agilent	N9038A	My52260123	9kHz ~ 8.45GHz	Jan. 31, 2018	Jan. 30, 2019	Conduction (CO01-CB)
LISN	F.C.C.	FCC-LISN-50-16-2	04083	150kHz ~ 100MHz	Dec. 20, 2017	Dec. 19, 2018	Conduction (CO01-CB)
LISN	Schwarzbeck	NSLK 8127	8127647	9kHz ~ 30MHz	Dec. 29, 2017	Dec. 28, 2018	Conduction (CO01-CB)
COND Cable	Woken	Cable	01	150kHz ~ 30MHz	May 23, 2017	May 22, 2018	Conduction (CO01-CB)
Impulsbegrenzer Pulse Limiter	Rohde&Schwarz	ESH3-Z2	100430	9kHz ~ 30MHz	Feb. 06, 2018	Feb. 05, 2019	Conduction (CO01-CB)
Software	Audix	E3	6.120210n	-	N.C.R.	N.C.R.	Conduction (CO01-CB)
BILOG ANTENNA with 6dB Attenuator	TESEQ & EMCI	CBL6112D & N-6-06	37880 & AT-N0609	20MHz ~ 2GHz	Aug. 30, 2017	Aug. 29, 2018	Radiation (03CH01-CB)
Loop Antenna	Teseq	HLA 6120	24155	9kHz - 30 MHz	Mar. 16, 2018	Mar. 15, 2019	Radiation (03CH01-CB)
Horn Antenna	EMCO	3115	00075790	750MHz ~ 18GHz	Nov. 20, 2017	Nov. 19, 2018	Radiation (03CH01-CB)
Horn Antenna	Schwarzbeck	BBHA 9170	BBHA9170252	15GHz ~ 40GHz	Jul. 05, 2017	Jul. 04, 2018	Radiation (03CH01-CB)
Pre-Amplifier	EMCI	EMC330N	980332	20MHz ~ 3GHz	May 02, 2017	May 01, 2018	Radiation (03CH01-CB)
Pre-Amplifier	Agilent	8449B	3008A02310	1GHz ~ 26.5GHz	Jan. 09, 2018	Jan. 08, 2019	Radiation (03CH01-CB)
Pre-Amplifier	MITEQ	TTA1840-35-H G	1864479	18GHz ~ 40GHz	Jul. 10, 2017	Jul. 09, 2018	Radiation (03CH01-CB)
Spectrum Analyzer	R&S	FSP40	100056	9kHz ~ 40GHz	Nov. 23, 2017	Nov. 22, 2018	Radiation (03CH01-CB)
EMI Test	R&S	ESCS	100355	9kHz ~ 2.75GHz	May 06, 2017	May 05, 2018	Radiation (03CH01-CB)
RF Cable-low	Woken	Low Cable-16+17	N/A	30 MHz ~ 1 GHz	Oct. 11, 2017	Oct. 10, 2018	Radiation (03CH01-CB)
RF Cable-high	Woken	High Cable-16	N/A	1 GHz ~ 18 GHz	Oct. 11, 2017	Oct. 10, 2018	Radiation (03CH01-CB)
RF Cable-high	Woken	High Cable-16+17	N/A	1 GHz ~ 18 GHz	Oct. 11, 2017	Oct. 10, 2018	Radiation (03CH01-CB)
RF Cable-high	Woken	High Cable-40G#1	N/A	18GHz ~ 40 GHz	Oct. 11, 2017	Oct. 10, 2018	Radiation (03CH01-CB)
RF Cable-high	Woken	High Cable-40G#2	N/A	18GHz ~ 40 GHz	Oct. 11, 2017	Oct. 10, 2018	Radiation (03CH01-CB)
Spectrum analyzer	R&S	FSV40	100979	9kHz~40GHz	Dec. 21, 2017	Dec. 20, 2018	Conducted (TH01-CB)
RF Cable-high	Woken	RG402	High Cable-06	1 GHz – 26.5 GHz	Oct. 11, 2017	Oct. 10, 2018	Conducted (TH01-CB)



Instrument	Manufacturer	Model No.	Serial No.	Characteristics	Calibration Date	Calibration Due Date	Remark
RF Cable-high	Woken	RG402	High Cable-07	1 GHz –26.5 GHz	Oct. 11, 2017	Oct. 10, 2018	Conducted (TH01-CB)
RF Cable-high	Woken	RG402	High Cable-08	1 GHz –26.5 GHz	Oct. 11, 2017	Oct. 10, 2018	Conducted (TH01-CB)
RF Cable-high	Woken	RG402	High Cable-09	1 GHz –26.5 GHz	Oct. 11, 2017	Oct. 10, 2018	Conducted (TH01-CB)
RF Cable-high	Woken	RG402	High Cable-10	1 GHz –26.5 GHz	Oct. 11, 2017	Oct. 10, 2018	Conducted (TH01-CB)
Power Sensor	Agilent	U2021XA	MY53410001	50MHz~18GHz	Nov. 20, 2017	Nov. 19, 2018	Conducted (TH01-CB)

Note: Calibration Interval of instruments listed above is one year.

NCR means Non-Calibration required.



AC Power-line Conducted Emissions Result

Appendix A

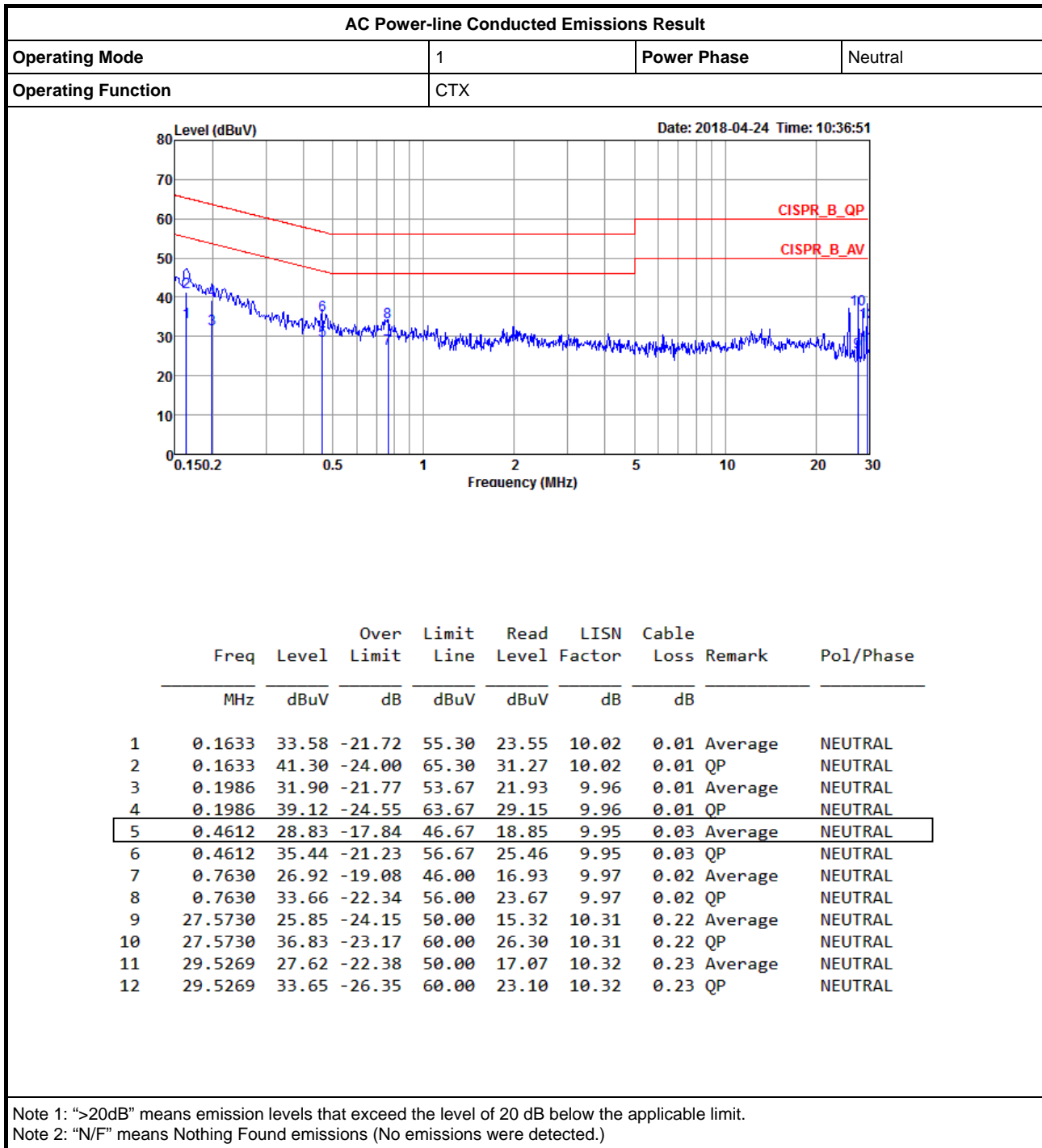



AC Power-line Conducted Emissions Result

Appendix A

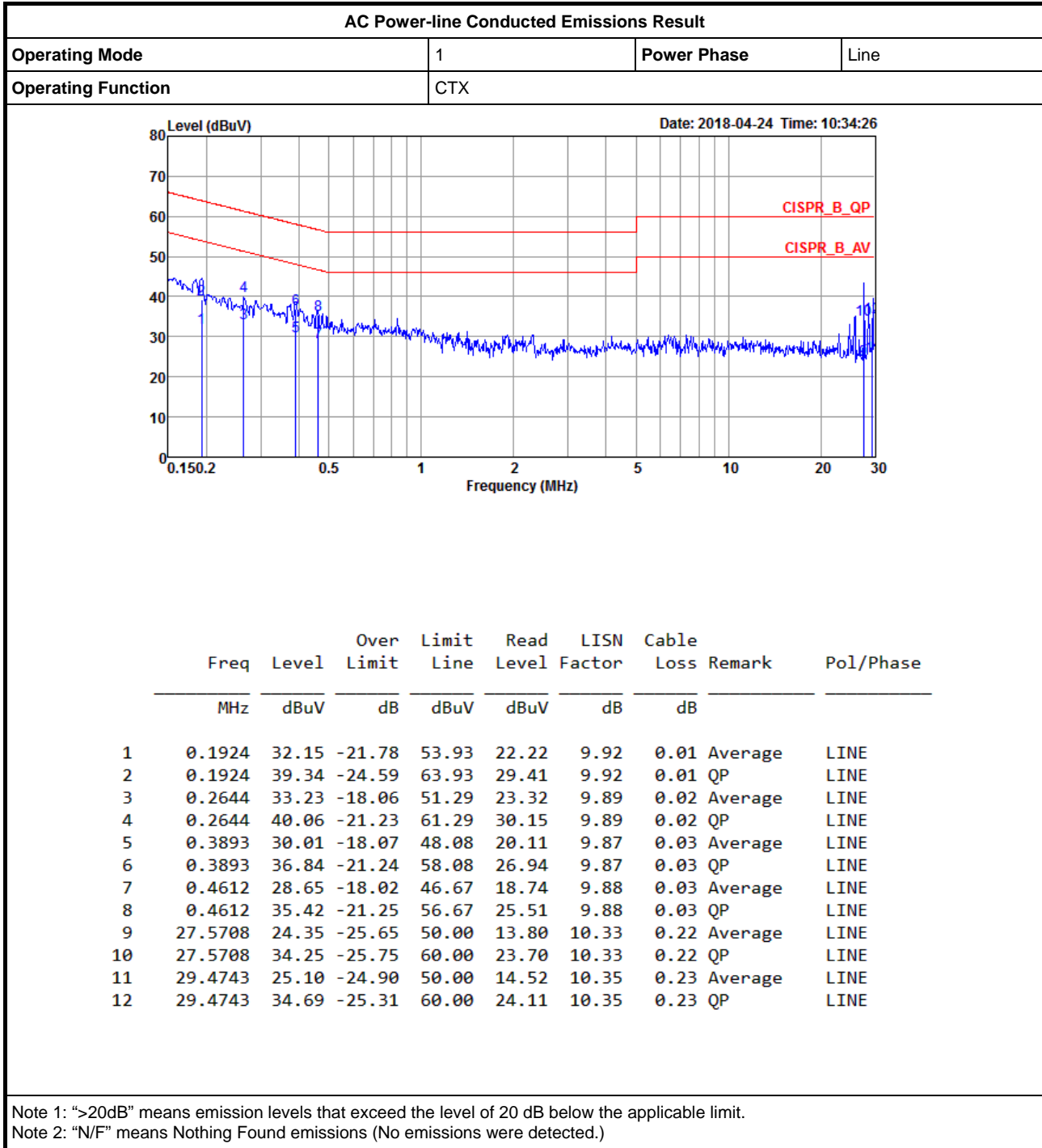



Summary

Mode	Max-N dB (Hz)	Max-OBW (Hz)	ITU-Code	Min-N dB (Hz)	Min-OBW (Hz)
2.4-2.4835GHz	-	-	-	-	-
BT-BR(1Mbps)	920k	887.056k	887KF1D	915k	882.059k
BT-EDR(2Mbps)	1.358M	1.221M	1M22G1D	1.355M	1.217M
BT-EDR(3Mbps)	1.346M	1.218M	1M22G1D	1.344M	1.216M

Max-N dB = Maximum 20dB down bandwidth; **Max-OBW** = Maximum 99% occupied bandwidth;
Min-N dB = Minimum 20dB down bandwidth; **Min-OBW** = Minimum 99% occupied bandwidth;

Result

Mode	Result	Limit (Hz)	Port 1-N dB (Hz)	Port 1-OBW (Hz)
BT-BR(1Mbps)	-	-	-	-
2402MHz	Pass	Inf	920k	884.558k
2440MHz	Pass	Inf	918.75k	887.056k
2480MHz	Pass	Inf	915k	882.059k
BT-EDR(2Mbps)	-	-	-	-
2402MHz	Pass	Inf	1.355M	1.221M
2440MHz	Pass	Inf	1.356M	1.217M
2480MHz	Pass	Inf	1.358M	1.218M
BT-EDR(3Mbps)	-	-	-	-
2402MHz	Pass	Inf	1.346M	1.218M
2440MHz	Pass	Inf	1.345M	1.216M
2480MHz	Pass	Inf	1.344M	1.218M

Port X-N dB = Port X 20dB down bandwidth; **Port X-OBW** = Port X 99% occupied bandwidth;

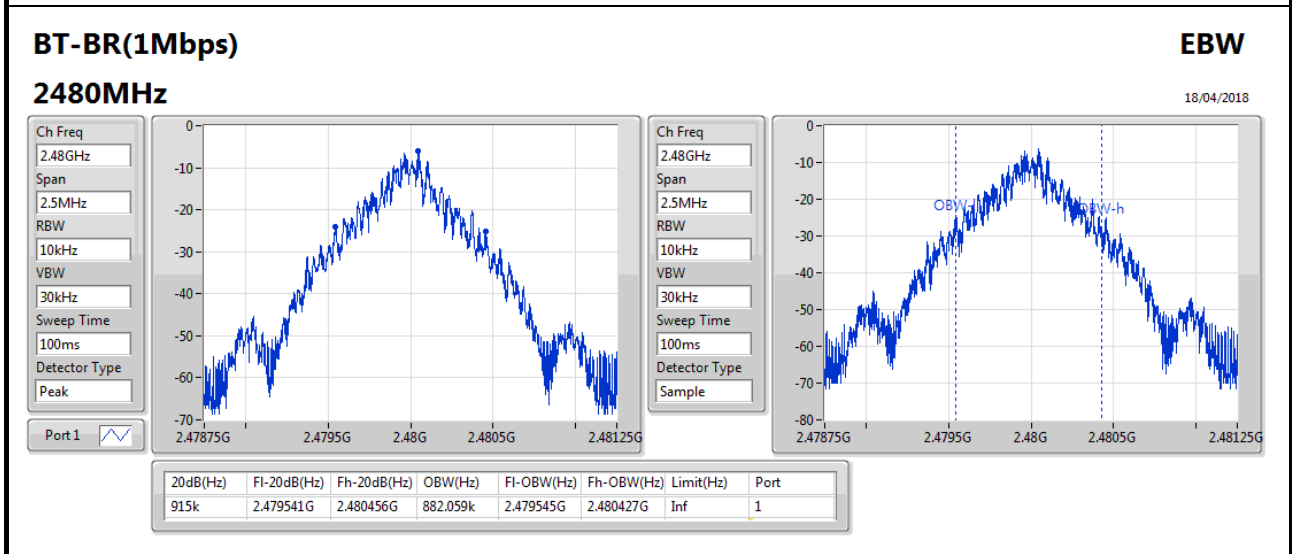
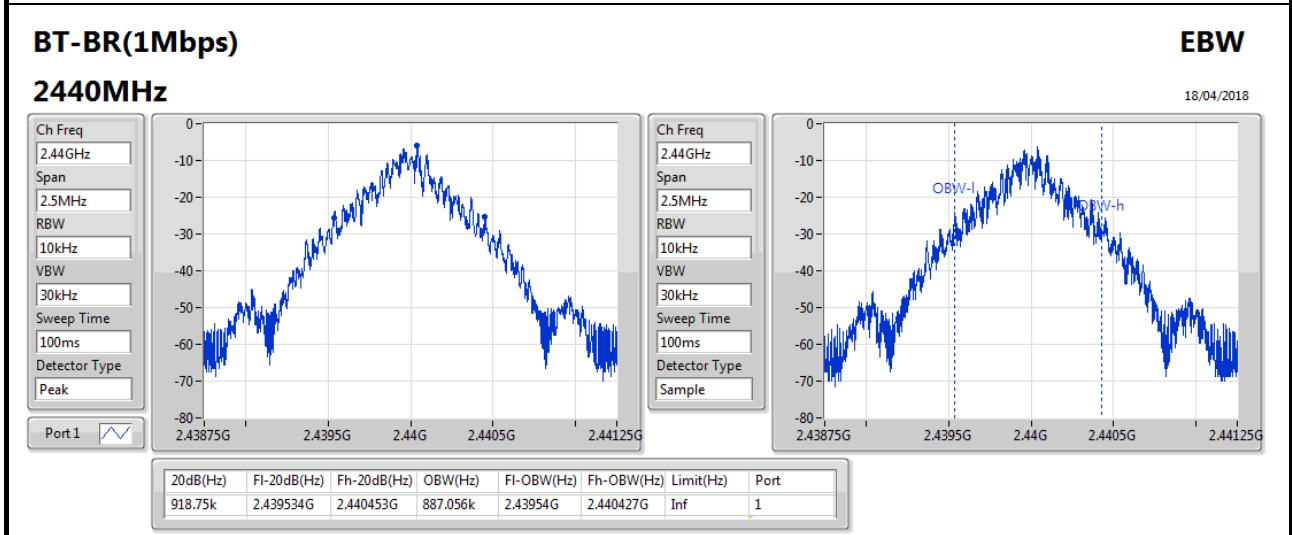
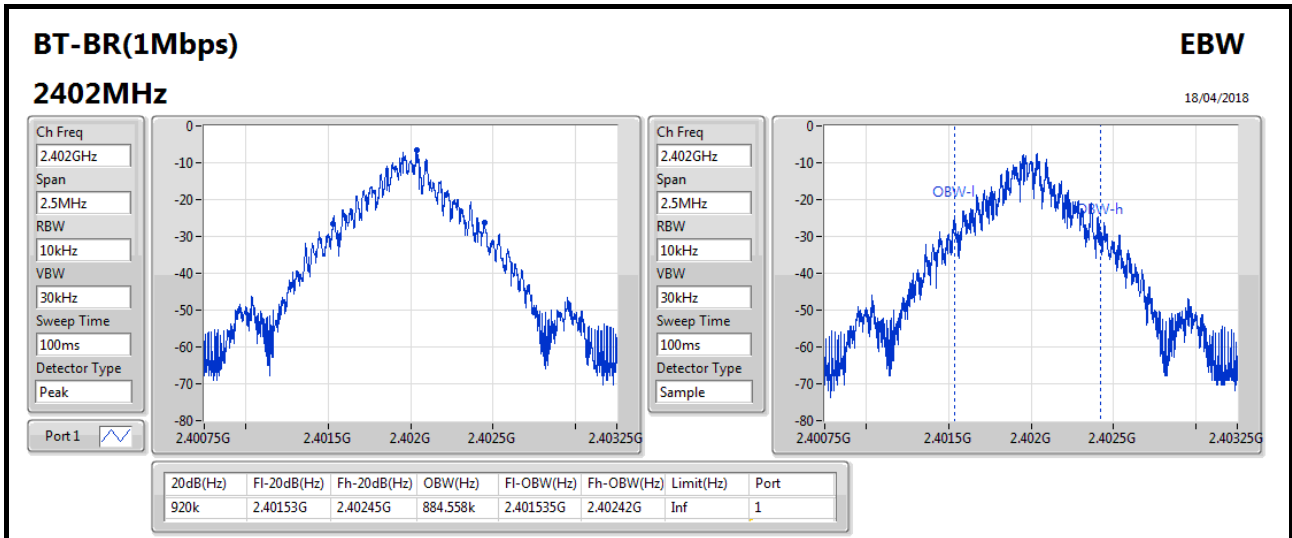

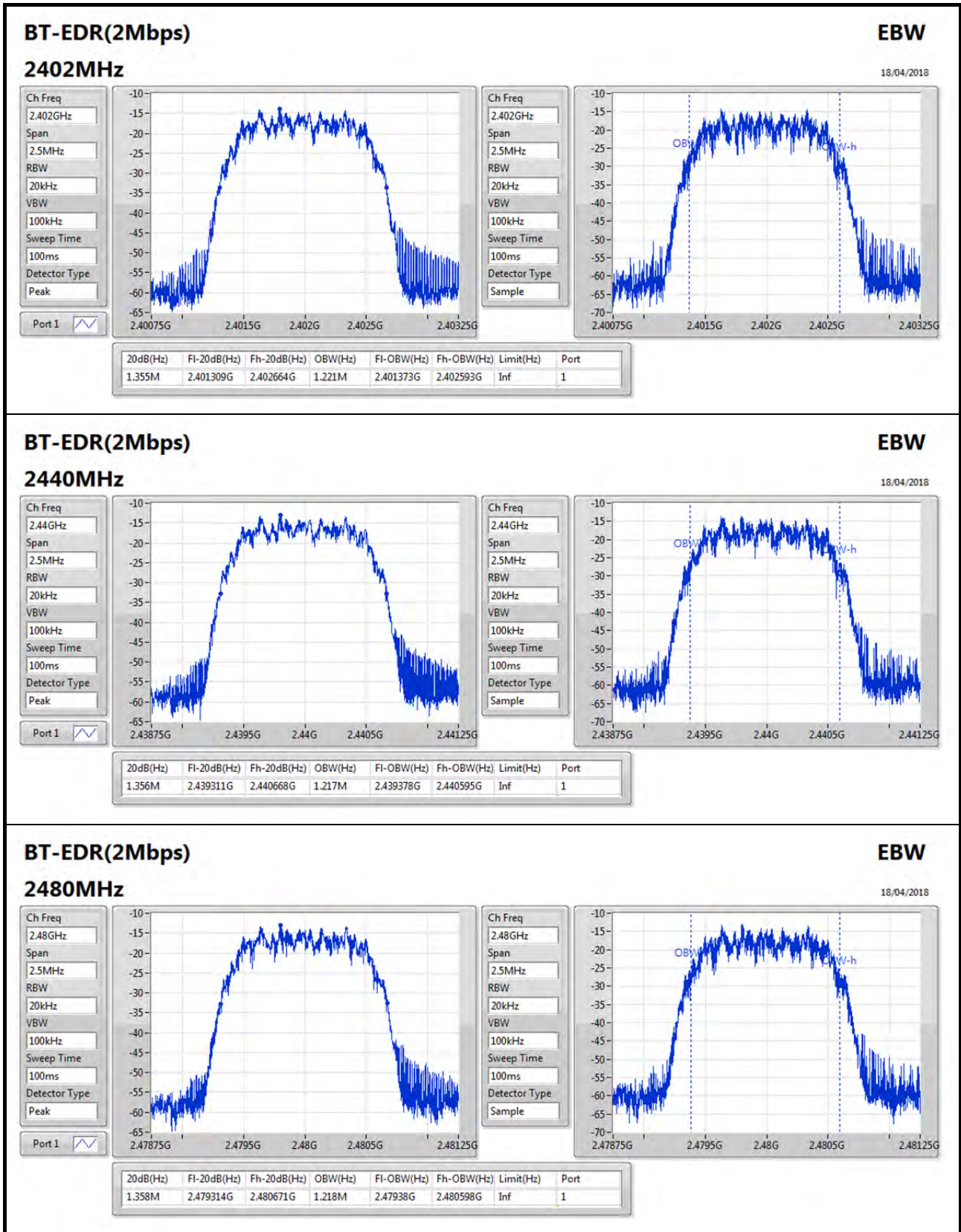
BT-EDR(2Mbps)
EBW

18/04/2018

2480MHz

Ch Freq: 2.48GHz
Span: 2.5MHz
RBW: 20kHz
VBW: 100kHz
Sweep Time: 100ms
Detector Type: Peak

Port 1

Ch Freq: 2.48GHz
Span: 2.5MHz
RBW: 20kHz
VBW: 100kHz
Sweep Time: 100ms
Detector Type: Sample

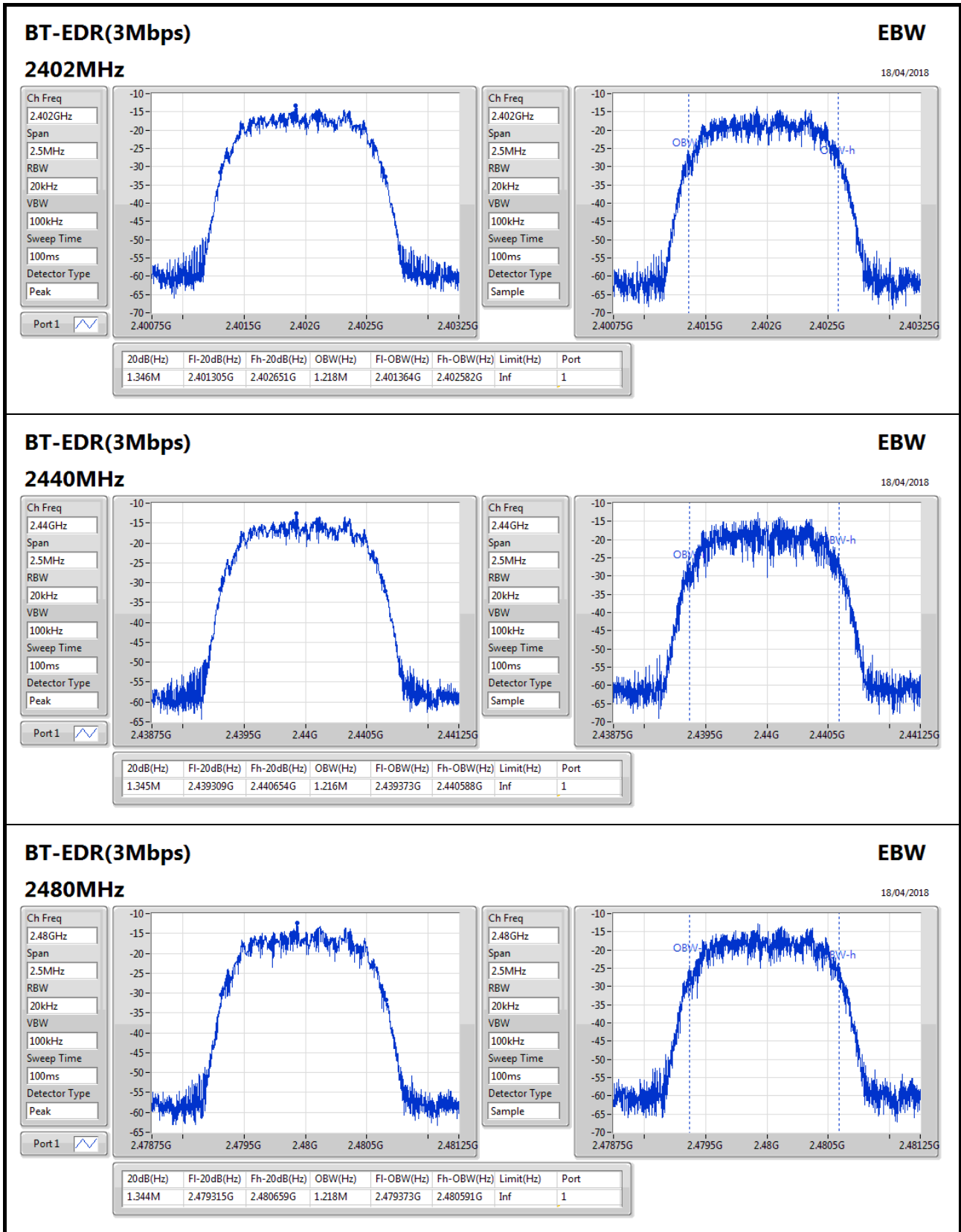
BT-EDR(3Mbps)
EBW

18/04/2018

2480MHz

Ch Freq: 2.48GHz
Span: 2.5MHz
RBW: 20kHz
VBW: 100kHz
Sweep Time: 100ms
Detector Type: Peak

Ch Freq: 2.48GHz
Span: 2.5MHz
RBW: 20kHz
VBW: 100kHz
Sweep Time: 100ms
Detector Type: Sample



Summary

Mode	Max-Space (Hz)	Min-Space (Hz)
2.4-2.4835GHz	-	-
BT-BR(1Mbps)	1.0035M	1.0005M
BT-EDR(2Mbps)	1.0035M	1.0005M
BT-EDR(3Mbps)	1.0005M	999k

Result

Mode	Result	Fl (Hz)	Fh (Hz)	Ch.Space (Hz)	Limit (Hz)
BT-BR(1Mbps)	-	-	-	-	-
2402MHz	Pass	2.402035G	2.403039G	1.0035M	612.72k
2440MHz	Pass	2.44004G	2.44104G	1.0005M	611.8875k
2480MHz	Pass	2.479044G	2.480045G	1.0005M	609.39k
BT-EDR(2Mbps)	-	-	-	-	-
2402MHz	Pass	2.401798G	2.402799G	1.0005M	902.43k
2440MHz	Pass	2.4398G	2.440802G	1.002M	903.096k
2480MHz	Pass	2.478803G	2.479806G	1.0035M	904.428k
BT-EDR(3Mbps)	-	-	-	-	-
2402MHz	Pass	2.401923G	2.402923G	1.0005M	896.436k
2440MHz	Pass	2.440112G	2.441112G	1.0005M	895.77k
2480MHz	Pass	2.478935G	2.479934G	999k	895.104k

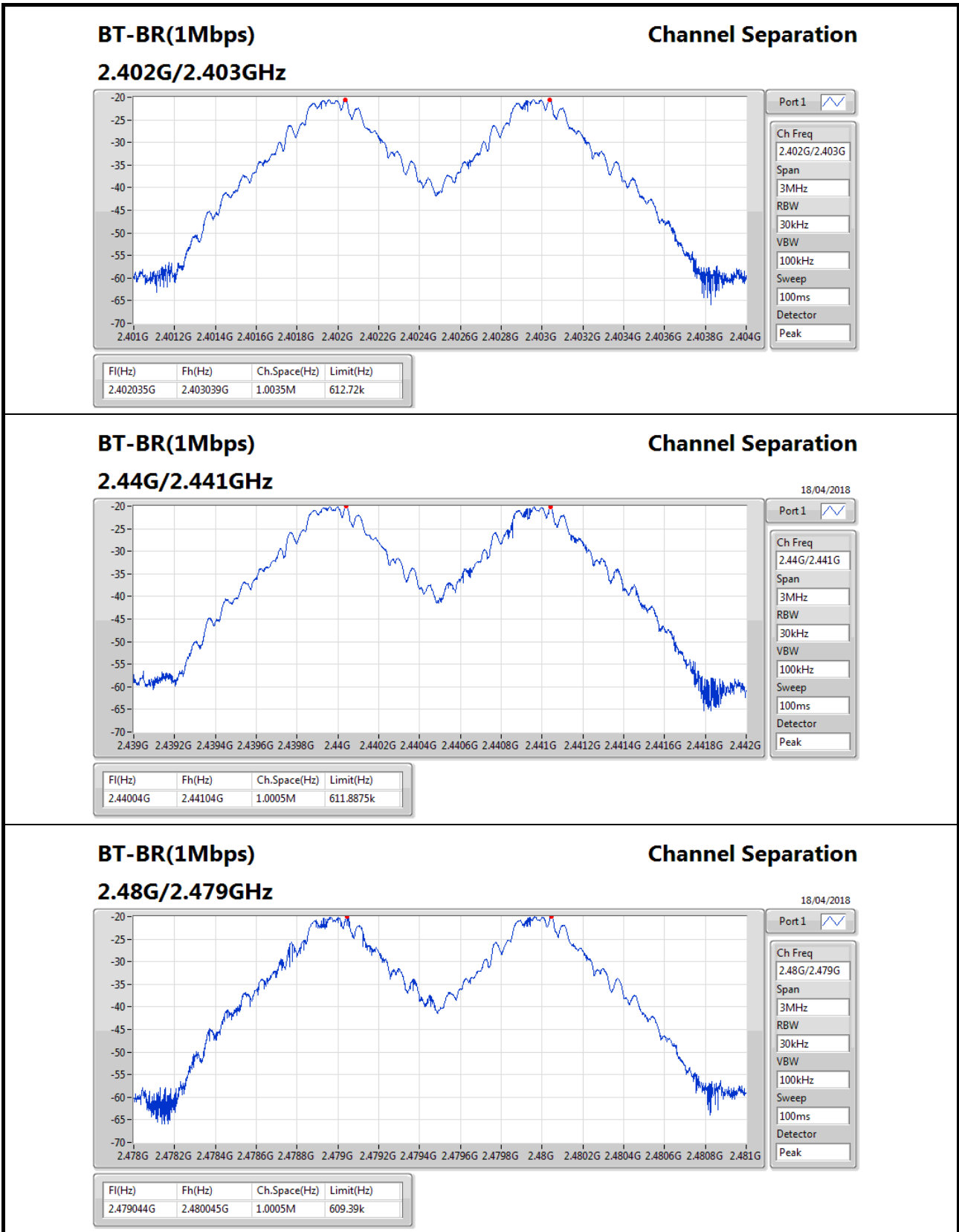

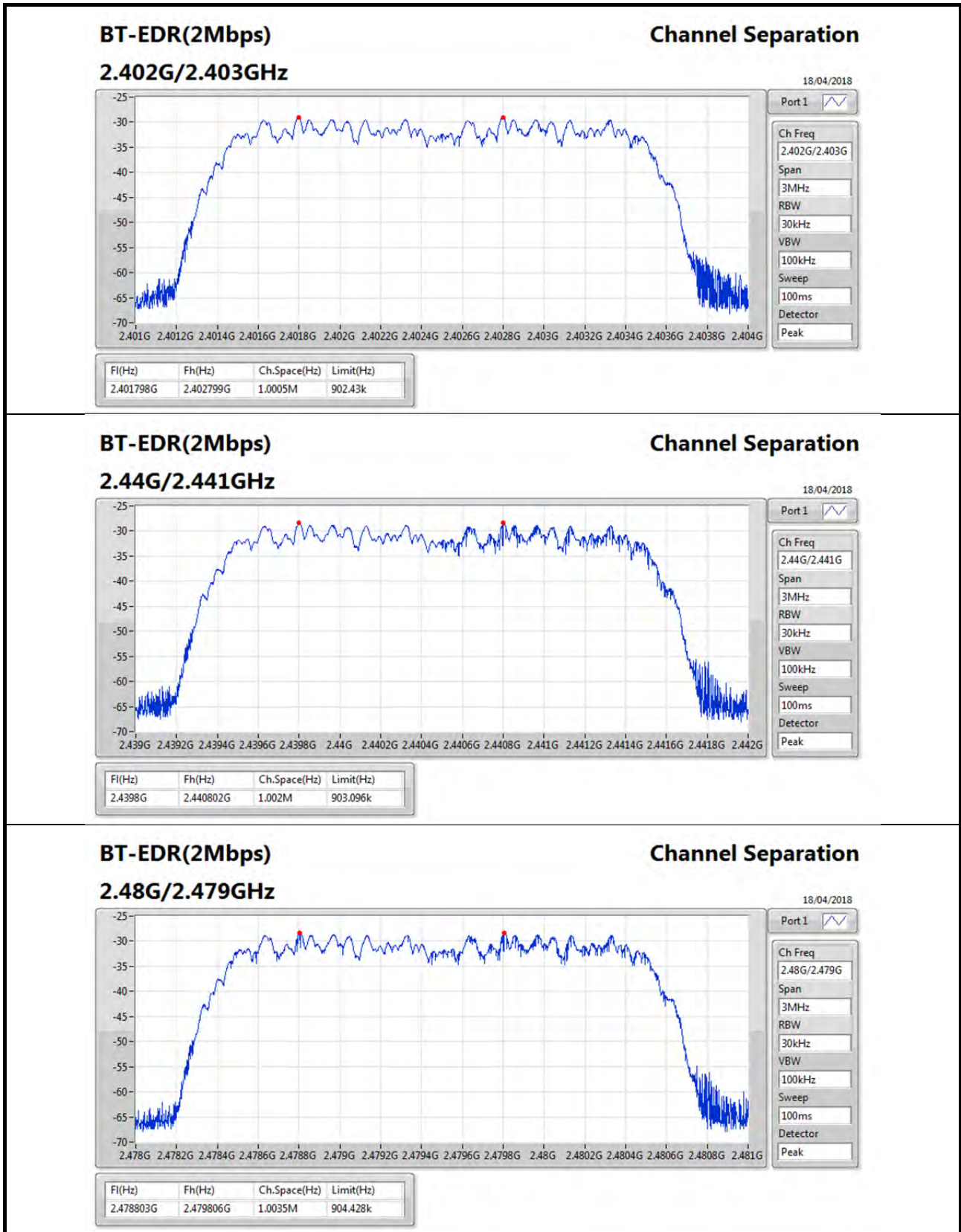

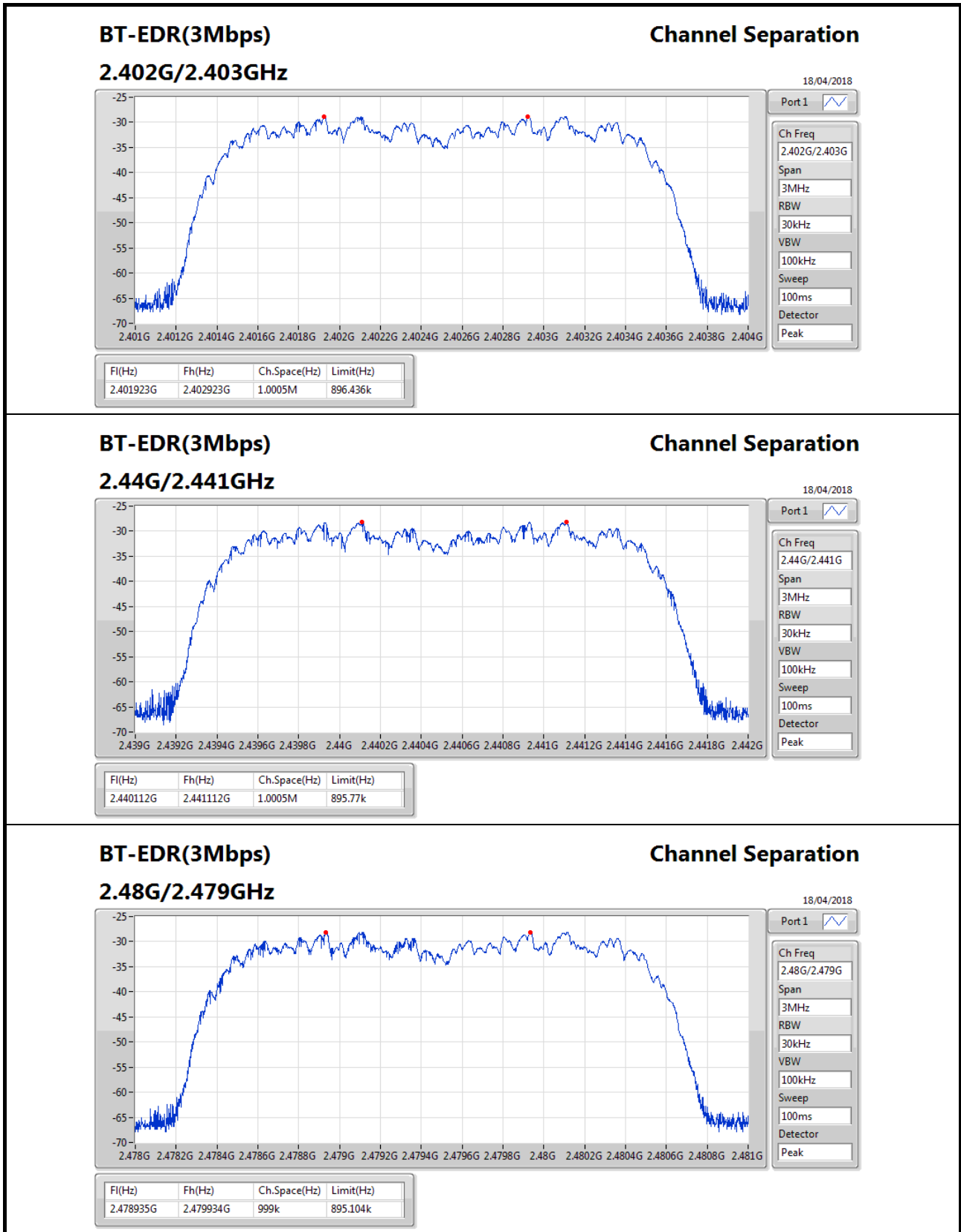



Summary

Mode	Power (dBm)	Power (W)
2.4-2.4835GHz	-	-
BT-BR(1Mbps)	8.13	0.00650
BT-EDR(2Mbps)	3.61	0.00230
BT-EDR(3Mbps)	3.71	0.00235

Result

Mode	Result	Gain (dBi)	Power (dBm)	Power Limit (dBm)
BT-BR(1Mbps)	-	-	-	-
2402MHz	Pass	2.92	7.82	21.00
2440MHz	Pass	2.92	8.13	21.00
2480MHz	Pass	2.92	8.08	21.00
BT-EDR(2Mbps)	-	-	-	-
2402MHz	Pass	2.92	3.34	21.00
2440MHz	Pass	2.92	3.59	21.00
2480MHz	Pass	2.92	3.61	21.00
BT-EDR(3Mbps)	-	-	-	-
2402MHz	Pass	2.92	3.33	21.00
2440MHz	Pass	2.92	3.71	21.00
2480MHz	Pass	2.92	3.12	21.00



Summary

Mode	Power (dBm)	Power (W)
2.4-2.4835GHz	-	-
BT-BR(1Mbps)	8.26	0.00670
BT-EDR(2Mbps)	5.68	0.00370
BT-EDR(3Mbps)	6.29	0.00426

Result

Mode	Result	Gain (dBi)	Power (dBm)	Power Limit (dBm)
BT-BR(1Mbps)	-	-	-	-
2402MHz	Pass	2.92	8.07	21.00
2440MHz	Pass	2.92	8.26	21.00
2480MHz	Pass	2.92	8.17	21.00
BT-EDR(2Mbps)	-	-	-	-
2402MHz	Pass	2.92	5.20	21.00
2440MHz	Pass	2.92	5.68	21.00
2480MHz	Pass	2.92	5.68	21.00
BT-EDR(3Mbps)	-	-	-	-
2402MHz	Pass	2.92	5.71	21.00
2440MHz	Pass	2.92	6.23	21.00
2480MHz	Pass	2.92	6.29	21.00

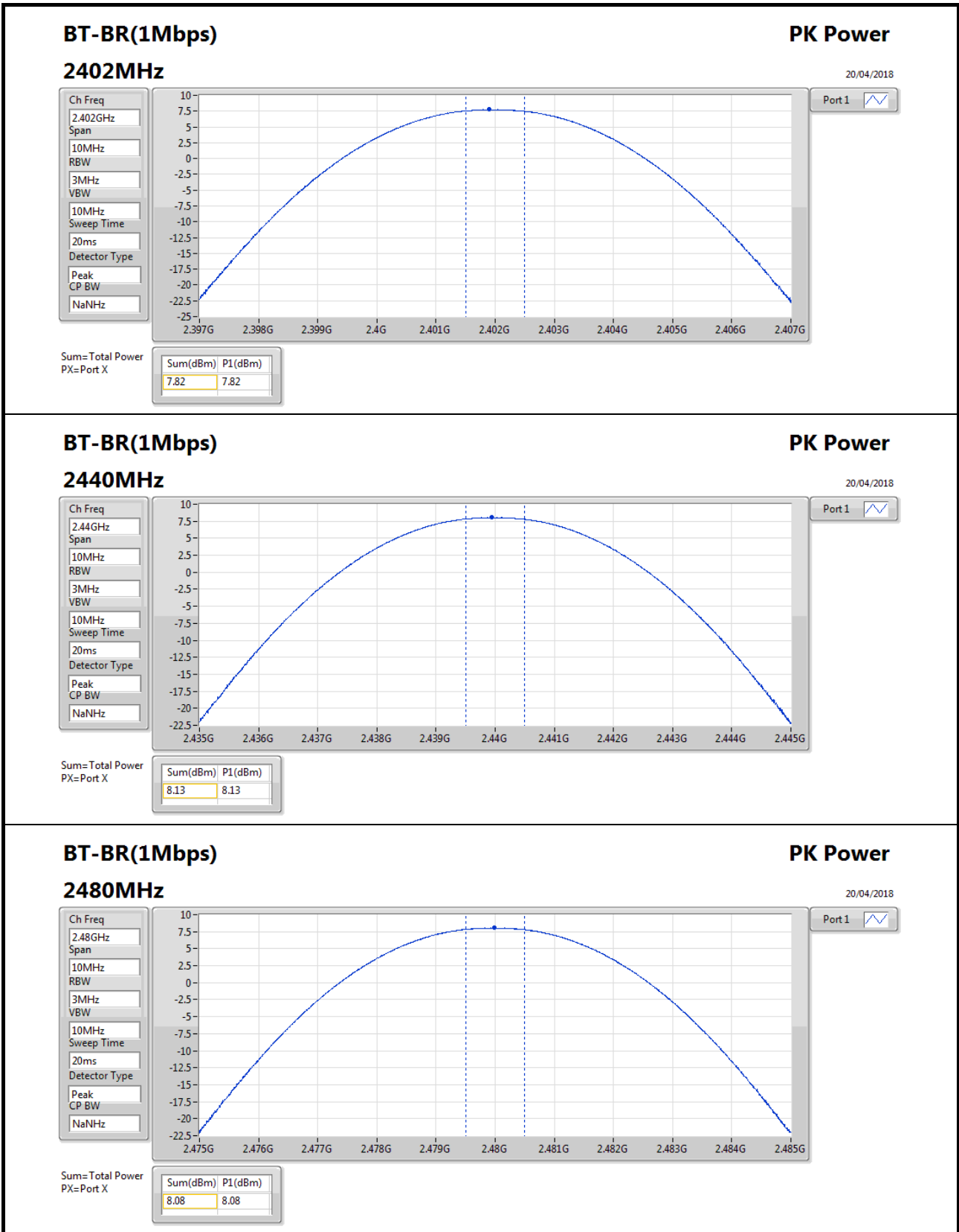

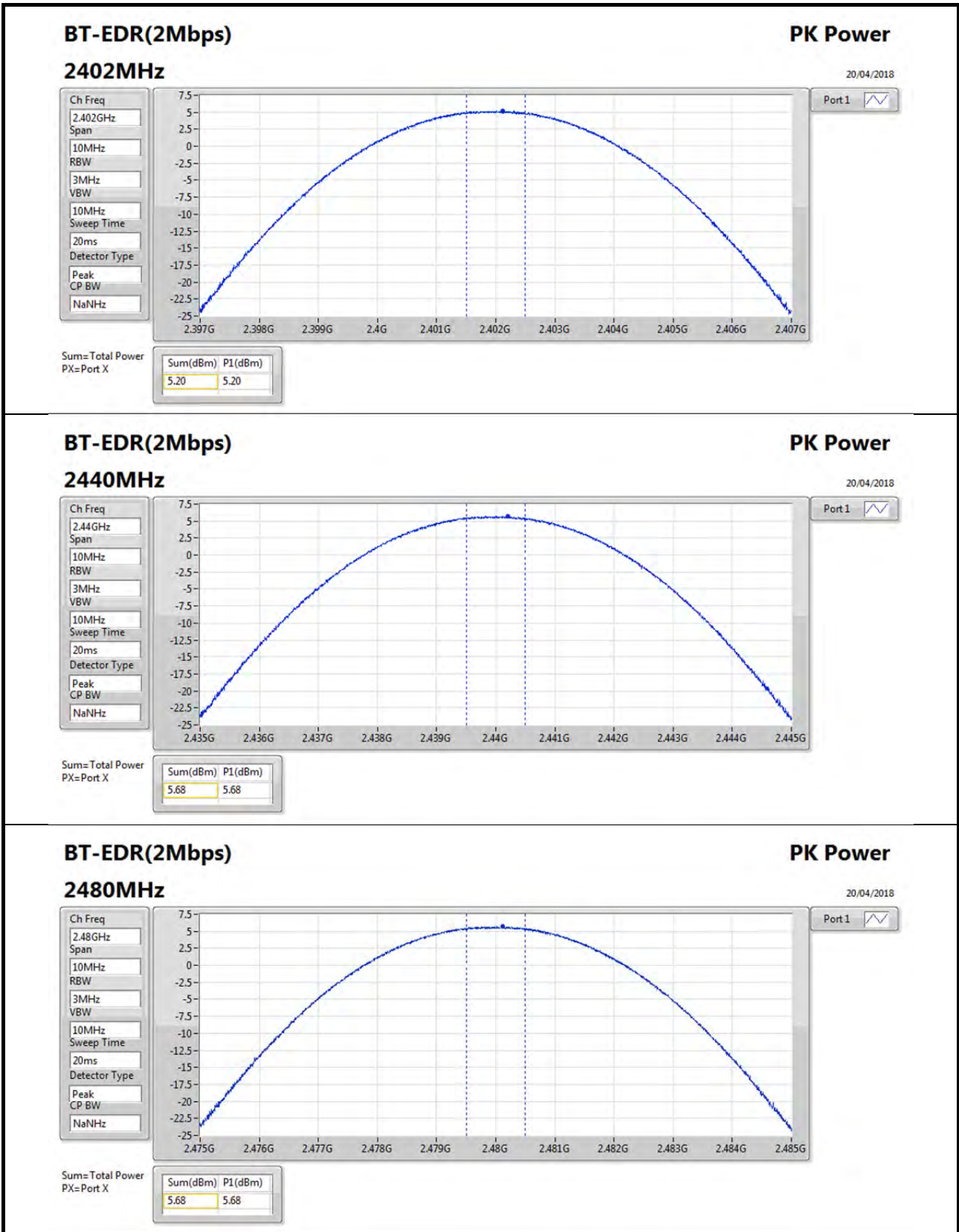

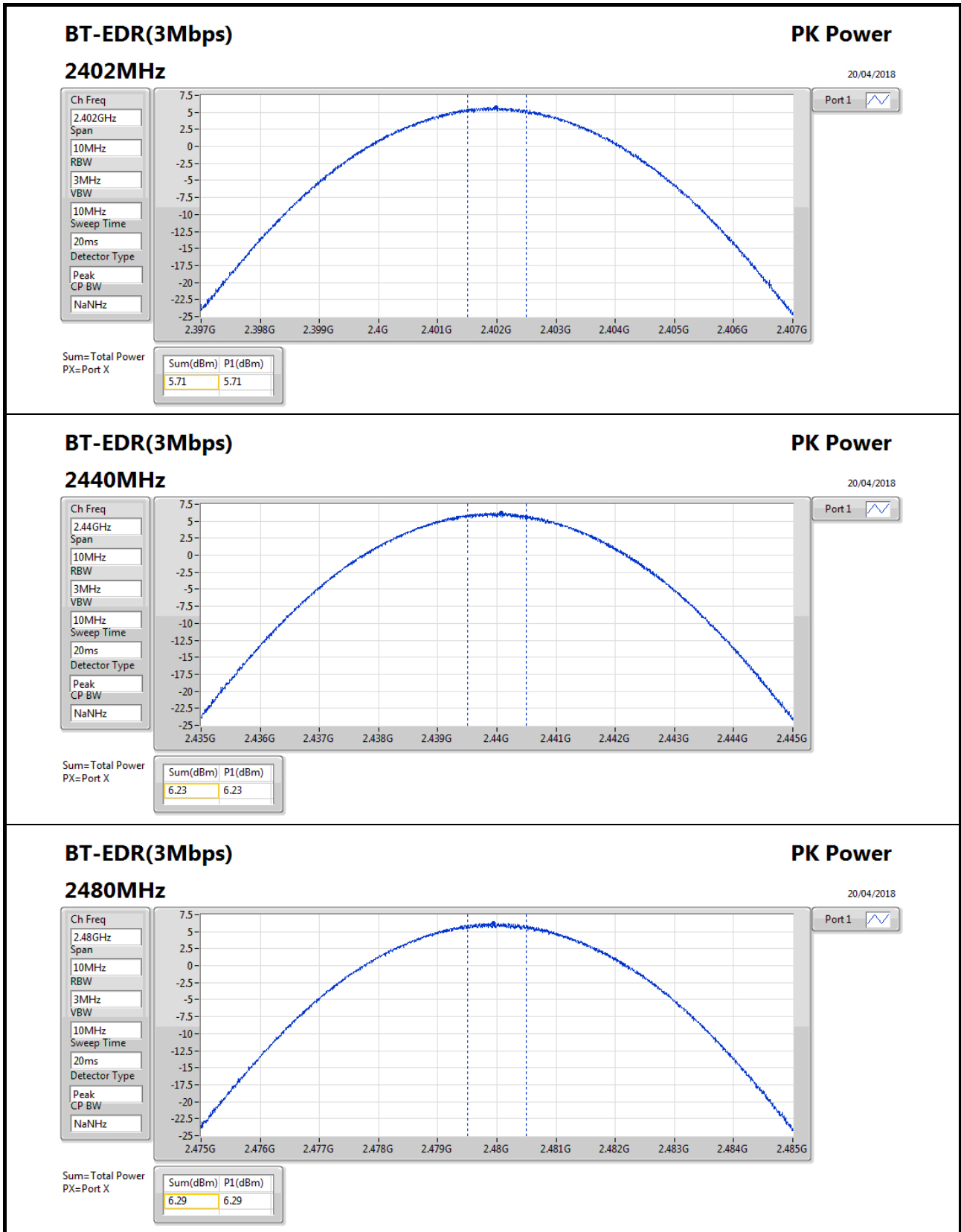



Summary

Mode	Max-Hop No
2.4-2.4835GHz	-
BT-BR(1Mbps)	79
BT-EDR(2Mbps)	79
BT-EDR(3Mbps)	79

Result

Mode	Result	Hopping No	Limit
BT-BR(1Mbps)	-	-	-
2440MHz	Pass	79	15
BT-EDR(2Mbps)	-	-	-
2440MHz	Pass	79	15
BT-EDR(3Mbps)	-	-	-
2440MHz	Pass	79	15

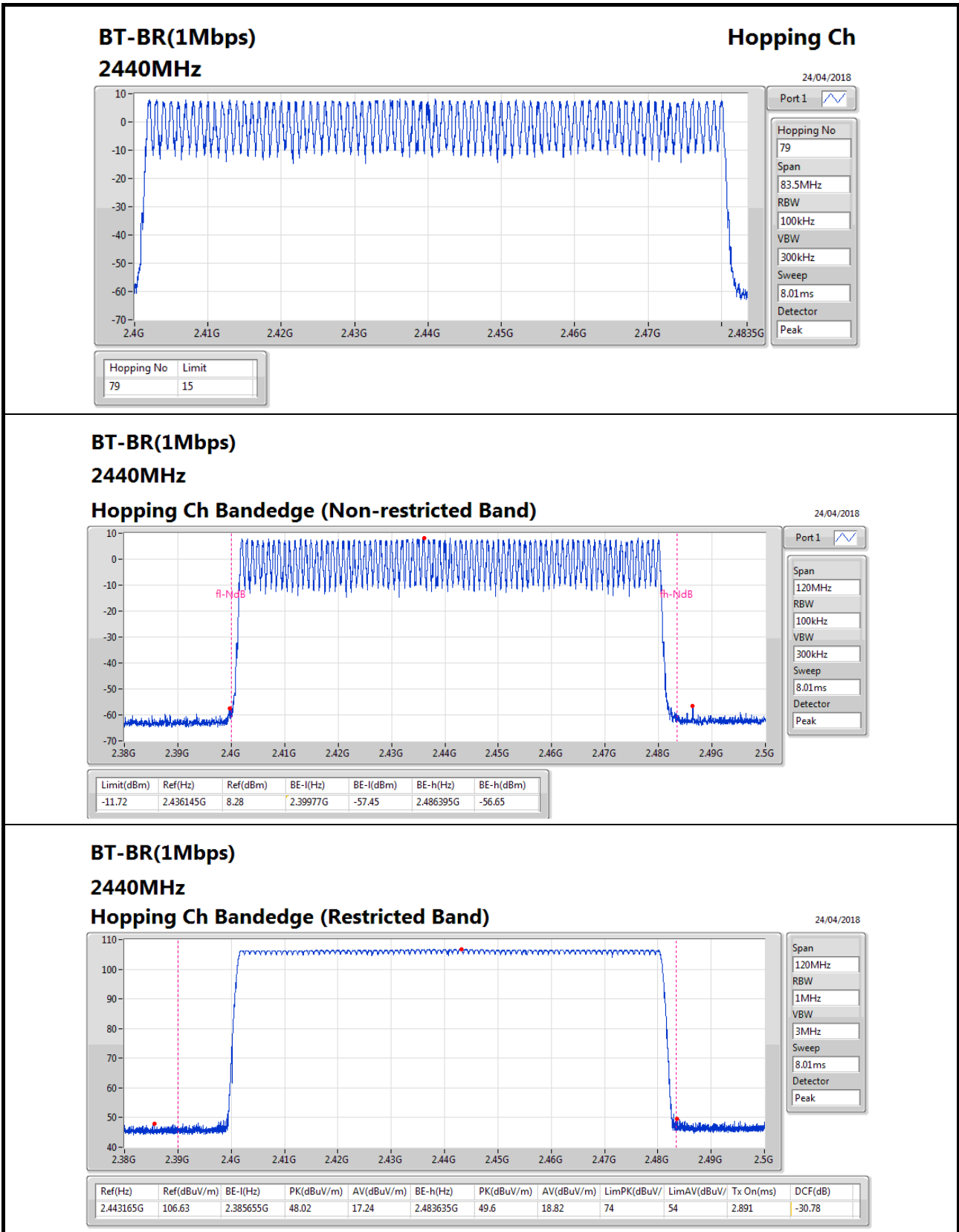

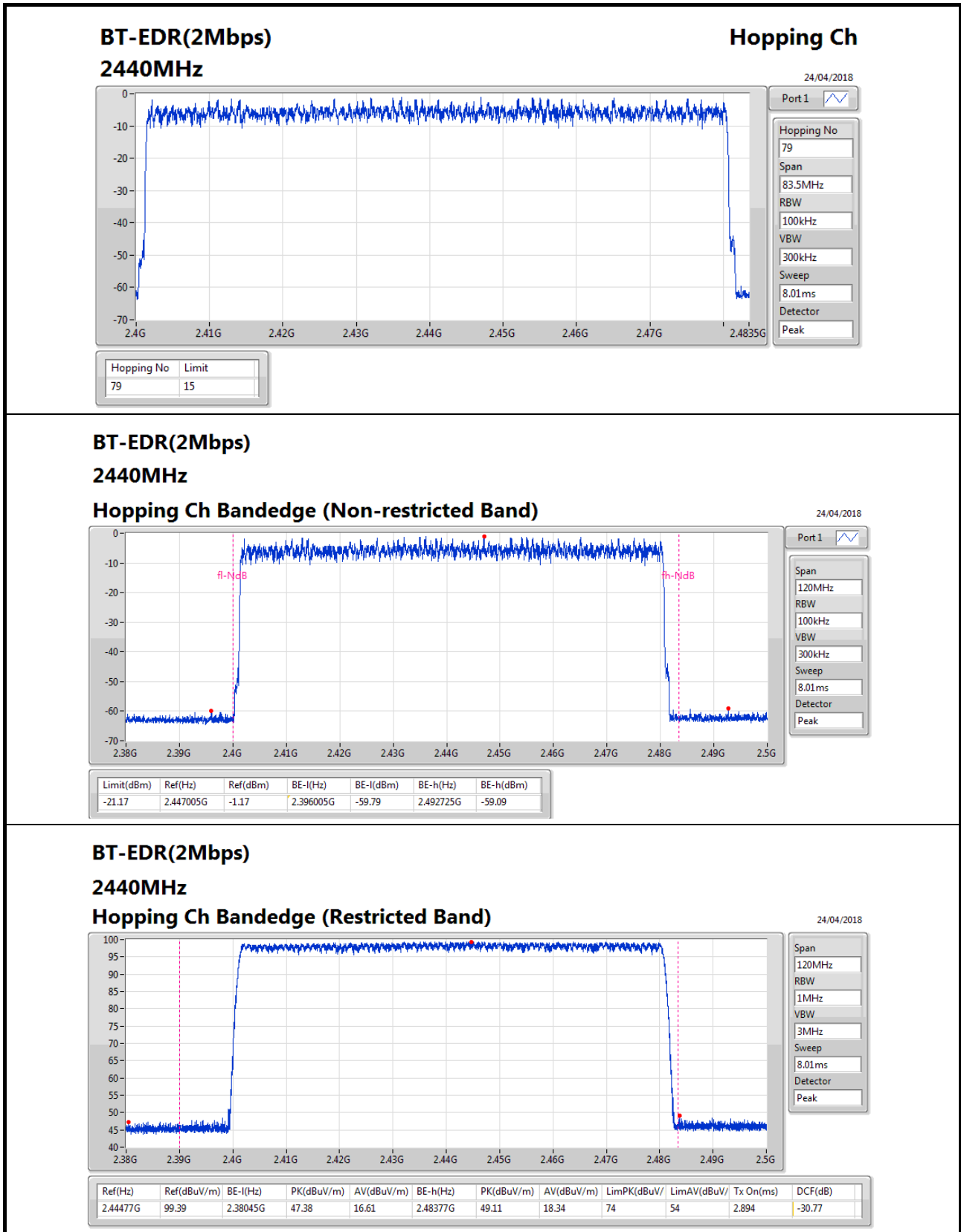

BT-EDR(2Mbps)

2440MHz

Hopping Ch Bandedge (Restricted Band)

24/04/2018

Span: 120MHz

RBW: 1MHz

VBW: 3MHz

Sweep: 8.01ms

Detector: Peak

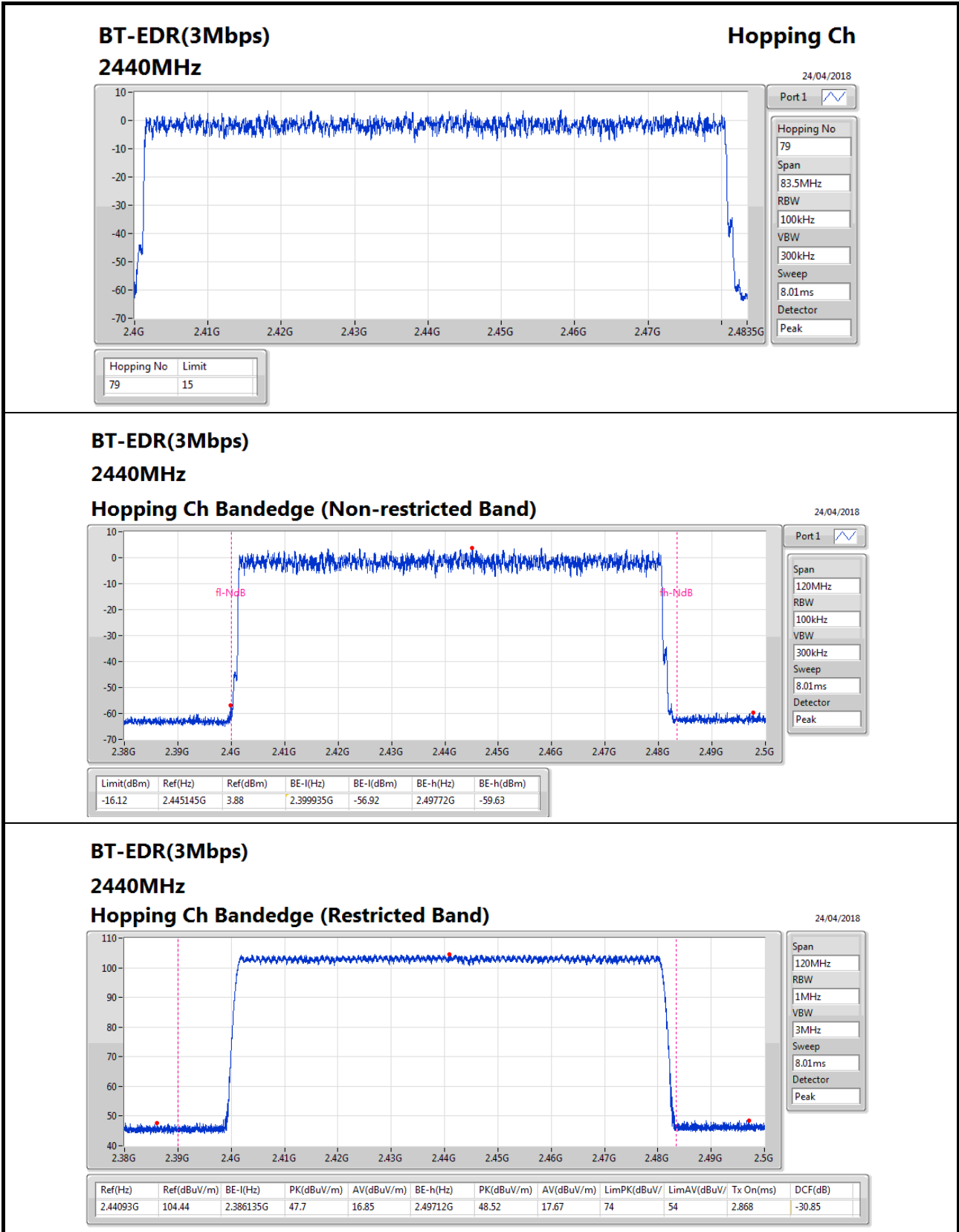



Summary

Mode	Max-Dwell (s)
2.4-2.4835GHz	-
BT-BR(1Mbps)	308.1806m
BT-EDR(2Mbps)	290.5916m
BT-EDR(3Mbps)	286.1144m

Result

Mode	Result	Period (s)	Dwell (s)	Limit (s)	Tx On (s)
BT-BR(1Mbps)	-	-	-	-	-
2440MHz	Pass	31.6	308.1806m	400m	2.891m
BT-EDR(2Mbps)	-	-	-	-	-
2440MHz	Pass	31.6	290.5916m	400m	2.726m
BT-EDR(3Mbps)	-	-	-	-	-
2440MHz	Pass	31.6	286.1144m	400m	2.684m

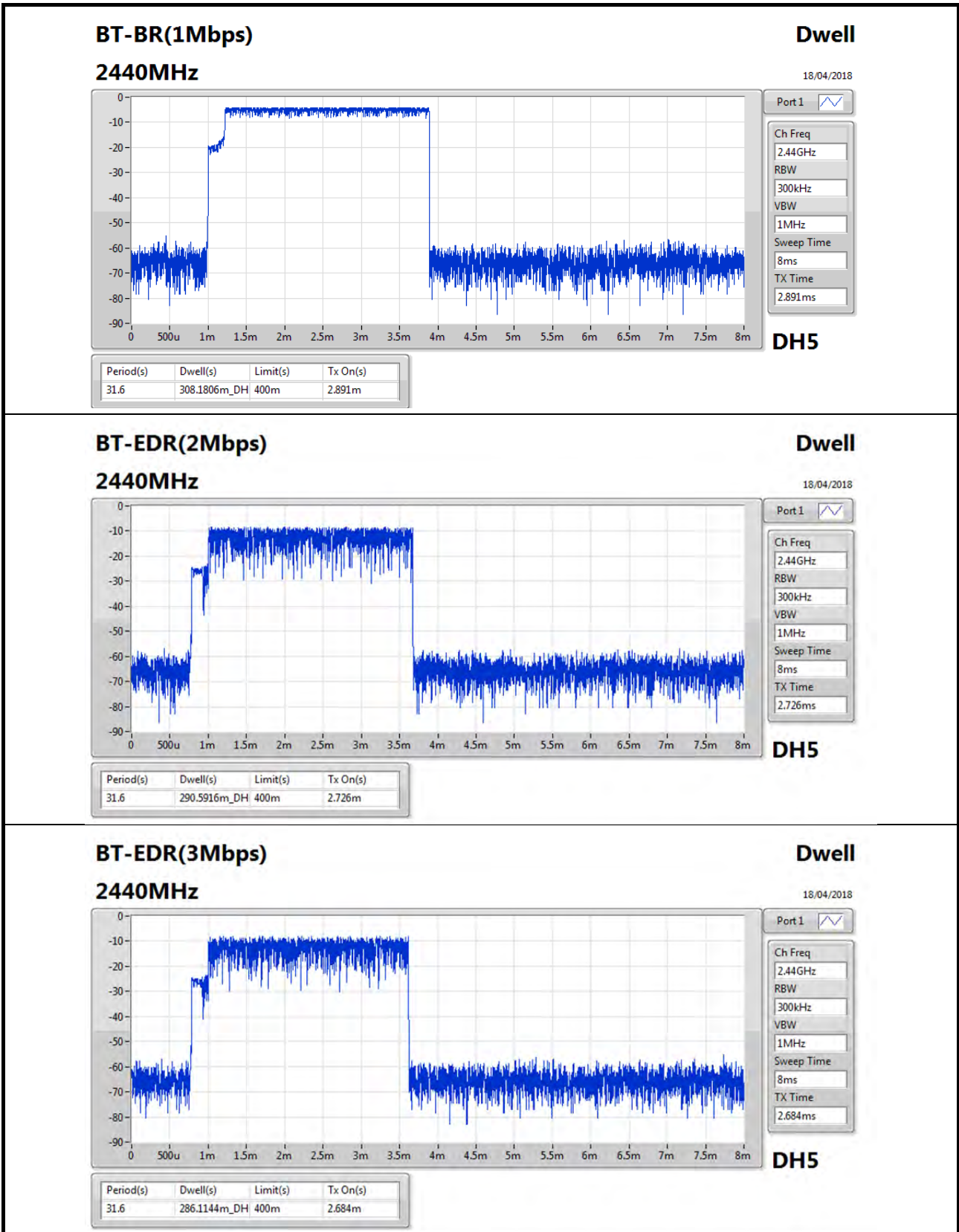



Summary

Mode	Result	Ref (Hz)	Ref (dBm)	Limit (dBm)	Freq (Hz)	Level (dBm)	Freq (Hz)	Level (dBm)	Freq (Hz)	Level (dBm)	Freq (Hz)	Level (dBm)	Port
2.4-2.4835GHz	-	-	-	-	-	-	-	-	-	-	-	-	-
BT-BR(1Mbps)	Pass	2.401837G	6.69	-13.31	845.776M	-59.82	2.399968G	-54.1	2.48372G	-58.14	6.889899G	-52.76	1
BT-EDR(2Mbps)	Pass	2.439746G	0.67	-19.33	2.302096G	-59.4	2.399684G	-59	2.4841G	-58.46	6.777327G	-52.5	1
BT-EDR(3Mbps)	Pass	2.479993G	0.6	-19.4	2.171856G	-59.29	2.399064G	-58.75	2.483708G	-58.26	6.749183G	-52.96	1

Result

Mode	Result	Ref (Hz)	Ref (dBm)	Limit (dBm)	Freq (Hz)	Level (dBm)	Freq (Hz)	Level (dBm)	Freq (Hz)	Level (dBm)	Freq (Hz)	Level (dBm)	Port
BT-BR(1Mbps)	-	-	-	-	-	-	-	-	-	-	-	-	-
2402MHz	Pass	2.401837G	6.69	-13.31	845.776M	-59.82	2.399968G	-54.1	2.48372G	-58.14	6.889899G	-52.76	1
2440MHz	Pass	2.439913G	6.95	-13.05	1.923216G	-59.6	2.398164G	-59.51	2.48422G	-58.53	6.991214G	-53.29	1
2480MHz	Pass	2.479993G	7.15	-12.85	1.716016G	-59.72	2.39964G	-58.4	2.484564G	-56.04	6.996843G	-52.34	1
BT-EDR(2Mbps)	-	-	-	-	-	-	-	-	-	-	-	-	-
2402MHz	Pass	2.401837G	1.58	-18.42	1.659184G	-59.73	2.399668G	-55.77	2.484556G	-58.21	6.994029G	-52.76	1
2440MHz	Pass	2.439746G	0.67	-19.33	2.302096G	-59.4	2.399684G	-59	2.4841G	-58.46	6.777327G	-52.5	1
2480MHz	Pass	2.479993G	0.69	-19.31	1.747984G	-59.47	2.398708G	-58.28	2.483828G	-57.81	6.991214G	-53.36	1
BT-EDR(3Mbps)	-	-	-	-	-	-	-	-	-	-	-	-	-
2402MHz	Pass	2.402004G	0.8	-19.2	875.376M	-59.29	2.399604G	-55.85	2.485424G	-59.04	6.881456G	-53.65	1
2440MHz	Pass	2.44008G	1.27	-18.73	1.904272G	-59.83	2.39968G	-59.83	2.484984G	-58.61	6.842056G	-52.87	1
2480MHz	Pass	2.479993G	0.6	-19.4	2.171856G	-59.29	2.399064G	-58.75	2.483708G	-58.26	6.749183G	-52.96	1

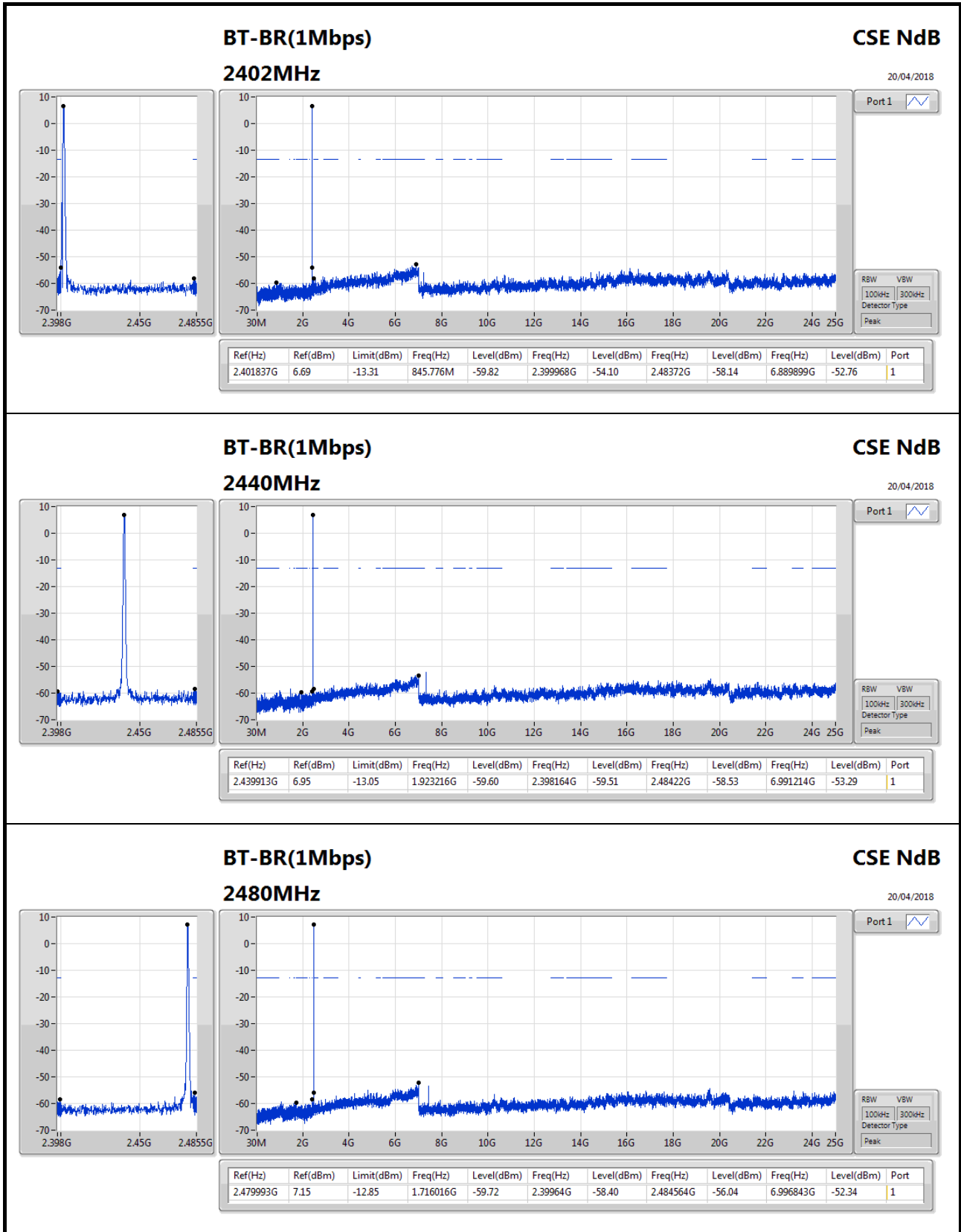

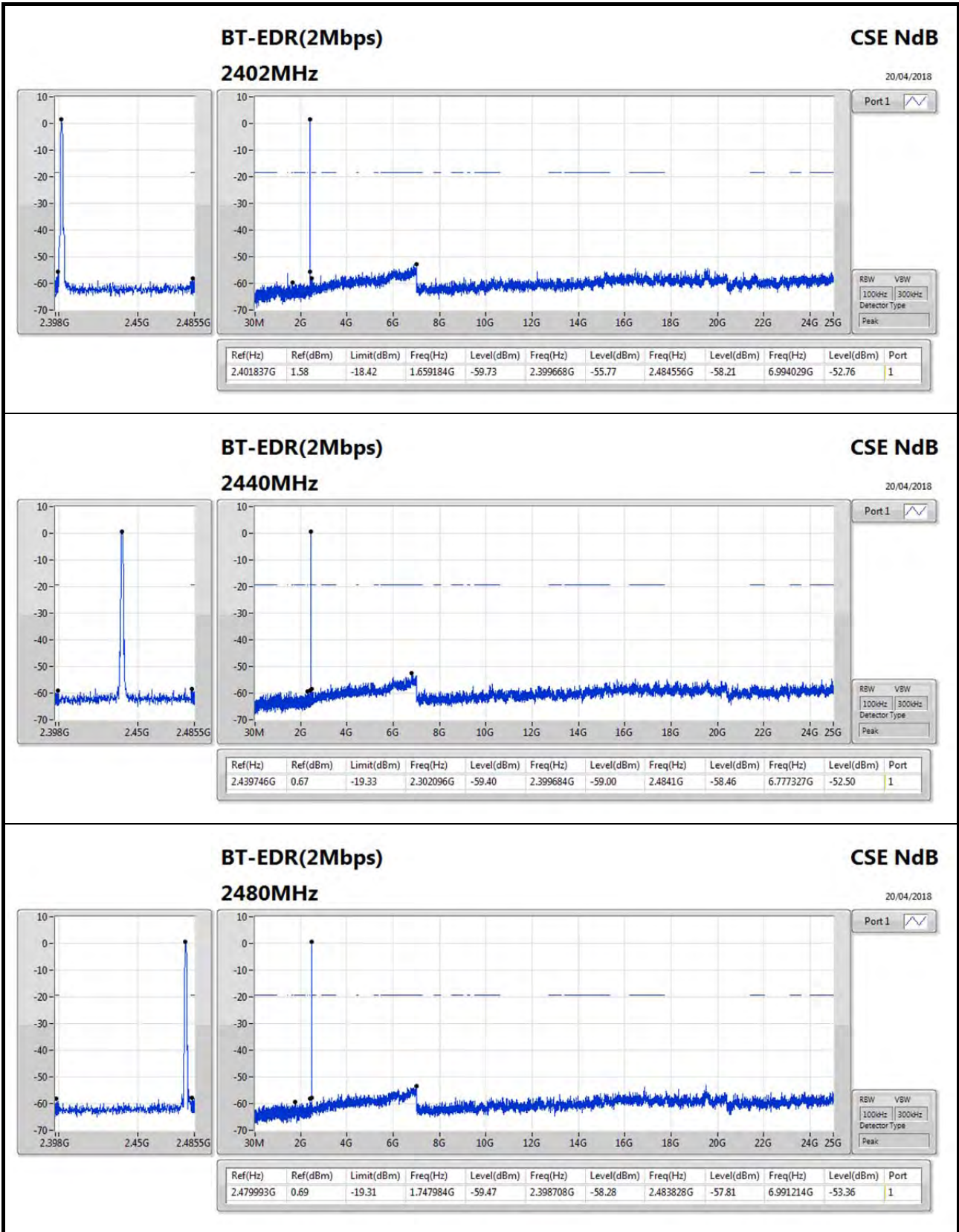

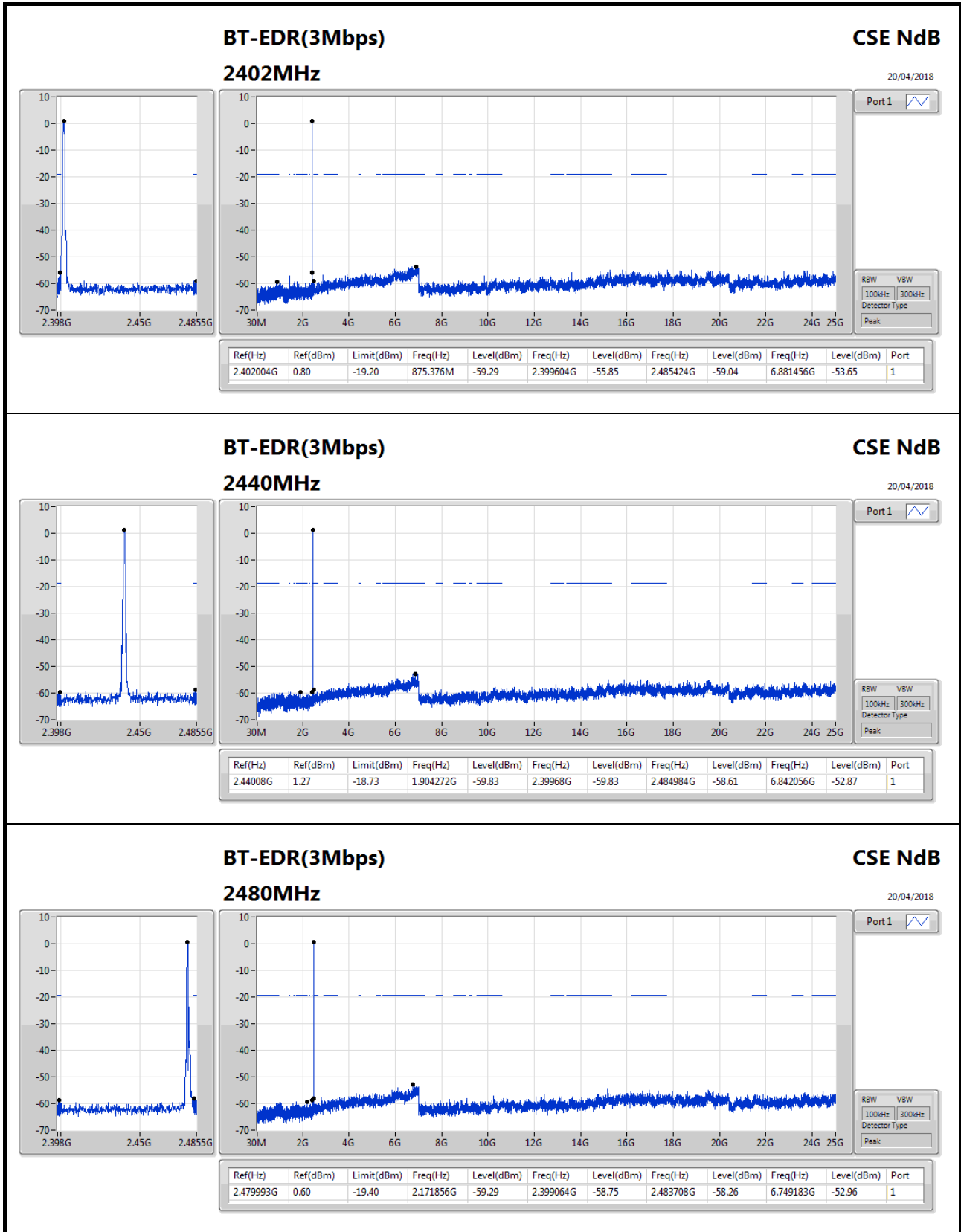



RSE below 1GHz Result

Appendix G.1

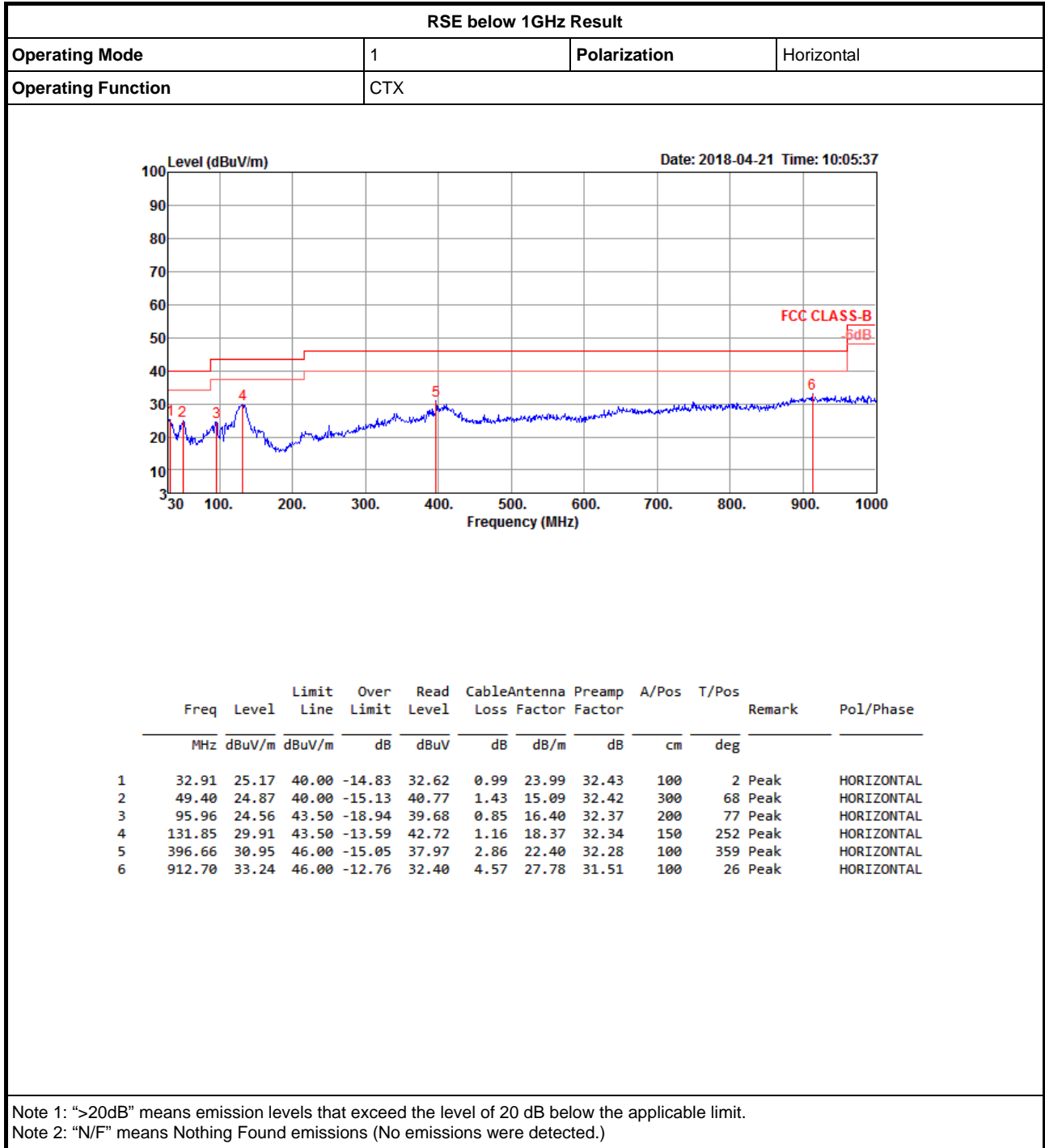



RSE below 1GHz Result

Appendix G.1

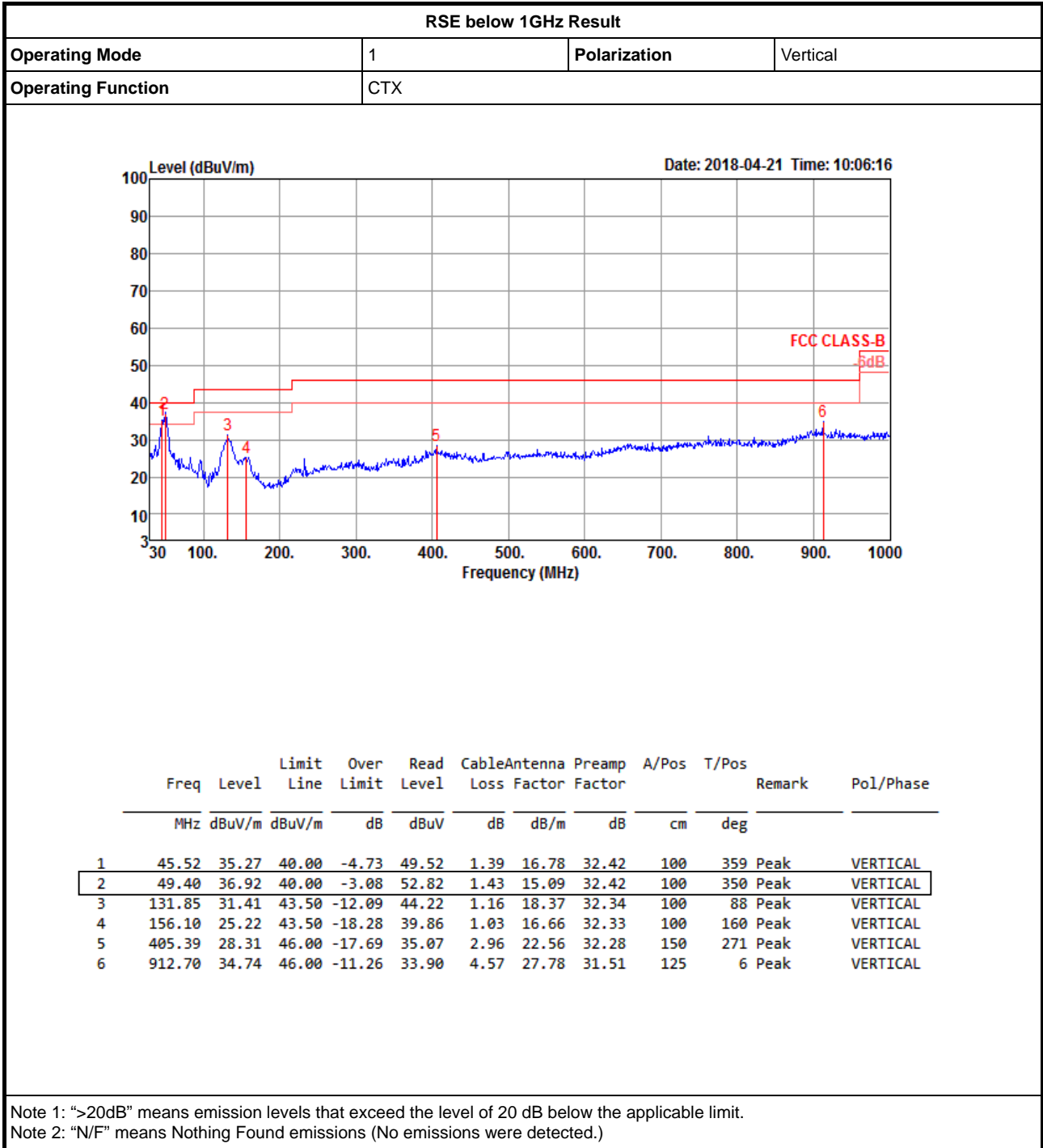



Summary





Mode	Result	Type	Freq (Hz)	Level (dBuV/m)	Limit (dBuV/m)	Margin (dB)	Factor (dB)	Dist (m)	Condition	Azimuth (°)	Height (m)	Comments
2.4-2.4835GHz	-	-	-	-	-	-	-	-	-	-	-	-
BT-BR(1Mbps)	Pass	AV	2.483502G	47.84	54.00	-6.16	32.42	3	Vertical	90	2.91	-

BT-BR(1Mbps)

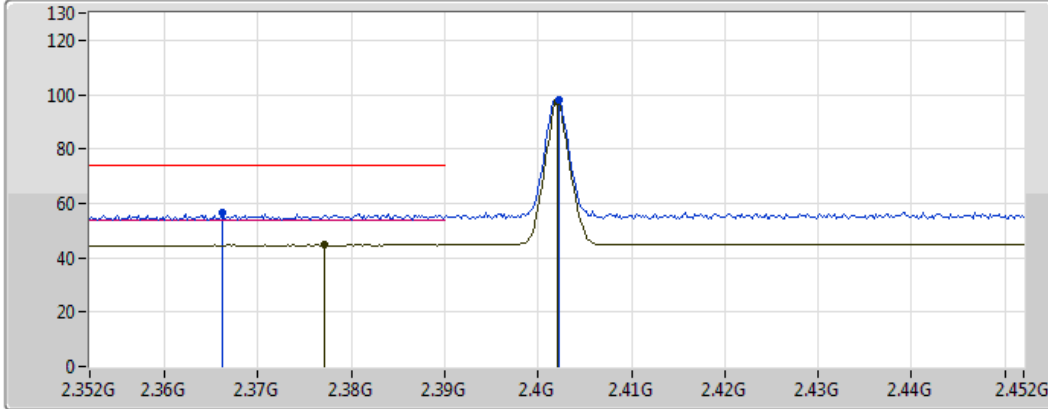
2402MHz_TX

18/04/2018



- Lim.PK 
- PK 
- Lim.AV 
- AV 

EUT Y_1TX
 Setting 8
 06-G-2
 FSP(100080)

Type	Freq (Hz)	Level (dBuV/m)	Limit (dBuV/m)	Margin (dB)	Factor (dB)	Dist (m)	Condition	Azimuth (°)	Height (m)	Comments
PK	2.3662G	56.53	74.00	-17.47	32.05	3	Vertical	109	2.53	-
AV	2.3772G	44.83	54.00	-9.17	32.07	3	Vertical	109	2.53	-
PK	2.4022G	98.22	Inf	-Inf	32.16	3	Vertical	109	2.53	-
AV	2.402G	97.33	Inf	-Inf	32.16	3	Vertical	109	2.53	-

BT-BR(1Mbps)

2402MHz_TX

18/04/2018

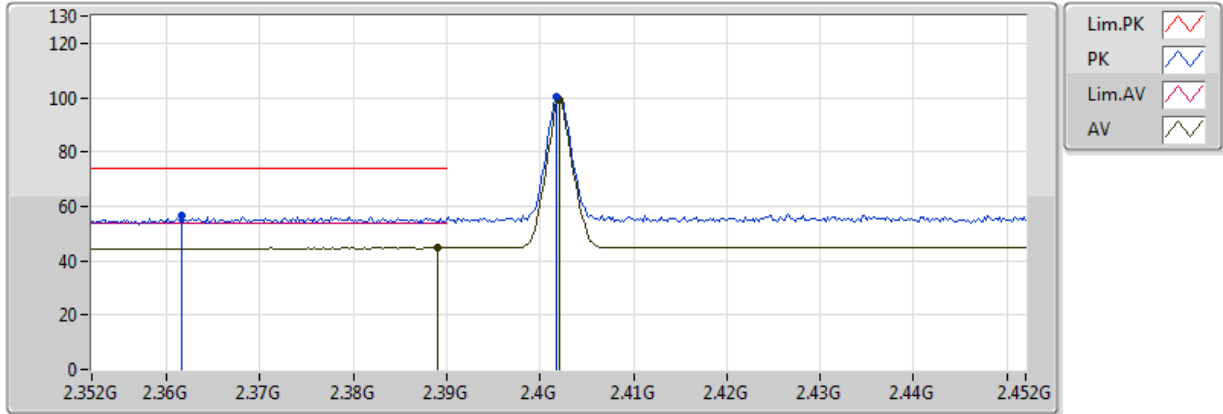

EUT Y_1TX
Setting 8
06-G-2
FSP(100080)

Type	Freq (Hz)	Level (dBuV/m)	Limit (dBuV/m)	Margin (dB)	Factor (dB)	Dist (m)	Condition	Azimuth (°)	Height (m)	Comments
PK	2.3616G	56.78	74.00	-17.22	32.02	3	Horizontal	339	2.39	-
AV	2.389G	44.74	54.00	-9.26	32.11	3	Horizontal	339	2.39	-
PK	2.4018G	100.34	Inf	-Inf	32.16	3	Horizontal	339	2.39	-
AV	2.402G	99.45	Inf	-Inf	32.16	3	Horizontal	339	2.39	-

BT-BR(1Mbps)

2402MHz_TX

18/04/2018

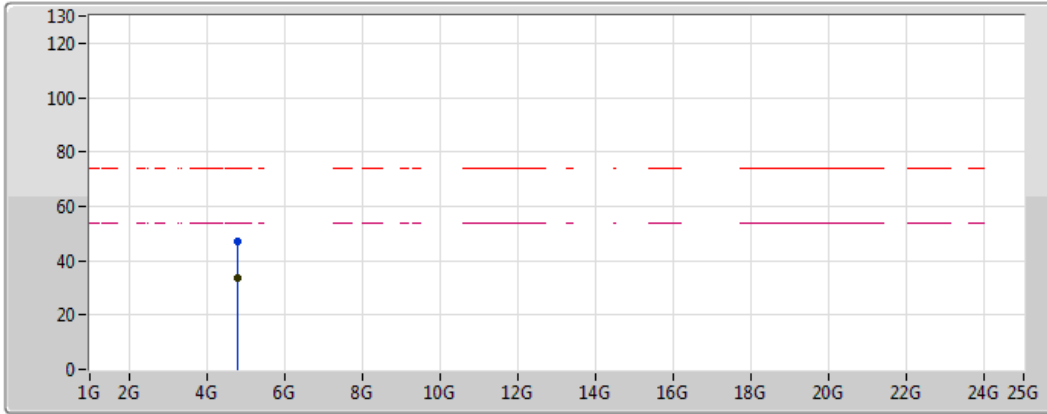

Legend:

- Lim.PK (Red dashed line)
- PK (Blue line with dot)
- Lim.AV (Magenta dashed line)
- AV (Black line with dot)

EUT Y_1TX
Setting 8
06-G-2
FSP(100080)

Type	Freq (Hz)	Level (dBuV/m)	Limit (dBuV/m)	Margin (dB)	Factor (dB)	Dist (m)	Condition	Azimuth (°)	Height (m)	Comments
PK	4.80314G	46.90	74.00	-27.10	6.64	3	Vertical	6	1.50	-
AV	4.804332G	33.57	54.00	-20.43	6.64	3	Vertical	6	1.50	-

BT-BR(1Mbps)

2402MHz_TX

18/04/2018

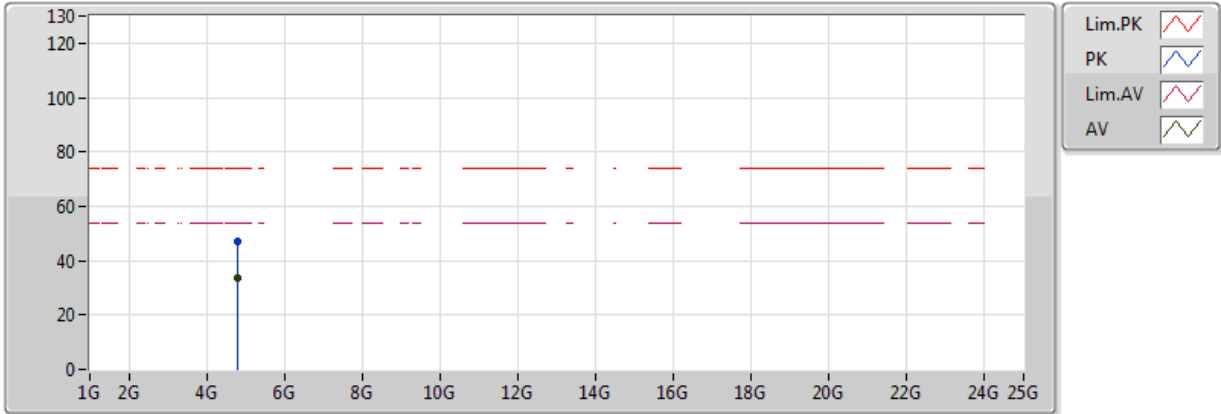

EUT Y_1TX
Setting 8
06-G-2
FSP(100080)

Type	Freq (Hz)	Level (dBuV/m)	Limit (dBuV/m)	Margin (dB)	Factor (dB)	Dist (m)	Condition	Azimuth (°)	Height (m)	Comments
PK	4.80219G	47.18	74.00	-26.82	6.64	3	Horizontal	335	1.40	-
AV	4.80422G	33.59	54.00	-20.41	6.64	3	Horizontal	335	1.40	-

BT-BR(1Mbps)

2440MHz_TX

18/04/2018

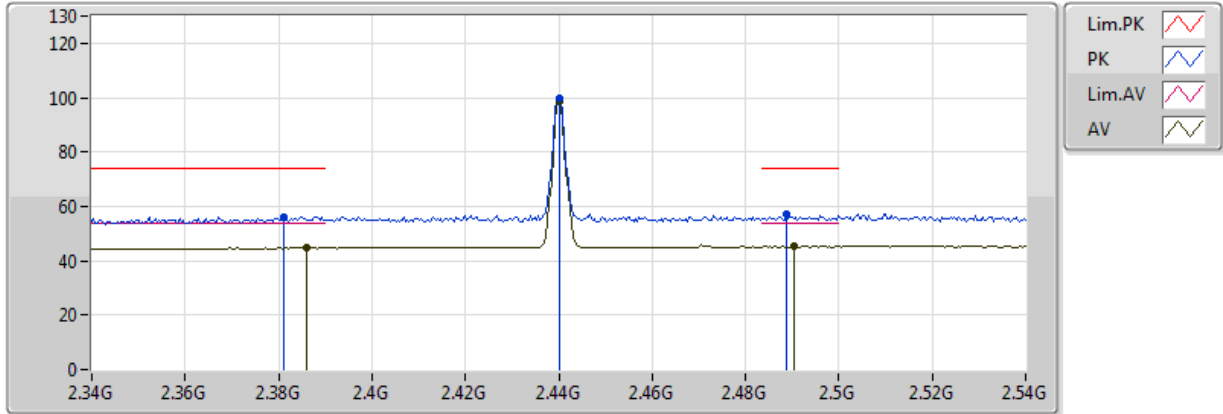

EUT Y_1TX
Setting 8
06-G-2
FSP(100080)

Type	Freq (Hz)	Level (dBuV/m)	Limit (dBuV/m)	Margin (dB)	Factor (dB)	Dist (m)	Condition	Azimuth (°)	Height (m)	Comments
PK	2.3812G	56.19	74.00	-17.81	32.09	3	Vertical	90	2.71	-
AV	2.386G	44.84	54.00	-9.16	32.10	3	Vertical	90	2.71	-
PK	2.44G	99.59	Inf	-Inf	32.28	3	Vertical	90	2.71	-
AV	2.44G	98.71	Inf	-Inf	32.28	3	Vertical	90	2.71	-
PK	2.4888G	57.17	74.00	-16.83	32.44	3	Vertical	90	2.71	-
AV	2.4904G	45.32	54.00	-8.68	32.45	3	Vertical	90	2.71	-

BT-BR(1Mbps)

2440MHz_TX

18/04/2018

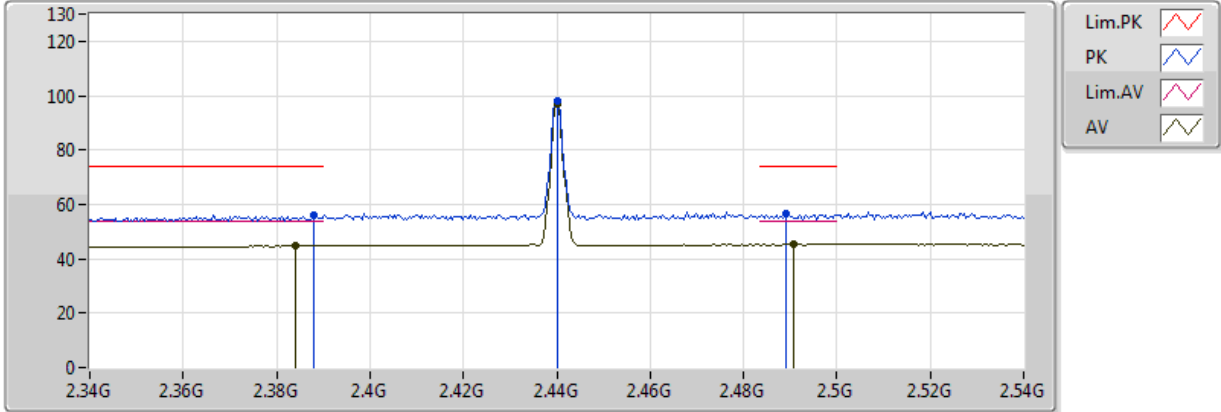

EUT Y_1TX
Setting 8
06-G-2
FSP(100080)

Type	Freq (Hz)	Level (dBuV/m)	Limit (dBuV/m)	Margin (dB)	Factor (dB)	Dist (m)	Condition	Azimuth (°)	Height (m)	Comments
PK	2.388G	56.13	74.00	-17.87	32.11	3	Horizontal	40	1.84	-
AV	2.384G	44.79	54.00	-9.21	32.10	3	Horizontal	40	1.84	-
PK	2.44G	98.08	Inf	-Inf	32.28	3	Horizontal	40	1.84	-
AV	2.44G	97.18	Inf	-Inf	32.28	3	Horizontal	40	1.84	-
PK	2.4892G	56.34	74.00	-17.66	32.44	3	Horizontal	40	1.84	-
AV	2.4908G	45.36	54.00	-8.64	32.45	3	Horizontal	40	1.84	-

BT-BR(1Mbps)

2440MHz_TX

18/04/2018

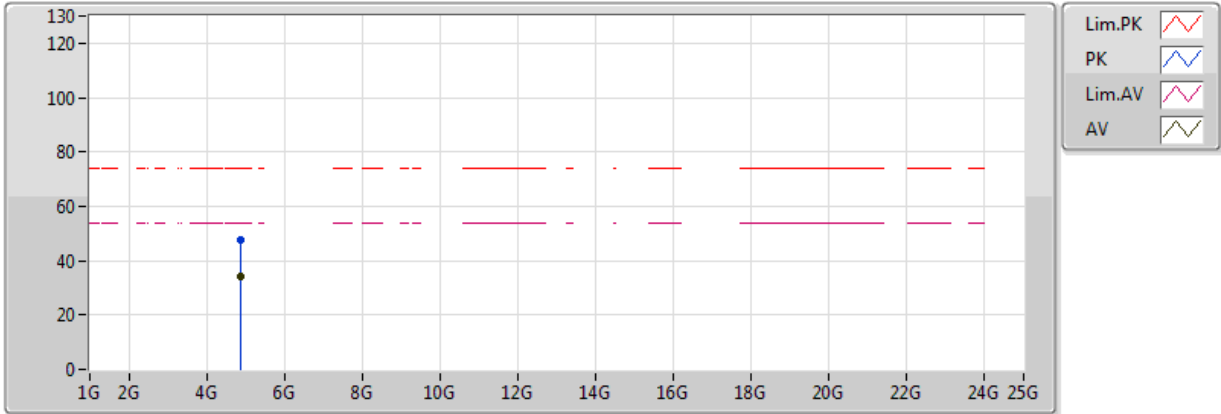

EUT Y_1TX
Setting 8
06-G-2
FSP(100080)

Type	Freq (Hz)	Level (dBuV/m)	Limit (dBuV/m)	Margin (dB)	Factor (dB)	Dist (m)	Condition	Azimuth (°)	Height (m)	Comments
PK	4.880236G	47.38	74.00	-26.62	6.85	3	Vertical	117	1.83	-
AV	4.879332G	33.99	54.00	-20.01	6.85	3	Vertical	117	1.83	-

BT-BR(1Mbps)

2440MHz_TX

18/04/2018

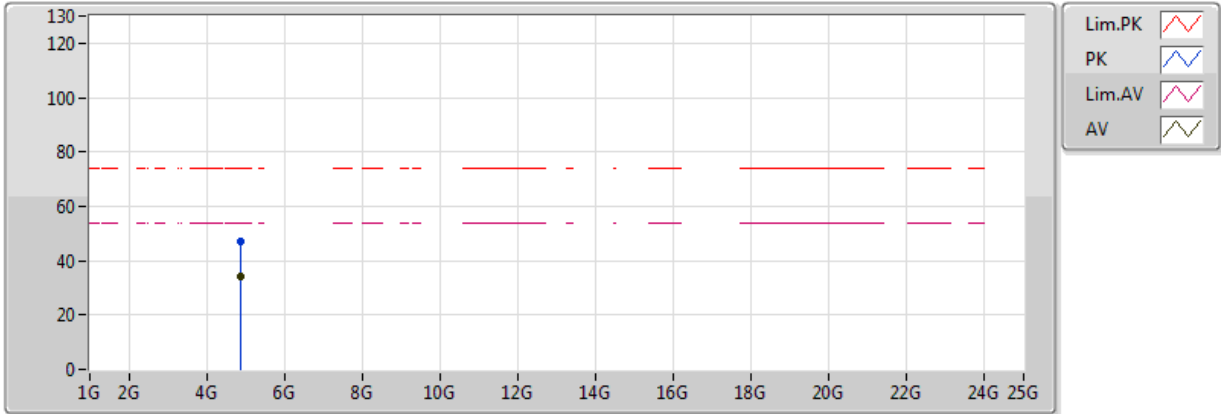

EUT Y_1TX
Setting 8
06-G-2
FSP(100080)

Type	Freq (Hz)	Level (dBuV/m)	Limit (dBuV/m)	Margin (dB)	Factor (dB)	Dist (m)	Condition	Azimuth (°)	Height (m)	Comments
PK	4.879804G	47.34	74.00	-26.66	6.85	3	Horizontal	251	1.26	-
AV	4.88026G	34.17	54.00	-19.83	6.85	3	Horizontal	251	1.26	-

BT-BR(1Mbps)

2480MHz_TX

18/04/2018

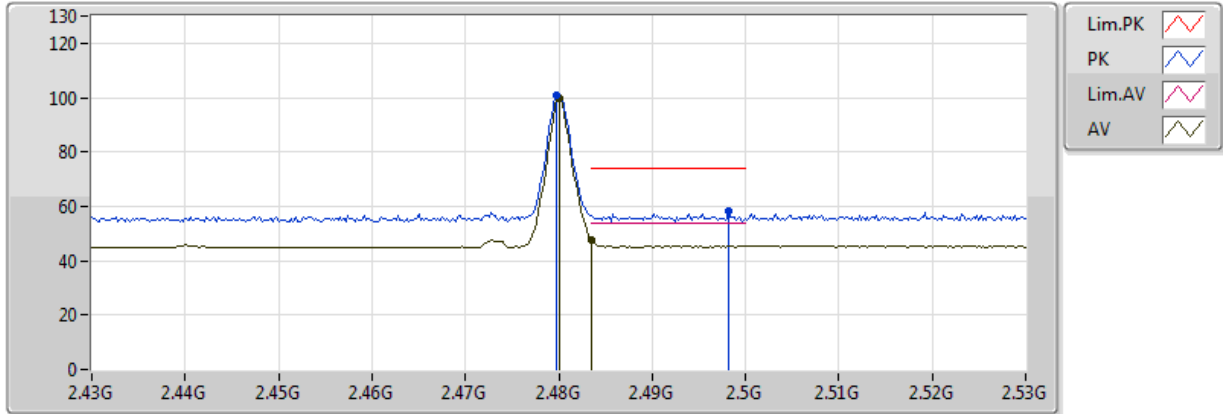

EUT Y_1TX
Setting 8
06-G-2
FSP(100080)

Type	Freq (Hz)	Level (dBuV/m)	Limit (dBuV/m)	Margin (dB)	Factor (dB)	Dist (m)	Condition	Azimuth (°)	Height (m)	Comments
PK	2.4798G	100.89	Inf	-Inf	32.41	3	Vertical	90	2.91	-
AV	2.48G	99.99	Inf	-Inf	32.41	3	Vertical	90	2.91	-
PK	2.4982G	58.10	74.00	-15.90	32.47	3	Vertical	90	2.91	-
AV	2.483502G	47.84	54.00	-6.16	32.42	3	Vertical	90	2.91	-

BT-BR(1Mbps)

2480MHz_TX

18/04/2018

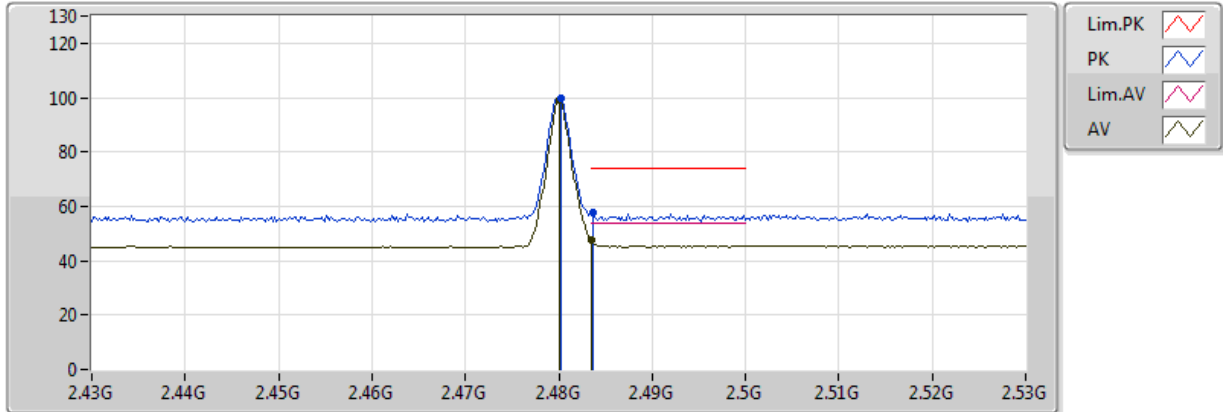

EUT Y_1TX
Setting 8
06-G-2
FSP(100080)

Type	Freq (Hz)	Level (dBuV/m)	Limit (dBuV/m)	Margin (dB)	Factor (dB)	Dist (m)	Condition	Azimuth (°)	Height (m)	Comments
PK	2.4802G	99.96	Inf	-Inf	32.41	3	Horizontal	8	2.01	-
AV	2.48G	99.05	Inf	-Inf	32.41	3	Horizontal	8	2.01	-
PK	2.4836G	57.88	74.00	-16.12	32.42	3	Horizontal	8	2.01	-
AV	2.483502G	47.41	54.00	-6.59	32.42	3	Horizontal	8	2.01	-

BT-BR(1Mbps)

2480MHz_TX

18/04/2018

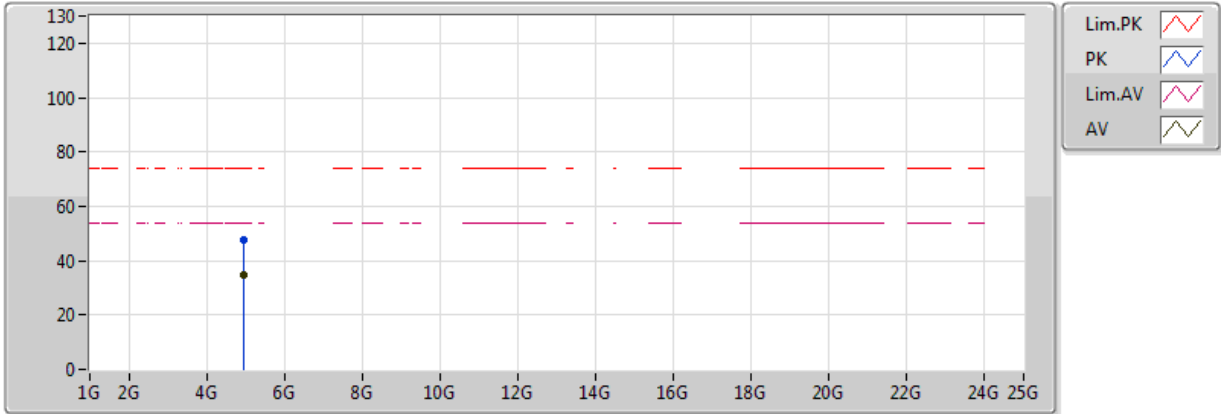

EUT Y_1TX
Setting 8
06-G-2
FSP(100080)

Type	Freq (Hz)	Level (dBuV/m)	Limit (dBuV/m)	Margin (dB)	Factor (dB)	Dist (m)	Condition	Azimuth (°)	Height (m)	Comments
PK	4.9603G	47.76	74.00	-26.24	7.08	3	Vertical	192	1.41	-
AV	4.96068G	34.58	54.00	-19.42	7.08	3	Vertical	192	1.41	-

BT-BR(1Mbps)

2480MHz_TX

18/04/2018

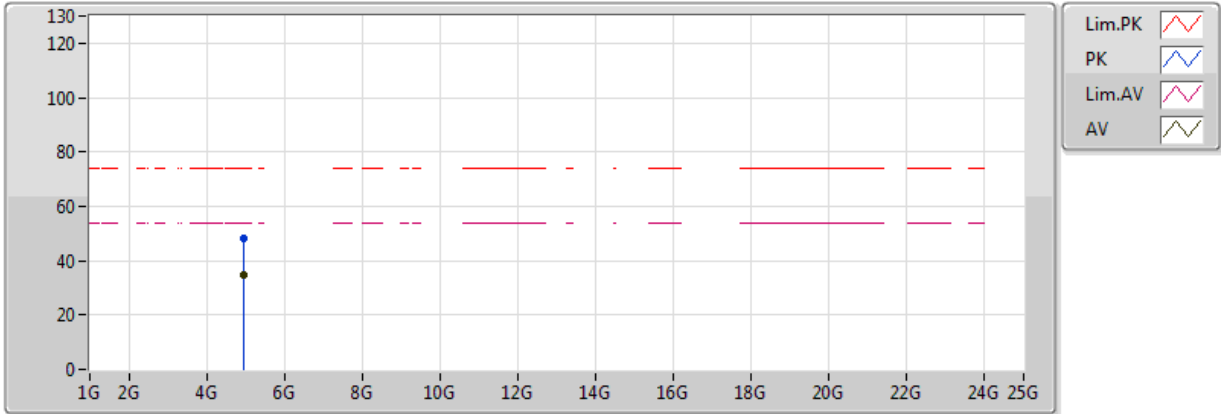

EUT Y_1TX
Setting 8
06-G-2
FSP(100080)

Type	Freq (Hz)	Level (dBuV/m)	Limit (dBuV/m)	Margin (dB)	Factor (dB)	Dist (m)	Condition	Azimuth (°)	Height (m)	Comments
PK	4.960616G	48.16	74.00	-25.84	7.08	3	Horizontal	296	1.52	-
AV	4.959484G	34.57	54.00	-19.43	7.08	3	Horizontal	296	1.52	-

BT-EDR(3Mbps)

2402MHz_TX

18/04/2018

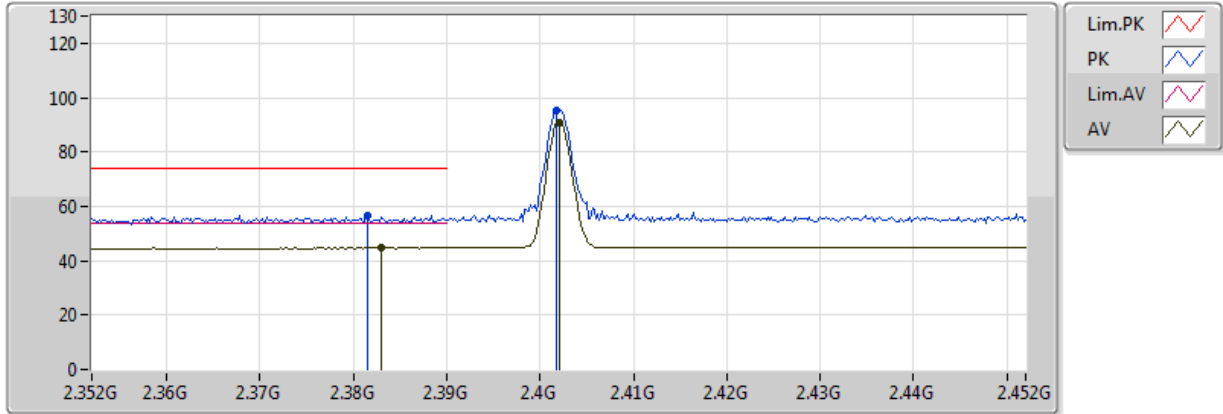

EUT Y_1TX
Setting 8
06-G-2
FSP(100080)

Type	Freq (Hz)	Level (dBuV/m)	Limit (dBuV/m)	Margin (dB)	Factor (dB)	Dist (m)	Condition	Azimuth (°)	Height (m)	Comments
PK	2.3816G	56.80	74.00	-17.20	32.09	3	Vertical	87	2.53	-
AV	2.383G	44.79	54.00	-9.21	32.10	3	Vertical	87	2.53	-
PK	2.4018G	95.12	Inf	-Inf	32.16	3	Vertical	87	2.53	-
AV	2.402G	90.95	Inf	-Inf	32.16	3	Vertical	87	2.53	-

BT-EDR(3Mbps)

2402MHz_TX

18/04/2018

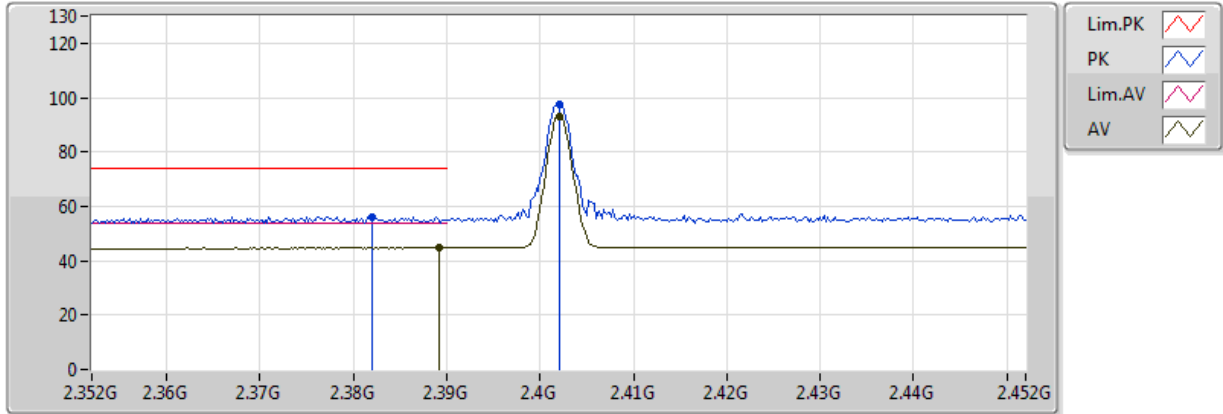

EUT Y_1TX
Setting 8
06-G-2
FSP(100080)

Type	Freq (Hz)	Level (dBuV/m)	Limit (dBuV/m)	Margin (dB)	Factor (dB)	Dist (m)	Condition	Azimuth (°)	Height (m)	Comments
PK	2.382G	56.07	74.00	-17.93	32.10	3	Horizontal	336	2.14	-
AV	2.3892G	44.83	54.00	-9.17	32.11	3	Horizontal	336	2.14	-
PK	2.402G	97.41	Inf	-Inf	32.16	3	Horizontal	336	2.14	-
AV	2.402G	93.23	Inf	-Inf	32.16	3	Horizontal	336	2.14	-

BT-EDR(3Mbps)

2402MHz_TX

18/04/2018

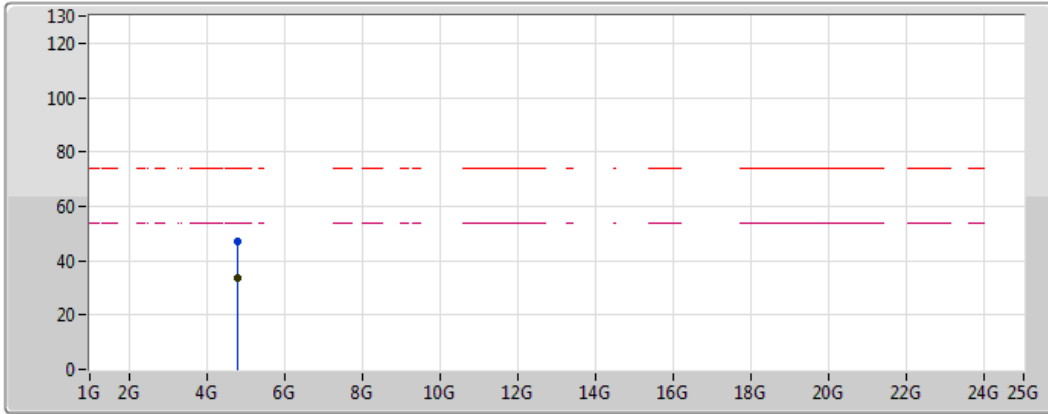

Legend for the spectrum plot:

- Lim.PK: Red dashed line with a peak icon
- PK: Blue solid line with a peak icon
- Lim.AV: Magenta dashed line with a peak icon
- AV: Black solid line with a peak icon

EUT Y_1TX
Setting 8
06-G-2
FSP(100080)

Type	Freq (Hz)	Level (dBuV/m)	Limit (dBuV/m)	Margin (dB)	Factor (dB)	Dist (m)	Condition	Azimuth (°)	Height (m)	Comments
PK	4.804172G	46.85	74.00	-27.15	6.64	3	Vertical	242	1.30	-
AV	4.804208G	33.58	54.00	-20.42	6.64	3	Vertical	242	1.30	-

BT-EDR(3Mbps)

2402MHz_TX

18/04/2018

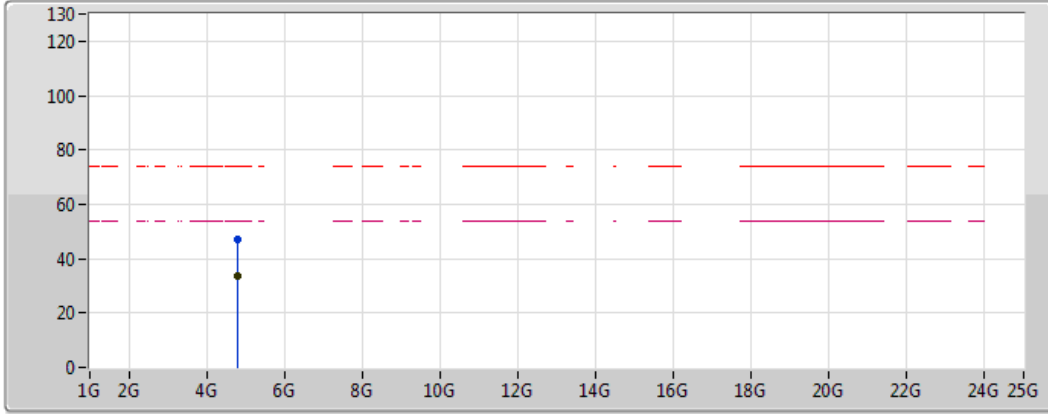

Legend for the spectrum plot:

- Lim.PK: Red dashed line with a peak icon
- PK: Blue line with a peak icon
- Lim.AV: Magenta dashed line with a peak icon
- AV: Black line with a peak icon

EUT Y_1TX
Setting 8
06-G-2
FSP(100080)

Type	Freq (Hz)	Level (dBuV/m)	Limit (dBuV/m)	Margin (dB)	Factor (dB)	Dist (m)	Condition	Azimuth (°)	Height (m)	Comments
PK	4.803316G	47.01	74.00	-26.99	6.64	3	Horizontal	187	1.69	-
AV	4.803116G	33.66	54.00	-20.34	6.64	3	Horizontal	187	1.69	-

BT-EDR(3Mbps)

2440MHz_TX

18/04/2018

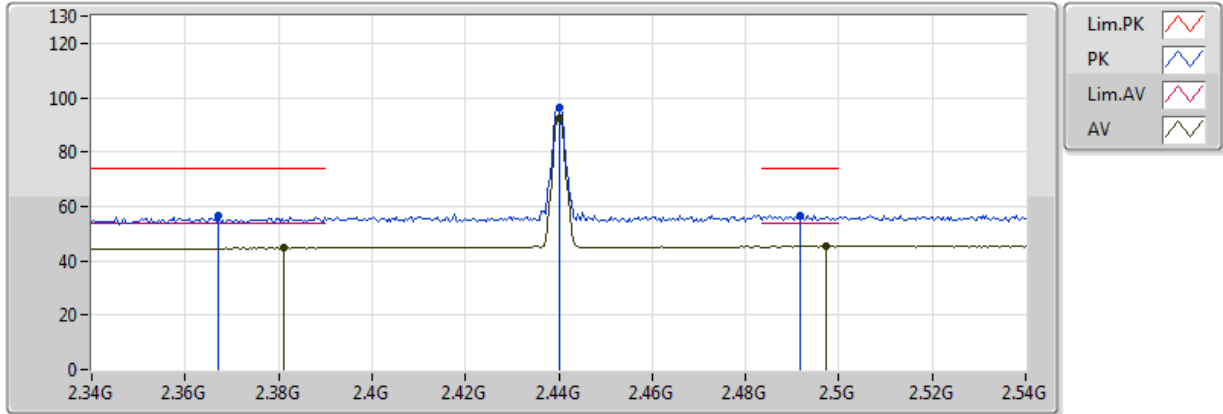

EUT Y_1TX
Setting 8
06-G-2
FSP(100080)

Type	Freq (Hz)	Level (dBuV/m)	Limit (dBuV/m)	Margin (dB)	Factor (dB)	Dist (m)	Condition	Azimuth (°)	Height (m)	Comments
PK	2.3672G	56.80	74.00	-17.20	32.05	3	Vertical	94	2.97	-
AV	2.3812G	44.84	54.00	-9.16	32.09	3	Vertical	94	2.97	-
PK	2.44G	96.57	Inf	-Inf	32.28	3	Vertical	94	2.97	-
AV	2.44G	92.36	Inf	-Inf	32.28	3	Vertical	94	2.97	-
PK	2.4916G	56.62	74.00	-17.38	32.45	3	Vertical	94	2.97	-
AV	2.4972G	45.33	54.00	-8.67	32.46	3	Vertical	94	2.97	-

BT-EDR(3Mbps)

2440MHz_TX

18/04/2018

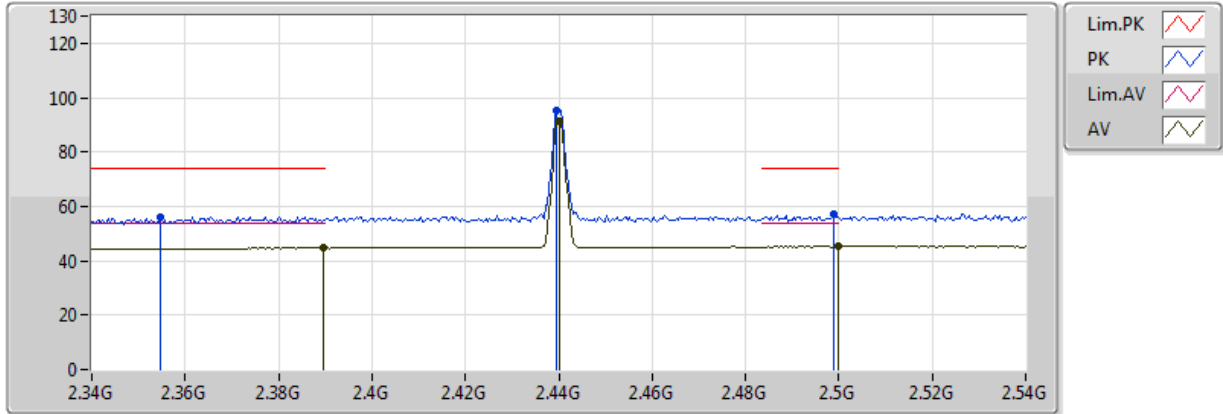

EUT Y_1TX
Setting 8
06-G-2
FSP(100080)

Type	Freq (Hz)	Level (dBuV/m)	Limit (dBuV/m)	Margin (dB)	Factor (dB)	Dist (m)	Condition	Azimuth (°)	Height (m)	Comments
PK	2.3548G	56.16	74.00	-17.84	32.01	3	Horizontal	333	1.86	-
AV	2.3896G	44.78	54.00	-9.22	32.11	3	Horizontal	333	1.86	-
PK	2.4396G	95.29	Inf	-Inf	32.28	3	Horizontal	333	1.86	-
AV	2.44G	91.13	Inf	-Inf	32.28	3	Horizontal	333	1.86	-
PK	2.4988G	56.91	74.00	-17.09	32.47	3	Horizontal	333	1.86	-
AV	2.5G	45.42	54.00	-8.58	32.48	3	Horizontal	333	1.86	-

BT-EDR(3Mbps)

2440MHz_TX

18/04/2018

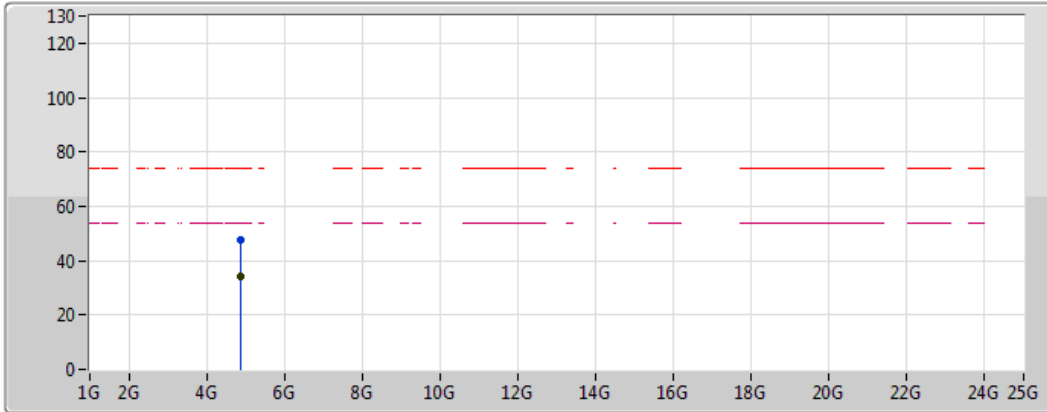

Legend for the spectrum plot:

- Lim.PK: Red dashed line with a red zigzag icon
- PK: Blue solid line with a blue zigzag icon
- Lim.AV: Magenta dashed line with a magenta zigzag icon
- AV: Black solid line with a black zigzag icon

EUT Y_1TX
Setting 8
06-G-2
FSP(100080)

Type	Freq (Hz)	Level (dBuV/m)	Limit (dBuV/m)	Margin (dB)	Factor (dB)	Dist (m)	Condition	Azimuth (°)	Height (m)	Comments
PK	4.88086G	47.66	74.00	-26.34	6.86	3	Vertical	289	1.63	-
AV	4.880448G	34.40	54.00	-19.60	6.86	3	Vertical	289	1.63	-

BT-EDR(3Mbps)

2440MHz_TX

18/04/2018

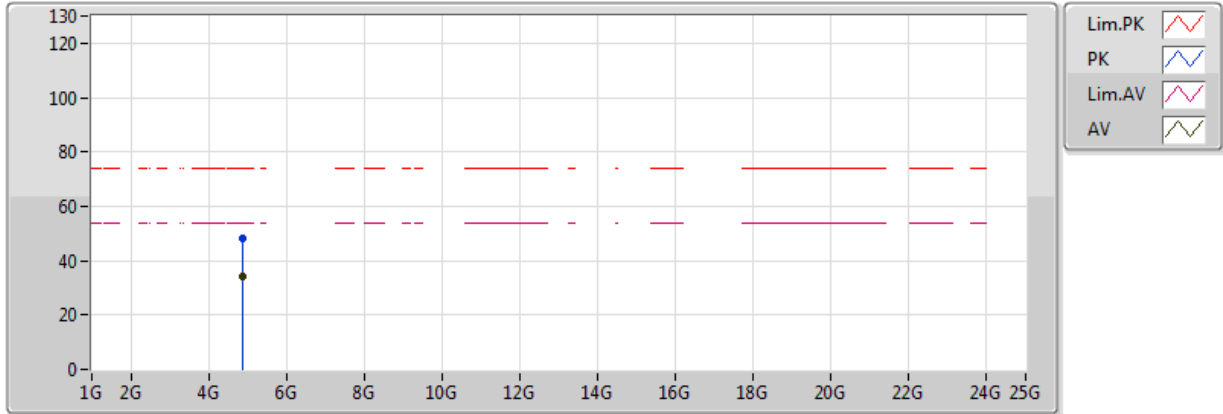

EUT Y_1TX
Setting 8
06-G-2
FSP(100080)

Type	Freq (Hz)	Level (dBuV/m)	Limit (dBuV/m)	Margin (dB)	Factor (dB)	Dist (m)	Condition	Azimuth (°)	Height (m)	Comments
PK	4.880128G	48.05	74.00	-25.95	6.85	3	Horizontal	233	1.39	-
AV	4.879448G	34.32	54.00	-19.68	6.85	3	Horizontal	233	1.39	-

BT-EDR(3Mbps)

2480MHz_TX

18/04/2018

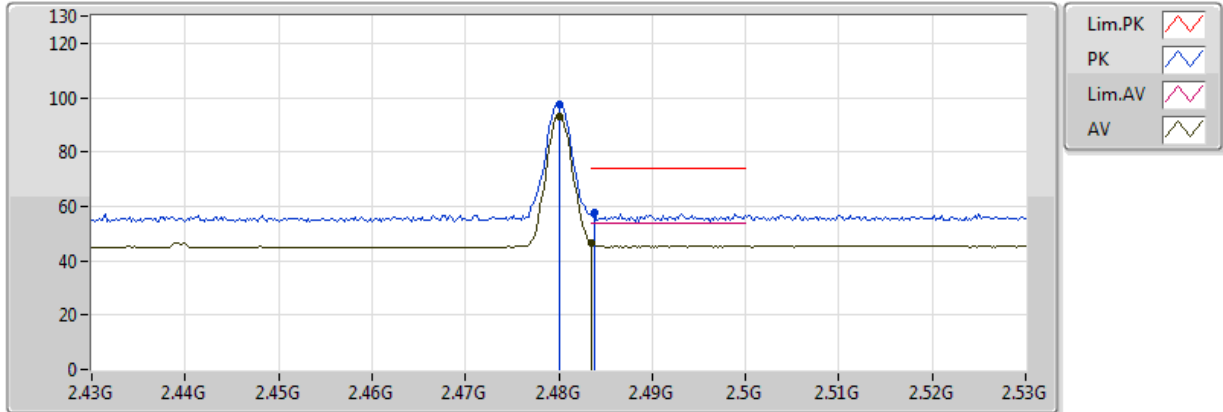

EUT Y_1TX
Setting 8
06-G-2
FSP(100080)

Type	Freq (Hz)	Level (dBuV/m)	Limit (dBuV/m)	Margin (dB)	Factor (dB)	Dist (m)	Condition	Azimuth (°)	Height (m)	Comments
PK	2.48G	97.24	Inf	-Inf	32.41	3	Vertical	90	2.92	-
AV	2.48G	93.13	Inf	-Inf	32.41	3	Vertical	90	2.92	-
PK	2.4838G	57.73	74.00	-16.27	32.42	3	Vertical	90	2.92	-
AV	2.483502G	46.44	54.00	-7.56	32.42	3	Vertical	90	2.92	-

BT-EDR(3Mbps)

2480MHz_TX

18/04/2018

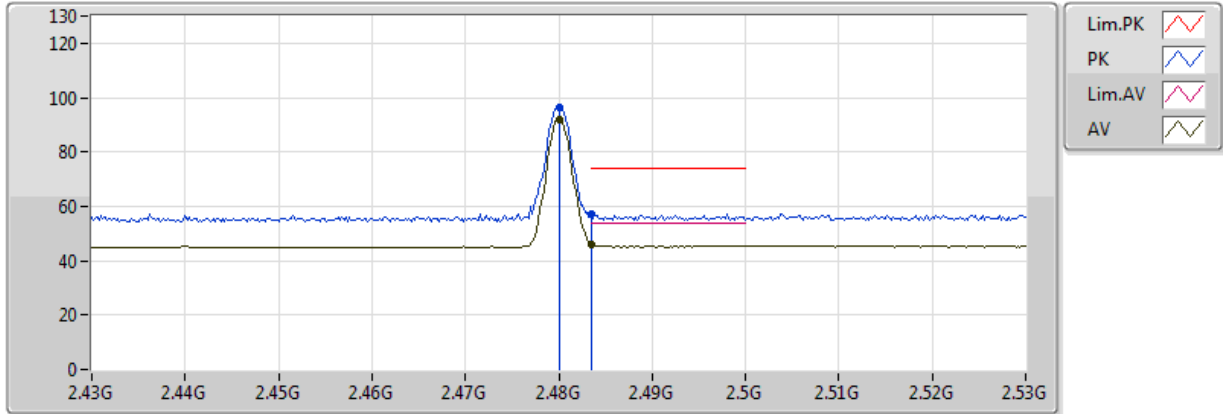

EUT Y_1TX
Setting 8
06-G-2
FSP(100080)

Type	Freq (Hz)	Level (dBuV/m)	Limit (dBuV/m)	Margin (dB)	Factor (dB)	Dist (m)	Condition	Azimuth (°)	Height (m)	Comments
PK	2.48G	96.21	Inf	-Inf	32.41	3	Horizontal	33	1.88	-
AV	2.48G	92.08	Inf	-Inf	32.41	3	Horizontal	33	1.88	-
PK	2.483502G	56.96	74.00	-17.04	32.42	3	Horizontal	33	1.88	-
AV	2.483502G	46.06	54.00	-7.94	32.42	3	Horizontal	33	1.88	-

BT-EDR(3Mbps)

2480MHz_TX

18/04/2018

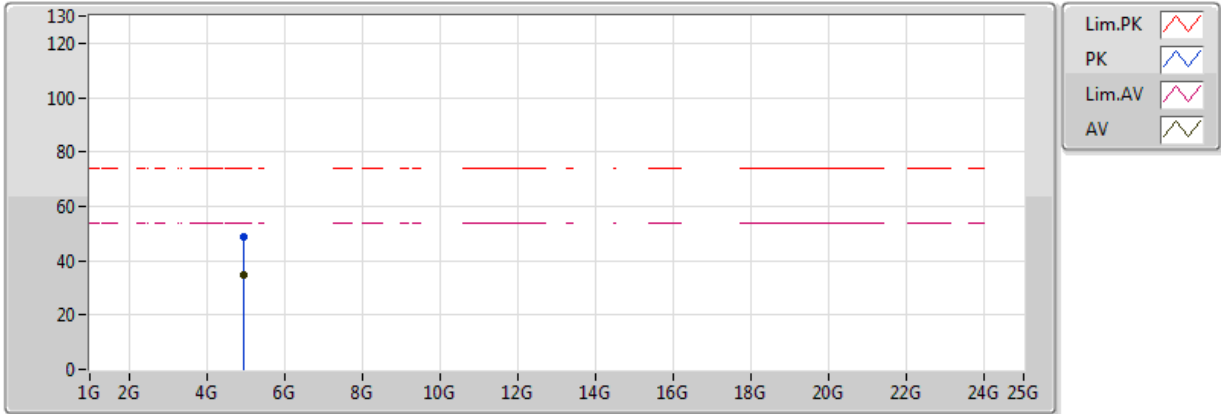

EUT Y_1TX
Setting 8
06-G-2
FSP(100080)

Type	Freq (Hz)	Level (dBuV/m)	Limit (dBuV/m)	Margin (dB)	Factor (dB)	Dist (m)	Condition	Azimuth (°)	Height (m)	Comments
PK	4.960336G	48.61	74.00	-25.39	7.08	3	Vertical	323	2.51	-
AV	4.960308G	34.64	54.00	-19.36	7.08	3	Vertical	323	2.51	-

BT-EDR(3Mbps)

2480MHz_TX

18/04/2018

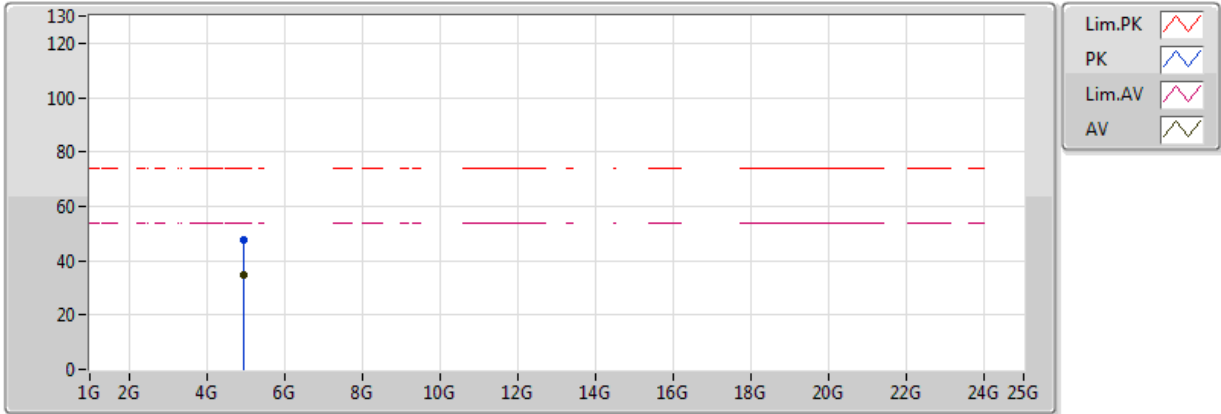

EUT Y_1TX
Setting 8
06-G-2
FSP(100080)

Type	Freq (Hz)	Level (dBuV/m)	Limit (dBuV/m)	Margin (dB)	Factor (dB)	Dist (m)	Condition	Azimuth (°)	Height (m)	Comments
PK	4.959304G	47.57	74.00	-26.43	7.08	3	Horizontal	284	1.70	-
AV	4.95938G	34.68	54.00	-19.32	7.08	3	Horizontal	284	1.70	-

