

# TEST REPORT

**Application No.:** SHEM1812000002CR  
**FCC ID:** N82-KOHLER035  
**IC:** 4554A-KOHLER035  
**Applicant:** Kohler Co.  
**Address of Applicant:** 444 Highland Drive Kohler, WI 53044 United States  
**Manufacturer:** Shanghai Kohler Electronics., Ltd.  
**Address of Manufacturer:** No. 1955, Fengxiang Road, Baoshan Area, Shanghai, PRC Post code: 200444  
**Factory:** Shanghai Kohler Electronics., Ltd.  
**Address of Factory:** No. 1955, Fengxiang Road, Baoshan Area, Shanghai, PRC Post code: 200444

**Equipment Under Test (EUT):**  
**EUT Name:** EIR Intelligent Toilet  
**Model No.:** K-77795, K-77795-RGD, K-77795-SG  
 ☐ Please refer to section 2 of this report which indicates which model was actually tested and which were electrically identical.

**Trade mark:** KOHLER  
**Standard(s) :** 47 CFR Part 15, Subpart C 15.249  
 RSS-210 Issue 9 August 2016 (Amendment)  
 RSS-Gen Issue 5, April 2018

**Date of Receipt:** 2018-12-18  
**Date of Test:** 2018-12-18 to 2018-12-25  
**Date of Issue:** 2019-04-08

<b>Test Result:</b>	<b>PASS*</b>
---------------------	--------------

\* In the configuration tested, the EUT complied with the standards specified above.

*Parlam Zhan*

Parlam Zhan  
E&E Section Manager

The manufacturer should ensure that all products in series production are in conformity with the product sample detailed in this report. If the product in this report is used in any configuration other than that detailed in the report, the manufacturer must ensure the new system complies with all relevant standards. Any mention of SGS International Electrical Approvals or testing done by SGS International Electrical Approvals in connection with, distribution or use of the product described in this report must be approved by SGS International Electrical Approvals in writing.



Unless otherwise agreed in writing, this document is issued by the Company subject to its General Conditions of Service printed overleaf, available on request or accessible at <http://www.sgs.com/en/Terms-and-Conditions.aspx> and, for electronic format documents, subject to Terms and Conditions for Electronic Documents at <http://www.sgs.com/en/Terms-and-Conditions/Terms-e-Documents.aspx>. Attention is drawn to the limitation of liability, indemnification and jurisdiction issues defined therein. Any holder of this document is advised that information contained hereon reflects the Company's findings at the time of its intervention only and within the limits of Client's instructions, if any. The Company's sole responsibility is to its Client and this document does not exonerate parties to a transaction from exercising all their rights and obligations under the transaction documents. This document cannot be reproduced except in full, without prior written approval of the Company. Any unauthorized alteration, forgery or falsification of the content or appearance of this document is unlawful and offenders may be prosecuted to the fullest extent of the law. Unless otherwise stated the results shown in this test report refer only to the sample(s) tested and such sample(s) are retained for 30 days only.  
**Attention: To check the authenticity of testing /inspection report & certificate, please contact us at telephone: (86-755) 8307 1443, or email: CN.Doccheck@sgs.com**



Revision Record			
Version	Description	Date	Remark
00	Original	2019-04-08	/

Authorized for issue by:			
		<i>Vincent Zhu</i>	
		_____ Vincent Zhu / Project Engineer	
		<i>Parlam zhan</i>	
		_____ Parlam Zhan / Reviewer	

## 2 Test Summary

Radio Spectrum Technical Requirement				
Item	Standard	Method	Requirement	Result
Antenna Requirement	47 CFR Part 15, Subpart C 15.249	N/A	47 CFR Part 15, Subpart C 15.203	Customer Declaration

Radio Spectrum Matter Part				
Item	Standard	Method	Requirement	Result
Conducted Emissions at AC Power Line (150kHz-30MHz)	47 CFR Part 15, Subpart C 15.249	ANSI C63.10 (2013) Section 6.2	47 CFR Part 15, Subpart C 15.207	Pass
20dB Bandwidth	47 CFR Part 15, Subpart C 15.249	ANSI C63.10 (2013) Section 6.9	47 CFR Part 15, Subpart C 15.215	Pass
Field Strength of the Fundamental Signal (15.249(a))	47 CFR Part 15, Subpart C 15.249	ANSI C63.10 (2013) Section 6.5&6.6	47 CFR Part 15, Subpart C 15.249(a)	Pass
Restricted Band Around Fundamental Frequency	47 CFR Part 15, Subpart C 15.249	ANSI C63.10 (2013) Section 6.4&6.5&6.6	47 CFR Part 15, Subpart C 15.205 & 15.249(d) & 15.209	Pass
Radiated Emissions	47 CFR Part 15, Subpart C 15.249	ANSI C63.10 (2013) Section 6.4&6.5&6.6	47 CFR Part 15, Subpart C 15.209 & 15.249 (a),(d)	Pass
99% Bandwidth	RSS-210 Issue 9 August 2016 (Amendment)	RSS-Gen Section 6.7	RSS-Gen Section 6.6	Pass
Frequency tolerance	RSS-210 Issue 9 August 2016 (Amendment)	RSS-210 A2.6 (a)	RSS-210 A2.6 (a)	Pass (Note 1)

### Note: Declaration of EUT Family Grouping:

There are series models mentioned in this report and they are the similar in electrical and electronic characters. Only the model K-77795 was tested since their differences are model number, color.

K-77795: EIR INTELLIGENT TOILET WHITE;

K-77795-SG: EIR INTELLIGENT TOILET SUNRISE GOLD

K-77795-RGD: EIR INTELLIGENT TOILET ROSE GOLD

Note 1: Frequency stability requested in RSS GEN S8.11 has been complied since the result of band edge can demonstrate.

### 3 Contents

	Page
<b>1 COVER PAGE .....</b>	<b>1</b>
<b>2 TEST SUMMARY .....</b>	<b>3</b>
<b>3 CONTENTS .....</b>	<b>4</b>
<b>4 GENERAL INFORMATION .....</b>	<b>5</b>
4.1 DETAILS OF E.U.T. ....	5
4.2 DESCRIPTION OF SUPPORT UNITS.....	5
4.3 MEASUREMENT UNCERTAINTY .....	5
4.4 TEST LOCATION .....	5
4.5 TEST FACILITY .....	6
4.6 DEVIATION FROM STANDARDS .....	6
4.7 ABNORMALITIES FROM STANDARD CONDITIONS.....	6
<b>5 EQUIPMENT LIST .....</b>	<b>7</b>
<b>6 RADIO SPECTRUM TECHNICAL REQUIREMENT .....</b>	<b>8</b>
6.1 ANTENNA REQUIREMENT .....	8
<b>7 RADIO SPECTRUM MATTER TEST RESULTS .....</b>	<b>9</b>
7.1 CONDUCTED EMISSIONS AT AC POWER LINE (150kHz-30MHz) .....	9
7.2 20DB BANDWIDTH.....	13
7.3 FIELD STRENGTH OF THE FUNDAMENTAL SIGNAL (15.249(A)) .....	16
7.4 RESTRICTED BAND AROUND FUNDAMENTAL FREQUENCY .....	18
7.5 RADIATED EMISSIONS .....	25
7.6 99% BANDWIDTH.....	30
7.7 FREQUENCY TOLERANCE.....	33
<b>8 TEST SETUP PHOTOGRAPHS .....</b>	<b>34</b>
<b>9 EUT CONSTRUCTIONAL DETAILS .....</b>	<b>34</b>

## 4 General Information

### 4.1 Details of E.U.T.

Power supply:	AC 120V 60Hz
Test voltage:	AC 120V 60Hz
Cable:	AC Cable 110cm
Modulation Type	MSK
Number of Channels	8
Operation Frequency	2414.5MHz~2449.5MHz
Channel Spacing	5MHz
Antenna Type:	PCB Antenna
Antenna Gain:	2.88 dBi

### 4.2 Description of Support Units

The EUT has been tested as an independent unit.

### 4.3 Measurement Uncertainty

No.	Item	Measurement Uncertainty
1	Radio Frequency	$\pm 8.4 \times 10^{-8}$
2	Timeout	$\pm 2s$
3	Duty cycle	$\pm 0.37\%$
4	Occupied Bandwidth	$\pm 3\%$
5	RF conducted power	$\pm 0.6dB$
6	RF power density	$\pm 2.84dB$
7	Conducted Spurious emissions	$\pm 0.75dB$
8	RF Radiated power	$\pm 4.6dB$ (Below 1GHz)
		$\pm 4.1dB$ (Above 1GHz)
9	Radiated Spurious emission test	$\pm 4.2dB$ (Below 30MHz)
		$\pm 4.4dB$ (30MHz-1GHz)
		$\pm 4.8dB$ (1GHz-18GHz)
		$\pm 5.2dB$ (Above 18GHz)
10	Temperature test	$\pm 1^{\circ}C$
11	Humidity test	$\pm 3\%$
12	Supply voltages	$\pm 1.5\%$
13	Time	$\pm 3\%$

Note: The measurement uncertainty represents an expanded uncertainty expressed at approximately the 95% confidence level using a coverage factor of k=2.

### 4.4 Test Location

All tests were performed at:

SGS-CSTC Standards Technical Services (Shanghai) Co., Ltd. E&E Lab

588 West Jindu Road, Xinqiao, Songjiang, 201612 Shanghai, China

Tel: +86 21 6191 5666

Fax: +86 21 6191 5678

No tests were sub-contracted.

#### 4.5 Test Facility

The test facility is recognized, certified, or accredited by the following organizations:

- **CNAS (No. CNAS L0599)**

CNAS has accredited SGS-CSTC Standards Technical Services (Shanghai) Co., Ltd. to ISO/IEC 17025:2005 General Requirements for the Competence of Testing and Calibration Laboratories (CNAS-CL01 Accreditation Criteria for the Competence of Testing and Calibration Laboratories) for the competence in the field of testing.

- **NVLAP (Certificate No. 201034-0)**

SGS-CSTC Standards Technical Services (Shanghai) Co., Ltd. is accredited by the National Voluntary Laboratory Accreditation Program (NVLAP). Certificate No. 201034-0.

- **FCC –Designation Number: CN5033**

SGS-CSTC Standards Technical Services (Shanghai) Co., Ltd. has been recognized as an accredited testing laboratory.

Designation Number: CN5033. Test Firm Registration Number: 479755.

- **Innovation, Science and Economic Development Canada**

SGS-CSTC Standards Technical Services (Shanghai) Co., Ltd. EMC Laboratory has been recognized by ISED as an accredited testing laboratory.

IC Registration No.: 8617A-1. CAB identifier: CN0020.

- **VCCI (Member No.: 3061)**

The 3m Semi-anechoic chamber and Shielded Room of SGS-CSTC Standards Technical Services (Shanghai) Co., Ltd. has been registered in accordance with the Regulations for Voluntary Control Measures with Registration No.: R-13868, C-14336, T-12221, G-10830 respectively.

#### 4.6 Deviation from Standards

None

#### 4.7 Abnormalities from Standard Conditions

None

## 5 Equipment List

Equipment	Manufacturer	Model No	Inventory No	Cal Date	Cal Due Date
<b>Conducted Emission at AC Power Line</b>					
EMI test receiver	R&S	ESR7	SHEM162-1	2018-12-20	2019-12-19
LISN	Schwarzbeck	NSLK8127	SHEM061-1	2018-12-20	2019-12-19
LISN	EMCO	3816/2	SHEM019-1	2018-12-20	2019-12-19
Pulse limiter	R&S	ESH3-Z2	SHEM029-1	2018-12-20	2019-12-19
CE test Cable	/	CE01	/	2018-12-26	2019-12-25
<b>Radiated Test</b>					
EMI test Receiver	R&S	ESU40	SHEM051-1	2018-12-20	2019-12-19
Spectrum Analyzer	R&S	FSP-30	SHEM002-1	2018-12-20	2019-12-19
Loop Antenna (9kHz-30MHz)	Schwarzbeck	FMZB1519	SHEM135-1	2017-04-10	2020-04-09
Antenna (25MHz-2GHz)	Schwarzbeck	VULB9168	SHEM048-1	2017-02-28	2020-02-27
Antenna (25MHz-3GHz)	Schwarzbeck	HL562	SHEM010-1	2017-02-28	2020-02-27
Horn Antenna (1-8GHz)	Schwarzbeck	HF906	SHEM009-1	2017-10-24	2020-10-23
Horn Antenna (1-18GHz)	Schwarzbeck	BBHA9120D	SHEM050-1	2017-01-14	2020-01-13
Horn Antenna (14-40GHz)	Schwarzbeck	BBHA 9170	SHEM049-1	2017-12-03	2020-12-02
Pre-amplifier (9kHz-2GHz)	CLAVIIO	BDLNA-0001	SHEM164-1	2018-08-13	2019-08-12
Pre-amplifier (1-18GHz)	CLAVIIO	BDLNA-0118	SHEM050-2	2018-08-13	2019-08-12
High-amplifier (14-40GHz)	Schwarzbeck	10001	SHEM049-2	2018-12-20	2019-12-19
Signal Generator	R&S	SMR40	SHEM058-1	2018-08-13	2019-08-12
Band Filter	LORCH	9BRX-875/X150	SHEM156-1	/	/
Band Filter	LORCH	13BRX-1950/X500	SHEM083-2	/	/
Band Filter	LORCH	5BRX-2400/X200	SHEM155-1	/	/
Band Filter	LORCH	5BRX-5500/X1000	SHEM157-2	/	/
High pass Filter	Wainwright	WHK3.0/18G	SHEM157-1	/	/
High pass Filter	Wainwright	WHKS1700	SHEM157-3	/	/
Semi/Fully Anechoic	ST	11*6*6M	SHEM078-2	2017-07-22	2020-07-21
RE test Cable	/	RE01, RE02, RE06	/	2018-12-26	2019-12-25



## 6 Radio Spectrum Technical Requirement

### 6.1 Antenna Requirement

#### 6.1.1 Test Requirement:

47 CFR Part 15, Subpart C 15.203

Limit:

15.203 requirement:

An intentional radiator shall be designed to ensure that no antenna other than that furnished by the responsible party shall be used with the device. The use of a permanently attached antenna or of an antenna that uses a unique coupling to the intentional radiator, the manufacturer may design the unit so that a broken antenna can be replaced by the user, but the use of a standard antenna jack or electrical connector is prohibited.

#### 6.1.2 Conclusion

Standard Requirement:

An intentional radiator shall be designed to ensure that no antenna other than that furnished by the responsible party shall be used with the device. The use of a permanently attached antenna or of an antenna that uses a unique coupling to the intentional radiator, the manufacturer may design the unit so that a broken antenna can be replaced by the user, but the use of a standard antenna jack or electrical connector is prohibited.

EUT Antenna:

The antenna is integrated on the main PCB and no consideration of replacement. The best case gain of the antenna is 2.88dBi.

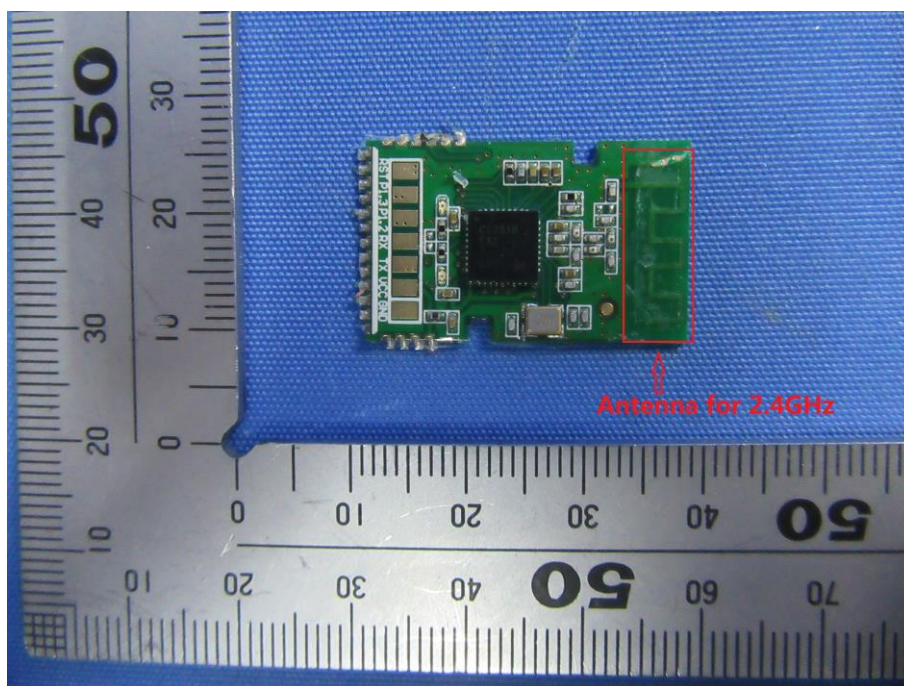



## 7 Radio Spectrum Matter Test Results

### 7.1 Conducted Emissions at AC Power Line (150kHz-30MHz)

Test Requirement 47 CFR Part 15, Subpart C 15.207  
Test Method: ANSI C63.10 (2013) Section 6.2  
Limit:

Frequency range (MHz)	Limit (dBuV)	
	Quasi-peak	Average
0.15-0.5	66 to 56*	56 to 46*
0.5-5	56	46
5-30	60	50

\* Decreases with the logarithm of the frequency.

#### 7.1.1 E.U.T. Operation

Operating Environment:

Temperature: 22 °C Humidity: 50 % RH Atmospheric Pressure: 1002 mbar

Test mode a:TX mode\_Keep the EUT in transmitting with modulation mode.

#### 7.1.2 Test Setup Diagram

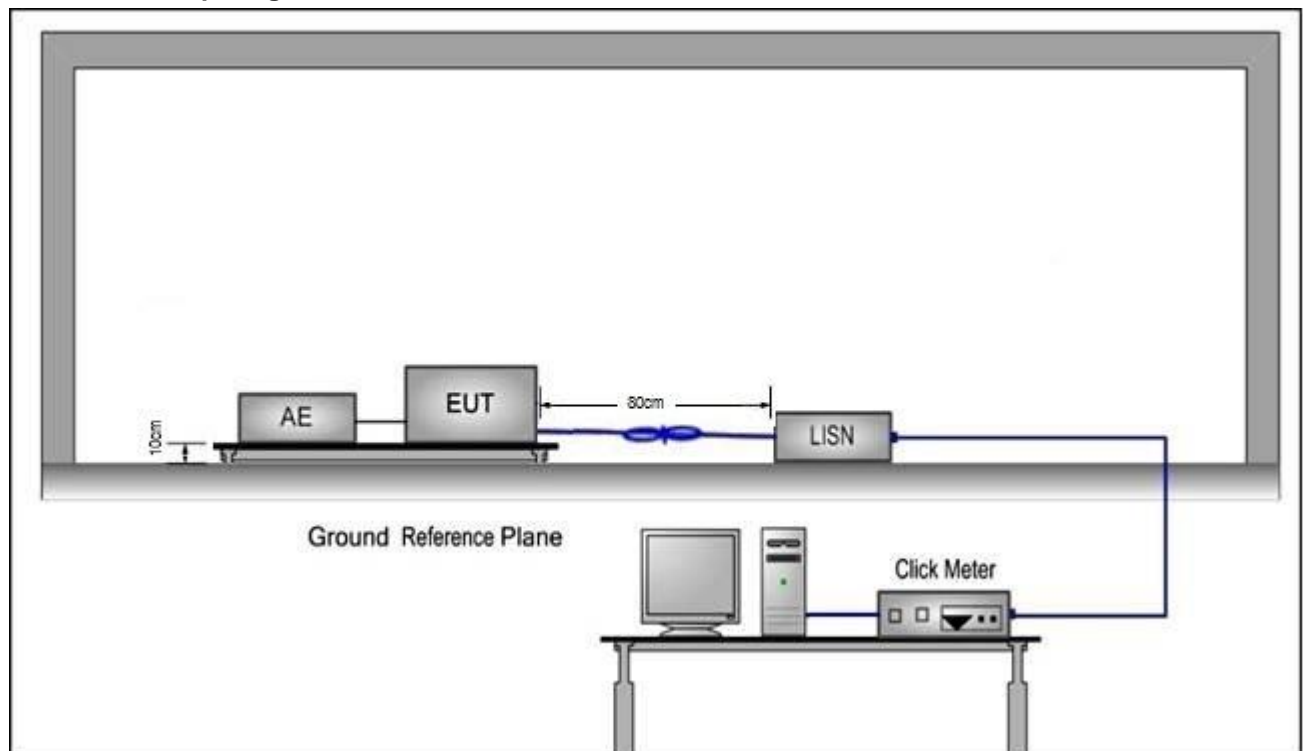

### 7.1.3 Measurement Procedure and Data

- 1) The mains terminal disturbance voltage test was conducted in a shielded room.
- 2) The EUT was connected to AC power source through a LISN 1 (Line Impedance Stabilization Network) which provides a 50ohm/50 $\mu$ H + 5ohm linear impedance. The power cables of all other units of the EUT were connected to a second LISN 2, which was bonded to the ground reference plane in the same way as the LISN 1 for the unit being measured. A multiple socket outlet strip was used to connect multiple power cables to a single LISN provided the rating of the LISN was not exceeded.
- 3) The tabletop EUT was placed upon a non-metallic table 0.8m above the ground reference plane. And for floor-standing arrangement, the EUT was placed on the horizontal ground reference plane,
- 4) The test was performed with a vertical ground reference plane. The rear of the EUT shall be 0.4 m from the vertical ground reference plane. The vertical ground reference plane was bonded to the horizontal ground reference plane. The LISN 1 was placed 0.8 m from the boundary of the unit under test and bonded to a ground reference plane for LISNs mounted on top of the ground reference plane. This distance was between the closest points of the LISN 1 and the EUT. All other units of the EUT and associated equipment was at least 0.8 m from the LISN 2.
- 5) In order to find the maximum emission, the relative positions of equipment and all of the interface cables must be changed according to ANSI C63.10 on conducted measurement.

Remark: LISN=Read Level+ Cable Loss+ LISN Factor

Mode:a; Line:Live Line

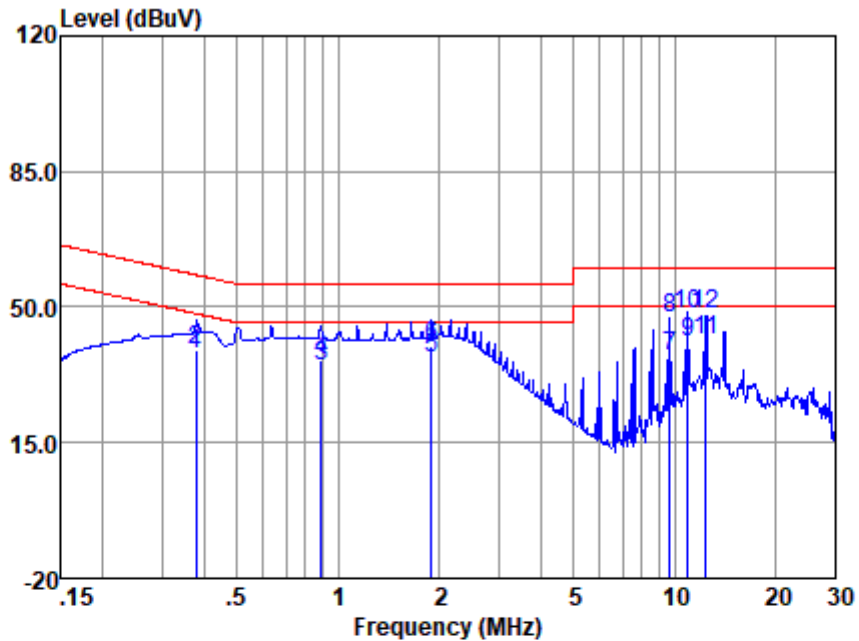

LISN : LINE  
EUT/Project No : 0004CR  
Test Mode : a

	Freq (MHz)	Read level (dBuV)	LISN Factor (dB)	Cable Loss (dB)	Emission Level (dBuV)	Limit (dBuV)	Over Limit (dB)	Remark
1	0.38	27.88	0.05	9.85	37.78	48.30	-10.52	Average
2	0.38	28.83	0.05	9.85	38.73	58.30	-19.57	QP
3	0.89	24.64	0.05	9.88	34.57	46.00	-11.43	Average
4	0.89	26.48	0.05	9.88	36.41	56.00	-19.59	QP
5	1.90	27.08	0.05	9.89	37.02	46.00	-8.98	Average
6	1.90	29.88	0.05	9.89	39.82	56.00	-16.18	QP
7	9.71	27.58	0.20	9.81	37.59	50.00	-12.41	Average
8	9.71	37.33	0.20	9.81	47.34	60.00	-12.66	QP
9	10.96	31.00	0.21	9.75	40.96	50.00	-9.04	Average
10	10.96	38.00	0.21	9.75	47.96	60.00	-12.04	QP
11	12.45	31.00	0.21	10.03	41.24	50.00	-8.76	Average
12	12.45	37.94	0.21	10.03	48.18	60.00	-11.82	QP

Notes: Emission Level = Read Level + LISN Factor + Cable loss

Mode:a; Line:Neutral Line

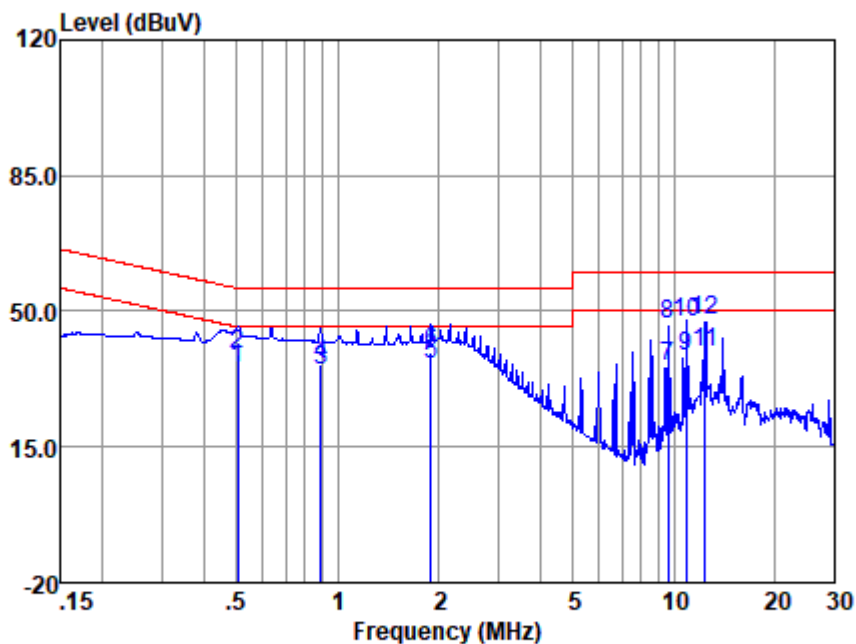

LISN : NEUTRAL  
 EUT/Project No : 0004CR  
 Test Mode : a

	Freq (MHz)	Read level (dBuV)	LISN Factor (dB)	Cable Loss (dB)	Emission Level (dBuV)	Limit (dBuV)	Over Limit (dB)	Remark
1	0.50	25.52	0.05	9.80	35.37	46.00	-10.63	Average
2	0.50	28.82	0.05	9.80	38.67	56.00	-17.33	QP
3	0.89	25.01	0.05	9.88	34.94	46.00	-11.06	Average
4	0.89	26.58	0.05	9.88	36.51	56.00	-19.49	QP
5	1.90	26.26	0.06	9.89	36.21	46.00	-9.79	Average
6	1.90	29.69	0.06	9.89	39.64	56.00	-16.36	QP
7	9.65	25.85	0.20	9.78	35.83	50.00	-14.17	Average
8	9.65	36.80	0.20	9.78	46.78	60.00	-13.22	QP
9	10.90	28.21	0.21	9.76	38.18	50.00	-11.82	Average
10	10.90	37.05	0.21	9.76	47.02	60.00	-12.98	QP
11	12.45	29.00	0.22	10.03	39.25	50.00	-10.75	Average
12	12.45	37.37	0.22	10.03	47.62	60.00	-12.38	QP

Notes: Emission Level = Read Level + LISN Factor + Cable loss

## 7.2 20dB Bandwidth

Test Requirement 47 CFR Part 15, Subpart C 15.215  
 Test Method: ANSI C63.10 (2013) Section 6.9  
 Limit: N/A

### 7.2.1 E.U.T. Operation

Operating Environment:

Temperature: 20 °C Humidity: 50 % RH Atmospheric Pressure: 1010 mbar

Test mode a:TX mode\_Keep the EUT in transmitting with modulation mode.

### 7.2.2 Test Setup Diagram

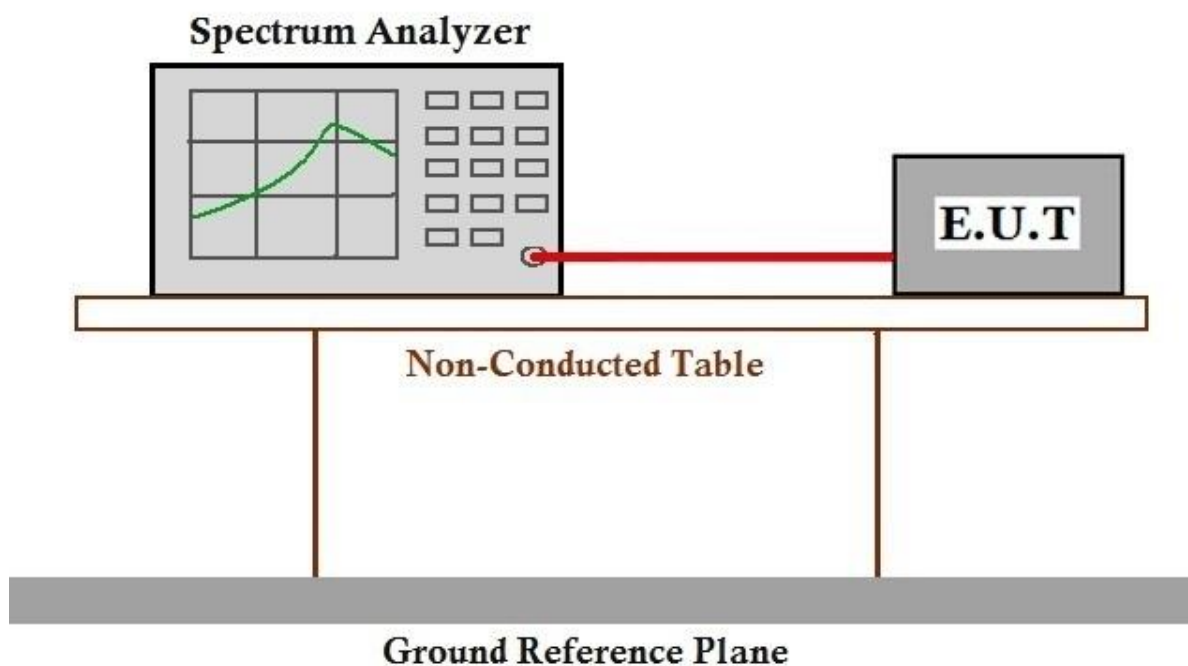

### 7.2.3 Measurement Procedure and Data

1. Place the EUT on the table and set it in Engineering mode.
2. Remove the antenna from the EUT and then connect a low loss RF cable from the antenna port to the spectrum analyzer.
3. Set the spectrum analyzer as RBW = approximately 1 % to 5 % of the OBW (set 30 kHz), VBW =3\* RBW, Span=3MHz, Sweep=auto
4. Mark the peak frequency and -20dB (upper and lower) frequency.
5. Repeat above procedures until all frequency measured was complete.

Frequency (MHz)	Bandwidth (MHz)	Result
2414.5	0.792	PASS
2434.5	0.786	PASS
2449.5	0.786	PASS

Test plot as follows:

Channel: 2414.5MHz

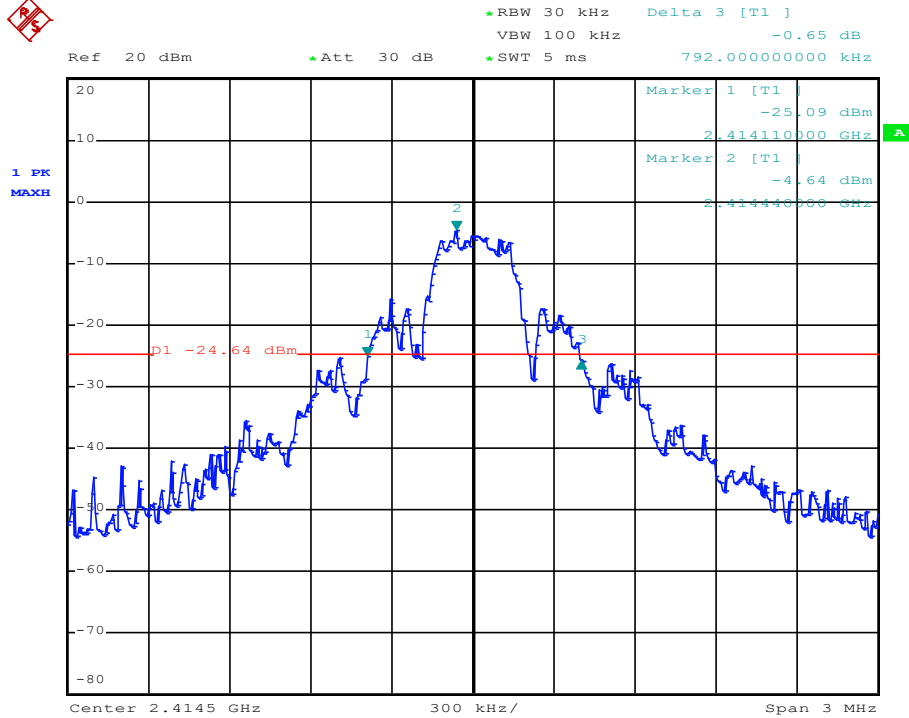

Channel: 2434.5MHz

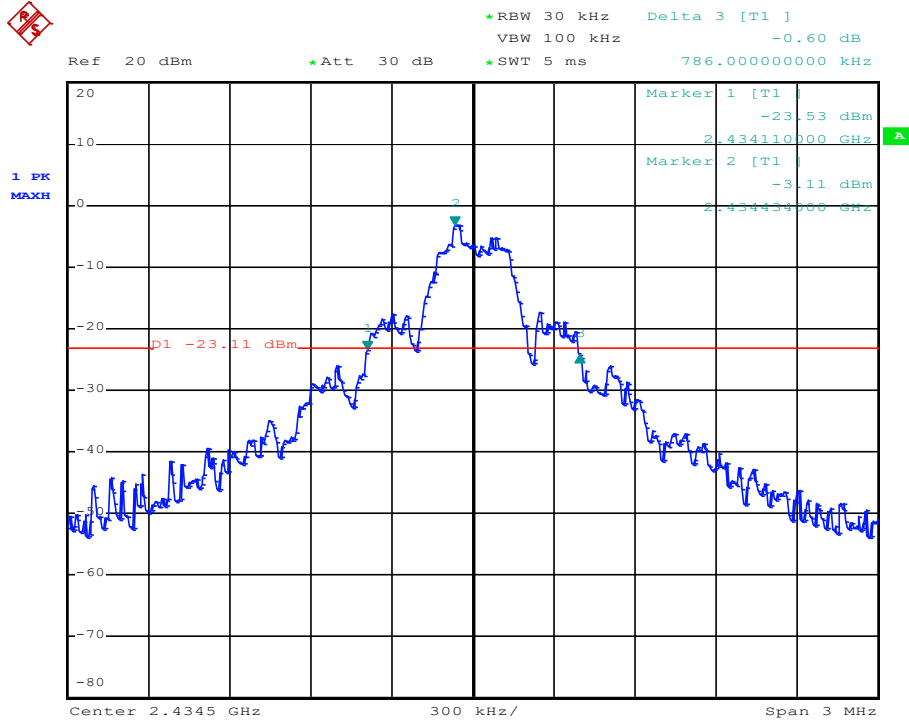



Channel: 2449.5MHz

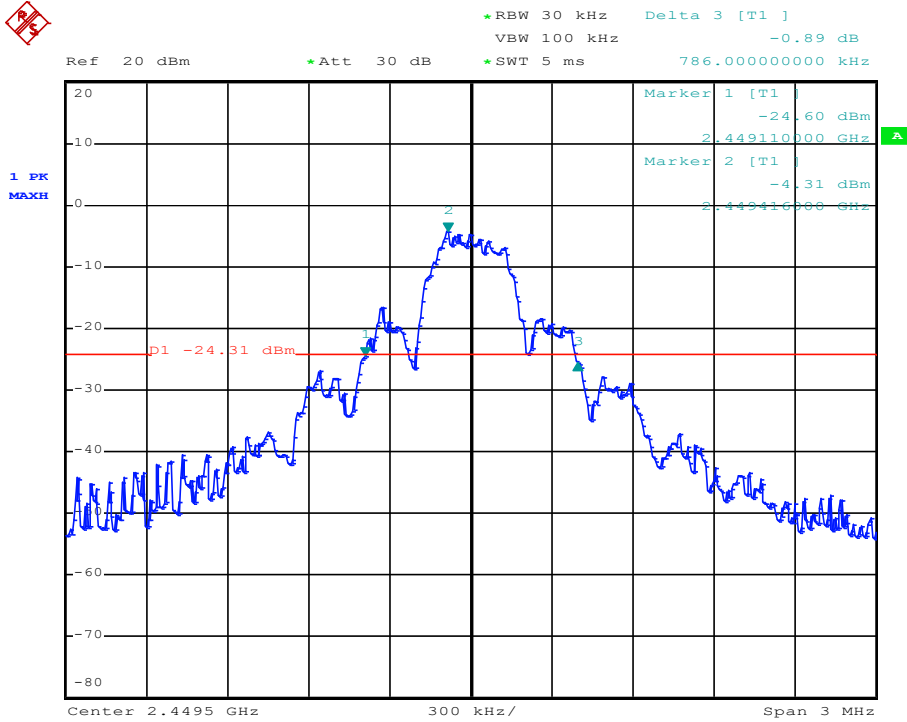

### 7.3 Field Strength of the Fundamental Signal (15.249(a))

Test Requirement 47 CFR Part 15, Subpart C 15.249(a)

Test Method: ANSI C63.10 (2013) Section 6.5&6.6

Test Site: Measurement Distance: 3m

Receiver Setup:

Frequency	Detector	RBW	VBW	Remark
Above 1GHz	Peak	1MHz	3MHz	Peak
	Peak	1MHz	10Hz	Average

Limit:

Frequency	Limit (dBuV/m)	Remark
2400~2483.5 MHz	114	Peak
	94	Quasi-Peak

Test Setup:

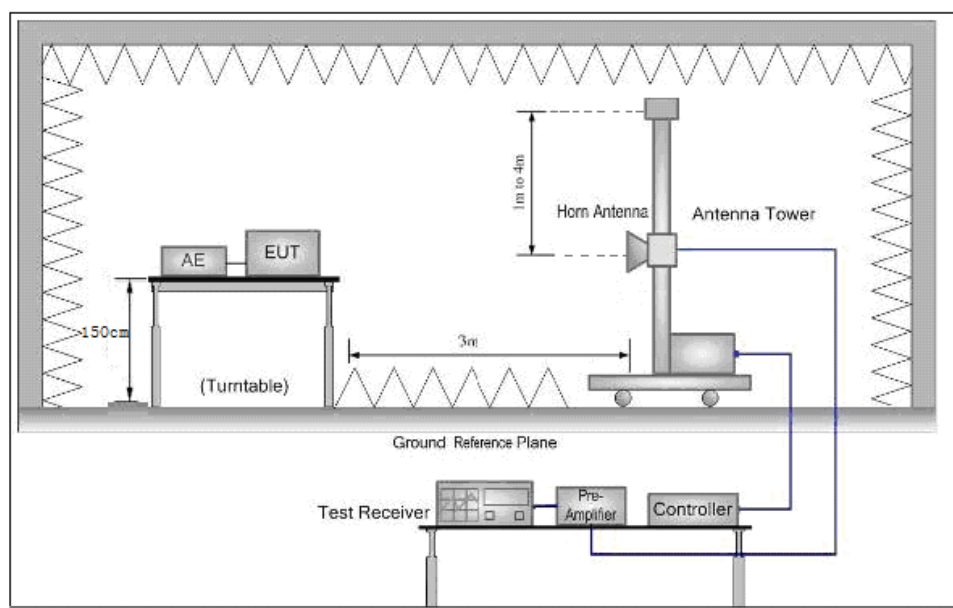

Test Procedure:

- The EUT was placed on the top of a rotating table 0.8 meters above the ground at a 3 meter semi-anechoic chamber. The table was rotated 360 degrees to determine the position of the highest radiation.
- The EUT was set 3 meters away from the interference-receiving antenna, which was mounted on the top of a variable-height antenna tower.
- The antenna height is varied from one meter to four meters above the ground to determine the maximum value of the field strength. Both horizontal and vertical polarizations of the antenna are set to make the measurement.
- For each suspected emission, the EUT was arranged to its worst case and then the antenna was tuned to heights from 1 meter to 4 meters (for the test frequency of below 30MHz, the antenna was tuned to heights 1 meter) and the rotatable table was turned from 0 degrees to 360 degrees to find the maximum reading.
- The test-receiver system was set to Peak Detect Function and Specified Bandwidth with Maximum Hold Mode.
- If the emission level of the EUT in peak mode was 10dB lower than the limit specified, then testing could be stopped and the peak values of the EUT would be reported. Otherwise the emissions that did not have 10dB margin would be re-tested one by one using peak, quasi-peak or average method as specified and then reported in a data sheet.

Test Results:

Pass

**Measurement Data**

Peak value:

Frequency (MHz)	Read Level (dBuV)	Factor (dB/m)	Level (dBuV/m)	Limit Line (dBuV/m)	Over Limit (dB)	Detector	Polarization
2414.5	91.42	-8.15	83.27	94	-10.73	Peak	Horizontal
	85.98	-8.18	77.8	94	-16.2	Peak	Vertical

Frequency (MHz)	Read Level (dBuV)	Factor (dB/m)	Level (dBuV/m)	Limit Line (dBuV/m)	Over Limit (dB)	Detector	Polarization
2434.5	90.05	-8.17	81.88	94	-12.12	Peak	Horizontal
	86.22	-8.17	78.05	94	-15.95	Peak	Vertical

Frequency (MHz)	Read Level (dBuV)	Factor (dB/m)	Level (dBuV/m)	Limit Line (dBuV/m)	Over Limit (dB)	Detector	Polarization
2449.5	89.35	-8.18	81.17	94	-12.83	Peak	Horizontal
	86.35	-8.15	78.2	94	-15.8	Peak	Vertical

Remark:

- 1) The basic equation with a sample calculation is as follows: Level = Read Level + Factor.  
**(The Factor is calculated by adding the Antenna Factor, Cable Loss and Preamp Factor)**
- 2) If the Peak value below the Quasi-Peak Limit, the Quasi-Peak test doesn't perform for this submission.

### 7.4 Restricted Band Around Fundamental Frequency

Test Requirement 47 CFR Part 15, Subpart C 15.205 & 15.249(d) & 15.209

Test Method: ANSI C63.10 (2013) Section 6.4&6.5&6.6

Limit:

Frequency(MHz)	Field strength(microvolts/meter)	Measurement distance(meters)
0.009-0.490	2400/F(kHz)	300
0.490-1.705	24000/F(kHz)	30
1.705-30.0	30	30
30-88	100	3
88-216	150	3
216-960	200	3
Above 960	500	3

Remark: The emission limits shown in the above table are based on measurements employing a CISPR quasi-peak detector except for the frequency bands 9-90kHz, 110-490kHz and above 1000 MHz. Radiated emission limits in these three bands are based on measurements employing an average detector, the peak field strength of any emission shall not exceed the maximum permitted average limits specified above by more than 20 dB under any condition of modulation.

**7.4.1 E.U.T. Operation**

Operating Environment:

Temperature: 22 °C Humidity: 50 % RH Atmospheric Pressure: 1002 mbar

Test mode a:TX mode\_Keep the EUT in transmitting with modulation mode.

**7.4.2 Test Setup Diagram**

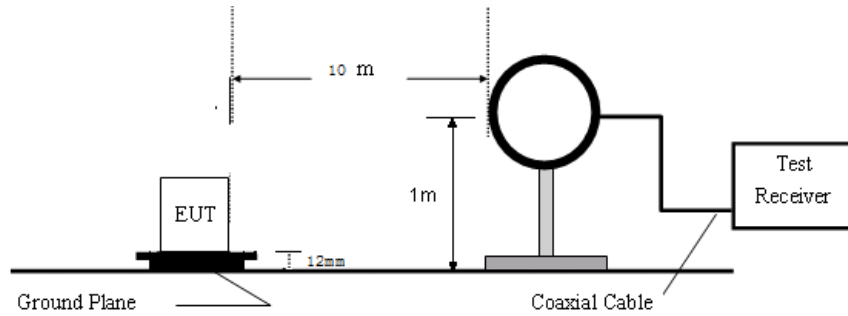

**Below 30MHz**

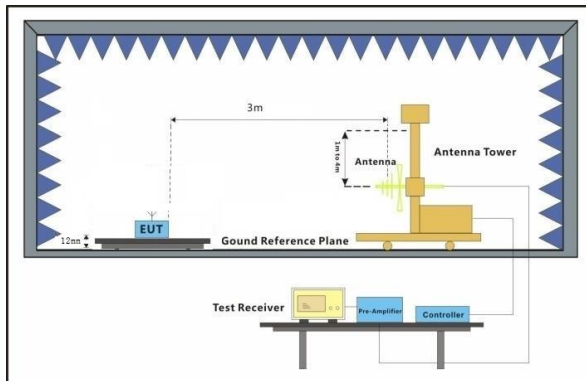

**30MHz to 1GHz**

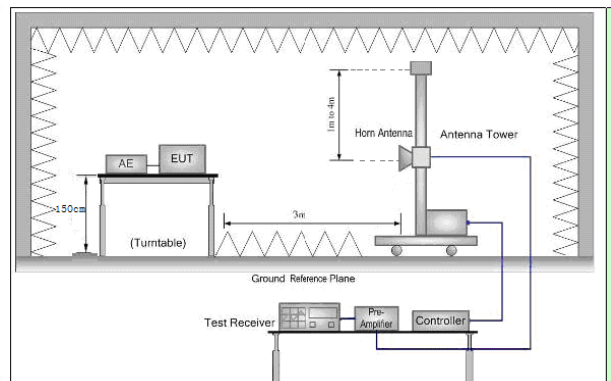

**Above 1 GHz**

**7.4.3 Measurement Procedure and Data**

- a. For below 1GHz, the EUT was placed on the top of a rotating table 0.8 meters above the ground at a 3 or 10 meter semi-anechoic chamber. The table was rotated 360 degrees to determine the position of the highest radiation.
- b. For above 1GHz, the EUT was placed on the top of a rotating table 1.5 meters above the ground at a 3 meter fully-anechoic chamber. The table was rotated 360 degrees to determine the position of the highest radiation.
- c. The EUT was set 3 or 10 meters away from the interference-receiving antenna, which was mounted on the top of a variable-height antenna tower.
- d. The antenna height is varied from one meter to four meters above the ground to determine the maximum value of the field strength. Both horizontal and vertical polarizations of the antenna are set to make the measurement.
- e. For each suspected emission, the EUT was arranged to its worst case and then the antenna was tuned to heights from 1 meter to 4 meters (for the test frequency of below 30MHz, the antenna was tuned to heights 1 meter) and the rotatable table was turned from 0 degrees to 360 degrees to find the maximum reading.
- f. The test-receiver system was set to Peak Detect Function and Specified Bandwidth with Maximum Hold Mode.
- g. If the emission level of the EUT in peak mode was 10dB lower than the limit specified, then testing could be stopped and the peak values of the EUT would be reported. Otherwise the emissions that did not have 10dB margin would be re-tested one by one using peak, quasi-peak or average method as specified and then reported in a data sheet.
- h. Test the EUT in the lowest channel, the middle channel, the Highest channel.
- i. The radiation measurements are performed in X, Y, Z axis positioning for Transmitting mode, and found the X axis positioning which it is the worst case.
- j. Repeat above procedures until all frequencies measured was complete.

Remark 1:  $\text{Level} = \text{Read Level} + \text{Cable Loss} + \text{Antenna Factor} - \text{Preamp Factor}$

Remark 2: For frequencies above 1GHz, the field strength limits are based on average limits. However, the peak field strength of any emission shall not exceed the maximum permitted average limits specified above by more than 20 dB under any condition of modulation. For the emissions whose peak level is lower than the average limit, only the peak measurement is shown in the report.



2414.5MHz:

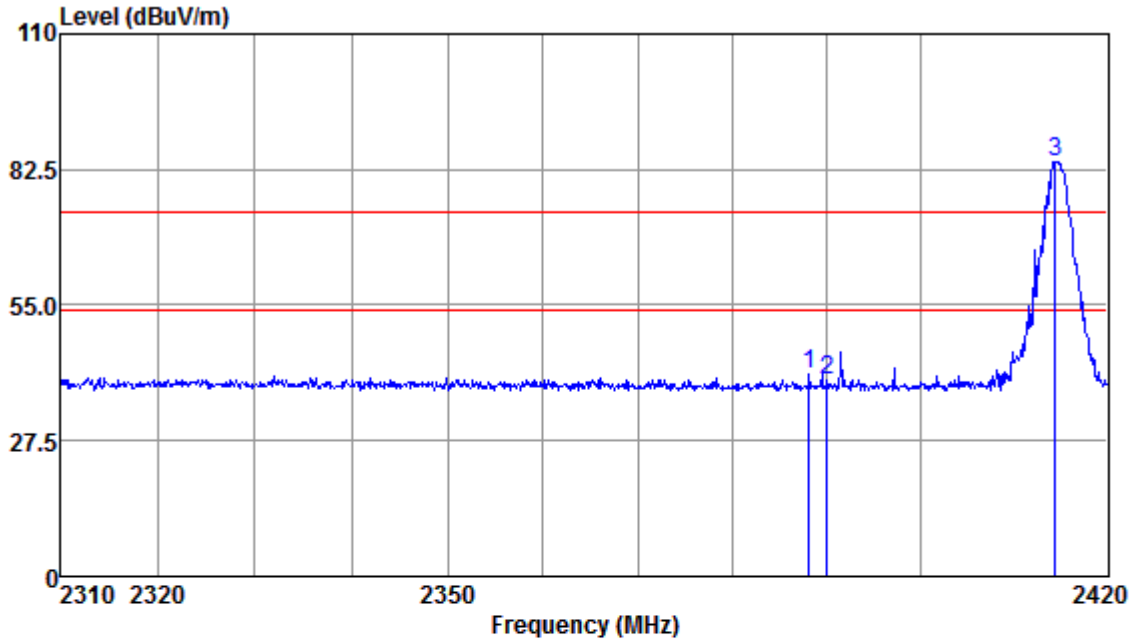

Antenna Polarity :HORIZONTAL

Freq	Read Level	Antenna Factor	Cable Loss	Preamp Factor	Emission Level	Limit Line	Over Limit	Remark
MHz	dBuv	dB/m	dB	dB	dBuv/m	dBuv/m	dB	
2388.13	49.37	26.03	3.15	37.36	41.19	74.00	-32.81	Peak
2390.00	47.88	26.03	3.15	37.36	39.70	74.00	-34.30	Peak
2414.38	92.31	26.08	3.13	37.36	84.16	74.00	10.16	Peak

Note:Emission Level=Read Level+Antenna Factor+Cable loss-Preamp Factor

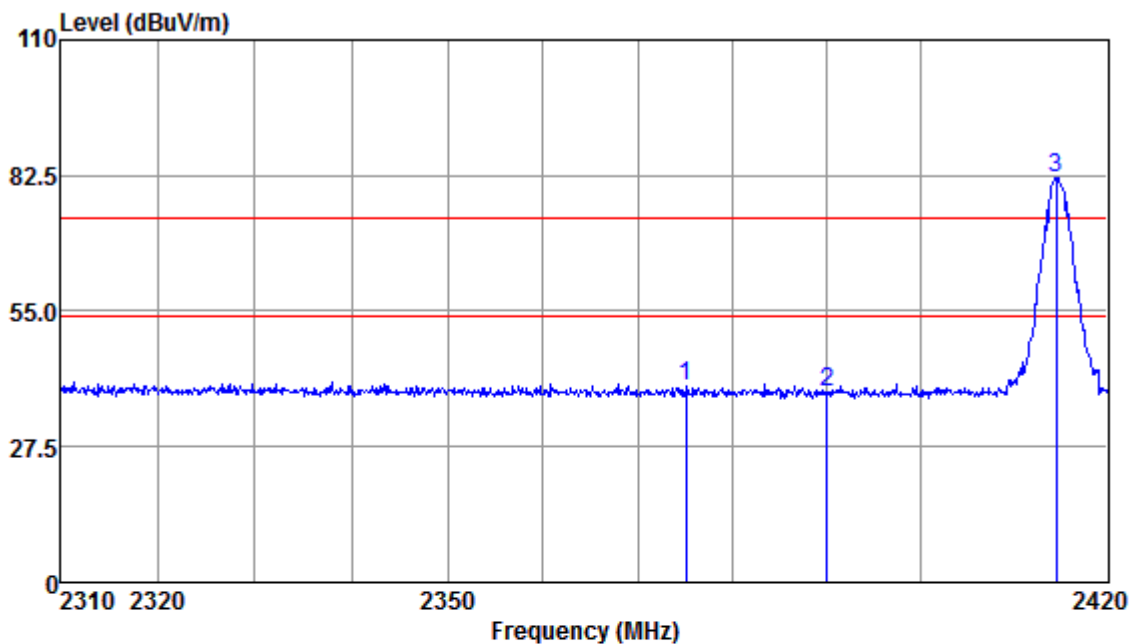

Antenna Polarity :VERTICAL

Freq	Read Level	Antenna Factor	Cable Loss	Preamp Factor	Emission Level	Limit Line	Over Limit	Remark
MHz	dBuv	dB/m	dB	dB	dBuv/m	dBuv/m	dB	
2375.05	48.08	26.01	3.17	37.36	39.90	74.00	-34.10	Peak
2390.00	46.57	26.03	3.15	37.36	38.39	74.00	-35.61	Peak
2414.49	90.31	26.08	3.13	37.36	82.16	74.00	8.16	Peak

Note:Emission Level=Read Level+Antenna Factor+Cable loss-Preamp Factor

2449.5MHz:

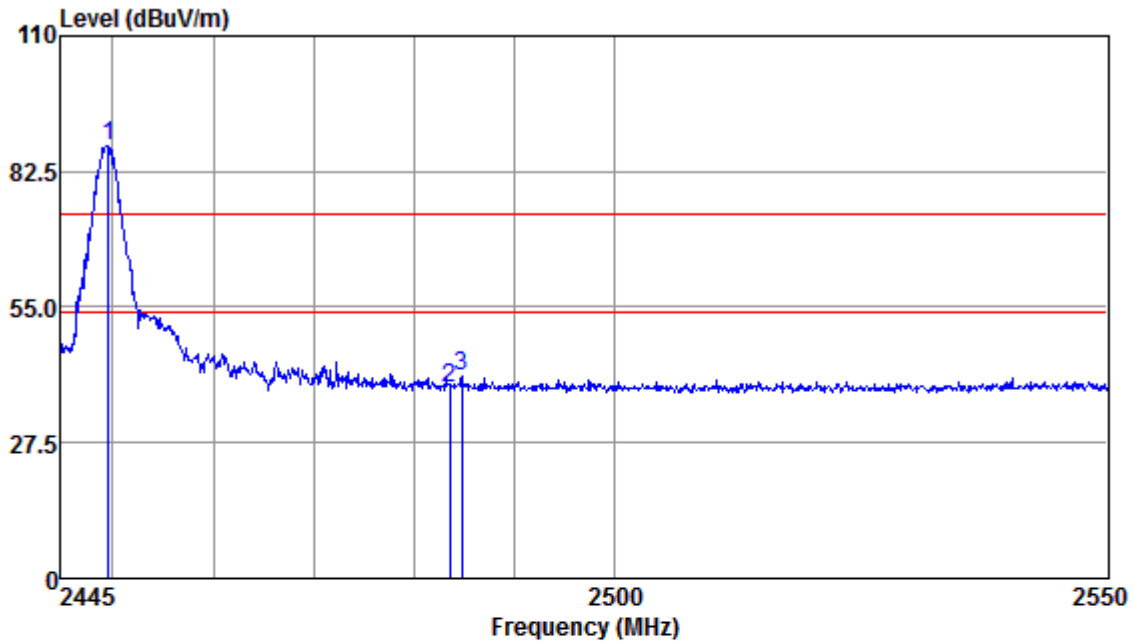

Antenna Polarity :HORIZONTAL

Freq	Read Level	Antenna Factor	Cable Loss	Preamp Factor	Emission Level	Limit Line	Over Limit	Remark
MHz	dBuv	dB/m	dB	dB	dBuv/m	dBuv/m	dB	
2449.63	95.71	26.13	3.13	37.43	87.54	74.00	13.54	Peak
2483.50	46.89	26.18	3.14	37.51	38.70	74.00	-35.30	Peak
2484.69	49.22	26.18	3.14	37.51	41.03	74.00	-32.97	Peak

Note:Emission Level=Read Level+Antenna Factor+Cable loss-Preamp Factor

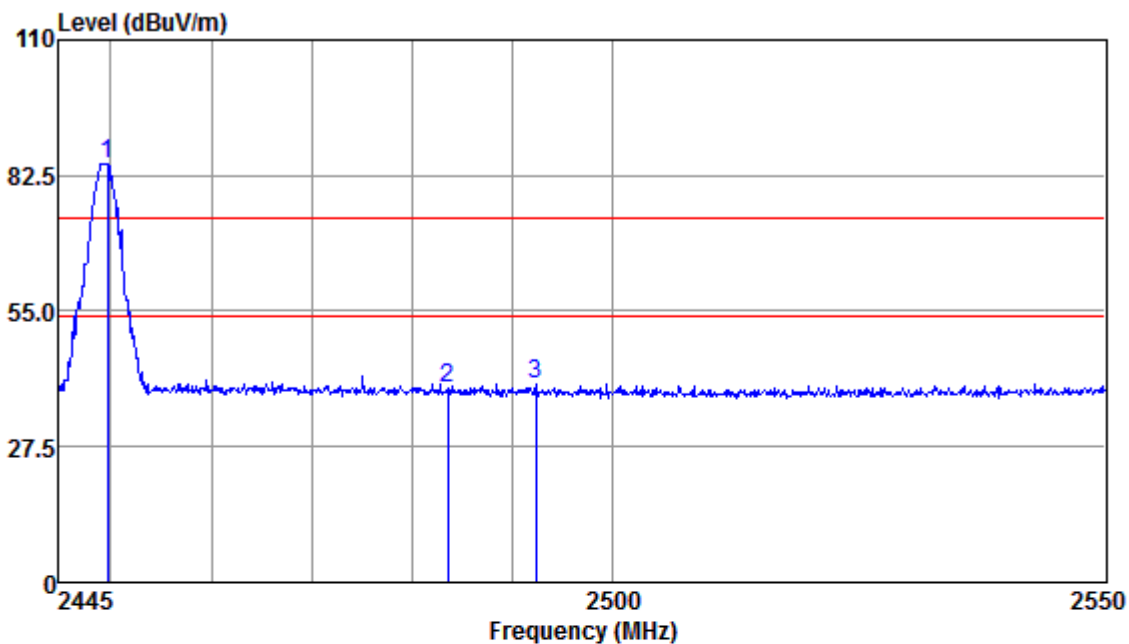

Antenna Polarity :VERTICAL

Freq	Read Level	Antenna Factor	Cable Loss	Preamp Factor	Emission Level	Limit Line	Over Limit	Remark
MHz	dBuv	dB/m	dB	dB	dBuv/m	dBuv/m	dB	
2449.73	93.14	26.13	3.13	37.43	84.97	74.00	10.97	Peak
2483.50	47.57	26.18	3.14	37.51	39.38	74.00	-34.62	Peak
2492.33	48.39	26.19	3.15	37.52	40.21	74.00	-33.79	Peak

Note:Emission Level=Read Level+Antenna Factor+Cable loss-Preamp Factor

### 7.5 Radiated Emissions

Test Requirement 47 CFR Part 15, Subpart C 15.209 & 15.249 (a),(d)

Test Method: ANSI C63.10 (2013) Section 6.4&6.5&6.6

Limit:

Frequency(MHz)	Field strength(microvolts/meter)	Measurement distance(meters)
0.009-0.490	2400/F(kHz)	300
0.490-1.705	24000/F(kHz)	30
1.705-30.0	30	30
30-88	100	3
88-216	150	3
216-960	200	3
Above 960	500	3

Remark: The emission limits shown in the above table are based on measurements employing a CISPR quasi-peak detector except for the frequency bands 9-90kHz, 110-490kHz and above 1000 MHz. Radiated emission limits in these three bands are based on measurements employing an average detector, the peak field strength of any emission shall not exceed the maximum permitted average limits specified above by more than 20 dB under any condition of modulation.

#### 7.5.1 E.U.T. Operation

Operating Environment:

Temperature: 22 °C Humidity: 50 % RH Atmospheric Pressure: 1002 mbar

Test mode a:TX mode\_Keep the EUT in transmitting with modulation mode.

#### 7.5.2 Test Setup Diagram

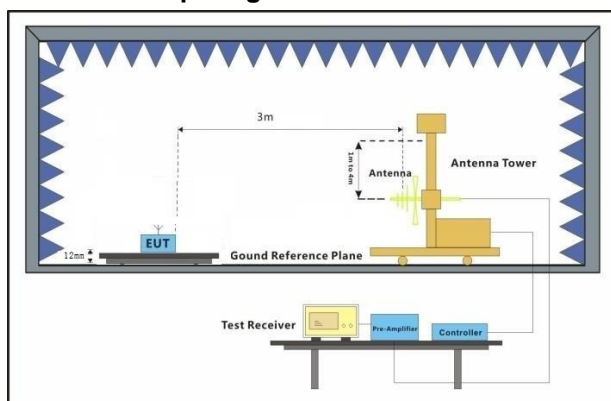

30MHz to 1GHz

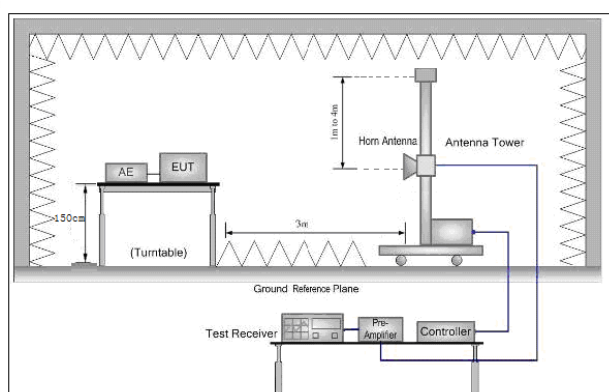

Above 1 GHz

### 7.5.3 Measurement Procedure and Data

- a. For below 1GHz, the EUT was placed on the top of a rotating table 0.8 meters above the ground at a 3 or 10 meter semi-anechoic chamber. The table was rotated 360 degrees to determine the position of the highest radiation.
- b. For above 1GHz, the EUT was placed on the top of a rotating table 1.5 meters above the ground at a 3 meter fully-anechoic chamber. The table was rotated 360 degrees to determine the position of the highest radiation.
- c. The EUT was set 3 or 10 meters away from the interference-receiving antenna, which was mounted on the top of a variable-height antenna tower.
- d. The antenna height is varied from one meter to four meters above the ground to determine the maximum value of the field strength. Both horizontal and vertical polarizations of the antenna are set to make the measurement.
- e. For each suspected emission, the EUT was arranged to its worst case and then the antenna was tuned to heights from 1 meter to 4 meters (for the test frequency of below 30MHz, the antenna was tuned to heights 1 meter) and the rotatable table was turned from 0 degrees to 360 degrees to find the maximum reading.
- f. The test-receiver system was set to Peak Detect Function and Specified Bandwidth with Maximum Hold Mode.
- g. If the emission level of the EUT in peak mode was 10dB lower than the limit specified, then testing could be stopped and the peak values of the EUT would be reported. Otherwise the emissions that did not have 10dB margin would be re-tested one by one using peak, quasi-peak or average method as specified and then reported in a data sheet.
- h. Test the EUT in the lowest channel, the middle channel, the Highest channel.
- i. The radiation measurements are performed in X, Y, Z axis positioning for Transmitting mode, and found the X axis positioning which it is the worst case.
- j. Repeat above procedures until all frequencies measured was complete.

#### Remark:

- 1) For emission below 1GHz, through pre-scan found the worst case is the lowest channel. Only the worst case is recorded in the report.
- 2) The field strength is calculated by adding the Antenna Factor, Cable Factor & Preamplifier. The basic equation with a sample calculation is as follows:  
Final Test Level = Receiver Reading + Antenna Factor + Cable Factor – Preamplifier Factor
- 3) Scan from 9kHz to 25GHz, the disturbance above 18GHz and below 30MHz was very low. The points marked on above plots are the highest emissions could be found when testing, so only above points had been displayed. The amplitude of spurious emissions from the radiator which are attenuated more than 20dB below the limit need not be reported.
- 4) For frequencies above 1GHz, the field strength limits are based on average limits. However, the peak field strength of any emission shall not exceed the maximum permitted average limits specified above by more than 20 dB under any condition of modulation. For the emissions whose peak level is lower than the average limit, only the peak measurement is shown



30MHz-1GHz:

Mode:a; Polarization:Horizontal

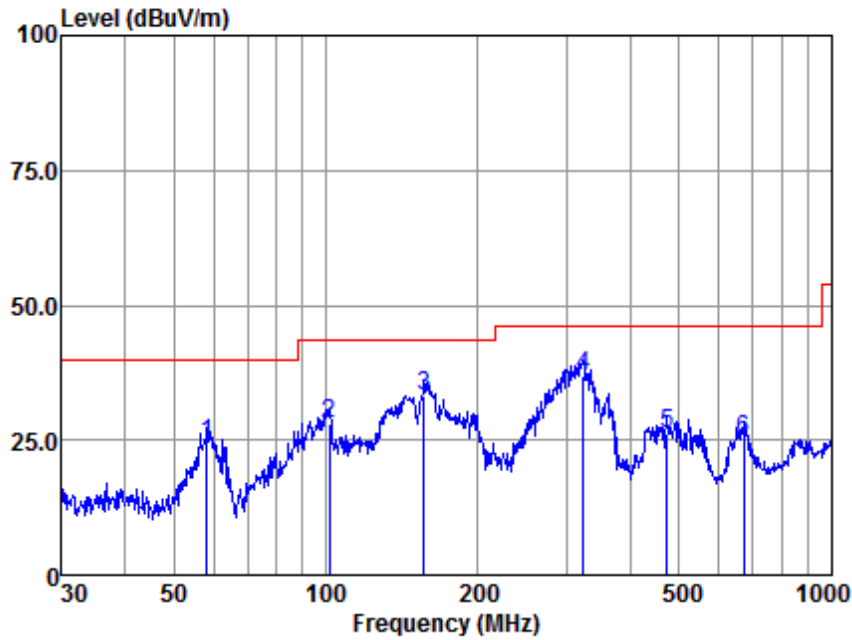

Antenna Polarity :HORIZONTAL  
EUT/Project :0004CR  
Test mode :a

	Read	Antenna	Cable	Preamp	Emission	Limit	Over	
Freq	Level	Factor	Loss	Factor	Level	Line	Limit	Remark
MHz	dBuv	dB/m	dB	dB	dBuv/m	dBuv/m	dB	
1	58.20	54.93	12.25	0.89	43.75	24.32	40.00	-15.68 QP
2	101.64	61.50	9.52	0.78	43.73	28.07	43.50	-15.43 QP
3	156.46	63.78	12.70	0.53	43.74	33.27	43.50	-10.23 QP
4	323.32	66.22	13.69	0.71	43.59	37.03	46.00	-8.97 QP
5	473.83	52.03	16.70	0.97	43.38	26.32	46.00	-19.68 QP
6	670.49	46.44	19.98	1.79	43.22	24.99	46.00	-21.01 QP

Note:Emission Level=Read Level+Antenna Factor+Cable loss-Preamp Factor

Mode:a; Polarization:Vertical

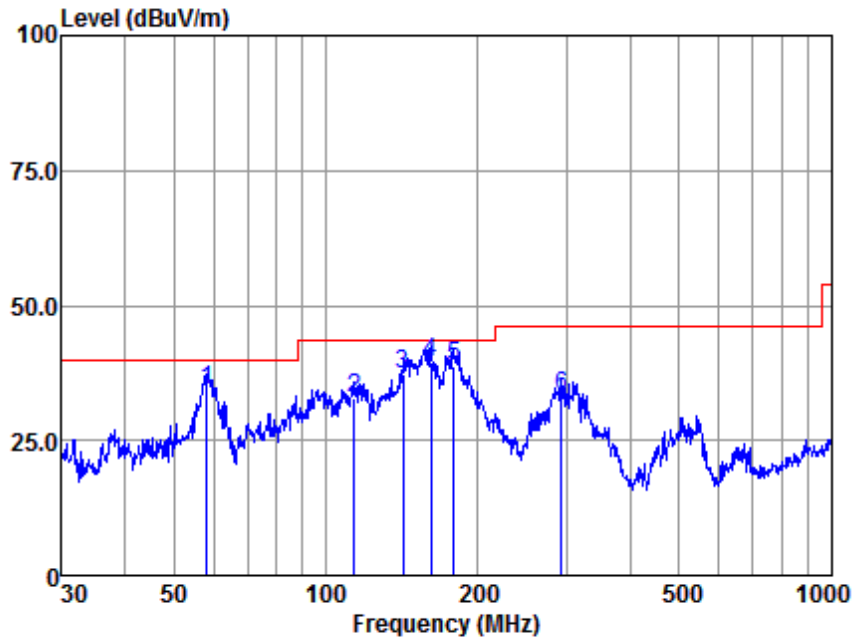

Antenna Polarity :VERTICAL  
EUT/Project :0004CR  
Test mode :a

	Freq	Read Level	Antenna Factor	Cable Loss	Preamp Factor	Emission Level	Limit Line	Over Limit	Remark
	MHz	dBuv	dB/m	dB	dB	dBuv/m	dBuv/m	dB	
1	58.20	64.94	12.25	0.89	43.75	34.33	40.00	-5.67	QP
2	113.71	66.07	9.75	0.71	43.74	32.79	43.50	-10.71	QP
3	142.32	68.99	11.45	0.59	43.73	37.30	43.50	-6.20	QP
4	161.47	69.97	12.85	0.51	43.75	39.58	43.50	-3.92	QP
5	179.39	70.36	11.88	0.45	43.80	38.89	43.50	-4.61	QP
6	293.08	63.15	12.97	0.64	43.67	33.09	46.00	-12.91	QP

Note:Emission Level=Read Level+Antenna Factor+Cable loss-Preamp Factor

Above 1GHz:

2414.5MHz:

Mark	Frequency (MHz)	Reading (dBuV)	Factor (dB)	Emission (dBuV/m)	Limit (dBuV/m)	Over Limit (dB)	Detector	Polarization
1	4832	42.75	6.40	49.15	54	-4.85	peak	Horizontal
2	7246	38.24	10.76	49.00	54	-5.00	peak	Horizontal
3	9663	37.28	14.37	51.65	54	-2.35	peak	Horizontal
4	4826	42.19	6.40	48.59	54	-5.41	peak	Vertical
5	7248	37.49	10.76	48.25	54	-5.75	peak	Vertical
6	9659	32.27	14.37	46.64	54	-7.36	peak	Vertical

2434.5MHz:

Mark	Frequency (MHz)	Reading (dBuV)	Factor (dB)	Emission (dBuV/m)	Limit (dBuV/m)	Over Limit (dB)	Detector	Polarization
1	4863	38.44	6.92	45.36	54	-8.64	peak	Horizontal
2	7312	35.08	11.08	46.16	54	-7.84	peak	Horizontal
3	9745	33.68	14.36	48.04	54	-5.96	peak	Horizontal
4	4868	41.60	6.92	48.52	54	-5.48	peak	Vertical
5	7303	36.51	11.08	47.59	54	-6.41	peak	Vertical
6	9734	34.12	14.36	48.48	54	-5.52	peak	Vertical

2449.5MHz:

Mark	Frequency (MHz)	Reading (dBuV)	Factor (dB)	Emission (dBuV/m)	Limit (dBuV/m)	Over Limit (dB)	Detector	Polarization
1	4915	40.38	7.31	47.69	54	-6.31	peak	Horizontal
2	7376	39.96	11.41	51.37	54	-2.63	peak	Horizontal
3	9835	33.76	14.38	48.14	54	-5.86	peak	Horizontal
4	4924	41.03	7.31	48.34	54	-5.66	peak	Vertical
5	7386	37.5	11.41	48.91	54	-5.09	peak	Vertical
6	9848	35.28	14.38	49.66	54	-4.34	peak	Vertical

### 7.6 99% Bandwidth

Test Requirement      RSS-Gen Section 6.6  
 Test Method:          RSS-Gen Section 6.7  
 Limit:                  N/A

#### 7.6.1 E.U.T. Operation

Operating Environment:

Temperature: 20 °C      Humidity: 50 % RH      Atmospheric Pressure: 1010 mbar

Test mode              a:TX mode\_Keep the EUT in transmitting with modulation mode.

#### 7.6.2 Test Setup Diagram

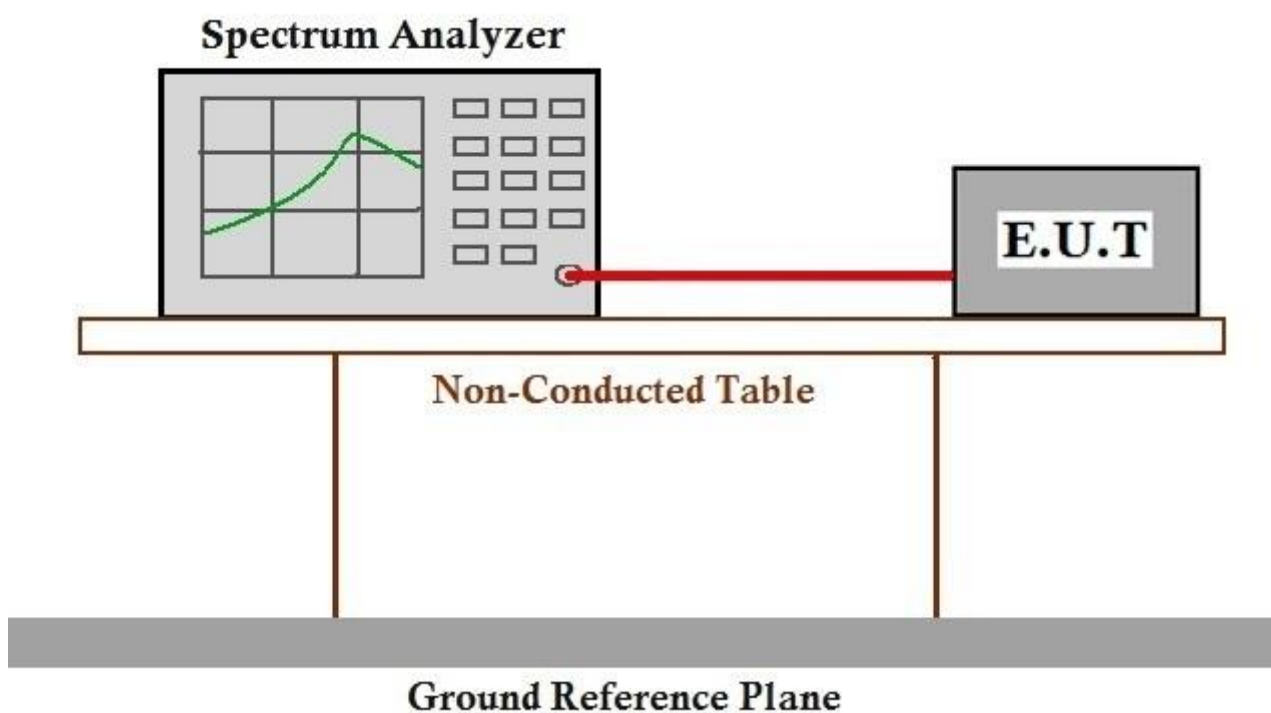

#### 7.6.3 Measurement Procedure and Data

- 1.Remove the antenna from the EUT and then connect a low RF cable from the antenna port to the spectrum;
- 2.Set the spectrum analyzer: Span = approximately 2 to 3 times the 20dB bandwidth, centred on the hopping channel;
- 3.Set the spectrum analyzer: RBW = 1% of the span (set 30 kHz). VBW >= RBW. Sweep = auto; Detector Function = Peak. Trace = Max Hold.
- 4.Mark the peak frequency and using the 99% OBW function measure the bandwidth.

Frequency (MHz)	Bandwidth (MHz)	Result
2414.5	0.762	PASS
2434.5	0.810	PASS
2449.5	0.762	PASS

Test plot as follows:

Channel: 2414.5MHz

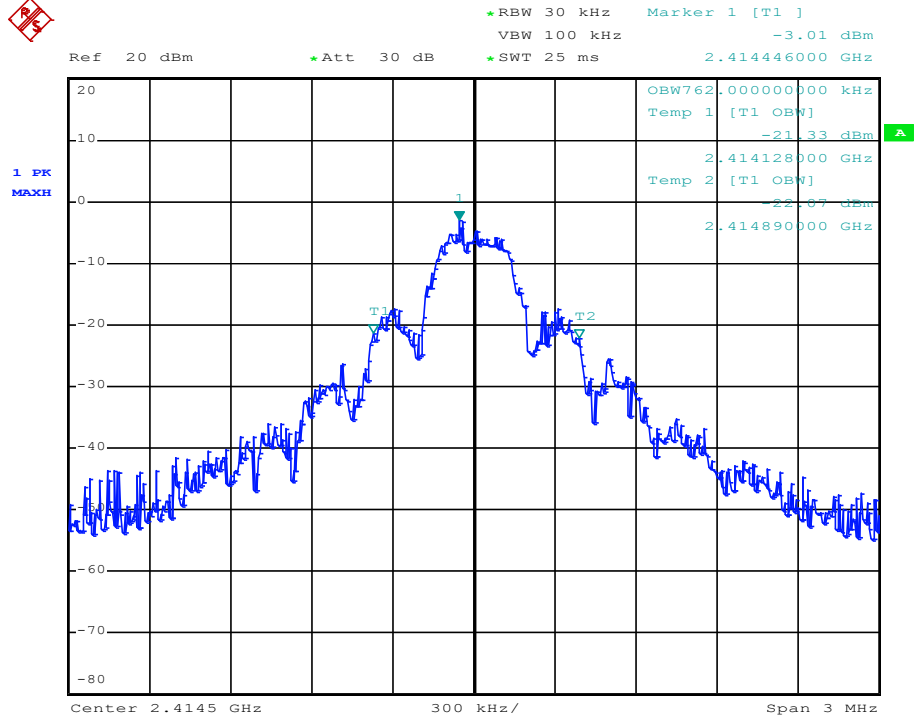

Channel: 2434.5MHz

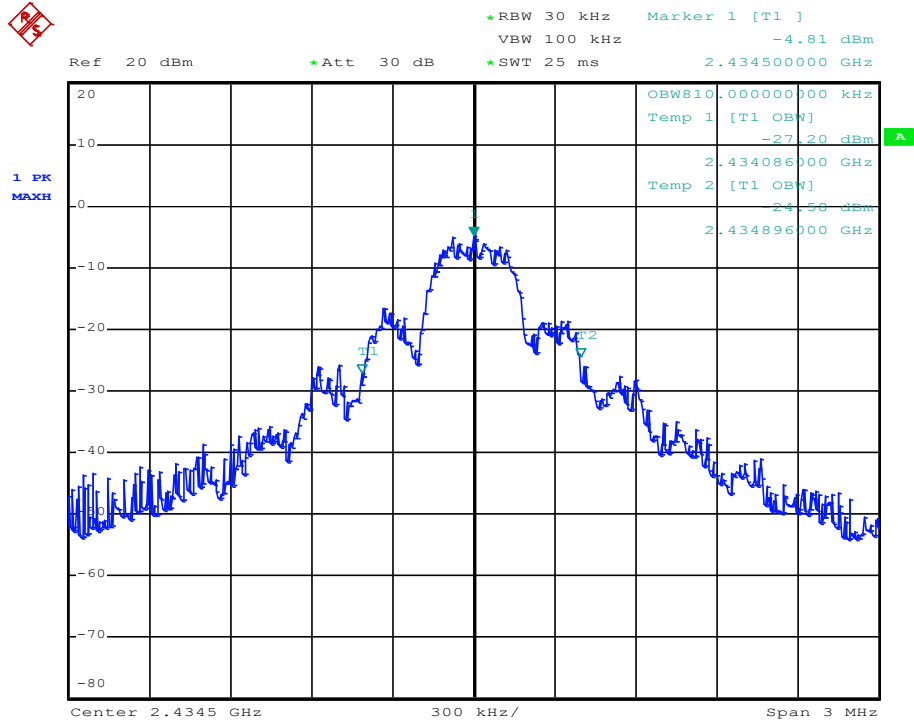

Channel: 2449.5MHz

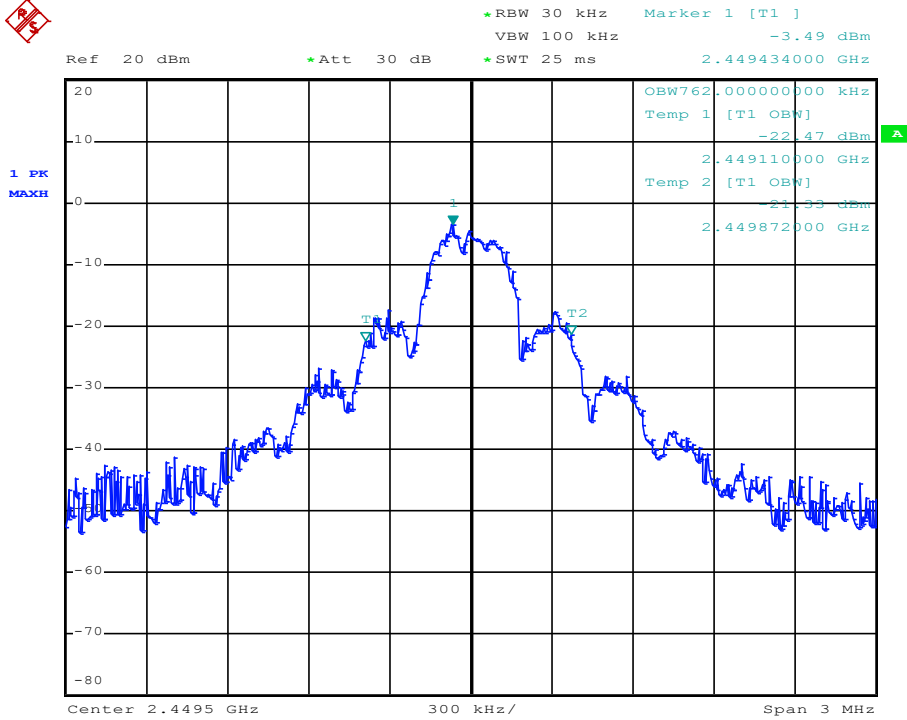



### 7.7 Frequency tolerance

Test Requirement      RSS-210 A2.6 (a)  
 Test Method:            RSS-210 A2.6 (a)  
 Limit:                    1.356kHz

#### 7.7.1 E.U.T. Operation

Operating Environment:

Temperature:    20 °C            Humidity: 50 % RH            Atmospheric Pressure: 1010 mbar

Test mode            a:TX mode\_Keep the EUT in transmitting with modulation mode.

#### 7.7.2 Test Setup Diagram

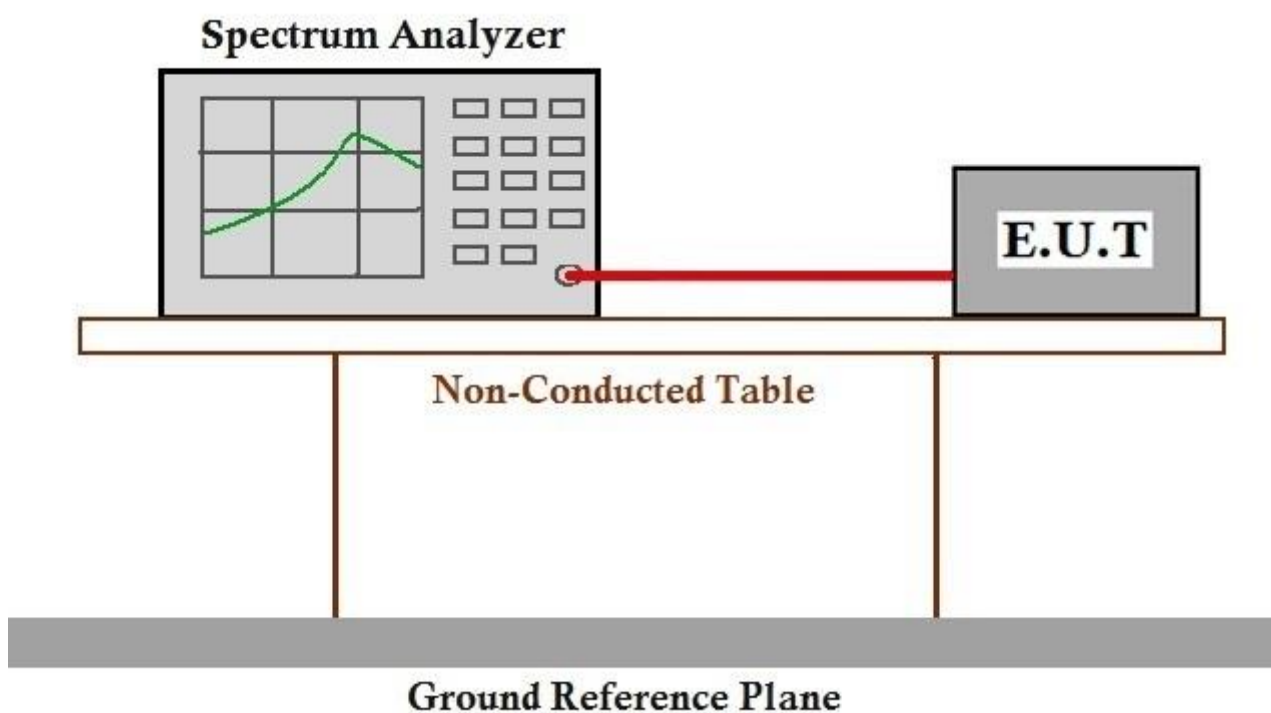

#### 7.7.3 Measurement Procedure and Data

Note: Frequency stability requested in RSS GEN S8.11 has been complied since the result of band edge can demonstrate.



## 8 Test Setup Photographs

Refer to the < Test Setup photos-FCC>.

## 9 EUT Constructional Details

Refer to the < External Photos > & < Internal Photos >.

**- End of the Report -**