



FCC/IC - TEST REPORT

Report Number : **68.950.18.0123.01** Date of Issue: April 11, 2018

Model : K-10349

Product Type : Heated Toilet Seat

Applicant : Kohler Co.

Address : 444 Highland Drive

Manufacturer : Zhongshan Meitu plastic Industrial Co.,Ltd

Address : Dache Industrial area, Nanlang town, Zhongshan City

Test Result : Positive Negative

Total pages including Appendices : 32

TÜV SÜD Certification and Testing (China) Co., Ltd. Shenzhen Branch is a subcontractor to TÜV SÜD Product Service GmbH according to the principles outlined in ISO 17025.

TÜV SÜD Certification and Testing (China) Co., Ltd. Shenzhen Branch reports apply only to the specific samples tested under stated test conditions. Construction of the actual test samples has been documented. It is the manufacturer's responsibility to assure that additional production units of this model are manufactured with identical electrical and mechanical components. The manufacturer/importer is responsible to the Competent Authorities in Europe for any modifications made to the production units which result in non-compliance to the relevant regulations. TÜV SÜD Certification and Testing (China) Co., Ltd. Shenzhen Branch shall have no liability for any deductions, inferences or generalizations drawn by the client or others from TÜV SÜD Certification and Testing (China) Co., Ltd. Shenzhen Branch issued reports.

This report is the confidential property of the client. As a mutual protection to our clients, the public and ourselves, extracts from the test report shall not be reproduced except in full without our written approval.



1 Table of Contents

1	Table of Contents.....	2
2	Details about the Test Laboratory.....	3
3	Description of the Equipment Under Test	4
4	Summary of Test Standards.....	5
5	Summary of Test Results	6
6	General Remarks.....	7
7	Test Setups	8
8	Systems test configuration	10
9	Technical Requirement	11
9.1	Conducted Emission.....	11
9.2	Conducted peak output power	14
9.3	Power spectral density.....	17
9.4	6 dB Bandwidth and 99% Occupied Bandwidth.....	20
9.5	Spurious RF conducted emissions	23
9.6	Band edge.....	27
9.7	Spurious radiated emissions for transmitter.....	29
10	Test Equipment List.....	32



2 Details about the Test Laboratory

Details about the Test Laboratory

Test Site 1

Company name: TÜV SÜD Certification and Testing (China) Co., Ltd. Shenzhen Branch
Building 12 & 13, Zhiheng Wisdomland Business Park, Nantou Checkpoint
Road 2, Nanshan District
Shenzhen 518052
P.R. China

Telephone: 86 755 8828 6998

Fax: 86 755 828 5299

FCC Registration 514049

No.:

IC Registration 10320A

No.:



3 Description of the Equipment Under Test

Product:	Heated Toilet Seat
Model no.:	K-10349
FCC ID:	N82-KOHLER023
IC:	4554A-KOHLER023
Options and accessories:	Adapter
Rating:	AC 100V-240V~50/60Hz
RF Transmission Frequency:	2402MHz-2480MHz
No. of Operated Channel:	40
Modulation:	GFSK
Antenna Type:	Internal Antenna
Antenna Gain:	2.62dBi
Description of the EUT:	The Equipment Under Test (EUT) is Heated Toilet Seat operated at 2.4GHz



4 Summary of Test Standards

Test Standards	
FCC Part 15 Subpart C 10-1-2017 Edition	PART 15 - RADIO FREQUENCY DEVICES Subpart C - Intentional Radiators
RSS-Gen Issue 5 April 2018	General Requirements for Compliance of Radio Apparatus
RSS-247 Issue 2 February 2017	Digital Transmission Systems (DTSS), Frequency Hopping Systems (FHSS) and License-Exempt Local Area Network (LE-LAN) Devices

All the test methods were according to KDB 558074 D01 DTS Measurement Guidance v04 DTS Measurement Guidance and ANSI C63.10 (2013).

5 Summary of Test Results

Technical Requirements						
FCC Part 15 Subpart C/RSS-247 Issue 2/RSS-Gen Issue 5						
Test Condition			Test Site	Test Result		
				Pass	Fail	N/A
§15.207	RSS-Gen, 8.8	Conducted emission AC power port	Site 1	<input checked="" type="checkbox"/>	<input type="checkbox"/>	<input type="checkbox"/>
§15.247 (b) (1)	RSS-247 5.4(d)	Conducted peak output power	Site 1	<input checked="" type="checkbox"/>	<input type="checkbox"/>	<input type="checkbox"/>
§15.247(a)(1)	RSS-247 5.1(a) & RSS-Gen 6.6	20dB bandwidth	---	<input type="checkbox"/>	<input type="checkbox"/>	<input checked="" type="checkbox"/>
§15.247(a)(1)	RSS-247 5.1(b)	Carrier frequency separation	---	<input type="checkbox"/>	<input type="checkbox"/>	<input checked="" type="checkbox"/>
§15.247(a)(1)(iii)	RSS-247 5.1(d)	Number of hopping frequencies	---	<input type="checkbox"/>	<input type="checkbox"/>	<input checked="" type="checkbox"/>
§15.247(a)(1)(iii)	RSS-247 5.1(d)	Dwell Time	---	<input type="checkbox"/>	<input type="checkbox"/>	<input checked="" type="checkbox"/>
§15.247(a)(2)	RSS-247 5.2(a)	6dB bandwidth and 99% Occupied Bandwidth	Site 1	<input checked="" type="checkbox"/>	<input type="checkbox"/>	<input type="checkbox"/>
§15.247(e)	RSS-247 5.2(b)	Power spectral density	Site 1	<input checked="" type="checkbox"/>	<input type="checkbox"/>	<input type="checkbox"/>
§15.247(d)	RSS-247 5.5	Spurious RF conducted emissions	Site 1	<input checked="" type="checkbox"/>	<input type="checkbox"/>	<input type="checkbox"/>
§15.247(d)	RSS-247 5.5	Band edge	Site 1	<input checked="" type="checkbox"/>	<input type="checkbox"/>	<input type="checkbox"/>
§15.247(d) & §15.209	RSS-247 5.5 & RSS-Gen 6.13	Spurious radiated emissions for transmitter	Site 1	<input checked="" type="checkbox"/>	<input type="checkbox"/>	<input type="checkbox"/>
§15.203	RSS-Gen 6.8	Antenna requirement	See note 1	<input checked="" type="checkbox"/>	<input type="checkbox"/>	<input type="checkbox"/>

Note 1: N/A=Not Applicable.

Note 2: The EUT uses an Integrated antenna, which gain is 2.62dBi. In accordance to §15.203 & RSS-Gen 6.8, it is considered sufficiently to comply with the provisions of this section.



6 General Remarks

Remarks

This submittal(s) (test report) is intended for FCC ID: N82-KOHLER023, IC: 4554A-KOHLER023 complies with Section 15.207, 15.209, 15.247 of the FCC Part 15, Subpart C, RSS-247 and RSS-Gen rules.

SUMMARY:

All tests according to the regulations cited on page 5 were

n - Performed

o - **Not** Performed

The Equipment under Test

n - **Fulfills** the general approval requirements.

o - **Does not** fulfill the general approval requirements.

Sample Received Date: March 26, 2018

Testing Start Date: March 28, 2018

Testing End Date: April 11, 2018

TÜV SÜD Certification and Testing (China) Co., Ltd. Shenzhen Branch

Tested by: Louise Liu 2018-07-30

Louise Liu

Prepared by: Moon Xiong 2018-07-30

Moon

Reviewed by: John Zhi 2018-07-30

John Zhi

7 Test Setups

Below 1GHz

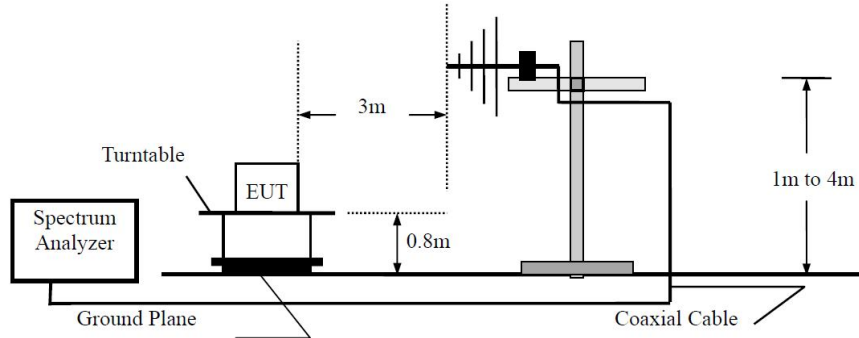

Above 1GHz

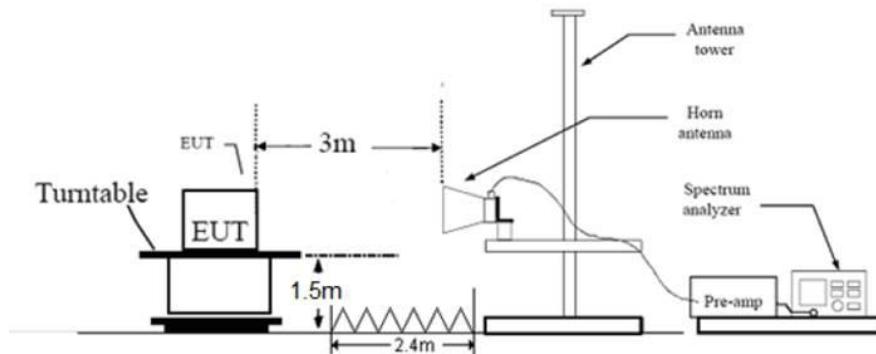

Conducted RF test setups

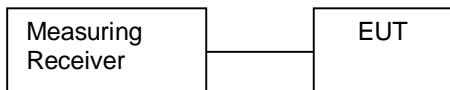

AC Power Line Conducted Emission test setups

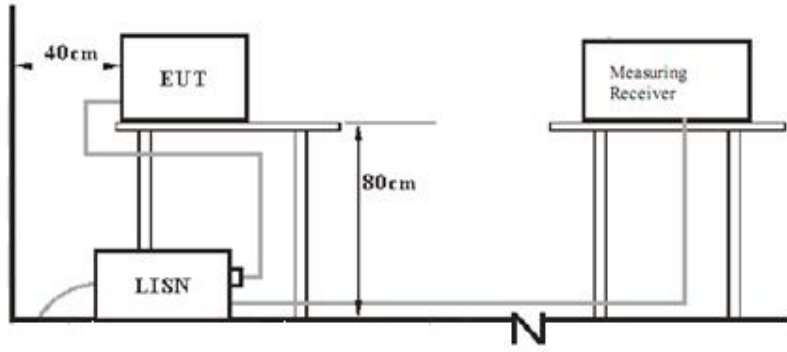



8 Systems test configuration

The system was configured to channel 0, 19, and 39 for the test.

9 Technical Requirement

9.1 Conducted Emission

Test Method

1. The EUT was placed on a table, which is 0.8m above ground plane
2. The power line of the EUT is connected to the AC mains through a Artificial Mains Network (A.M.N.).
3. Maximum procedure was performed to ensure EUT compliance
4. A EMI test receiver is used to test the emissions from both sides of AC line

Limit

Frequency MHz	QP Limit dB μ V	AV Limit dB μ V
0.150-0.500	66-56*	56-46*
0.500-5	56	46
5-30	60	50

*Decreases with the logarithm of the frequency.



M/N : K-10349
 Operating Condition : BT link and warming and lighting
 Comment : AC 120V/60Hz

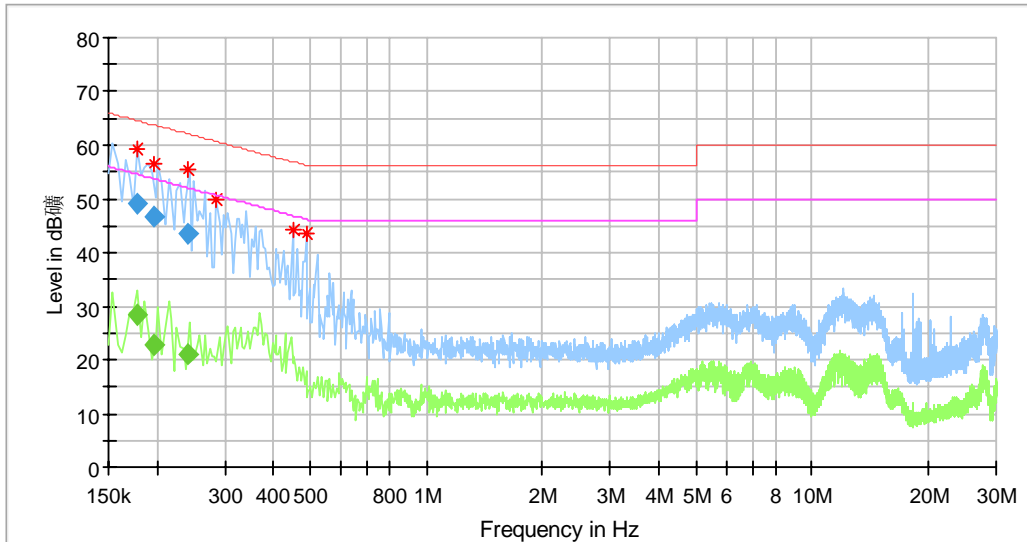

Critical_Freqs

Frequency (MHz)	MaxPeak (dBµV)	Average (dBµV)	Limit (dBµV)	Margin (dB)	Line	Corr. (dB)
0.177500	59.37	---	64.58	5.20	L1	10.2
0.197500	56.51	---	63.53	7.01	L1	10.2
0.241500	55.36	---	62.03	6.67	L1	10.2
0.286000	49.92	---	60.64	10.72	L1	10.2
0.450000	44.06	---	56.88	12.81	L1	11.0
0.486000	43.35	---	56.24	12.88	L1	10.4

Final_Result

Frequency (MHz)	QuasiPeak (dBµV)	Average (dBµV)	Limit (dBµV)	Margin (dB)	Line	Corr. (dB)
0.177500	---	28.45	54.60	26.15	L1	10.2
0.177500	49.28	---	64.60	15.32	L1	10.2
0.197500	---	22.65	53.72	31.07	L1	10.2
0.197500	46.84	---	63.72	16.88	L1	10.2
0.241500	---	21.21	52.04	30.83	L1	10.2
0.241500	43.60	---	62.04	18.44	L1	10.2

Remark: Correct factor=cable loss + LISN factor

M/N : K-10349
 Operating Condition : BT link and warming and lighting
 Comment : AC 120V/60Hz

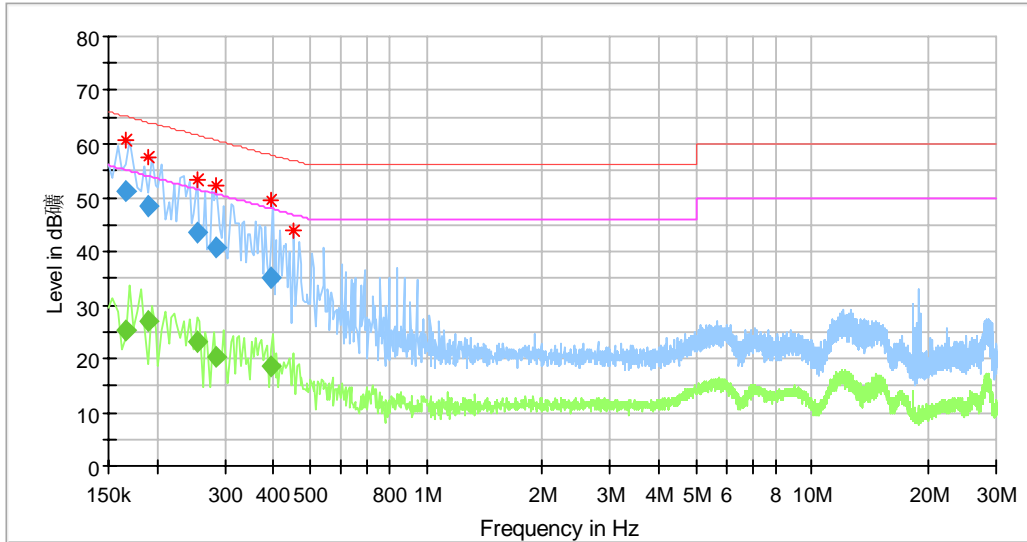

Critical_Freqs

Frequency (MHz)	MaxPeak (dBµV)	Average (dBµV)	Limit (dBµV)	Margin (dB)	Line	Corr. (dB)
0.165500	60.69	---	64.96	4.27	N	10.3
0.189500	57.57	---	63.86	6.30	N	10.3
0.253500	53.33	---	61.63	8.30	N	10.3
0.285500	52.18	---	60.64	8.46	N	10.3
0.393500	49.51	---	57.90	8.38	N	10.3
0.454000	43.75	---	56.80	13.05	N	10.3

Final_Result

Frequency (MHz)	QuasiPeak (dBµV)	Average (dBµV)	Limit (dBµV)	Margin (dB)	Line	Corr. (dB)
0.165500	---	25.37	55.18	29.81	N	10.3
0.165500	51.24	---	65.18	13.94	N	10.3
0.189500	---	26.87	54.06	27.19	N	10.3
0.189500	48.43	---	64.06	15.63	N	10.3
0.253500	---	23.08	51.64	28.56	N	10.3
0.253500	43.64	---	61.64	18.00	N	10.3
0.285500	---	20.49	50.65	30.16	N	10.3
0.285500	40.66	---	60.65	19.99	N	10.3
0.393500	---	18.62	47.99	29.37	N	10.3
0.393500	34.95	---	57.99	23.04	N	10.3

Remark: Correct factor=cable loss + LISN factor



9.2 Conducted peak output power

Test Method

1. Use the following spectrum analyzer settings:
 RBW > the 6 dB bandwidth of the emission being measured, VBW ≥ 3RBW, Span ≥ 3RBW
 Sweep = auto, Detector function = peak, Trace = max hold.
2. Add a correction factor to the display.
3. Allow the trace to stabilize. Use the marker-to-peak function to set the marker to the peak of the emission. The indicated level is the peak output power.

Limits

According to §15.247 (b) (1) & RSS-247 5.4(d), conducted peak output power limit as below:

Frequency Range MHz	Limit W	Limit dBm
2400-2483.5	≤1	≤30

Test result as below table

Frequency MHz	Conducted Peak Output Power dBm	Result
Bottom channel 2402MHz	0.88	Pass
Middle channel 2440MHz	0.89	Pass
Top channel 2480MHz	0.75	Pass



Low channel 2402MHz

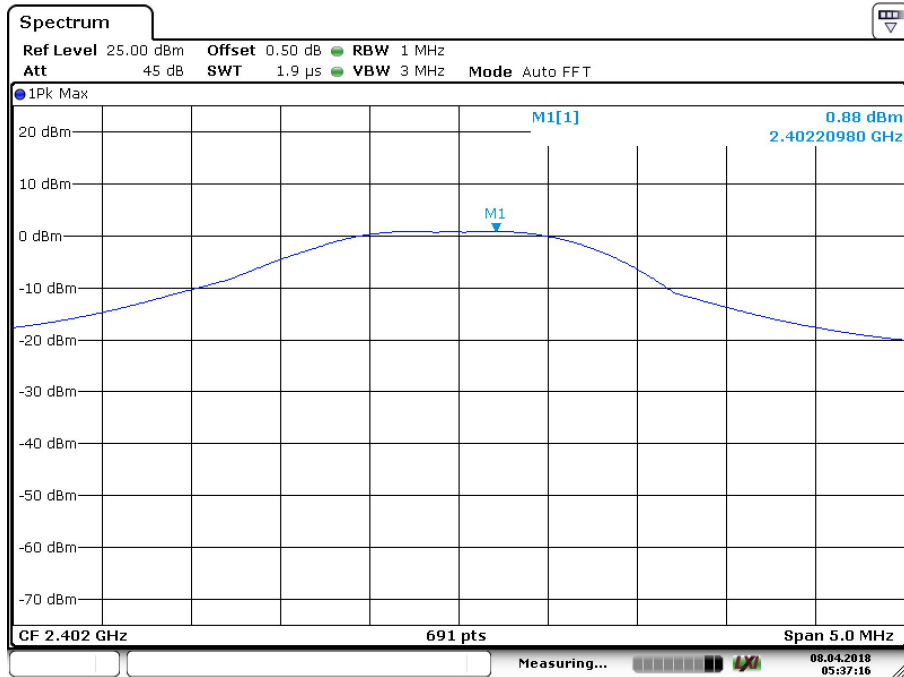

Date: 8.APR.2018 05:37:16

Middle channel 2440MHz

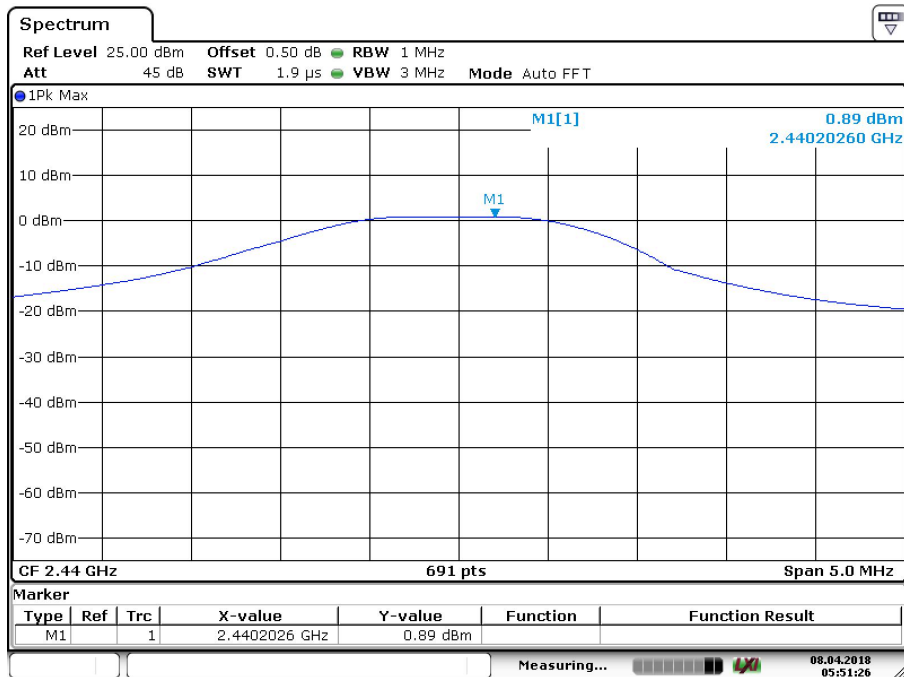

Date: 8.APR.2018 05:51:26



9.3 Power spectral density

Test Method

This procedure shall be used if maximum peak conducted output power was used to demonstrate compliance:

1. Set analyzer center frequency to DTS channel center frequency. RBW=3kHz, VBW≥3RBW, Span=1.5 times DTS bandwidth, Detector=Peak, Sweep=auto, Trace= max hold.
2. Allow trace to fully stabilize, use the peak marker function to determine the maximum amplitude level within the RBW.
3. Repeat above procedures until other frequencies measured were completed.

Limit

Limit [dBm]

≤8

Test result

Frequency MHz	Power spectral density dBm	Result
Top channel 2402MHz	-13.86	Pass
Middle channel 2440MHz	-13.84	Pass
Bottom channel 2480MHz	-13.76	Pass



Low channel 2402MHz

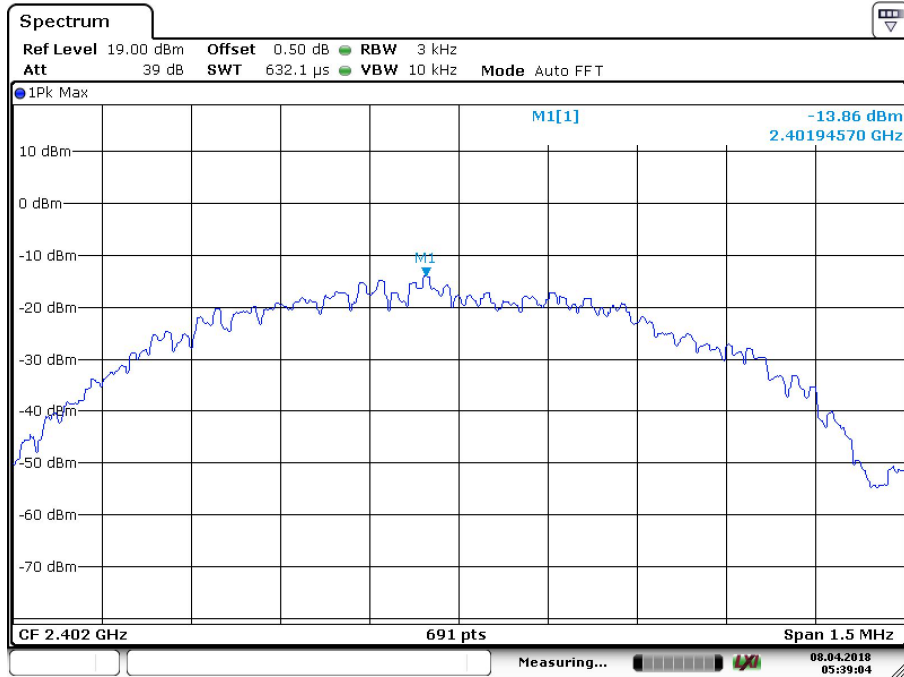

Date: 8.APR.2018 05:39:04

Middle channel 2440MHz

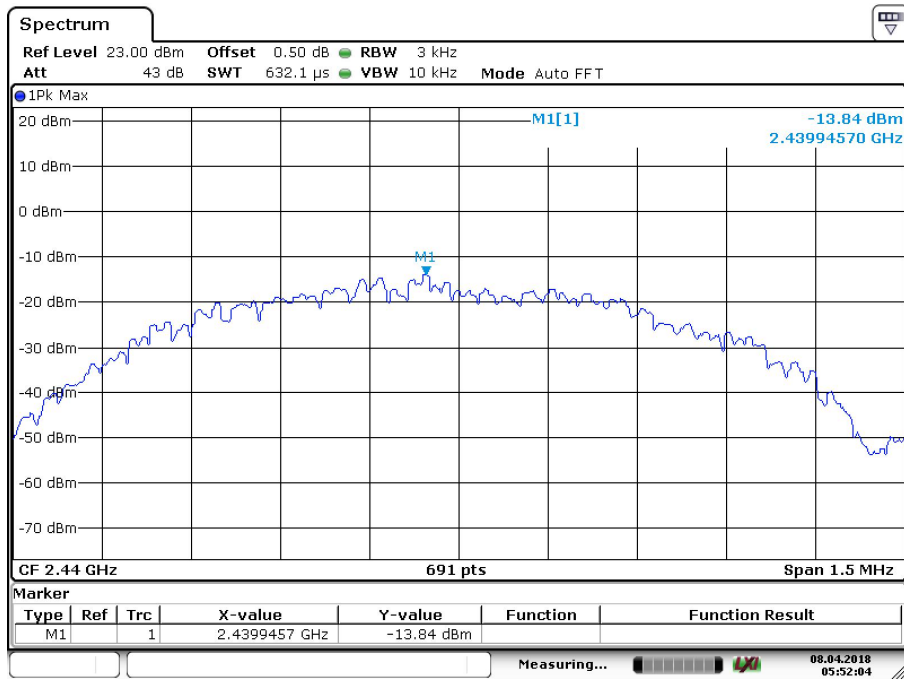

Date: 8.APR.2018 05:52:04



High channel 2480MHz

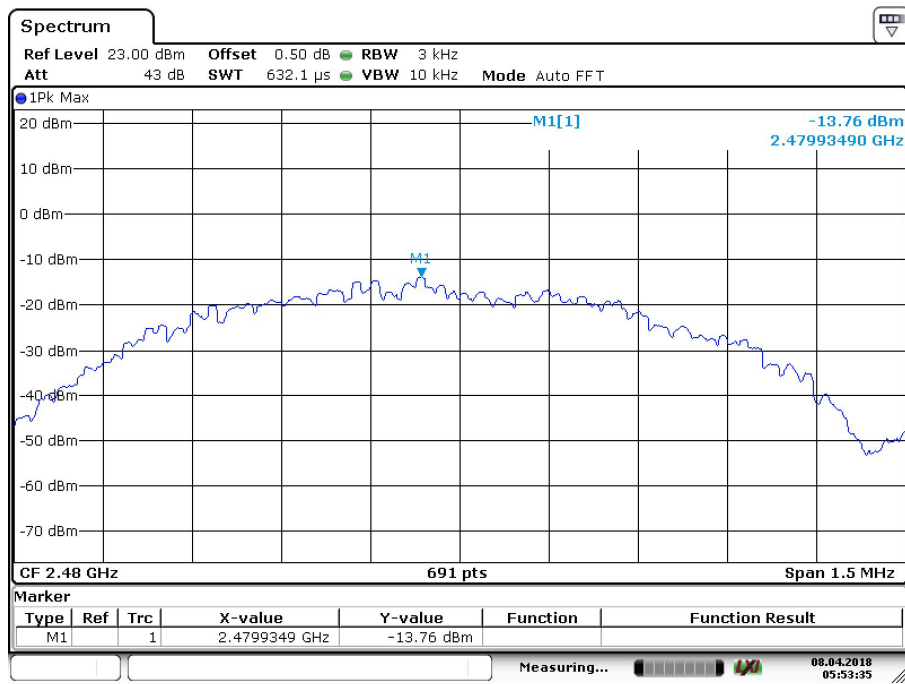

Date: 8.APR.2018 05:53:34



9.4 6 dB Bandwidth and 99% Occupied Bandwidth

Test Method

1. Use the following spectrum analyzer settings:
RBW=100K, VBW≥3RBW, Sweep = auto, Detector function = peak, Trace = max hold
2. Use the automatic bandwidth measurement capability of an instrument, may be employed using the X dB bandwidth mode with X set to 6 dB, care shall be taken so that the bandwidth measurement is not influenced by any intermediate power nulls in the fundamental emission that might be ≥ 6 dB.
3. Allow the trace to stabilize, record the X dB Bandwidth value.

Limit

Limit [kHz]

≥500

Test result

Frequency MHz	6dB bandwidth kHz	99% bandwidth kHz	Result
Bottom channel 2402MHz	738.1	1121.56	Pass
Middle channel 2440MHz	733.7	1098.41	Pass
Top channel 2480MHz	723.6	1114.33	Pass



6 dB Bandwidth & 99% Occupied Bandwidth

Low channel 2402MHz

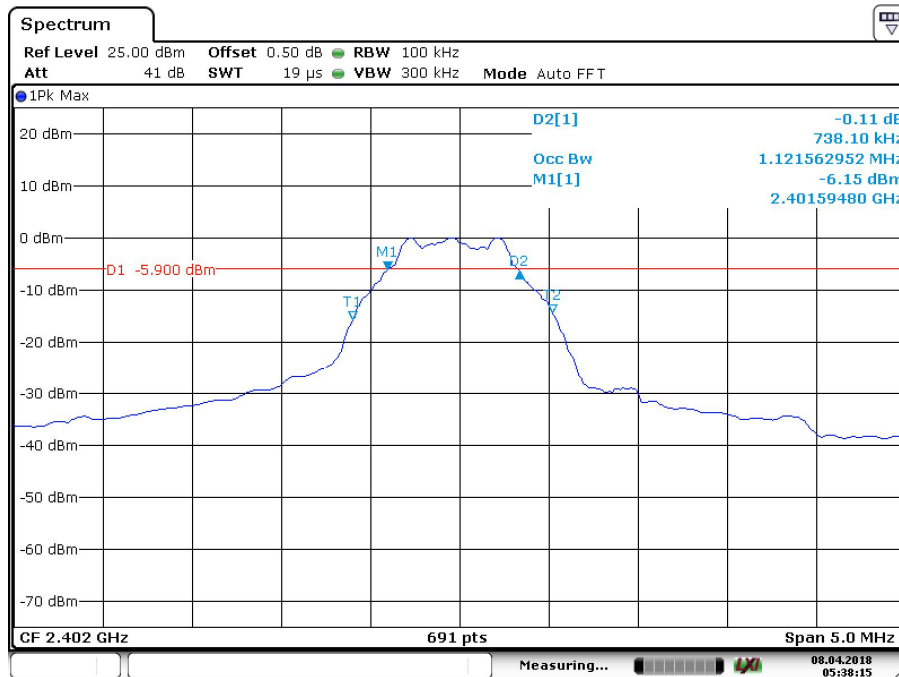

Date: 8.APR.2018 05:38:15

Middle channel 2440MHz

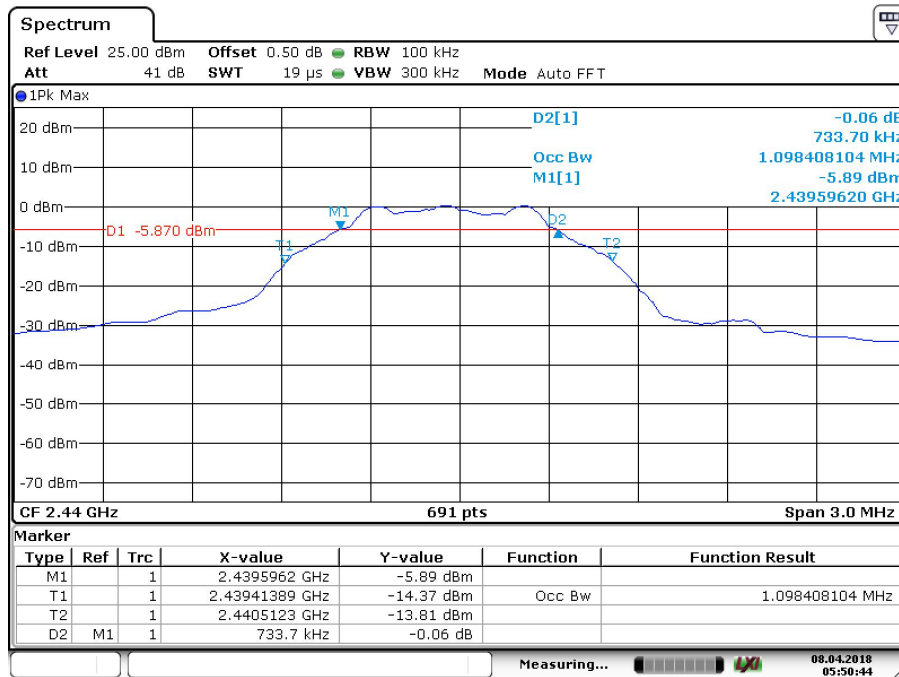

Date: 8.APR.2018 05:50:44



High channel 2480MHz

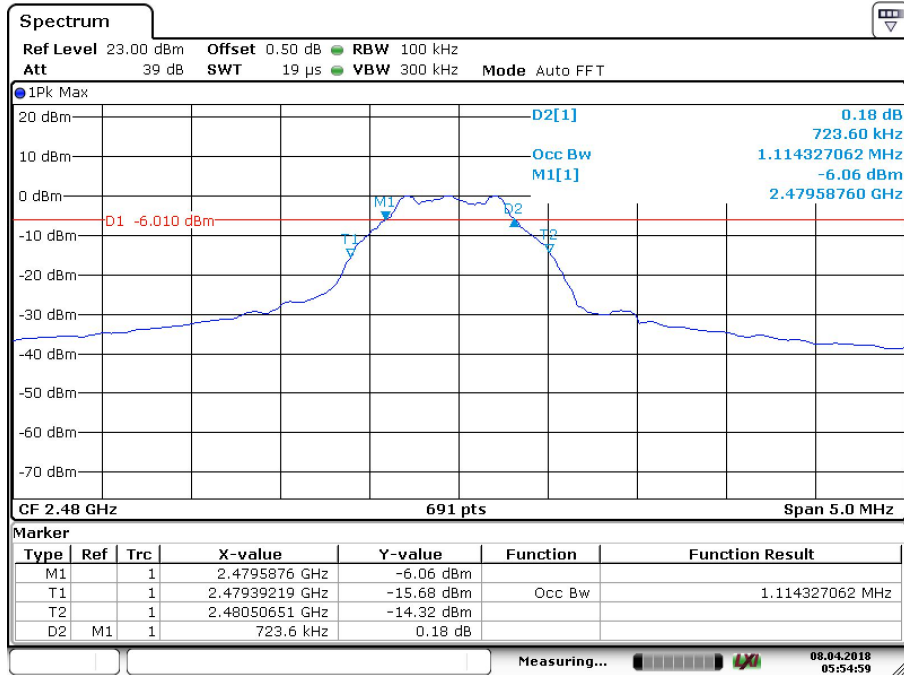

Date: 8.APR.2018 05:54:59



9.5 Spurious RF conducted emissions

Test Method

1. Establish a reference level by using the following procedure:
 - a. Set RBW=100 kHz. VBW≥3RBW. Detector =peak, Sweep time = auto couple, Trace mode = max hold.
 - b. Allow trace to fully stabilize, use the peak marker function to determine the maximum PSD level.
2. Use the maximum PSD level to establish the reference level.
 - a. Set the center frequency and span to encompass frequency range to be measured.
 - b. Use the peak marker function to determine the maximum amplitude level. Ensure that the amplitude of all unwanted emissions outside of the authorized frequency band (excluding restricted frequency bands) are attenuated by at least the minimum requirements, report the three highest emissions relative to the limit.
3. Repeat above procedures until other frequencies measured were completed.

Limit

Frequency Range MHz	Limit (dBc)
30-25000	-20



Spurious RF conducted emissions

2402MHz

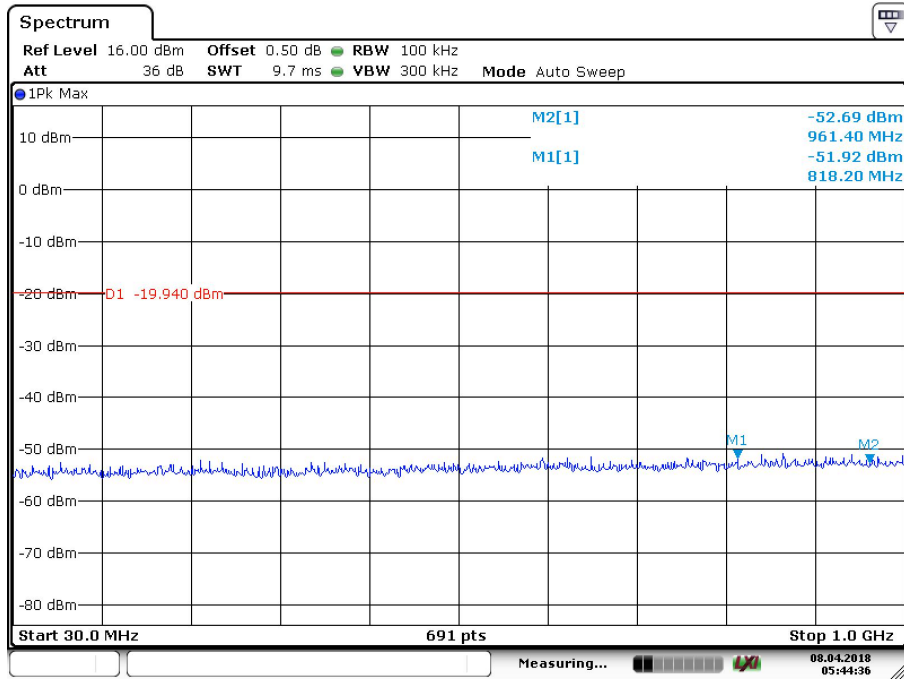

Date: 8.APR.2018 05:44:36

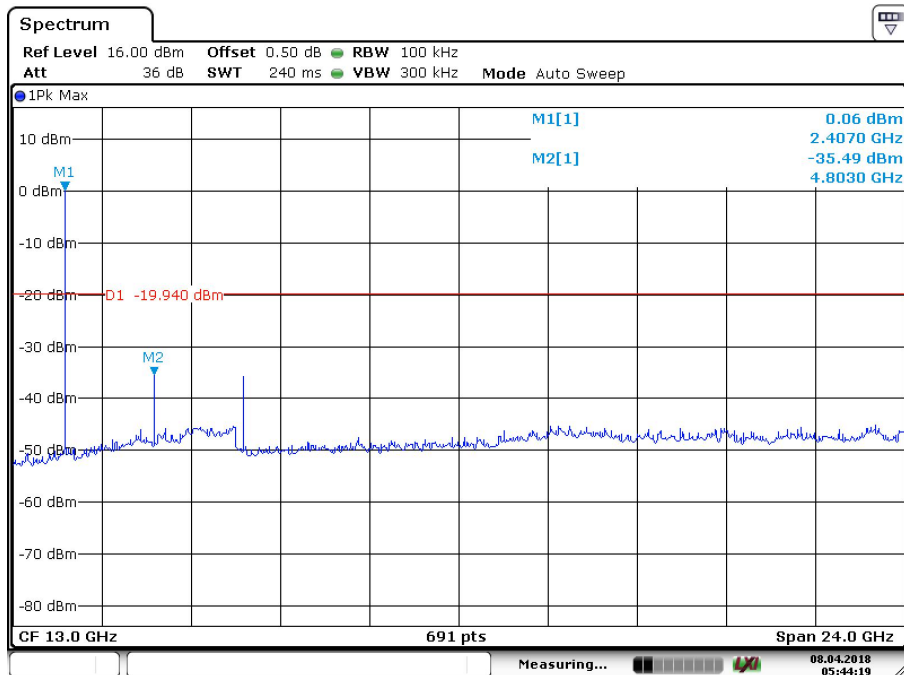

Date: 8.APR.2018 05:44:19



2440MHz

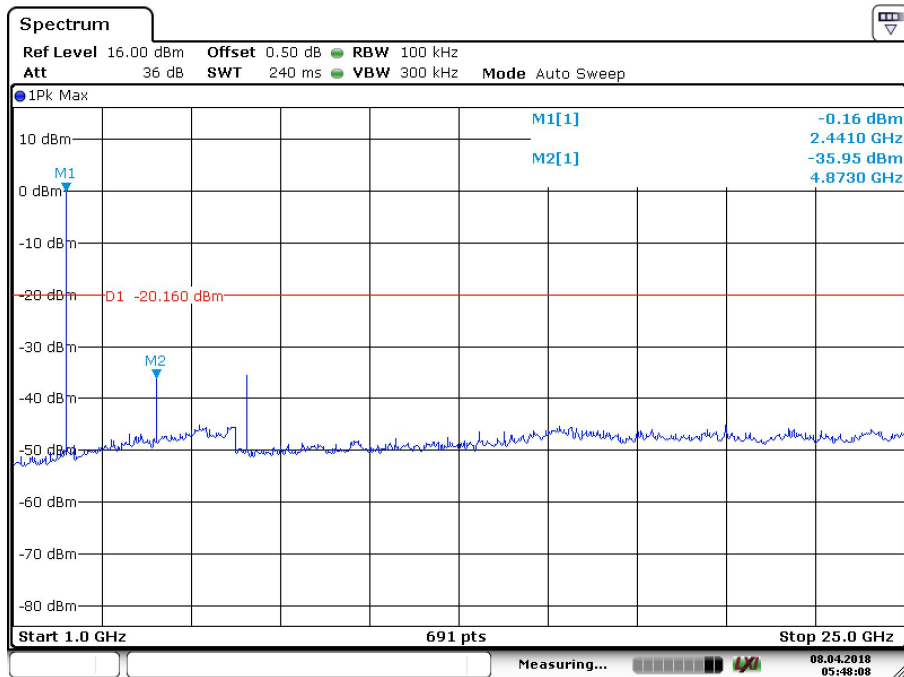
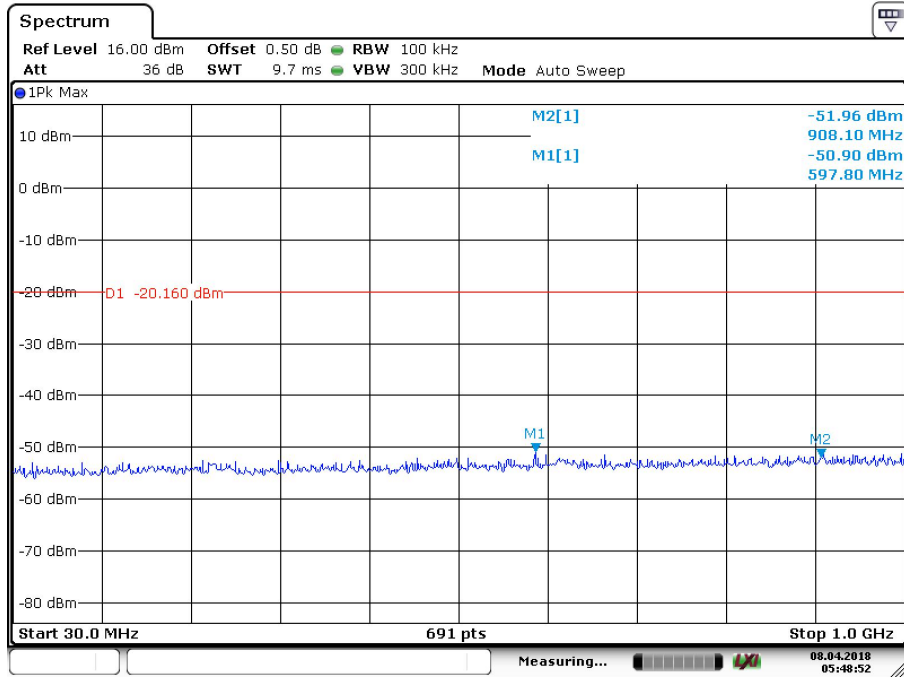



2480MHz

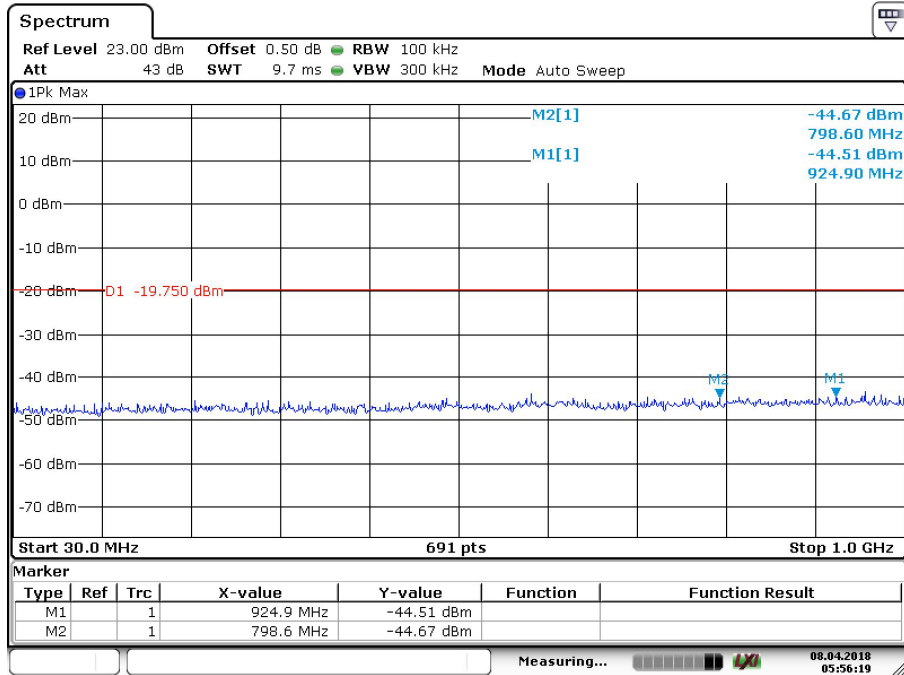

Date: 8.APR.2018 05:56:19

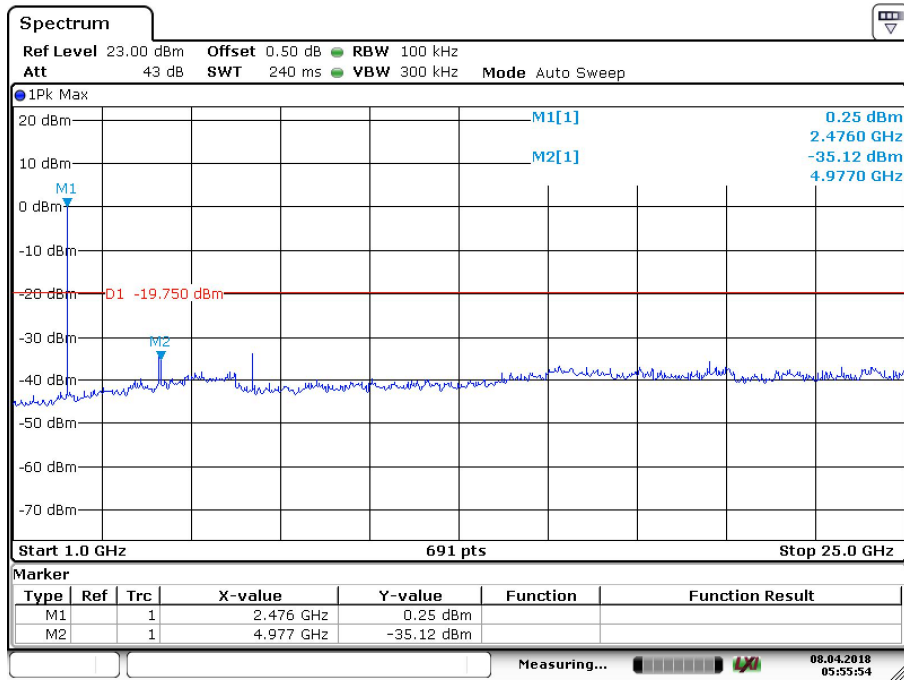

Date: 8.APR.2018 05:55:54



9.6 Band edge

Test Method

- 1 Use the following spectrum analyzer settings:
Span = wide enough to capture the peak level of the in-band emission and all spurious
RBW = 100 kHz, VBW ≥ RBW, Sweep = auto, Detector function = peak, Trace = max hold.
- 2 Allow the trace to stabilize, use the peak and delta measurement to record the result.
- 3 The level displayed must comply with the limit specified in this Section.

Limit

Frequency Range MHz	Limit (dBc)
30-25000	-20

Band edge testing

2402MHz

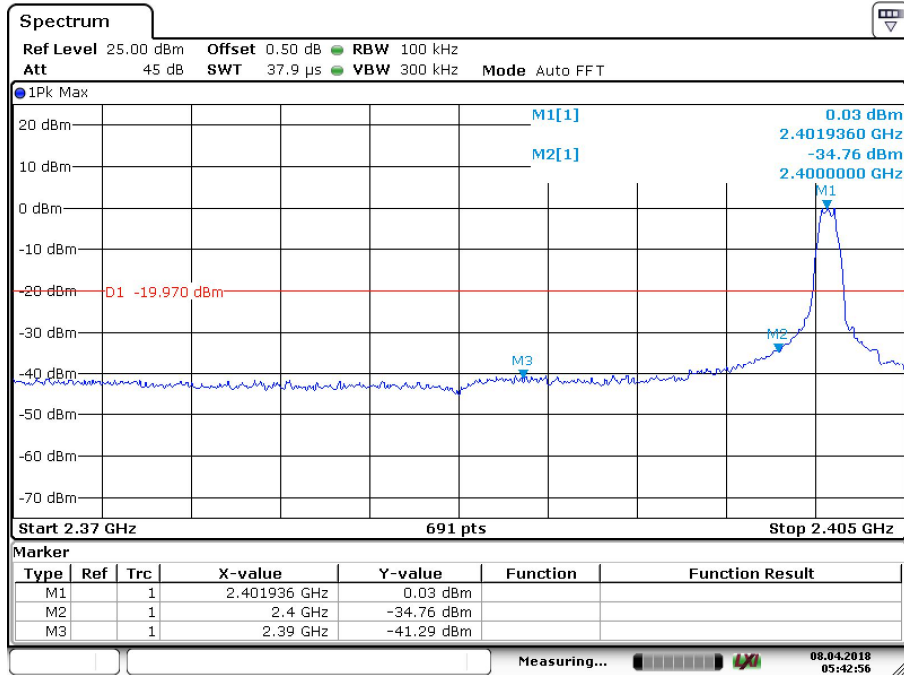

Date: 8.APR.2018 05:42:56

2480MHz

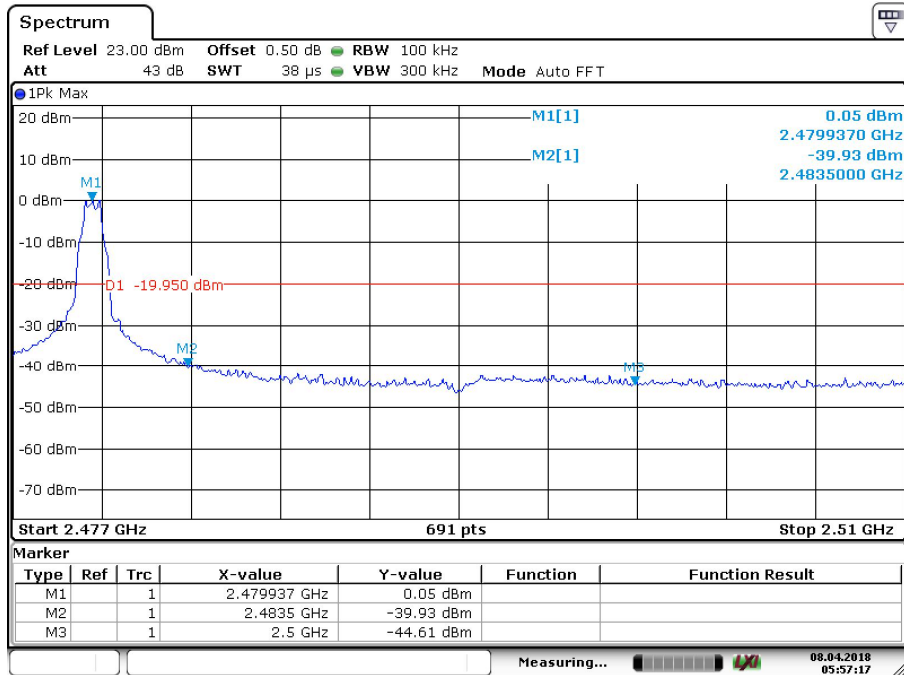

Date: 8.APR.2018 05:57:17

9.7 Spurious radiated emissions for transmitter

Test Method

- 1: The EUT was placed on a turn table which is 1.5m above ground plane for above 1GHz and 0.8m above ground for below 1GHz at 3 meters chamber room for test. The table was rotated 360 degrees to determine the position of the highest radiation.
- 2: The EUT was set 3 meters away from the interference – receiving antenna, which was mounted on the top of a variable – height antenna tower.
- 3: The height of antenna is varied from one meter to four meters above the ground to determine the maximum value of the field strength. Both horizontal and vertical polarizations of the antenna are set to make the measurement.
- 4: For each suspected emission, the EUT was arranged to its worst case and then the antenna was tuned to heights from 1 meter to 4 meters and the rotatable table was turned from 0 degrees to 360 degrees to find the maximum reading.
- 5: Use the following spectrum analyzer settings According to C63.10:

For Above 1GHz

Span = wide enough to capture the peak level of the in-band emission and all spurious
RBW = 1MHz, VBW \geq RBW for peak measurement and VBW = 10Hz for average measurement, Sweep = auto, Detector function = peak, Trace = max hold.

For Below 1GHz

Use the following spectrum analyzer settings:

Span = wide enough to capture the peak level of the in-band emission and all spurious
RBW = 100 KHz, VBW \geq RBW for peak measurement, Sweep = auto, Detector function = peak, Trace = max hold.

Note:

- 1: The resolution bandwidth and video bandwidth of test receiver/spectrum analyzer is 120 KHz for Quasi-peak detection (QP) at frequency below 1GHz.
- 2: The resolution bandwidth of test receiver/spectrum analyzer is 1MHz and the video bandwidth is 3MHz for peak detection (PK) at frequency above 1GHz.
- 3: The resolution bandwidth of test receiver/spectrum analyzer is 1MHz and the video bandwidth is 3MHz for RMS Average ((duty cycle < 98%) for Average detection (AV) at frequency above 1GHz, then the measurement results was added to a correction factor (20log(1/duty cycle)).
- 4: The resolution bandwidth of test receiver/spectrum analyzer is 1MHz and the video bandwidth is 10Hz (duty cycle > 98%) for Average detection (AV) at frequency above 1GHz.

Limit

The radio emission outside the operating frequency band shall be at least 20 dB below that in the 100 kHz bandwidth within the band that contains the highest level of the desired power. Radiated emissions which fall in the restricted bands, as defined in section 15.205, must comply with the radiated emission limits specified in section 15.209.

Frequency MHz	Field Strength uV/m	Field Strength dBµV/m	Detector
30-88	100	40	QP
88-216	150	43.5	QP
216-960	200	46	QP
960-1000	500	54	QP
Above 1000	500	54	AV
Above 1000	5000	74	PK

Spurious radiated emissions for transmitter

According to C63.10, if the peak (or quasi-peak) measured value complies with the average limit, it is unnecessary to perform an average measurement, so AV emission value did not show in below table if the peak value complies with average limit.

Transmitting spurious emission test result as below:

Low channel 2402MHz Test Result

Frequency Band	Frequency	Emission Level	Polarization	Limit	Detector	Margin	Correct factor	Result
	MHz	dBuV/m		dBuV/m				
30-1000MHz	186.331667	35.37	H	43.50	QP	8.13	-30.3	Pass
	204.438333	38.53	H	46.00	QP	4.97	-28.8	Pass
	41.963333	29.97	V	40.00	QP	10.03	-26.0	Pass
	63.033889	29.47	V	40.00	QP	10.53	-28.5	Pass
1000-2500MHz	--	--	H	74	PK	--	--	Pass
	--	--	V	74	PK	--	--	Pass

Middle channel 2440MHz Test Result

Frequency Band	Frequency	Emission Level	Polarization	Limit	Detector	Margin	Correct factor	Result
	MHz	dBuV/m		dBuV/m				
1000-2500MHz	--	--	H	74	PK	--	--	Pass
	--	--	V	74	PK	--	--	Pass

High channel 2480MHz Test Result

Frequency Band	Frequency	Emission Level	Polarization	Limit	Detector	Margin	Correct factor	Result
	MHz	dBuV/m		dBuV/m				
1000-2500MHz	--	--	H	74	PK	--	--	Pass
	--	--	V	74	PK	--	--	Pass

Remark:

- (1) "*" means the emission(s) appear within the restrict bands shall follow the requirement of section 15.205.
- (2) Data of measurement within this frequency range shown "--" in the table above means the reading of emissions are the noise floor or attenuated more than 10dB below the permissible limits or the field strength is too small to be measured.
- (3) Above 1GHz: Corrector factor = Antenna Factor + Cable Loss- Amplifier Gain
Below 1GHz: Corrector factor = Antenna Factor + Cable Loss

10 Test Equipment List

List of Test Instruments

Radiated Emission Test

DESCRIPTION	MANUFACTURER	MODEL NO.	SERIAL NO.	CAL. DUE DATE
Signal Analyzer	Rohde & Schwarz	FSV40	101030	2018-7-14
EMI Test Receiver	Rohde & Schwarz	ESR 26	101269	2018-7-14
Trilog Super Broadband Test Antenna	Schwarzbeck	VULB 9163	707	2018-7-14
Horn Antenna	Rohde & Schwarz	HF907	102294	2018-7-14
Pre-amplifier	Rohde & Schwarz	SCU 18	102230	2018-7-14
3m Semi-anechoic chamber	TDK	9X6X6	----	2020-7-7
EMI Test Receiver	Rohde & Schwarz	ESR 26	101269	2018-7-14
Trilog Super Broadband Test Antenna	Schwarzbeck	VULB 9163	707	2018-7-14
Horn Antenna	Rohde & Schwarz	HF907	102294	2018-7-14

Conducted Emission Test

Description	Manufacturer	Model no.	Serial no.	cal. due date
EMI Test Receiver	Rohde & Schwarz	ESR 3	101782	2018-7-14
LISN	Rohde & Schwarz	ENV4200	100249	2018-7-14
LISN	Rohde & Schwarz	ENV432	101318	2018-7-14
LISN	Rohde & Schwarz	ENV216	100326	2018-7-14
ISN	Rohde & Schwarz	ENY81	100177	2018-7-14
ISN	Rohde & Schwarz	ENY81-CA6	101664	2018-7-14
High Voltage Probe	Rohde & Schwarz	TK9420(VT9420)	9420-584	2018-7-14
RF Current Probe	Rohde & Schwarz	EZ-17	100816	2018-7-14
Attenuator	Shanghai Huaxiang	TS2-26-3	080928189	2018-7-7
Test software	Rohde & Schwarz	EMC32	Version9.15.00	N/A

C - Conducted RF tests

- Conducted peak output power
- 6dB bandwidth and 99% Occupied Bandwidth
- Power spectral density*
- Spurious RF conducted emissions
- Band edge



11 System Measurement Uncertainty

For a 95% confidence level, the measurement expanded uncertainties for defined systems, in accordance with the recommendations of ISO 17025 were:

System Measurement Uncertainty	
Test Items	Extended Uncertainty
Uncertainty for Conducted Emission 150kHz-30MHz (for test using High Voltage Probe TK9420(VT9420))	2.92 dB
Uncertainty for Radiated Spurious Emission 25MHz-3000MHz	Horizontal: 4.98dB; Vertical: 5.06dB;
Uncertainty for Radiated Spurious Emission 3000MHz-18000MHz	Horizontal: 4.95dB; Vertical: 4.94dB;
Uncertainty for Radiated Spurious Emission 18000MHz-40000MHz	Horizontal: 5.14dB; Vertical: 5.12dB;
Uncertainty for Conducted RF test with TS 8997	Power level test involved: 2.06dB Frequency test involved: 1.16×10^{-7}