



SGS-CSTC Standards Technical Services (Shanghai) Co., Ltd.

588 West Jindu Road, Songjiang District, Shanghai, China
Telephone: +86 (0) 21 6191 5666
Fax: +86 (0) 21 6191 5678
ee.shanghai@sgs.com

Report No.: SHEM140900245601
Page: 1 of 30

1 Cover Page

RF TEST REPORT

Application No.:	SHEM1409002456RF
Applicant:	Kohler Company.
FCC ID:	N82-KOHLER015
IC:	4554A-KOHLER015
Equipment Under Test (EUT): NOTE: The following sample(s) submitted was/were identified on behalf of the client as	
Product Name:	Veil Integrated Remote Control
Model No.(EUT):	1235953
Standards:	FCC PART 15 Subpart C Section 15.249: 2013 RSS-210 Issue 8 (December 2010) RSS-Gen Issue 3 (December 2010)
Date of Receipt:	September 28, 2014
Date of Test:	October 31, 2014 to November 03, 2014
Date of Issue:	November 20, 2014
Test Result:	Pass*

*In the configuration tested, the EUT detailed in this report complied with the standards specified above.



Tony Wu
E&E Section Manager

SGS-CSTC (Shanghai) Co., Ltd.

The manufacturer should ensure that all products in series production are in conformity with the product sample detailed in this report. If the product in this report is used in any configuration other than that detailed in the report, the manufacturer must ensure the new system complies with all relevant standards.

The report must not be used by the client to claim product certification, approval, or endorsement by NVLAP, NIST, or any agency of the federal government. All test results in this report can be traceable to National or International Standards.

This document is issued by the Company subject to its General Conditions of Service printed overleaf, available on request or accessible at www.sgs.com/terms_and_conditions.htm and, for electronic format documents, subject to Terms and Conditions for Electronic Documents at www.sgs.com/terms_e-document.htm. Attention is drawn to the limitation of liability, indemnification and jurisdiction issues defined therein. Any holder of this document is advised that information contained hereon reflects the Company's findings at the time of its intervention only and within the limits of Client's instructions, if any. The Company's sole responsibility is to its Client and this document does not exonerate parties to a transaction from exercising all their rights and obligations under the transaction documents. This document cannot be reproduced except in full, without prior written approval of the Company. Any unauthorized alteration, forgery or falsification of the content or appearance of this document is unlawful and offenders may be prosecuted to the fullest extent of the law. Unless otherwise stated the results shown in this test report refer only to the sample(s) tested and such sample(s) are retained for 90 days only.

2 Version

Revision Record				
Version	Chapter	Date	Modifier	Remark
00	/	November 20, 2014	/	Original

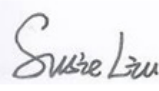
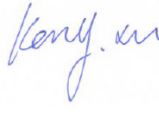
Authorized for issue by:			
Engineer		Eddy Zong _____ Print Name	
Clerk		Susie Liu _____ Print Name	
Reviewer		Keny Xu _____ Print Name	

3 Test Summary

Test Item	Test Requirement	IC Reference	Test method	Result
Antenna Requirement	FCC Part 15, Subpart C Section 15.203	RSS-Gen 7.1.2	---	PASS
AC Power Line Conducted Emission	FCC Part 15, Subpart C Section 15.207	RSS-Gen Issue 3 Section 7.2.4	ANSI C63.10 (2009) Section 6.2	N/A
Field Strength of the Fundamental Signal	FCC Part 15, Subpart C Section 15.249 (a)	RSS-210 Issue 8 Annex 2.9 (a)	ANSI C63.10 (2009) Section 6.10.2	PASS
Radiated Spurious Emissions and Band-edge	FCC Part 15, Subpart C Section 15.249 (a) &15.209&15.205	RSS-Gen Issue 3 Section 4.9 RSS-Gen Issue 3 Section 7.2.2	ANSI C63.10 (2009) Section 6.5&6.6&6.7	PASS
20dB Bandwidth	FCC Part 15, Subpart C Section 15.215 (c)	RSS-210 Issue 8 Annex 8	ANSI C63.10 (2009) Section 6.9.1	PASS
99% Occupied bandwidth	---	RSS-Gen Issue 3 Section 4.6.1	RSS-Gen Issue 3 Section 4.6.1	PASS



4 Contents

	Page
1 COVER PAGE	1
2 VERSION	2
3 TEST SUMMARY	3
4 CONTENTS.....	4
5 GENERAL INFORMATION	5
5.1 CLIENT INFORMATION.....	5
5.2 GENERAL DESCRIPTION OF E.U.T.....	5
5.3 TECHNICAL SPECIFICATIONS.....	5
5.4 TEST MODE.....	5
5.5 DESCRIPTION OF SUPPORT UNITS.....	5
5.6 TEST LOCATION	5
5.7 TEST FACILITY	6
5.8 MEASUREMENT UNCERTAINTY	6
6 EQUIPMENTS USED DURING TEST.....	7
7 TEST RESULTS	8
7.1 E.U.T. TEST CONDITIONS	8
7.2 ANTENNA REQUIREMENT.....	9
7.3 CONDUCTED EMISSIONS ON MAINS TERMINALS	10
7.4 FIELD STRENGTH OF THE FUNDAMENTAL SIGNAL	12
7.5 RADIATED SPURIOUS EMISSIONS AND BAND-EDGE.....	14
7.5.1 Radiated Spurious Emissions.....	17
7.5.2 Radiated Band edge	20
7.6 20dB BANDWIDTH	24
7.7 99% OCCUPIED BANDWIDTH	27
8 TEST SETUP PHOTOGRAPHS.....	30
9 EUT CONSTRUCTIONAL DETAILS.....	30

5 General Information

5.1 Client Information

Applicant: Kohler Company.
 Address of Applicant: 444 Highland Drive Kohler, WI, 53044
 Manufacturer: Shanghai Kohler Electronics, Ltd.
 Address of Manufacturer: Building E, 18 Jindian road, Pudong New area, Shanghai
 Factory: Shanghai Kohler Electronics, Ltd.
 Address of Factory: Building E, 18 Jindian road, Pudong New area, Shanghai

5.2 General Description of E.U.T.

Product Description: Portable Product
 Power Supply: DC 3.7V Li-on Rechargeable Battery
 Supply the EUT with fully charged battery during the testing.

5.3 Technical Specifications

Operation Frequency: 2414.5-2459.5MHz
 Modulation Technique: MSK

Channel List

No.	Frequency(MHz)	No.	Frequency(MHz)
1	2414.5	6	2439.5
2	2419.5	7	2444.5
3	2424.5	8	2449.5
4	2429.5	9	2454.5
5	2434.5	10	2459.5

Antenna Type: Integral
 Antenna Gain: -4dBi

5.4 Test Mode

Test Mode	Description of Test Mode
Engineering mode	Keep EUT working in continuously transmitting mode.

5.5 Description of Support Units

The EUT has been tested independently.

5.6 Test Location

All tests were performed at:
 SGS-CSTC Standards Technical Services (Shanghai) Co., Ltd.
 No.588 West Jindu Road, Songjiang District, Shanghai, China.201612.
 Tel: +86 21 6191 5666
 Fax: +86 21 6191 5678

5.7 Test Facility

The test facility is recognized, certified, or accredited by the following organizations:

- **CNAS (No. CNAS L0599)**

CNAS has accredited SGS-CSTC Standards Technical Services (Shanghai) Co., Ltd. to ISO/IEC 17025:2005 General Requirements for the Competence of Testing and Calibration Laboratories (CNAS-CL01 Accreditation Criteria for the Competence of Testing and Calibration Laboratories) for the competence in the field of testing. Date of expiry: 2017-07-14.

- **FCC – Registration No.: 402683**

SGS-CSTC Standards Technical Services (Shanghai) Co., Ltd. has been registered and fully described in a report filed with the Federal Communications Commission (FCC). The acceptance letter from the FCC is maintained in our files. Registration No.: 402683, Expiry Date: 2017-09-16.

- **Industry Canada (IC) – IC Assigned Code: 8617A**

The 3m Semi-anechoic chamber of SGS-CSTC Standards Technical Services (Shanghai) Co., Ltd. has been registered by Certification and Engineering Bureau of Industry Canada for radio equipment testing with Registration No.: 8617A-1. Expiry Date: 2017-06-18.

- **VCCI (Member No.: 3061)**

The 3m Semi-anechoic chamber and Shielded Room of SGS-CSTC Standards Technical Services (Shanghai) Co., Ltd. has been registered in accordance with the Regulations for Voluntary Control Measures with Registration No.: R-3868 and C-4336 respectively. Date of Registration: 2012-05-29. Date of Expiry: 2015-05-28.

5.8 Measurement Uncertainty

No.	Parameter	Measurement Uncertainty
1	Radio Frequency	$< \pm 1 \times 10^{-5}$
2	Total RF power, conducted	$< \pm 1.5$ dB
3	RF power density, conducted	$< \pm 3$ dB
4	Spurious emissions, conducted	$< \pm 3$ dB
5	All emissions, radiated	$< \pm 6$ dB (30MHz – 1GHz) $< \pm 6$ dB (above 1GHz)
6	Temperature	$< \pm 1^{\circ}\text{C}$
7	Humidity	$< \pm 5$ %
8	DC and low frequency voltages	$< \pm 3$ %

6 Equipments Used during Test

Item	Test Equipment	Manufacturer	Model No.	Serial No.	Cal. Date	Cal. Due date
1	EMI test receiver	Rohde & Schwarz	ESCS30	100086	2014-02-14	2015-02-13
2	Line impedance stabilization network	SCHWARZBECK	NSLK8127	8127-490	2014-02-14	2015-02-13
3	Line impedance stabilization network	ETS	3816/2	00034161	2014-02-14	2015-02-13
4	Spectrum Analyzer	Rohde & Schwarz	FSP-30	2705121009	2014-02-14	2015-02-13
5	EMI test receiver	Rohde & Schwarz	ESU40	100109	2014-02-14	2015-02-13
6	Active Loop Antenna (9kHz to 30MHz)	Rohde & Schwarz	FMZB 1519	1519-034	2014-03-19	2015-03-18
7	Broadband UHF-VHF ANTENNA (25MHz to 2GHz)	SCHWARZBECK	VULB9168	9168-313	2014-02-14	2015-02-13
8	Ultra broadband antenna (25MHz to 3GHz)	Rohde & Schwarz	HL562	100227	2014-10-09	2015-10-08
9	Horn Antenna (1GHz to 18GHz)	Rohde & Schwarz	HF906	100284	2014-02-14	2015-02-13
10	Horn Antenna (1GHz to 18GHz)	SCHWARZBECK	BBHA9120D	9120D-679	2014-07-28	2015-07-27
11	Horn Antenna (14GHz to 40GHz)	SCHWARZBECK	BBHA 9170	BBHA9170373	2014-02-14	2015-02-13
12	Pre-amplifier (9KHz – 2GHz)	LNA6900	TESEQ	71033	2014-02-14	2015-02-13
13	Pre-amplifier (1GHz – 26.5GHz)	Rohde & Schwarz	SCU-F0118-G40-BZ4-CSS(F)	10001	2014-02-14	2015-02-13
14	Pre-amplifier (14GHz – 40GHz)	Rohde & Schwarz	SCU-F1840-G35-BZ3-CSS(F)	10001	2014-02-14	2015-02-13
15	Tunable Notch Filter	Wainwright instruments GmbH	WRCT800.0/8 80.0-0.2/40-5SSK	9	2014-06-02	2015-06-01
16	High pass Filter	FSCW	HP 12/2800-5AA2	19A45-02	2014-06-02	2015-06-01
17	High-low temperature cabinet	Suzhou Zhihe	TL-40	50110050	2014-04-13	2015-04-12
18	AC power stabilizer	WOCEN	6100	51122	2014-06-02	2015-06-01
19	DC power	QJE	QJ30003SII	611145	2014-06-02	2015-06-01
20	Signal Generator (Interferer)	Agilent	SMR40	100555	2014-02-14	2015-02-13
21	Signal Generator (Blocker)	Rohde & Schwarz	SMJ100A	02.20.360.142	2014-02-14	2015-02-13
22	Splitter	Anritsu	MA1612A	M12265	/	/
23	Coupler	e-meca	803-S-1	900-M01	/	/

7 Test Results

7.1 E.U.T. test conditions

Requirements: 15.31(e) For intentional radiators, measurements of the variation of the input power or the radiated signal level of the fundamental frequency component of the emission, as appropriate, shall be performed with the supply voltage varied between 85% and 115% of the nominal rated supply voltage. For battery operated equipment, the equipment tests shall be performed using a new battery.

Operating Environment:	Temperature:	20.0 -25.0 °C
	Humidity:	35-75 % RH
	Atmospheric Pressure:	99.2 -102.0 kPa

Test frequencies: According to the 15.31(m) Measurements on intentional radiators or receivers, other than TV broadcast receivers, shall be performed and, if required, reported for each band in which the device can be operated with the device operating at the number of frequencies in each band specified in the following table:

Frequency range over which device operates	Number of frequencies	Location in the range of operation
1 MHz or less	1	Middle
1 to 10 MHz	2	1 near top and 1 near bottom
More than 10 MHz	3	1 near top, 1 near middle and 1 near bottom

Pursuant to Part 15.31(c) For swept frequency equipment, measurements shall be made with the frequency sweep stopped at those frequencies chosen for the measurements to be reported.

Test frequency is the lowest channel: 1 channel (2414.5MHz), middle channel: 5 channel (2434.5MHz) and highest channel: 10 channel (2459.5MHz) with fixed at channel.

7.2 Antenna Requirement

Standard requirement:

15.203 requirement:

An intentional radiator shall be designed to ensure that no antenna other than that furnished by the responsible party shall be used with the device. The use of a permanently attached antenna or of an antenna that uses a unique coupling to the intentional radiator, the manufacturer may design the unit so that a broken antenna can be replaced by the user, but the use of a standard antenna jack or electrical connector is prohibited

EUT Antenna:

The antenna is PCB antenna. The gain of the antenna is less than -4 dBi.

7.3 Conducted Emissions on Mains Terminals

Frequency Range: 150 KHz to 30 MHz

Class/Severity: Class B

Limit:

Frequency range MHz	Class B Limits: dB (µV)	
	Quasi-peak	Average
0.15 to 0.50	66 to 56	56 to 46
0.50 to 5	56	46
5 to 30	60	50

Note1: The limit decreases linearly with the logarithm of the frequency in the range 0.15 MHz to 0.50MHz.

Note2: The lower limit is applicable at the transition frequency.

Test site/setup:

Test instrumentation set-up:

Frequency Range	Detector	RBW	VBW
9KHz to 150Hz	Quasi-peak	200Hz	500Hz
150KHz to 30MHz	Quasi-peak	9kHz	30kHz

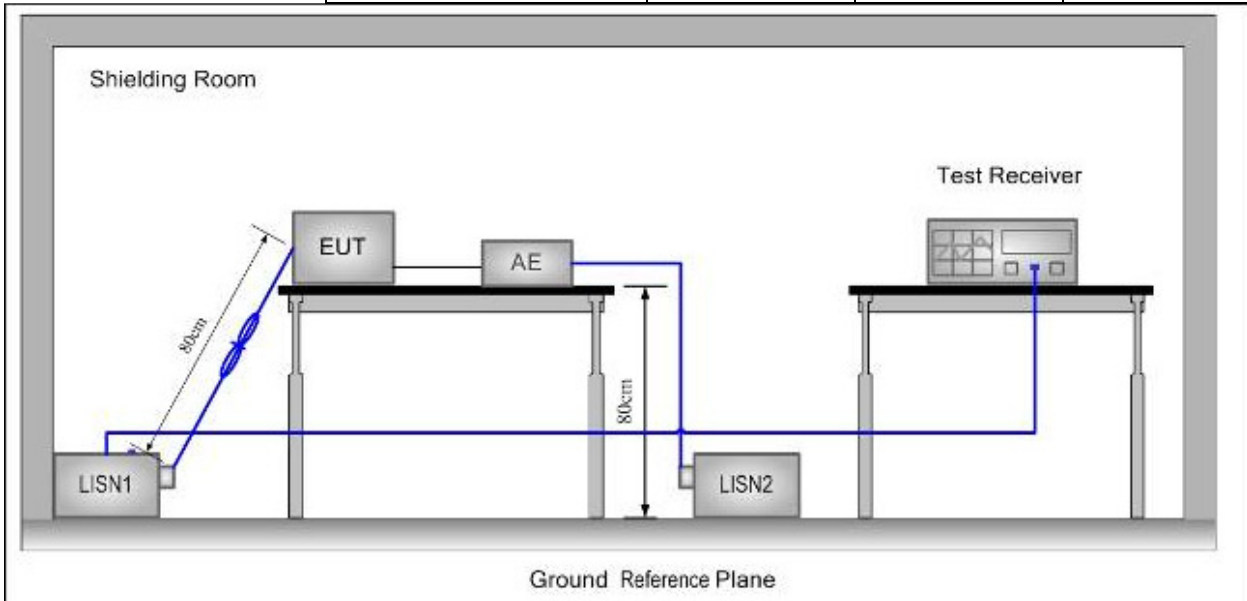

Test Procedure:

1. The mains terminal disturbance voltage was measured with the EUT in a shielded room.
2. The EUT was connected to AC power source through a LISN 1 (Line Impedance Stabilization Network) which provides 50Ω/50µH + 5Ω linear impedance. The power cables of all other units of the EUT were connected to a second LISN, which was bonded to the ground reference plane in the same way as the LISN for the unit being measured. A multiple socket outlet strip was used to connect multiple power cables to a single LISN provided the rating of the LISN was not exceeded
3. The tabletop EUT was placed upon a non-metallic table 0.8m above the ground reference plane.

And for floor-standing arrangement, the EUT was placed on the horizontal ground reference plane, but separated from metallic contact with the ground reference plane by 0.1m of insulation.

4. The test was performed with a vertical ground reference plane. The rear of the EUT shall be 0.4 m from the vertical ground reference plane. The vertical ground reference plane was bonded to the horizontal ground reference plane. The LISN was placed 0.8 m from the boundary of the unit under test and bonded to a ground reference plane for LISN mounted on top of the ground reference plane. This distance was between the closest points of the LISN and the EUT. The mains lead of EUT excess 0.8m was folded back and forth parallel to the lead so as to form a horizontal bundle with a length between 0.3m and 0.4m. All other units of the EUT and associated equipment were at least 0.8 m from the LISN.

Remark: Pre-scan was performed with peak detected on all ports, Quasi-peak & average measurements were performed at the frequencies at which maximum peak emission level were detected. Please see the attached Quasi-peak and Average test results.

Test Result: N/A

Test Data:

Note: This EUT is powered by battery only; therefore the AC Conducted Emission test is not applicable.

7.4 Field Strength of the Fundamental Signal

Test Site: Measurement Distance: 3m (Semi-Anechoic Chamber)

Receiver Setup:	Frequency	Detector	RBW	VBW	Remark
	Above 1GHz	Peak	1MHz	3MHz	Peak
		Peak	1MHz	10Hz	Average

Limit:	Frequency	Limit (dBuV/m)	Remark
	2400-2483.5 MHz	114	Peak
		94	Average

Test Setup:

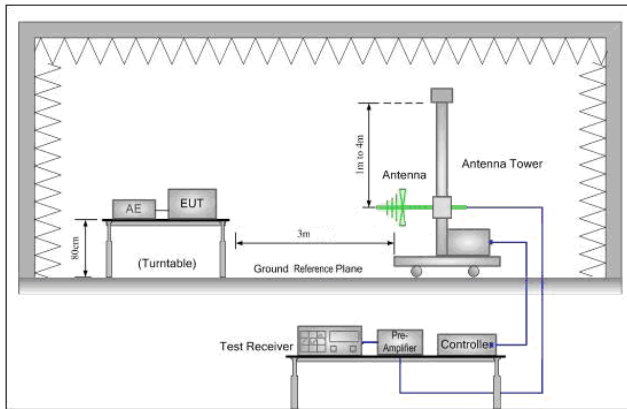

Figure 1. 30MHz to 1GHz

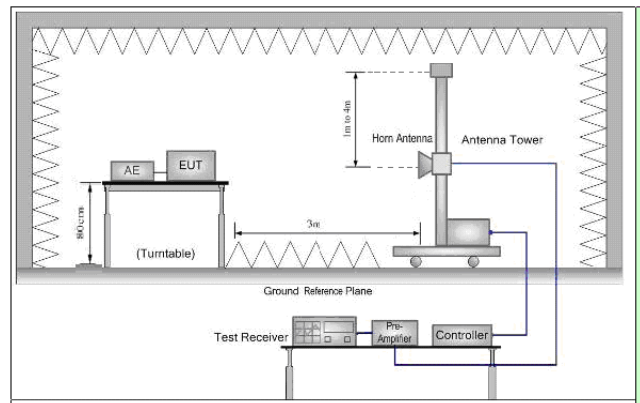

Figure 2. Above 1 GHz

Test Procedure:

- The EUT was placed on the top of a rotating table 0.8 meters above the ground at a 3 meter semi-anechoic chamber. The table was rotated 360 degrees to determine the position of the highest radiation.
- The EUT was set 3 meters away from the interference-receiving antenna, which was mounted on the top of a variable-height antenna tower.
- The antenna height is varied from one meter to four meters above the ground to determine the maximum value of the field strength. Both horizontal and vertical polarizations of the antenna are set to make the measurement.
- For each suspected emission, the EUT was arranged to its worst case and then the antenna was tuned to heights from 1 meter to 4 meters (for the test frequency of below 30MHz, the antenna was tuned to heights 1 meter) and the rotatable table was turned from 0 degrees to 360 degrees to find the maximum reading.
- The test-receiver system was set to Peak Detect Function and Specified Bandwidth with Maximum Hold Mode.
- If the emission level of the EUT in peak mode was 10dB lower than the limit specified, then testing could be stopped and the peak values of the EUT would be reported. Otherwise the emissions that did not have 10dB margin would be re-tested one by one using peak, quasi-peak or average method as specified and then reported in a data sheet.
- Repeat above procedures until all frequencies measured was complete.

Test Results:

Pass

Measurement Data

Peak value:

Frequency (MHz)	Read Level (dBUV)	Factor (dB/m)	Level (dBUV/m)	Limit Line (dBUV/m)	Over Limit (dB)	Polarization
2414.5	68.99	-3.93	65.06	94	-28.94	Horizontal
2414.5	68.69	-3.93	64.76	94	-29.24	Vertical
2434.5	70.57	-3.96	66.61	94	-27.39	Horizontal
2434.5	76.1	-3.96	72.14	94	-21.86	Vertical
2449.5	72.49	-3.98	68.51	94	-25.49	Horizontal
2449.5	71.45	-3.98	67.47	94	-26.53	Vertical

Remark:

- 1) The basic equation with a sample calculation is as follows: Level = Read Level + Factor.
(The Factor is calculated by adding the Antenna Factor, Cable Loss and Preamp Factor)
- 2) If the Peak value below the AV Limit, the AV test doesn't perform for this submission.

7.5 Radiated Spurious Emissions and Band-edge

Frequency Range: 9KHz to 25GHz

Test site/setup: Measurement Distance: 3m (Semi-Anechoic Chamber)
Test instrumentation set-up:

Frequency Range	Detector	RBW	VBW
0.009MHz-0.090MHz	Peak	10kHz	30kHz
0.009MHz-0.090MHz	Average	10kHz	30kHz
0.090MHz-0.110MHz	Quasi-peak	10kHz	30kHz
0.110MHz-0.490MHz	Peak	10kHz	30kHz
0.110MHz-0.490MHz	Average	10kHz	30kHz
0.490MHz -30MHz	Quasi-peak	10kHz	30kHz
30MHz-1GHz	Quasi-peak	100kHz	300kHz
Above 1GHz	Peak	RBW=1MHz	VBW≥RBW
	Average		VBW=10Hz

Sweep=Auto

15.209 Limit:

Frequency	Limit (dBuV/m)
0.009MHz-0.490MHz	128.5 ~ 93.8
0.490MHz-1.705MHz	73.8 ~63.0
1.705MHz-30MHz	69.5
30MHz-88MHz	40.0
88MHz-216MHz	43.5
216MHz-960MHz	46.0
960MHz-1GHz	54.0
Above 1GHz	54.0

Note: 15.35(b), Unless otherwise specified, the limit on peak radio frequency emissions is 20dB above the maximum permitted average emission limit applicable to the equipment under test. This peak limit applies to the total peak emission level radiated by the device.

Test Configuration: Receive antenna scan height 1 m - 4 m. polarization Vertical / Horizontal

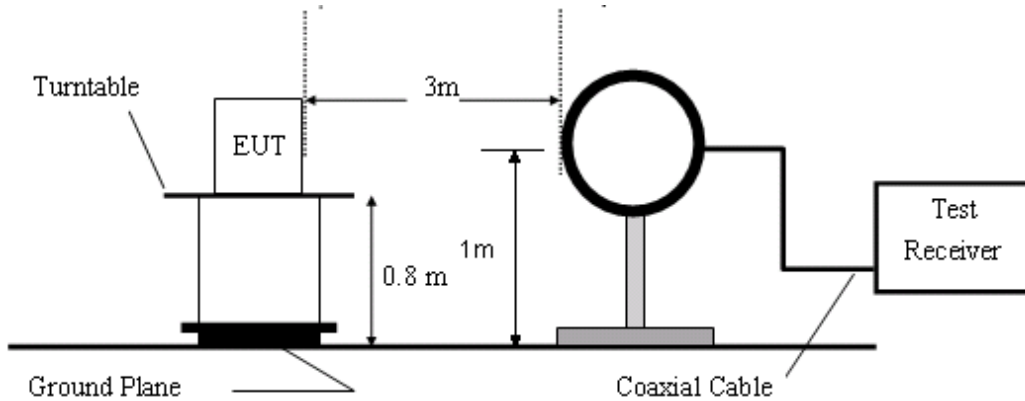

Figure1. 30MHz to 1GHz radiated emissions test configuration

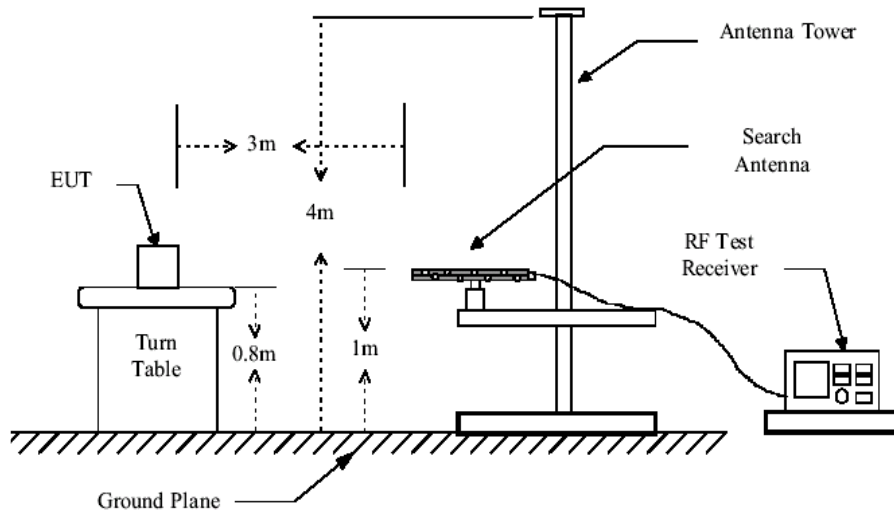

Figure2. 30MHz to 1GHz radiated emissions test configuration

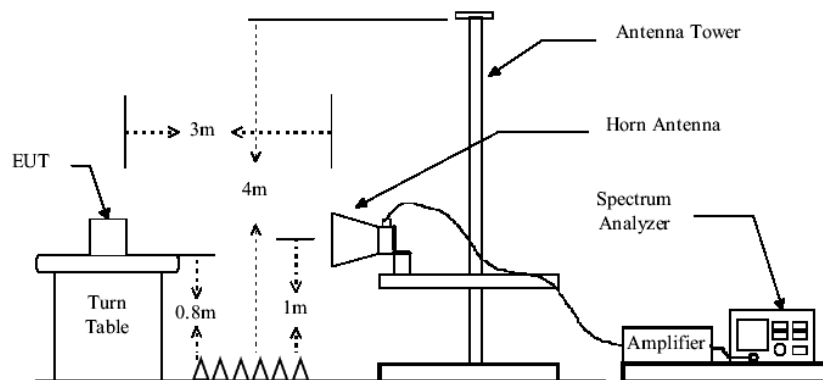

Figure3. Above 1GHz radiated emissions test configuration

Test Procedure: The procedure used was ANSI Standard C63.10:2009. The receiver was scanned from 9KHz to 25GHz. When an emission was found, the table was rotated to produce the maximum signal strength. An initial pre-scan was performed for in peak detection mode using the receiver. The EUT was measured for both the Horizontal and Vertical polarities and performed a pre-test three orthogonal planes. For intentional radiators, measurements of the variation of the input power or the radiated signal level of the fundamental frequency component of the emission, as appropriate, shall be performed with the supply voltage varied between 85% and 115% of the nominal rated supply voltage. The worst case emissions were reported.

Low noise amplifier was used below 1GHz, High pass Filter was used above 3GHz.

Between 1G and 3GHz, we did not use any amplifier or filter.

Pre-test was performed on Antenna A and Antenna B mode, Compliance test was performed on worse case (Antenna A mode).

Test were performed for their spatial orthogonal(X, Y, Z), the worst test data (X orthogonal) was submitted.

- 1) For this intentional radiator operates below 25 GHz. the spectrum shall be investigated to the tenth harmonic of the highest fundamental frequency. And above the third harmonic of this intentional radiator, the disturbance is very low. So the test result only displays to 5rd harmonic.
- 2) As shown in Section, for frequencies above 1000MHz. the above field strength limits are based on average limits. However, the peak field strength of any emission shall not exceed the maximum permitted average limits specified above by more than 20 dB under any condition of modulation.

The test only perform the EUT in transmitting status since the test frequencies were over 1GHz only required transmitting status.

Test Result: Pass

7.5.1 Radiated Spurious Emissions

30MHz-1GHz:

Vertical:

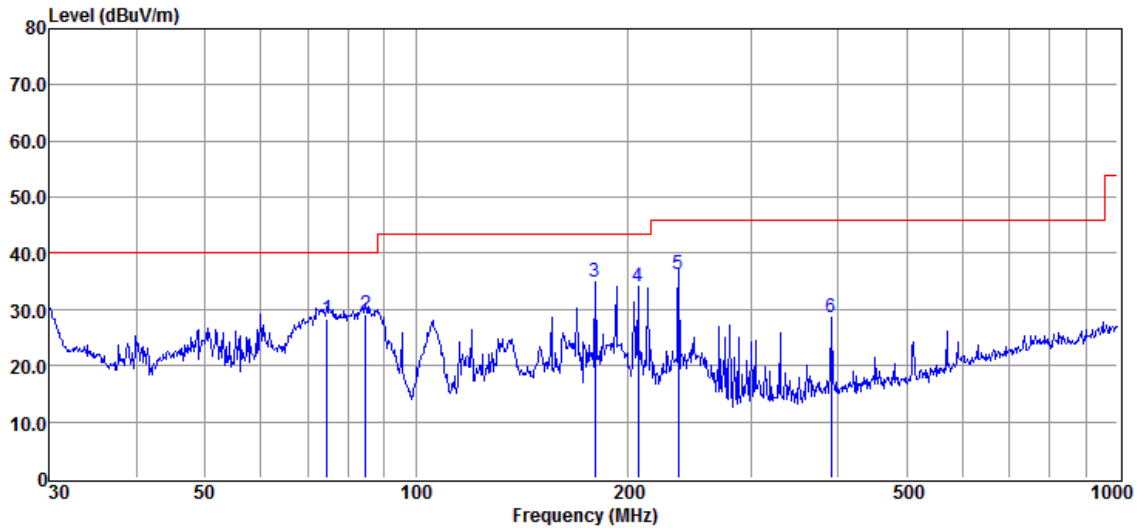

Item	Freq.	Read Level	Antenna Factor	Preamp Factor	Cable Loss	Result Level	Limit Line	Over Limit	Detector
(Mark)	(MHz)	(dBμV)	(dB/m)	(dB)	(dB)	(dBμV/m)	(dBμV/m)	(dB)	
1	74.657	41.79	9.64	23.67	0.64	28.40	40.00	-11.60	QP
2	84.702	43.34	8.59	23.67	0.75	29.01	40.00	-10.99	QP
3	180.016	45.15	12.10	23.63	1.33	34.95	43.50	-8.55	QP
4	207.123	47.12	9.15	23.62	1.43	34.08	43.50	-9.42	QP
5	236.645	48.47	9.86	23.64	1.52	36.21	46.00	-9.79	QP
6	390.723	36.00	14.23	23.70	2.14	28.67	46.00	-17.33	QP

Horizontal:

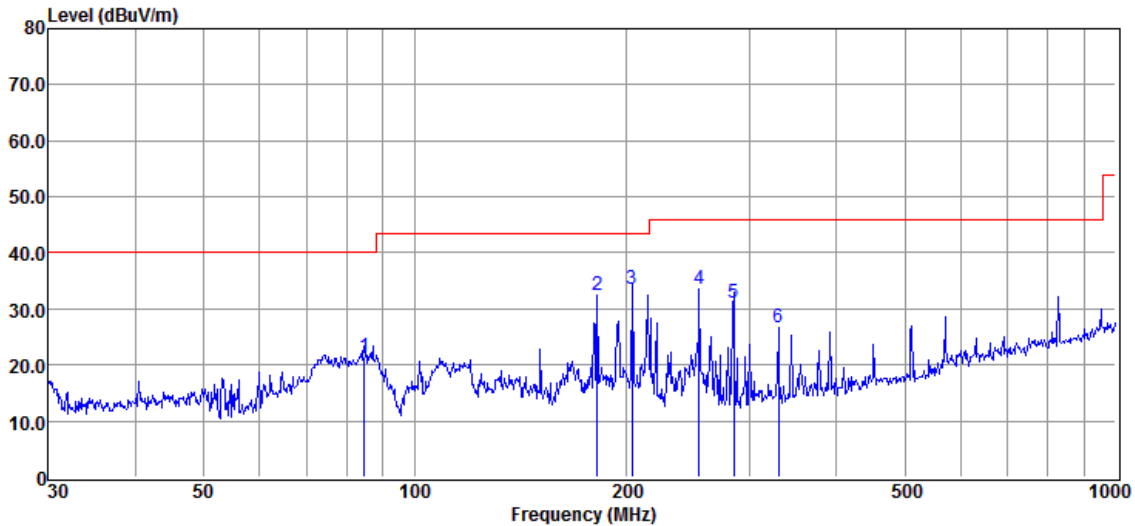

Item	Freq.	Read Level	Antenna Factor	Preamp Factor	Cable Loss	Result Level	Limit Line	Over Limit	Detector
(Mark)	(MHz)	(dBμV)	(dB/m)	(dB)	(dB)	(dBμV/m)	(dBμV/m)	(dB)	
1	84.702	35.75	8.59	23.67	0.75	21.42	40.00	-18.58	QP
2	181.920	42.85	11.99	23.63	1.35	32.56	43.50	-10.94	QP
3	204.238	46.41	9.21	23.62	1.41	33.41	43.50	-10.09	QP
4	254.728	45.25	10.44	23.65	1.59	33.63	46.00	-12.37	QP
5	284.977	41.63	11.34	23.66	1.80	31.11	46.00	-14.89	QP
6	330.195	35.31	13.12	23.68	1.92	26.67	46.00	-19.33	QP

Test Level = Receiver Reading + Antenna Factor + Cable Factor – Pre-amplifier Factor

Above 1GHz:

Channel: lowest

Mark	Frequency (MHz)	Reading (dBuV)	Factor (dB)	Emission (dBuV/m)	Limit (dBuV/m)	Over Limit (dB)	Detector	Polarization
1	4829	39.77	6.45	46.22	54	-7.78	peak	Horizontal
2	7243.5	40.30	10.79	51.09	54	-2.91	peak	Horizontal
3	9658	35.53	14.35	49.88	54	-4.12	peak	Horizontal
4	4829	41.78	6.45	48.23	54	-5.77	peak	Vertical
5	7243.5	39.62	10.79	50.41	54	-3.59	peak	Vertical
6	9658	34.97	14.35	49.32	54	-4.68	peak	Vertical

Channel: Middle

Mark	Frequency (MHz)	Reading (dBuV)	Factor (dB)	Emission (dBuV/m)	Limit (dBuV/m)	Over Limit (dB)	Detector	Polarization
1	4869	37.61	6.86	44.47	54	-9.53	peak	Horizontal
2	7304	37.45	11.06	48.51	54	-5.49	peak	Horizontal
3	9738	36.15	14.36	50.51	54	-3.49	peak	Horizontal
4	4865.75	45.88	6.83	52.71	54	-1.29	peak	Vertical
5	7305	37.84	11.06	48.90	54	-5.10	peak	Vertical
6	9738	36.59	14.36	50.95	54	-3.05	peak	Vertical

Channel: Highest

Mark	Frequency (MHz)	Reading (dBuV)	Factor (dB)	Emission (dBuV/m)	Limit (dBuV/m)	Over Limit (dB)	Detector	Polarization
1	4919	39.89	7.29	47.18	54	-6.82	peak	Horizontal
2	7378.5	38.82	11.37	50.19	54	-3.81	peak	Horizontal
3	9838	36.17	14.38	50.55	54	-3.45	peak	Horizontal
4	4912.75	45.62	7.26	52.88	54	-1.12	peak	Vertical
5	7378.5	38.21	11.37	49.58	54	-4.42	peak	Vertical
6	9838	35.52	14.38	49.90	54	-4.10	peak	Vertical

- Remark: 1. Test Level = Receiver Reading + Antenna Factor + Cable Loss- Preamplifier Factor
 2. No any other emission which falls in restricted bands can be detected and be reported.
 3. If the Peak value below the AV Limit, the AV test doesn't perform for this submission.

7.5.2 Radiated Band edge

Channel: lowest

MK.	Frequency (MHz)	Reading (dBuV/m)	Corrected factor(dB)	Result (dBuV/m)	Limit (dBuV/m)	Over Limit (dB)	Detector	Polarization
1	2344.43	42.94	-3.75	39.19	54	-14.81	Peak	Horizontal
2	2390	40.55	-3.89	36.66	54	-17.34	Peak	Horizontal
3	2414.72	73.10	-3.94	69.16	54	15.16	Horizontal	
1	2357.96	43.73	-3.80	39.93	54	-14.07	Peak	Vertical
2	2390	41.47	-3.89	37.58	54	-16.42	Peak	Vertical
3	2414.61	72.07	-3.94	68.13	54	14.13	Peak	Vertical

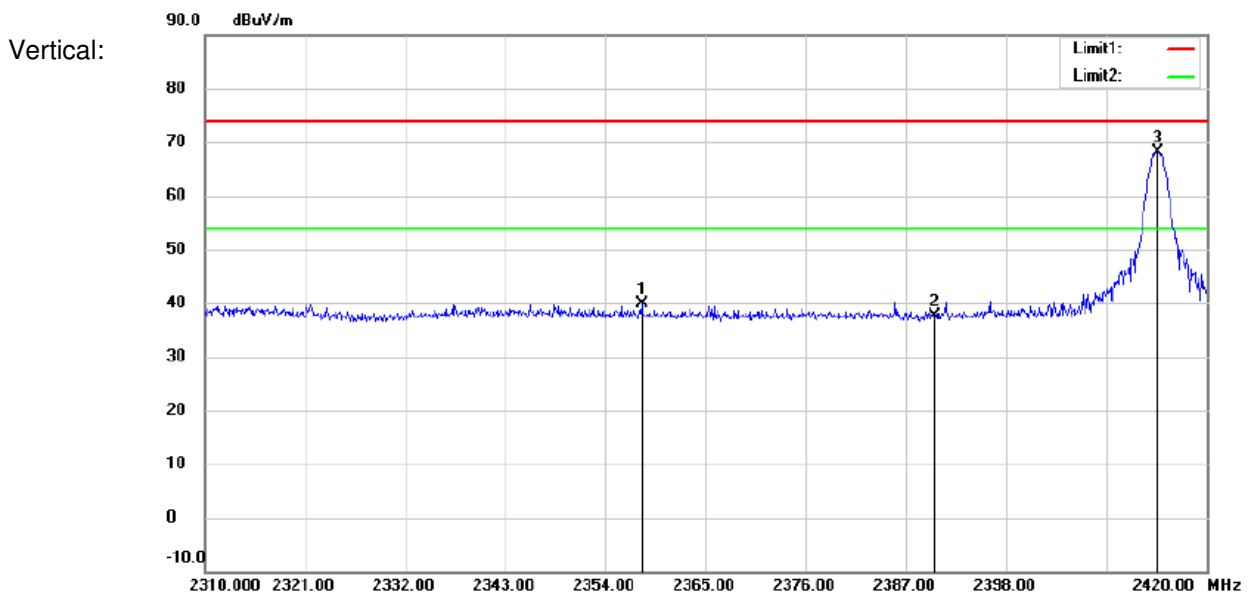
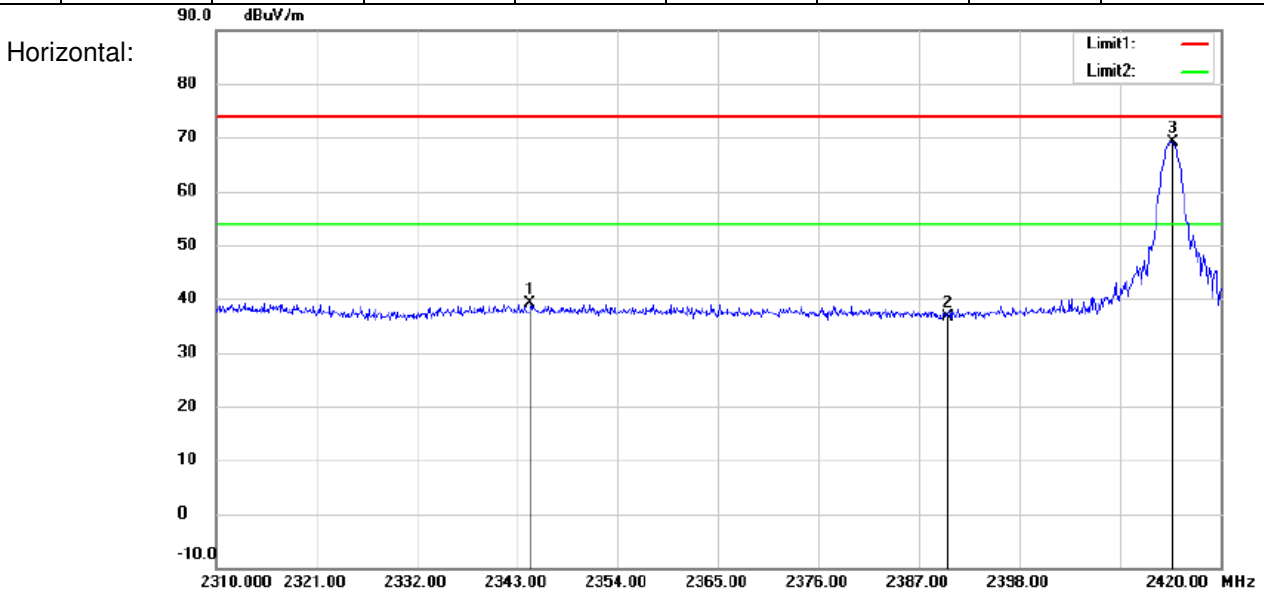

Channel: Highest

MK.	Frequency (MHz)	Reading (dBuV/m)	Corrected factor(dB)	Result (dBuV/m)	Limit (dBuV/m)	Over Limit (dB)	Detector	Polarization
1	2459.75	69.4	-3.98	65.42	54	11.42	Peak	Horizontal
2	2483.5	40.47	-4.01	36.46	54	-17.54	Peak	Horizontal
3	2514.565	42.11	-3.86	38.25	54	-15.75	Peak	Horizontal
1	2459.37	71.01	-3.99	67.02	54	13.02	Peak	Vertical
2	2483.5	40.65	-4.01	36.64	54	-17.36	Peak	Vertical
3	2524.445	42.34	-3.75	38.59	54	-15.41	Peak	Vertical

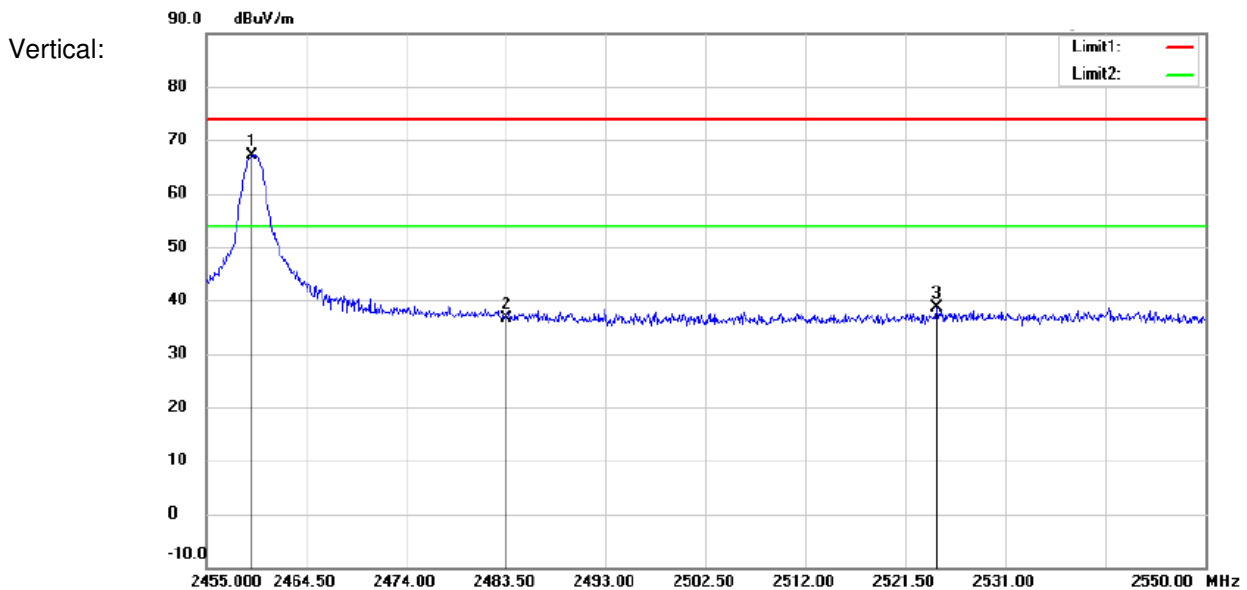
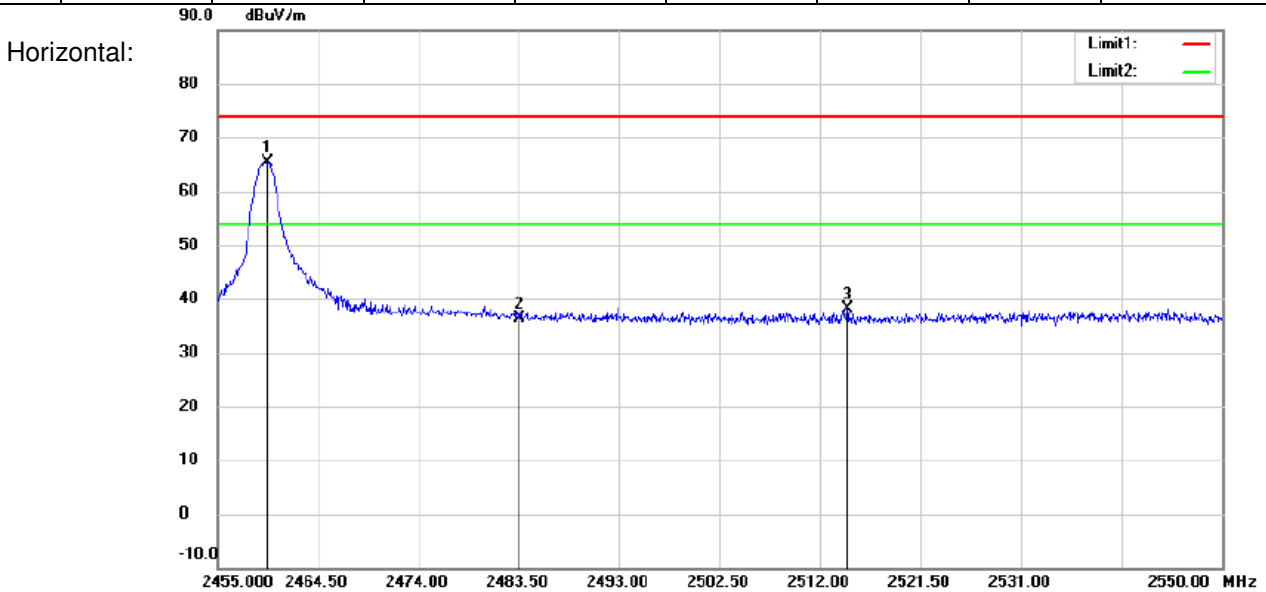

- Remark: 1. Test Level = Receiver Reading + Antenna Factor + Cable Loss- Preamplifier Factor
2. No any other emission which falls in restricted bands can be detected and be reported.
3. If the Peak value below the AV Limit, the AV test doesn't perform for this submission.

All frequencies within the "Restricted bands" have been evaluated to compliance, only spurious emissions are permitted in any of the frequency bands listed below:

1. FCC Part 15, Subpart C Section 15.205 Restricted bands of operation.

MHz	MHz	MHz	GHz
0.090 - 0.110	16.42 - 16.423	399.9 - 410	4.5 - 5.15
1.495 - 0.505	16.69475 - 16.69525	608 - 614	5.35 - 5.46
2.1735 - 2.1905	16.80425 - 16.80475	960 - 1240	7.25 - 7.75
4.125 - 4.128	25.5 - 25.67	1300 - 1427	8.025 - 8.5
4.17725 - 4.17775	37.5 - 38.25	1435 - 1626.5	9.0 - 9.2
4.20725 - 4.20775	73 - 74.6	1645.5 - 1646.5	9.3 - 9.5
6.215 - 6.218	74.8 - 75.2	1660 - 1710	10.5 - 12.7
6.26775 - 6.26825	108 - 121.94	1718.8 - 1722.2	13.25 - 13.4
6.31175 - 6.31225	123 - 138	2200 - 2300	14.47 - 14.5
8.291 - 8.294	149.9 - 150.05	2310 - 2390	15.35 - 16.2
8.362 - 8.366	156.52475 - 156.52525	2483.5 - 2500	17.7 - 21.4
8.37625 - 8.38675	156.7 - 156.9	2655 - 2900	22.01 - 23.12
8.41425 - 8.41475	162.0125 - 167.17	3260 - 3267	23.6 - 24.0
12.29 - 12.293	167.72 - 173.2	3332 - 3339	31.2 - 31.8
12.51975 - 12.52025	240 - 285	3345.8 - 3358	36.43 - 36.5
12.57675 - 12.57725	322 - 335.4	3600 - 4400	
13.36 - 13.41			

2. RSS-Gen section 7.2.2 Restricted bands of operation

MHz	MHz	GHz
0.090-0.110	240-285	9.0-9.2
2.1735-2.1905	322-335.4	9.3-9.5
3.020-3.026	399.9-410	10.6-12.7
4.125-4.128	608-614	13.25-13.4
4.17725-4.17775	960-1427	14.47-14.5
4.20725-4.20775	1435-1626.5	15.35-16.2
5.677-5.683	1645.5-1646.5	17.7-21.4
6.215-6.218	1660-1710	22.01-23.12
6.26775-6.26825	1718.8-1722.2	23.6-24.0
6.31175-6.31225	2200-2300	31.2-31.8
8.291-8.294	2310-2390	36.43-36.5
8.362-8.366	2655-2900	Above 38.6
8.37625-8.38675	3260-3267	
8.41425-8.41475	3332-3339	
12.29-12.293	3345.8-3358	
12.51975-12.52025	3500-4400	
12.57675-12.57725	4500-5150	
13.36-13.41	5350-5460	
16.42-16.423	7250-7750	
16.69475-16.69525	8025-8500	
16.80425-16.80475		
25.5-25.67		
37.5-38.25		
73-74.6		
74.8-75.2		
108-138		
156.52475-156.52525		
156.7-156.9		

7.6 20dB Bandwidth

Test Configuration:

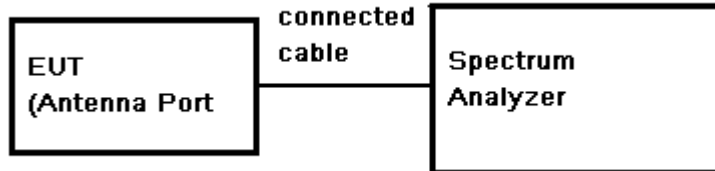

Test Procedure:

1. Place the EUT on the table and set it in Engineering mode.
2. Remove the antenna from the EUT and then connect a low loss RF cable from the antenna port to the spectrum analyzer.
3. Set the spectrum analyzer as RBW = approximately 1 % to 5 % of the OBW (set 30 kHz), VBW =3* RBW, Span=3MHz, Sweep=auto
4. Mark the peak frequency and -6dB (upper and lower) frequency.
5. Repeat above procedures until all frequency measured was complete.

Limit:

N/A

Test Result:

Pass

Test Data:

CH	Frequency (MHz)	Bandwidth (MHz)	Result
Low	2414.5	0.804	PASS
Mid	2434.5	0.804	PASS
High	2449.5	0.807	PASS

Test plot as follows:

Channel: **Lowest**

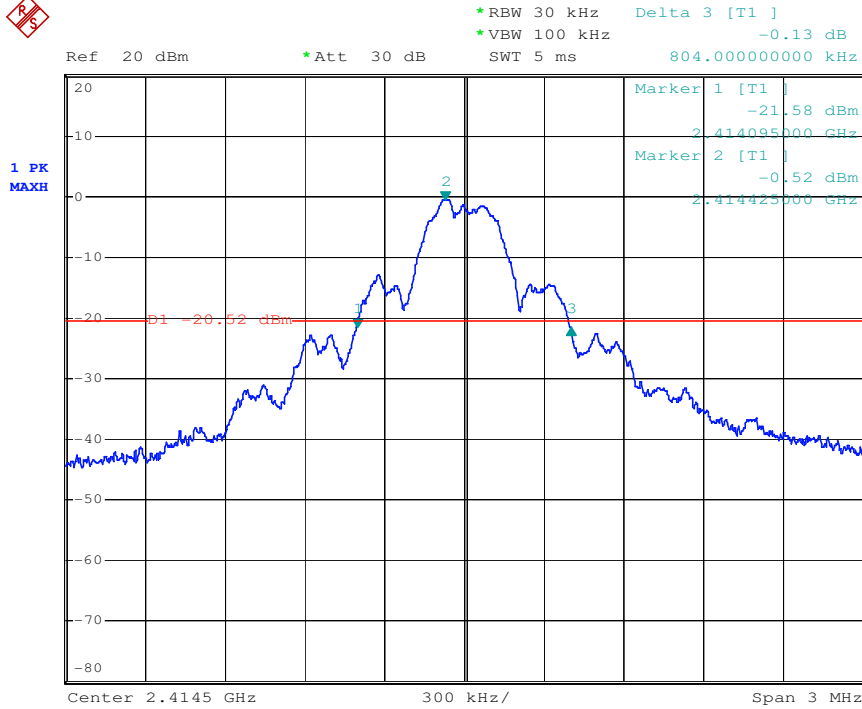

Channel: **Middle**

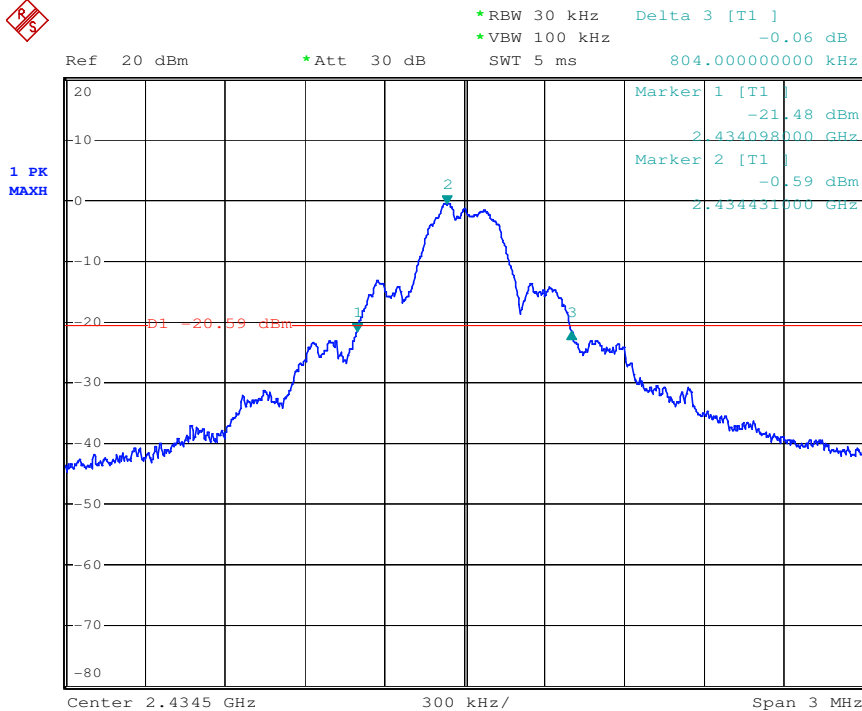

Channel: Highest

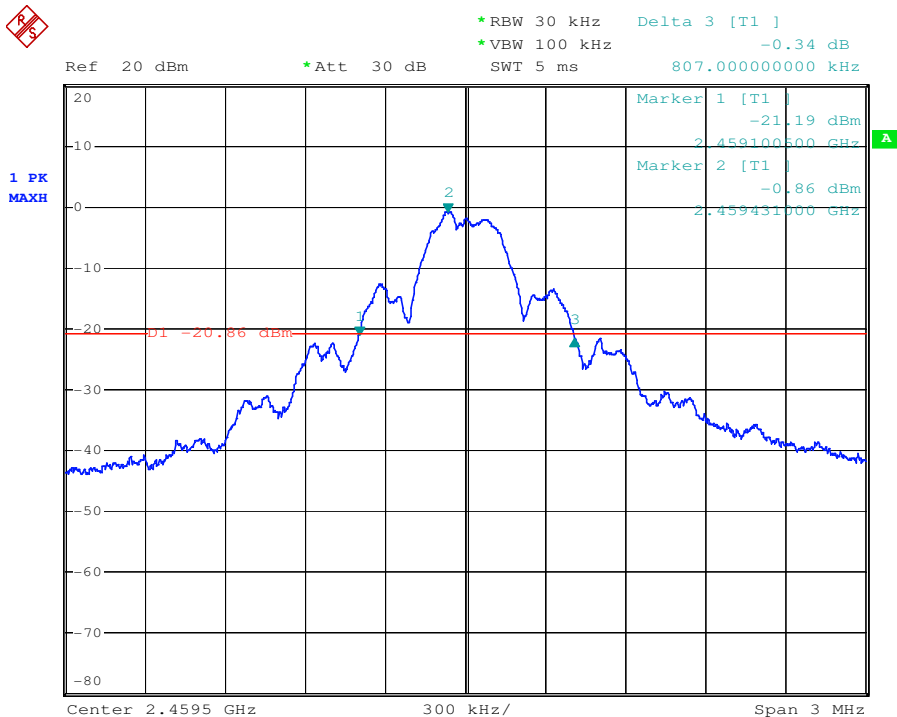

7.7 99% Occupied Bandwidth

Test Configuration:

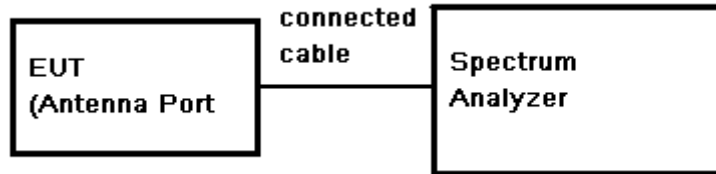

Test Procedure:

1. Remove the antenna from the EUT and then connect a low RF cable from the antenna port to the spectrum;
2. Set the spectrum analyzer: Span = approximately 2 to 3 times the 20dB bandwidth, centred on the hopping channel;
3. Set the spectrum analyzer: RBW = 1% of the span (set 30 kHz). VBW >= RBW. Sweep = auto; Detector Function = Peak. Trace = Max Hold.
4. Mark the peak frequency and -20dB points.

Test Result:

Pass

Test Date:

CH	Frequency (MHz)	Bandwidth (MHz)
Low	2414.5	0.813
Mid	2434.5	0.813
High	2449.5	0.837

Test plot as follows:

Channel: lowest

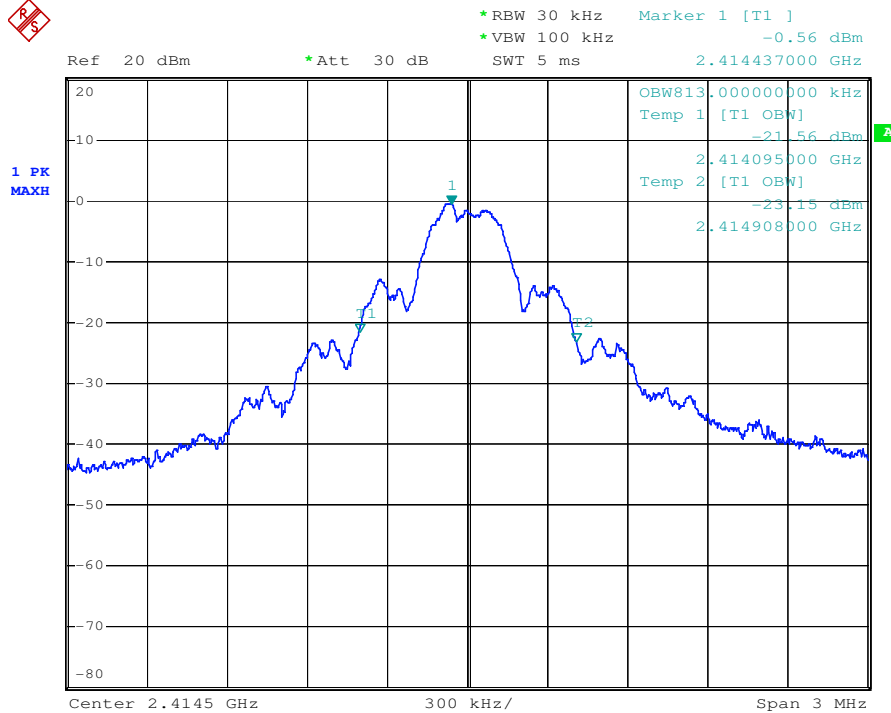

Channel: Middle

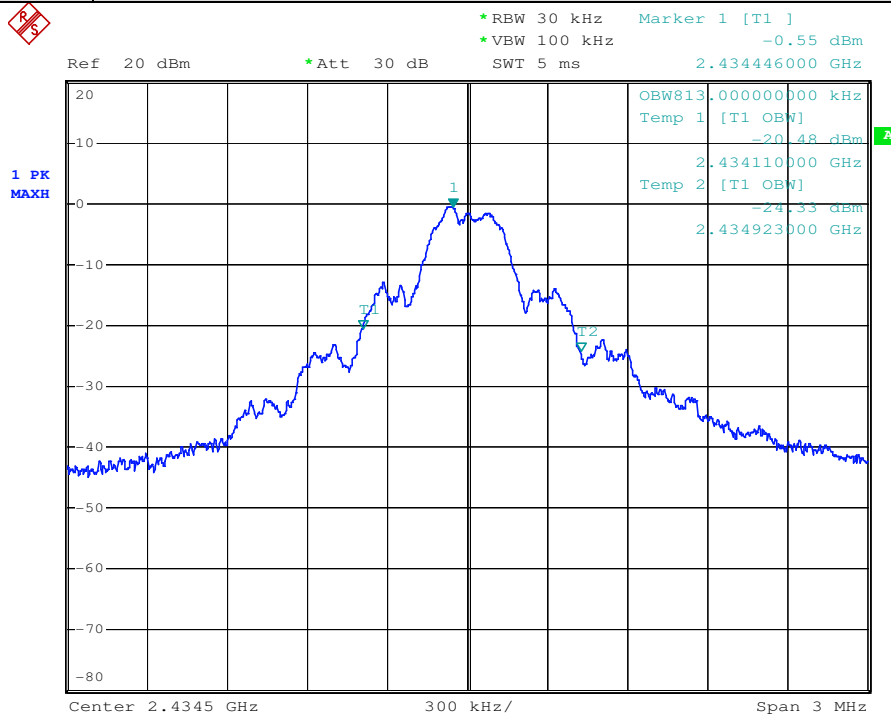

Channel: Highest



*RBW 30 kHz Marker 1 [T1]
*VBW 100 kHz -0.92 dBm

Ref 20 dBm *Att 30 dB SWT 5 ms 2.459440000 GHz



Center 2.4595 GHz 300 kHz/ Span 3 MHz



8 Test Setup Photographs

Refer to the <1235953_Test Setup photos-FCC>.

9 EUT Constructional Details

Refer to the <1235953_External Photos-FCC > & <1235953 _Internal Photos-FCC>.

--End of the Report--