

Model AC320
Baby Video Monitor

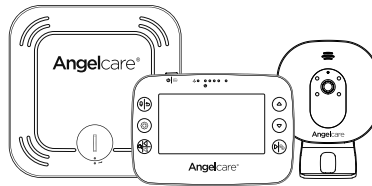

Model AC327
Baby Movement Monitor,
with Video



Model AC337
Baby Movement Monitor,
with Video

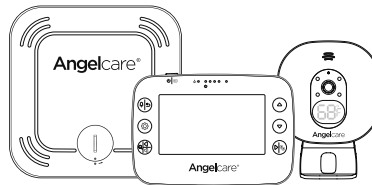

⚠ WARNING

Keep user's guide for future reference. Please read the warnings and safety instructions carefully before assembling & using the product. Failure to follow the warnings and the instructions could result in serious injury or death or damage to the product.

IMPORTANT - INTENDED USE

This product is NOT intended and should NOT be used to prevent Sudden Infant Death Syndrome (SIDS). This product is NOT intended to diagnose, treat, mitigate, cure or prevent any disease or condition. This is a product to monitor the movement of healthy babies and is not a substitute for parental care.

This baby monitor is compliant with all relevant standards regarding electromagnetic fields and is, when handled as described in the User's Guide, safe to use

WARNINGS

1. Because of the serious strangulation risk to infant & toddlers, parents & caregivers should note the following Warnings



WARNING - Strangulation Hazard - Children have STRANGLED in cords

- **KEEP** the Nursery Unit and adapter cords **OUT** of the reach of children more than 3 feet or 1 meter away
- **NEVER** use extension cords with adapters. **ONLY** use adapters provided
- **This product is NOT a Toy. NEVER allow children to play with it**

2.

WARNING - MOVEMENT SENSOR PAD - NO ALARM

- Sources of vibration & movement, other than your baby's, can be detected by the Sensor Pad and interfere with the performance of your Angelcare monitor
- The alarm will not sound if it detects movement other than your baby's
- High sensitivity settings can pick up other sources of vibration & movement - please read instructions on sensitivity setting to adjust accordingly
- Other active and older babies (toddlers) in the same room can be detected and the alarm will not sound
- Ensure the baby's environment is **FREE** from any movements or vibrations when using the Sensor Pad - see below warnings 3 to 11

3. DO NOT use a crib mobile and other crib accessories that may produce movements or vibrations

4. Fans (including ceiling), washing machines, floor boards, central heating or loud music are all forms of movement and vibration and may interfere and be detected by the Sensor Pad

5. If an additional Nursery Unit is added then it must be positioned at least 6.5 feet (2 metres) minimum from Nursery Unit 1 and Sensor Pad as this could interfere with performance

6. DO NOT use with bedside crib touching parent's/ carer's bed as the Sensor Pad will detect your movements

7. DO NOT place the crib against a wall or skirting board as vibrations may be detected

8. Following removal of baby from the crib, some mattresses may still detect mattress movement due to it forming back into shape and alarm may not sound

9. Ensure crib is stable to eliminate any movement

10. Crib should not be placed in reaching distance of another crib or bed

11. DO NOT use other wireless devices in the same room as the monitor (including mobile phones, microwaves...). They may interfere with signal and performance

12. **The Sensor Pad is made of plastic and does not permit air to circulate.** Therefore, mildew build up could develop underneath the mattress in the Sensor Pad area

We suggest rotating & airing /drying the mattress regularly to prevent any mildew. **AVOID CONTACT WITH MOISTURE.** Clean - wipe with a dry lint free cloth

13. **The Sensor Pad is not suitable for use above age 24 months**

14. **This product cannot replace responsible adult supervision**

- This product is designed to aid in the monitoring of your child. When using the monitor, you must still

2

provide the supervision necessary for the continued safety of your child

- Use this appliance **ONLY** for its intended use as described in this manual

15. The Sensor Pad is not intended to be used to determine if a child is out of the crib

16. ALWAYS be sure to immediately check on baby whenever an alarm sounds

17. Keep cords out of the reach of ANY children

18. ONLY use the chargers and power adapters provided. Do not use other types as this may damage the device and battery pack (if included in your model)

19. Adult assembly required. Keep small parts away from children when assembling

20. Follow instructions and test this monitor and its functions so you are familiar with it prior to actual use. ALWAYS be sure that both the transmitter and receiver are working properly and are within range of each other – check periodically and when changing location of the Nursery Unit

21. DO NOT touch the plug contacts especially with sharp or metal objects

22. DO NOT use the baby monitor near water Care should be taken so that objects DO NOT fall onto units and that liquids are not spilled into either unit or Sensor Pad through its openings



23. Keep monitor AWAY from heat sources (such as stoves, radiators, etc.). Heat can damage the case or electrical parts

24. ALWAYS place both the Nursery Unit and the Parent Unit on a flat solid surface in an upright position that allows for proper VENTILATION. DO NOT place on sofas, cushions, beds, etc. which may block ventilation or anywhere that would muffle the sound or interfere with the normal flow of air

25. The baby monitor can only be used between 10°C and 40°C (50°F and 104°F)

WARNINGS AND SAFETY

INSTRUCTIONS - BATTERY SPECIFIC

26. ALWAYS keep all batteries away from children

27. The Parent Unit battery is a replaceable Li-Ion battery. The Wireless Sensor Pad uses a replaceable Button Cell Lithium Battery. Only use the Angelcare recommended replacement battery (see Technical Specification)

- Danger of explosion if the wrong battery is used or if replaced incorrectly. Refer to User's Guide for correct battery installation
- DO NOT short circuit supply terminals

28. DO NOT mix old and new batteries and only use Angelcare recommended replacement batteries (see Technical Specification)

29. The Button Cell battery represents a small part and a choking hazard – KEEP away from children!

30. Dispose of batteries responsibly according to the User's Guide

31. Exercise care in handling batteries in order not to short out the batteries with conducting materials such as rings, bracelets and keys

32. Overcharging, short circuiting, reverse charging, mutilation, or incineration of batteries must be avoided to prevent one or more of the following occurrences: release of toxic materials, release of hydrogen and/or oxygen, gas and rise in surface temperature

33. DO NOT attempt to recharge batteries provided with or identified for use with this product that are not intended to be charged The batteries may leak corrosive electrolyte or explode

34. Incorrect polarity installation of the batteries in the end product must be avoided Reverse insertion of batteries can cause charging, and that may result in leakage or explosion

35. Remove batteries from units if you store the product over 30 days because the batteries could leak and damage the product

36. Discard 'dead' batteries as soon as possible since 'dead' batteries are more likely to leak in a product. If a battery has leaked or vented, discard product responsibly

37. DO NOT store this product, or the batteries provided with or identified for use with this product, in high-temperature & high humidity environments and avoid direct sunlight

IMPORTANT SAFETY INSTRUCTIONS

38. Sensor Pad –

- If your crib does not have a solid, stationary, completely flat, firm surface including a spring or slat base, place a hard board between the crib base and the Sensor Pad, to ensure correct operation (see specification on STEP 2)
- The Sensor Pad functions with standard crib sprung and foam mattresses and not memory foam (partial or full), hollow frame construction mattresses and water beds. Please consult Angelcare if unsure of mattress compatibility

39. This monitor uses public airwaves to transmit signals. The Parent Unit may pick up signals or interference from other nursery monitors in your area. Your monitor may even be picked up by other households. To protect your privacy, make sure both units are turned OFF when not in use

40. Power cord protection - Protect the Adapter's power cord from being walked on or pinched by furniture or other items – Power supply cords should be routed so that they are not likely to be walked on or pinched by items upon or against them, paying particular attention to cords and plugs, convenience receptacle, and the point where they exit from the product. The socket outlet should be installed near the equipment and should

be easily accessible. Make sure to plug the adapter to the socket outlet nearest to the equipment and that is easily accessible. To disconnect from mains, unplug the adapter

41. Only use attachments/accessories and replacement parts specified by the manufacturer. Any mounting of the product should follow the manufacturer's instructions

- DO NOT position this product on an unstable cart, stand, tripod, bracket or table. The product may fall, causing serious injury to a child or adult and serious damage to the product
- Use ONLY the stand sold with the product
- Be sure replacement parts are supplied by Angelcare and have the same characteristics as original part. Unauthorised substitution may result in fire, electric shock or fire

42. Unplug this appliance during lightning storms or when not used for long periods of time

43. Servicing - DO NOT attempt to service this product yourself as opening or removing covers (except battery door) may expose you to dangerous voltage or other hazards

- **Power Supply** – see Technical Specification within this guide

44. Overloading - DO NOT overload wall outlets, extension cords or integral convenience receptacles as this can result in a risk of fire or electric shock

45. Nursery Unit Antenna - The antenna used for this transmitter must be installed to provide a separation distance of at least 8" (20 cm) from all persons and must not be collocated or operating in conjunction with any other antenna or transmitter

46. Cleaning - Disconnect all units before cleaning. DO NOT immerse any part of the monitor in water. Clean only with a dry cloth

SET UP REQUIREMENTS

WHAT'S IN THE BOX

- 1 Nursery Unit
- 2 Stand (for Nursery Unit)
- 3 2 x AC Adapters
- 4 Parent Unit
- 5 Lithium Ion Battery pack (for Parent Unit)
- 6 Sensor Pad (on model AC327 and AC337)
- 7 CR2450 Battery (for Sensor Pad)
- 8 Hardware (for wall mounting)

WHAT YOU NEED

Hardboard, if the crib does not have a firm surface
(see specification on STEP 2)

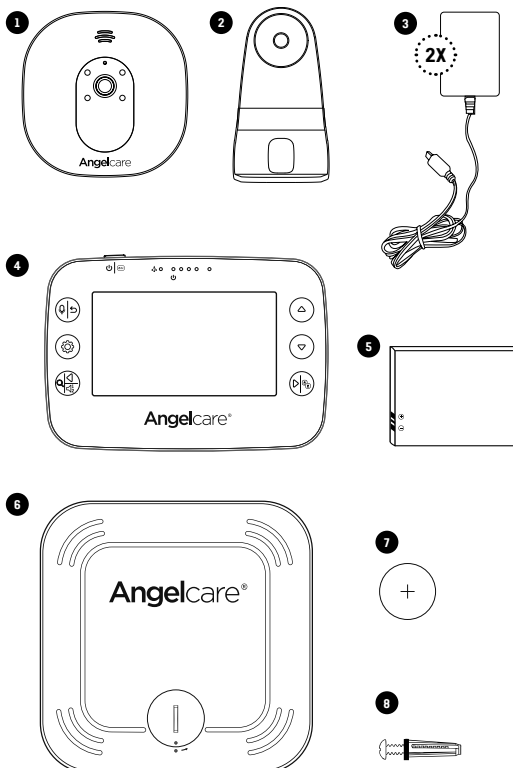

1- SETTING UP THE PARENT UNIT

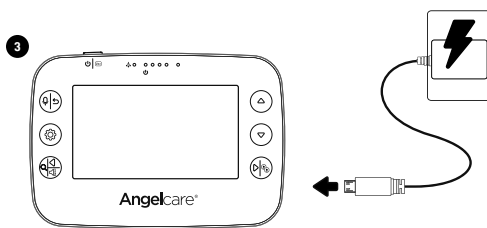
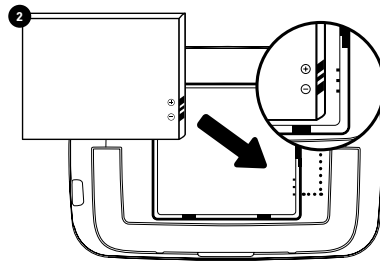
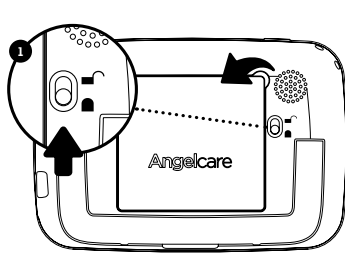

Charge the Parent Unit 8 hours prior to first use

Regular charging time is 4 hours

2- SETTING UP THE SENSOR PAD (ON MODEL AC327 AND AC337)

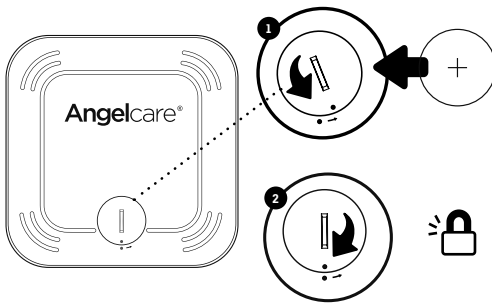

1. Remove the battery cover and insert the battery face with + face up
2. Replace the battery cover, align 2 dots and click to secure

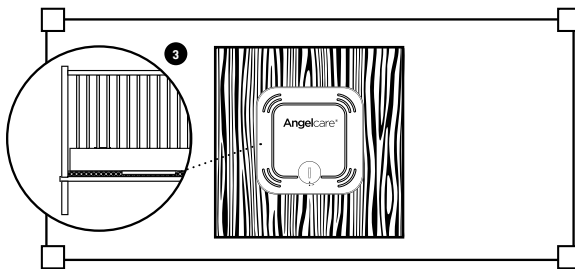

3. Remove the mattress from the crib, place Sensor Pad - **Angelcare® logo side up** - on base in centre of mattress. It should be centred on the hardboard if your crib requires a hardboard support (see 'IMPORTANT' note below)
4. Replace the mattress



! IMPORTANT

- If your crib does not have a solid, stationary, completely flat, firm surface including a spring or slat base, place a hardboard between the crib base and the Sensor Pad, to ensure correct operation. The hardboard support must measure at least 30 x 30 cm (12" x 12") and 6 mm (1/4") thick. This hardboard support must be larger than the Sensor Pad surface area
- The Sensor Pad functions with standard crib sprung and foam mattresses and not memory foam (partial or full), hollow frame construction mattresses and water beds. Please consult Angelcare if unsure of mattress compatibility. The hardboard maintains a constant pressure on the Sensor Pad, enabling it to detect the baby's movements even when the baby is at the edges of the crib

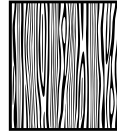

3-SETTING UP THE NURSERY UNIT

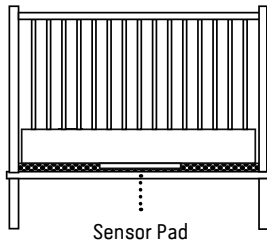

Place the Nursery Unit and Adapter cord at least **3 feet (1 meter)** from the crib

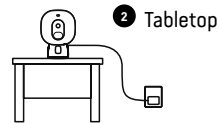
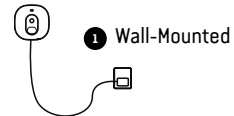

WALL-MOUNTED

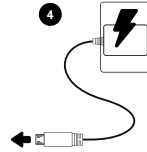
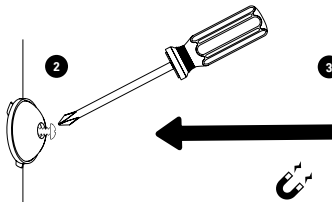
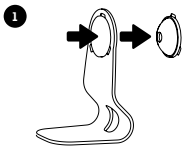

TABLETOP

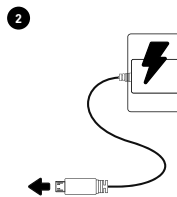
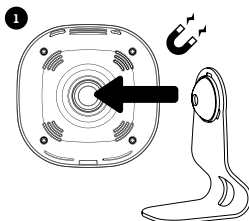

4- TURNING ON YOUR MONITOR

NURSERY UNIT

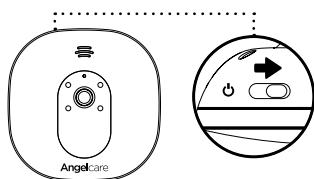

PARENT UNIT



Note:

- Your Nursery Unit and Parent Unit come pre-paired
- Each time you power **ON** your Nursery Unit, the internal thermometer will need to calibrate to ensure accuracy. This automatic process will take approximately 30 minutes

E
N

PAUSING AND RESTARTING THE SENSOR PAD

- Allows you to pause the Sensor Pad if you remove baby from the crib, e.g. for feeding or comforting. Ensure to un-pause the Sensor Pad before putting baby in the crib

NURSERY UNIT



PARENT UNIT



TEST THE SENSOR PAD (ON MODEL AC327 AND AC337)

1. Sources of vibration & movement other than your baby's can be detected by the Sensor Pad and interfere with the performance of your Angelcare monitor. The alarm will not sound if it detects movement other than your baby's
2. There are 4 sensitivity settings. The unit is set at level 2 (default) and can be adjusted accordingly
3. The Sensor Pad will detect false movements if you are touching the crib
4. The monitor will produce a Pre-alarm single beep tone designed to stir baby if no movement has been detected for 15 seconds. If no further movement is detected, the main alarm will sound at 20 seconds

SENSOR PAD FOUR CORNER TEST

1. Place the Sensor Pad at the centre of baby's sleeping area and put the mattress back in place
2. Switch ON both Nursery & Parent Units
3. Place your hand in a corner of the mattress and keep it there for 20 seconds
 - If the alarm sounds, even after placing your hand in any of the corners, adjust the sensitivity higher by a single level and repeat this test
 - If the movement alarm does not sound, continue the below:
 - Step away from the crib, after 20 seconds an alarm will sound from the Nursery and Parent Unit
4. Place your hand back onto the mattress in a different corner, the alarm will cease as movement is detected
 - Repeat in the remaining corners
 - If the alarm does not sound when you step away from the crib, lower sensitivity down a single level and repeat this test. If the problem persists, check for other sources of vibrations in the nursery

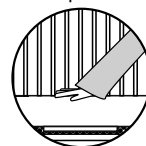

! IMPORTANT

- Test your monitor before first use
- Prior to use and on a regular basis (before placing your child in the crib) always check the Sensor Pad is detecting no movements or vibrations in its environment
- Test your monitor every time you move the Sensor Pad to a different place

5- GETTING TO KNOW YOUR MONITOR

NURSERY UNIT

- 1 Speaker
- 2 Microphone
- 3 Camera Lens
- 4 Power indicator (on model AC327 & AC320)
Temperature Indicator (on model AC337)
- 5 Micro USB charging port
- 6 Pause Sensor Pad / Pairing button
- 7 **Power ON/OFF**
- 8 Magnet for tabletop stand and wall mount

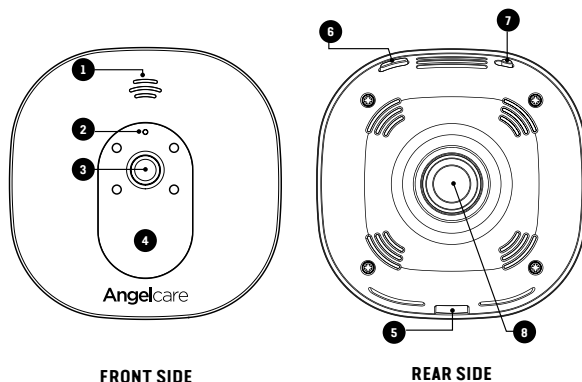

PARENT UNIT

- 1 **Power ON/OFF** (Press & Hold) / Sleep mode (Quickly press & release)
- 2 Talk-back / Return & save settings
- 3 Menu
- 4 Zoom & pan feature / Navigate left / Switch Nursery Unit sound
- 5 Movement indicator (TIC function)
- 6 Power indicator
- 7 Visual sound indicator
- 8 Microphone
- 9 Volume up / Navigate up
- 10 Volume down / Navigate down
- 11 Navigate right / View mode
- 12 Rechargeable battery compartment
- 13 Micro USB charging port
- 14 Speakerphone
- 15 Folding stand

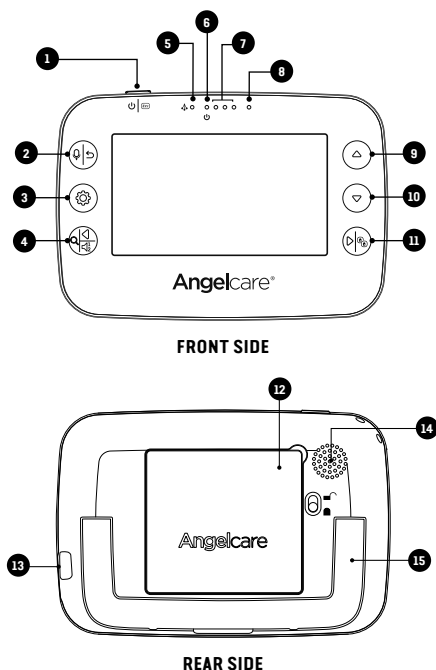

TOP STATUS BAR

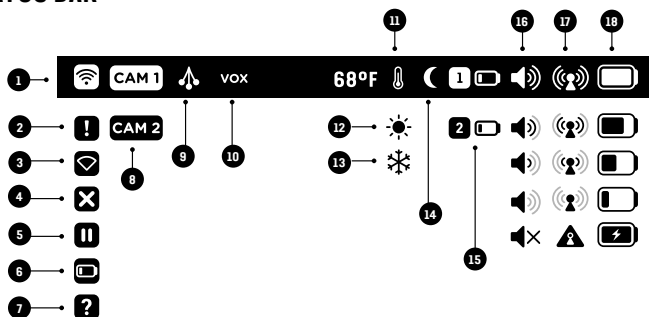

(on model AC327 and AC337)

- | | | | | | |
|---|--|----|--|----|---|
| 1 | Sensor Pad movement detection is activated | 8 | Nursery Unit selected and broadcasting sound | 14 | Night vision is activated |
| 2 | Sensor Pad alert | 9 | "TIC" function is activated (on model AC327 and AC337) | 15 | Sensor Pad low battery indicator (on model AC327 and AC337) |
| 3 | Sensor Pad lost link | 10 | "VOX" function is activated | 16 | Volume level indicators |
| 4 | Sensor Pad movement detection is OFF | 11 | Temperature alert is activated | 17 | Reception quality indicators |
| 5 | Sensor Pad is paused | 12 | Temperature alert: too hot | 18 | Parent Unit battery level indicators |
| 6 | Sensor Pad is low battery | 13 | Temperature alert: too cold | | |
| 7 | Sensor Pad has never been paired | | | | |

MAIN MENU

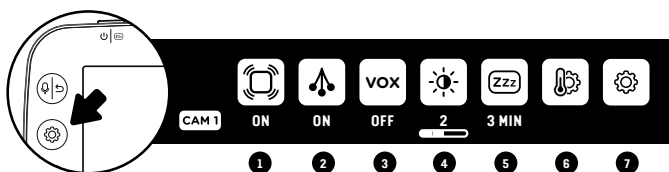

- 1 Movement Sensor Pad Activation** (on model AC327 and AC337):
 - ON:** The Parent & Nursery Units will alarm if there is no movement after 20 seconds
 - PAUSE:** Allows you to pause the Sensor Pad if you remove baby from the crib, e.g. for feeding or comforting
 - The Pause icon in the status bar will flash
 - On the AC327, the Nursery Unit Power indicator will slowly blink
 - On the AC337, the Nursery Unit temperature indicator will show a pause "P" symbol

Ensure to un-pause the Sensor Pad before putting baby in the crib (Turn movement detection ON)

 - OFF:** When your baby gets older, allows you to turn movement detection OFF and use your monitor for video only
- 2 Tic Activation** (on model AC327 and AC337):
 If movement detection is activated, allows you to hear a Tic sound every 5 seconds. In the event you have two Sensor Pads connected, the Tic indication will flash green for Sensor Pad 1 and blue for Sensor Pad 2
 - 3 VOX Activation:** Sound Activated' (**VOX ON**) means that it will transmit sounds only when it detects them, based on the setting of the sensitivity level. To save power, after 10 seconds, the sound transmission will stop if no sound is detected. Once sound is detected transmission will automatically activate. 'Continuous Sound' (**VOX OFF**) means the sound monitoring is continuously ON, picking up all sounds
 - 4 Screen Brightness**
 - 5 Sleep Mode Set-Up**
 - 6 Temperature Settings**
 - 7 General Settings**

E
N

! IMPORTANT

- To confirm your settings, you'll always need to press the ↶ button. A confirmation icon will then appear on the screen: Settings have been saved (✓) Settings have not been saved (✗)
- If you have 2 Nursery Units & 2 Sensor Pads paired with your monitor, you can only change the settings of the viewing Nursery Unit

TEMPERATURE SETTINGS MENU

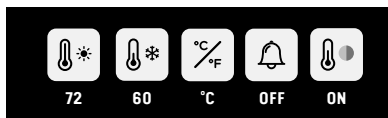

1 2 3 4 5

- 1 Set warmer temperature alarm
- 2 Set colder temperature alarm
- 3 Set Celsius or Fahrenheit display
- 4 Activate the temperature alarm
- 5 Activate the Nursery temperature color code display (on model AC337)
White: Temperature is normal
Red: Temperature is too hot
Blue: Temperature is too cold

GENERAL SETTINGS MENU



1 2 3 4 5

- 1 **Set VOX sensitivity:** The sensitivity of the microphone is adjustable and has 4 levels (the most sensitive is level 4). This means that sound will only transmit based on the level that you set
- 2 **Set Sensor Pad sensitivity** (on model AC327 & AC337):
To ensure adequate monitoring of your child's movements, you can adjust the sensitivity of the Sensor Pad
- 3 **Set Nursery Unit speaker phone volume**
- 4 **Activate Nursery Unit display** (on model AC337)
- 5 **Pairing Menu**

PAIRING MENU





1 2 3

- 1 Nursery Unit 1 Status
- 2 Nursery Unit 2 Status
- 3 Sensor Pad 1 Status (on model AC327 and AC337)

Nursery Unit and Sensor Pad Status Icons:

OK Green: Connected/Paired

 **Blue:** Add a Nursery Unit or Sensor Pad

 **Red:** Remove Nursery Unit or Sensor Pad

Confirmation process ON THE SCREEN:

 **Blue:** "Link" icon animation when pairing (Linking timeout: 60s)

 **Green:** Successful pairing

 **Red:** Failed pairing, please try again

ALERTS ICONS



(on model AC327 and AC337)

- 1 Sensor Pad alert:** If after 20 seconds there is NO movement detected both the Parent Unit and Nursery Unit speakers will emit loud consecutive beeps - this is the movement alarm
- 2 Sensor Pad is paused**
- 3 Sensor Pad lost link:** Parent Unit and Nursery Unit speakers will emit loud consecutive beeps
- 4 Parent Unit is out-of-range:** Parent Unit will emit 3 consecutive beeps, every 10 seconds
- 5 Temperature is too hot:** Parent Unit will emit 3 consecutive beeps, every 5 seconds
- 6 Temperature is too cold:** Parent Unit will emit 3 consecutive beeps, every 5 seconds
- 7 Parent Unit battery is low:** Parent Unit will emit 3 consecutive beeps, every 30 seconds

Note: Press any key to **stop alarm** and make the alert icon disappear

In the case of a **Sensor Pad alarm**, the monitor will Pause the Sensor Pad. In Pause mode, the movement detection feature is disabled. To reactivate the Sensor Pad, simply un-pause the Sensor Pad into the first menu

6- ADDING ACCESSORIES

Your Angelcare monitor allows you to add an additional Nursery Unit and Sensor Pad. Please contact your local distributor to see what is available in your country

IMPORTANT:

- When using two Nursery Units you will only be able to hear audio from one Nursery Unit at a time. In split screen, the sound transmitted from the Parent Unit will be from the Nursery Unit number highlighted in the info bar
- When using two Sensor Pads with one Monitor, it is recommended that each Sensor Pad is located in separate rooms

7- TROUBLESHOOTING

TAKING CARE OF YOUR RECHARGEABLE BATTERY

- Ensure that you fully charge your battery for 8 hours before its first use.
- To maintain maximum battery life, it is recommended that you fully discharge your battery periodically. If your Parent Unit is not in use, please turn it **OFF**.

NO SOUND IS BEING TRANSMITTED

- Check the volume level on the Parent Unit and the Nursery Unit to ensure they are set to an appropriate level.
- Try bringing the Parent Unit closer to the Nursery Unit to see if you get sound.
- Charge the Parent Unit.

EN



WEAK RECEPTION

- Bring units closer together.
- Change the position of one or both units.
- Place units on a flat surface away from baby's reach.
- Recharge the Parent Unit.

STATIC, DISTORTION, INTERFERENCES (FROM OTHER MONITORS, WIRELESS PHONES, WALKIE-TALKIES, ETC.)

- Rotate Parent Unit or move it away from source of interference.

FEEDBACK (LOUD NOISES EMITTED FROM THE PARENT UNIT)

- Move units further apart (at least 10 feet (3 meters)).
- Decrease volume on Parent Unit.

THE PARENT UNIT SCREEN IS BLACK (PARENT UNIT IS OFF)

- Turn the Parent Unit back **ON** by pushing and holding the **POWER ON/OFF** button for 2 seconds.
- Recharge the Parent Unit.

MOVEMENT SENSOR PAD - NO ALARM

- Sources of vibration & movement, other than your baby's, can be detected by the Sensor Pad and the alarm will not sound.
- Refer to Warnings 3 to 11 and see STEP 4, TEST THE SENSOR PAD.

MOVEMENT SENSOR PAD - FALSE ALARMS

- Replace the Sensor Pad battery CR2450.
- Turn OFF the Nursery Unit.
- Sensor Pad False alarms may happen for several reasons, always be sure to immediately check on baby whenever an alarm sounds:
 - Nursery Unit has not been turned OFF after you have removed your baby from the crib
 - Make sure there is no bedding between the mattress and the Sensor Pad
 - Sensor Pad has not been placed under the mattress properly. Be sure the Sensor Pad is on a flat, firm surface with the printed side facing up
 - The sensitivity level may also need to be adjusted
- Refer to Warnings 3 to 11 and see STEP 4, TEST THE SENSOR PAD

NO SOUND IS BEING TRANSMITTED

- Check that both units are powered ON.
- Check that Parent Unit is not on MUTE.

HOW TO CHECK THE PARENT UNIT BATTERY

- Unplug the adapter from the Parent Unit and check the battery level indicator.

LOSS OF CONNECTIVITY BETWEEN THE NURSERY UNIT AND PARENT UNIT

· If your Nursery Unit becomes un-paired from your Parent Unit, please follow the steps below to re-pair them.

1. Turn ON the Parent Unit and keep the Nursery Unit OFF
2. Press Menu button
3. It will directly jump to General setting menu. Select the Pairing Icon and press
4. In the Pairing Menu, select Nursery Unit 1 Icon and press
- If Nursery Unit 1 is marked as connected select it to go the Nursery Unit 1 Pairing option. You will now need to remove it by selecting the red icon . The linking icon will appear on the screen until Successful Pairing Icon appears on the screen. You'll now be able to proceed with step 4
5. The Linking Icon will appear on the screen
6. Turn ON the Nursery Unit and press and hold its "pause/pairing" button until the power LED starts blinking while pairing
7. If the connection has been made, the Green Successful Pairing Icon will appear on the screen and the menu will show the OK Paired Icon
8. Otherwise, the Red Failed Pairing Icon will appear on the screen. You will need to try again

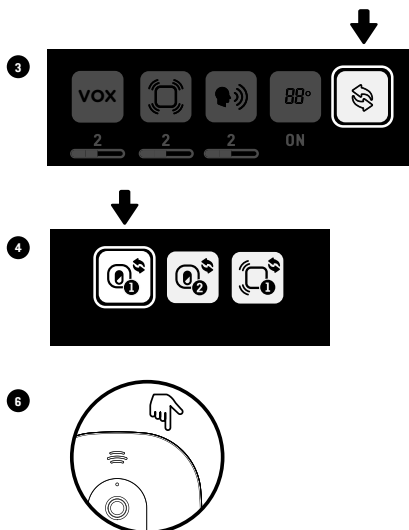

E
N

LOSS OF CONNECTIVITY BETWEEN THE SENSOR PAD AND THE NURSERY UNIT (ON MODELS AC327 & AC337)

· If your Sensor Pad becomes un-paired from your Parent Unit, please follow the steps below to re-pair them. In order to reconnect your Sensor Pad to your Nursery Unit, you need to make sure the Nursery Unit is paired with the Parent Unit first

1. Remove the battery of the Sensor Pad
- Note:** If you have two Sensor Pads, you will need to remove the battery from both of them first and then follow the steps below
2. Press Menu icon
3. Select the General setting menu and press
4. Select the Pairing Icon and press
5. In the Pairing Menu, select Sensor Pad 1 Icon and press
- If Sensor Pad is marked as connected select it to go the the Sensor Pad Pairing option. You will now need to remove it by selecting the red icon . The linking icon will appear on the screen until Successful Pairing Icon appears on the screen. You'll now be able to proceed with step 5
6. Insert the battery into the Sensor Pad. It will automatically activate it
7. If the connection has been made, the Green Successful Pairing Icon will appear on the screen and the menu will show the OK Paired Icon
8. Otherwise, the Red Failed Pairing Icon will appear on the screen. You will need to try again

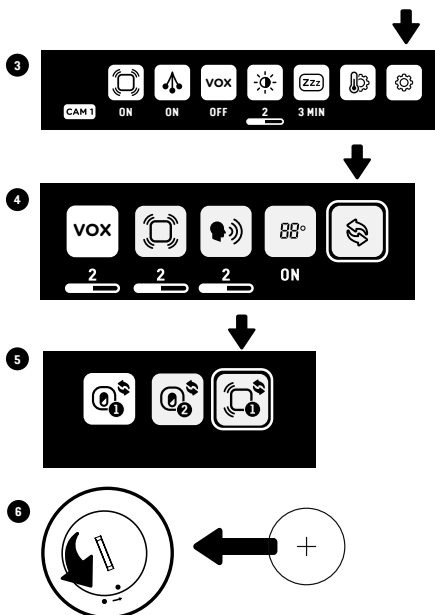



CUSTOMER CARE - LIMITED WARRANTY

Angelcare® warrants to the original owner of this product that Angelcare® monitor is free from any material and workmanship defects for the term of the warranty period (see warranty table below to determine the warranty for your country). If this monitoring system fails to function properly when used as directed under normal conditions and during the warranty period, Angelcare® will either repair or replace the product, at our discretion, free of charge. Please contact your local distributor to validate warranty and warranty period.

The product must be accompanied by a proof of purchase, either a bill of sale or other proof that the monitoring system is within the warranty period. Angelcare® will bear the cost of repairing or replacing the product and shipping it back to you.

This warranty does not apply to a product which has been damaged as a result of improper maintenance, an accident, improper voltage supply or any other form of misuse. The warranty is also void if the owner repairs or modifies the product in any way. Angelcare® is not liable

for any incidental or consequential damages with regard to this product. The warranty also excludes any liability other than what is stated above. No other warranty is given.

This warranty does not cover products and accessories which are not Angelcare®-branded, or any problems that result from usage that is not in accordance with product instructions, failure to follow the product instructions, or problems caused by using accessories, parts or components not supplied by Angelcare.

LEGAL RIGHTS VARY FROM COUNTRY TO COUNTRY. SOME COUNTRIES DO NOT ALLOW THE EXCLUSION OR LIMITATION OF INCIDENTAL OR CONSEQUENTIAL DAMAGES, SO THE ABOVE LIMITATIONS MAY NOT APPLY TO YOU.

WE ARE NOT IN ANY WAY RESPONSIBLE FOR ANY OUTCOME RESULTING FROM THE USE OF THIS PRODUCT.

Warranty term per country	
North America	1 year



TECHNICAL SPECIFICATIONS

Range:

- Open field (Open area without obstructions):
- Between the Nursery Unit and the Parent Unit: up to 820 feet (250 meters)
 - Between the Nursery Unit and the Sensor Pad: up to 20 feet (6 meters)

Number of Channels:

19 channels.

Thermometer Guidelines:

High Temperature Alarm: 72°F (22°C)
Low Temperature Alarm: 60°F (16°C)

Power Supply:

1 included Li-Ion battery 1300 mAh 3.7V (manufactured by Icon Energy System (Shenzhen) Co Ltd) for the Parent Unit
2 x 100-240 V AC / 5V DC 0.6A Adapters for the Parent Unit and the Nursery Unit

1 included CR2450 3V battery for model AC327 and AC337 (wireless Sensor Pad)

Caution: To reduce the risk of electric shock, do not expose this product to rain or moisture.

Danger of explosion if batteries are incorrectly replaced. The battery included for the Parent Unit is a user replaceable Li-ion rechargeable battery. Only use the Angelcare recommended replacement battery. The battery for the Sensor Pad is a user replaceable Lithium (not Li-Ion) battery and is NOT rechargeable. To obtain information on replacement batteries please contact Angelcare customer service: www.angelcarebaby.com or contact your local distributor. Instructions will be included with the replacement battery. Keep all batteries away from children.

Batteries:

- CAUTION: RISK OF EXPLOSION IF BATTERY IS REPLACED BY AN INCORRECT TYPE

Transmission:

Transmission between the Parent Unit and the Nursery Unit is made on 2.4 GHz frequency.

Transmission between the Nursery Unit and the Sensor Pad is made on 2.4 GHz frequency for model AC327 and AC337.

Federal Communications Commission (FCC) –

This device has been tested and found to comply with the limits for a Class B digital device, pursuant to Part 15 of the FCC rules. Operation is subject to the following two conditions: (1) this device may not cause interference, and (2) this device must accept any interference, including interference that may cause undesired operation of the device.

Industry Canada (IC) – This device complies with the Industry Canada license exempt RSS standard(s): Operation is subject to the following two conditions: (1) this device may not cause interference, and (2) this device must accept any interference, including interference that may cause undesired operation of the device.

RF Exposure – This device is designed and manufactured to comply with Radio Frequency (RF) radiation exposure limits for EU, FCC and IC for an uncontrolled environment. To maintain the compliance, human exposure to the nursery unit shall not be less than 20 cm (8 inches) during normal operation.

Exposition aux radiofréquences – Cet appareil est conçu et fabriqué pour respecter les limites d'exposition aux radiofréquences (RF) de l'EU, de la FCC et d'IC dans un milieu non contrôlé. Pour maintenir cette conformité, il ne doit pas y avoir de présence humaine à moins de 20 cm (8 po) de l'unité du nourrisson pendant le fonctionnement normal.

Go to: www.angelcarebaby.com for Full User's guide including full compliance statements.

PROTECT THE ENVIRONMENT

The wheelee bin symbols mean that according to local laws and regulations your product and/or its battery shall be disposed of separately from household waste. When the product/battery reaches its end of life take it to a collection point designated by local authorities. The separate disposal and recycling will help conserve natural resources and protect human health and the environment. Refer to User's Guide for removal of batteries.

See product for compliance marks specific to this device.



FCC AND IC WARNING

Industry Canada (IC) –

This device contains license-exempt transmitter(s)/receiver(s) that comply with Innovation, Science and Economic Development Canada's license-exempt RSS standard (s). Operation is subject to the following two conditions: (1) this device may not cause interference, and (2) this device must accept any interference, including interference that may cause undesired operation of the device.

Cet appareil contient des émetteurs / récepteurs exemptés de licence conformes à la norme RSS d'Innovation, Sciences et Développement économique Canada. Son fonctionnement est soumis aux deux conditions suivantes: (1) cet appareil ne doit pas causer d'interférences et (2) cet appareil doit accepter toute interférence, y compris les interférences pouvant entraîner un fonctionnement non souhaité de l'appareil.

Federal Communications Commission (FCC) –

Warning: Changes or modifications to this unit not expressly approved by the party responsible for compliance could void the user's authority to operate the equipment.

NOTE: This equipment has been tested and found to comply with the limits for a Class B digital device, pursuant to Part 15 of the FCC Rules. These limits are designed to provide reasonable protection against harmful interference in a residential installation.

This equipment generates, uses and can radiate radio frequency energy and, if not installed and used in accordance with the instructions, may cause harmful interference to radio communications.

However, there is no guarantee that interference will not occur in a particular installation. If this equipment does cause harmful interference to radio or television reception, which can be determined by turning the equipment off and on, the user is encouraged to try to correct the interference by one or more of the following measures:

- Reorient or relocate the receiving antenna.
- Increase the separation between the equipment and receiver.
- Connect the equipment into an outlet on a circuit different from that to which the receiver is connected.
- Consult the dealer or an experienced radio/TV technician for help.



Contact information

IMPORTANT! This Angelcare® monitor is a personal care product. Please do not return this product to the store. If you have questions or need help, please call your distributor before returning this product.

We, at Angelcare®, stand behind all of our products. If you are not completely satisfied or have any questions, please contact your distributor before returning this product:

United States and Canada: Please contact us at: info@angelcarebaby.com

Other countries: Find your local distributor by visiting our website:
angelcarebaby.com/distributeurs

TO LEARN MORE

To learn more, watch the **set-up videos** and other functionalities on our website.

<https://angelcare.zendesk.com/how-to-video>

www.angelcarebaby.com

Angelcare Monitors Inc.

201, boulevard de l'Industrie, local 104
Candiac (Quebec) J5R 6A6
Canada

IM327-ROW-201018

