



Valued Quality. Delivered.

TEST REPORT

Report Number: 15071310HKG-001

Application
for
Original Grant of 47 CFR Part 15 Certification
RSS-247 Issue 1 Equipment Certification

Video Baby Monitor - Baby Unit

FCC ID: N7TAC1300T

IC: 5786A-AC1300T

Prepared and Checked by:

Approved by:

Signed on File

Josie Yao
Engineer

Koo Wai Ip
Assistant Supervisor
September 24, 2015

- Intertek's standard Terms and Conditions can be obtained at our website: <http://www.intertek.com/terms/>.
- The test report only allows to be revised within the retention period unless further standard or the requirement was noticed.
- This report is for the exclusive use of Intertek's Client and is provided pursuant to the agreement between Intertek and its Client. Intertek's responsibility and liability are limited to the terms and conditions of the agreement. Intertek assumes no liability to any party, other than to the Client in accordance with the agreement, for any loss, expense or damage occasioned by the use of this report. Only the Client is authorized to permit copying or distribution of this report and then only in its entirety. Any use of the Intertek name or one of its marks for the sale or advertisement of the tested material, product or service must first be approved in writing by Intertek. The observations and test results in this report are relevant only to the sample tested. This report by itself does not imply that the material, product, or service is or has ever been under an Intertek certification program.

Intertek Testing Services Hong Kong Ltd.

2/F., Garment Centre, 576 Castle Peak Road, Kowloon, Hong Kong.
Tel: (852) 2173 8888 Fax: (852) 2785 5487 Website: www.hk.intertek-ettsemko.com

INTERTEK TESTING SERVICES

GENERAL INFORMATION

Applicant Name:	Angelcare Monitors Inc.
Applicant Address:	201 Boul. De l'industrie, Local 104, Candiac, Quebec, J5R 6A6, Canada
FCC Specification Standard:	FCC Part 15, October 1, 2014 Edition
FCC ID:	N7TAC1300T
FCC Model(s):	AC1300, AC1320
IC Specification Standard:	RSS-247 Issue 1, May 2015 RSS-Gen Issue 4, December 2014
IC:	5786A-AC1300T
IC Model(s):	AC1300, AC1320
Type of EUT:	Spread Spectrum Transmitter
Description of EUT:	Video Baby Monitor - Baby Unit
Serial Number:	N/A
Sample Receipt Date:	July 24, 2015
Date of Test:	July 27, 2015 to September 05, 2015
Report Date:	September 24, 2015
Environmental Conditions:	Temperature: +10 to 40°C Humidity: 10 to 90%

INTERTEK TESTING SERVICES

Table of Contents

1.0 Test Results Summary & Statement of Compliance	4
1.1 Summary of Test Results	4
1.2 Statement of Compliance	4
2.0 General Description	6
2.1 Product Description	6
2.2 Test Methodology	6
2.3 Test Facility	6
3.0 System Test Configuration	8
3.1 Justification	8
3.2 EUT Exercising Software	9
3.3 Details of EUT and Description of Accessories	10
3.4 Measurement Uncertainty	10
4.0 Test Results	12
4.1 Maximum Conducted Output Power at Antenna Terminals	12
4.2 Maximum 20 dB RF Bandwidth	15
4.3 Minimum Number of Hopping Frequencies	18
4.4 Minimum Hopping Channel Carrier Frequency Separation	20
4.5 Average Channel Occupancy Time	22
4.6 Out of Band Conducted Emissions	25
4.7 Field Strength Calculation	30
4.8 Transmitter Radiated Emissions in Restricted Bands and Spurious Emissions	31
4.8.1 Radiated Emission Configuration Photograph	32
4.8.2 Radiated Emission Data	32
4.8.3 Transmitter Duty Cycle Calculation	38
4.9 AC Power Line Conducted Emission	40
4.9.1 AC Power Line Conducted Emission Configuration Photograph	40
4.9.2 AC Power Line Conducted Emission Data	40
5.0 Equipment List	43

INTERTEK TESTING SERVICES

**EXHIBIT 1
TEST RESULTS SUMMARY & STATEMENT OF COMPLIANCE**

INTERTEK TESTING SERVICES

1.0 Test Results Summary & Statement of Compliance

1.1 Summary of Test Results

Test Items	FCC Part 15 Section	RSS-247/ RSS-Gen [#] Section	Results	Details see section
Antenna Requirement	15.203	8.3 [#]	Pass	2.1
Max. Conducted Output Power	15.247(b)(1)	5.4(2)	Pass	4.1
Max. 20dB RF Bandwidth	15.247(a)(1)(iii)	5.1(1)	Pass	4.2
Min. No. of Hopping Frequencies	15.247(a)(1)(iii)	5.1(4)	Pass	4.3
Min. Hopping Channel Carrier Frequency Separation	15.247(a)(1)	5.1(2)	Pass	4.4
Average Time of Occupancy	15.247(a)(1)(iii)	5.1(4)	Pass	4.5
Out of Band Antenna Conducted Emission	15.247(d)	5.5	Pass	4.6
Radiated Emission in Restricted Bands and Spurious Emissions	15.247(d) & 15.209	8.10 [#]	Pass	4.8
AC Power Line Conducted Emission	15.207	8.8 [#]	Pass	4.9

Note: Pursuant to FCC Part 15 Section 15.215(c), the 20dB bandwidth of the emission was contained within the frequency band designated (mentioned as above) which the EUT operated. The effects, if any, from frequency sweeping, frequency hopping, other modulation techniques and frequency stability over expected variations in temperature and supply voltage were considered.

1.2 Statement of Compliance

The equipment under test is found to be complying with the following standards:

FCC Part 15, October 1, 2014 Edition
RSS-247 Issue 1, May 2015
RSS-Gen Issue 4, December 2014

INTERTEK TESTING SERVICES

**EXHIBIT 2
GENERAL DESCRIPTION**

INTERTEK TESTING SERVICES

2.0 General Description

2.1 Product Description

The Equipment Under Test (EUT) is a 2.4GHz Frequency Hopping Spread Spectrum Baby Unit of Video Baby Monitor. It operates at frequency range of 2410.875MHz to 2471.625MHz. There are total 19 channels. The EUT is powered by a 100-240VAC to 5.0VDC 500mA AC adaptor or 3 x "AA" size 1.5VDC Alkaline batteries.

The Model: AC1320 is the same as the Model: AC1300 in electronics/electrical designs, including software & firmware, construction design/physical design/enclosure and PCB layout. The only differences between these models are model number, color and Model: AC1300 equipped with sensor pad, while Model AC1320 does not for marketing purpose.

The antenna(s) used in the EUT is integral, and the test sample is a prototype.

The circuit description and frequency hopping algorithm are saved with filename: descri.pdf.

2.2 Test Methodology

Both AC power line-conducted and radiated emission measurements were performed according to the procedures in ANSI C63.4 (2014). Preliminary radiated scans and all radiated measurements were performed in radiated emission test sites. All Radiated tests were performed at an antenna to EUT distance of 3 meters, unless stated otherwise in the "**Justification Section**" of this Application. Antenna port conducted measurements were performed according to ANSI C63.10 (2013). All other measurements were made in accordance with the procedures in 47 CFR Part 2.

2.3 Test Facility

The radiated emission test site and antenna port conducted measurement facility used to collect the radiated data and conductive data are at Workshop No. 3, G/F., World-Wide Industrial Centre, 43-47 Shan Mei Street, Fo Tan, Sha Tin, N.T., Hong Kong. This test facility and site measurement data have been fully placed on file with FCC and Industry Canada.

INTERTEK TESTING SERVICES

**EXHIBIT 3
SYSTEM TEST CONFIGURATION**

INTERTEK TESTING SERVICES

3.0 System Test Configuration

3.1 Justification

For radiated emissions testing, the equipment under test (EUT) was setup to transmit / receive continuously to simplify the measurement methodology. Care was taken to ensure proper power supply voltages during testing. During testing, all cables (if any) were manipulated to produce worst case emissions.

The Baby Unit was powered by a 100-240VAC to 5.0VDC 500mA adaptor or 3 x "AA" size 1.5VDC Alkaline batteries.

For the measurements, the EUT was attached to a plastic stand if necessary and placed on the wooden turntable. If the baby unit attached to peripherals, they were connected and operational (as typical as possible). The parent unit was remotely located as far from the antenna and the baby as possible to ensure full power transmission from the baby unit. Else, the baby was wired to transmit full power with modulation.

The signal was maximized through rotation and placement in the three orthogonal axes. The antenna height and polarization were varied during the search for maximum signal level. The antenna height was varied from 1 to 4 meters. Radiated emissions were taken at three meters unless the signal level was too low for measurement at that distance. If necessary, a pre-amplifier was used and/or the test was conducted at a closer distance.

For any intentional radiator powered by AC power line, measurements of the radiated signal level of the fundamental frequency component of the emission was performed with the supply voltage varied between 85% and 115% of the nominal rated supply voltage.

For transmitter radiated measurement, the spectrum analyzer resolution bandwidth was 100 kHz for frequencies below 1000 MHz. The resolution bandwidth was 1 MHz for frequencies above 1000 MHz.

Radiated emission measurement for transmitter were performed from the lowest radio frequency signal generated in the device which is greater than 9 kHz to the tenth harmonic of the highest fundamental frequency or to 40 GHz, whichever is lower.

Emission that are directly caused by digital circuits in the transmit path and transmitter portion were measured, and the limit are according to FCC Part 15 Section 15.209. Digital circuitry used to control additional functions other than the operation of the transmitter is subject to FCC Part Section 15.109 Limits.

INTERTEK TESTING SERVICES

3.1 Justification - Cont'd

Detector function for radiated emissions was in peak mode. Average readings, when required, were taken by measuring the duty cycle of the equipment under test and subtracting the corresponding amount in dB from the measured peak readings. A detailed description for the calculation of the average factor can be found in section 4.8.3.

Determination of pulse desensitization was made according to *Hewlett Packard Application Note 150-2, Spectrum Analysis... Pulsed RF*. The effective period (Teff) was referred to Exhibit 4.8.3. With the resolution bandwidth 1MHz and spectrum analyzer IF bandwidth 3dB, the pulse desensitization factor was 0dB.

For AC line conducted emission test, the EUT along with its peripherals were placed on a 1.0m(W)x1.5m(L) and 0.8m in height wooden table and the EUT was adjusted to maintain a 0.4 meter space from a vertical reference plane. The EUT was connected to power mains through a line impedance stabilization network (LISN), which provided 50ohm coupling impedance for measuring instrument. The LISN housing, measuring instrument case, reference ground plane, and vertical ground plane were bounded together. The excess power cable between the EUT and the LISN was bundled.

All connecting cables of EUT and peripherals were manipulated to find the maximum emission.

All relevant operation modes have been tested, and the worst case data is included in this report.

3.2 EUT Exercising Software

The EUT exercise program used during radiated and conducted testing was designed to exercise the various system components in a manner similar to a typical use.

INTERTEK TESTING SERVICES

3.3 Details of EUT and Description of Accessories

Details of EUT:

An AC adaptor (provided with the unit) was used to power the device. Their description are listed below.

- (1) An AC adaptor (100-240VAC to 5.0VDC 500mA, Model: T05005U002) (Supplied by Client)
- (2) Operated Battery: 3 x "AA" size 1.5VDC Alkaline batteries (Supplied by Client)

Description of Accessories:

- (1) Angelcare Parent Unit, Model: AC1300, FCC ID: N7TAC1300R (Supplied by Client)
- (2) Angelcare Sensor Pad (Supplied by Client)

3.4 Measurement Uncertainty

When determining of the test conclusion, the Measurement Uncertainty of test at a level of confidence of 95% has been considered. The values of the Measurement uncertainty for radiated emission test and RF conducted measurement test are $\pm 5.3\text{dB}$ and $\pm 0.99\text{dB}$ respectively. The value of the Measurement uncertainty for conducted emission test is $\pm 4.2\text{dB}$.

Uncertainty and Compliance - Unless the standard specifically states that measured values are to be extended by the measurement uncertainty in determining compliance, all compliance determinations are based on the actual measured value.

INTERTEK TESTING SERVICES

**EXHIBIT 4
TEST RESULTS**

INTERTEK TESTING SERVICES

4.0 Test Results

RF Conducted measurement Test Setup by a Spectrum Analyzer.

The figure below shows the test setup, which is utilized to make these measurements.

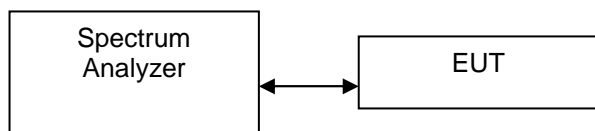

4.1 Maximum Conducted (peak) Output Power at Antenna Terminals

- The antenna power of the EUT was connected to the input of a power meter. Power was read directly and cable loss correction was added to the reading to obtain power at the EUT antenna terminals.
- The antenna port of the EUT was connected to the input of a spectrum analyzer. The analyzer was set for RBW>20dB bandwidth and power was read directly in dBm. External attenuation and cable loss were compensated for using the OFFSET function of the analyser.

Antenna Gain = 2dBi		
Frequency (MHz)	Output in dBm	Output in mW
Low Channel: 2410.875	15.40	34.674
Middle Channel: 2441.250	15.10	32.359
High Channel: 2471.625	15.16	32.809

Cable loss / external attenuation : 0.5 dB

Cable loss, external attenuation: included in OFFSET function
 added to SA raw reading

dBm max. output level = 15.40 dBm

Limits:

- 0.125W (21dBm) for antennas with gains of 6dBi or less
- 0.25W (24dBm) for antennas with gains of 6dBi or less
- 1W (30dBm) for antennas with gains of 6dBi or less
- ___W (___dBm) for antennas with gains more than 6dBi

The plots of conducted output power are saved as below.

INTERTEK TESTING SERVICES

Plots of conducted output power

Lowest Channel

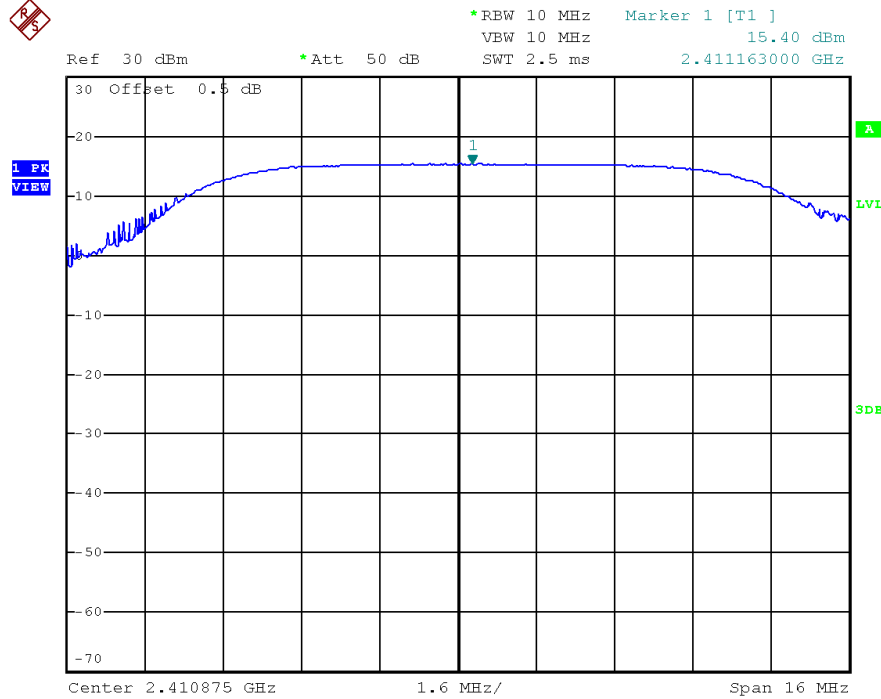

Middle Channel

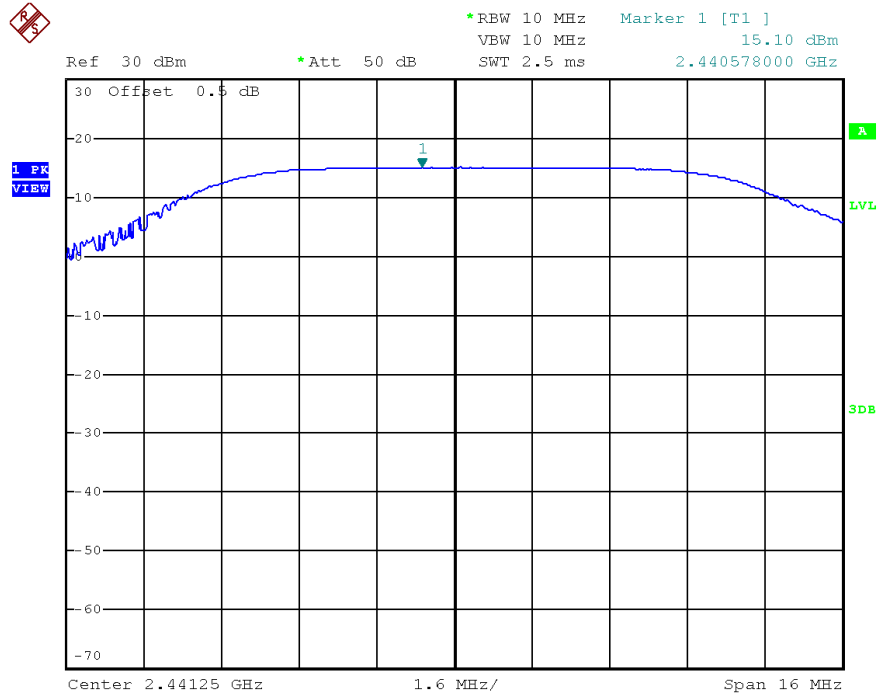

INTERTEK TESTING SERVICES

Plots of conducted output power

Highest Channel

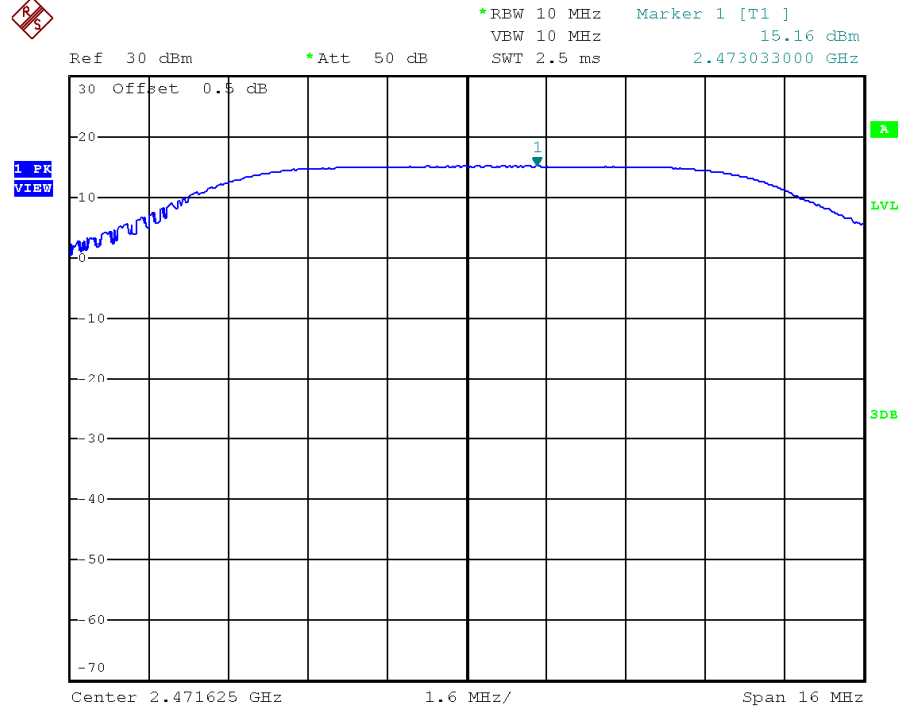

INTERTEK TESTING SERVICES

RF Conduct measurement Test Setup

The figure below shows the test setup, which is utilized to make these measurements.

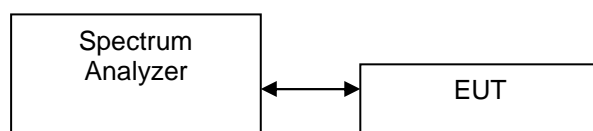

4.2 Minimum 6dB RF Bandwidth

The antenna port of the EUT was connected to the input of a spectrum analyzer. Analyzer RES BW was chosen so that the display was a result of the hopping channel modulation. For each RF output channel investigated, the spectrum analyzer center frequency was set to the channel carrier. A PEAK output reading was taken, a DISPLAY line was drawn 20 dB lower than PEAK level. The 20 dB bandwidth was determined from where the channel output spectrum intersected the display line.

Frequency (MHz)	20 dB Bandwidth (kHz)
Low Channel: 2410.875	3360
Middle Channel: 2441.250	3280
High Channel: 2471.625	3360

Limits

- $\leq 500\text{kHz}$ for 902-928MHz
- N/A for 2400-2483.5MHz
- $\leq 1\text{MHz}$ for 5725-5850MHz

The plots of 20dB RF bandwidth and occupied bandwidth are saved as below.

INTERTEK TESTING SERVICES

Plots of 20dB RF bandwidth

Lowest Channel

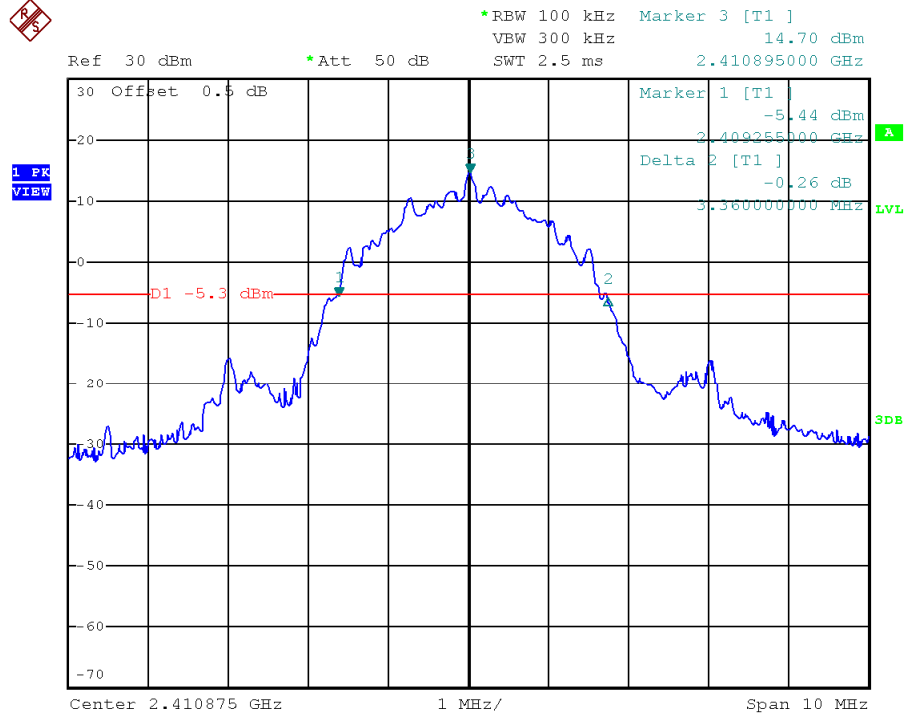

Middle Channel

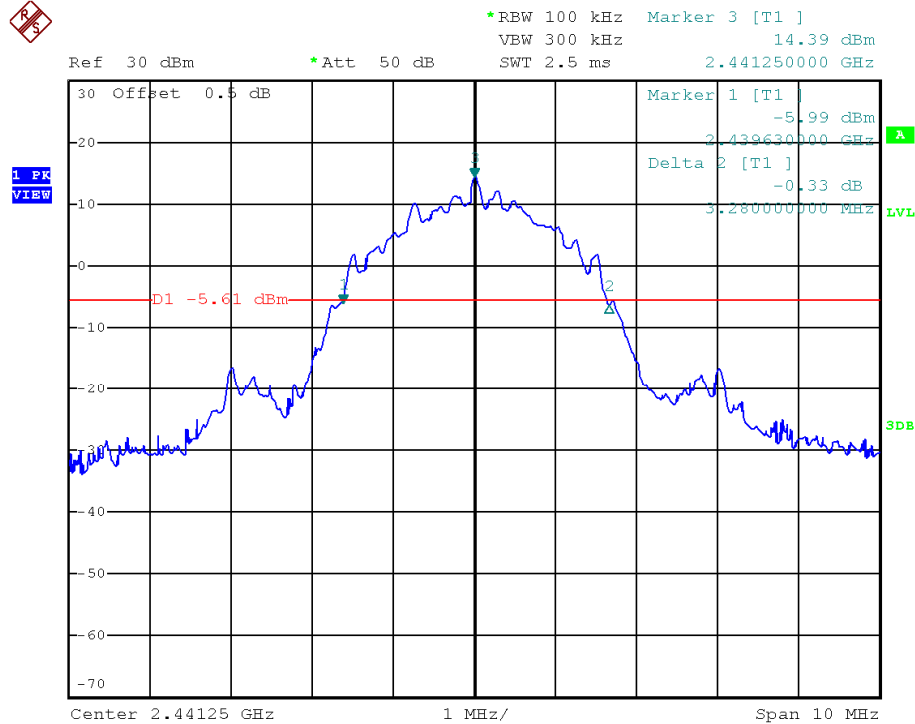

INTERTEK TESTING SERVICES

Plots of 20dB RF bandwidth

Highest Channel

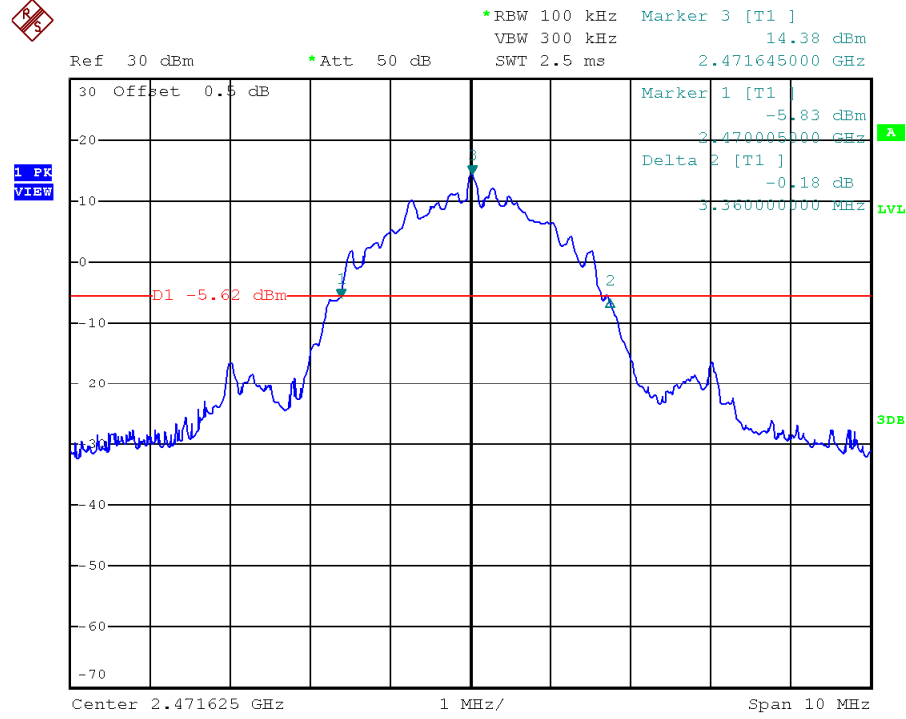

INTERTEK TESTING SERVICES

4.3 Minimum Number of Hopping Frequencies

With the analyzer set to MAX HOLD readings were taken for 2-3 minutes in each band. The channel peaks so recorded were added together, and the total number compared to the minimum number of channels required in the regulation.

No. of hopping channels	19
-------------------------	----

Minimum Requirements:

- at least 50 hopping channels for 902MHz-928MHz (20 dB bandwidth of hopping channel < 250kHz)
- at least 25 hopping channels for 902MHz-928MHz (20 dB bandwidth of hopping channel \geq 250kHz)
- at least 15 hopping channels for 2400MHz-2483.5MHz.
- at least 75 hopping channels for 5725MHz-5850MHz.

The plots of number of hopping frequencies are saved as below.

INTERTEK TESTING SERVICES

4.4 Minimum Hopping Channel Carrier Frequency Separation

Using the DELTA MARKER function of the analyzer, the frequency separation between two adjacent channels was measured and met the requirement.

Baby Unit	
The two adjacent channels being measured	Channel Separation (kHz)
Channel 1 & Channel 2	3380

Limits:

The channel separation must be larger than:

- 25 kHz
- 20 dB bandwidth of hopping channel: 3360kHz
- 2/3 of 20dB bandwidth of hopping channel: 2240Hz

The plot(s) of hopping channel carrier frequency separation is saved as below.

INTERTEK TESTING SERVICES

Plots of hopping channel carrier frequency separation

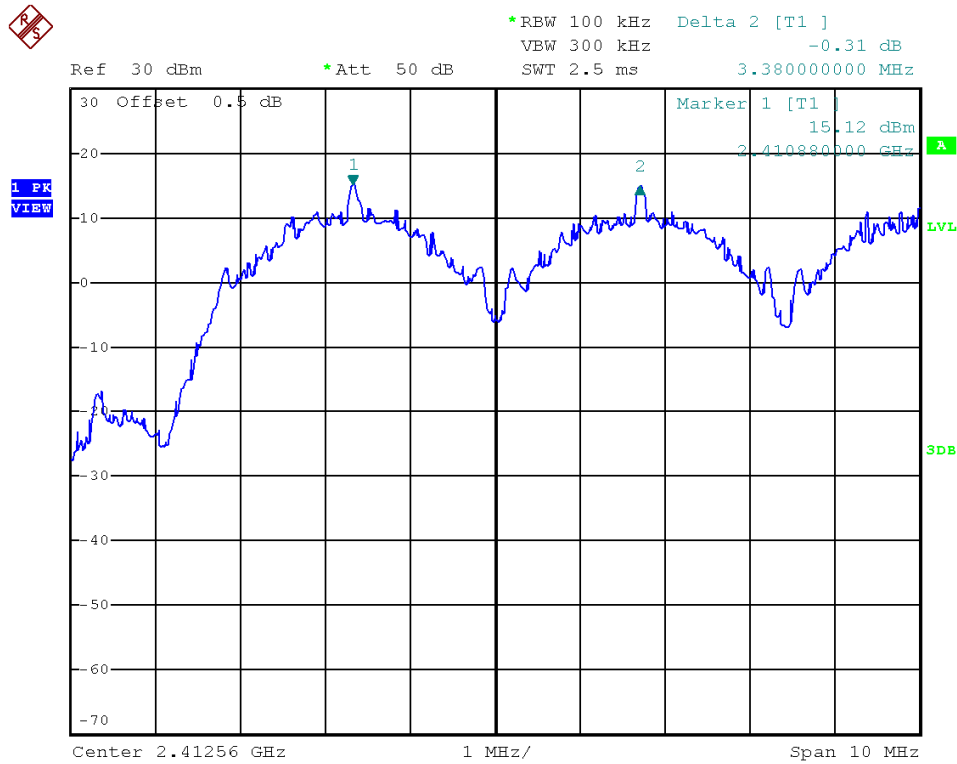

INTERTEK TESTING SERVICES

4.5 Average Channel Occupancy Time

The spectrum analyzer center frequency was set to one of the known hopping channels. The SWEEP was set to 10ms, the SPAN was set to ZERO SPAN, and the TRIGGER was set to VIDEO. The time duration of the transmission so captured was measured with the MARKER DELTA function.

The SWEEP was then set to the time required by the regulation (20 seconds for 902-928 MHz devices, if the 20dB bandwidth is less than 250kHz, 10 seconds for 902-928 MHz if the 20dB bandwidth is or greater than 250kHz, "0.4 seconds x Number of hopping channels employed" seconds for 2400-2483.5 MHz, 30 seconds for 5725-5850 MHz). The analyzer was set to SINGLE SWEEP, the total ON time was added and compared against the limit (0.4 seconds).

Baby Unit (worst-case:)	
Average Occupancy Time = $0.812\text{ms} \times 50 \times 7.6$	308.56ms

Limits:

Average 0.4 seconds maximum occupancy in:

- 7.6 seconds (0.4 sec. x 19) for 2400MHz-2483.5MHz
- 20 seconds for 902MHz-928MHz \geq 50 hopping channels
- 10 seconds for 902MHz-928MHz \geq 25 hopping channels
- 30 seconds for 5725-5850MHz

The plots of average channel occupancy time are saved as below.

INTERTEK TESTING SERVICES

Plots of average channel occupancy time

Plot A

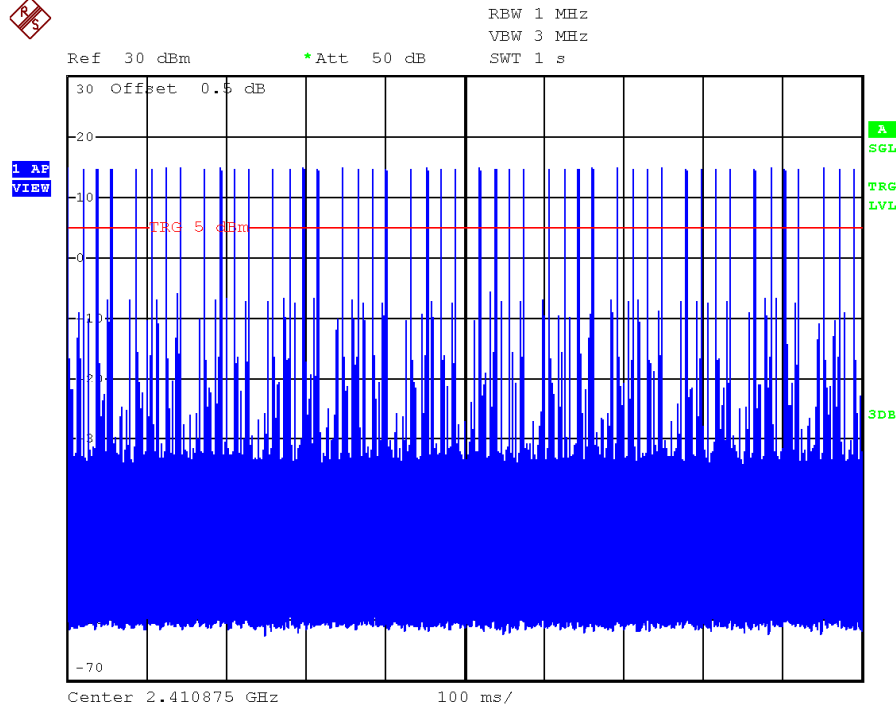

Plot B

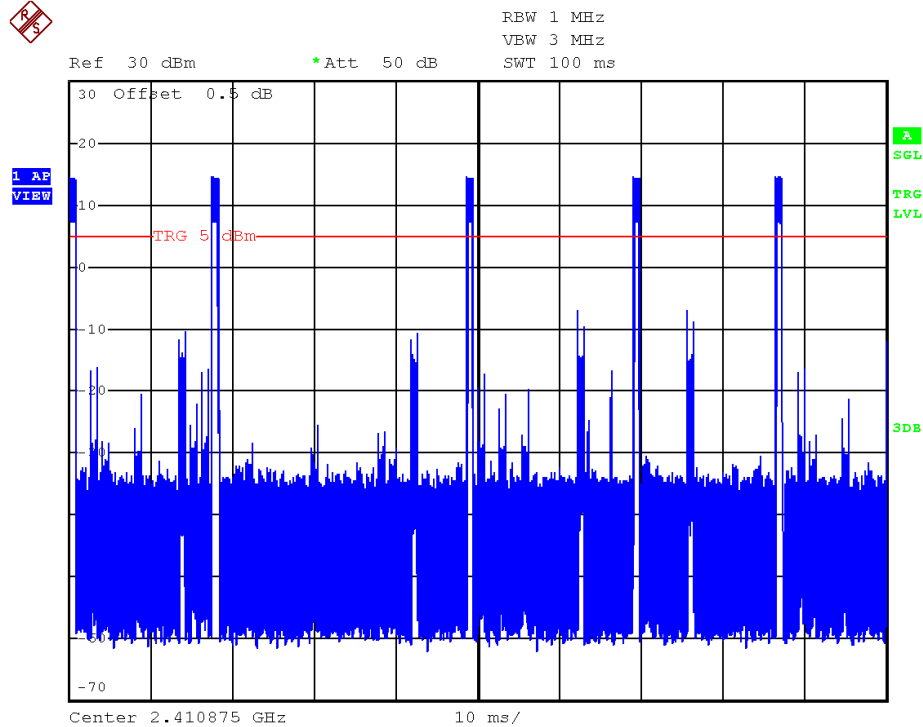

INTERTEK TESTING SERVICES

Plots of average channel occupancy time

Plot C

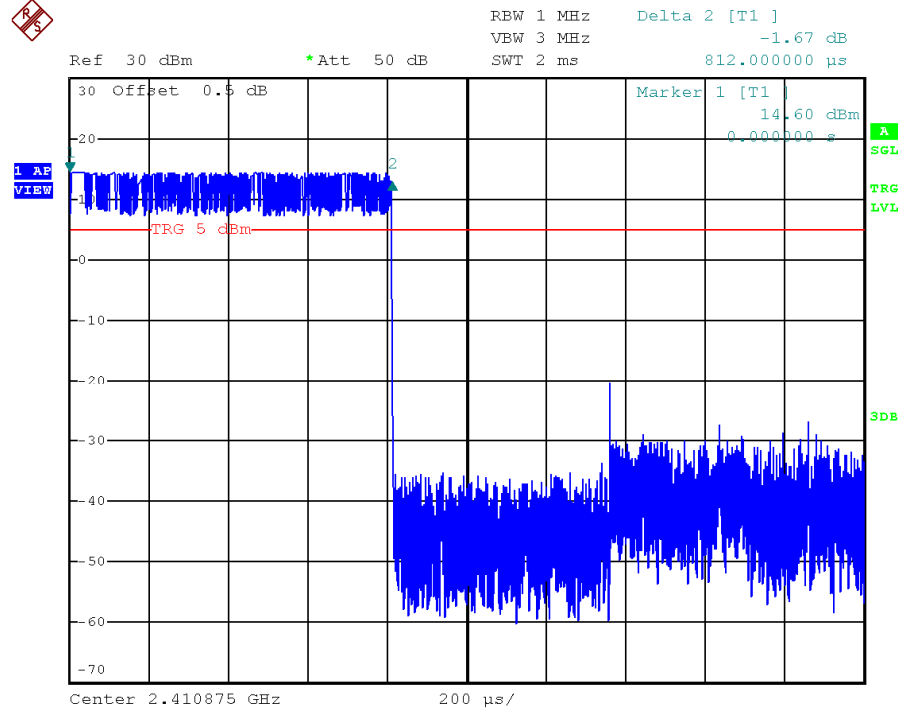

INTERTEK TESTING SERVICES

4.6 Out of Band Conducted Emissions

In any 100 kHz bandwidth outside the EUT passband, the RF power produced by the modulation products of the spreading sequence, the information sequence, and the carrier frequency shall be at least 20 dB below that of the maximum in-band 100 kHz emission.

The plot(s) of bandedge compliance is shown the worst-case which has been already considered between enable and disable the hopping function of the EUT.

Limits:

All spurious emission and up to the tenth harmonic was measured and they were found to be at least 20 dB below the highest level of the desired power in the passband.

The plots of out of band conducted emissions are saved as below.

Plots of out of band conducted emissions

Lowest channel, Plot 1

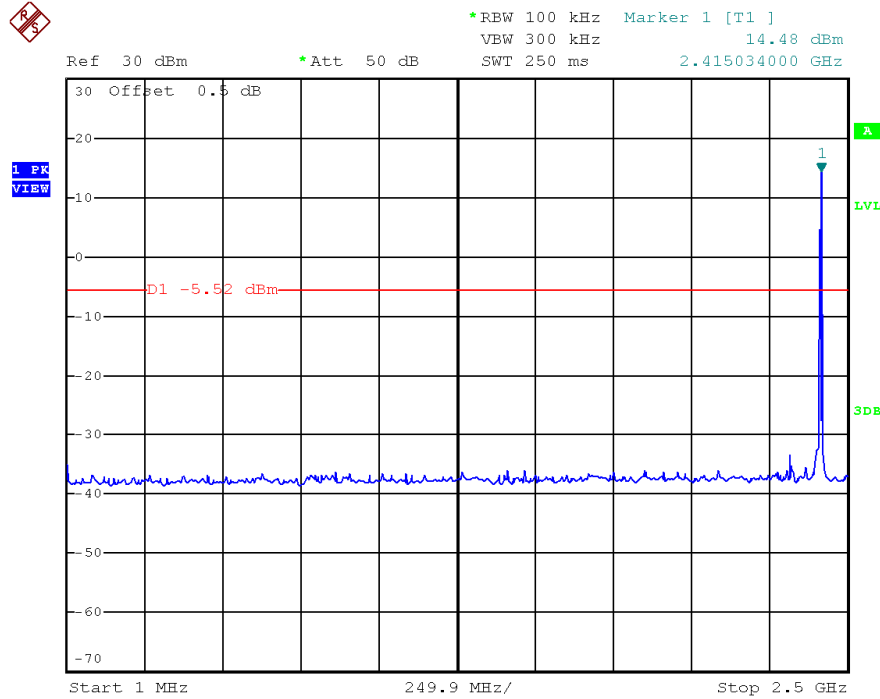

Lowest channel, Plot 2

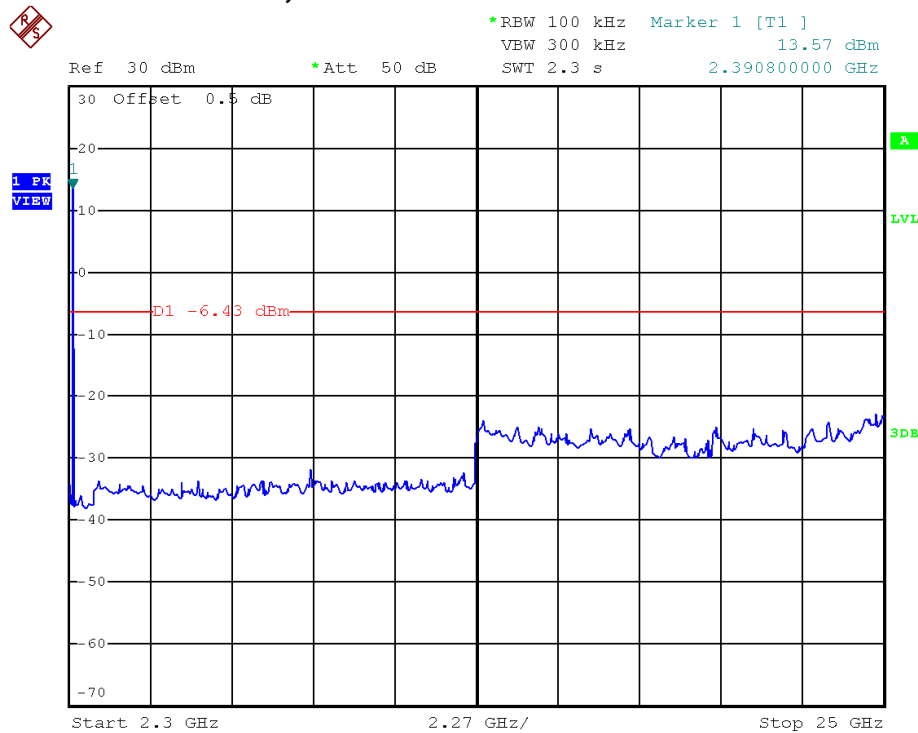

INTERTEK TESTING SERVICES

Plots of out of band conducted emissions

Middle channel, Plot 1

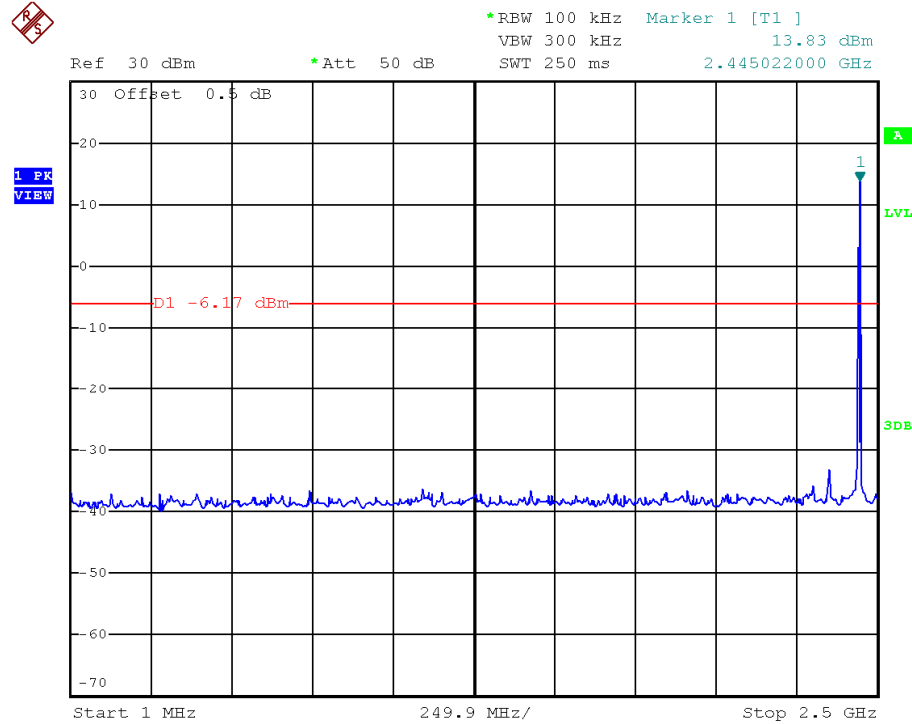

Middle channel, Plot 2

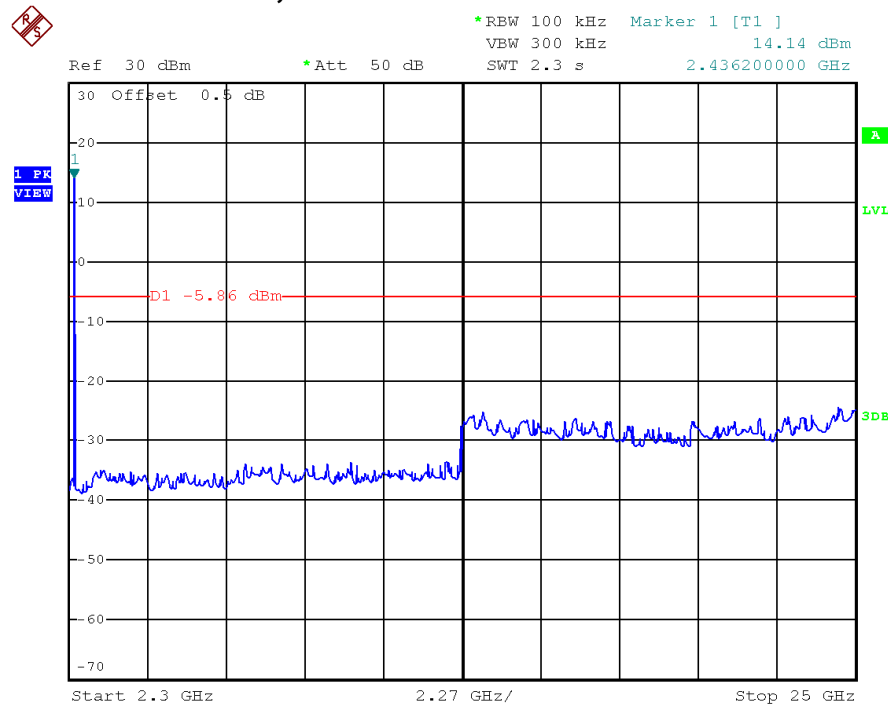

Plots of out of band conducted emissions

Highest channel, Plot 1

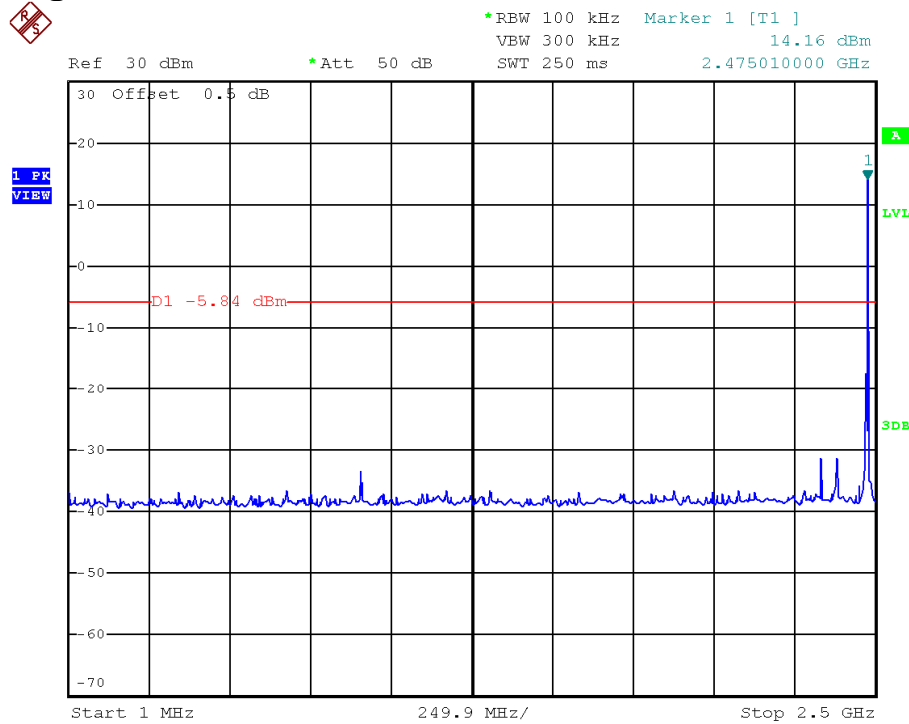

Highest channel, Plot 2

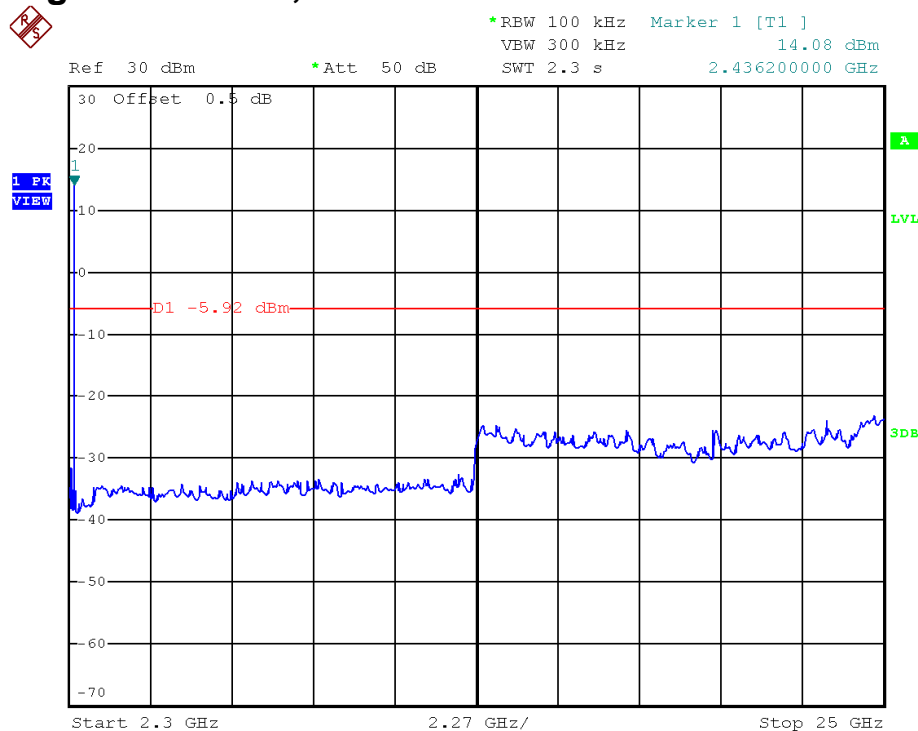

INTERTEK TESTING SERVICES

Plots of bandedge emissions

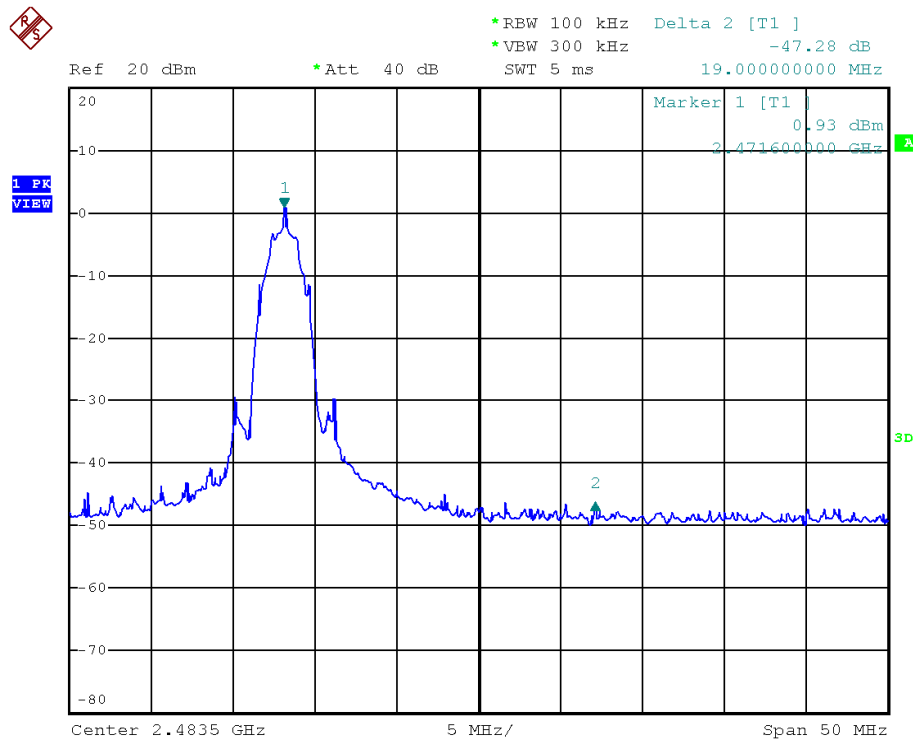
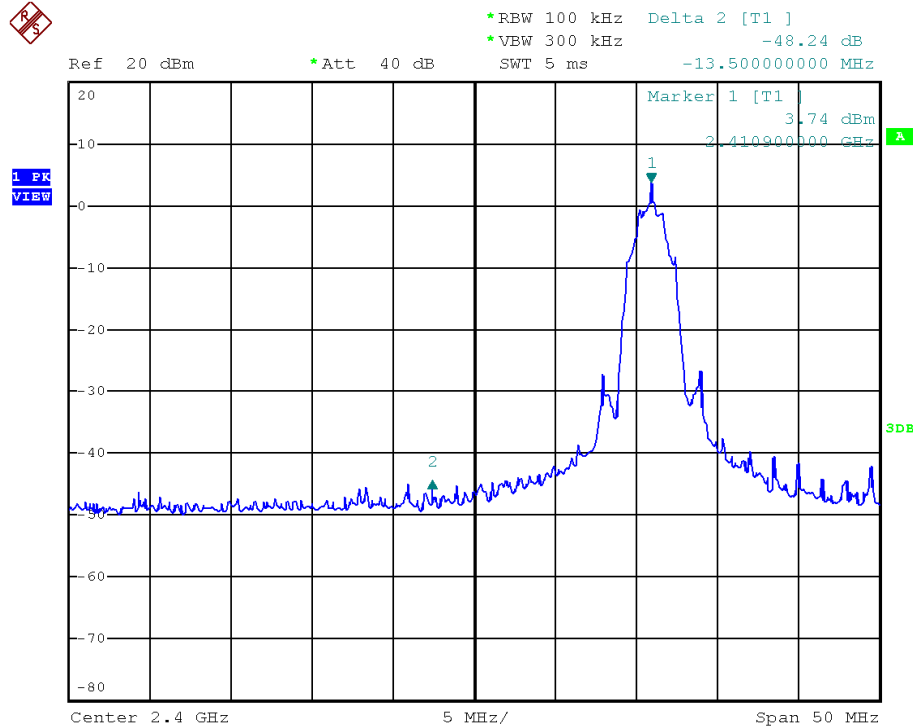

INTERTEK TESTING SERVICES

4.7 Field Strength Calculation

The field strength is calculated by adding the reading on the Spectrum Analyzer to the factors associated with preamplifiers (if any), antennas, cables, pulse desensitization and average factors (when specified limit is in average and measurements are made with peak detectors). A sample calculation is included below.

$$FS = RA + AF + CF - AG + PD + AV$$

where

- FS = Field Strength in dB μ V/m
- RA = Receiver Amplitude (including preamplifier) in dB μ V
- CF = Cable Attenuation Factor in dB
- AF = Antenna Factor in dB
- AG = Amplifier Gain in dB
- PD = Pulse Desensitization in dB
- AV = Average Factor in -dB

In the radiated emission table which follows, the reading shown on the data table may reflect the preamplifier gain. An example of the calculations, where the reading does not reflect the preamplifier gain, follows:

$$FS = RA + AF + CF - AG + PD + AV$$

Example

Assume a receiver reading of 62.0 dB μ V is obtained. The antenna factor of 7.4 dB and cable factor of 1.6 dB is added. The amplifier gain of 29 dB is subtracted. The pulse desensitization factor of the spectrum analyzer was 0 dB, and the resultant average factor was -10 dB. The net field strength for comparison to the appropriate emission limit is 32 dB μ V/m. This value in dB μ V/m was converted to its corresponding level in μ V/m.

$$\begin{aligned} RA &= 62.0 \text{ dB}\mu\text{V} \\ AF &= 7.4 \text{ dB} \\ CF &= 1.6 \text{ dB} \\ AG &= 29 \text{ dB} \\ PD &= 0 \text{ dB} \\ AV &= -10 \text{ dB} \\ FS &= 62 + 7.4 + 1.6 - 29 + 0 + (-10) = 32 \text{ dB}\mu\text{V/m} \end{aligned}$$

$$\text{Level in } \mu\text{V/m} = \text{Common Antilogarithm} [(32 \text{ dB}\mu\text{V/m})/20] = 39.8 \mu\text{V/m}$$

INTERTEK TESTING SERVICES

4.8 Transmitter Radiated Emissions in Restricted Bands and Spurious Emissions

Data is included of the worst case configuration (the configuration which resulted in the highest emission levels). A sample calculation, configuration photographs and data tables of the emissions are included.

The data on the following pages list the significant emission frequencies, the limit and the margin of compliance.

INTERTEK TESTING SERVICES

4.8.1 Radiated Emission Configuration Photograph

Worst Case Restricted Band Radiated Emission
at

699.972 MHz

The worst case radiated emission configuration photographs are attached in the Appendix and saved with filename: config photos.pdf

4.8.2 Radiated Emission Data

The data in tables 1-5 list the significant emission frequencies, the limit and the margin of compliance.

Judgement -

Passed by 2.4 dB margin

INTERTEK TESTING SERVICES

4.8.3 Radiated Emission Test Setup

The figure below shows the test setup, which is utilized to make these measurements.

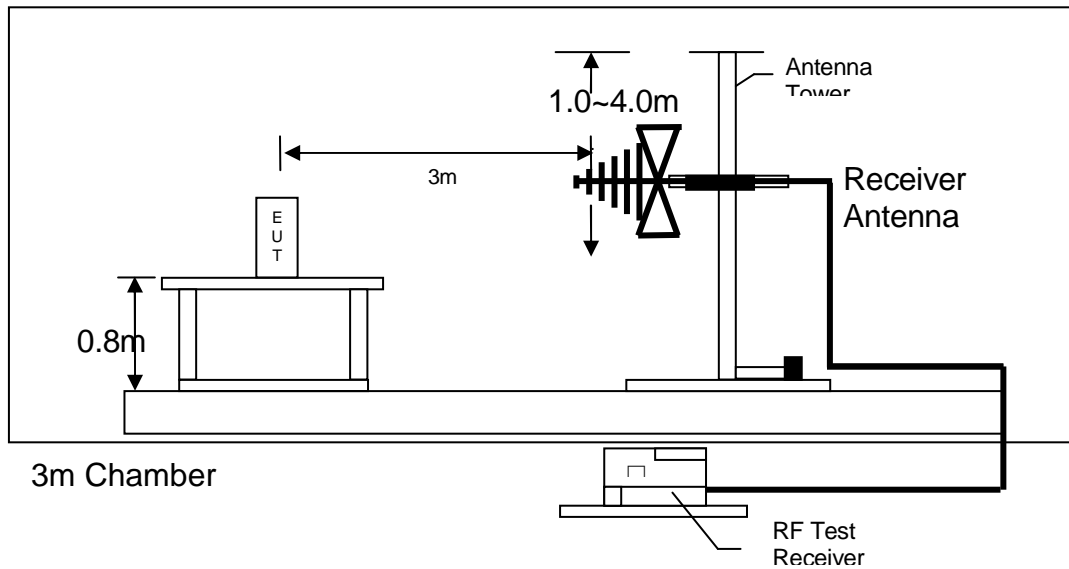

Test setup of radiated emissions up to 1GHz

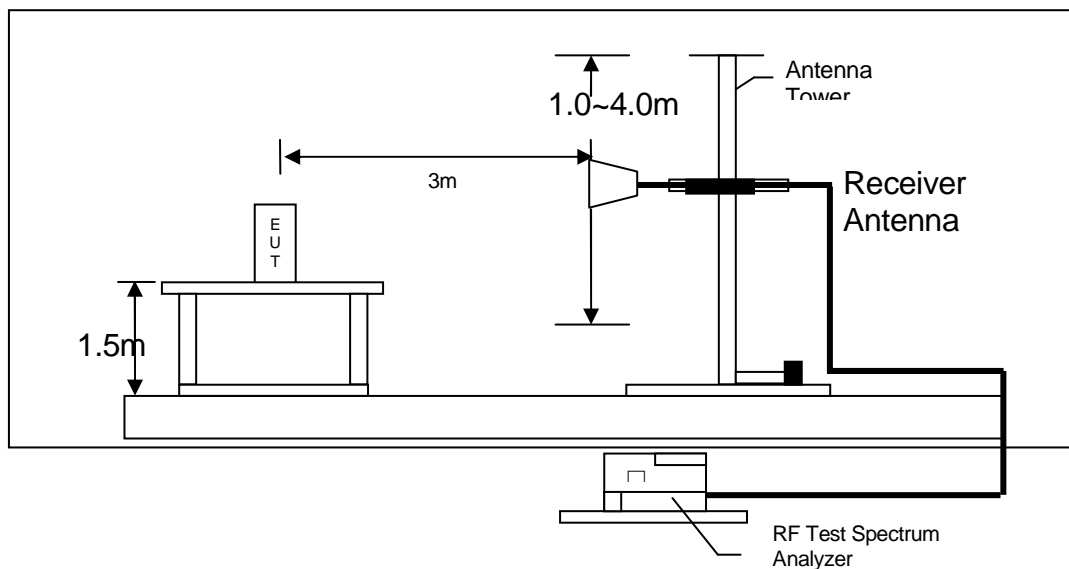

Test setup of radiated emissions above 1GHz

INTERTEK TESTING SERVICES

Mode: TX-Channel 01

Table 1

Radiated Emission Data

Polarization	Frequency (MHz)	Reading (dB μ V)	Pre-Amp Gain (dB)	Antenna Factor (dB)	Net at 3m - Peak (dB μ V/m)	Average Factor (dB)	Calculated at 3m (dB μ V/m)	Average Limit at 3m (dB μ V/m)	Margin (dB)
V	4821.750	55.4	33	34.9	57.3	27.8	29.5	54.0	-24.5
V	7232.625	54.6	33	37.9	59.5	27.8	31.7	54.0	-22.3
V	12054.375	52.2	33	40.5	59.7	27.8	31.9	54.0	-22.1

Polarization	Frequency (MHz)	Reading (dB μ V)	Pre-Amp Gain (dB)	Antenna Factor (dB)	Net at 3m - Peak (dB μ V/m)	Peak Limit at 3m (dB μ V/m)	Margin (dB)
V	4821.750	55.4	33	34.9	57.3	74.0	-16.7
V	7232.625	54.6	33	37.9	59.5	74.0	-14.5
V	12054.375	52.2	33	40.5	59.7	74.0	-14.3

- NOTES:
1. Peak detector is used for the emission measurement.
 2. All measurements were made at 3 meters. Radiated emissions not detected at the 3-meter distance were measured at 0.3-meter and an inverse proportional extrapolation was performed to compare the signal level to the 3-meter limit. No other radiated emissions than those reported were detected at a test distance of 0.3-meter.
 3. Negative value in the margin column shows emission below limit.
 4. Horn antenna is used for the emission over 1000MHz.
 5. Emission (the row indicated by **bold italic**) within the restricted band meets the requirement of FCC Part 15 Section 15.205 / RSS-GEN Section 8.10.

INTERTEK TESTING SERVICES

Mode: TX-Channel 11

Table 2

Radiated Emission Data

Polarization	Frequency (MHz)	Reading (dBμV)	Pre-Amp Gain (dB)	Antenna Factor (dB)	Net at 3m - Peak (dBμV/m)	Average Factor (dB)	Calculated at 3m (dBμV/m)	Average Limit at 3m (dBμV/m)	Margin (dB)
V	4882.500	55.6	33	34.9	57.5	27.8	29.7	54.0	-24.3
V	7323.750	54.8	33	37.9	59.7	27.8	31.9	54.0	-22.1
V	12206.250	52.4	33	40.5	59.9	27.8	32.1	54.0	-21.9

Polarization	Frequency (MHz)	Reading (dBμV)	Pre-Amp Gain (dB)	Antenna Factor (dB)	Net at 3m - Peak (dBμV/m)	Peak Limit at 3m (dBμV/m)	Margin (dB)
V	4882.500	55.6	33	34.9	57.5	74.0	-16.5
V	7323.750	54.8	33	37.9	59.7	74.0	-14.3
V	12206.250	52.4	33	40.5	59.9	74.0	-14.1

- NOTES:
1. Peak detector is used for the emission measurement.
 2. All measurements were made at 3 meters. Radiated emissions not detected at the 3-meter distance were measured at 0.3-meter and an inverse proportional extrapolation was performed to compare the signal level to the 3-meter limit. No other radiated emissions than those reported were detected at a test distance of 0.3-meter.
 3. Negative value in the margin column shows emission below limit.
 4. Horn antenna is used for the emission over 1000MHz.
 5. Emission (the row indicated by **bold italic**) within the restricted band meets the requirement of FCC Part 15 Section 15.205 / RSS-GEN Section 8.10.

INTERTEK TESTING SERVICES

Mode: TX-Channel 19

Table 3

Radiated Emission Data

Polarization	Frequency (MHz)	Reading (dBμV)	Pre-Amp Gain (dB)	Antenna Factor (dB)	Net at 3m - Peak (dBμV/m)	Average Factor (dB)	Calculated at 3m (dBμV/m)	Average Limit at 3m (dBμV/m)	Margin (dB)
V	2483.500	65.1	33	29.4	61.5	27.8	33.7	54.0	-20.3
V	4943.250	55.6	33	34.9	57.5	27.8	29.7	54.0	-24.3
V	7414.875	53.8	33	37.9	58.7	27.8	30.9	54.0	-23.1
V	12358.125	52.4	33	40.5	59.9	27.8	32.1	54.0	-21.9

Polarization	Frequency (MHz)	Reading (dBμV)	Pre-Amp Gain (dB)	Antenna Factor (dB)	Net at 3m - Peak (dBμV/m)	Peak Limit at 3m (dBμV/m)	Margin (dB)
V	2483.500	65.1	33	29.4	61.5	74.0	-12.5
V	4943.250	55.6	33	34.9	57.5	74.0	-16.5
V	7414.875	53.8	33	37.9	58.7	74.0	-15.3
V	12358.125	52.4	33	40.5	59.9	74.0	-14.1

- NOTES: 1. Peak detector is used for the emission measurement.
2. All measurements were made at 3 meters. Radiated emissions not detected at the 3-meter distance were measured at 0.3-meter and an inverse proportional extrapolation was performed to compare the signal level to the 3-meter limit. No other radiated emissions than those reported were detected at a test distance of 0.3-meter.
3. Negative value in the margin column shows emission below limit.
4. Horn antenna is used for the emission over 1000MHz.
5. Emission (the row indicated by **bold italic**) within the restricted band meets the requirement of FCC Part 15 Section 15.205 / RSS-2GEN Section 8.10.

INTERTEK TESTING SERVICES

Mode: Talk with Video Transmission

Table 4

Radiated Emission Data

Polarization	Frequency (MHz)	Reading (dB μ V)	Pre-amp (dB)	Antenna Factor (dB)	Net at 3m (dB μ V/m)	Limit at 3m (dB μ V/m)	Margin (dB)
V	50.763	34.8	16	11.0	29.8	40.0	-10.2
V	131.757	39.5	16	14.0	37.5	43.5	-6.0
H	141.329	36.8	16	14.0	34.8	43.5	-8.7
V	168.413	27.6	16	18.0	29.6	43.5	-13.9
V	263.819	31.9	16	21.0	36.9	46.0	-9.1
H	325.595	32.0	16	24.0	40.0	46.0	-6.0
H	361.713	29.8	16	24.0	37.8	46.0	-8.2
H	407.514	28.8	16	24.0	36.8	46.0	-9.2
V	455.905	28.5	16	26.0	38.5	46.0	-7.5
V	506.479	26.7	16	27.0	37.7	46.0	-8.3
H	554.825	25.4	16	28.0	37.4	46.0	-8.6
V	578.669	29.5	16	28.0	41.5	46.0	-4.5
V	699.972	29.6	16	30.0	43.6	46.0	-2.4
V	744.861	28.4	16	30.0	42.4	46.0	-3.6
V	839.181	23.2	16	31.0	38.2	46.0	-7.8
V	881.406	24.3	16	32.0	40.3	46.0	-5.7
V	938.832	23.0	16	33.0	40.0	46.0	-6.0

- NOTES:
1. Quasi-peak detector is used for the emission measurement.
 2. All measurements were made at 3 meters. Radiated emissions not detected at the 3-meter distance were measured at 0.3-meter and an inverse proportional extrapolation was performed to compare the signal level to the 3-meter limit. No other radiated emissions than those reported were detected at a test distance of 0.3-meter.
 3. Negative value in the margin column shows emission below limit.
 4. Emission (the row indicated by **bold italic**) within the restricted band meets the requirement of FCC Part 15 Section 15.205 / RSS-GEN Section 8.10.

INTERTEK TESTING SERVICES

4.8.3 Transmitter Duty Cycle Calculation

$$\begin{aligned}\text{Duty Cycle (DC)} &= \text{Maximum On time in 100ms}/100\text{ms} \\ &= (0.812\text{ms} \times 5)/100\text{ms}\end{aligned}$$

$$\begin{aligned}\text{Average Factor (AF)} &= 20 \log (\text{DC}) \\ &= 20 * \log (0.0406) \\ &= -27.8\text{dB}\end{aligned}$$

The EUT antenna output port was connected to the input of the spectrum analyzer. The analyzer center frequency was set to EUT RF channel carrier. The SPAN function on the analyzer was set to ZERO. The transmitter ON time was determined from the resultant time-amplitude display.

Please refer to the attached plot(s) for more details.

Plots of transmitter Duty Cycle

Plot A

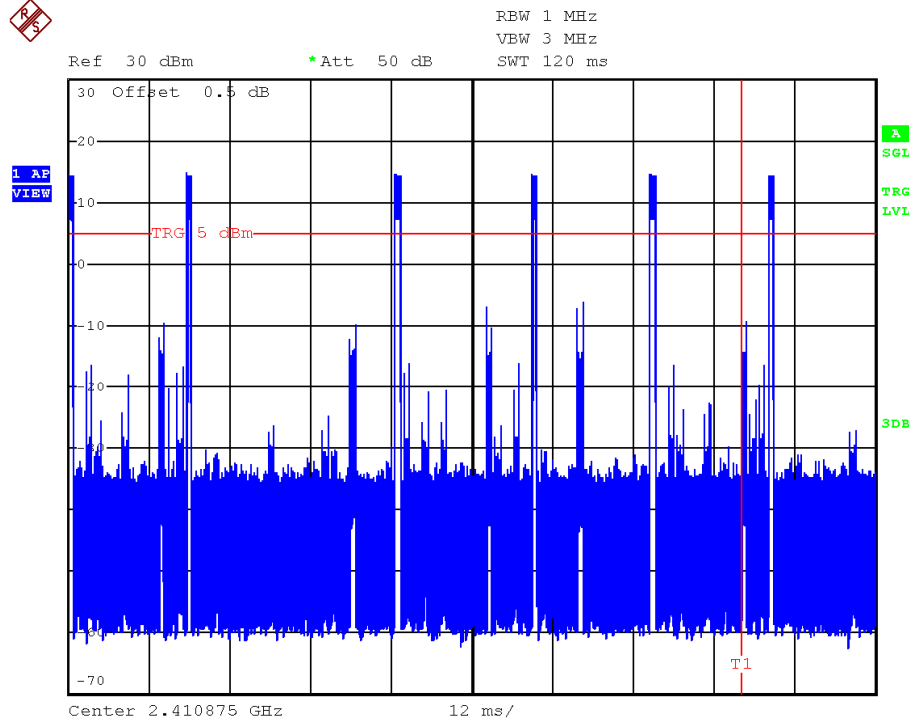

Plot B

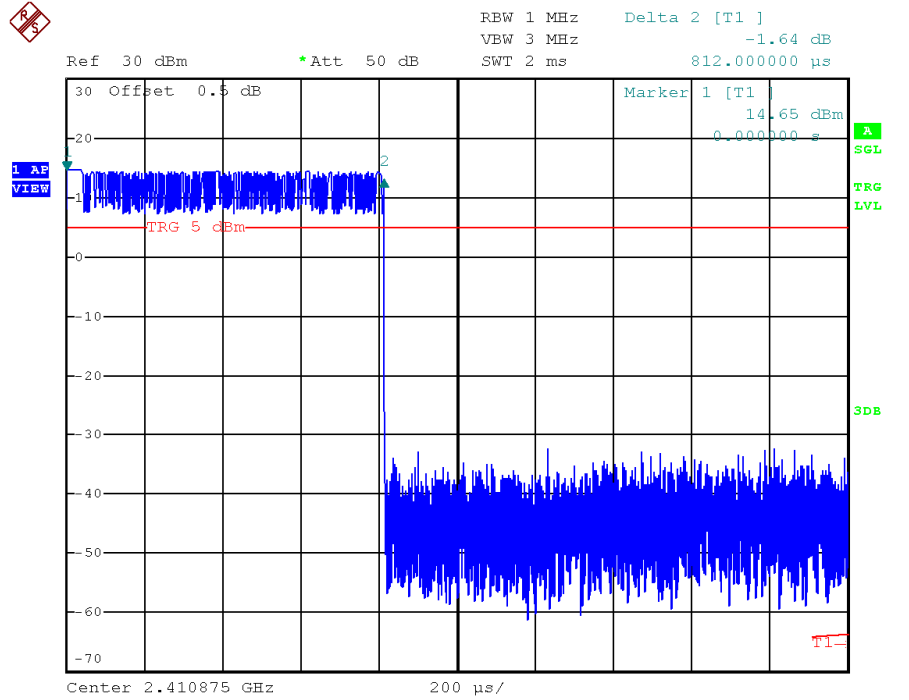

INTERTEK TESTING SERVICES

4.9 AC Power Line Conducted Emission

- Not applicable – EUT is only powered by battery for operation.
- EUT connects to AC power line. Emission Data is listed in following pages.

- Base Unit connects to AC power line and has transmission. Handset connects to AC power line but has no transmission. Emission Data of Base Unit is listed in following pages.

4.9.1 AC Power Line Conducted Emission Configuration Photograph

The worst case line conducted configuration photographs are attached in the Appendix and saved with filename: config photos.pdf

4.9.2 AC Power Line Conducted Emission Data

The plot(s) and data in the following pages list the significant emission frequencies, the limit and the margin of compliance.

Passed by >20 dB margin

INTERTEK TESTING SERVICES

Worst Case: TX Mode

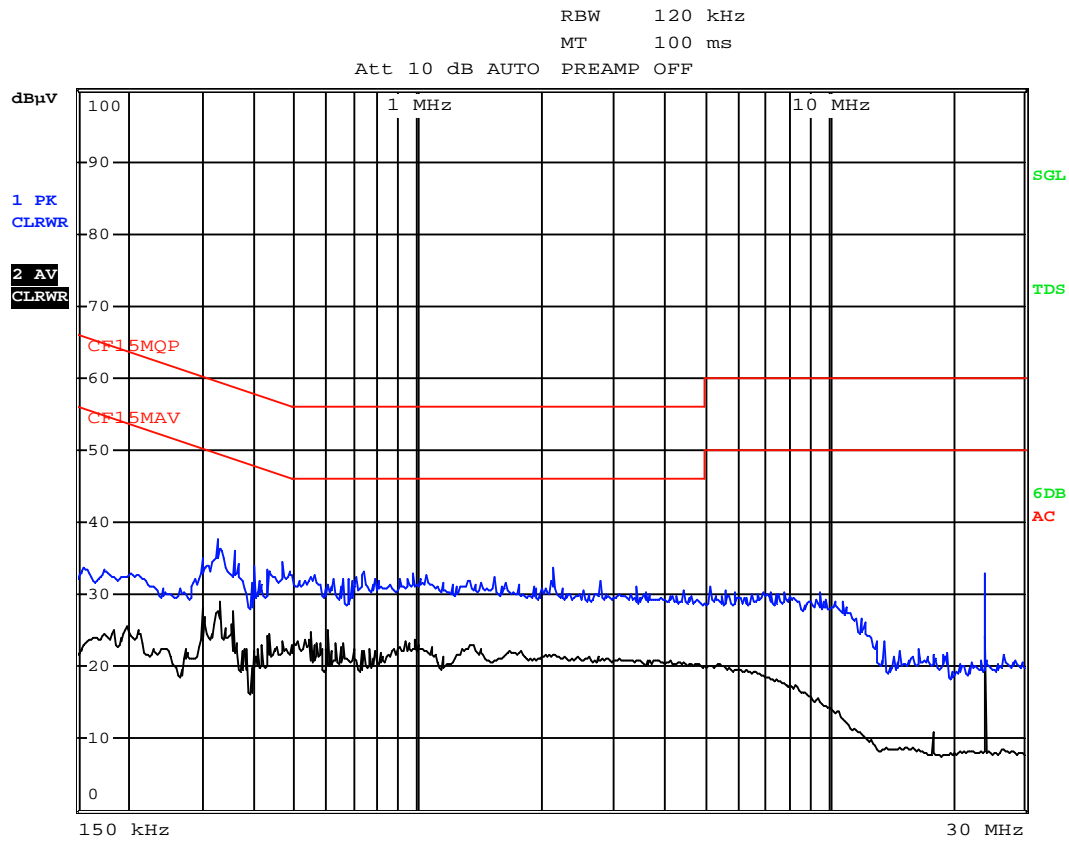

INTERTEK TESTING SERVICES

**EXHIBIT 5
EQUIPMENT LIST**

INTERTEK TESTING SERVICES

5.0 Equipment List

1) Radiated Emissions Test

Equipment	EMI Test Receiver	Biconical Antenna	Spectrum Analyzer
Registration No.	EW-2666	EW-0571	EW-2253
Manufacturer	R&S	EMCO	R&S
Model No.	ESCI7	3104C	FSP40
Calibration Date	May 13, 2015	Jun. 23, 2015	May 27, 2015
Calibration Due Date	May 13, 2016	Dec. 23, 2016	May 27, 2016

Equipment	Double Ridged Guide Antenna	Broad-Band Horn Antenna with frequency range 14G - 40GHz	Log Periodic Antenna
Registration No.	EW-1133	EW-1679	EW-0446
Manufacturer	EMCO	SCHWARZBECK	EMCO
Model No.	3115	BBHA9170	3146
Calibration Date	Apr. 30, 2014	Jun. 10, 2015	Nov. 10, 2014
Calibration Due Date	Oct. 30, 2015	Jun. 10, 2016	May 10, 2016

2) Conductive Measurement Test

Equipment	Spectrum Analyzer
Registration No.	EW-2249
Manufacturer	R&S
Model No.	FSP30
Calibration Date	Nov. 19, 2014
Calibration Due Date	Nov. 19, 2015

3) Conducted Emission Test

Equipment	EMI Test Receiver	LISN
Registration No.	EW-2500	EW-2874
Manufacturer	R&S	R&S
Model No.	ESCI	ENV-216
Calibration Date	Nov. 06, 2014	Dec. 08, 2014
Calibration Due Date	Nov. 06, 2015	Dec. 08, 2015

END OF TEST REPORT