

Angelcare®

FOR YOUR PEACE OF MIND

..... **OWNER'S MANUAL**

Model AC117

Baby Sound and Movement Monitor



TABLE OF CONTENTS

.....

 WARNINGS	3
Setup requirements.....	7
Charging the Parent Unit (10 hours).....	6
Positioning the movement Sensor Pad.....	8
Setting up the Nursery Unit.....	11
Getting to know your monitor.....	13
Activating and deactivating additional functions	20
Troubleshooting	22
Limited warranty.....	24
Technical specifications.....	24

OWNER'S MANUAL

KEEP YOUR OWNER'S MANUAL FOR FUTURE REFERENCE.

PLEASE READ THE WARNINGS AND INSTRUCTIONS CAREFULLY BEFORE ASSEMBLING & USING THE PRODUCT.

FAILURE TO FOLLOW THE WARNINGS AND THE INSTRUCTIONS COULD RESULT IN SERIOUS INJURY OR DEATH OR DAMAGES TO THE PRODUCT.

THE SENSOR PAD FEATURE IS NOT FOR USE WITH ADULTS, CHILDREN OR INFANTS OLDER THAN 24 MONTHS.

THE SENSOR PAD IS NOT INTENDED TO BE USED TO DETERMINE IF A CHILD IS OUT OF THE CRIB.

WARNING

Adult assembly required.

Keep small parts away from children when assembling.

We, at Angelcare®, stand behind all of our products.
If you are not completely satisfied or have any questions,

United States and Canada: Please contact us at: angelcare@cdecinc.ca

Other countries: Please contact your local distributor.

FCC AND IC REGULATIONS

.....

RF radiation exposure statement

The **NU** complies with FCC RF radiation exposure limits set forth for an uncontrolled environment. **Caution:** To maintain the compliance with the FCC's and Industry Canada's RF exposure guideline, install the **NU** at least 7.9" (20 cm) from ALL persons. The transmitter of this device must not be co-located or operating in conjunction with any other antenna or transmitter. **The Parent Unit has been tested and meets the FCC RF exposure guidelines.** Use of accessories may not ensure compliance with FCC exposure guidelines.

Industry Canada

This product meets the applicable Industry Canada technical specifications.
CAN ICES-3 (B)/NMB-3 (B)

⚠️ WARNINGS

1. THIS PRODUCT CANNOT REPLACE RESPONSIBLE ADULT SUPERVISION. This product is designed to aid in the monitoring of your child. When using the monitor, you must still provide the supervision necessary for the continued safety of your child. Monitoring of premature babies, or those considered to be at risk, should always be carried out under the supervision of a health professional. This monitor SHOULD NOT be used as a medical device, nor as a device to prevent Sudden Infant Death Syndrome (SIDS).

2. WARNING Strangulation Hazard — Children have STRANGLED in cords. Keep adapter cords

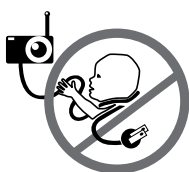

out of the reach of children (more than 3 feet [1 meter] away). NEVER use Sensor Pad(s) without the protective cord covering. Check protective cord covering before each use. Immediately discontinue use of Sensor Pad(s) if

protective covering is damaged or broken.

3. Never use extension cords with AC adapters. ONLY use the AC adapters provided.

4. When an AC Adapter is plugged into an electrical outlet, DO NOT touch the exposed end.

5. ALWAYS be sure that both the transmitter and receiver are working properly and are within range of each other. Test monitor before first use, periodically and when changing location of the Nursery Unit.

6. ALWAYS be sure to immediately check on baby whenever an alarm sounds.

7. DO NOT use monitor near water (such as bath tub, sink, etc.).



8. Keep monitor AWAY from heat sources (such as stoves, radiators, etc.).

9. ALWAYS place both the Nursery Unit and Parent Unit on a flat surface in an upright position and allow for proper ventilation. DO NOT place on sofas, cushions, beds, etc. which may block ventilation.

10. This monitor uses public airwaves to transmit signals. The Parent Unit may pick up signals or interference from other nursery monitors in your area. Your monitor may even be picked up by other households. To protect your privacy, make sure both units are turned OFF when not in use. If you experience interference, change the channel on both units.

11. This product is NOT a toy. DO NOT allow children to play with it.

12. This product contains small parts. Adult

assembly required. Exercise care when unpacking and assembling the product and keep small parts away from children.

13. Use and store the monitor at a temperature between 5 °C and 40 °C.

⚠️ BATTERY WARNING

14. Use ONLY AAA RECHARGEABLE batteries for the Parent Unit. DO NOT mix old and new batteries. DO NOT mix alkaline, standard or rechargeable batteries. Insert batteries with correct polarity. DO NOT short-circuit supply terminals. ONLY use the recommended batteries or equivalent (volts and size) and the correct adapter. Remove batteries when product is stored for long periods of time or when batteries are exhausted. Dispose exhausted batteries properly. DO NOT recharge non-rechargeable batteries. Rechargeable batteries are ONLY to be charged under adult supervision. Keep all batteries away from children.

15. IMPORTANT SAFETY INSTRUCTIONS

15.1 Read these instructions - All the safety instructions should be read before the product is operated.

15.2 Keep these instructions. The safety and operating instructions should be retained for future reference.

15.3 Heed all warnings - All warnings on the product and in the operating instructions should be adhered to.

15.4 Follow all instructions - All operating and use instructions should be followed.

15.5 Water and moisture - DO NOT use this apparatus near water. For example, near a bath tub, wash bowl, kitchen sink, laundry tub, in a wet environment or near a swimming pool and the like. Care should be taken so that objects DO NOT fall onto units and that liquids are not spilled into either unit or Sensor Pad through its openings.

15.6 Cleaning - Disconnect all units before cleaning. DO NOT immerse in water any part of the Nursery Unit, Parent Unit. Clean only with dry cloth.

15.7 Ventilation - DO NOT block any ventilation openings. Allow for proper ventilation when units are in use. DO NOT cover the Nursery Unit or Parent Unit with any object such as a blanket. DO NOT place it in a drawer or in any location which would muffle the sound or interfere with the normal flow of air.

15.8 Heat sources - DO NOT install near any heat sources such as radiators, heat registers, stoves, TVs or other apparatus (including amplifiers) that produce heat. Heat can damage the case or electrical parts.

15.9 Power cord protection - Protect the Sensor Pad cord and Adapter's power cord from being walked on or pinched by furniture or other items - Power supply cords should be routed so that they are not likely to be walked on or pinched by items upon or against them, paying particular attention to cords and plugs, convenience receptacle, and the point where they exit from the product.

15.10 Accessories - Only use attachments/accessories specified by the manufacturer. DO NOT place this product on an unstable cart, stand, tripod, bracket or table. The product may fall, causing serious injury to a child or adult and serious damage to the product. Use ONLY with a cart, stand, tripod, bracket or table recommended by the manufacturer or sold with the product. Any mounting of the product should follow the manufacturer's instructions.

15.11 Unplug this appliance during lightning storms or when not used for long periods of time.

15.12 Servicing - DO NOT attempt to service this product yourself as opening or removing covers (except battery doors) may expose you to dangerous voltage or other hazards.

15.13 Replacement parts - When replacement parts are required, be sure the replacement parts specified by the manufacturer have the same characteristic as the original part. Unauthorized substitution may result in fire, electric shock or other hazards.

15.14 Usage - This baby monitor is intended as an aid. It is NOT a substitute for responsible and proper adult supervision and should not be used as such. Use this appliance ONLY for its intended use as described in this manual.

15.15 Power Sources - Operate this product only from the type of power source indicated on the type plate of the adaptor. If you are unsure of the type of power supply to your home, consult your dealer or local power company.

15.16 Overloading - DO NOT overload wall outlets, extension cords or integral convenience receptacles as this can result in a risk of fire or electric shock.

15.17 Object and Liquid Entry - NEVER push objects of any kind into this product through casing slots as they may touch dangerous voltage points or short out parts that could result in a risk of fire or electric shock. NEVER spill liquid of any kind on the product.

15.18 Antenna - The antenna used for this transmitter must be installed to provide a separation distance of at least 7.9" (20 cm) from all persons and must not be collocated or operating in conjunction with any other antenna or transmitter.

15.19 Power Lines - An outside antenna system should NOT be located in the vicinity of overhead power lines or other electric light or power circuit, or where it can fall into such power lines or circuits as contact with them may be fatal.

15.20 WARNING Strangulation Hazard - Children have STRANGLED in cords. Keep



adapter cords out of the reach of children (more than 3 feet (1 meter) away). NEVER use Sensor Pad(s) without the protective cord covering. Check protective cord covering before each use. Immediately discontinue use of Sensor Pad(s) if protective covering is damaged or broken.

15.21 Interference - This monitor uses public airwaves to transmit signals. The Parent Unit may pick up signals or interference from other nursery monitors in your area. Your monitor may even be

picked up by other households. To protect your privacy, make sure both units are turned OFF when not in use. If you experience interference, change the channel on both units.

15.22 Vibration Source - When the monitor is in use, DO NOT use a bedside crib, crib mobile or other crib accessories that may produce vibrations. Other sources of vibrations may include fans, washing machines, loud music, etc. These sources of vibration may interfere with the performance of your Angelcare® monitor and the alarm will not sound if it continues to detect any movement other than your baby's. Be sure all vibration sources are eliminated before using the monitor.

You may experience false alarms for several reasons. The most common reason is the Nursery Unit has not been turned OFF after you have removed your baby from the crib. Another reason is the Sensor Pad has not been placed under the mattress properly.

Be sure the Sensor Pad is on a flat, firm surface with the printed side facing up. The sensitivity level may also need to be adjusted. Refer to Step 5.3. Always be sure to immediately check on baby whenever an alarm sounds.

15.23 Sensor Pad - If the crib has a spring or slat base, place a hard board between the crib base and the Sensor Pad measuring at least 33 x 33 cm and 6 mm thick. Only use your Angelcare® monitor in a stationary sleeping environment such as a crib where the Sensor Pad can rest on a completely flat, firm surface.

16. IMPORTANT SAFETY INSTRUCTIONS RELATED TO USE OF BATTERIES

16.1 Use ONLY the type and size of batteries specified in the owner's manual. There is a risk of explosion if batteries are replaced with an incorrect type.

16.2 Use ONLY AAA rechargeable batteries and/or the AC Adapters provided for the Parent Unit. You must use only rechargeable batteries in the Parent Unit. DO NOT use alkaline batteries or you will severely damage the unit.

16.3 Charge the batteries for 10 hours prior to first use. Be sure to have the monitor in the OFF position during this period. ONLY use the AC Adapters included with your monitor.

16.4 DO NOT use these adapters with any other equipments.

16.5 When unplugging the AC Adapter from the Nursery Unit, be sure it is switched to the OFF position. If it isn't, the unit will revert to battery mode if batteries are installed.

16.6 DO NOT use rechargeable batteries in the Nursery Unit. Use alkaline batteries ONLY.

16.7 DO NOT dispose of batteries in fire. They may explode. Check with local regulations for possible special disposal instructions.

16.8 Exercise care in handling batteries in order not to short out the batteries with conducting materials such as rings, bracelets and keys. Overcharging, short circuiting, reverse charging, mutilation, or incineration of batteries must be avoided to prevent one or more of the following occurrences: release of toxic materials, release of hydrogen and/or oxygen gas and rise in surface temperature.

16.9 DO NOT attempt to recharge batteries provided with or identified for use with this product that are not intended to be charged. The batteries may leak corrosive electrolyte or explode.

16.10 DO NOT attempt to rejuvenate the batteries provided with or identified for use with this product by heating them. Sudden release of battery electrolyte may occur, causing burns or irritation to eyes or skin.

16.11 If and when necessary, the batteries must be replaced with identical new ones or equivalent (volts and size). If a battery to be replaced is connected with other batteries in series, replace the other batteries at the same time as well. DO NOT mix old and new batteries.

16.12 Reverse polarity installation of the batteries in the end product must be avoided. Reverse insertion of batteries can cause charging, and that may result in leakage or explosion.

16.13 Remove batteries from this product if you store the product over 30 days because the batteries could leak and damage the product.

16.14 Discard 'dead' batteries as soon as possible since 'dead' batteries are more likely to leak in a product. If a battery has leaked or vented, it should be replaced immediately using protective gloves.

16.15 DO NOT store this product, or the batteries provided with or identified for use with this product, in high-temperature areas.

WARNING

(North America Only)

17. Modifications not authorized by the manufacturer may void users authority to operate this device.

17.1 NOTE: This equipment has been tested and found to comply with the limits for a Class B digital device, pursuant to Part 15 of the FCC Rules. These limits are designed to provide reasonable protection against harmful interference in a residential installation. This equipment generates, uses and can radiate radio frequency energy and, if not installed and used in accordance with the instructions, may cause harmful interference to radio communications.

17.2 However, there is no guarantee that interference will not occur in a particular installation. If this equipment does cause harmful interference to radio or television reception, which can be determined by turning the equipment OFF and ON, the user is encouraged to try to correct the interference by one or more of the following measures:

- Reorient or relocate the receiving antenna.
- Increase the separation between the equipment and receiver.
- Connect the equipment into an outlet on a circuit different from that to which the receiver is connected.
- Consult the dealer or an experienced radio/TV technician for help.

17.3 This device complies with part 15 of the FCC Rules. Operation is subject to the following two conditions:

(1) This device may not cause harmful interference, and

(2) This device must accept any interference received, including interference that may cause undesired operation.

17.4 This device complies with the part 15 of the FCC Rules and the Industry Canada license - exempt RSS standards(s). Operation is subject to the following two conditions:

17.5 (1) This device may not cause harmful interference, and

17.6 (2) This device must accept any interference received, including interference that may cause undesired operation.

IC WARNING:

1. This device complies with Industry Canada RSS standard(s). Operation is subject to the following two conditions:

(1) this device may not cause interference, and (2) this device must accept any interference including interference that may cause undesired operation of the device.

2. Changes or modifications not expressly approved by the party responsible for compliance could void the user's authority to operate the equipment.

Le présent appareil est conforme aux CNR d'Industrie Canada applicables aux appareils radio

Exempt de licence. L'exploitation est autorisée aux deux conditions suivantes:

(1) l'appareil ne doit pas produire de brouillage, et
(2) l'utilisateur de l'appareil doit accepter tout brouillage radioélectrique subi, même si le brouillage est susceptible d'en compromettre le fonctionnement.

SETUP REQUIREMENTS

Model AC117

Sound and Movement Monitor

INCLUDED:

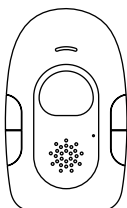

Parent Unit

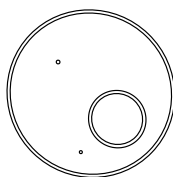

Nursery Unit

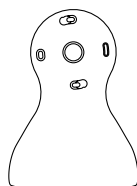

Tabletop stand
(for Nursery Unit)

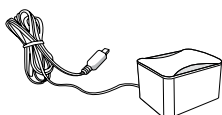

AC adapter
(for Parent Unit
& Nursery Unit)

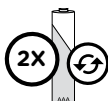

2 Rechargeable AAA Batteries
(for Parent Unit)



Wireless Movement Sensor Pad
* Always place Angelcare logo side up *



3V LITHIUM
BATTERY
(for Sensor Pad)

YOU MUST PREPARE:

One hardboard (not included)
Thickness: **1/4" (6 mm)**
Minimum dimensions:
13" x 13" (33 x 33 cm)
Maximum dimensions:
equal to the mattress size



Hardboard

IMPORTANT

The hardboard must be larger than the Sensor Pad surface.

WHAT YOU WILL NEED (NOT INCLUDED):

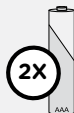

2 AAA Alkaline
Batteries
(for Nursery Unit)

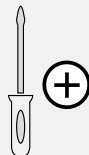

Miniature Philips
Screwdriver

STEP 1 - CHARGING THE PARENT UNIT (10 HOURS)

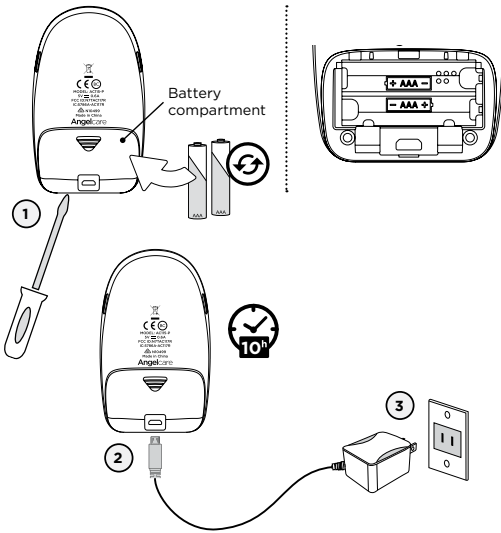

- 1) Remove the batteries compartment on the backside. Insert the provided rechargeable batteries into the compartment.
- 2) Connect the USB plug to the Parent Unit.
- 3) Connect the power adapter with an electrical outlet.
- 4) Charge the unit for **10 continuous hours prior to first use.**

PARENT UNIT:

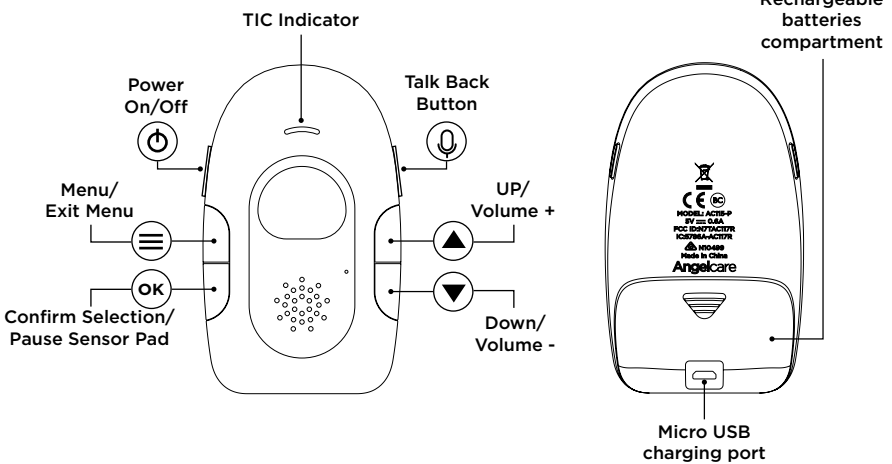

⚠ WARNING

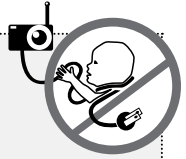

STRANGULATION HAZARD.

Children have **STRANGLED** in cords:

- Keep adapter cords out of the reach of children (more than 3 feet [1 meter] away).
- Because of the serious strangulation risk to infants and toddlers, parents and caregivers should never place the Nursery Unit within 3 feet (1 meter) of a crib.
- **NEVER** use Sensor Pad without the cord covers. Check cord covers before each use to ensure it is securely placed under the leg of the crib. Discontinue use of Sensor Pad if any cord covers are damaged or broken.
- **NEVER** use extension cords with adapters. **ONLY** use the adapters provided. This product is not a toy. Never allow children to play with it.

STEP 2 - POSITIONING THE MOVEMENT SENSOR PAD

2.1 - SELECT A LOCATION FOR THE NURSERY UNIT

IMPORTANT

Place the crib near a supporting wall and far from air currents. Install the Nursery Unit on a flat, stable surface facing the crib at a distance of at least **3 feet (1 meter)**. Make sure to plug the adapter to the socket outlet nearest to the equipment and that is easily accessible.

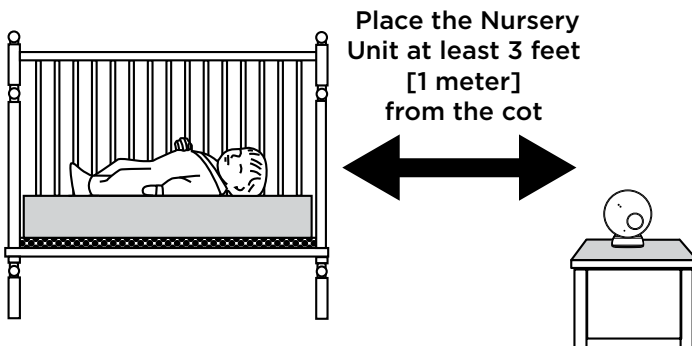

2.2 POWERING THE MOVEMENT SENSOR PAD

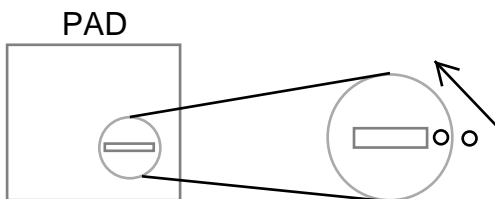

- 1) When using the Sensor Pad for the first time, you will need to insert the provided CR3032 battery.
- 2) Remove the battery cover using a coin. Turn in the direction of the arrow.
- 3) Place the included battery (CR3032) in the compartment.
Note: The + symbol should be facing up.
- 4) Replace the battery cover (the two dots will line up).
The Sensor Pad is now ON.
- 5) Verify the wireless sensor pad is in linking with NU- NU Light Ring does not flash in light blue.

INSTALL THE SENSOR PAD ON THE MATTRESS SUPPORT

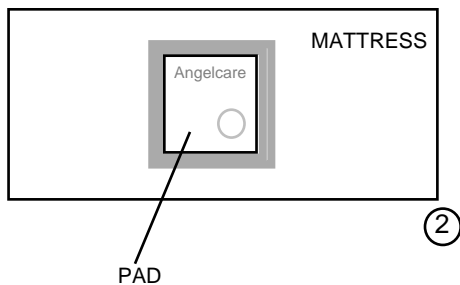

- 1) Remove the mattress from the crib.
- 2) Place the Sensor Pad-printed side up in the center of the mattress. It should be centered on the hardboard if your crib requires a hardboard support.
- 3) Replace the mattress.

2.3- INSTALL THE SENSOR PAD ON THE MATTERESS SUPPORT

IMPORTANT

If your crib does not have a solid, stable surface for the Sensor Pad, you will need to place a support under it, to ensure correct operation of the system.

This hardboard support should be at least 6 mm thick and should have minimum dimensions of 13" x 13" (33 x 33 cm). This support board must be larger than the Sensor Pad surface area.

The Sensor Pad functions with any size and type of mattress except memory-foam mattresses, hollow frame mattresses and water beds. The hardboard maintains a constant pressure on the Sensor Pad, enabling it to detect the baby's movements even when the baby is at the edges of the crib.



Hardboard

10

WARNING

STRANGULATION HAZARD



- Remove all slack from Sensor Pad Cord.
- When lowering the mattress support as your child grows, slide the vertical Cord Cover downward so it remains approximately in the center between the mattress support and the floor. Slide the Sensor Pad Cord through the Floor Cover to eliminate any additional slack.

- The Sensor Pad is not designed for use with adults, children or infants older than 24 months.
- Discontinue use of the Sensor Pad when child is older than 24 months. Remove Sensor Pad from crib and store for future use.
- **BEFORE FIRST TIME USE:** To test that the unit is ready for use, refer to instruction manual on how to test that the installation has been done correctly.

STEP 3 - SETTING UP THE NURSERY UNIT

Select a location for the Nursery Unit that is at least 1 m away from the crib.

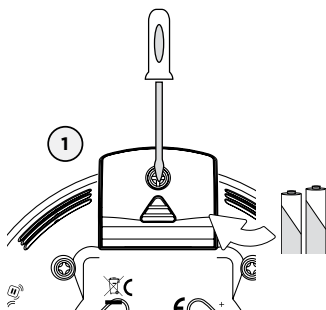

- 1) Remove the batteries cover and insert 2 AAA Alkaline Batteries (not included)

Note:

The batteries maintain power supply in case of power outage.

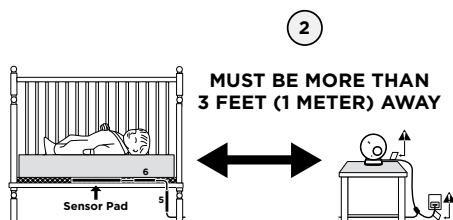

- 2) Install the Nursery Unit on a flat, stable surface facing the crib at a distance of at least 3 feet (1 meter)
- 3) Check to make sure the Sensor Pad has not moved from position.
- 4) Place the mattress back inside the crib.

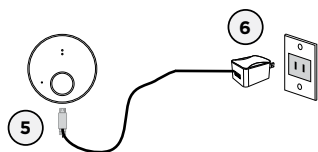

- 5) Connect the USB plug to the Nursery Unit.
- 6) Connect the USB plug with the power adapter and then with an electrical outlet.

Note: Each time you power **ON** your Nursery Unit, the internal thermometer will need to calibrate to ensure accuracy. This automatic process will take approximately 30 minutes. The colour changing temperature display, by default, will be turned **"OFF"**. You may turn this feature **"ON"** in the settings mode on your Parent Unit.

NURSERY UNIT:

Power ON/OFF Light Indicator
Low Batteries Light Indicator

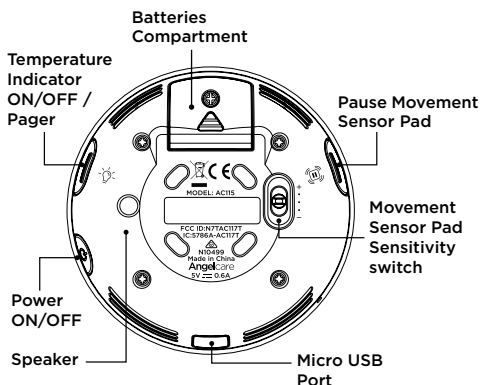
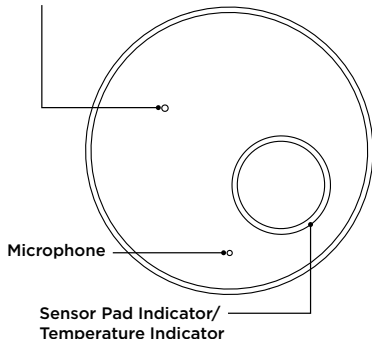





STEP 4 - TURNING ON YOUR MONITOR

YOU ARE NOW READY TO USE YOUR MONITOR

The Angelcare® monitor can be used with the pre-program factory settings or you can also customize your settings to your preference.

DEFAULT SETTINGS

	Detection Mode:	
	Movement:	ON
	Sound:	ON
	Sound transmission (VOX):	OFF
	Temperature Unit:	Fahrenheit - USA Celsius - Canada
	Temperature Alarm:	OFF
	Temperature Alarm Setting:	High: 86° F / 30° C Low: 66° F / 19° C

TURN ON YOUR MONITOR

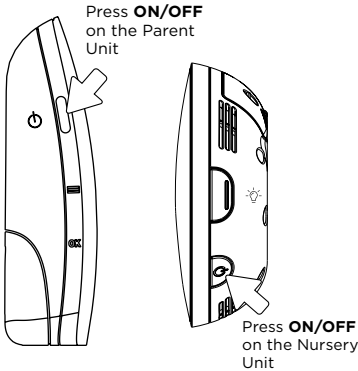

- 1) Press the Parent Unit **ON/OFF** button for 2 seconds.
- 2) Press the Nursery Unit Power **ON/OFF** button for 2 seconds.

NOTE:

The screen of the Parent Unit will flash the out-of-range icon till it displays the room temperature and function icons. The connecting process should be done within 30 seconds. If this sequence is not completed within 30 seconds you will need to switch the units off and start again.

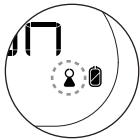

When Parent Unit is turned **ON** and Nursery Unit is **OFF** or if there is a lost connection between the 2 units (refer to troubleshooting). The **Out-of-range** icon will blink on the screen and the Parent Unit will beep.

IMPORTANT ICONS

Detection mode icons: Indicates monitor detection mode

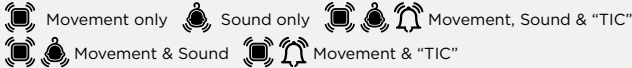

VOX icon: Indicates when the Nursery Unit is in VOX mode

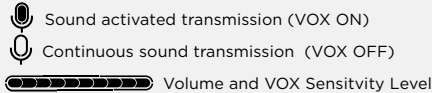

Connection icon: Indicates the connection quality between the Parent Unit and the Nursery Unit



Temperature display: Indicates room temperature

Temperature alerts icons: Indicates Temperature Alarm is active

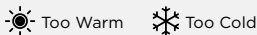

Battery level icon: Indicates Parent Unit battery life

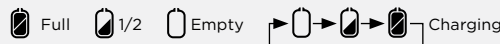

STEP 5 - TESTING AND GETTING TO KNOW YOUR MONITOR

The Angelcare® monitor can be used with the pre-program factory settings or you can also customize your settings to your preference.

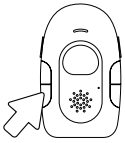

All changes and adjustments made in the main menu will not be activated unless you confirm them by pressing the **EXIT** button.

IMPORTANT

When in MENU mode, sound transmission between Parent and Nursery Units will be temporarily deactivated.

5.1 - MENU ACCESS AND CHANGING THE SETTINGS

The MENU settings are accessed by pressing and HOLD the MENU button on the Parent Unit. The MENU functions are in a loop. Each time you press the **OK** button briefly you move on to the next MENU function. The MENU functions are in the following order

PRESS AND HOLD: Movement & "TIC"	STEP 5.2
PRESS 1 TIME: Sound	STEP 5.5
PRESS 2 TIMES: Sound Transmission (VOX)	STEP 5.6
PRESS 4 TIMES: Temperature	STEP 5.7

NOTE:

By continuing to press the **OK** button you will be continuously moving through the loop. Once you have selected your preferred settings you must press **EXIT MENU** or your changes will not be saved.

5.2 - SETTING THE SENSOR PAD

SET THE MOVEMENT DETECTION

Allows you to detect the baby's movements.

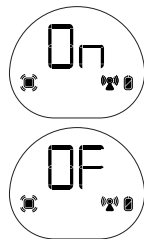
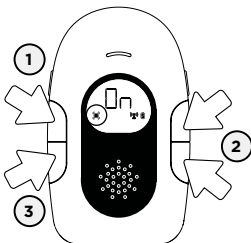

- 1) Press and HOLD the **MENU** button till the **Movement monitoring** icon blinks.
 The movement monitoring icon will blink.
- 2) Use the **UP** and **DOWN** arrows to activate or deactivate movement detection.
- 3) Press the **OK** button to confirm your choice.

SET THE TIC FUNCTION

Allows you to detect baby's movements as well as hear a TIC sound at each movement. (This function can ONLY be activated in conjunction with the Movement Function).

IMPORTANT

To activate the "TIC" Function, the movement detection needs to be **ON**.

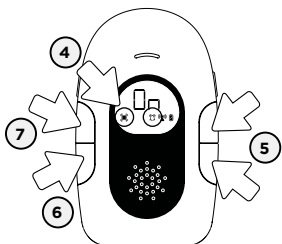

- 4) If you have activated the movement, the Parent Unit will allow you to set the "TIC" function.



The movement monitoring and "TIC" icons will blink

- 5) Use the **UP** and **DOWN** arrows to set the TIC function.

- 6) Press the **OK** button to confirm your choice.

- 7) Press the **EXIT** button to test the Sensor Pad.

TO TEST THE SENSOR PAD

MOVEMENT MODE NEED TO BE ACTIVATED:

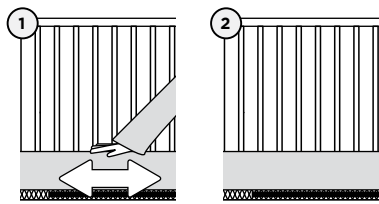

- 1) Move your hand lightly on the mattress.

NOTE:

The Parent Unit will emit a "TIC" sound (when activated) and will flashes every 5 seconds.

- 2) Remove your hand from the mattress. After 15 seconds you will hear a 'TIC' pre-alarm sound, and 5 seconds later the Movement Alarm will trigger.

- 3) Repeat by moving your hand lightly in all four corners of the mattress. Ensure the Nursery Unit Movement Indicator is still flashing.

MOVEMENT ALARM

- If **NO** movement is detected after 15 seconds you will hear a single 'TIC' pre-alarm sound from the Nursery Unit.
- If after a further 5 seconds there is still **NO** movement detected both the Parent Unit and Nursery Unit speakers will emit loud warning sound.v
- Nursery Unit will flash red light.
- Sensor Pad Icon and sound level bar on Parent Unit will flash.

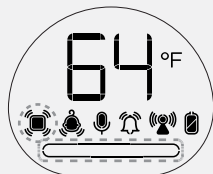

IF THE ALARM DOES NOT SOUND

- Avoid contact with crib while Sensor Pad is in operation.
- Place crib near a supporting wall.
- Adjust Sensor Pad sensitivity level.
- Turn OFF crib mobile, fans, loud music or anything else that may cause vibration.

TO STOP THE ALARM

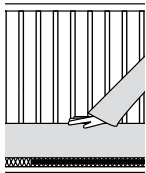

Place your hand back on the mattress.

OR

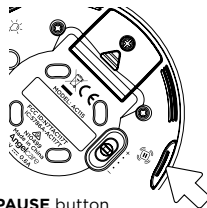

Press **PAUSE** button on the Nursery Unit

OR

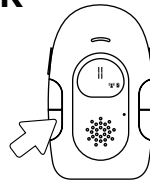

Press **PAUSE SENSOR PAD** button on the Parent Unit

5.3 - PAUSING AND RESTARTING THE SENSOR PAD

Allows you to pause the Sensor Pad if you remove baby from the crib, e.g. for feeding or comforting.

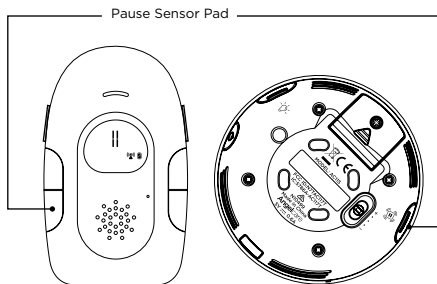

- 1) From the Parent Unit, press and hold **Pause Sensor Pad** button for at least 2 seconds.

OR

From the Nursery Unit, press the **Pause** button

IMPORTANT

- If you do not pause the Sensor Pad, the alarm will sound if there is no movement after 20 seconds.
- Ensure to unpause the Sensor Pad before putting baby in the crib.

5.4 ADJUST THE SENSOR PAD SENSITIVITY LEVEL:

To ensure adequate monitoring of your baby's movements, you can adjust the sensitivity of the Sensor Pad. Set a high sensitivity for a newborn and a lower sensitivity as baby grows and gains weight. A thicker mattress will also need a higher sensitivity. Slide the Nursery Unit sensitivity level button to select between low, medium or high level.

For optimal results begin with medium sensitivity level, adjusting the sensitivity by increasing or decreasing as required.

NOTE:

If you are experiencing false alarms, adjust the sensitivity level.

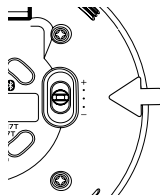

IMPORTANT

- The Sensor Pad is not designed for use with adults, children or infants older than 24 months.
- Once you are finished using the Sensor Pad, please remove it from the baby's crib and store it away.

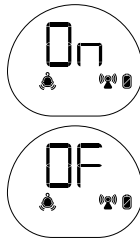
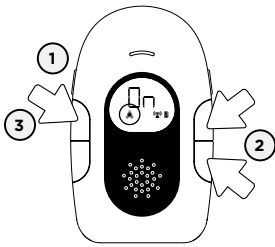
5.5 - SOUND**TO ACTIVATE SOUND:**

- 1) Press and hold the **MENU** Button then press the **OK** button till the **Sound Monitoring** icon blinks.
 The sound monitoring icon will blink.
- 2) Using the **UP** and **DOWN** arrows, turn the function **ON** or **OFF**.
- 3) Press the **EXIT** button to confirm your choice.

TO TEST SOUND:

Ask someone to speak into the Nursery Unit or place the unit near a radio to ensure that sound is being picked up.

IMPORTANT

To avoid feedback (whistling), keep both units at least 10 feet apart (3 meters) apart.

IF YOU HEAR NO SOUND:

- Check that both units are powered ON.
- Check that both units are plugged into functioning electrical outlets.
- Check the batteries in both units (replace or recharge them if necessary).
- Bring the Parent Unit closer to the Nursery Unit.

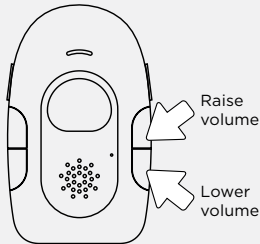
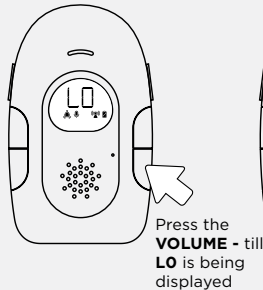
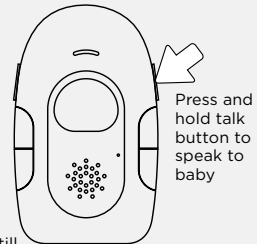
ADJUST THE SOUND LEVEL**PUT IN MUTE MODE****PUT IN DIALOGUE MODE**

5.6 - SOUND TRANSMISSION (VOX)

Your monitor is 'Sound Activated'. This means that it will transmit sounds only when it detects them. It will detect even the softest levels of crying.

To save power, after 10 seconds, the sound transmission will stop if no sound is detected. Once sound is detected transmission will automatically activate.

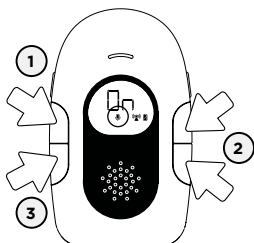

- 1) Press and hold the **MENU** button then press the **OK** button till the **VOX** icon blinks.



The VOX icon will blink.



- 2) Use the **UP** and **DOWN** arrows to activate or deactivate VOX.
- 3) Press the **OK** button to go to the next setting or press the **EXIT** button to confirm your choice.

TO ADJUST SOUND SENSITIVITY (VOX)

The sensitivity of the microphone is adjustable and has 4 levels (the most sensitive is level 4). This means that sound will only transmit based on the level that you set.

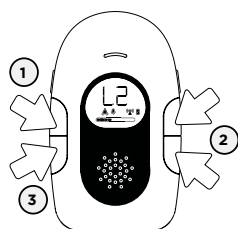

TO

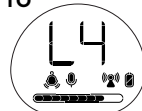

- 1) When the Sound Transmission is **ON** (VOX ON) press and hold the **MENU** button then press **OK** button till **VOX** icon blinks.



The VOX icon will blink.

- 2) Use the **UP** and **DOWN** arrows to select desired microphone sensitivity level.
- 3) Press the **OK** button to go to the next setting or press the **EXIT** button to confirm your choice.

5.7 - TEMPERATURE

TO SELECT TEMPERATURE IN CELSIUS OR FAHRENHEIT

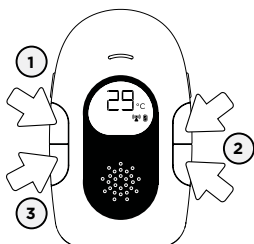

- 1) Press and hold the **MENU** button then press **OK** button till the **°F / °C** icon blinks.





The °F / °C icon will blink.

- 2) Use the **UP** and **DOWN** arrows to select temperature in Celsius or Fahrenheit.
- 3) Press the **OK** button to go to the next setting or press the **EXIT** button to confirm your choice.

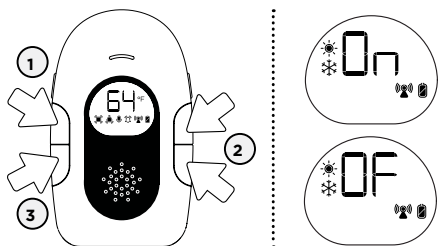
TO ACTIVATE THE TEMPERATURE ALARM



- 1) Press and hold the **MENU** button then press **OK** button till the **Temperature Indicator** icon blinks.

  The Temperature Indicator (Low and High) will blink.

- 2) Use the **UP** and **DOWN** arrows to turn temperature alarm **ON** or **OFF**.
- 3) Press **OK** button to confirm your choice.

TO SET TEMPERATURE RANGE

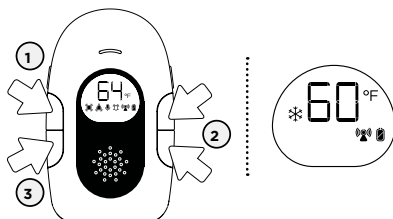

- 1) Press the **OK** button **once** more.

 The Snow Flake (Low Temperature icon) will blink.

- 2) Use the **UP** and **DOWN** arrows to set the **LOW** temperature alarm (41 to 66,5° Fahrenheit / 5 to 19° Celsius).
- 3) Press the **OK** button to confirm your choice.

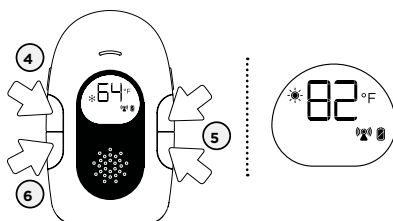

- 4) Press the **OK** button **once** again.

 The Sun (High Temperature icon) will blink.

- 5) Use the **UP** and **DOWN** arrows to set the **HIGH** temperature alarm (71 to 98,6° Fahrenheit / 22 to 37° Celsius).
- 6) Press the **OK** button to go to the next setting or press the **EXIT** button to confirm your choice.

The low temperature range is 41 to 66,5°F (5 to 19°C) and high temperature range is 71 to 98,6°F (22 to 37°C).

NOTE:

Make sure to turn **ON** Temperature alarm to be able to set Temperature range.

TEMPERATURE ALARM

- Alarm activates when the temperature reaches the maximum or minimum set temperature.
- Parent Unit will emit 3 consecutive beeps, every 5 seconds if the temperature reaches levels out of your chosen range. The relevant icon will flash on the Parent Unit screen to alert you.
- The Nursery Temperature Indicator will turn blue if the temperature is too cold or red if the temperature is too hot.

STEP 6 - ACTIVATING AND DEACTIVATING ADDITIONAL FUNCTIONS

6.1 - ACTIVATE OR DEACTIVATE TEMPERATURE INDICATOR ON NURSERY UNIT

With this option the Nursery Unit Temperature Indicator will light up in colour when the temperature goes above or below your preferences. If the temperature goes above your set preferences and this option is turned ON, the light on the Nursery Unit's will turn to red instead of the default white. If the temperature goes under the set preferences, then the light will turn blue.

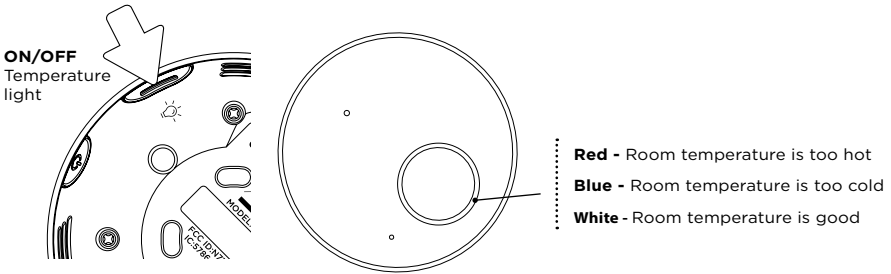

6.2 - OUT OF RANGE SETTINGS

Your monitor has an Out-of-Range alarm that advises you when your two units are not communicating. Out-of-Range situations can be caused by distance or by physical interferences.

RANGE:

Open field (Open area without obstructions): up to 755 feet (230 meters).

OUT-OF-RANGE ALARM

- Alarm activates when your two units are not communicating.
- The Parent Unit will emit a double beep every 16 seconds.
- Out-of-Range Icon will flash on the screen.



IMPORTANT

If you turn the Nursery Unit OFF the Out-of-Range Alarm will sound. Turn the Nursery Unit ON again to reactivate the link.

TO STOP THE OUT-OF-RANGE ALARM:

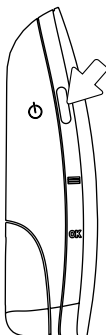

Press 2 seconds to turn the Parent Unit OFF

OR



Turn the Nursery Unit ON

6.3 - PAGER

Allows you to locate the Parent Unit.

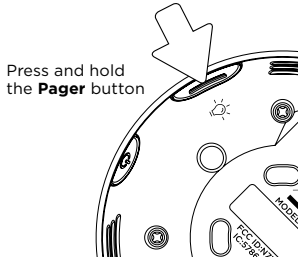

TO LOCATE THE PARENT UNIT

Press and hold the Nursery Unit Pager button on the side of the Nursery Unit. The Parent Unit will emit a paging sound.

TO STOP THE PAGING SOUND

Press any button on the Parent Unit or the Pager button on the Nursery Unit.

TROUBLESHOOTING

TAKING CARE OF YOUR RECHARGEABLE BATTERIES

- Ensure that you fully charge your batteries for 10 hours before their first use.
- To maintain maximum battery life it is recommended that you fully discharge your batteries periodically. Battery performance can be diminished by leaving the batteries constantly charging. If your parent unit is not in use, please turn it off.
- Inadequate battery power can impair the performance of your monitor. If you are not happy with the performance of your Parent Unit Monitor please replace the rechargeable batteries (2 x NiMH Rechargeable Batteries).
- It is advisable to change the batteries every 6 months.

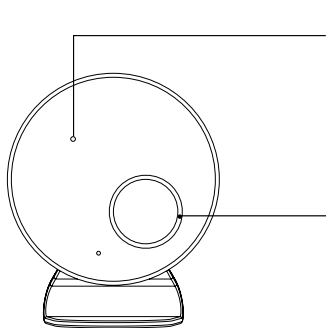

Power On/Off Light Indicator Low Battery Light Indicator	
Flashing green	Nursery unit is using the back-up batteries
Flashing yellow	Nursery Unit batteries are low
Steady green	Monitor is activated

Sensor Pad Light Indicator Temperature Indicator	
Flashing red	No movement is detected
Flashing white	Monitor is paused
Steady Red	Room temperature is too hot
Steady Blue	Room temperature is too cold
Steady White	Room temperature is good

FALSE ALARMS

- Turn **OFF** the Nursery Unit.
- Make sure there is no bedding between the mattress and the Sensor Pad.
- If the crib has a spring or slat base, place a hardboard between the crib base and the Sensor Pad measuring at least 13" x 13" (33 x 33 cm) thick.
- Make sure Sensor Pad is positioned as described under the setup requirements. Sensitivity may need to be adjusted, refer to **Step 5.4**.

ALARM WILL NOT SOUND

- Avoid contact with the crib when the monitor is **ON**.
- Place crib near a solid supporting wall to avoid Sensor Pad from detecting movement from outside the crib.
- Turn **OFF** crib mobile, fans, loud music or anything else that may cause vibration.
- You may need to decrease the sensitivity, refer to **Step 5.4**.

NURSERY UNIT POWER ON INDICATOR (GREEN LIGHT) DOES NOT LIGHT UP

- Check connections or change to another electrical outlet.
- Press the Nursery Unit ON/OFF button for 2 seconds to turn the Nursery Unit ON.

WEAK RECEPTION
.....

- Bring units closer together.
- Change the position of one or both units.
- Place units on a flat surface away from baby's reach.
- Replace the batteries or recharge the Parent Unit.

STATIC, DISTORTION, INTERFERENCES (FROM OTHER MONITORS, WIRELESS PHONES, WALKIE-TALKIES, ETC...)
.....

- Rotate the Parent Unit or move it away from source of interference.

FEEDBACK (LOUD NOISES EMITTED FROM THE PARENT UNIT)
.....

- Move units farther apart (at least 3 meters apart).
- Decrease volume on the Parent Unit.

THE PARENT UNIT SCREEN IS BLACK (PARENT UNIT IS OFF)
.....

- Turn the Parent Unit back ON by pushing and holding the power button.
- Replace the batteries or recharge the Parent Unit.

SENSOR PAD LIGHT INDICATOR FLASHING RED (MONITOR IS BARELY DETECTING MOVEMENT)
.....

- Make sure there is no bedding between the mattress and the Sensor Pad.
- The Sensor Pad must rest on a completely flat and firm surface. If the crib has a spring or slat base, place a hard board between the crib base and the Sensor Pad measuring at least 13" x 13" (33 x 33 cm) thick.
- Make sure Sensor Pad is positioned as described under the setup requirements. Sensitivity may need to be adjusted, refer to **Step 5.4**.

NO POWER
.....

- Check or replace batteries.
- Make sure Monitor is **ON**.

NURSERY UNIT POWER ON INDICATOR (GREEN LIGHT) DOES NOT LIGHT UP
.....

- Check connections or change to another electrical outlet.
- Press the Nursery Unit ON/OFF button for 2 seconds to turn the Nursery Unit ON.

LIMITED WARRANTY

Angelcare® warrants to the original owner of this product that Angelcare® monitor is free from any material and workmanship defects for the term of the warranty period (see warranty table below to determine the warranty for your country). If this monitoring system fails to function properly when used as directed under normal conditions and during the warranty period, Angelcare® will either repair or replace the product, at our discretion, free of charge. Please contact your local distributor to validate warranty and warranty period.

The product must be accompanied by a proof of purchase, either a bill of sale or other proof that the monitoring system is within the warranty period. Angelcare® will bear the cost of repairing or replacing the product and shipping it back to you.

This warranty does not apply to a product which has been damaged as a result of improper maintenance, an accident, improper voltage supply or any other form of misuse. The warranty is also void if the owner repairs or modifies the product in any way. Angelcare® is not liable for any incidental or consequential damages with regard to this product. The warranty also excludes any liability other than what is stated above. No other warranty is given.

This warranty does not cover products and accessories which are not Angelcare-branded, or any problems that result from usage that is not in accordance with product instructions, failure to follow the product instructions, or problems caused by using accessories, parts or components not supplied by Angelcare.

LEGAL RIGHTS VARY FROM COUNTRY TO COUNTRY. SOME COUNTRIES DO NOT ALLOW THE EXCLUSION OR LIMITATION OF INCIDENTAL OR CONSEQUENTIAL DAMAGES, SO THE ABOVE LIMITATIONS MAY NOT APPLY TO YOU.

WE ARE NOT IN ANY WAY RESPONSIBLE FOR ANY OUTCOME RESULTING FROM THE USE OF THIS PRODUCT.

IMPORTANT! This Angelcare® monitor is a personal care product. Please do not return this product to the store. If you have questions or need help, please call your distributor before returning this product.

WARRANTY TERM PER COUNTRY

North America	1 year
---------------	--------

TECHNICAL SPECIFICATIONS

Range:

Open field (Open area without obstructions): up to 755 feet (230 meters).

Power Supply:

2 AAA alkaline batteries (not included) or 100/240V AC/5V DC adapter for Nursery Unit.
2 AAA rechargeable batteries and 100/240V AC/5V DC adapter for the Parent Unit.

Caution: To reduce the risk of electric shock, do not expose this product to rain or moisture.

Danger of explosion if batteries are incorrectly replaced. The battery included for the Parent Unit is 2 AAA NIMH rechargeable batteries, manufactured by GPI INTERNATIONAL LIMITED (GN60AAAHC, 1.2V 600mAh). Only use the Angelcare recommended replacement battery. To obtain information on replacement batteries please contact Angelcare customer service: www.angelcarebaby.com or contact your local distributor. Instructions will be included with the replacement battery. Dispose of exhausted batteries properly according to your local ordinances. Keep all batteries away from children.

Batteries:

- DO NOT mix old and new batteries.
- DO NOT mix alkaline standard (carbon-zinc), or rechargeable (NI-CD, NIMH, etc.) batteries.

CAUTION: RISK OF EXPLOSION IF BATTERY IS REPLACED BY AN INCORRECT TYPE. DISPOSE OF USED BATTERIES ACCORDING TO THE INSTRUCTIONS.

Transmission:

Transmission between the Parent Unit and the Nursery Unit is made on 1.92 to 1.93 GHz frequency for North America.

PROTECT THE ENVIRONMENT

This electronic equipment contains reusable material and must not be disposed with domestic waste. Please take it to a collecting point for electric and electronic equipment (ask your local authorities for details).



SAR Information Statement

Your baby monitor Parent Unit is a radio transmitter and receiver. It is designed and manufactured not to exceed the emission limits for exposure to radiofrequency (RF) energy set by the Federal Communications Commission of the the U.S. Government. These limits are part of comprehensive guidelines are based on standards that were developed by independent scientific studies. The standards include a substantial safety margin designed to assure all persons, regardless of age and health. The exposure standard for the Parent Unit employs a unit of measurement known as the Specific Absorption Rate, or SAR. The SAR limit set by the FCC is 1.6W/kg. Test for SAR are conducted with the Parent Unit transmitting at its highest certified power level in all tested frequency bands.

Although the SAR is determined at the highest certified power level, the actual SAR level of the Parent Unit is designed to operate at multiple power levels so as to use only the power required to reach the Nursery Unit. In general, the closer you are to Nursery Unit, the lower the power output. Before a baby monitor model is available for sale to the public, it must be tested and certified to the FCC that it does not exceed the limit established by the government adopted requirement for safe exposure. The tests are performed in positions and locations (e.g. in front of face and the worn on the body) as required by FCC for each model. The highest SAR value for the Parent Unit when tested for use in front of face is 0.043W/Kg and when worn on the body is 0.125W/Kg (Body-worn measurements differ among various models, depending upon available accessories and FCC requirements). While there may be difference between the SAR levels of various Parent Units and various positions, they all meet the government requirement for safe exposures. The FCC has granted an Equipment Authorization for this model Parent Unit with all reported SAR levels evaluated in compliance with the FCC RFexposure guidelines. SAR information on this model Parent Unit is on file with the FCC and can be found under the Display Grant section of <http://www.fcc.gov/oet/fccid> after searching on FCC ID:N7TAC117R. In the United States and Canada, the SAR limit for the Parent Unit is 1.6 watts/kg (W/kg) averaged over one gram of tissue. The standard incorporates a substantial margin of safety to give additional protection for the public and to account for any variations in measurements.

IC STATEMENT

This device complies with Industry Canada license-exempt RSS standard(s)

Operation is subject to the following two conditions:

- (1) This device may not cause interference, and
- (2) This device must accept any interference, including interference that may cause undesired operation of the device.

This equipment complies with IC radiation exposure limits set forth for satisfying RF exposure compliance. This transmitter must not be co-located or operation in conjunction with any other antenna or transmitter.

These requirements set a SAR limit of 1.6W/kg averaged over one gram of tissue.

The highest SAR value for this Parent Unit when tested for use in front of face is 0.043W/Kg and when worn on the body is 0.125W/Kg. This device was tested for typical body-worn operations. To comply with RF exposure requirements, 0 mm testing separation distance was done between testing BODY and the Parent Unit, including antenna. Third-party belt-clips, holsters, and similar accessories used by this device should not contain any metallic components. Body-worn accessories that do not meet these requirements may not comply RF exposure requirements and should be avoided.

Use only the supplied antenna.

www.angelcarebaby.com