

AC1101
Rev.0
10/28/2013

FCC ID: N7TAC1100R
IC: 5786A-AC1100R
Australia:  N10499

17.5mm x 1.3mm
17.5mm x 1.3mm
20.5mm x 1.4mm

Engrave

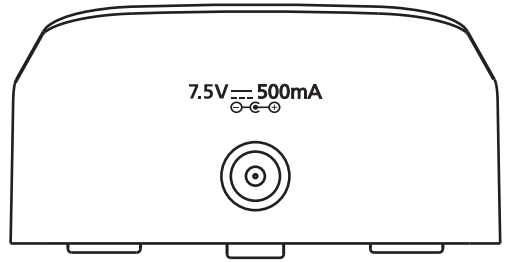

Pad
Printing

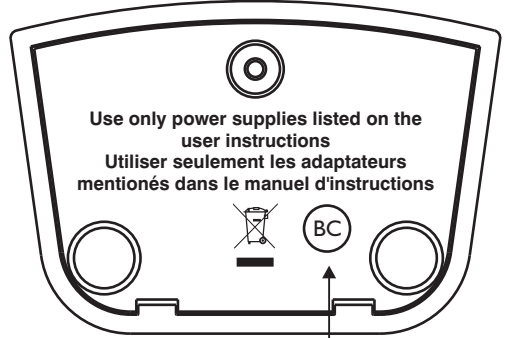
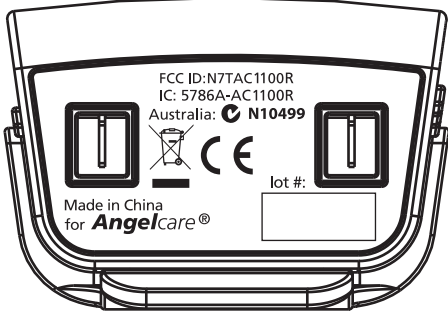

Engrave

Label-BC

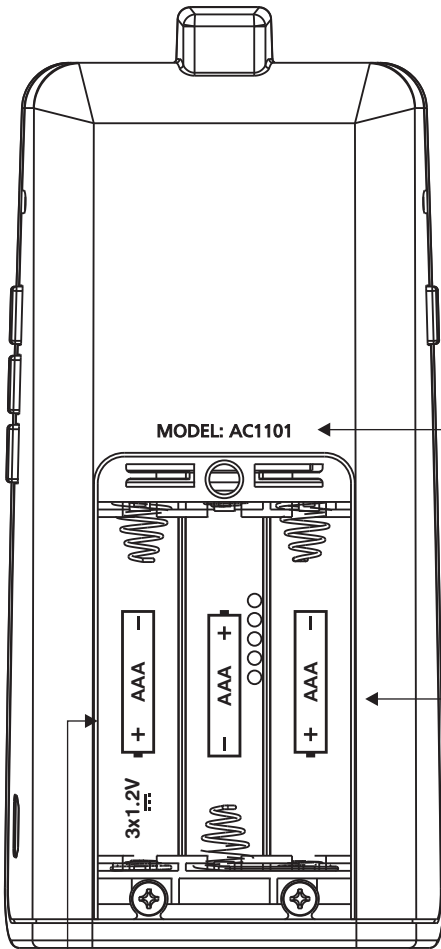

Pad
Printing

MODEL: AC1101

Put model
number here
instead of on
the battery door

Engrave

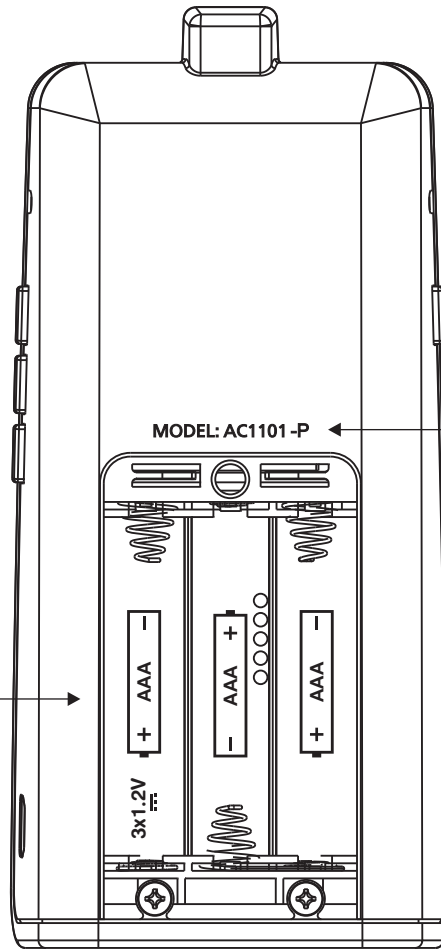

Pad
Printing

MODEL: AC1101-P

Different
model number
with NU
for Canada

For Canada

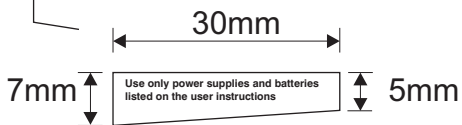

Label-Battery/Adapter
to be put inside the battery compartment

AC1100
Rev.3
12/14/2010

FCC ID:N7TAC1100R
IC: 5786A-AC1100R
Australia:  N10499

Engrave

17.5mm x 1.3mm

17.5mm x 1.3mm

20.5mm x 1.4mm

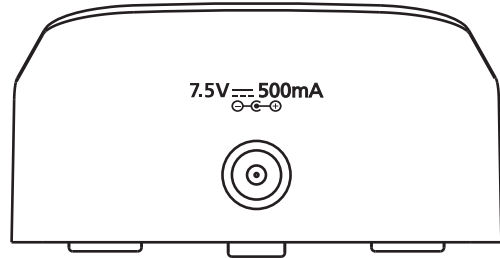
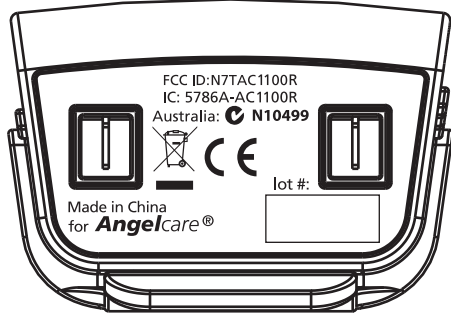

Pad
Printing

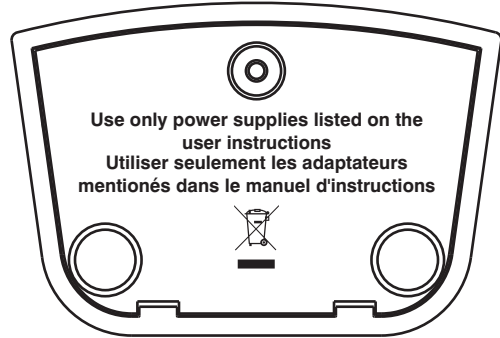

Engrave

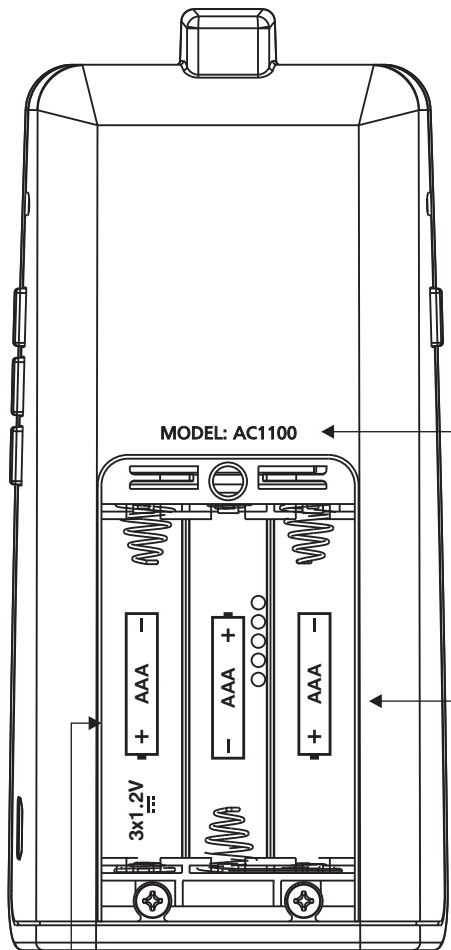

Pad
Printing

Put model
number here
instead of on
the battery door

Engrave

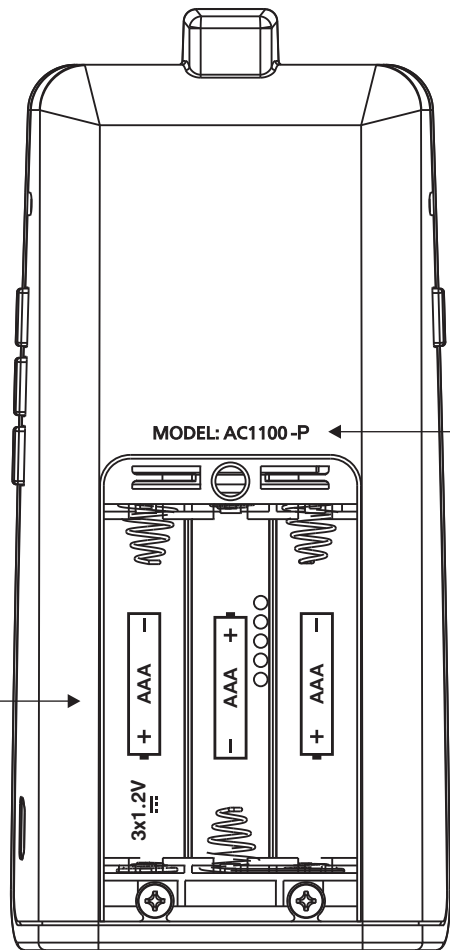

Pad
Printing

Different
model number
with NU
for Canada

For Canada

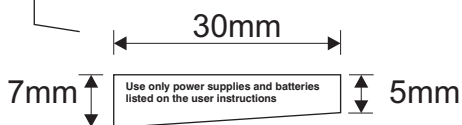

Label-Battery/Adapter
to be put inside the battery compartment

AC1120
Rev.2
12/14/2010

FCC ID:N7TAC1100R
IC: 5786A-AC1100R
Australia:  N10499

Engrave

17.5mm x 1.3mm

17.5mm x 1.3mm

20.5mm x 1.4mm

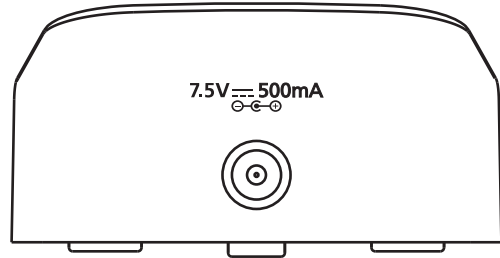
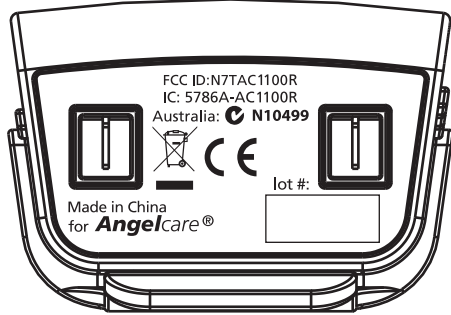

Pad
Printing

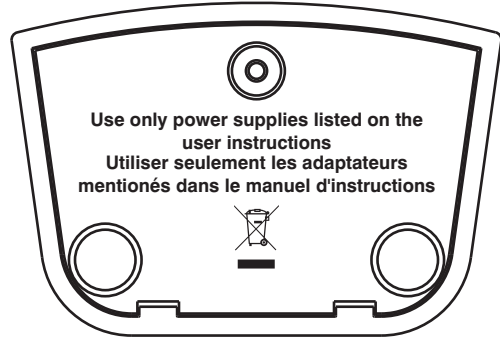

Engrave

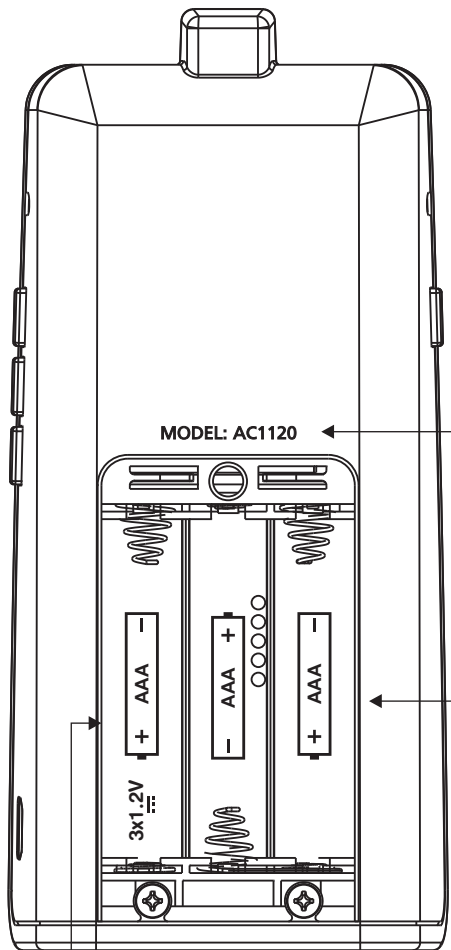

Pad
Printing

Put model
number here
instead of on
the battery door

Engrave

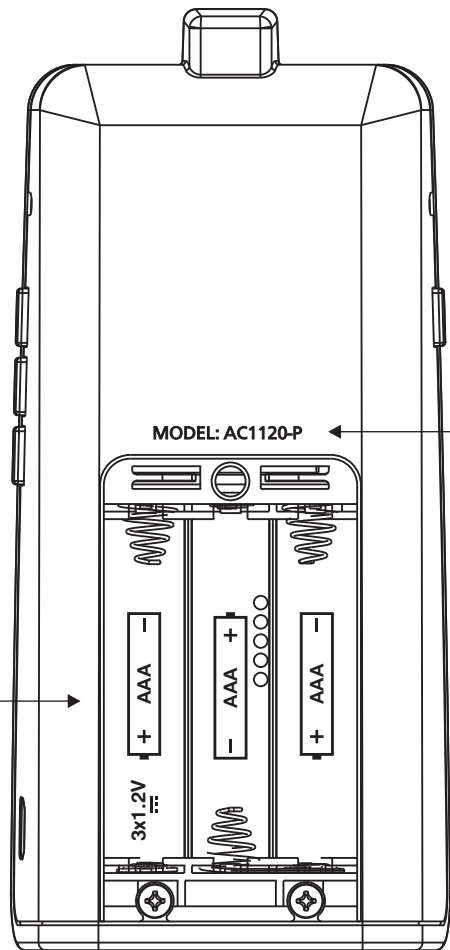

Pad
Printing

Different
model number
with NU
for Canada

For Canada

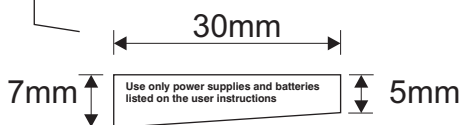

Label-Battery/Adapter
to be put inside the battery compartment