



# FCC LTE NB1 Test Report

**CUSTOMER** : Sierra Wireless Inc.  
**EQUIPMENT** : Radio Module  
**MODEL NAME** : WP7702  
**FCC ID** : N7NWP77B  
**STANDARD** : 47 CFR Part 2, 22(H), 24(E), 27  
**CLASSIFICATION** : PCS Licensed Transmitter (PCB)

This is a partial report. The product was received on Dec. 05, 2017 and completely tested on Apr. 13, 2018. We, SPORTON INTERNATIONAL Inc., would like to declare that the tested sample has been evaluated in accordance with the test procedures given in ANSI / TIA-603-E and the testing has shown the tested sample to be in compliance with the applicable technical standards.

The test results in this report apply exclusively to the tested model / sample. Without written approval of SPORTON INTERNATIONAL INC., the test report shall not be reproduced except in full.

Reviewed by: Joseph Lin / Supervisor

Approved by: Jones Tsai / Manager



## **SPORTON INTERNATIONAL INC.**

**No. 52, Hwa Ya 1<sup>st</sup> Rd., Hwa Ya Technology Park, Kwei-Shan District, Tao Yuan City, Taiwan, R.O.C.**

SPORTON INTERNATIONAL INC.

TEL : 886-3-327-3456

FAX : 886-3-328-4978

FCC ID: N7NWP77B

Page Number : 1 of 21

Report Issued Date : Apr. 25, 2018

Report Version : Rev. 01

Report Template No.: BU5-FGLTE Version 2.0



# TABLE OF CONTENTS

**REVISION HISTORY.....3**

**SUMMARY OF TEST RESULT .....4**

**1 GENERAL DESCRIPTION .....5**

    1.1 Customer .....5

    1.2 Manufacturer.....5

    1.3 Product Feature of Equipment Under Test.....5

    1.4 Product Specification of Equipment Under Test.....5

    1.5 Modification of EUT .....5

    1.6 Testing Location .....6

    1.7 Applicable Standards.....6

**2 TEST CONFIGURATION OF EQUIPMENT UNDER TEST.....7**

    2.1 Test Mode.....7

    2.2 Connection Diagram of Test System.....9

    2.3 Support Unit used in test configuration and system .....9

    2.4 Measurement Results Explanation Example.....9

    2.5 Frequency List of Low/Middle/High Channels .....10

**3 CONDUCTED TEST ITEMS .....11**

    3.1 Measuring Instruments .....11

    3.2 Test Setup .....11

    3.3 Conducted Output Power .....12

    3.4 Peak-to-Average Ratio .....13

    3.5 Occupied Bandwidth.....14

    3.6 Conducted Band Edge .....15

    3.7 Conducted Spurious Emission .....16

    3.8 Frequency Stability .....17

**4 RADIATED TEST ITEMS .....18**

    4.1 Measuring Instruments .....18

    4.2 Test Setup .....18

    4.3 Test Result of Radiated Test.....18

    4.4 Radiated Spurious Emission .....19

**5 LIST OF MEASURING EQUIPMENT .....20**

**6 UNCERTAINTY OF EVALUATION.....21**

**APPENDIX A. TEST RESULTS OF CONDUCTED TEST**

**APPENDIX B. TEST RESULTS OF RADIATED TEST**



### REVISION HISTORY

REPORT NO.	VERSION	DESCRIPTION	ISSUED DATE
FG7D0540D	Rev. 01	Initial issue of report	Apr. 25, 2018



### SUMMARY OF TEST RESULT

Report Section	FCC Rule	Description	Limit	Result	Remark
3.3	§2.1046	Conducted Output Power	Reporting Only	PASS	-
3.4	§24.232(d)	Peak-to-Average Ratio	<13 dB	PASS	-
3.5	§2.1049	Occupied Bandwidth	Reporting Only	PASS	-
3.6	§2.1051 §22.917(a) §24.238(a) §27.53(c)(2)(4) §27.53(g)	Conducted Band Edge Measurement (Band 2) (Band 12) (Band 13) (Band 26)	< 43+10log <sub>10</sub> (P[Watts])	PASS	-
3.7	§2.1051 §22.917(a) §24.238(a) §27.53(c)(2) §27.53(g)	Conducted Spurious Emission (Band 2) (Band 12) (Band 13) (Band 26)	< 43+10log <sub>10</sub> (P[Watts])	PASS	-
3.8	§2.1055 §22.355	Frequency Stability Temperature & Voltage	< 2.5 ppm for Part 22	PASS	-
	§2.1055 §24.235 §27.54		Within Authorized Band		
4.4	§2.1053 §22.917(a) §24.238(a) §27.53(c)(2) §27.53(f) §27.53(g)	Radiated Spurious Emission (Band 2) (Band 12) (Band 13) (Band 26)	< 43+10log <sub>10</sub> (P[Watts])	PASS	Under limit 6.97 dB at 1576.000 MHz



# 1 General Description

## 1.1 Customer

Sierra Wireless Inc.  
13811 Wireless Way Richmond, BC Canada V6V 3A4

## 1.2 Manufacturer

Sierra Wireless Inc.  
13811 Wireless Way Richmond, BC Canada V6V 3A4

## 1.3 Product Feature of Equipment Under Test

WP7702 is an IOT module supporting multiband LTE CATM1/NB1 and 2G operation.

## 1.4 Product Specification of Equipment Under Test

Standards-related Product Specification	
<b>Tx Frequency</b>	LTE Band 2 : 1850.1 MHz ~ 1909.9 MHz LTE Band 12 : 699.1 MHz ~ 715.9 MHz LTE Band 13 : 777.1 MHz ~ 786.9 MHz LTE Band 26 : 824.1MHz ~ 848.9 MHz
<b>Rx Frequency</b>	LTE Band 2 : 1930.1 MHz ~ 1989.9 MHz LTE Band 12 : 729.1 MHz ~ 745.9 MHz LTE Band 13 : 746.1 MHz ~ 755.9 MHz LTE Band 26 : 869.1 MHz ~ 893.9 MHz
<b>Maximum Output Power to Antenna</b>	LTE Band 2 : 23.79 dBm LTE Band 12 : 23.56 dBm LTE Band 13 : 23.62 dBm LTE Band 26 : 23.12 dBm
<b>Type of Modulation</b>	BPSK / QPSK

## 1.5 Modification of EUT

No modifications are made to the EUT during all test items.



## 1.6 Testing Location

Sporton Lab is accredited to ISO 17025 by Taiwan Accreditation Foundation (TAF code : 1190) and the FCC designation No. TW1190 under the FCC 2.948(e) by Mutual Recognition Agreement (MRA) in FCC Test.

<b>Test Site</b>	SPORTON INTERNATIONAL INC.	
<b>Test Site Location</b>	No. 52, Hwa Ya 1 <sup>st</sup> Rd., Hwa Ya Technology Park, Kwei-Shan District, Tao Yuan City, Taiwan, R.O.C. TEL: +886-3-327-3456 FAX: +886-3-328-4978	
<b>Test Site No.</b>	<b>Sporton Site No.</b>	
	TH05-HY	03CH07-HY

**Note:** The test site complies with ANSI C63.4 2014 requirement.

## 1.7 Applicable Standards

According to the specifications of the manufacturer, the EUT must comply with the requirements of the following standards:

- 47 CFR Part 2, 22(H), 24(E), 27
- ANSI / TIA-603-E
- FCC KDB 971168 D01 Power Meas. License Digital Systems v03r01

**Remark:** All test items were verified and recorded according to the standards and without any deviation during the test.



## 2 Test Configuration of Equipment Under Test

### 2.1 Test Mode

Antenna port conducted and radiated test items listed below are performed according to KDB 971168 D01 Power Meas. License Digital Systems v03r01 with maximum output power.

Radiated measurements are performed by rotating the EUT in three different orthogonal test planes to find the maximum emission.

Test Items	LTE -NB1	Subcarrier (kHz)		Modulation		Tone@		Test Channel		
	Band	3.75	15	BPSK	QPSK	1	Full	L	M	H
Max. Output Power	2	✓	✓	✓	✓	✓	✓	✓	✓	✓
	12	✓	✓	✓	✓	✓	✓	✓	✓	✓
	13	✓	✓	✓	✓	✓	✓	✓	✓	✓
	26	✓	✓	✓	✓	✓	✓	✓	✓	✓
Peak-to-Average Ratio	2		✓	✓	✓	✓	✓	✓	✓	✓
	12		✓	✓	✓	✓	✓	✓	✓	✓
	13		✓	✓	✓	✓	✓	✓	✓	✓
	26		✓	✓	✓	✓	✓	✓	✓	✓
26dB and 99% Bandwidth	2		✓	✓	✓		✓	✓	✓	✓
	12		✓	✓	✓		✓	✓	✓	✓
	13		✓	✓	✓		✓	✓	✓	✓
	26		✓	✓	✓		✓	✓	✓	✓
Conducted Band Edge	2	✓	✓	✓	✓	✓	✓	✓		✓
	12	✓	✓	✓	✓	✓	✓	✓		✓
	13	✓	✓	✓	✓	✓	✓	✓		✓
	26	✓	✓	✓	✓	✓	✓	✓		✓
Conducted Spurious Emission	2	✓	✓	✓	✓	✓		✓	✓	✓
	12	✓	✓	✓	✓	✓		✓	✓	✓
	13	✓	✓	✓	✓	✓		✓	✓	✓
	26	✓	✓	✓	✓	✓		✓	✓	✓



Test Items	LTE -NB1	Subcarrier (kHz)		Modulation		Tone@		Test Channel		
	Band	3.75	15	BPSK	QPSK	1	Full	L	M	H
Frequency Stability	2		v	v			v		v	
	12		v	v			v		v	
	13		v	v			v		v	
	26		v	v			v		v	
Radiated Spurious Emission	2	Worst Case						v	v	v
	12	Worst Case						v	v	v
	13	Worst Case						v	v	v
	26	Worst Case						v	v	v
Note	1. The mark "v" means that this configuration is chosen for testing 2. The mark "-" means that this bandwidth is not supported. 3. The device is investigated from 30MHz to 10 times of fundamental signal for radiated spurious emission test under different RB size/offset and modulations in exploratory test. Subsequently, only the worst case emissions are reported.									



## 2.2 Connection Diagram of Test System

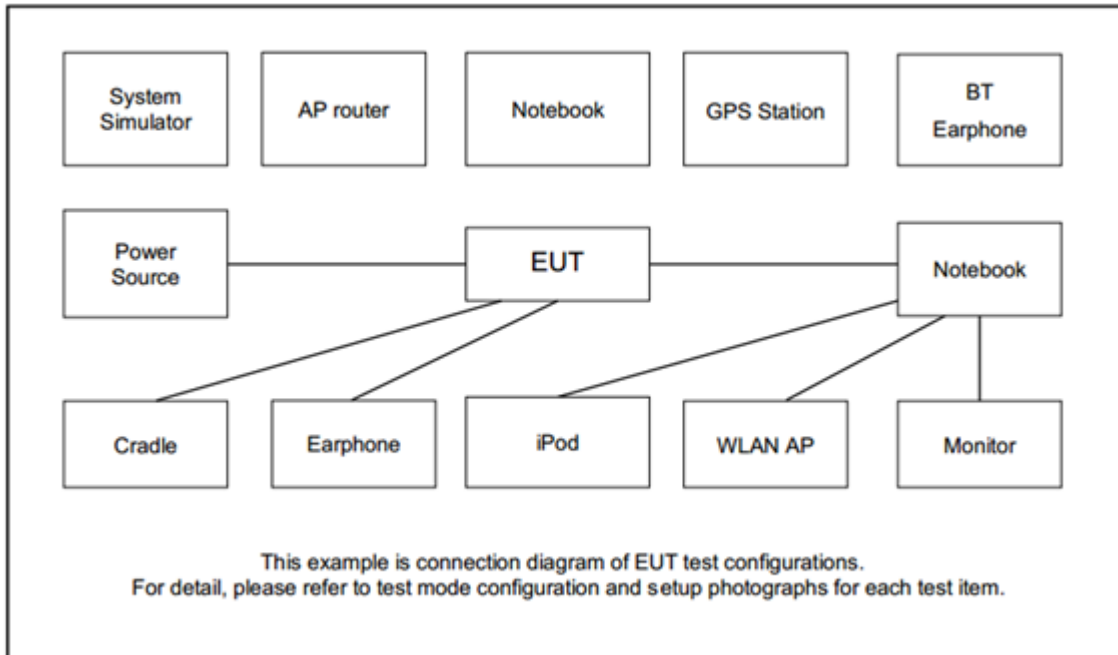

## 2.3 Support Unit used in test configuration and system

Item	Equipment	Trade Name	Model No.	FCC ID	Data Cable	Power Cord
1.	LTE-NB1 Base Station	Anritsu	MT8821C	N/A	N/A	Unshielded, 1.8 m
2.	Base Station	Kaysight	UXM	N/A	N/A	Unshielded, 1.8 m

## 2.4 Measurement Results Explanation Example

### For all conducted test items:

The offset level is set in the spectrum analyzer to compensate the RF cable loss and attenuator factor between EUT conducted output port and spectrum analyzer. With the offset compensation, the spectrum analyzer reading level is exactly the EUT RF output level.

The spectrum analyzer offset is derived from RF cable loss and attenuator factor.

*Offset = RF cable loss + attenuator factor.*

Following shows an offset computation example with cable loss 4.2 dB and 10dB attenuator.

Example :

$$\begin{aligned} \text{Offset(dB)} &= \text{RF cable loss(dB)} + \text{attenuator factor(dB)}. \\ &= 4.2 + 10 = 14.2 \text{ (dB)} \end{aligned}$$



### 2.5 Frequency List of Low/Middle/High Channels

LTE-NB1 Band 2 Channel and Frequency List			
Channel/Frequency(MHz)	Lowest	Middle	Highest
Channel	18601	18900	19199
Frequency	1850.1	1880	1909.9

LTE-NB1 Band 12 Channel and Frequency List			
Channel/Frequency(MHz)	Lowest	Middle	Highest
Channel	23011	23095	23179
Frequency	699.1	707.5	715.9

LTE-NB1 Band 13 Channel and Frequency List			
Channel/Frequency(MHz)	Lowest	Middle	Highest
Channel	23181	23230	23279
Frequency	777.1	782	786.9

LTE-NB1 Band 26 Channel and Frequency List			
Channel/Frequency(MHz)	Lowest	Middle	Highest
Channel	26791	26915	27039
Frequency	824.1	836.5	848.9

### 3 Conducted Test Items

#### 3.1 Measuring Instruments

See list of measuring instruments of this test report.

#### 3.2 Test Setup

##### 3.2.1 Conducted Output Power

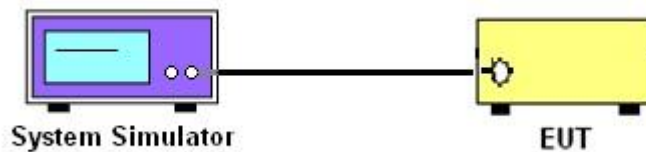

##### 3.2.2 Peak-to-Average Ratio, Occupied Bandwidth ,Conducted Band-Edge and Conducted Spurious Emission

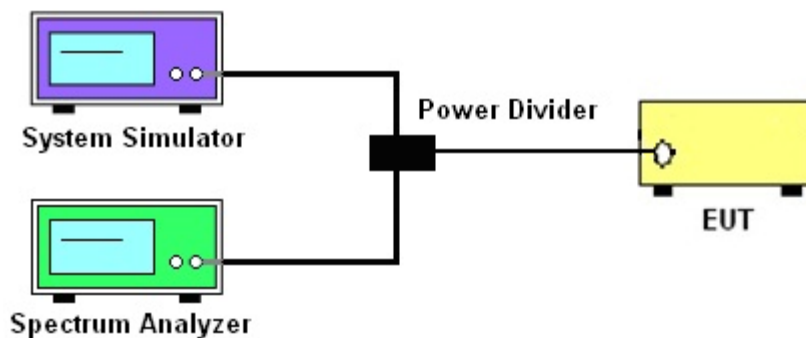

##### 3.2.3 Frequency Stability

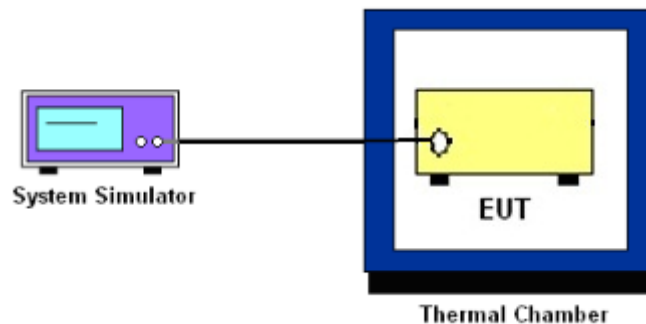

##### 3.2.4 Test Result of Conducted Test

Please refer to Appendix A.



### **3.3 Conducted Output Power**

#### **3.3.1 Description of the Conducted Output Power Measurement**

A system simulator was used to establish communication with the EUT. Its parameters were set to force the EUT transmitting at maximum output power. The measured power in the radio frequency on the transmitter output terminals shall be reported.

#### **3.3.2 Test Procedures**

1. The transmitter output port was connected to the system simulator.
2. Set EUT at maximum power through the system simulator.
3. Select lowest, middle, and highest channels for each band and different modulation.  
Measure and record the power level from the system simulator.



## **3.4 Peak-to-Average Ratio**

### **3.4.1 Description of the PAR Measurement**

Power Complementary Cumulative Distribution Function (CCDF) curves provide a means for characterizing the power peaks of a digitally modulated signal on a statistical basis. A CCDF curve depicts the probability of the peak signal amplitude exceeding the average power level. Most contemporary measurement instrumentation include the capability to produce CCDF curves for an input signal provided that the instrument's resolution bandwidth can be set wide enough to accommodate the entire input signal bandwidth. In measuring transmissions in this band using an average power technique, the peak-to-average ratio (PAR) of the transmission may not exceed 13 dB.

### **3.4.2 Test Procedures**

The testing follows FCC KDB 971168 v03r01 Section 5.7.1

1. The EUT was connected to spectrum and system simulator via a power divider.
2. Set the CCDF (Complementary Cumulative Distribution Function) option in spectrum analyzer.
3. The highest RF powers were measured and recorded the maximum PAPR level associated with a probability of 0.1 %.
4. Record the deviation as Peak to Average Ratio.



## 3.5 Occupied Bandwidth

### 3.5.1 Description of Occupied Bandwidth Measurement

The occupied bandwidth is the width of a frequency band such that, below the lower and above the upper frequency limits, the mean powers emitted are each equal to a specified percentage 0.5% of the total mean transmitted power.

The 26 dB emission bandwidth is defined as the frequency range between two points, one above and one below the carrier frequency, at which the spectral density of the emission is attenuated 26 dB below the maximum in-band spectral density of the modulated signal. Spectral density (power per unit bandwidth) is to be measured with a detector of resolution bandwidth equal to approximately 1.0% of the emission bandwidth.

### 3.5.2 Test Procedures

The testing follows FCC KDB 971168 v03r01 Section 4.2

1. The EUT was connected to spectrum analyzer and system simulator via a power divider.
2. The spectrum analyzer center frequency is set to the nominal EUT channel center frequency. The span range for the spectrum analyzer shall be between two and five times the anticipated OBW.
3. The nominal resolution bandwidth (RBW) shall be in the range of 1 to 5 % of the anticipated OBW, and the VBW shall be at least 3 times the RBW.
4. Set the detection mode to peak, and the trace mode to max hold.
5. Determine the reference value: Set the EUT to transmit a modulated signal. Allow the trace to stabilize. Set the spectrum analyzer marker to the highest level of the displayed trace.  
(this is the reference value)
6. Determine the “-26 dB down amplitude” as equal to (Reference Value – X).
7. Place two markers, one at the lowest and the other at the highest frequency of the envelope of the spectral display such that each marker is at or slightly below the “-X dB down amplitude” determined in step 6. If a marker is below this “-X dB down amplitude” value it shall be placed as close as possible to this value. The OBW is the positive frequency difference between the two markers.
8. Use the 99 % power bandwidth function of the spectrum analyzer and report the measured bandwidth.



## 3.6 Conducted Band Edge

### 3.6.1 Description of Conducted Band Edge Measurement

22.917(a)

For operations in the 824 – 849 MHz band, the FCC limit is  $43 + 10\log_{10}(P[\text{Watts}])$  dB below the transmitter power P(Watts) in a 100kHz bandwidth. However, in the 1MHz bands immediately outside and adjacent to the licensee's frequency block, a resolution bandwidth of at least one percent of the emission bandwidth of the fundamental emission of the transmitter may be employed.

24.238 (a)

For operations in the 1850-1910 and 1930-1990 MHz band, the FCC limit is  $43 + 10\log_{10}(P[\text{Watts}])$  dB below the transmitter power P(Watts) in a 1MHz bandwidth. However, in the 1 MHz bands immediately outside and adjacent to the frequency block a resolution bandwidth of at least one percent of the emission bandwidth of the fundamental emission of the transmitter may be employed.

27.53 (g)

For operations in the 698 -746 MHz band, the FCC limit is  $43 + 10\log_{10}(P[\text{Watts}])$  dB below the transmitter power P(Watts) in a 100 kHz bandwidth. However, in the 100 kilohertz bands immediately outside and adjacent to a licensee's frequency block, a resolution bandwidth of at least 30 kHz may be employed.

### 3.6.2 Test Procedures

The testing follows FCC KDB 971168 v03r01 Section 6.0.

1. The EUT was connected to spectrum analyzer and system simulator via a power divider.
2. The band edges of low and high channels for the highest RF powers were measured.
3. Set RBW  $\geq$  1% EBW in the 1MHz band immediately outside and adjacent to the band edge.
4. Beyond the 1 MHz band from the band edge, RBW=1MHz was used.
5. Set spectrum analyzer with RMS detector.
6. The RF fundamental frequency should be excluded against the limit line in the operating frequency band.
7. Checked that all the results comply with the emission limit line.

The limit line is derived from  $43 + 10\log(P)$ dB below the transmitter power P(Watts)



## **3.7 Conducted Spurious Emission**

### **3.7.1 Description of Conducted Spurious Emission Measurement**

The power of any emission outside of the authorized operating frequency ranges must be lower than the transmitter power (P) by a factor of at least  $43 + 10 \log (P)$  dB.

It is measured by means of a calibrated spectrum analyzer and scanned from 30 MHz up to a frequency including its 10<sup>th</sup> harmonic.

### **3.7.2 Test Procedures**

The testing follows FCC KDB 971168 v03r01 Section 6.0.

1. The EUT was connected to spectrum analyzer and system simulator via a power divider.
2. The RF output of EUT was connected to the spectrum analyzer by RF cable and attenuator. The path loss was compensated to the results for each measurement.
3. The middle channel for the highest RF power within the transmitting frequency was measured.
4. The conducted spurious emission for the whole frequency range was taken.
5. Make the measurement with the spectrum analyzer's RBW = 1MHz, VBW = 3MHz.
6. Set spectrum analyzer with RMS detector.
7. Taking the record of maximum spurious emission.
8. The RF fundamental frequency should be excluded against the limit line in the operating frequency band.
9. The limit line is derived from  $43 + 10\log(P)$ dB below the transmitter power P(Watts)





### 3.8 Frequency Stability

#### 3.8.1 Description of Frequency Stability Measurement

The frequency stability shall be measured by variation of ambient temperature and variation of primary supply voltage to ensure that the fundamental emission stays within the authorized frequency block. The frequency stability of the transmitter shall be maintained within  $\pm 0.00025\%$  ( $\pm 2.5\text{ppm}$ ) of the center frequency.

#### 3.8.2 Test Procedures for Temperature Variation

The testing follows FCC KDB 971168 v03r01 Section 9.0.

1. The EUT was set up in the thermal chamber and connected with the system simulator.
2. With power OFF, the temperature was decreased to  $-30^{\circ}\text{C}$  and the EUT was stabilized before testing. Power was applied and the maximum change in frequency was recorded within one minute.
3. With power OFF, the temperature was raised in  $10^{\circ}\text{C}$  step up to  $50^{\circ}\text{C}$ . The EUT was stabilized at each step for at least half an hour. Power was applied and the maximum frequency change was recorded within one minute.

#### 3.8.3 Test Procedures for Voltage Variation

The testing follows FCC KDB 971168 v03r01 Section 9.0.

1. The EUT was placed in a temperature chamber at  $20\pm 5^{\circ}\text{C}$  and connected with the system simulator.
2. The power supply voltage to the EUT was varied from 85% to 115% of the nominal value measured at the input to the EUT.
3. The variation in frequency was measured for the worst case.

## 4 Radiated Test Items

### 4.1 Measuring Instruments

See list of measuring instruments of this test report.

### 4.2 Test Setup

#### 4.2.1 For radiated test from 30MHz to 1GHz

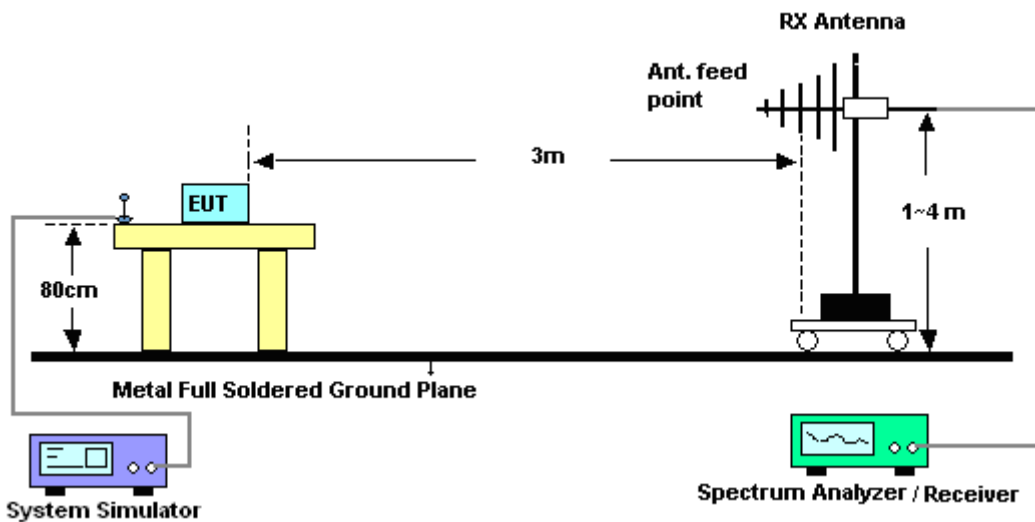

#### 4.2.2 For radiated test above 1GHz

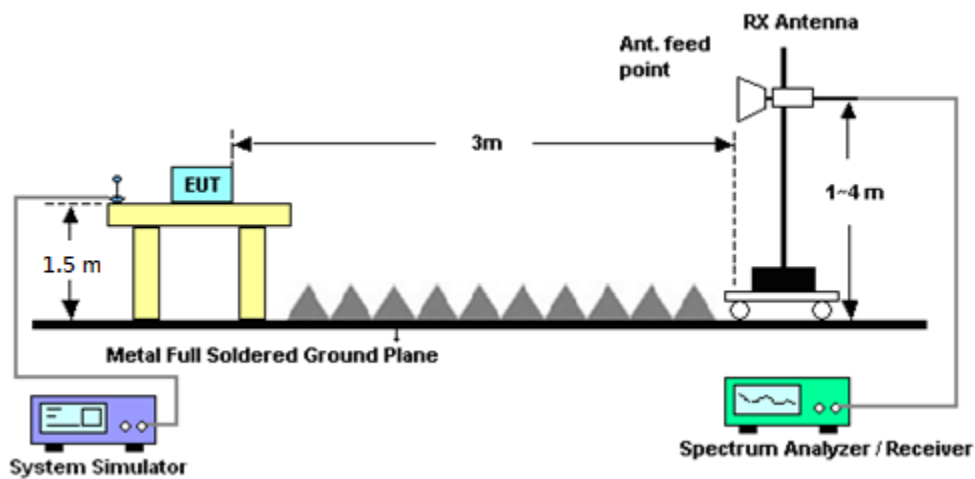

### 4.3 Test Result of Radiated Test

Please refer to Appendix B.



## **4.4 Radiated Spurious Emission**

### **4.4.1 Description of Radiated Spurious Emission**

The radiated spurious emission was measured by substitution method according to ANSI / TIA-603-E. The power of any emission outside of the authorized operating frequency ranges must be attenuated below the transmitter power (P) by a factor of at least  $43 + 10 \log (P)$  dB.

For LTE-NB1 Band 12

For operations in the 746-758 MHz, 775-788 MHz, and 805-806 MHz bands, emissions in the band 1559-1610 MHz shall be limited to  $-70$  dBW/MHz equivalent isotropically radiated power (EIRP) for wideband signals, and  $-80$  dBW EIRP for discrete emissions of less than 700 Hz bandwidth.

The spectrum is scanned from 30 MHz up to a frequency including its 10th harmonic.

### **4.4.2 Test Procedures**

The testing follows FCC KDB 971168 v03r01 Section 5.8 and ANSI / TIA-603-E Section 2.2.12.

1. The EUT was placed on a turntable with 0.8 meter for frequency below 1GHz and 1.5 meter for frequency above 1GHz respectively above ground.
2. The EUT was set 3 meters from the receiving antenna, which was mounted on the antenna tower.
3. The table was rotated 360 degrees to determine the position of the highest spurious emission.
4. The height of the receiving antenna is varied between one meter and four meters to search the maximum spurious emission for both horizontal and vertical polarizations.
5. Make the measurement with the spectrum analyzer's RBW = 1MHz, VBW = 3MHz, taking the record of maximum spurious emission.
6. A horn antenna was substituted in place of the EUT and was driven by a signal generator.
7. Tune the output power of signal generator to the same emission level with EUT maximum spurious emission.
8. Taking the record of output power at antenna port.
9. Repeat step 7 to step 8 for another polarization.
10. The RF fundamental frequency should be excluded against the limit line in the operating frequency band.

The limit line is derived from  $43 + 10\log(P)$ dB below the transmitter power P(Watts)



## 5 List of Measuring Equipment

Instrument	Manufacturer	Model No.	Serial No.	Characteristics	Calibration Date	Test Date	Due Date	Remark
Base Station (Measure)	Anritsu	MT8821C	620166475 5	GSM / GPRS / WCDMA / LTE FDD/TDD	Mar. 26, 2018	Apr. 03, 2018~ Apr. 13, 2018	Mar. 25, 2019	Conducted (TH05-HY)
Spectrum Analyzer	Rohde & Schwarz	FSV40	101397	10Hz~40GHz	Nov. 07, 2017	Apr. 03, 2018~ Apr. 13, 2018	Nov. 06, 2018	Conducted (TH05-HY)
Temperature Chamber	ESPEC	SH-641	92013720	-30°C~70°C	Aug. 28, 2017	Apr. 03, 2018~ Apr. 13, 2018	Aug. 27, 2018	Conducted (TH05-HY)
Programmable Power Supply	GW Instek	PSS-2005	EL890001	1V~20V 0.5A~5A	Oct. 06, 2017	Apr. 03, 2018~ Apr. 13, 2018	Oct. 05, 2018	Conducted (TH05-HY)
Coupler	Warison	1-18GHz 20dB	#B	1G~18GHz	Dec. 04, 2017	Apr. 03, 2018~ Apr. 13, 2018	Dec. 03, 2018	Conducted (TH05-HY)
Bilog Antenna	TESEQ	CBL 6111D&00800 N1D01N-06	35419&03	30MHz to 1GHz	Jan. 07, 2017	Dec. 12, 2017~ Dec. 19, 2017	Jan. 06, 2018	Radiation (03CH07-HY)
Double Ridge Horn Antenna	ESCO	3117	00075962	1GHz ~ 18GHz	Aug. 23, 2017	Dec. 12, 2017~ Dec. 19, 2017	Aug. 22, 2018	Radiation (03CH07-HY)
Horn Antenna	ESCO	3117	00066584	1GHz~18GHz	Sep. 06, 2017	Dec. 12, 2017~ Dec. 19, 2017	Sep. 05, 2018	Radiation (03CH07-HY)
SHF-EHF Horn Antenna	SCHWARZBE CK	BBHA 9170	BBHA9170 251	18GHz- 40GHz	Nov. 10, 2017	Dec. 12, 2017~ Dec. 19, 2017	Nov. 09, 2018	Radiation (03CH07-HY)
SHF-EHF Horn Antenna	SCHWARZBE CK	BBHA 9170	BBHA9170 584	18GHz- 40GHz	Nov. 27, 2017	Dec. 12, 2017~ Dec. 19, 2017	Nov. 26, 2018	Radiation (03CH07-HY)
Preamplifier	COM-POWER	PA-103A	161241	10MHz-1GHz	Mar. 14, 2017	Dec. 12, 2017~ Dec. 19, 2017	Mar. 13, 2018	Radiation (03CH07-HY)
Preamplifier	Agilent	8449B	3008A023 62	1GHz~ 26.5GHz	Oct. 30, 2017	Dec. 12, 2017~ Dec. 19, 2017	Oct. 29, 2018	Radiation (03CH07-HY)
Amplifier	MITEQ	TTA1840-35- HG	1871923	18GHz~40GHz, VSWR : 2.5:1 max	Jul. 18, 2017	Dec. 12, 2017~ Dec. 19, 2017	Jul. 17, 2018	Radiation (03CH07-HY)
Spectrum Analyzer	Agilent	N9010A	MY534701 18	10Hz~44GHz	Apr. 17, 2017	Dec. 12, 2017~ Dec. 19, 2017	Apr. 16, 2018	Radiation (03CH07-HY)
Antenna Mast	Max-Full	MFA520BS	N/A	1m~4m	N/A	Dec. 12, 2017~ Dec. 19, 2017	N/A	Radiation (03CH07-HY)
Turn Table	ChainTek	Chaintek 3000	N/A	0~360 Degree	N/A	Dec. 12, 2017~ Dec. 19, 2017	N/A	Radiation (03CH07-HY)



## 6 Uncertainty of Evaluation

### Uncertainty of Radiated Emission Measurement (30 MHz ~ 1000 MHz)

Measuring Uncertainty for a Level of Confidence of 95% ( $U = 2Uc(y)$ )	3.05
---	------

### Uncertainty of Radiated Emission Measurement (1 GHz ~ 18 GHz)

Measuring Uncertainty for a Level of Confidence of 95% ( $U = 2Uc(y)$ )	3.44
---	------

### Uncertainty of Radiated Emission Measurement (18 GHz ~ 40 GHz)

Measuring Uncertainty for a Level of Confidence of 95% ( $U = 2Uc(y)$ )	3.95
---	------



## Appendix A. Test Results of Conducted Test

### Conducted Output Power(Average power)

LTE-NB1 Band 2 Maximum Average Power [dBm]					
Sub-carrier Spacing [kHz]	Mod	Number of Tones	Lowest	Middle	Highest
3.75	BPSK	1T0	16.55	23.51	16.48
3.75		1T47	16.54	23.49	16.45
3.75	QPSK	1T0	16.53	23.49	16.46
3.75		1T47	16.54	23.51	16.44
15	BPSK	1T0	20.34	23.79	20.13
15		1T11	20.37	23.74	20.11
15	QPSK	1T0	20.37	23.69	20.13
15		1T11	20.33	23.75	20.12
15		12T0	18.51	21.71	18.22

LTE-NB1 Band 12 Maximum Average Power [dBm]					
Sub-carrier Spacing [kHz]	Mod	Number of Tones	Lowest	Middle	Highest
3.75	BPSK	1T0	16.01	23.26	15.89
3.75		1T47	15.98	23.27	15.91
3.75	QPSK	1T0	16.02	23.26	15.91
3.75		1T47	15.99	23.25	15.92
15	BPSK	1T0	19.85	23.55	19.78
15		1T11	19.83	23.53	19.75
15	QPSK	1T0	19.83	23.55	19.77
15		1T11	19.84	23.56	19.75
15		12T0	17.94	21.67	17.87

LTE-NB1 Band 13 Maximum Average Power [dBm]					
Sub-carrier Spacing [kHz]	Mod	Number of Tones	Lowest	Middle	Highest
3.75	BPSK	1T0	15.83	23.03	15.69
3.75		1T47	15.79	23.01	15.68
3.75	QPSK	1T0	15.85	23.05	15.71
3.75		1T47	15.81	22.99	15.69
15	BPSK	1T0	19.98	23.62	19.87
15		1T11	19.99	23.59	19.85
15	QPSK	1T0	20.01	23.61	19.85
15		1T11	19.99	23.61	19.83
15		12T0	18.28	21.68	18.15



LTE-NB1 Band 26 Maximum Average Power [dBm]					
Sub-carrier Spacing [kHz]	Mod	Number of Tones	Lowest	Middle	Highest
3.75	BPSK	1T0	16.81	22.76	15.79
3.75		1T47	16.82	22.72	15.78
3.75	QPSK	1T0	16.83	22.75	15.75
3.75		1T47	16.81	22.71	15.78
15	BPSK	1T0	16.98	23.11	19.51
15		1T11	16.99	23.09	19.51
15	QPSK	1T0	17.01	23.12	19.53
15		1T11	16.99	23.09	19.52
15		12T0	17.45	21.41	18.04



## LTE NB1 Band 2

### Peak-to-Average Ratio

Mode	LTE NB1 Band 2 / 15kHz			
Mod.	BPSK	QPSK		Limit: 13dB
T Size	1T	1T	Full T	Result
Lowest CH	2.52	1.94	3.42	PASS
Middle CH	2.64	1.94	3.51	
Highest CH	2.55	2.09	3.45	





LTE NB1 Band 2 / 15kHz / BPSK

Lowest Channel / 1T

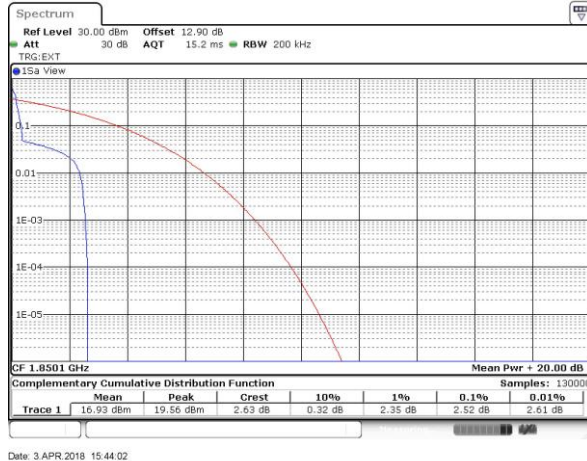

Date: 3 APR 2018 15:44:02

Middle Channel / 1T

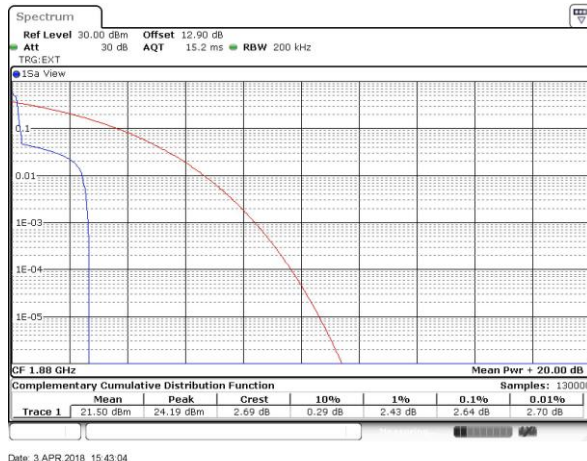

Date: 3 APR 2018 15:43:04

Highest Channel / 1T



Date: 13 APR 2018 15:58:09



LTE NB1 Band 2 / 10MHz / QPSK

Lowest Channel / 1T

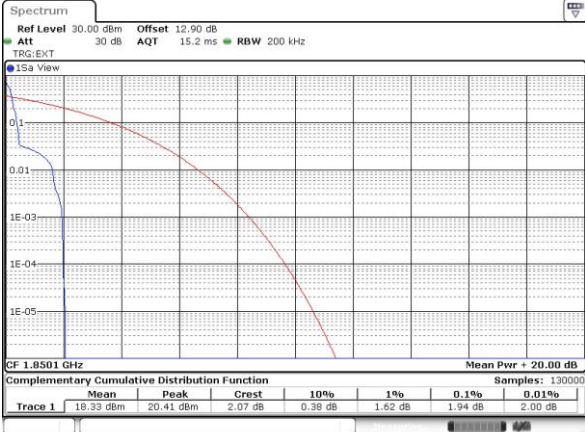

Date: 3 APR 2018 11:52:38

Lowest Channel / Full T

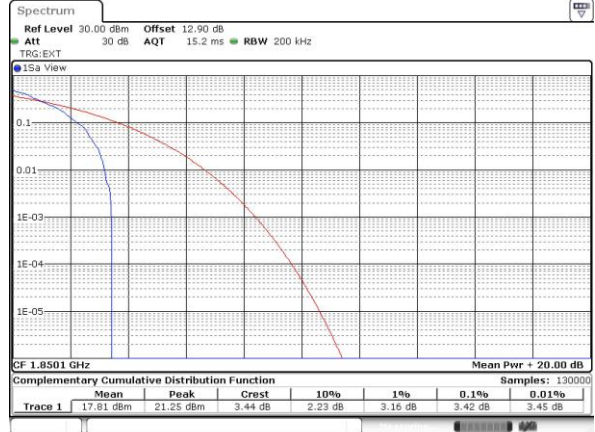

Date: 3 APR 2018 11:50:22

Middle Channel / 1T

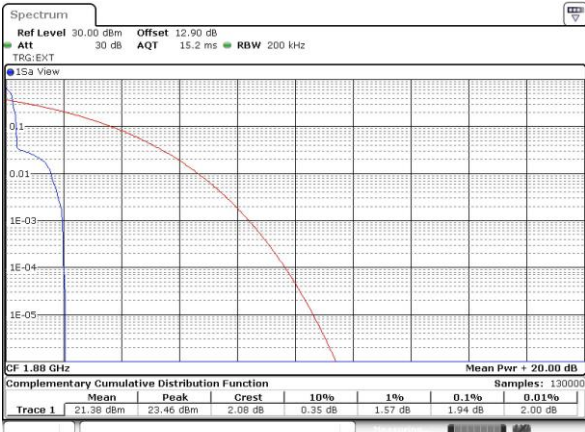

Date: 13 APR 2018 16:02:04

Middle Channel / Full T

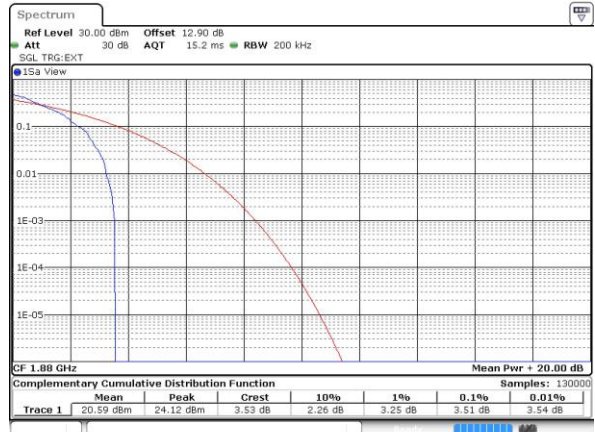

Date: 13 APR 2018 16:05:41

Highest Channel / 1T

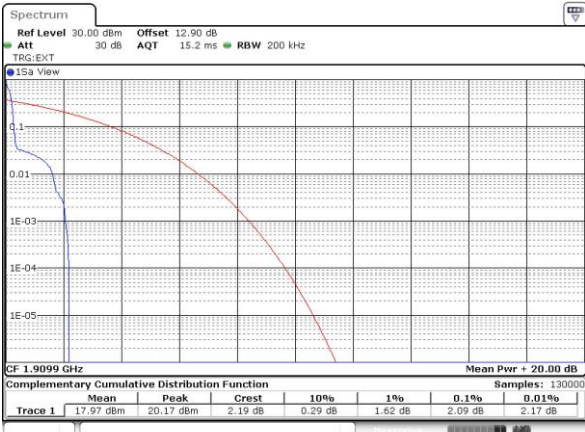

Date: 13 APR 2018 15:59:02

Highest Channel / Full T

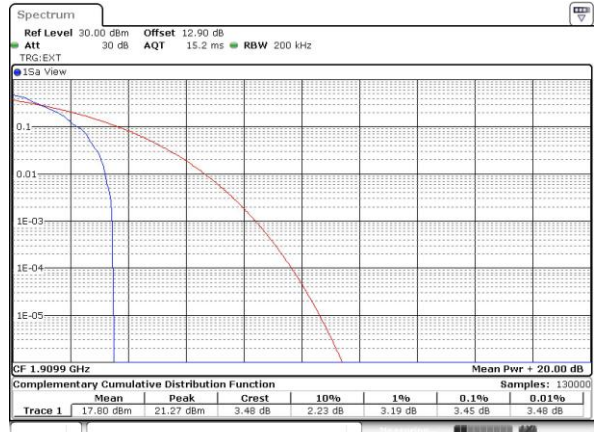

Date: 3 APR 2018 15:41:55



**26dB Bandwidth**

Mode	LTE NB1 Band 2 : 26dB(kHz)
Subcarrier Spacing	15k
Mod.	QPSK
Lowest CH	211.39
Middle CH	227.77
Highest CH	210.99



LTE NB1 Band 2

Lowest Channel / 15kHz / QPSK

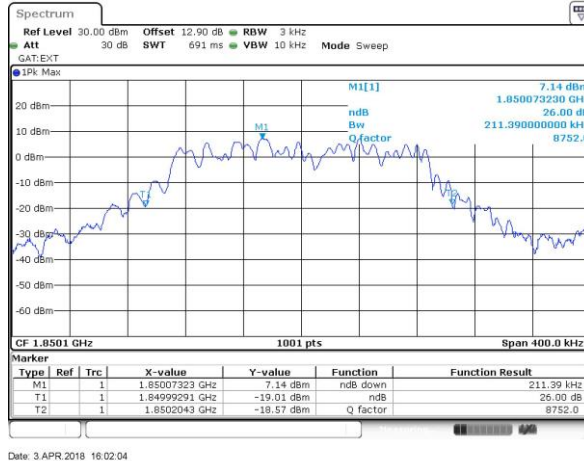

Date: 3 APR 2018 16:02:04

Middle Channel / 15kHz / QPSK

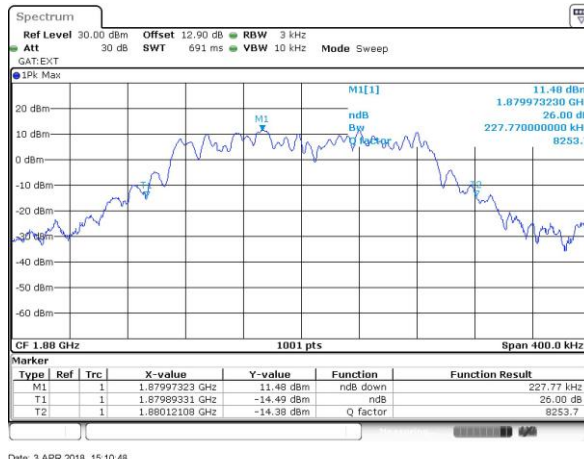

Date: 3 APR 2018 15:10:48

Highest Channel / 15kHz / QPSK

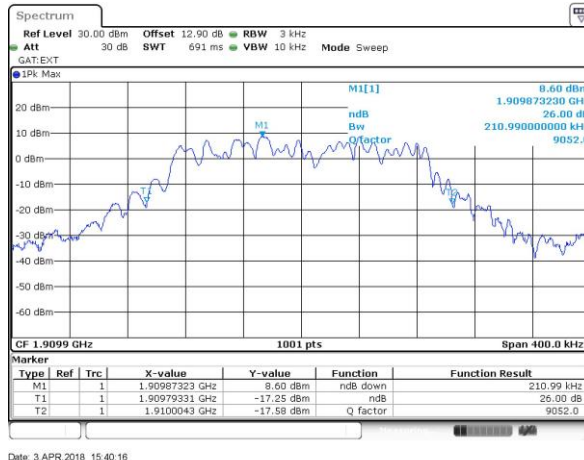

Date: 3 APR 2018 15:40:16



### Occupied Bandwidth

Mode	LTE NB1 Band 2 : OB(kHz)
Subcarrier Spacing	15k
Mod.	QPSK
Lowest CH	187.81
Middle CH	184.22
Highest CH	184.22



LTE NB1 Band 2

Lowest Channel / 15kHz / QPSK

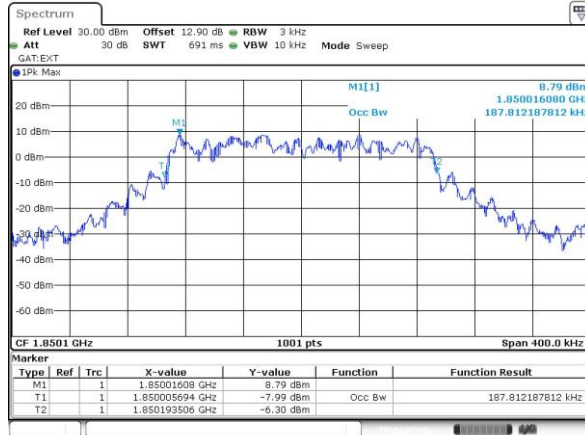

Date: 3 APR 2018 12:26:29

Middle Channel / 15kHz / QPSK

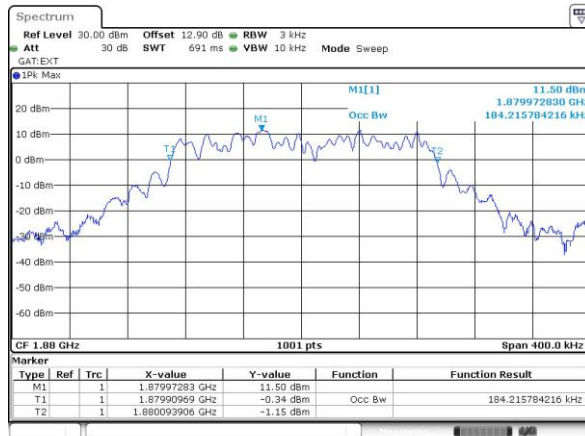

Date: 3 APR 2018 15:07:52

Highest Channel / 15kHz / QPSK

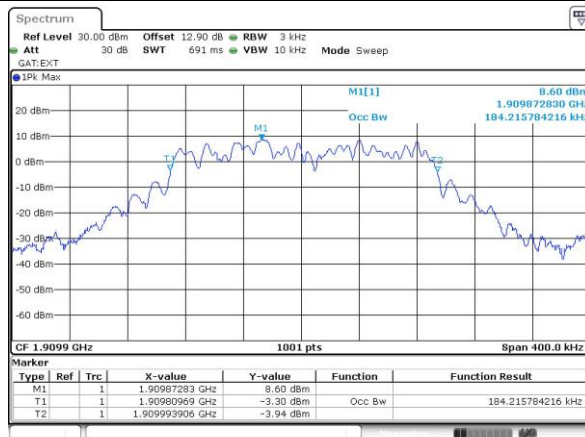

Date: 3 APR 2018 15:37:22



# Conducted Band Edge

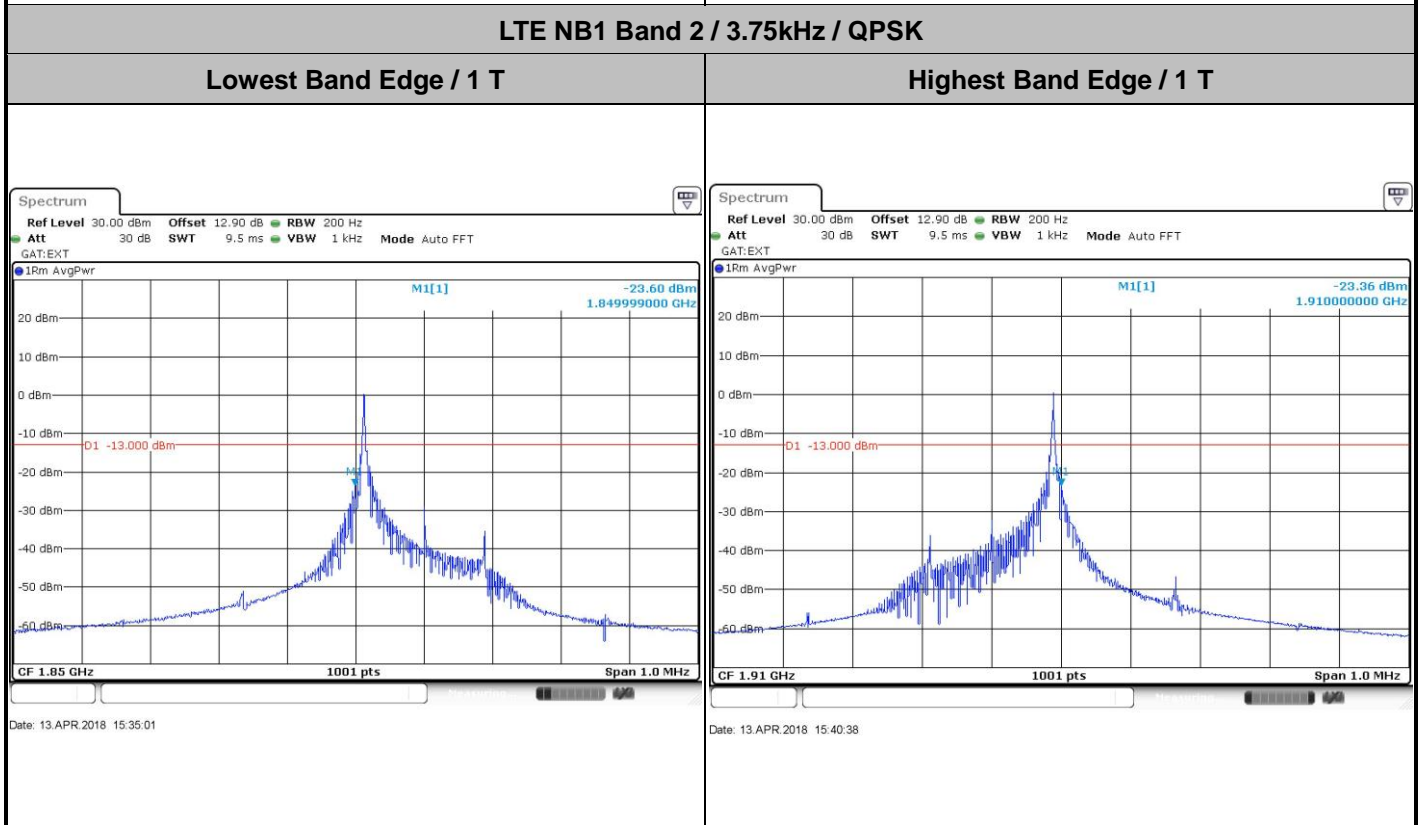
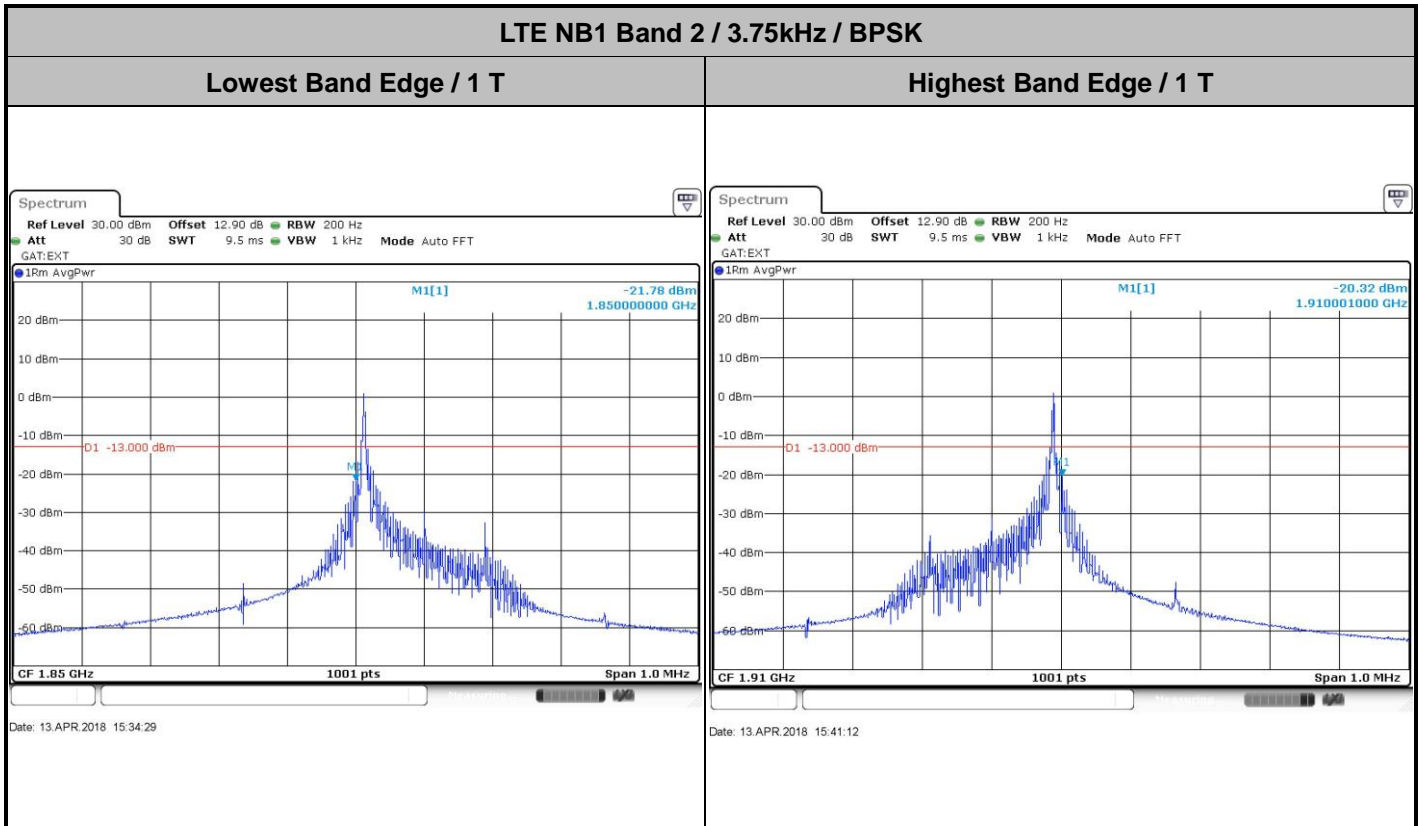

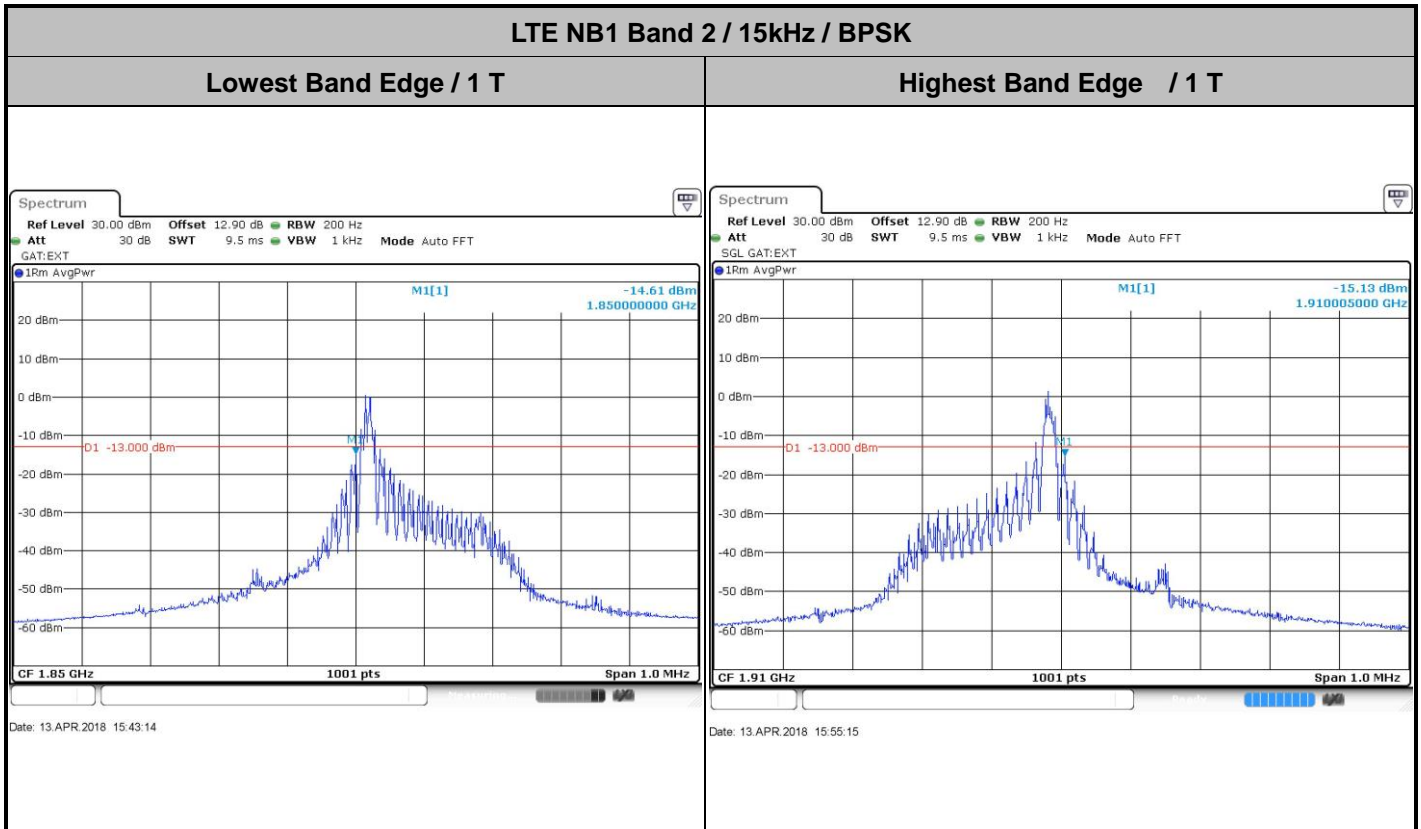



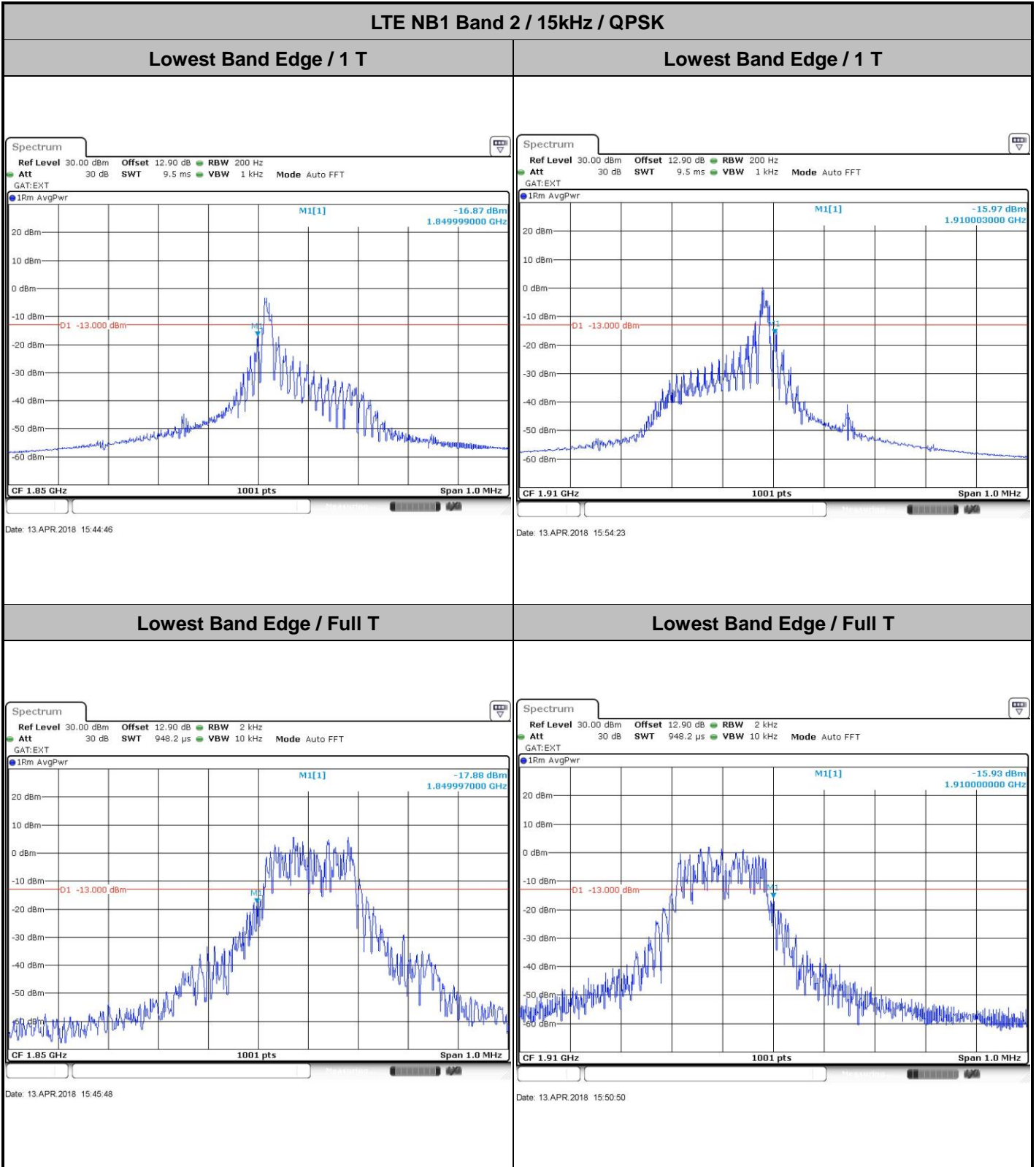



# Conducted Spurious Emission

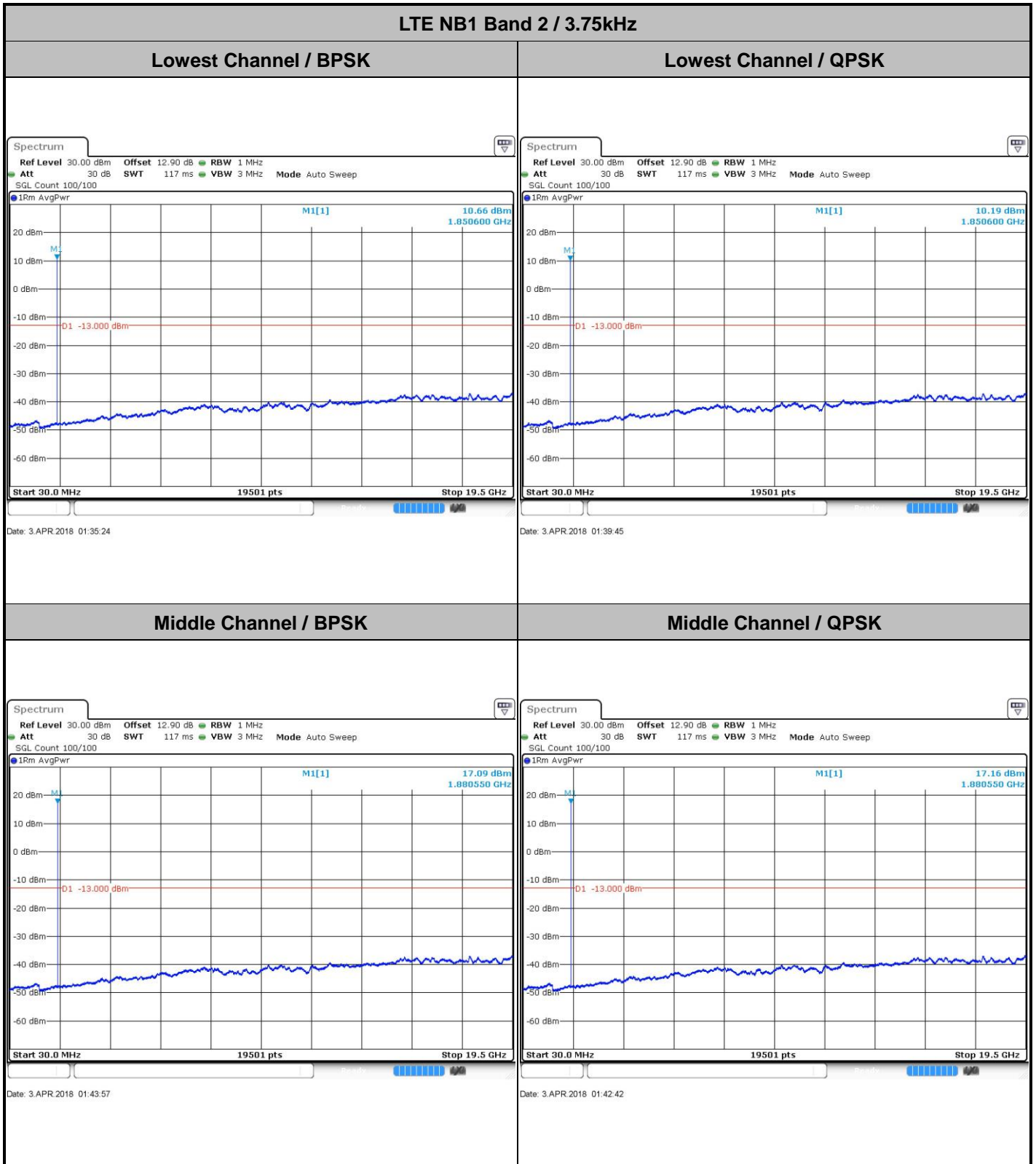



LTE NB1 Band 2 / 3.75kHz

Highest Channel / BPSK

Highest Channel / QPSK

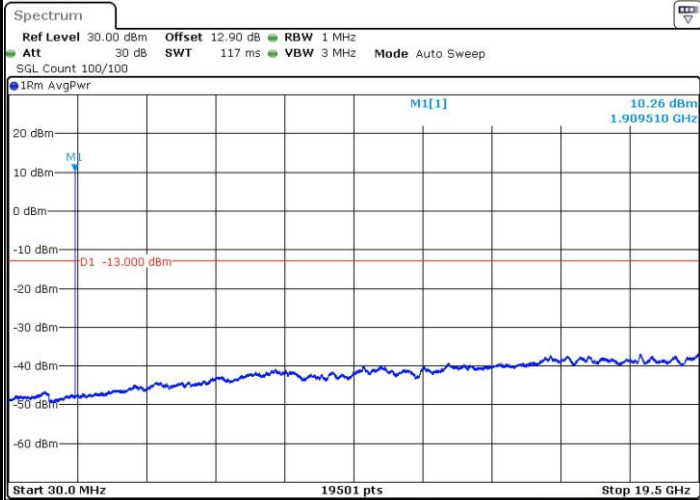

Date: 3.APR.2018 01:50:43

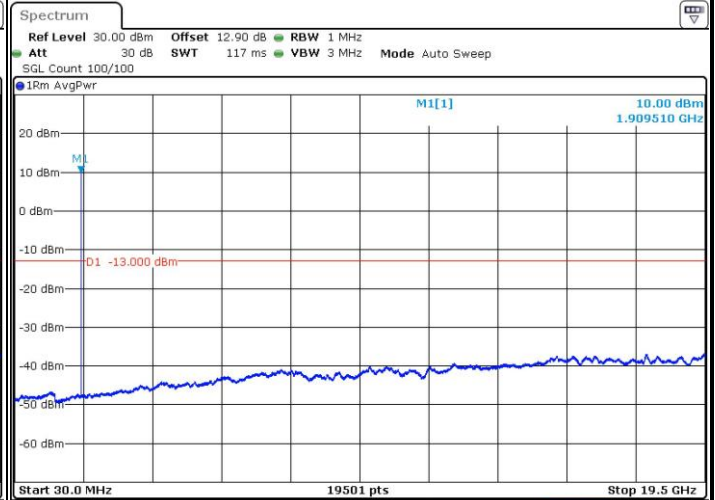

Date: 3.APR.2018 01:51:49



LTE NB1 Band 2 / 15kHz

Lowest Channel / BPSK

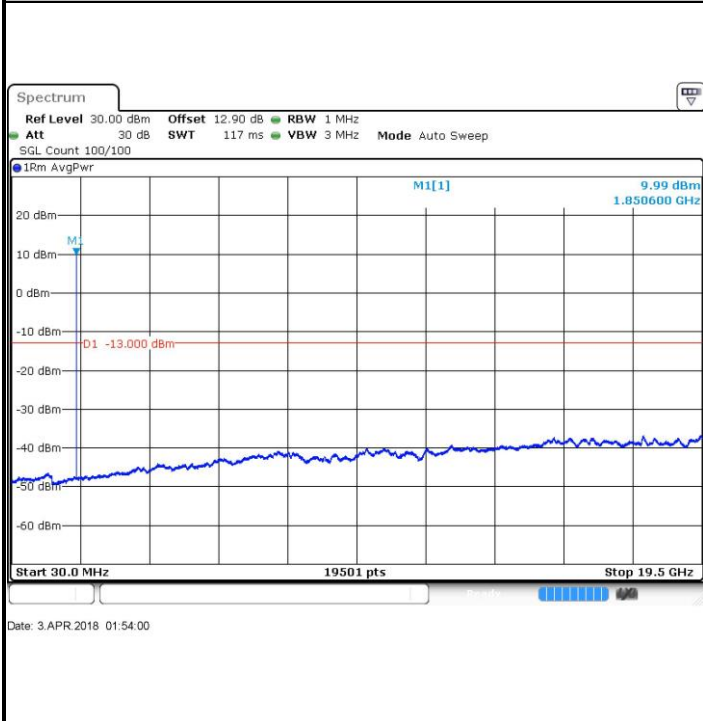

Lowest Channel / QPSK

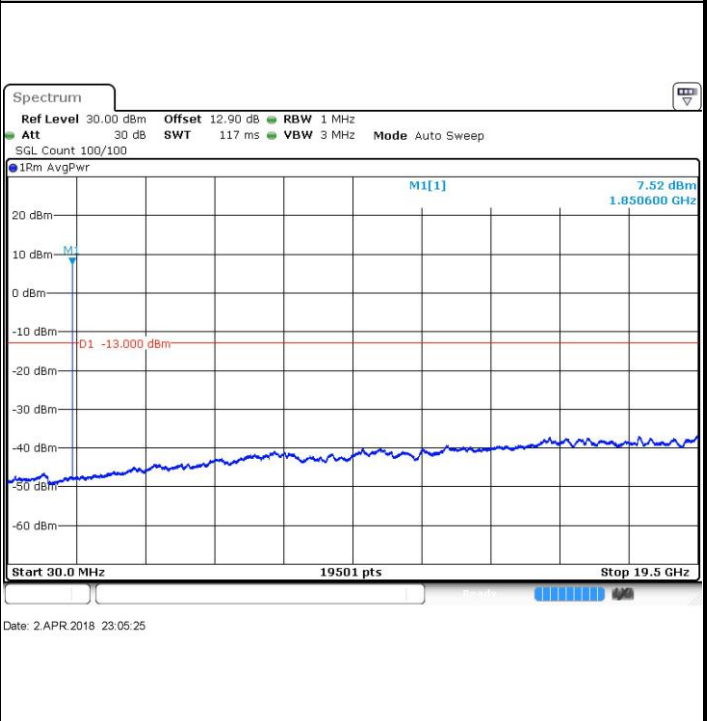

Middle Channel / BPSK

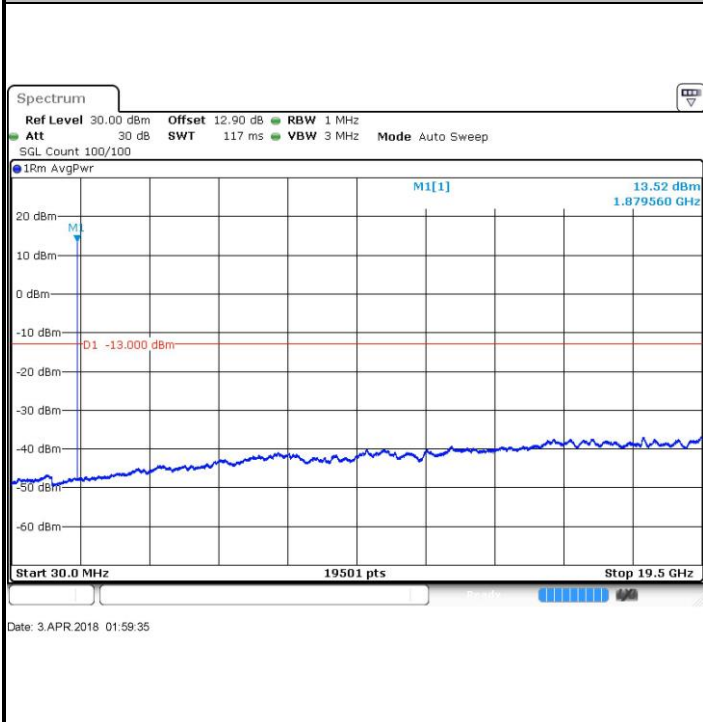

Middle Channel / QPSK

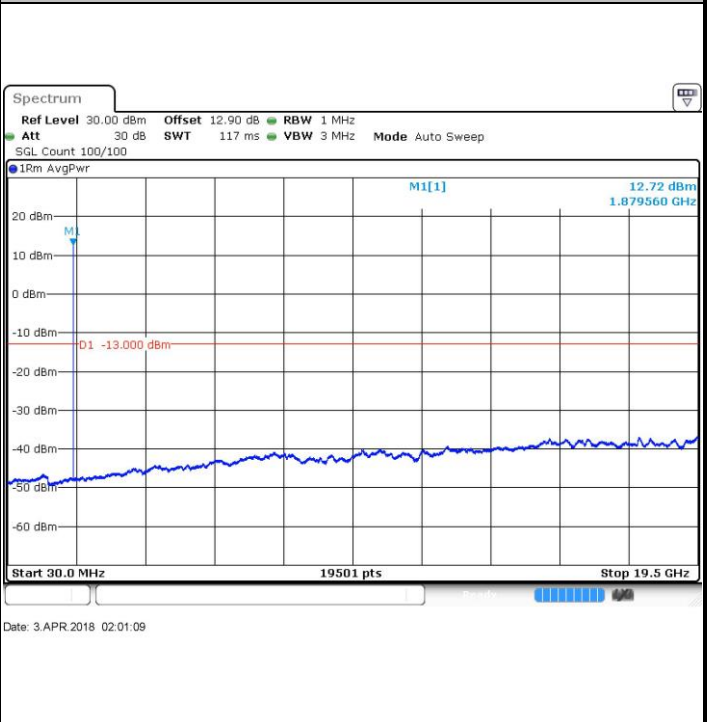

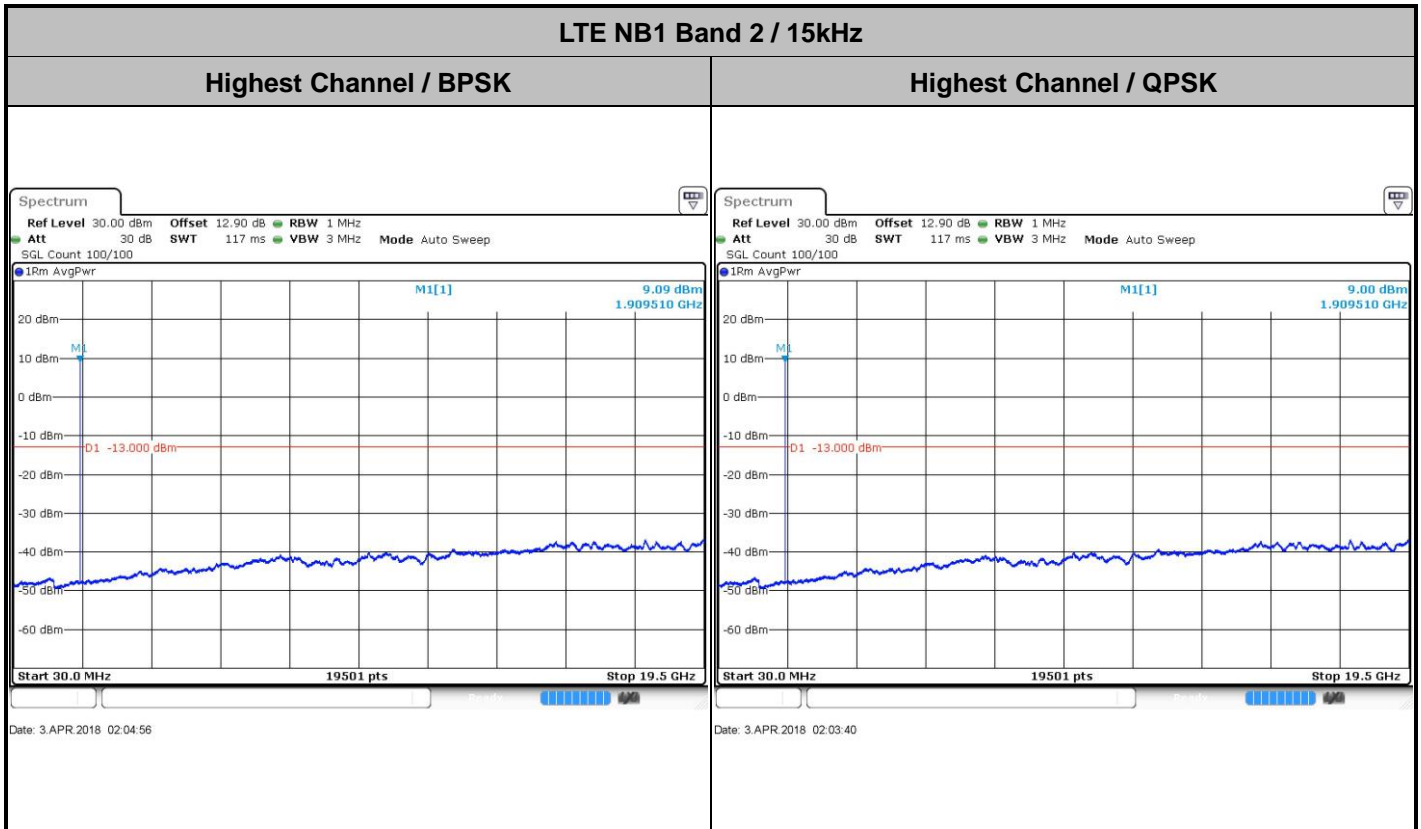



### Frequency Stability

Test Conditions		LTE NB1 Band 2 (BPSK) / Middle Channel	Limit
Temperature (°C)	Voltage (Volt)	15kHz	Note 2.
		Deviation (ppm)	Result
50	Normal Voltage	0.0032	PASS
40	Normal Voltage	0.0023	
30	Normal Voltage	0.0038	
20(Ref.)	Normal Voltage	0.0000	
10	Normal Voltage	0.0005	
0	Normal Voltage	0.0004	
-10	Normal Voltage	0.0007	
-20	Normal Voltage	0.0023	
-30	Normal Voltage	0.0007	
20	Maximum Voltage	0.0002	
20	Normal Voltage	0.0000	
20	Battery End Point	0.0038	

**Note:**

1. Normal Voltage =3.7 V. ; Battery End Point (BEP) =3.4 V. ; Maximum Voltage =4.3 V.
2. Note: The frequency fundamental emissions stay within the authorized frequency block.



## LTE NB1 Band 12

### Peak-to-Average Ratio

Mode	LTE NB1 Band 12 / 15kHz			
Mod.	BPSK	QPSK		Limit: 13dB
T Size	1T	1T	Full T	Result
Lowest CH	2.64	2.17	3.54	PASS
Middle CH	2.58	2.12	3.48	
Highest CH	2.64	2.14	3.51	



LTE NB1 Band 12 / 15kHz / BPSK

Lowest Channel / 1T

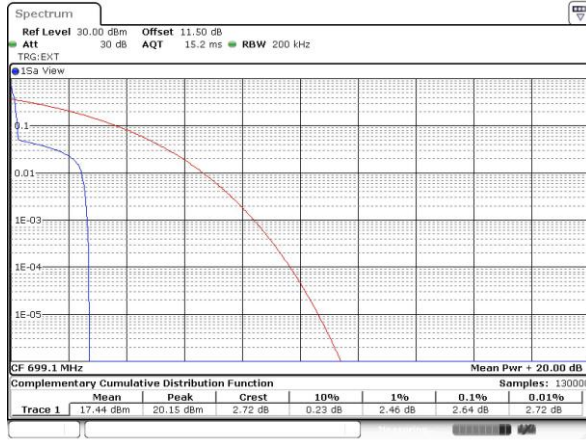

Date: 4 APR 2018 02:38:39

Middle Channel / 1T

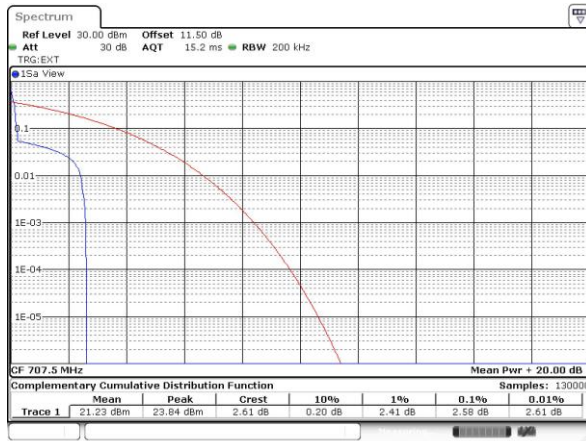

Date: 4 APR 2018 02:51:15

Highest Channel / 1T



Date: 4 APR 2018 03:07:51





LTE NB1 Band 12 / 10MHz / QPSK

Lowest Channel / 1T



Date: 4 APR 2018 02:37:36

Lowest Channel / Full T

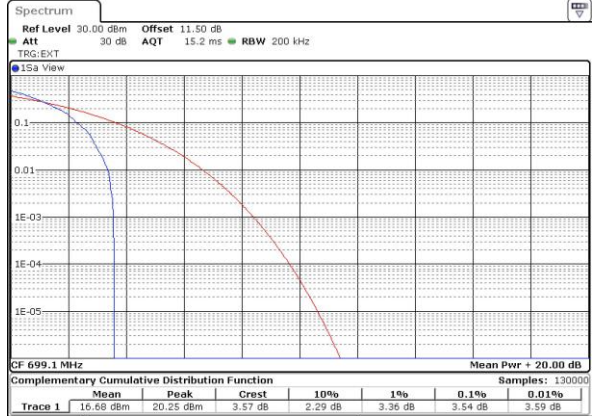

Date: 4 APR 2018 02:36:25

Middle Channel / 1T



Date: 4 APR 2018 02:50:17

Middle Channel / Full T



Date: 4 APR 2018 02:49:08

Highest Channel / 1T



Date: 4 APR 2018 03:09:14

Highest Channel / Full T



Date: 4 APR 2018 03:13:29



**26dB Bandwidth**

Mode	LTE NB1 Band 12 : 26dB(kHz)
Subcarrier Spacing	15k
Mod.	QPSK
Lowest CH	210.59
Middle CH	210.99
Highest CH	210.59



LTE NB1 Band 12

Lowest Channel / 15kHz / QPSK

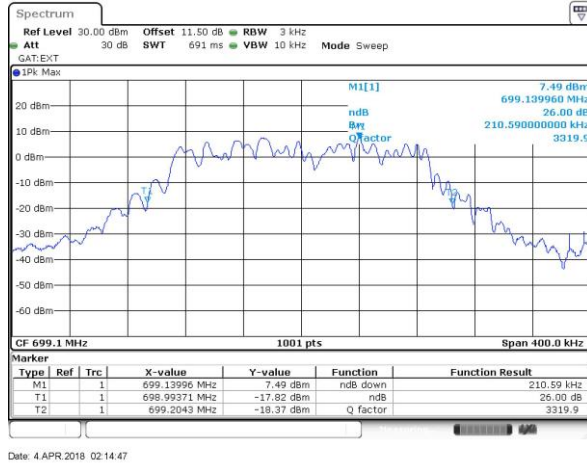

Middle Channel / 15kHz / QPSK

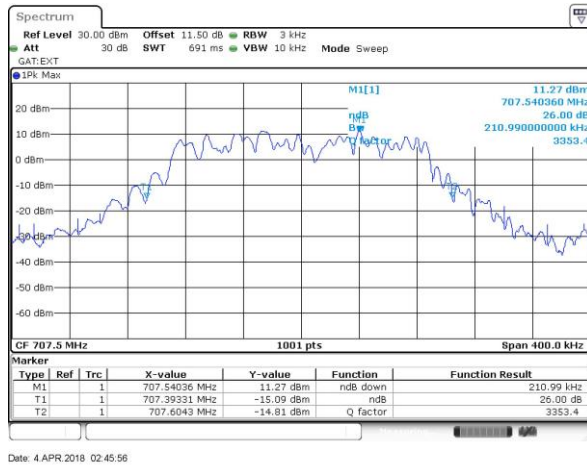

Highest Channel / 15kHz / QPSK

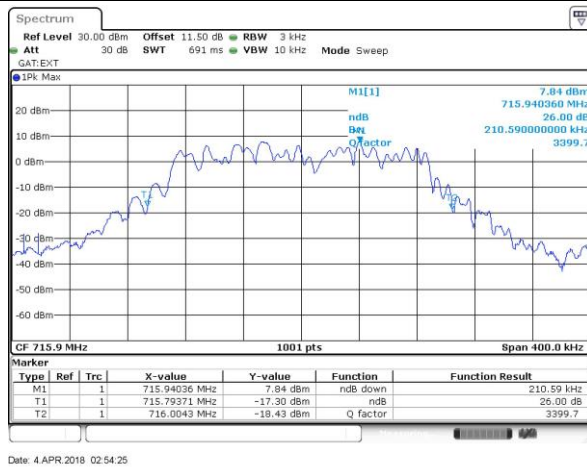



### Occupied Bandwidth

Mode	LTE NB1 Band 12 : OB(kHz)
Subcarrier Spacing	15k
Mod.	QPSK
Lowest CH	182.62
Middle CH	182.22
Highest CH	182.22



LTE NB1 Band 12

Lowest Channel / 15kHz / QPSK

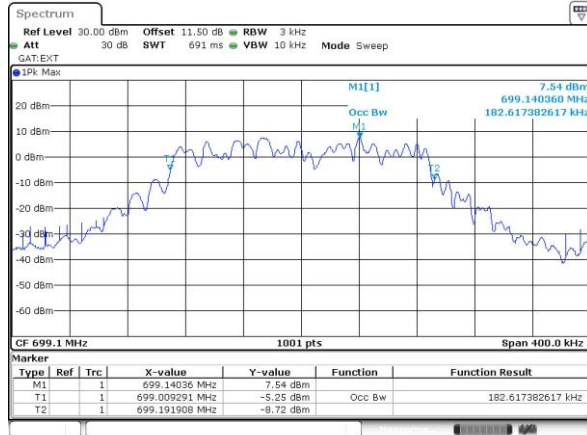

Date: 4 APR 2018 02:34:50

Middle Channel / 15kHz / QPSK



Date: 4 APR 2018 02:48:01

Highest Channel / 15kHz / QPSK

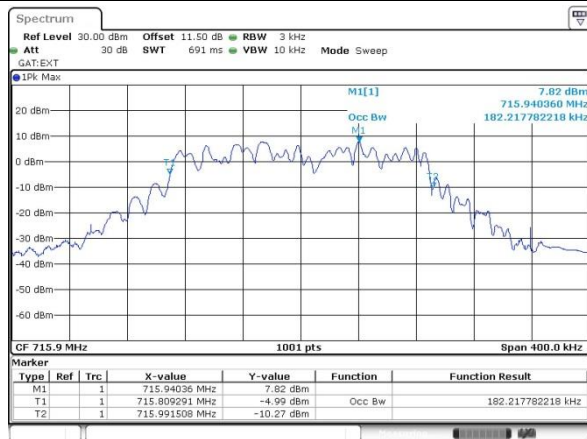

Date: 4 APR 2018 02:56:35



# Conducted Band Edge

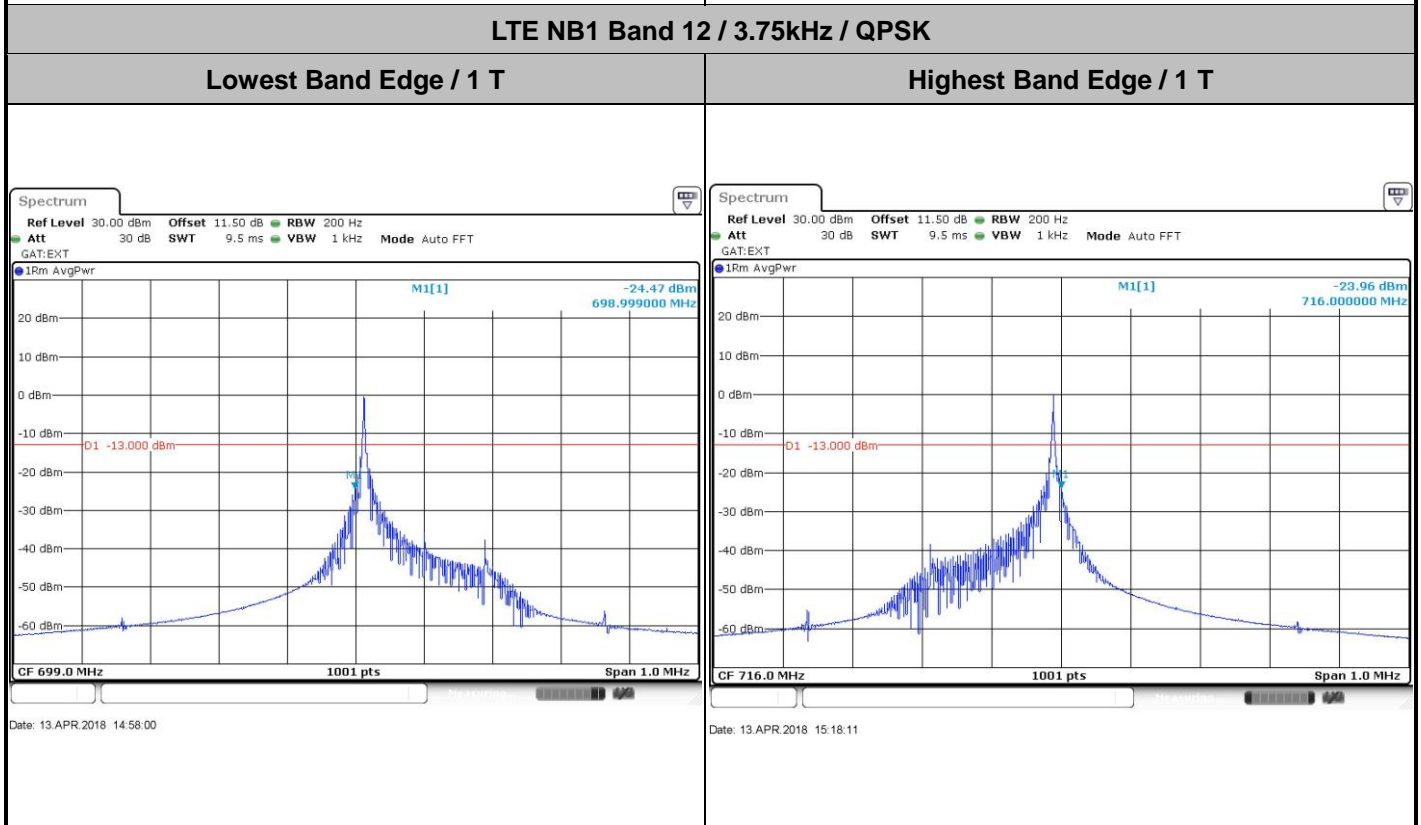
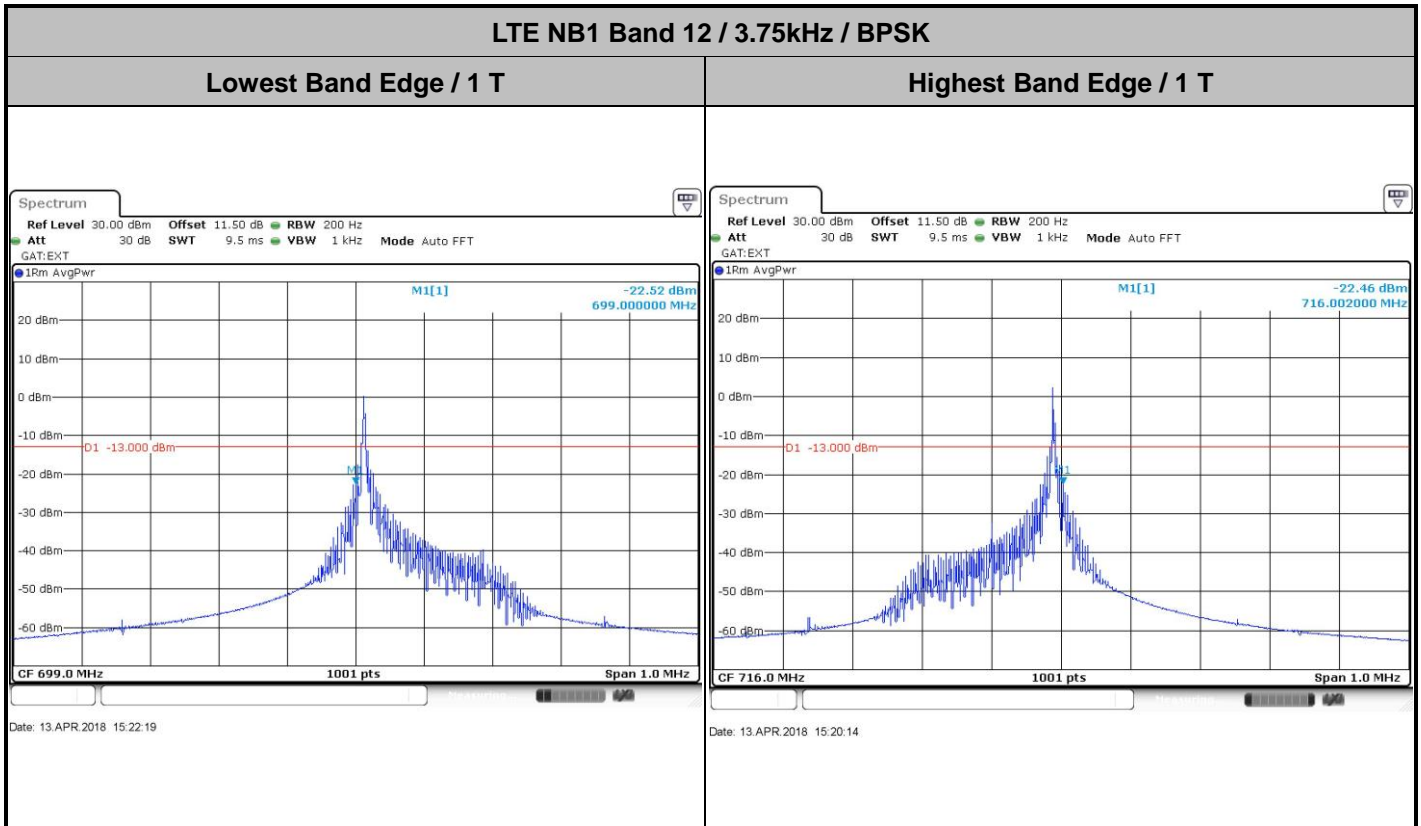



LTE NB1 Band 12 / 15kHz / BPSK

Lowest Band Edge / 1 T

Highest Band Edge / 1 T

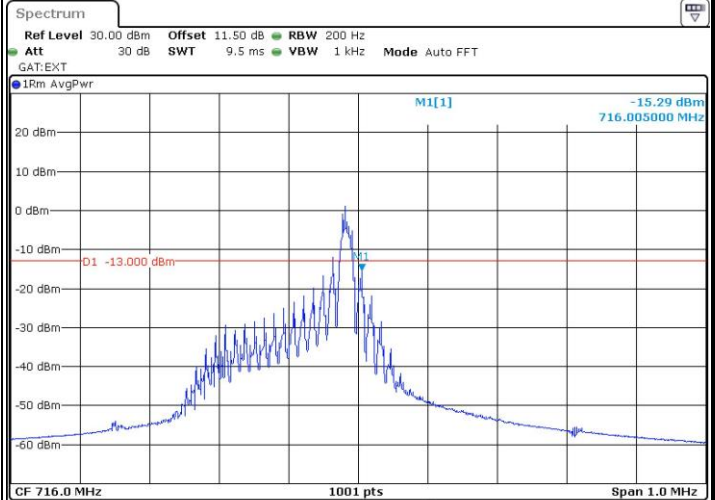
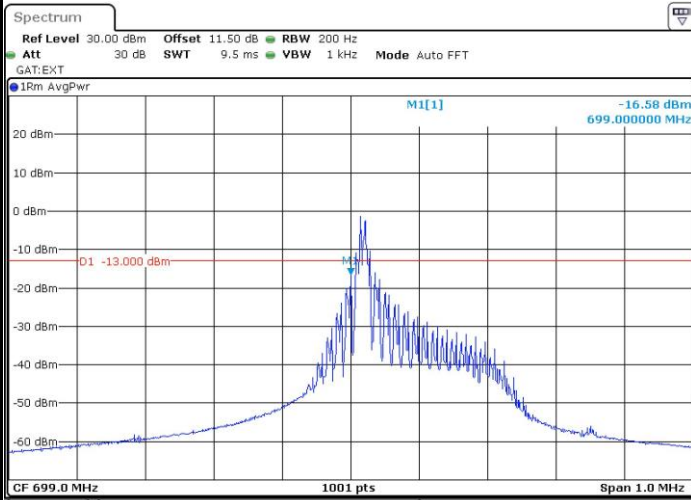



LTE NB1 Band 12 / 15kHz / QPSK

Lowest Band Edge / 1 T

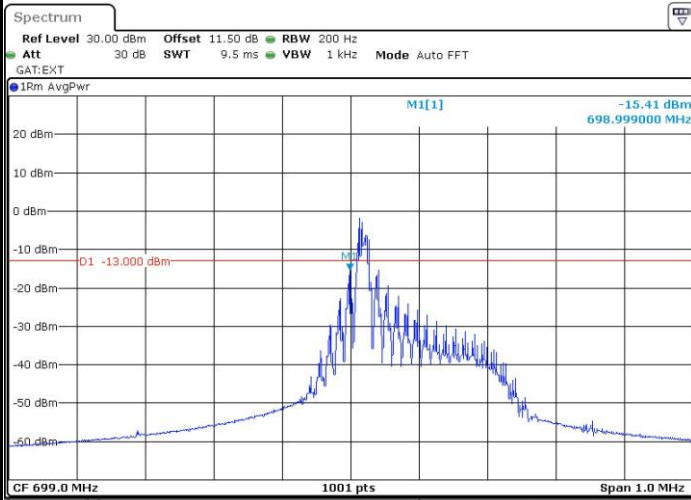

Lowest Band Edge / 1 T

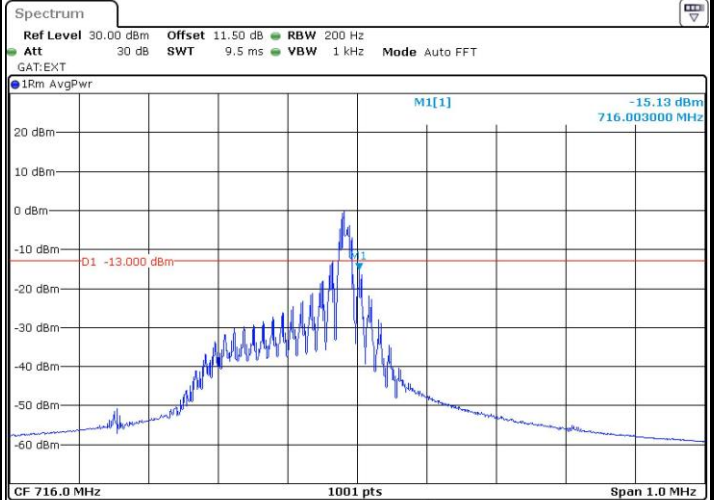

Lowest Band Edge / Full T

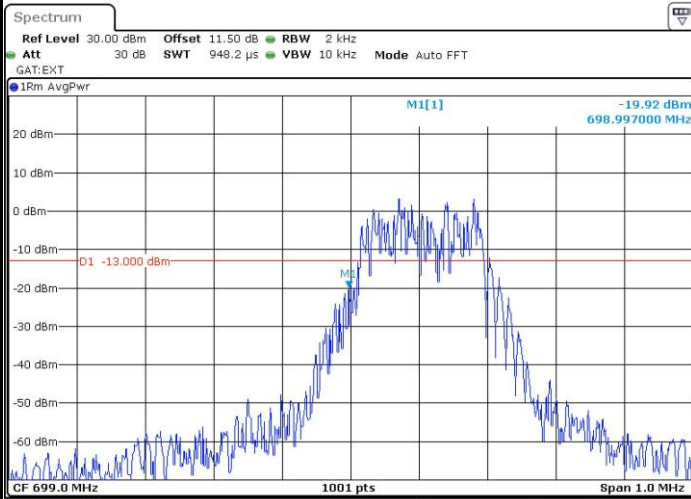

Lowest Band Edge / Full T

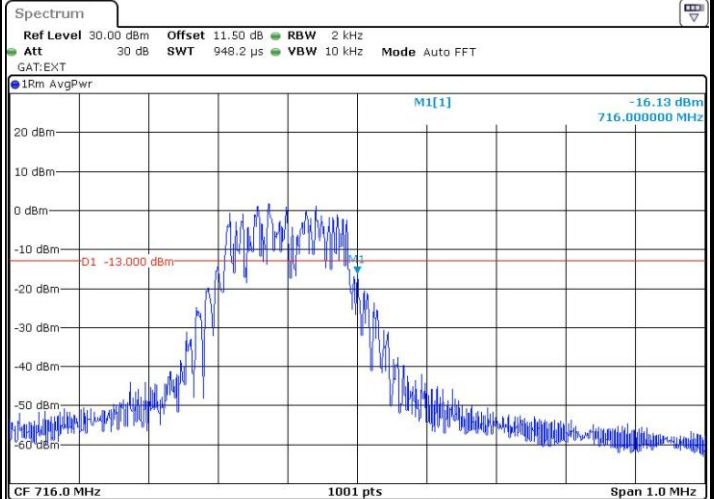





# Conducted Spurious Emission

