



TEST REPORT

REPORT NUMBER: B17W00380-FCC-RF

ON

Type of Equipment: Wireless Modules
Model Name: WP7601
Manufacturer: Sierra Wireless Inc.

ACCORDING TO

FCC CFR Part 2, FREQUENCY ALLOCATIONS AND RADIO TREATY MATTERS; GENERAL RULES AND REGULATIONS; e-CFR, Jun 22, 2017

PART 27, MISCELLANEOUS WIRELESS COMMUNICATIONS SERVICES, e-CFR, Jun 22, 2017

RSS-Gen General Requirements for Compliance of Radio Apparatus. Issue 4, November 13, 2014

RSS-130 Mobile Broadband Services (MBS) Equipment Operating in the Frequency Bands 698-756 MHz and 777-787 MHz, Issue 1, October , 2013

RSS-139 Advanced Wireless Services (AWS) Equipment Operating in the Bands 1710-1780 MHz and 2110-2180 MHz, Issue 3, July 16, 2015

Chongqing Institute of Telecommunications

Month date, year

Jun, 28, 2017

Signature

Zhang Yan

Director

Note:

The test results in this test report relate only to the devices specified in this report. This report shall not be reproduced except in full without the written approval of Chongqing Institute of Telecommunications.



FCC ID: N7NWP76A
ISED: 2147C-WP76A
Report Date: 2017-06-28

Test Firm Name: Chongqing Institute of Telecommunications
FCC Registration Number: 428018

Test Firm Name: Telecommunication Technology Labs. Academy
of Telecommunication Research. MIIT
ISED Registration Number: 11590A

Statement

The measurements shown in this report were made in accordance with the procedures described on test pages. All reported tests were carried out on a sample equipment to demonstrate limited compliance with FCC CFR 47 Parts 2, 27 and RSS-Gen, 130, 139, The sample tested was found to comply with the requirements defined in the applied rules.



CONTENTS

1 GENERAL INFORMATION.....	4
1.1 NOTES	4
1.2 TESTERS.....	5
1.3 TESTING LABORATORY INFORMATION	6
1.4 DETAILS OF APPLICANT OR MANUFACTURER.....	7
2 TEST ITEM.....	8
2.1 GENERAL INFORMATION	8
2.2 OUTLINE OF EQUIPMENT UNDER TEST.....	8
2.3 MODIFICATIONS INCORPORATED IN EUT.....	8
2.4 EQUIPMENT CONFIGURATION.....	8
2.5 OTHER INFORMATION.....	8
3 SUMMARY OF TEST RESULTS	9
4 TEST EQUIPMENTS AND ANCILLARIES USED FOR TESTS.....	10
5 TEST RESULTS.....	11
5.1 CONDUCTED RF POWER OUTPUT	11
5.2 OCCUPIED BANDWIDTH.....	21
5.3 CONDUCTED SPURIOUS EMISSION.....	31
5.4 RADIATED SPURIOUS EMISSION.....	45
5.5 BAND EDGE	56
5.6 FREQUENCY STABILITY OVER TEMPERATURE VARIATION	98
5.7 FREQUENCY STABILITY OVER VOLTAGE VARIATION.....	99
5.8 PEAK TO AVERAGE RATIO.....	100
ANNEX A EUT PHOTOS	103
ANNEX B DEVIATIONS FROM PRESCRIBED TEST METHODS.....	104



1 General Information

1.1 Notes

All reported tests were carried out on a sample equipment to demonstrate limited compliance with FCC CFR 47 Parts 2, 27 and RSS-Gen, 130, 139.

The test results of this test report relate exclusively to the item(s) tested as specified in section 2.

The following deviation from, additions to, or exclusions from the test specifications have been made. See Annex B.

Chongqing Institute of Telecommunications authorizes the applicant or manufacturer (see section 1.4) to reproduce this report provided, and the test report may only be reproduced or published in full. Reproduction or publication of extracts from the report requires the prior written approval of Chongqing Institute of Telecommunications Mr. Zhang Yan.

Any use which a third party makes of this report, or any reliance on or decisions to be made based on it, are the responsibility of such third parties. Chongqing Institute of Telecommunications accepts no responsibility for damages, if any, suffered by any third party as a result of decisions made or actions based on this report.



1.2 Testers

Name: Chen Wen
Position: Engineer
Department: Department of RF test
Date: 2017-06-13 to 2017-06-27

Signature: 

Editor of this test report:

Name: Zhou Jin
Position: Engineer
Department: Department of RF test
Date: 2017-06-28

Signature: 

Technical responsibility for area of testing:

Name: Zhang Yan
Position: Manager
Department: Director of the laboratory
Date: 2017-06-28

Signature: 



1.3 Testing Laboratory information

1.3.1 Location

Name: Chongqing Institute of Telecommunications
Address: No. 8, Yuma Road, Chayuan New City, Nan'an District,
Chongqing
P. R. CHINA, 401336
Tel: +86-23-88069965
Fax: +86-23-88608777
Email: songweiwei@chinattl.com

1.3.2 Test location, where different from section 1.3.1

Name: -----
Street: -----
City: -----
Country: -----
Telephone: -----
Fax: -----
Postcode: -----



1.4 Details of applicant or manufacturer

1.4.1 Manufacturer

Name: Sierra Wireless Inc.
Address: 13811, Wireless Way, Richmond, British Columbia
Country: Canada
Telephone: +1 604 231 1100
Fax: +1 604 231 1109



2 Test Item

2.1 General Information

Manufacturer: Sierra Wireless Inc.
 Type of Equipment: Wireless Modules
 Model Name: WP7601
 Serial Number: S1:U1708470300603
 Production Status: Product
 Receipt date of test item: 2016-06-13

2.2 Outline of Equipment under Test

The WP7601, referred to as “EUT” hereafter, is a wireless modem operating on the LTE networks. The table below shows the supported bands for the EUT.

Technology	Band	UL Freq.(MHz)	DL Freq.(MHz)	Note
LTE	B4	1710 – 1755	2110 – 2155	--
	B13	777 - 787	746 - 756	--

2.3 Modifications Incorporated in EUT

The EUT has not been modified from what is described by the brand name and unique type identification stated above.

2.4 Equipment Configuration

Equipment configuration list:

Item	Generic Description	Manufacturer	Type	Serial No.	Remarks
A	Modules	Sierra Wireless Inc.	WP7601	S1:U1708470300603	None

2.5 Other Information

--



3 Summary of Test Results

A brief summary of the tests carried out is shown as following.

FCC Rules	ISED Standards	Name of Test	Result
2.1046, 27.50(b)	RSS-130 4.4 RSS-139 6.5	Conducted RF Power Output	Pass
2.1049	RSS-Gen 6.6	Occupied Bandwidth	*Note 1
2.1051, 2.1053, 27.53	RSS-130 4.6 RSS-139 6.6	Conducted spurious emissions	Pass
2.1051, 2.1053, 27.53	RSS-130 4.3 RSS-139 6.4	Radiated Spurious Emission	Pass
2.1051, 2.1053, 27.53	RSS-130 4.6 RSS-139 6.6	Band Edge	Pass
2.1055, 27.54	RSS-130 4.3 RSS-139 6.4	Frequency Stability over Temperature Variation	Pass
2.1055, 27.54	RSS-130 4.3 RSS-139 6.4	Frequency Stability over Voltage Variation	Pass
27.50	RSS-130 4.4	Peak to Average Ratio	Pass
Note 1: No applicable performance criteria.			



4 Test Equipments and Ancillaries Used For Tests

The test equipments and ancillaries used are as follows.

No.	Equipment	Model	SN	Manufacture	Cal. Due Date
1	EMI Test Receiver	ESU26	100367	R&S	2018-03-03
2	Trilog super broadband test antenna	VULB 9163	9163-544	R&S	2017-12-01
3	Double-Ridged Horn Antenna	HF907	100356	R&S	2017-12-01
4	Fully-Anechoic Chamber	11.8m×6.5m×6.3m	--	ETS	2017-08-19
5	Universal Radio Communication Tester	CMW500	128181	R&S	2018-03-03
6	Signal Generator	SMU200A	104517	R&S	2018-03-03
7	spectrum analyzer	FSQ 26	201137/026	R&S	2018-03-03
8	spectrum analyzer	N9020A	MY50200376	Agilent	2018-03-03
9	Universal Radio Communication Tester	CMU200	112012	R&S	2018-03-03
10	Climate chamber	SH-241	92010759	ESPEC	2018-03-03
11	DC Power Supply	N6705B	MY50000919	Agilent	2017-12-06
12	Universal Radio Communication Tester	CMW500	152395	R&S	2018-03-03



5 Test Results

5.1 Conducted RF Power Output

Specifications:	FCC Part 2.1046, 27.50(b) RSS-130 4.4, RSS-139 6.5
DUT Serial Number:	S1: U1708470300603
Test conditions:	Ambient Temperature:15°C-35°C Relative Humidity:30%-60% Air pressure: 86-106kPa
Test Results:	Pass

Limit Level Construction:

According to Part 27.50(b), portable stations (hand-held devices) transmitting in the 746-757 MHz, 776-788 MHz, and 805-806 MHz bands are limited to 3 watts ERP.

According to Part 27.50(d), fixed, mobile, and portable (hand-held) stations operating in the 1710-1755 MHz band and mobile and portable stations operating in the 1695-1710 MHz and 1755-1780 MHz bands are limited to 1 watt EIRP.

According to RSS-130 4.4, the e.i.r.p. shall not exceed 50 watts for mobile equipment or for outdoor fixed subscriber equipment, nor shall it exceed 5 watts for portable equipment or for indoor fixed subscriber equipment.

According to RSS-139 6.5, the equivalent isotropically radiated power (e.i.r.p.) for mobile and portable transmitters shall not exceed one watt. The e.i.r.p. for fixed and base stations in the band 1710-1780 MHz shall not exceed one watt.

Test Setup:

During the test, the EUT was controlled via the Wireless Telecommunications Test Set to ensure max power transmission and proper modulation and measured by spectrum analyzer.

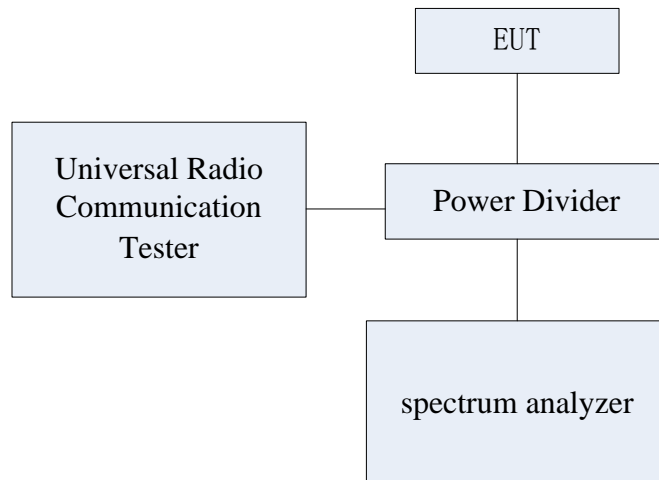



Test Method:

- 1) The EUT was coupled to the spectrum analyzer and the Wireless Telecommunications Test Set through a power divider. The loss of the RF cables of the test system is calibrated to correct the readings.
- 2) For RMS power test, the spectrum analyzer was set to RMS Detector function and Maximum hold mode.
- 3) For Peak power test, the spectrum analyzer was set to Maxpeak Detector function and Maximum hold mode.
- 4) The resolution bandwidth of the spectrum analyzer was comparable to the emission bandwidth.

Note: --



5.1.1 LTE B4 Conducted RF Power Output Results

Test Data (1.4MHz bandwidth Mode)

Channel	Frequency (MHz)	No.RB	RB START	Modulation	Max Power(RMS) (dBm)	Max Power (PK) (dBm)	PAR
19957	1710.7	1	0	QPSK	22.85	27.64	4.79
		1	2		23.28	27.92	4.64
		1	5		23.02	27.79	4.77
		6	0		22.05	27.51	5.46
		1	0	16QAM	21.99	27.58	5.59
		1	2		22.53	27.98	5.45
		1	5		22.10	27.72	5.62
		6	0		21.08	27.64	6.56
20175	1732.5	1	0	QPSK	23.13	27.76	4.63
		1	2		23.15	27.72	4.57
		1	5		23.13	27.82	4.69
		6	0		22.07	27.60	5.53
		1	0	16QAM	22.09	27.65	5.56
		1	2		22.37	27.88	5.51
		1	5		22.08	27.72	5.64
		6	0		21.00	27.39	6.39
20393	1754.3	1	0	QPSK	23.02	27.07	4.05
		1	2		23.11	27.10	3.99
		1	5		22.89	27.08	4.19
		6	0		22.06	27.10	5.04
		1	0	16QAM	22.31	26.88	4.57
		1	2		22.63	27.09	4.46
		1	5		22.53	27.22	4.69
		6	0		21.28	27.11	5.83



Test Data (3MHz bandwidth Mode)

Channel	Frequency (MHz)	No.RB	RB START	Modulation	Max Power(RMS) (dBm)	Max Power (PK) (dBm)	PAR
19965	1711.5	1	0	QPSK	23.10	27.81	4.71
		1	8		22.97	27.67	4.70
		1	15		23.08	27.78	4.70
		15	0		22.09	27.48	5.39
		1	0	16QAM	22.21	27.38	5.17
		1	8		22.31	27.27	4.96
		1	15		22.44	27.61	5.17
		15	0		21.08	27.45	6.37
20175	1732.5	1	0	QPSK	22.88	27.52	4.64
		1	8		22.93	27.47	4.54
		1	15		22.99	27.73	4.74
		15	0		22.03	27.76	5.73
		1	0	16QAM	21.61	27.17	5.56
		1	8		21.46	26.92	5.46
		1	15		21.65	27.35	5.70
		15	0		20.96	27.39	6.43
20385	1753.5	1	0	QPSK	22.76	26.87	4.11
		1	8		22.88	26.90	4.02
		1	15		23.11	27.34	4.23
		15	0		22.13	27.40	5.27
		1	0	16QAM	22.08	26.76	4.68
		1	8		22.09	26.66	4.57
		1	15		22.17	27.00	4.83
		15	0		21.08	27.10	6.02



Test Data (5MHz bandwidth Mode)

Channel	Frequency (MHz)	No.RB	RB START	Modulation	Max Power(RMS) (dBm)	Max Power (PK) (dBm)	PAR
19975	1712.5	1	0	QPSK	22.90	27.59	4.69
		1	13		23.15	27.71	4.56
		1	24		23.05	27.49	4.44
		25	0		21.93	27.79	5.86
		1	0	16QAM	22.47	27.84	5.37
		1	13		22.56	27.84	5.28
		1	24		22.34	27.52	5.18
		25	0		20.94	27.58	6.64
20175	1732.5	1	0	QPSK	22.99	27.62	4.63
		1	13		23.05	27.56	4.51
		1	24		23.05	27.83	4.78
		25	0		21.95	27.72	5.77
		1	0	16QAM	21.04	26.74	5.70
		1	13		21.30	26.90	5.60
		1	24		21.63	27.38	5.75
		25	0		20.84	27.44	6.60
20375	1752.5	1	0	QPSK	22.99	26.96	3.97
		1	13		23.09	26.96	3.87
		1	24		23.20	27.39	4.19
		25	0		22.14	27.39	5.25
		1	0	16QAM	21.55	26.39	4.84
		1	13		21.54	26.44	4.90
		1	24		21.79	26.92	5.13
		25	0		21.24	27.34	6.10



Test Data (10MHz bandwidth Mode)

Channel	Frequency (MHz)	No.RB	RB START	Modulation	Max Power(RMS) (dBm)	Max Power (PK) (dBm)	PAR
20000	1715	1	0	QPSK	22.96	27.69	4.73
		1	25		23.19	27.43	4.24
		1	49		22.98	27.02	4.04
		50	0		22.05	27.73	5.68
		16QAM	1	0	22.38	27.68	5.30
			1	25	22.49	27.29	4.80
			1	49	22.54	27.02	4.48
			50	0	21.17	27.18	6.01
20175	1732.5	1	0	QPSK	22.90	27.40	4.50
		1	25		23.32	27.82	4.50
		1	49		23.19	27.97	4.78
		50	0		21.91	27.33	5.42
		16QAM	1	0	21.45	26.96	5.51
			1	25	21.50	27.07	5.57
			1	49	21.60	27.41	5.81
			50	0	20.91	27.65	6.74
20350	1750	1	0	QPSK	23.12	27.03	3.91
		1	25		23.00	26.77	3.77
		1	49		23.26	27.41	4.15
		50	0		22.00	27.21	5.21
		16QAM	1	0	22.45	27.00	4.55
			1	25	22.07	26.55	4.48
			1	49	22.22	27.00	4.78
			50	0	21.11	27.02	5.91



Test Data (15MHz bandwidth Mode)

Channel	Frequency (MHz)	No.RB	RB START	Modulation	Max Power(RMS) (dBm)	Max Power (PK) (dBm)	PAR
20025	1717.5	1	0	QPSK	23.16	27.85	4.69
		1	38		22.74	26.96	4.22
		1	74		22.89	27.08	4.19
		75	0		21.87	27.10	5.23
		1	0	16QAM	22.46	27.70	5.24
		1	38		22.20	22.68	0.48
		1	74		22.29	27.00	4.71
		75	0		20.94	27.10	6.16
20175	1732.5	1	0	QPSK	22.74	27.04	4.30
		1	38		22.76	27.18	4.42
		1	74		22.76	27.31	4.55
		75	0		21.80	27.73	5.93
		1	0	16QAM	21.06	26.10	5.04
		1	38		21.88	27.04	5.16
		1	74		21.77	27.10	5.33
		75	0		20.91	27.63	6.72
20325	1747.5	1	0	QPSK	23.09	27.69	4.60
		1	38		22.90	26.79	3.89
		1	74		23.28	27.36	4.08
		75	0		21.90	27.27	5.37
		1	0	16QAM	22.58	27.67	5.09
		1	38		21.71	26.32	4.61
		1	74		21.83	26.69	4.86
		75	0		21.01	27.11	6.10



Test Data (20MHz bandwidth Mode)

Channel	Frequency (MHz)	No.RB	RB START	Modulation	Max Power(RMS) (dBm)	Max Power (PK) (dBm)	PAR
20050	1720	1	0	QPSK	23.34	28.11	4.77
		1	50		23.16	27.11	3.95
		1	99		23.00	27.56	4.56
		100	0		21.99	27.83	5.84
		16QAM	1	0	21.82	27.31	5.49
			1	50	21.84	26.60	4.76
			1	99	21.82	27.21	5.39
			100	0	20.97	27.29	6.32
20175	1732.5	1	0	QPSK	22.80	27.00	4.20
		1	50		23.20	27.80	4.60
		1	99		23.23	27.69	4.46
		100	0		21.91	28.02	6.11
		16QAM	1	0	22.61	27.21	4.60
			1	50	23.11	28.04	4.93
			1	99	22.93	27.82	4.89
			100	0	20.93	27.61	6.68
20300	1745	1	0	QPSK	23.04	27.91	4.87
		1	50		23.26	27.09	3.83
		1	99		23.14	27.26	4.12
		100	0		21.93	27.21	5.28
		16QAM	1	0	22.75	28.27	5.52
			1	50	22.70	27.21	4.51
			1	99	22.74	27.41	4.67
			100	0	20.88	27.18	6.30



5.1.2 LTE B13 Conducted RF Power Output Results

Test Data (5MHz bandwidth Mode)

Channel	Frequency (MHz)	No.RB	RB START	Modulation	Max Power(RMS) (dBm)	Max Power (PK) (dBm)	PAR
23205	779.5	1	0	QPSK	23.43	26.64	3.21
		1	13		23.32	27.15	3.83
		1	24		23.50	26.95	3.45
		25	0		22.57	27.59	5.02
		1	0	16QAM	22.17	26.40	4.23
		1	13		21.86	26.84	4.98
		1	24		22.05	26.65	4.60
		25	0		21.47	27.30	5.83
23230	782	1	0	QPSK	23.29	27.16	3.87
		1	13		23.63	26.98	3.35
		1	24		23.59	27.41	3.82
		25	0		22.51	27.58	5.07
		1	0	16QAM	22.03	26.98	4.95
		1	13		22.28	26.73	4.45
		1	24		22.35	27.19	4.84
		25	0		21.67	27.53	5.86
23255	784.5	1	0	QPSK	23.71	27.06	3.35
		1	13		23.83	27.49	3.66
		1	24		23.41	27.41	4.00
		25	0		22.57	27.92	5.35
		1	0	16QAM	22.92	27.03	4.11
		1	13		23.03	27.45	4.42
		1	24		22.94	27.48	4.54
		25	0		21.42	27.64	6.22



Test Data (10MHz bandwidth Mode)

Channel	Frequency (MHz)	No.RB	RB START	Modulation	Max Power(RMS) (dBm)	Max Power (PK) (dBm)	PAR
23230	782	1	0	QPSK	23.39	26.88	3.49
		1	25		23.71	27.06	3.35
		1	49		23.44	27.43	3.99
		50	0		22.51	27.87	5.36
		1	0	16QAM	22.58	26.74	4.16
		1	25		23.03	26.99	3.96
		1	49		22.47	27.17	4.70
		50	0		21.39	27.53	6.14



5.2 Occupied bandwidth

Specifications:	FCC Part 2.1049 RSS-Gen 6.6
DUT Serial Number:	S1: U1708470300603
Test conditions:	Ambient Temperature:15°C-35°C Relative Humidity:30%-60% Air pressure: 86-106kPa
Test Results:	--

Test Setup

During the test, the EUT was controlled via the Wireless Communications Test Set to ensure max power transmission and proper modulation and measured by spectrum analyzer.

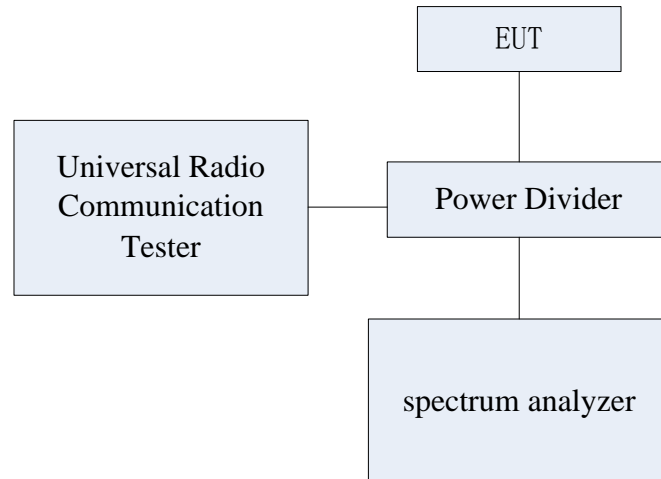

Test Method

The 99% occupied bandwidth was calculated from the spectrum analyzer. Markers in the spectrum analyzer were then placed between the calculated frequencies to show the calculated 99% power band. The -26dB bandwidth was also measured and recorded.

Note: --



5.2.1 LTE B4 occupied bandwidth Results

Mode	EUT channel No.	bandwidth	No. RB	RB offset	99% occupied bandwidth [MHz]	-26dBc occupied bandwidth [MHz]
QPSK	20175 (1732.5MHz)	1.4MHz	6	0	1.08	1.22
		3MHz	15		2.68	2.87
		5MHz	25		4.49	4.97
		10MHz	50		8.94	9.62
		15MHz	75		13.49	14.74
20MHz		100	17.93		19.18	
16QAM		1.4MHz	6		1.08	1.27
		3MHz	15		2.68	2.90
		5MHz	25		4.47	4.82
		10MHz	50		8.94	9.59
	15MHz	75	13.47	14.33		
	20MHz	100	17.94	18.93		

5.2.2 LTE B13 occupied bandwidth Results

Mode	EUT channel No.	bandwidth	No. RB	RB offset	99% occupied bandwidth [MHz]	-26dBc occupied bandwidth [MHz]
QPSK	23230 (782MHz)	5MHz	25	0	4.48	4.86
		10MHz	50		8.91	9.56
16QAM		5MHz	25		4.46	4.79
		10MHz	50		8.92	9.54



Graphical results for LTE B4:

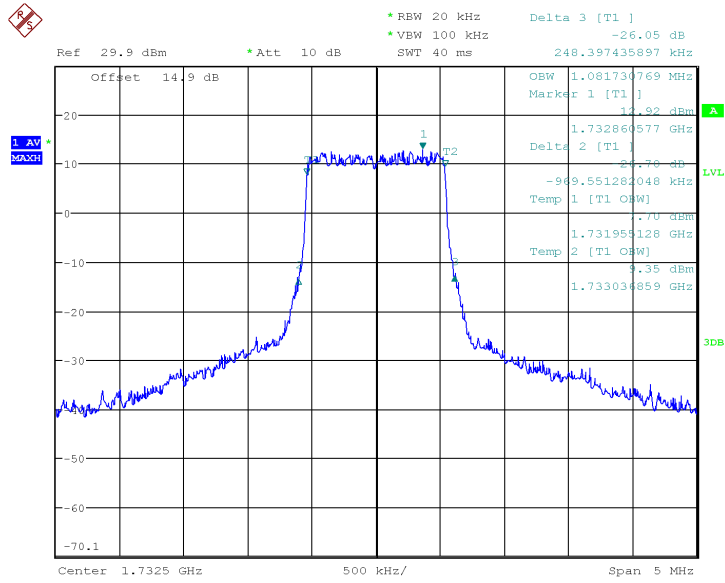

Date: 20.JUN.2017 11:17:26

LTE Band4 QPSK Channel 20175 BW=1.4MHz RB=6 RB Offset=0

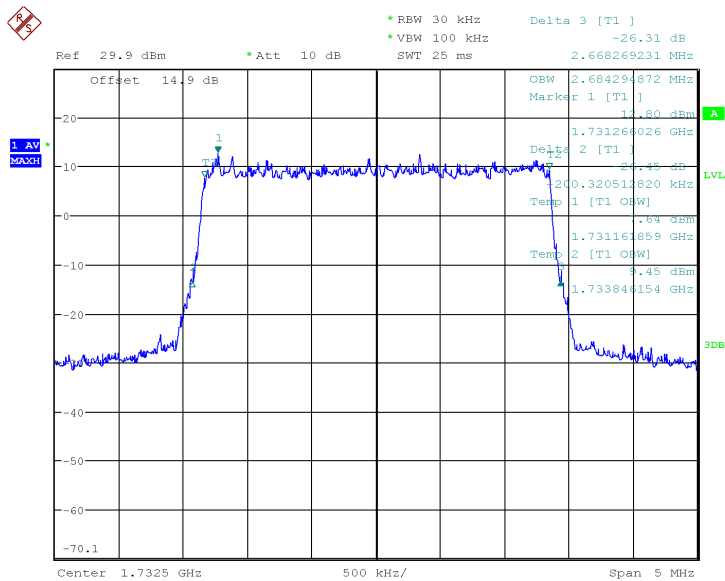

Date: 20.JUN.2017 11:19:52

LTE Band4 QPSK Channel 20175 BW=3MHz RB=15 RB Offset=0

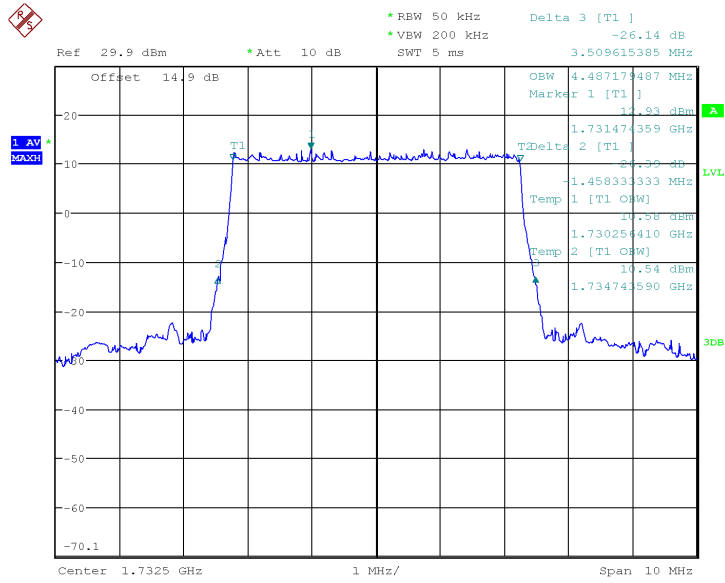

Date: 20.JUN.2017 11:22:07

LTE Band4 QPSK Channel 20175 BW=5MHz RB=25 RB Offset=0

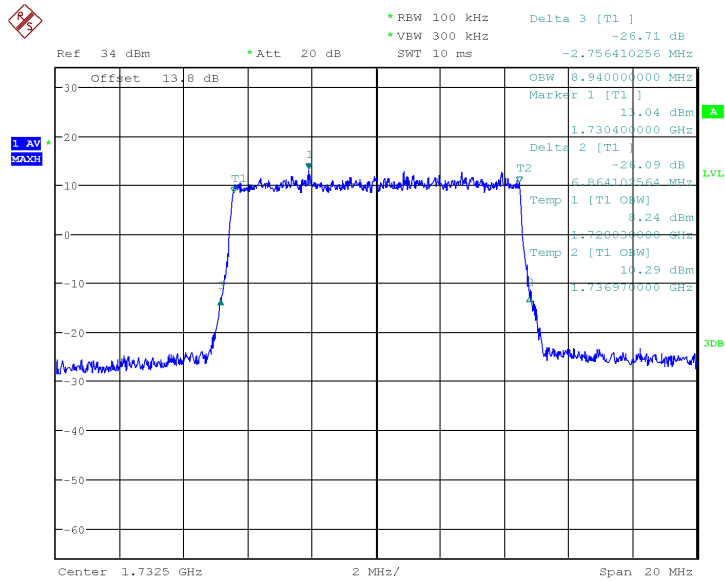

Date: 26.JUN.2017 17:21:29

LTE Band4 QPSK Channel 20175 BW=10MHz RB=50 RB Offset=0

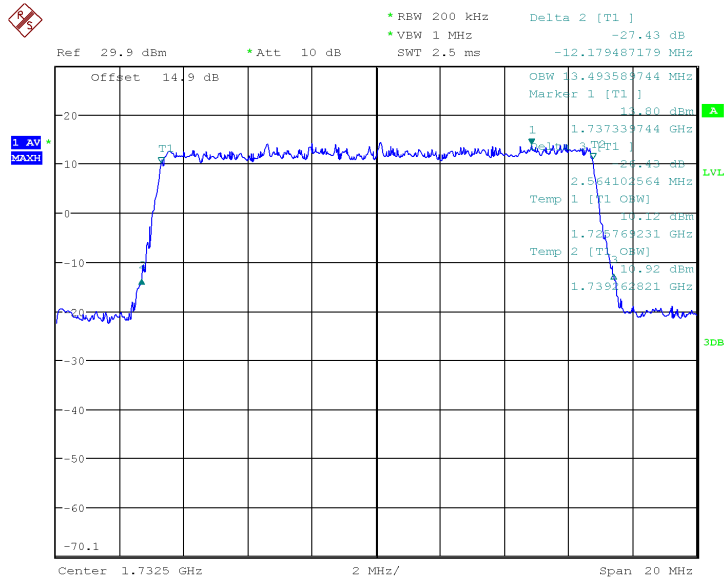

Date: 20.JUN.2017 11:26:19

LTE Band4 QPSK Channel 20175 BW=15MHz RB=75 RB Offset=0

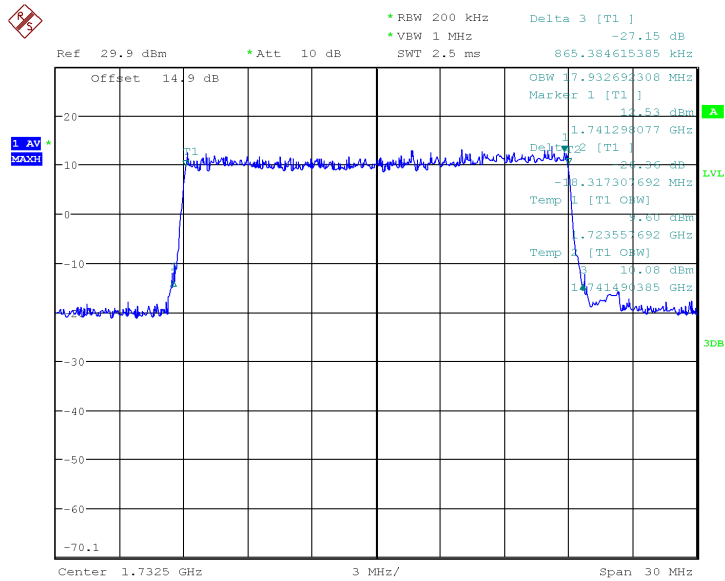

Date: 20.JUN.2017 11:27:46

LTE Band4 QPSK Channel 20175 BW=20MHz RB=100 RB Offset=0

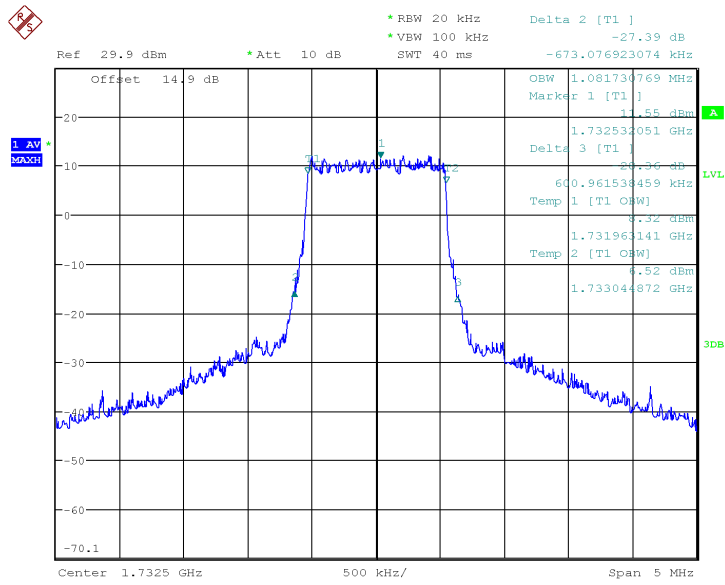

Date: 20.JUN.2017 11:30:24

LTE Band4 16QAM Channel 20175 BW=1.4MHz RB=6 RB Offset=0

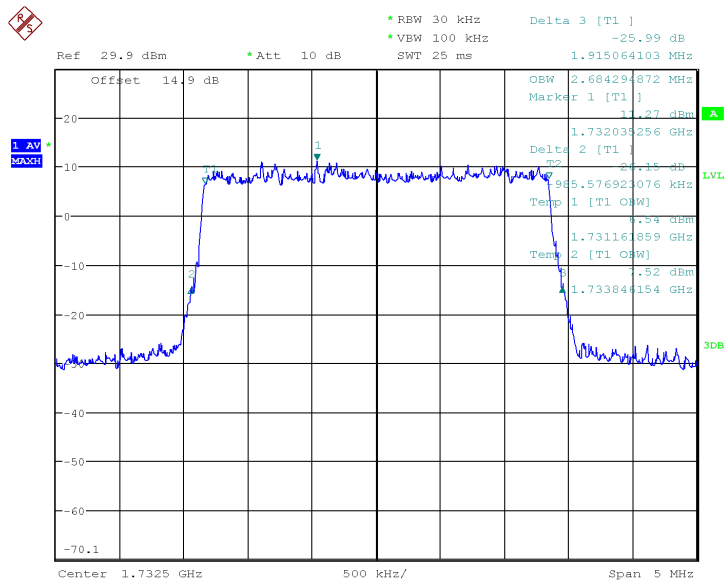

Date: 20.JUN.2017 11:31:47

LTE Band4 16QAM Channel 20175 BW=3MHz RB=15 RB Offset=0

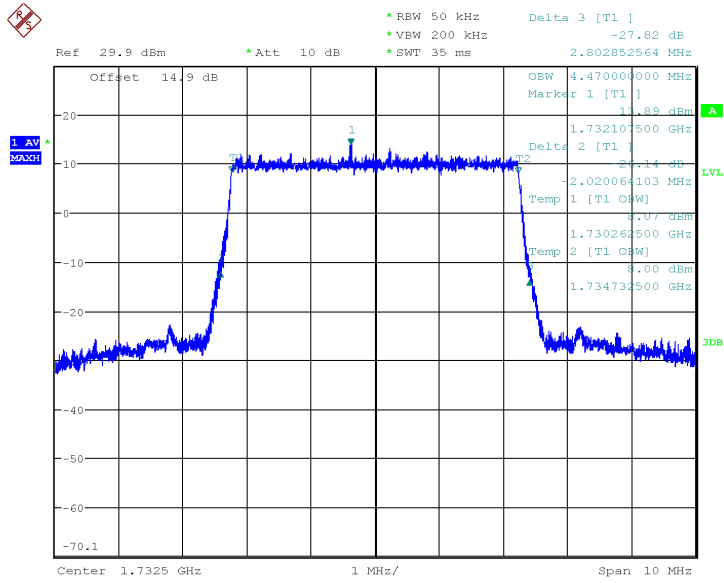

Date: 20.JUN.2017 11:34:28

LTE Band4 16QAM Channel 20175 BW=5MHz RB=25 RB Offset=0

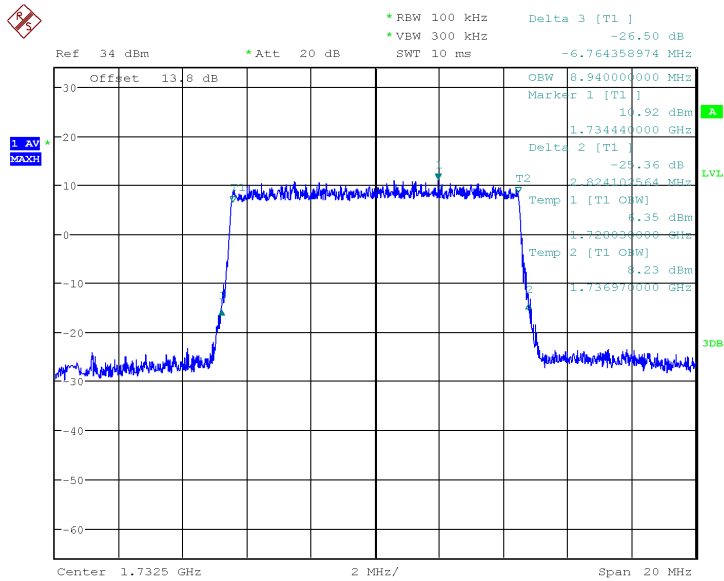

Date: 26.JUN.2017 17:23:09

LTE Band4 16QAM Channel 20175 BW=10MHz RB=50 RB Offset=0

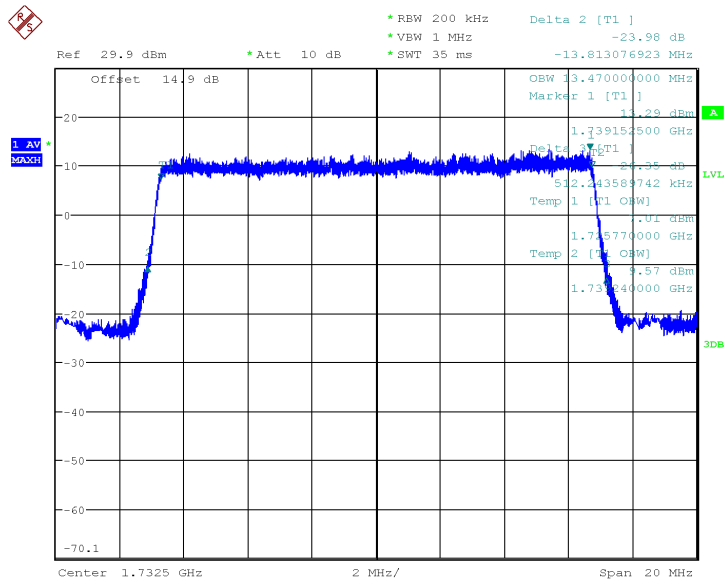

Date: 20.JUN.2017 11:36:56

LTE Band4 16QAM Channel 20175 BW=15MHz RB=75 RB Offset=0

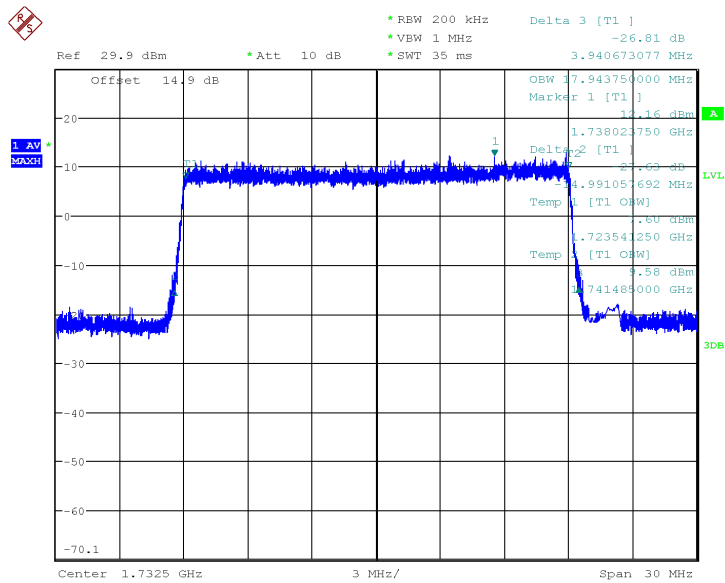

Date: 20.JUN.2017 11:37:58

LTE Band4 16QAM Channel 20175 BW=20MHz RB=100 RB Offset=0



Graphical results for LTE B13:

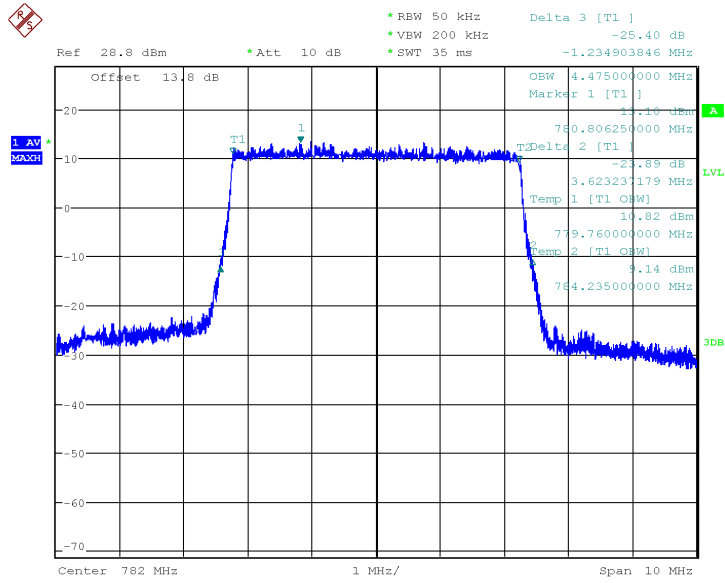

Date: 20.JUN.2017 11:42:42

LTE Band13 QPSK Channel 23230 BW=5MHz RB=25 RB Offset=0

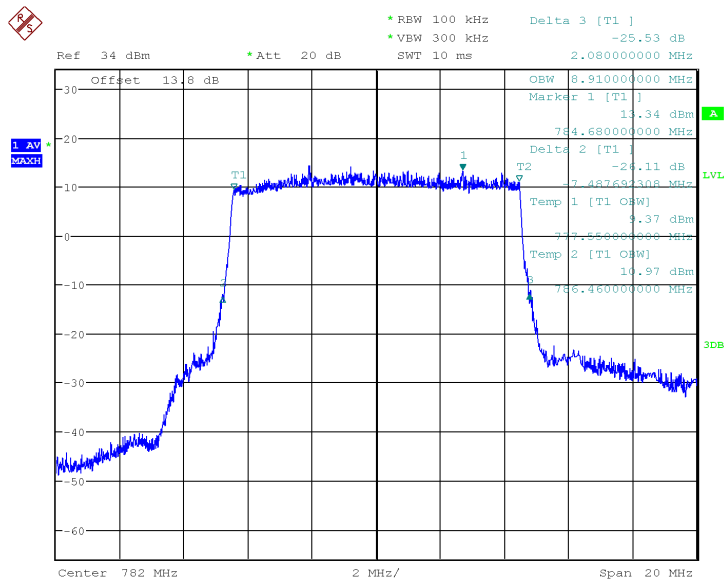

Date: 26.JUN.2017 17:25:48

LTE Band13 QPSK Channel 23230 BW=10MHz RB=50 RB Offset=0

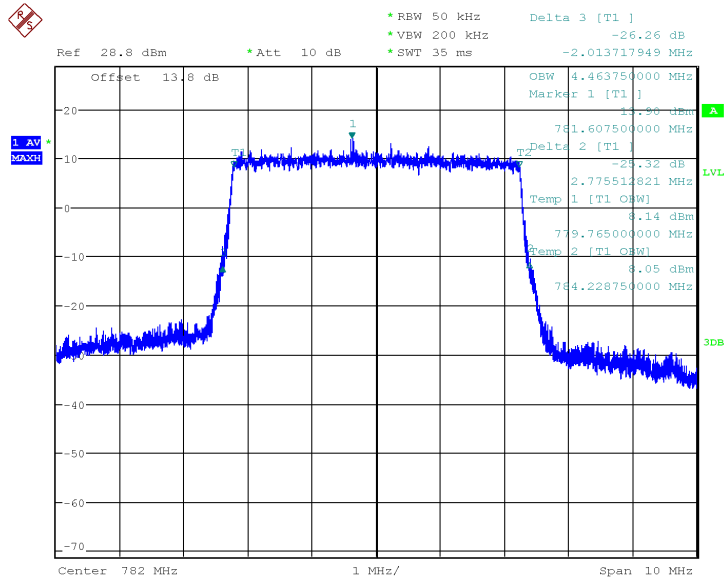

Date: 20.JUN.2017 11:43:46

LTE Band13 16QAM Channel 23230 BW=5MHz RB=25 RB Offset=0

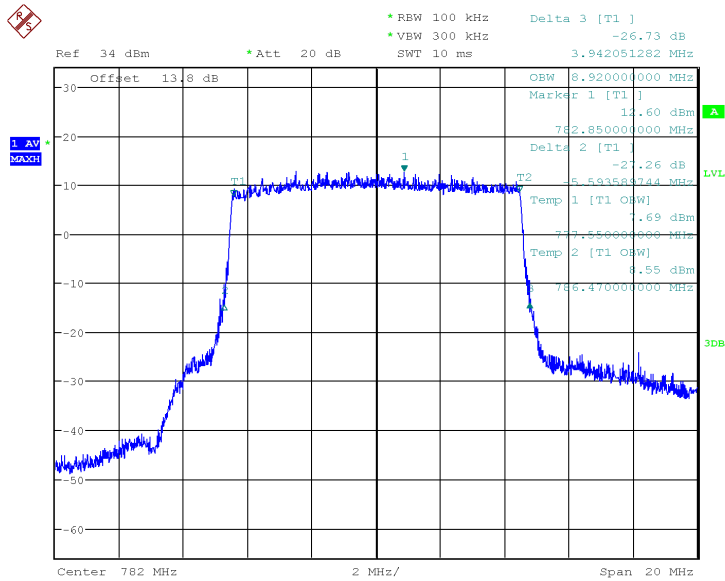

Date: 26.JUN.2017 17:24:53

LTE Band13 16QAM Channel 23230 BW=10MHz RB=50 RB Offset=0



5.3 Conducted Spurious Emission

Specifications:	FCC Part 2.1051, 2.1053, 27.53 RSS-130 4.6, RSS-139 6.6
DUT Serial Number:	S1: U1708470300603
Test conditions:	Ambient Temperature:15°C-35°C Relative Humidity:30%-60% Air pressure: 86-106kPa
Test Results:	--

Limit Level Construction:

According to Part 27.53(c):

For operations in the 746-758 MHz band and the 776-788 MHz band, on any frequency outside the 776-788 MHz band, the power of any emission shall be attenuated outside the band below the transmitter power (P) by at least $43 + 10 \log(P)$ dB;

According to Part 27.53(h):

Except as otherwise specified below, for operations in the 1695-1710 MHz, 1710-1755 MHz, 1755-1780 MHz, 1915-1920 MHz, 1995-2000 MHz, 2000-2020 MHz, 2110-2155 MHz, 2155-2180 MHz, and 2180-2200 bands, the power of any emission outside a licensee's frequency block shall be attenuated below the transmitter power (P) in watts by at least $43 + 10 \log_{10}(P)$ dB.

According to RSS-130 4.6:

The power of any unwanted emissions in any 100 kHz bandwidth on any frequency outside the frequency range(s) within which the equipment is designed to operate shall be attenuated below the transmitter power, P (dBW), by at least $43 + 10 \log_{10} p$ (watts), dB. However, in the 100 kHz band immediately outside the equipment's operating frequency range, a resolution bandwidth of 30 kHz may be employed.

In addition to the limit outlined above, equipment operating in the frequency bands 746-756 MHz and 777-787 MHz shall also comply with the following restrictions:

The power of any unwanted emissions in any 6.25 kHz bandwidth for all frequencies between 763-775 MHz and 793-806 MHz shall be attenuated below the transmitter power, P (dBW), by at least:

- (i) $76 + 10 \log_{10} p$ (watts), dB, for base and fixed equipment, and
- (ii) $65 + 10 \log_{10} p$ (watts), dB, for mobile and portable equipment

According to RSS-139 6.6:

(i) In the first 1.0 MHz bands immediately outside and adjacent to the equipment's smallest operating frequency block, which can contain the equipment's occupied bandwidth, the emission power per any 1% of the emission bandwidth shall be attenuated below the transmitter output power P (in dBW) by at least $43 + 10 \log_{10} p$ (watts) dB.

(ii) After the first 1.0 MHz outside the equipment's smallest operating frequency block, which can contain the equipment's occupied bandwidth, the emission power in any 1 MHz bandwidth shall be attenuated below the transmitter output power P (in dBW) by at least $43 + 10 \log_{10} p$ (watts) dB.



Test Setup:

During the test, the EUT was controlled via the Wireless Communications Test Set to ensure max power transmission and proper modulation and measured by spectrum analyzer.

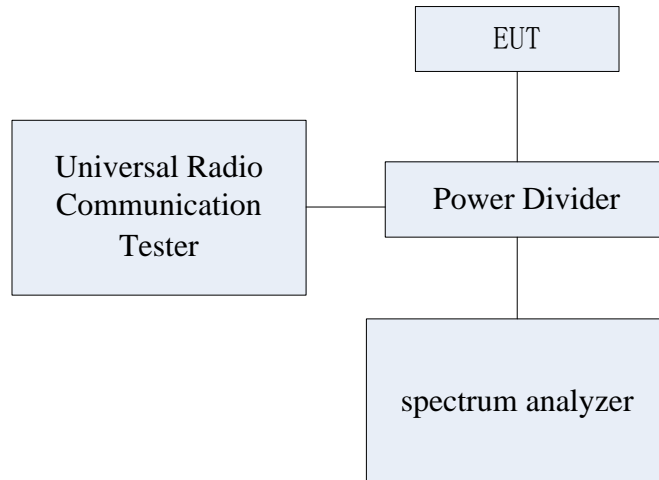

Test Method:

The measurement was performed accordance with section 2.2.13 of ANSI/TIA-603-D-2010: Land Mobile FM or PM Communications Equipment Measurement and Performance Standards.

The RF output of the transmitter was connected to a spectrum analyzer through a calibrated coaxial cable. Sufficient scans were taken to show the out-of-band emissions, if any, up to 10th harmonic. The EUT was scanned for spurious emissions from 30MHz to 20GHz with sufficient bandwidth and video resolution. The spectrum analyzer was set to Maximum hold mode to ensure that the worst-case emissions were captured.

Note: --



5.3.3 LTE B4 Conducted Spurious Emission Results

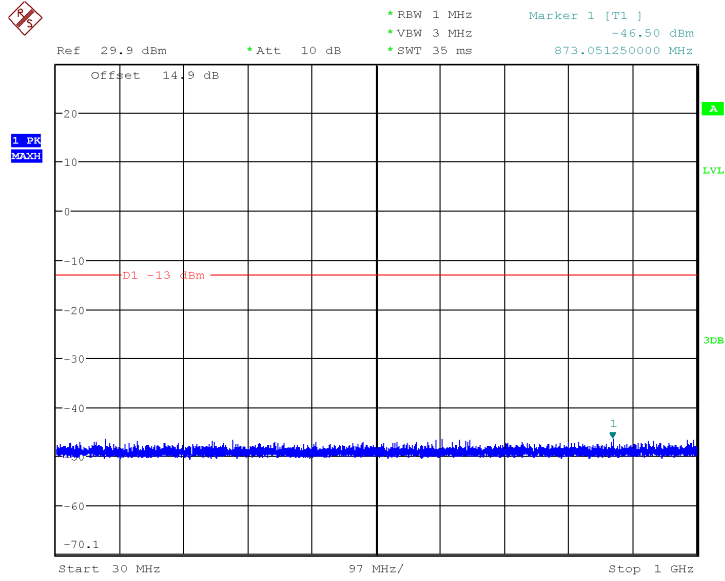

Date: 20.JUN.2017 13:01:13

1.4MHz bandwidth QPSK Mode Middle channel, 1732.5 MHz, 30MHz to 1GHz

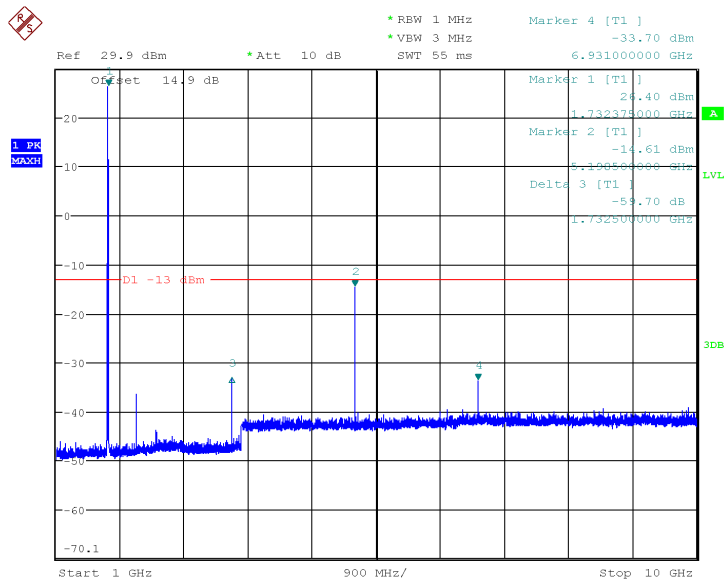

Date: 20.JUN.2017 13:06:24

1.4MHz bandwidth QPSK Middle channel, 1732.5MHz, 1GHz to 10GHz

Note: The strong emission shown in each case is the carrier signal.

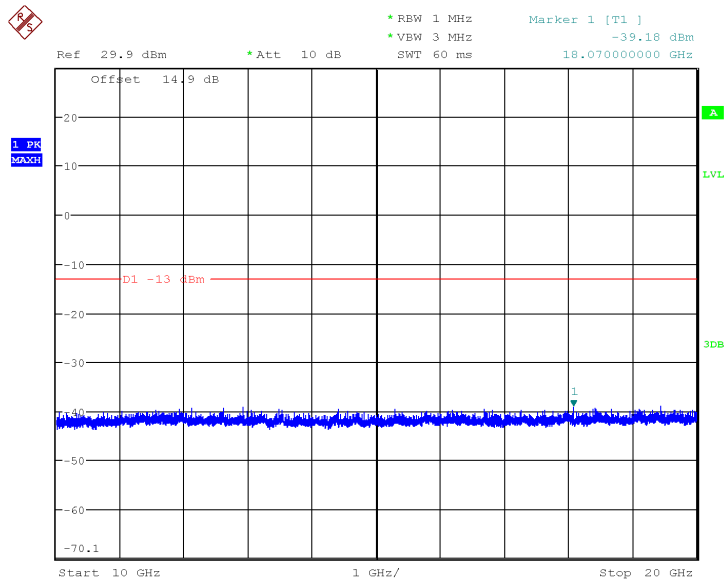

Date: 20.JUN.2017 13:12:26

1.4MHz bandwidth QPSK Middle channel, 1732.5 MHz, 10GHz to 20GHz

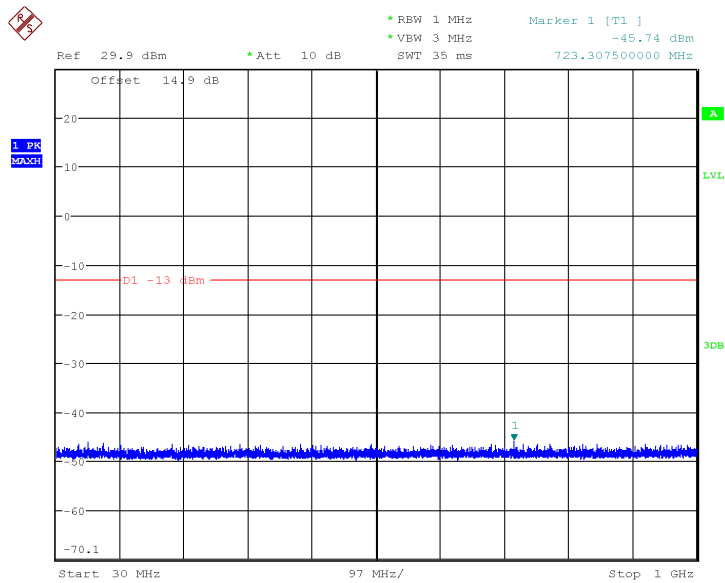

Date: 20.JUN.2017 13:15:06

3MHz bandwidth QPSK Mode Middle Channel, 1732.5 MHz, 30MHz to 1GHz

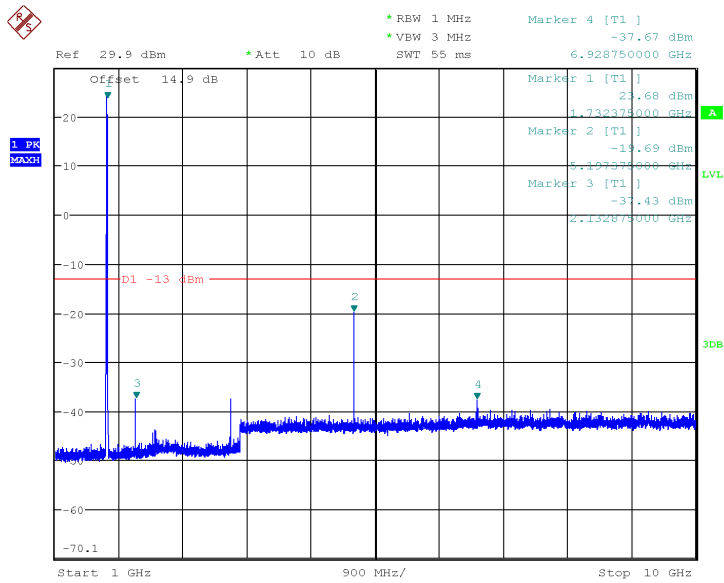

Date: 20.JUN.2017 13:15:58

3MHz bandwidth QPSK Middle Channel, 1732.5 MHz, 1GHz to 10GHz

Note: The strong emission shown in each case is the carrier signal.

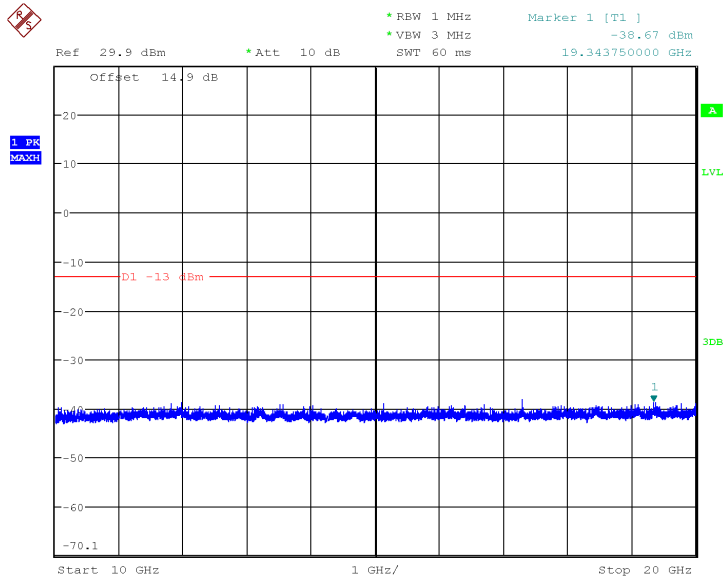

Date: 20.JUN.2017 13:17:37

3MHz bandwidth QPSK Middle Channel, 1732.5 MHz, 10GHz to 20GHz

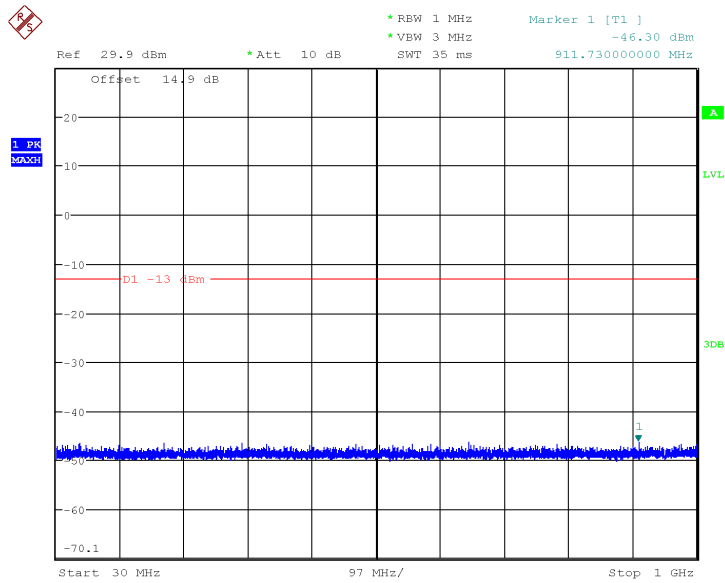

Date: 20.JUN.2017 13:21:54

5MHz bandwidth QPSK Mode Middle Channel, 1732.5 MHz,30MHz to 1GHz

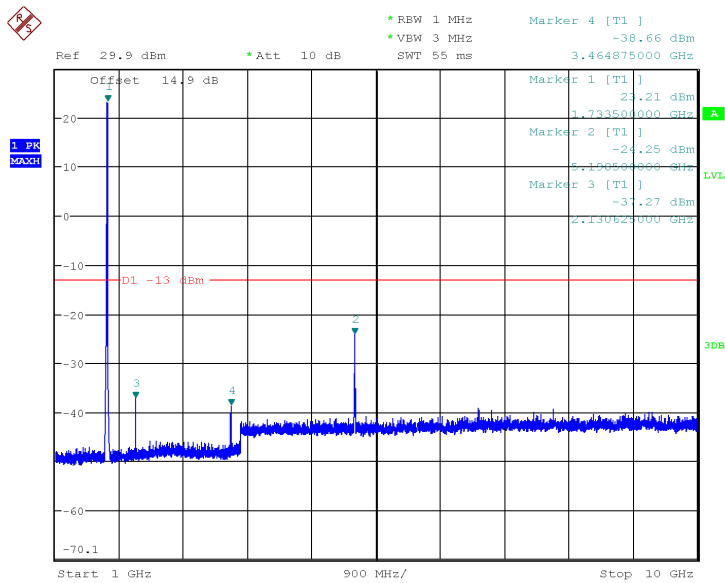

Date: 20.JUN.2017 13:22:38

5MHz bandwidth QPSK Mode Middle Channel, 1732.5 MHz,1GHz to 10GHz

Note: The strong emission shown in each case is the carrier signal.

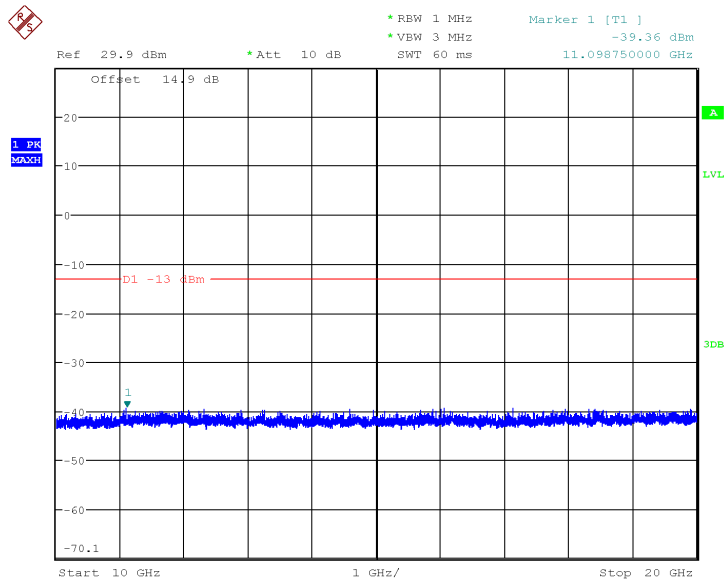

Date: 20.JUN.2017 13:24:41

5MHz bandwidth QPSK Mode Middle Channel, 1732.5 MHz, 10GHz to 20GHz

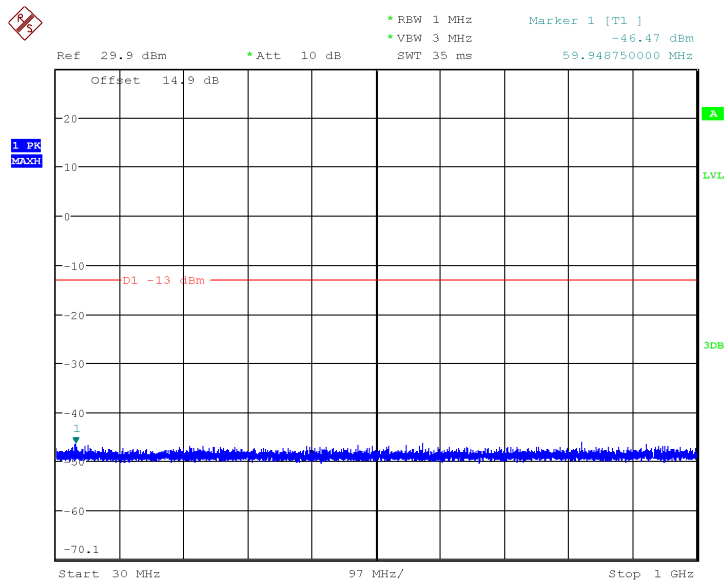

Date: 20.JUN.2017 13:26:03

10MHz bandwidth QPSK Mode Middle Channel, 1732.5 MHz, 30MHz to 1GHz

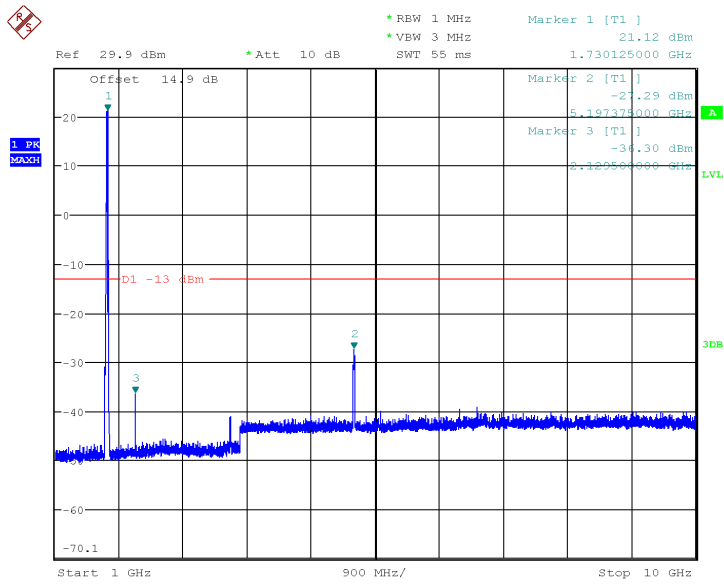

Date: 20.JUN.2017 13:27:03

10MHz bandwidth QPSK Mode Middle Channel, 1732.5 MHz, 1GHz to 10GHz

Note: The strong emission shown in each case is the carrier signal.

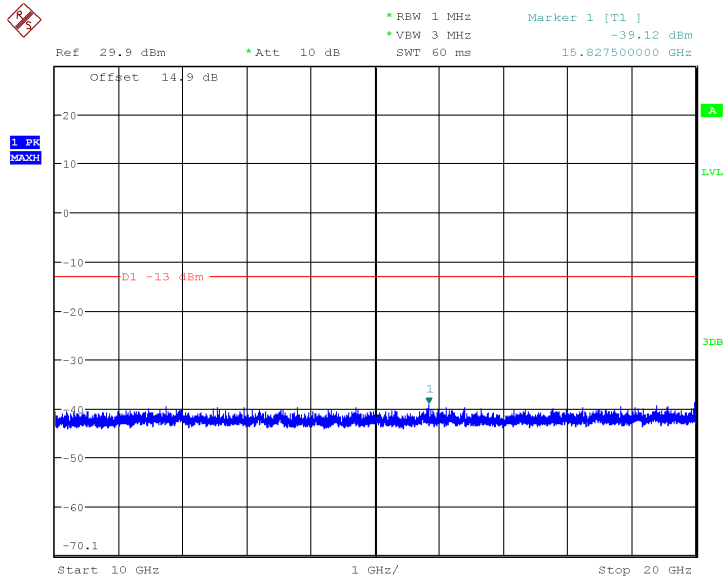

Date: 20.JUN.2017 13:27:31

10MHz bandwidth QPSK Mode Middle Channel, 1732.5 MHz, 10GHz to 20GHz

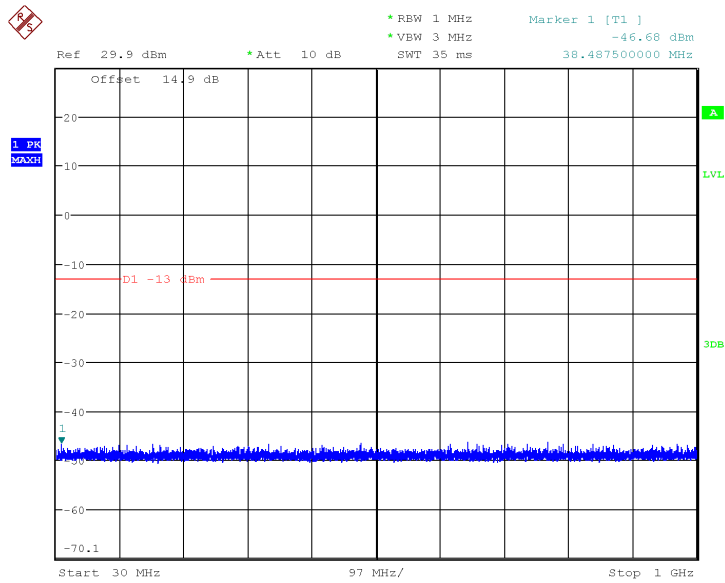

Date: 20.JUN.2017 13:28:30

15MHz bandwidth QPSK Mode Middle Channel, 1732.5 MHz, 30MHz to 1GHz

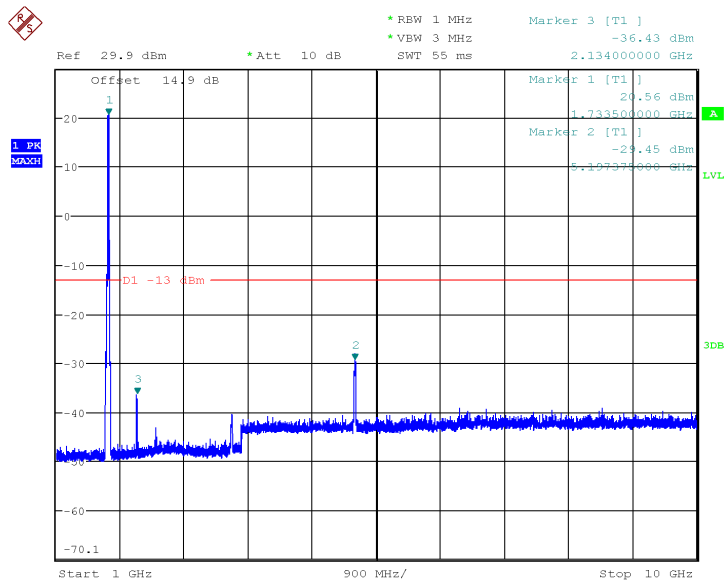

Date: 20.JUN.2017 13:40:07

15MHz bandwidth QPSK Mode Middle Channel, 1732.5 MHz, 1GHz to 10GHz

Note: The strong emission shown in each case is the carrier signal.

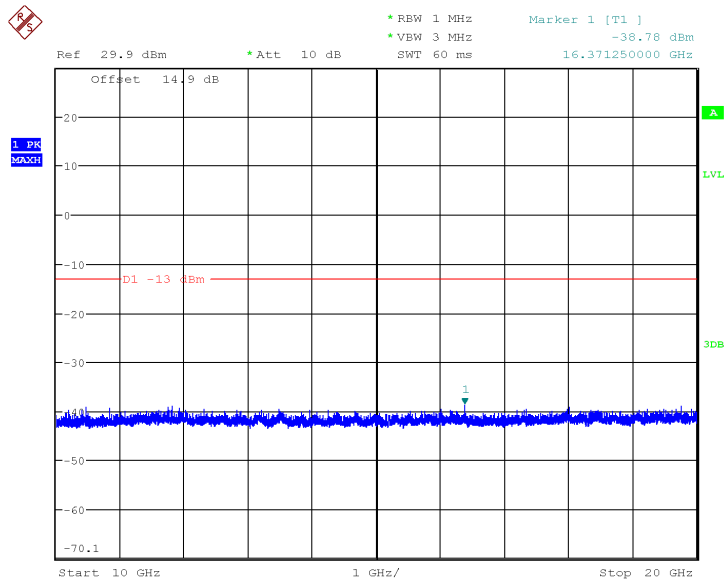

Date: 20.JUN.2017 13:29:59

15MHz bandwidth QPSK Mode Middle Channel, 1732.5 MHz, 10GHz to 20GHz

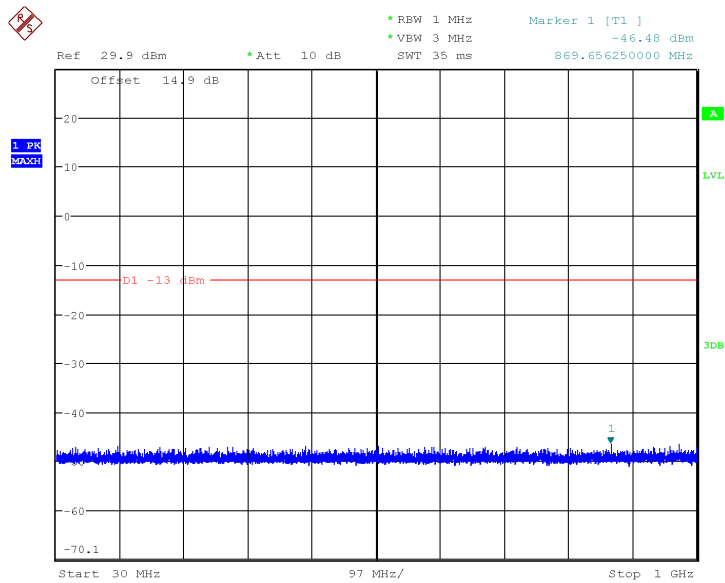

Date: 20.JUN.2017 13:33:18

20MHz bandwidth QPSK Mode Middle Channel, 1732.5 MHz, 30MHz to 1GHz

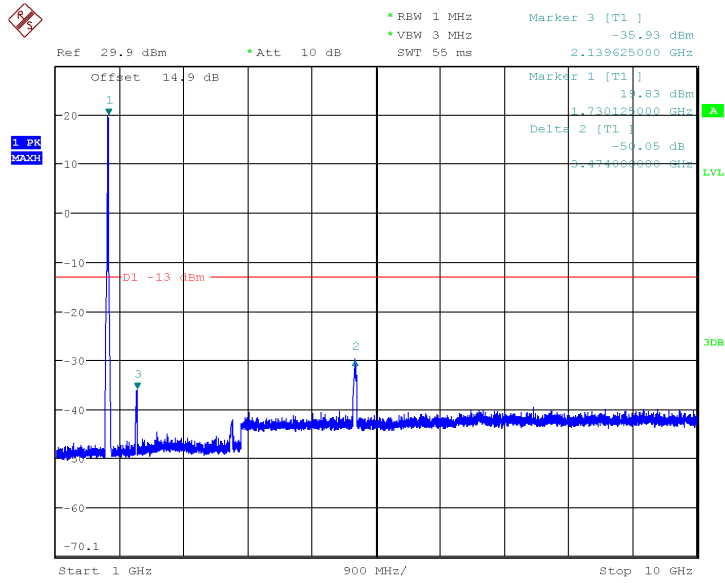

Date: 20.JUN.2017 13:34:05

20MHz bandwidth QPSK Mode Middle Channel, 1732.5 MHz, 1GHz to 10GHz

Note: The strong emission shown in each case is the carrier signal.

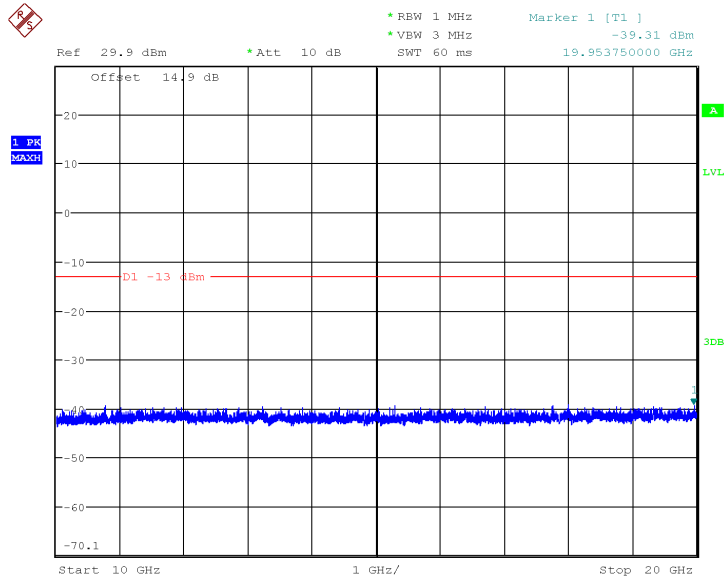

Date: 20.JUN.2017 13:34:50

20MHz bandwidth QPSK Mode Middle Channel, 1732.5 MHz, 10GHz to 20GHz



5.3.4 LTE B13 Conducted Spurious Emission Results

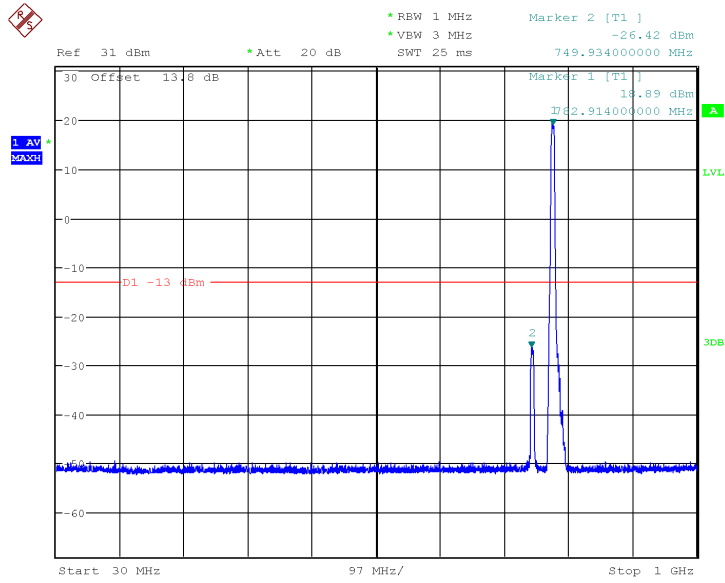

Date: 27.JUN.2017 10:48:29

5MHz bandwidth QPSK Mode Middle Channel, 782 MHz,30MHz to 1GHz

Note: The strong emission shown in each case is the carrier signal.

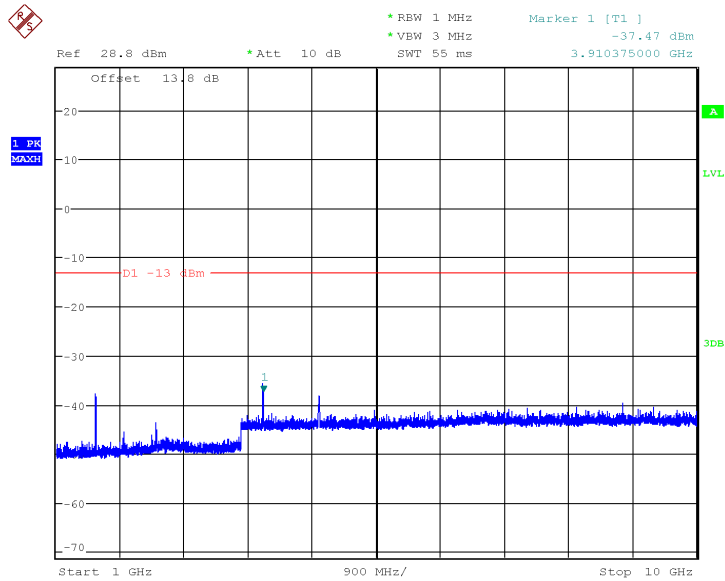

Date: 20.JUN.2017 13:48:17

5MHz bandwidth QPSK Mode Middle Channel, 782 MHz, 1GHz to 10GHz

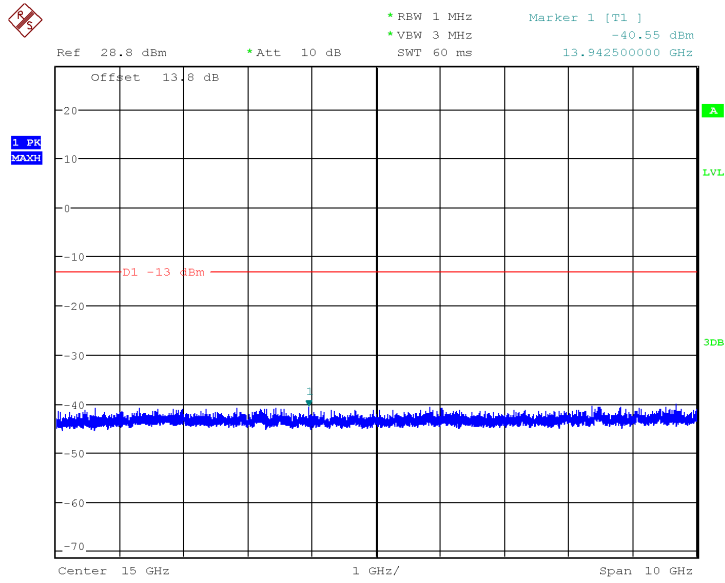

Date: 20.JUN.2017 13:48:40

5MHz bandwidth QPSK Mode Middle Channel, 782 MHz, 10GHz to 20GHz

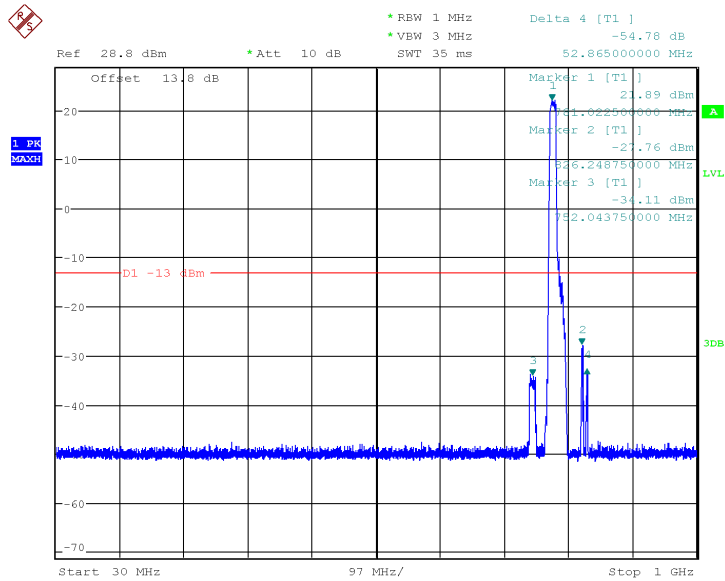

Date: 20.JUN.2017 13:49:36

10MHz bandwidth QPSK Mode Middle Channel, 782 MHz, 30MHz to 1GHz

Note: The strong emission shown in each case is the carrier signal.

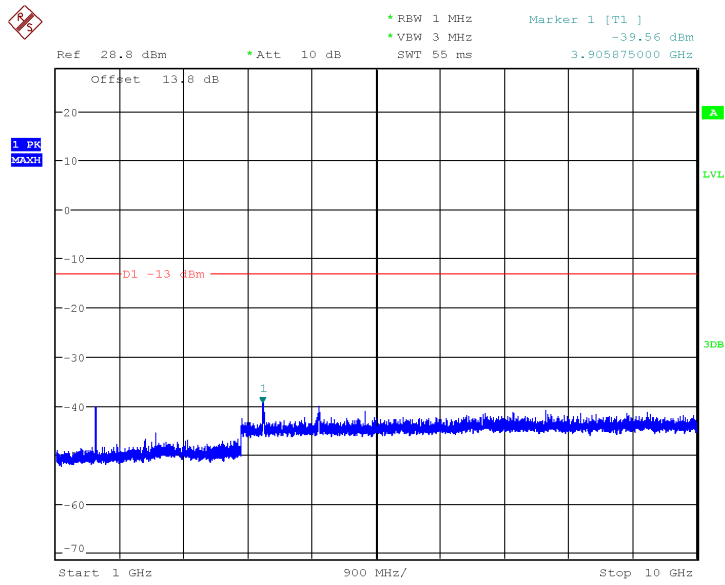

Date: 20.JUN.2017 13:50:08

10MHz bandwidth QPSK Mode Middle Channel, 782 MHz, 1GHz to 10GHz

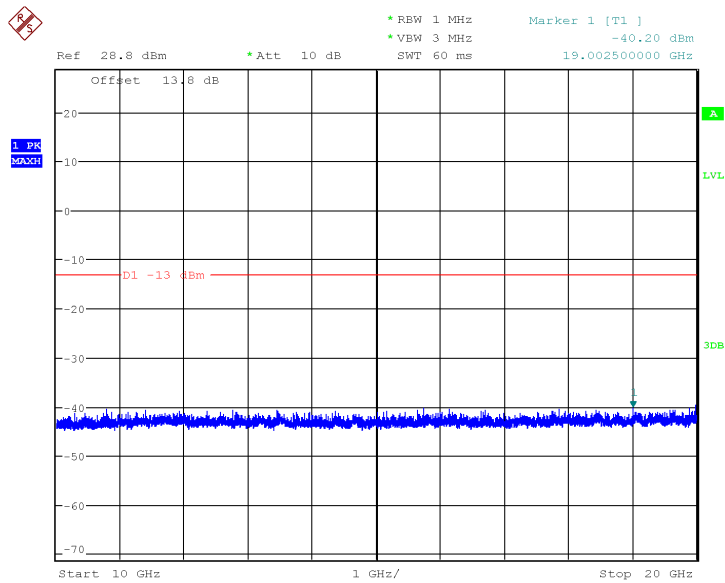

Date: 20.JUN.2017 13:50:39

10MHz bandwidth QPSK Mode Middle Channel, 782 MHz, 10GHz to 20GHz



5.4 Radiated Spurious Emission

Specifications:	FCC Part 2.1051, 2.1053, 27.53 RSS-130 4.6, RSS-139 6.6
DUT Serial Number:	S1: U1708470300603
Test conditions:	Ambient Temperature:15°C-35°C Relative Humidity:30%-60% Air pressure: 86-106kPa
Test Results:	--

Limit Level Construction:

According to Part 27.53(c):

For operations in the 746-758 MHz band and the 776-788 MHz band, on any frequency outside the 776-788 MHz band, the power of any emission shall be attenuated outside the band below the transmitter power (P) by at least $43 + 10 \log(P)$ dB;

According to Part 27.53(h):

Except as otherwise specified below, for operations in the 1695-1710 MHz, 1710-1755 MHz, 1755-1780 MHz, 1915-1920 MHz, 1995-2000 MHz, 2000-2020 MHz, 2110-2155 MHz, 2155-2180 MHz, and 2180-2200 bands, the power of any emission outside a licensee's frequency block shall be attenuated below the transmitter power (P) in watts by at least $43 + 10 \log_{10}(P)$ dB.

According to RSS-130 4.6:

The power of any unwanted emissions in any 100 kHz bandwidth on any frequency outside the frequency range(s) within which the equipment is designed to operate shall be attenuated below the transmitter power, P (dBW), by at least $43 + 10 \log_{10} p$ (watts), dB. However, in the 100 kHz band immediately outside the equipment's operating frequency range, a resolution bandwidth of 30 kHz may be employed.

In addition to the limit outlined above, equipment operating in the frequency bands 746-756 MHz and 777-787 MHz shall also comply with the following restrictions:

The power of any unwanted emissions in any 6.25 kHz bandwidth for all frequencies between 763-775 MHz and 793-806 MHz shall be attenuated below the transmitter power, P (dBW), by at least:

- (i) $76 + 10 \log_{10} p$ (watts), dB, for base and fixed equipment, and
- (ii) $65 + 10 \log_{10} p$ (watts), dB, for mobile and portable equipment

According to RSS-139 6.6:

(i) In the first 1.0 MHz bands immediately outside and adjacent to the equipment's smallest operating frequency block, which can contain the equipment's occupied bandwidth, the emission power per any 1% of the emission bandwidth shall be attenuated below the transmitter output power P (in dBW) by at least $43 + 10 \log_{10} p$ (watts) dB.

(ii) After the first 1.0 MHz outside the equipment's smallest operating frequency block, which can contain the equipment's occupied bandwidth, the emission power in any 1 MHz bandwidth shall be attenuated below the transmitter output power P (in dBW) by at least $43 + 10 \log_{10} p$ (watts) dB.

Limits for Radiated spurious emissions(UE)	
Frequency range	Limit Level /Resolution Bandwidth
30 MHz to 20000 MHz	-13dBm/1MHz

Test Setup:

The EUT was placed in an anechoic chamber. The Wireless Communications Test Set was used to set the TX channel and power level and modulate the TX signal with different bit patterns.

Test Method:

The measurement method is substitution method accordance with section 2.2.12 of ANSI/TIA-603-D: Land Mobile FM or PM Communications Equipment Measurement and Performance Standards.

(a) Connect the equipment as illustrated and measure the spurious emissions as the method as above. The distance from the device to the antenna is 3 m .

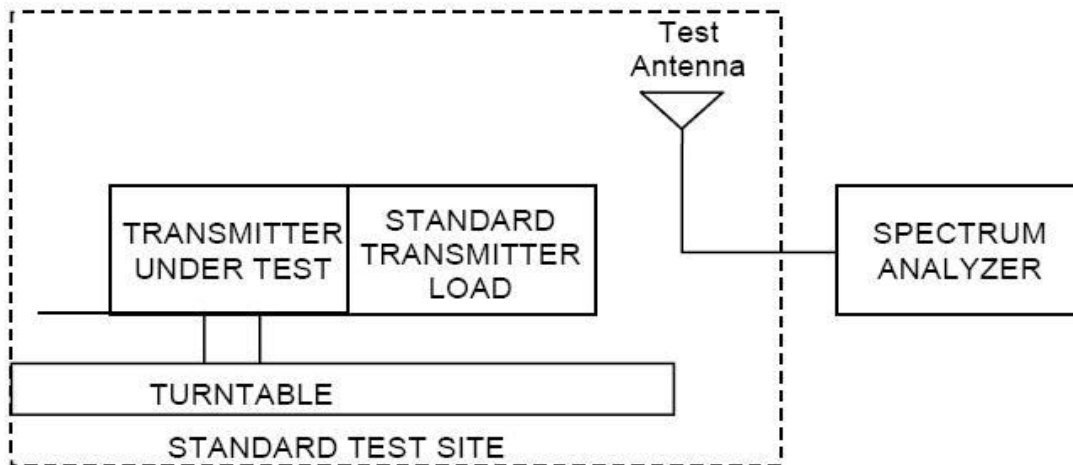

(b) Reconnect the equipment as illustrated.

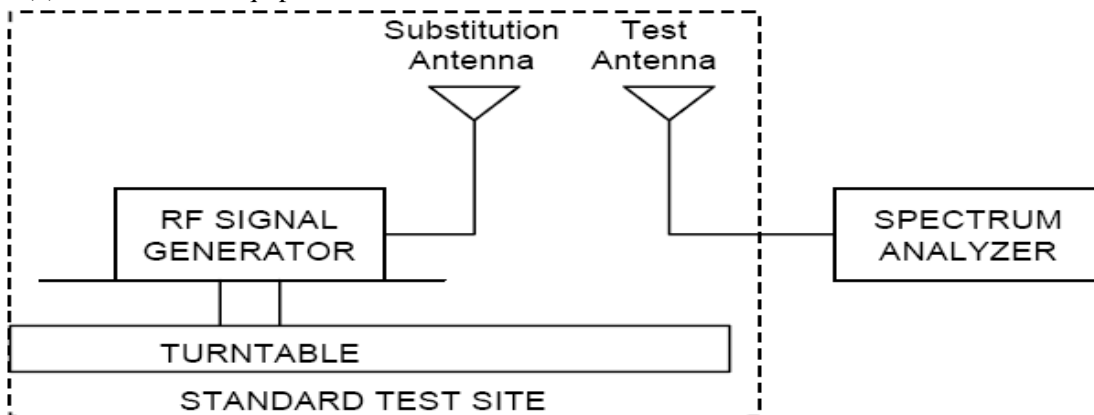

(c) Remove the transmitter and replace it with a substitution antenna. The center of the substitution antenna should be approximately at the same location as the center of the transmitter.

(d) Feed the substitution antenna at the transmitter end with a signal generator connected to the



antenna by means of a non-radiating cable. With the antennas at both ends horizontally polarized, and with the signal generator tuned to a particular spurious frequency, raise and lower the test antenna to obtain a maximum reading at the spectrum analyzer. Adjust the level of the signal generator output until the previously recorded maximum reading for this set of conditions is obtained. This should be done carefully repeating the adjustment of the test antenna and generator output.

(e) Repeat step d) with both antennas vertically polarized for each spurious frequency.

(f) Calculate power in dBm into a reference ideal half-wave dipole antenna by reducing the readings obtained in steps d) and e) by the power loss in the cable between the generator and the antenna, and further corrected for the gain of the substitution antenna used relative to an ideal half-wave dipole antenna by the following formula:

$$P_d(\text{dBm}) = P_g(\text{dBm}) - \text{cable loss (dB)} + \text{antenna gain (dB)}$$

where:

P_d is the dipole equivalent power and

P_g is the generator output power into the substitution antenna.

5.4.1 LTE B4 Radiated Spurious Emission Results

Test Data (1.4MHz bandwidth QPSK Mode)

Frequency [MHz]	Generator output power(P_g) [dBm]	Cable loss [dB]	Antenna Gain [dB]	Spurious Emission Power (P_d) [dBm]	Antenna Polarization [H/V]
3465.00	-51.76	6.9	12.6	-57.46	V
5197.50	-51.02	5.8	12.7	-57.92	V
6930.00	-48.65	0.9	11.7	-59.45	V
8662.50	-50.92	1.1	11.9	-61.72	V
10395.00	-51.48	0.8	12.1	-62.78	V
3465.00	-51.80	6.9	12.6	-57.50	H
5197.50	-52.17	5.8	12.7	-59.07	H
6930.00	-48.83	0.9	11.7	-59.63	H
8662.50	-50.72	1.1	11.9	-61.52	H
10395.00	-49.68	0.8	12.1	-60.98	H

**Test Data (1.4MHz bandwidth 16QAM Mode)**

Frequency [MHz]	Generator output power(Pg) [dBm]	Cable loss [dB]	Antenna Gain [dB]	Spurious Emission Power (Pd) [dBm]	Antenna Polarization [H/V]
3465.00	-54.21	6.9	12.6	-59.91	V
5197.50	-53.90	5.8	12.7	-60.80	V
6930.00	-46.20	0.9	11.7	-57.00	V
8662.50	-51.96	1.1	11.9	-62.76	V
10395.00	-46.95	0.8	12.1	-58.25	V
3465.00	-56.34	6.9	12.6	-62.04	H
5197.50	-54.54	5.8	12.7	-61.44	H
6930.00	-49.09	0.9	11.7	-59.89	H
8662.50	-49.85	1.1	11.9	-60.65	H
10395.00	-49.15	0.8	12.1	-60.45	H

Test Data (3MHz bandwidth QPSK Mode)

Frequency [MHz]	Generator output power(Pg) [dBm]	Cable loss [dB]	Antenna Gain [dB]	Spurious Emission Power (Pd) [dBm]	Antenna Polarization [H/V]
3465.00	-54.51	6.9	12.6	-60.21	V
5197.50	-51.76	5.8	12.7	-58.66	V
6930.00	-50.81	0.9	11.7	-61.61	V
8662.50	-50.66	1.1	11.9	-61.46	V
10395.00	-45.88	0.8	12.1	-57.18	V
3465.00	-56.60	6.9	12.6	-62.30	H
5197.50	-55.32	5.8	12.7	-62.22	H
6930.00	-51.47	0.9	11.7	-62.27	H
8662.50	-52.06	1.1	11.9	-62.86	H
10395.00	-49.04	0.8	12.1	-60.34	H

**Test Data (3MHz bandwidth 16QAM Mode)**

Frequency [MHz]	Generator output power(Pg) [dBm]	Cable loss [dB]	Antenna Gain [dB]	Spurious Emission Power (Pd) [dBm]	Antenna Polarization [H/V]
3465.00	-53.01	6.9	12.6	-58.71	V
5197.50	-54.81	5.8	12.7	-61.71	V
6930.00	-50.75	0.9	11.7	-61.55	V
8662.50	-51.87	1.1	11.9	-62.67	V
10395.00	-47.14	0.8	12.1	-58.44	V
3465.00	-52.43	6.9	12.6	-58.13	H
5197.50	-50.70	5.8	12.7	-57.60	H
6930.00	-47.44	0.9	11.7	-58.24	H
8662.50	-46.34	1.1	11.9	-57.14	H
10395.00	-50.44	0.8	12.1	-61.74	H

Test Data (5MHz bandwidth QPSK Mode)

Frequency [MHz]	Generator output power(Pg) [dBm]	Cable loss [dB]	Antenna Gain [dB]	Spurious Emission Power (Pd) [dBm]	Antenna Polarization [H/V]
3465.00	-53.25	6.9	12.6	-58.95	V
5197.50	-53.66	5.8	12.7	-60.56	V
6930.00	-51.82	0.9	11.7	-62.62	V
8662.50	-48.32	1.1	11.9	-59.12	V
10395.00	-48.64	0.8	12.1	-59.94	V
3465.00	-53.53	6.9	12.6	-59.23	H
5197.50	-53.77	5.8	12.7	-60.67	H
6930.00	-50.45	0.9	11.7	-61.25	H
8662.50	-50.92	1.1	11.9	-61.72	H
10395.00	-51.37	0.8	12.1	-62.67	H

**Test Data (5MHz bandwidth 16QAM Mode)**

Frequency [MHz]	Generator output power(Pg) [dBm]	Cable loss [dB]	Antenna Gain [dB]	Spurious Emission Power (Pd) [dBm]	Antenna Polarization [H/V]
3465.00	-55.46	6.9	12.6	-61.16	V
5197.50	-52.71	5.8	12.7	-59.61	V
6930.00	-49.11	0.9	11.7	-59.91	V
8662.50	-50.97	1.1	11.9	-61.77	V
10395.00	-46.65	0.8	12.1	-57.95	V
3465.00	-56.77	6.9	12.6	-62.47	H
5197.50	-51.97	5.8	12.7	-58.87	H
6930.00	-51.80	0.9	11.7	-62.60	H
8662.50	-48.59	1.1	11.9	-59.39	H
10395.00	-47.73	0.8	12.1	-59.03	H

Test Data (10MHz bandwidth QPSK Mode)

Frequency [MHz]	Generator output power(Pg) [dBm]	Cable loss [dB]	Antenna Gain [dB]	Spurious Emission Power (Pd) [dBm]	Antenna Polarization [H/V]
3465.00	-53.58	6.9	12.6	-59.28	V
5197.50	-52.86	5.8	12.7	-59.76	V
6930.00	-47.47	0.9	11.7	-58.27	V
8662.50	-47.94	1.1	11.9	-58.74	V
10395.00	-46.58	0.8	12.1	-57.88	V
3465.00	-55.98	6.9	12.6	-61.68	H
5197.50	-55.56	5.8	12.7	-62.46	H
6930.00	-51.45	0.9	11.7	-62.25	H
8662.50	-50.09	1.1	11.9	-60.89	H
10395.00	-49.52	0.8	12.1	-60.82	H

**Test Data (10MHz bandwidth 16QAM Mode)**

Frequency [MHz]	Generator output power(Pg) [dBm]	Cable loss [dB]	Antenna Gain [dB]	Spurious Emission Power (Pd) [dBm]	Antenna Polarization [H/V]
3465.00	-56.08	6.9	12.6	-61.78	V
5197.50	-52.06	5.8	12.7	-58.96	V
6930.00	-47.50	0.9	11.7	-58.30	V
8662.50	-50.27	1.1	11.9	-61.07	V
10395.00	-50.84	0.8	12.1	-62.14	V
3465.00	-55.62	6.9	12.6	-61.32	H
5197.50	-55.70	5.8	12.7	-62.60	H
6930.00	-51.09	0.9	11.7	-61.89	H
8662.50	-51.14	1.1	11.9	-61.94	H
10395.00	-48.79	0.8	12.1	-60.09	H

Test Data (15MHz bandwidth QPSK Mode)

Frequency [MHz]	Generator output power(Pg) [dBm]	Cable loss [dB]	Antenna Gain [dB]	Spurious Emission Power (Pd) [dBm]	Antenna Polarization [H/V]
3465.00	-52.31	6.9	12.6	-58.01	V
5197.50	-50.80	5.8	12.7	-57.70	V
6930.00	-47.87	0.9	11.7	-58.67	V
8662.50	-49.84	1.1	11.9	-60.64	V
10395.00	-50.05	0.8	12.1	-61.35	V
3465.00	-56.10	6.9	12.6	-61.80	H
5197.50	-55.93	5.8	12.7	-62.83	H
6930.00	-51.79	0.9	11.7	-62.59	H
8662.50	-49.64	1.1	11.9	-60.44	H
10395.00	-49.95	0.8	12.1	-61.25	H



Test Data (15MHz bandwidth 16QAM Mode)

Frequency [MHz]	Generator output power(Pg) [dBm]	Cable loss [dB]	Antenna Gain [dB]	Spurious Emission Power (Pd) [dBm]	Antenna Polarization [H/V]
3465.00	-53.14	6.9	12.6	-58.84	V
5197.50	-55.89	5.8	12.7	-62.79	V
6930.00	-51.38	0.9	11.7	-62.18	V
8662.50	-47.00	1.1	11.9	-57.80	V
10395.00	-51.19	0.8	12.1	-62.49	V
3465.00	-55.10	6.9	12.6	-60.80	H
5197.50	-52.70	5.8	12.7	-59.60	H
6930.00	-46.25	0.9	11.7	-57.05	H
8662.50	-49.94	1.1	11.9	-60.74	H
10395.00	-51.35	0.8	12.1	-62.65	H

Test Data (20MHz bandwidth QPSK Mode)

Frequency [MHz]	Generator output power(Pg) [dBm]	Cable loss [dB]	Antenna Gain [dB]	Spurious Emission Power (Pd) [dBm]	Antenna Polarization [H/V]
3465.00	-57.30	6.9	12.6	-63.00	V
5197.50	-51.42	5.8	12.7	-58.32	V
6930.00	-50.72	0.9	11.7	-61.52	V
8662.50	-46.48	1.1	11.9	-57.28	V
10395.00	-51.46	0.8	12.1	-62.76	V
3465.00	-55.44	6.9	12.6	-61.14	H
5197.50	-52.44	5.8	12.7	-59.34	H
6930.00	-50.21	0.9	11.7	-61.01	H
8662.50	-46.77	1.1	11.9	-57.57	H
10395.00	-50.28	0.8	12.1	-61.58	H



Test Data (20MHz bandwidth 16QAM Mode)

Frequency [MHz]	Generator output power(Pg) [dBm]	Cable loss [dB]	Antenna Gain [dB]	Spurious Emission Power (Pd) [dBm]	Antenna Polarization [H/V]
3465.00	-55.47	6.9	12.6	-61.17	V
5197.50	-53.78	5.8	12.7	-60.68	V
6930.00	-48.45	0.9	11.7	-59.25	V
8662.50	-46.56	1.1	11.9	-57.36	V
10395.00	-49.30	0.8	12.1	-60.60	V
3465.00	-53.47	6.9	12.6	-59.17	H
5197.50	-50.20	5.8	12.7	-57.10	H
6930.00	-48.90	0.9	11.7	-59.70	H
8662.50	-51.09	1.1	11.9	-61.89	H
10395.00	-49.69	0.8	12.1	-60.99	H

5.4.2 LTE B13 Radiated Spurious Emission Results

Test Data (5MHz bandwidth QPSK Mode)

Frequency [MHz]	Generator output power(Pg) [dBm]	Cable loss [dB]	Antenna Gain [dB]	Spurious Emission Power (Pd) [dBm]	Antenna Polarization [H/V]
1502.00	-48.22	4.5	8.0	-51.72	V
2253.00	-46.87	5.7	10.4	-51.57	V
3004.00	-54.91	6.5	11.5	-59.91	V
3755.00	-54.31	7.1	12.6	-59.81	V
4506.00	-52.90	7.9	12.7	-57.70	V
1502.00	-54.26	4.5	8.0	-57.76	H
2253.00	-57.61	5.7	10.4	-62.31	H
3004.00	-52.53	6.5	11.5	-57.53	H
3755.00	-56.17	7.1	12.6	-61.67	H
4506.00	-54.65	7.9	12.7	-59.45	H

**Test Data (5MHz bandwidth 16QAM Mode)**

Frequency [MHz]	Generator output power(Pg) [dBm]	Cable loss [dB]	Antenna Gain [dB]	Spurious Emission Power (Pd) [dBm]	Antenna Polarization [H/V]
1502.00	-48.38	4.5	8.0	-51.88	V
2253.00	-46.03	5.7	10.4	-50.73	V
3004.00	-56.08	6.5	11.5	-61.08	V
3755.00	-55.18	7.1	12.6	-60.68	V
4506.00	-57.12	7.9	12.7	-61.92	V
1502.00	-59.42	4.5	8.0	-62.92	H
2253.00	-52.95	5.7	10.4	-57.65	H
3004.00	-54.78	6.5	11.5	-59.78	H
3755.00	-51.93	7.1	12.6	-57.43	H
4506.00	-52.63	7.9	12.7	-57.43	H

Test Data (10MHz bandwidth QPSK Mode)

Frequency [MHz]	Generator output power(Pg) [dBm]	Cable loss [dB]	Antenna Gain [dB]	Spurious Emission Power (Pd) [dBm]	Antenna Polarization [H/V]
1502.00	-48.42	4.5	8.0	-51.92	V
2253.00	-47.08	5.7	10.4	-51.78	V
3004.00	-53.30	6.5	11.5	-58.30	V
3755.00	-52.85	7.1	12.6	-58.35	V
4506.00	-55.73	7.9	12.7	-60.53	V
1502.00	-58.92	4.5	8.0	-62.42	H
2253.00	-56.71	5.7	10.4	-61.41	H
3004.00	-52.42	6.5	11.5	-57.42	H
3755.00	-53.19	7.1	12.6	-58.69	H
4506.00	-52.46	7.9	12.7	-57.26	H



Test Data (10MHz bandwidth 16QAM Mode)

Frequency [MHz]	Generator output power(Pg) [dBm]	Cable loss [dB]	Antenna Gain [dB]	Spurious Emission Power (Pd) [dBm]	Antenna Polarization [H/V]
1502.00	-47.84	4.5	8.0	-51.34	V
2253.00	-45.73	5.7	10.4	-50.43	V
3004.00	-56.04	6.5	11.5	-61.04	V
3755.00	-56.20	7.1	12.6	-61.70	V
4506.00	-54.41	7.9	12.7	-59.21	V
1502.00	-48.61	4.5	8.0	-52.11	H
2253.00	-46.59	5.7	10.4	-51.29	H
3004.00	-56.72	6.5	11.5	-61.72	H
3755.00	-52.57	7.1	12.6	-58.07	H
4506.00	-52.46	7.9	12.7	-57.26	H



5.5 Band Edge

Specifications:	FCC Part 2.1051, 2.1053, 27.53 RSS-130 4.6, RSS-139 6.6
DUT Serial Number:	S1: U1708470300603
Test conditions:	Ambient Temperature:15°C-35°C Relative Humidity:30%-60% Air pressure: 86-106kPa
Test Results:	--

Limit Level Construction:

According to Part 27.53(c):

For operations in the 746-758 MHz band and the 776-788 MHz band, on any frequency outside the 776-788 MHz band, the power of any emission shall be attenuated outside the band below the transmitter power (P) by at least $43 + 10 \log(P)$ dB;

According to Part 27.53(h):

Except as otherwise specified below, for operations in the 1695-1710 MHz, 1710-1755 MHz, 1755-1780 MHz, 1915-1920 MHz, 1995-2000 MHz, 2000-2020 MHz, 2110-2155 MHz, 2155-2180 MHz, and 2180-2200 bands, the power of any emission outside a licensee's frequency block shall be attenuated below the transmitter power (P) in watts by at least $43 + 10 \log_{10}(P)$ dB.

According to RSS-130 4.6:

The power of any unwanted emissions in any 100 kHz bandwidth on any frequency outside the frequency range(s) within which the equipment is designed to operate shall be attenuated below the transmitter power, P (dBW), by at least $43 + 10 \log_{10} p$ (watts), dB. However, in the 100 kHz band immediately outside the equipment's operating frequency range, a resolution bandwidth of 30 kHz may be employed.

In addition to the limit outlined above, equipment operating in the frequency bands 746-756 MHz and 777-787 MHz shall also comply with the following restrictions:

The power of any unwanted emissions in any 6.25 kHz bandwidth for all frequencies between 763-775 MHz and 793-806 MHz shall be attenuated below the transmitter power, P (dBW), by at least:

- (i) $76 + 10 \log_{10} p$ (watts), dB, for base and fixed equipment, and
- (ii) $65 + 10 \log_{10} p$ (watts), dB, for mobile and portable equipment

According to RSS-139 6.6:

(i) In the first 1.0 MHz bands immediately outside and adjacent to the equipment's smallest operating frequency block, which can contain the equipment's occupied bandwidth, the emission power per any 1% of the emission bandwidth shall be attenuated below the transmitter output power P (in dBW) by at least $43 + 10 \log_{10} p$ (watts) dB.

(ii) After the first 1.0 MHz outside the equipment's smallest operating frequency block, which can contain the equipment's occupied bandwidth, the emission power in any 1 MHz bandwidth shall be attenuated below the transmitter output power P (in dBW) by at least $43 + 10 \log_{10} p$ (watts) dB.



Test Setup:

During the test, the EUT was controlled via the Wireless Communications Test Set to ensure max power transmission and proper modulation and measured by spectrum analyzer.

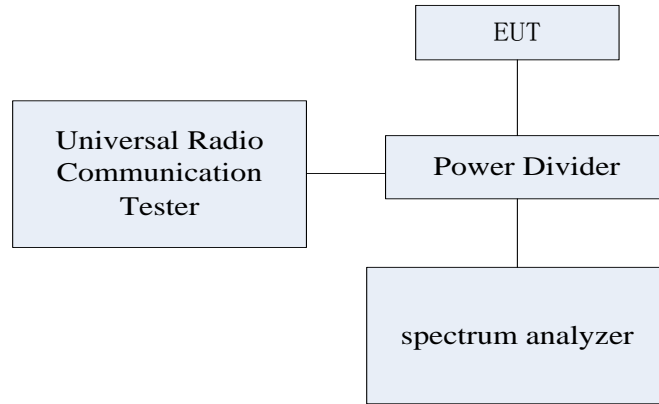

Test Method:

- 1) The EUT was coupled to the EMI test receiver analyzer mode and the base station simulator through a power divider. The loss of the cables the test system is calibrated to correct the readings.
- 2) The spectrum analyzer was set to Average Detector function and Maximum hold mode.
- 3) The resolution bandwidth of the spectrum analyzer was a little greater than 1% of the 26dB emission bandwidth.

Note: In the graphical result description (X, Y), X represents the number of RB, Y represents the RB offset.

5.5.1 LTE B4 Band Edge Results

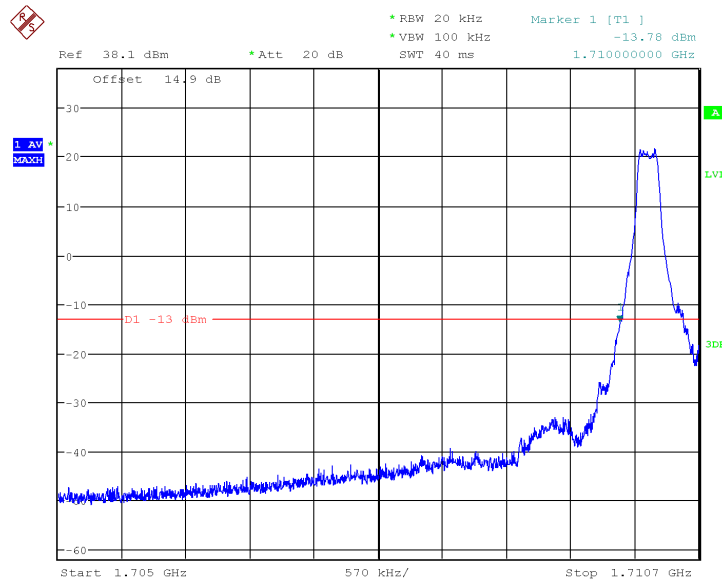

Date: 22.JUN.2017 11:59:36

LTE Band4, 1.4MHz bandwidth, QPSK,(1,0) Mode , Below 1710MHz

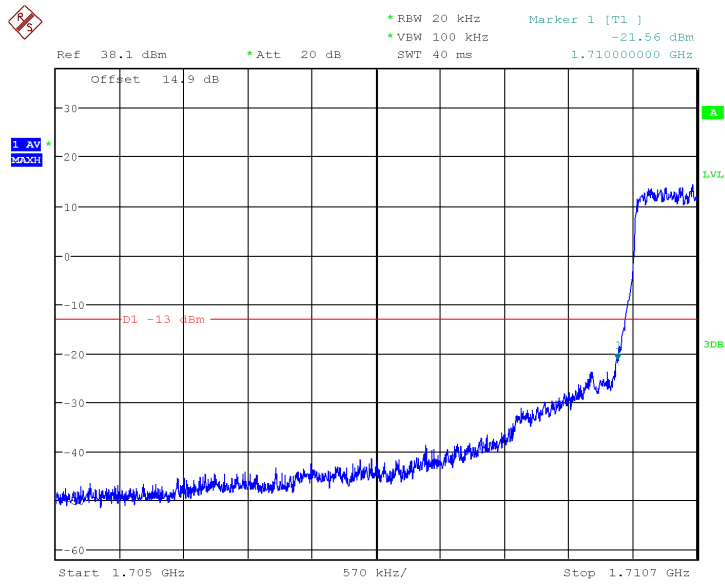

Date: 22.JUN.2017 12:00:50

LTE Band4, 1.4MHz bandwidth, QPSK,(6,0) Mode , Below 1710MHz

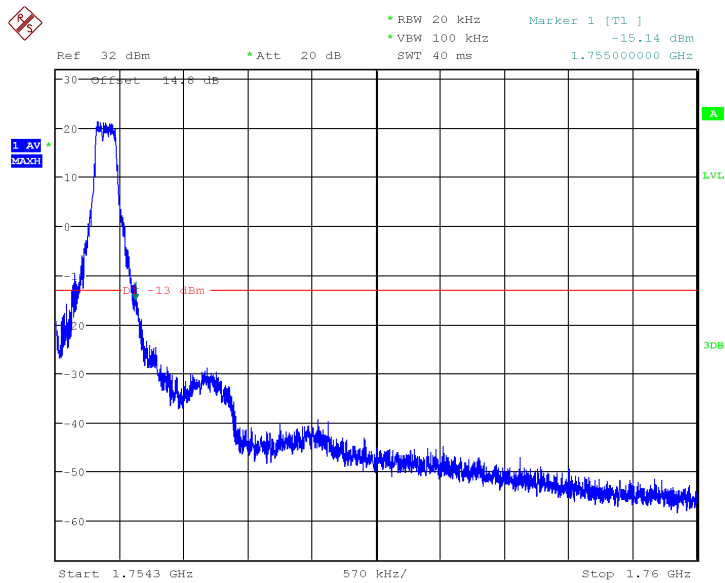

Date: 27.JUN.2017 10:55:49

LTE Band4, 1.4MHz bandwidth, QPSK,(1,6) Mode, Above 1755MHz

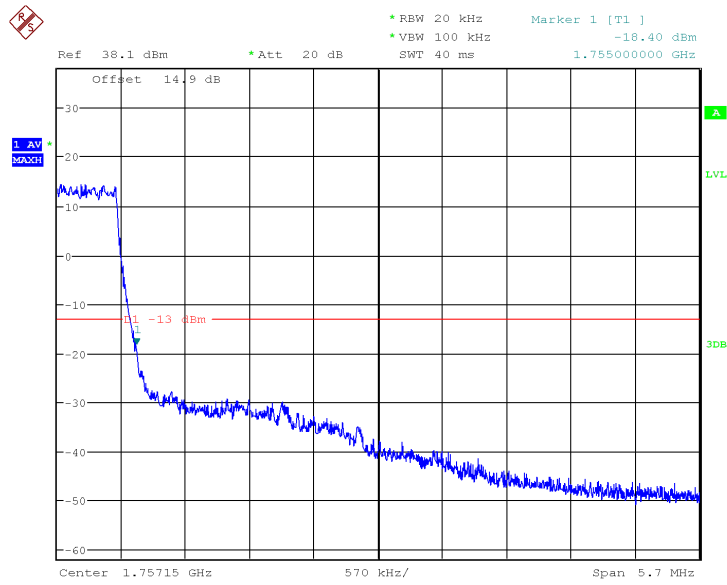

Date: 22.JUN.2017 12:03:43

LTE Band4, 1.4MHz bandwidth, QPSK,(6,0) Mode, Above 1755MHz

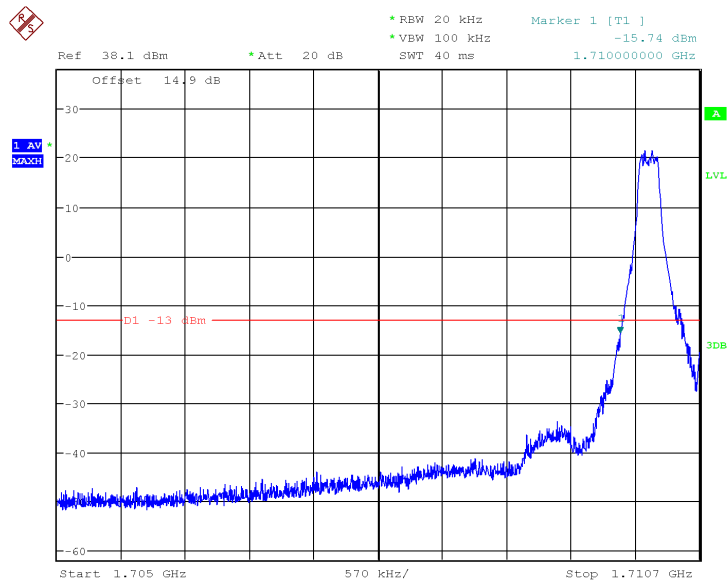

Date: 22.JUN.2017 13:51:36

LTE Band4, 1.4MHz bandwidth, 16QAM,(1,0) Mode , Below 1710MHz

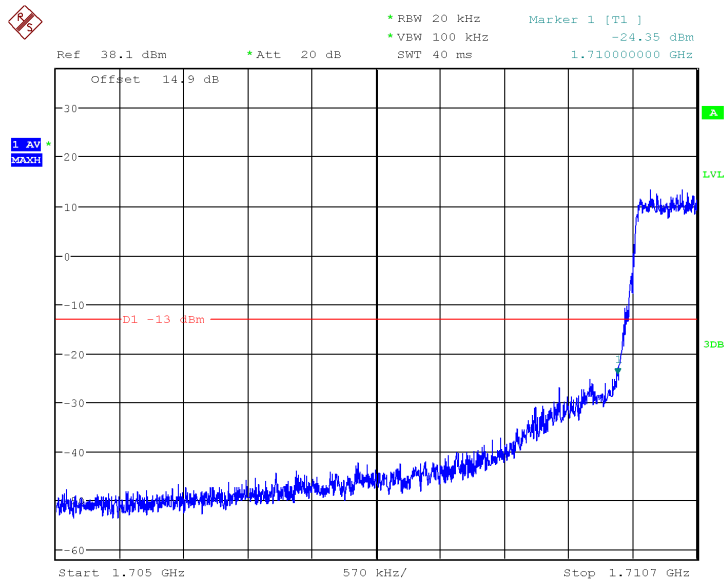

Date: 22.JUN.2017 13:51:58

LTE Band4, 1.4MHz bandwidth, 16QAM,(6,0) Mode , Below 1710MHz

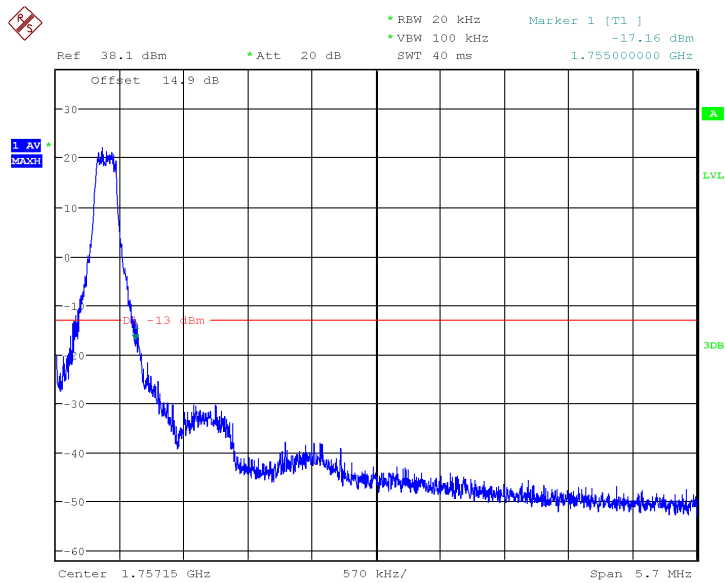

Date: 22.JUN.2017 13:39:56

LTE Band4, 1.4MHz bandwidth, 16QAM,(1,6) Mode , Above 1755MHz

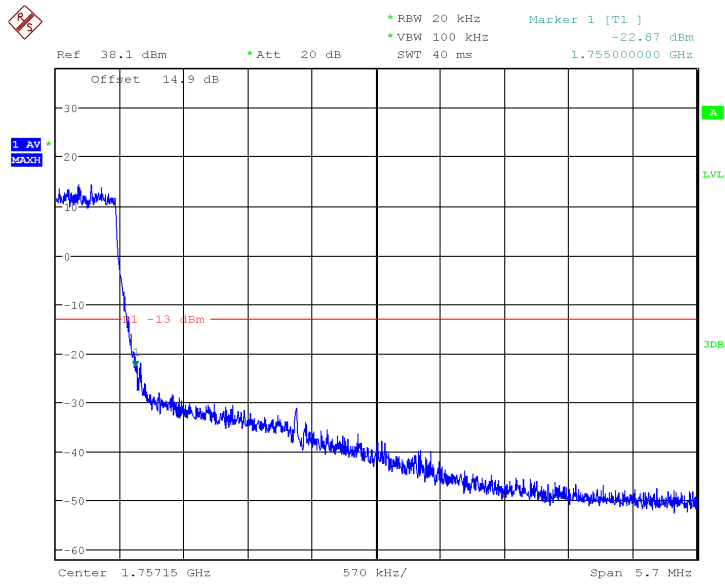

Date: 22.JUN.2017 13:41:23

LTE Band4, 1.4MHz bandwidth, 16QAM,(6,0) Mode, Above 1755MHz

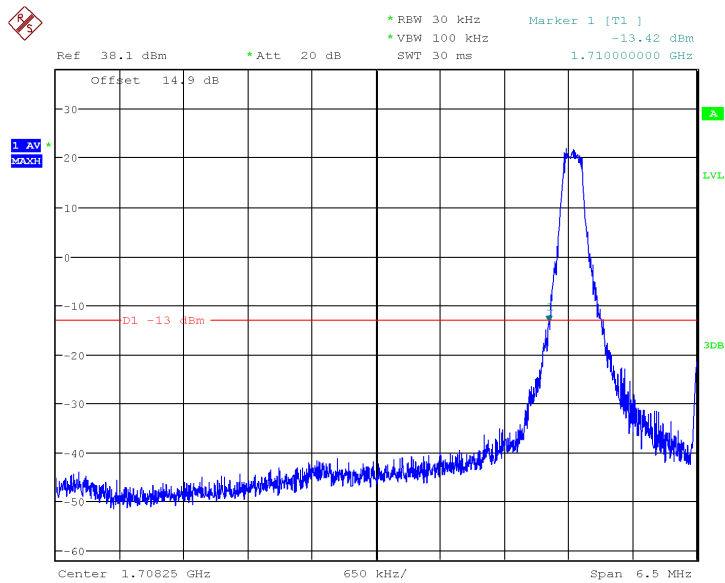

Date: 22.JUN.2017 14:00:52

LTE Band4, 3MHz bandwidth, QPSK,(1,0) Mode, Below 1710MHz

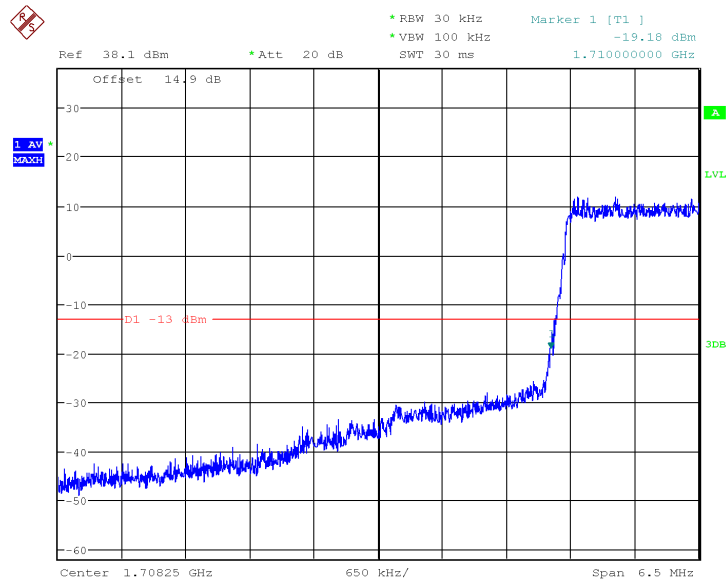

Date: 22.JUN.2017 14:01:21

LTE Band4, 3MHz bandwidth, QPSK,(15,0) Mode , Below 1710MHz

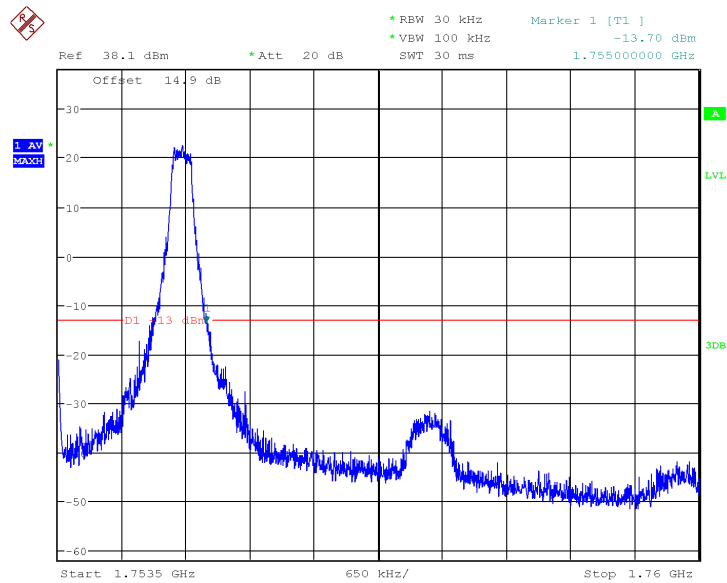

Date: 22.JUN.2017 14:12:23

LTE Band4, 3MHz bandwidth, QPSK,(1,15) Mode , Above 1755MHz

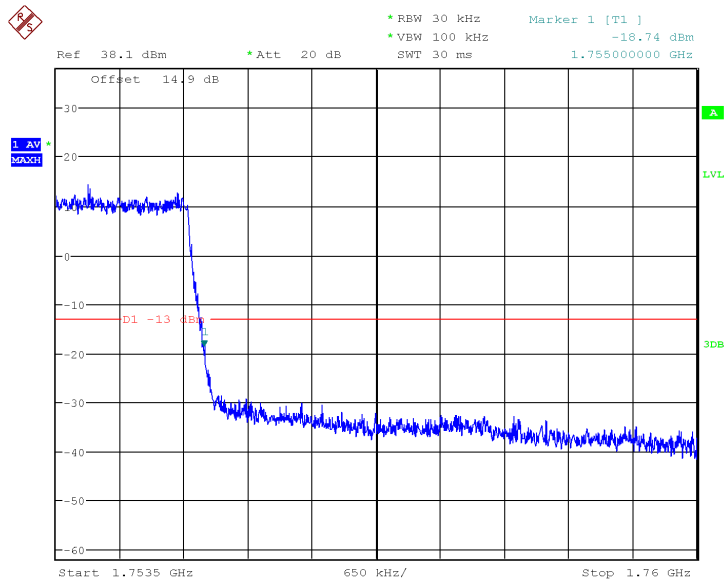

Date: 22.JUN.2017 14:11:57

LTE Band4, 3MHz bandwidth, QPSK,(15,0) Mode, Above 1755MHz

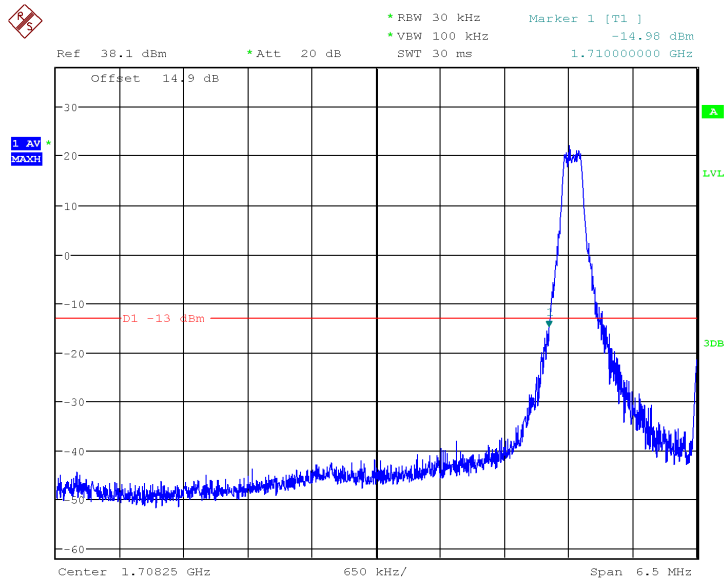

Date: 22.JUN.2017 14:02:31

LTE Band4, 3MHz bandwidth, 16QAM,(1,0) Mode , Below 1710MHz

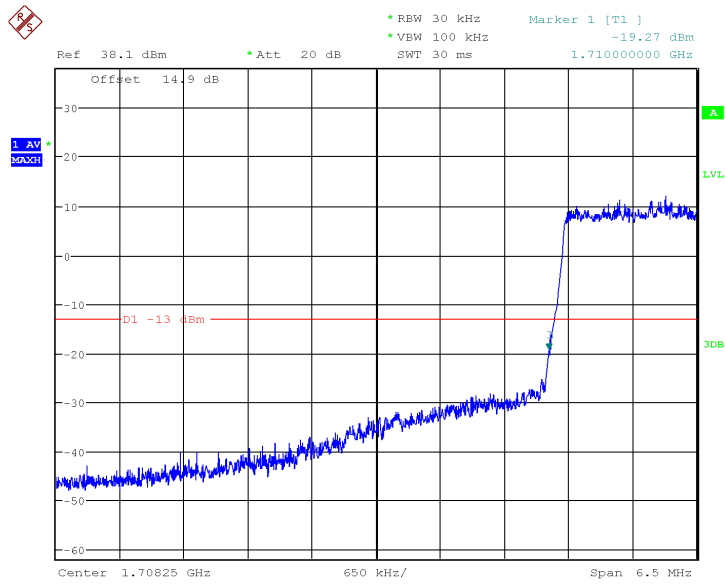

Date: 22.JUN.2017 14:02:07

LTE Band4, 3MHz bandwidth, 16QAM,(15,0) Mode , Below 1710MHz

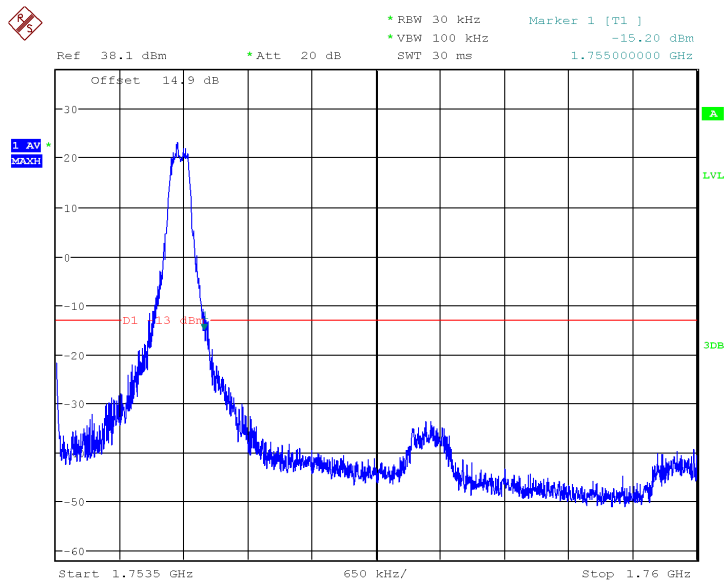

Date: 22.JUN.2017 14:10:52

LTE Band4, 3MHz bandwidth, 16QAM,(1,15) Mode , Above 1755MHz

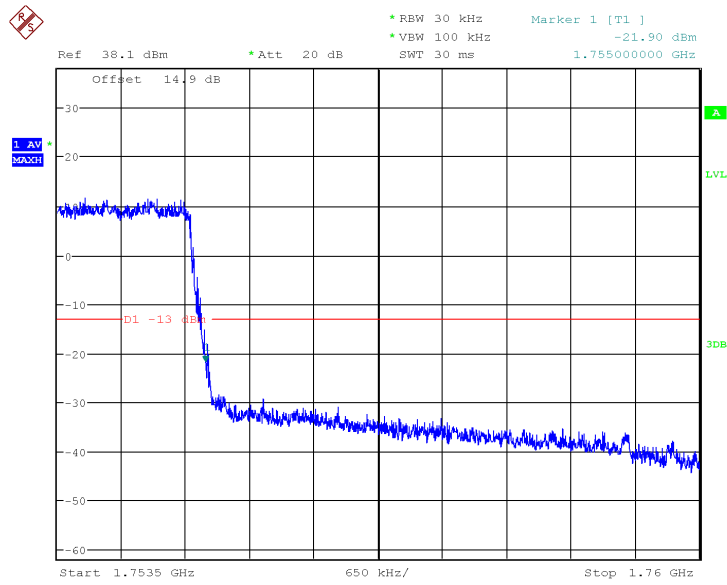

Date: 22.JUN.2017 14:11:30

LTE Band4, 3MHz bandwidth, 16QAM,(15,0) Mode, Above 1755MHz

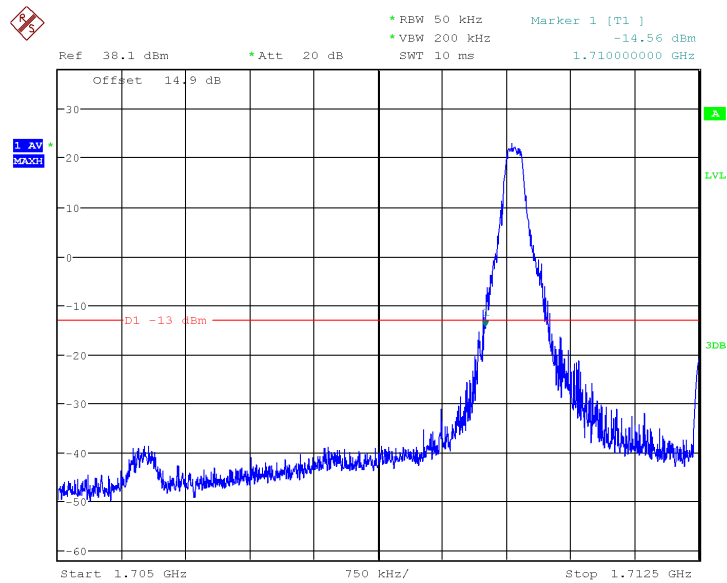

Date: 22.JUN.2017 14:33:23

LTE Band4, 5MHz bandwidth, QPSK,(1,0) Mode , Below 1710MHz

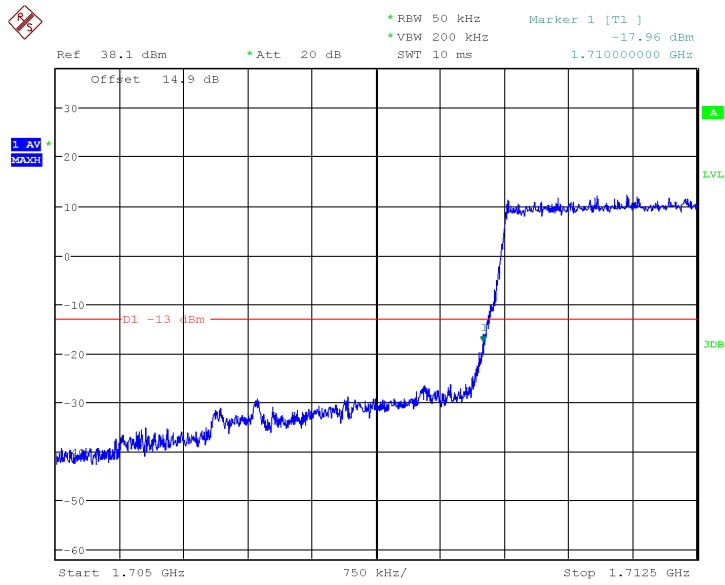

Date: 22.JUN.2017 14:36:27

LTE Band4, 5MHz bandwidth, QPSK,(25,0) Mode , Below 1710MHz

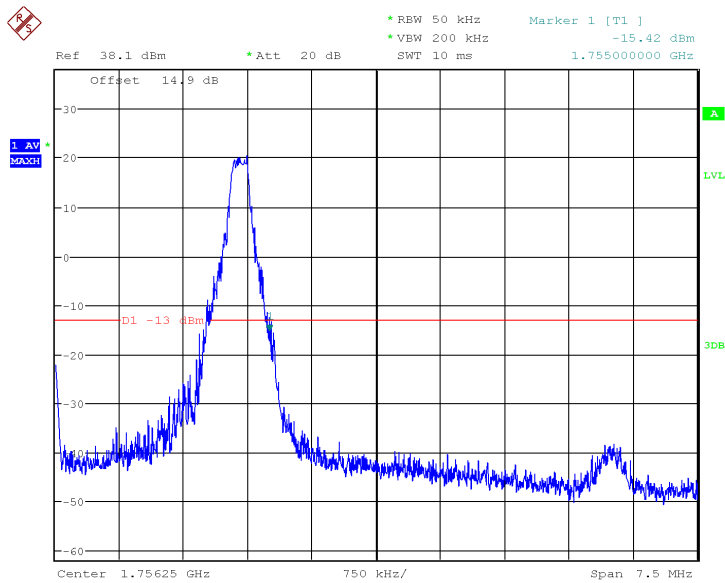

Date: 22.JUN.2017 14:40:57

LTE Band4, 5MHz bandwidth, QPSK,(1,25) Mode, Above 1755MHz

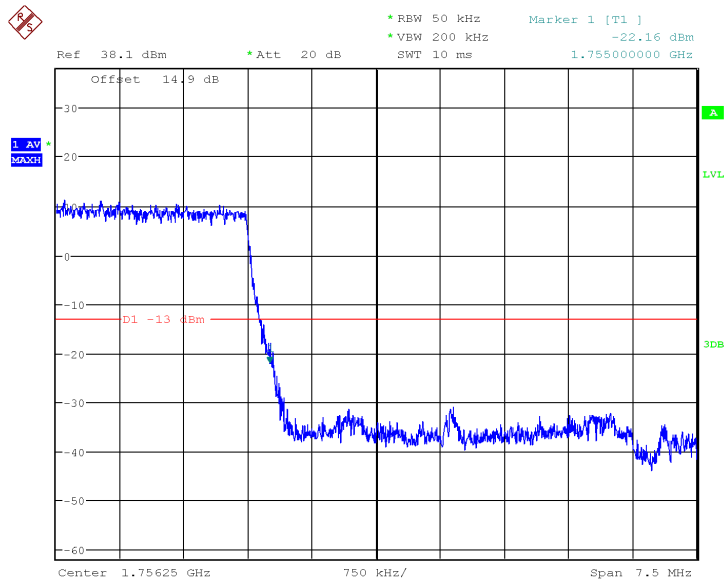

Date: 22.JUN.2017 14:42:04

LTE Band4, 5MHz bandwidth, QPSK,(25,0) Mode, Above 1755MHz

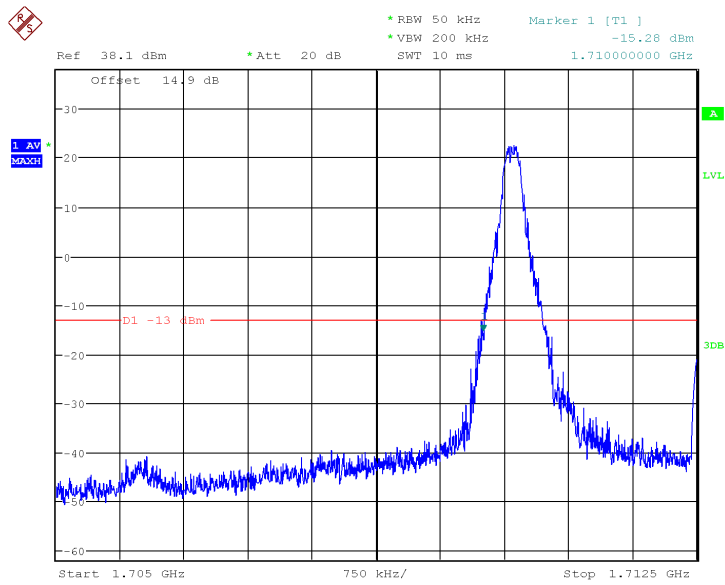

Date: 22.JUN.2017 14:34:29

LTE Band4, 5MHz bandwidth, 16QAM,(1,0) Mode , Below 1710MHz

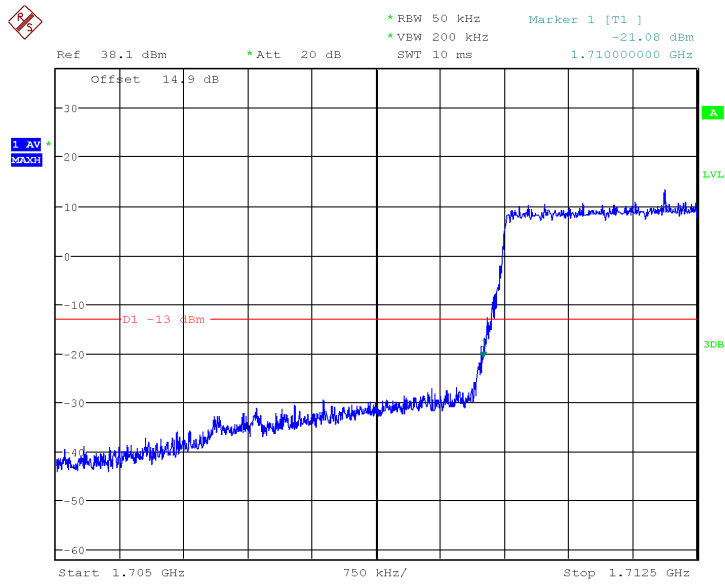

Date: 22.JUN.2017 14:36:02

LTE Band4, 5MHz bandwidth, 16QAM,(25,0) Mode , Below 1710MHz

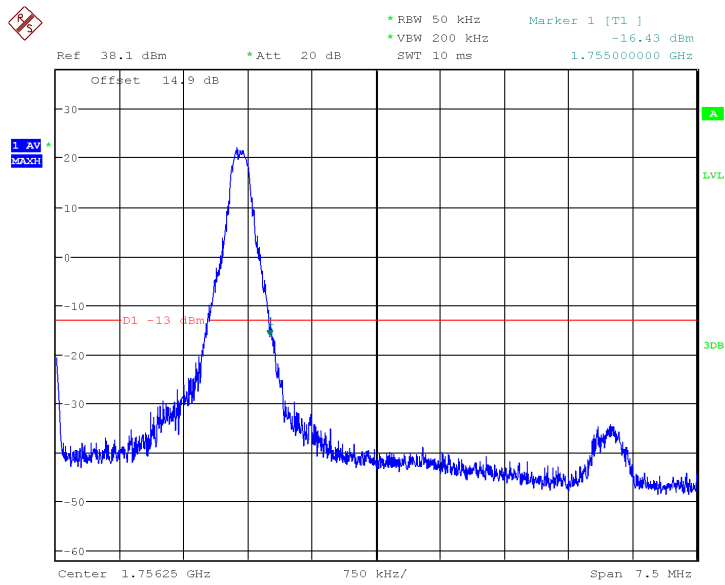

Date: 22.JUN.2017 14:41:23

LTE Band4, 5MHz bandwidth, 16QAM,(1,25) Mode , Above 1755MHz

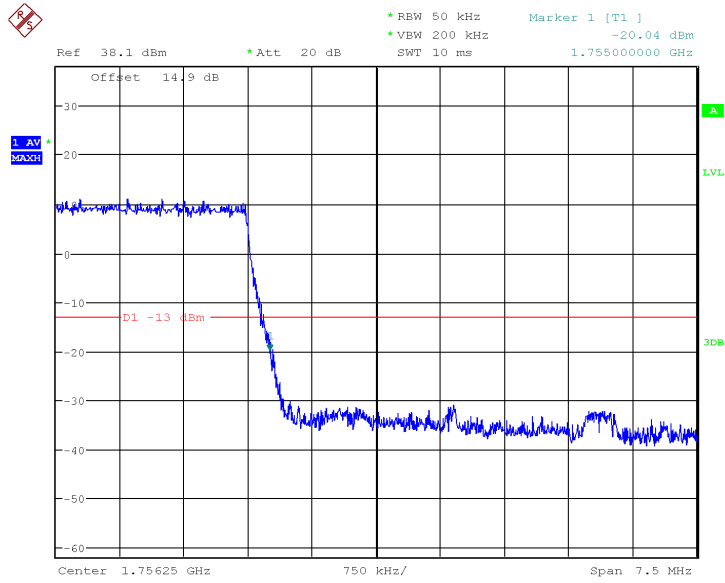

Date: 22.JUN.2017 14:41:50

LTE Band4, 5MHz bandwidth, 16QAM,(25,0) Mode, Above 1755MHz

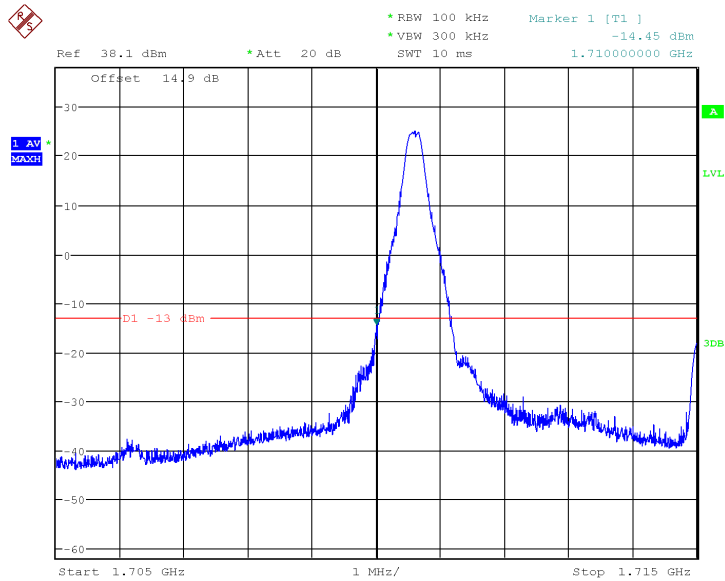

Date: 22.JUN.2017 14:55:20

LTE Band4, 10MHz bandwidth, QPSK,(1,0) Mode , Below 1710MHz

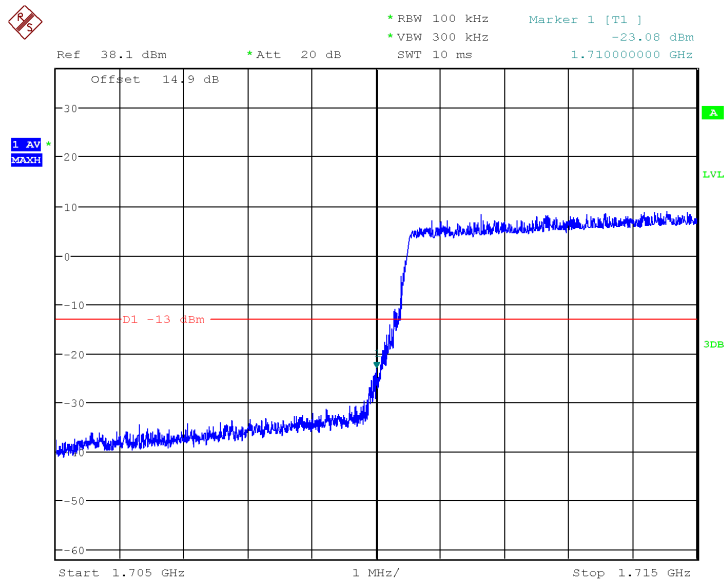

Date: 22.JUN.2017 14:59:38

LTE Band4, 10MHz bandwidth, QPSK,(50,0) Mode , Below 1710MHz

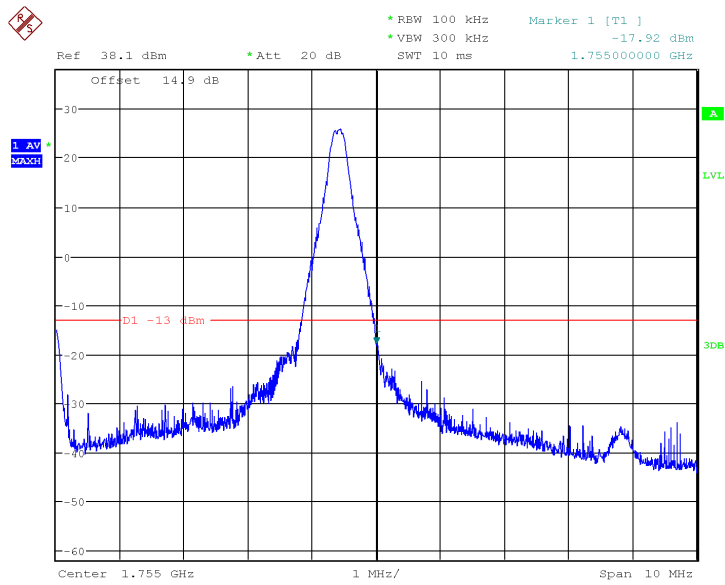

Date: 22.JUN.2017 15:04:33

LTE Band4, 10MHz bandwidth, QPSK,(1,50) Mode, Above 1755MHz

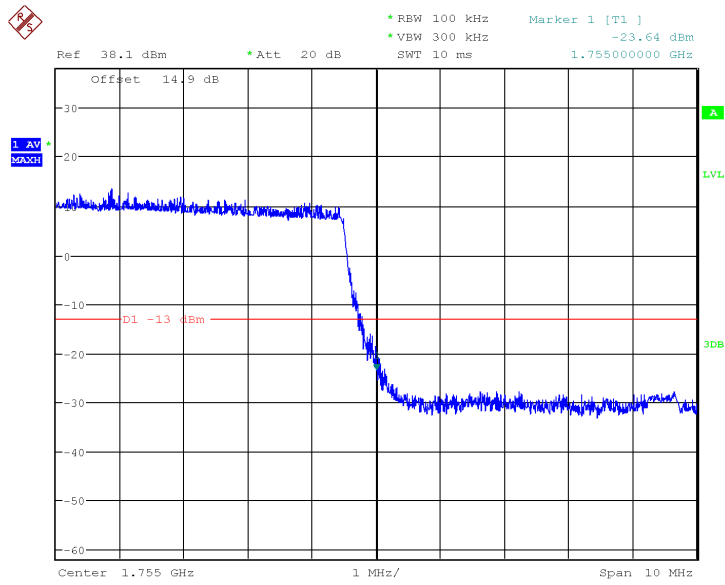

Date: 22.JUN.2017 15:08:30

LTE Band4, 10MHz bandwidth, QPSK,(50,0) Mode, Above 1755MHz

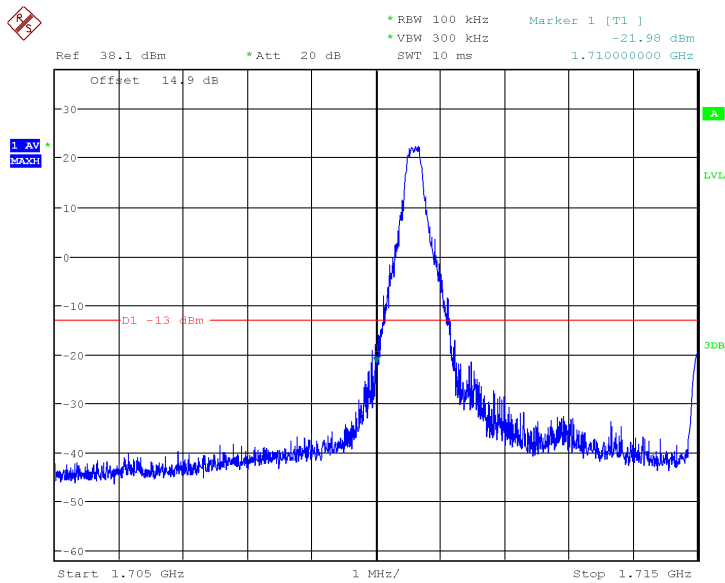

Date: 22.JUN.2017 14:56:41

LTE Band4, 10MHz bandwidth, 16QAM,(1,0) Mode, Below 1710MHz

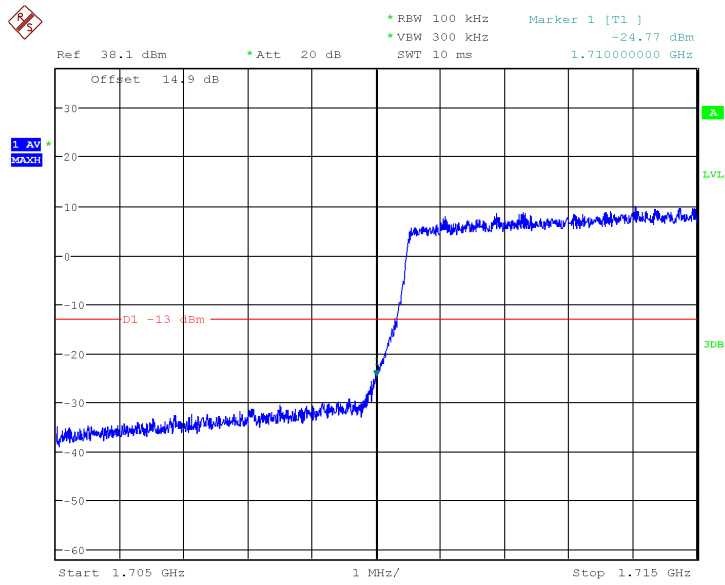

Date: 22.JUN.2017 14:59:06

LTE Band4, 10MHz bandwidth, 16QAM,(50,0) Mode , Below 1710MHz

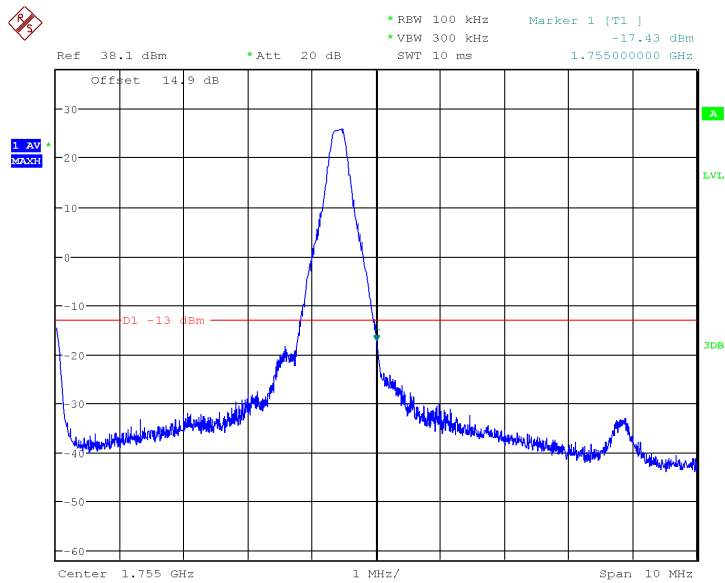

Date: 22.JUN.2017 15:06:55

LTE Band4, 10MHz bandwidth, 16QAM,(1,50) Mode , Above 1755MHz

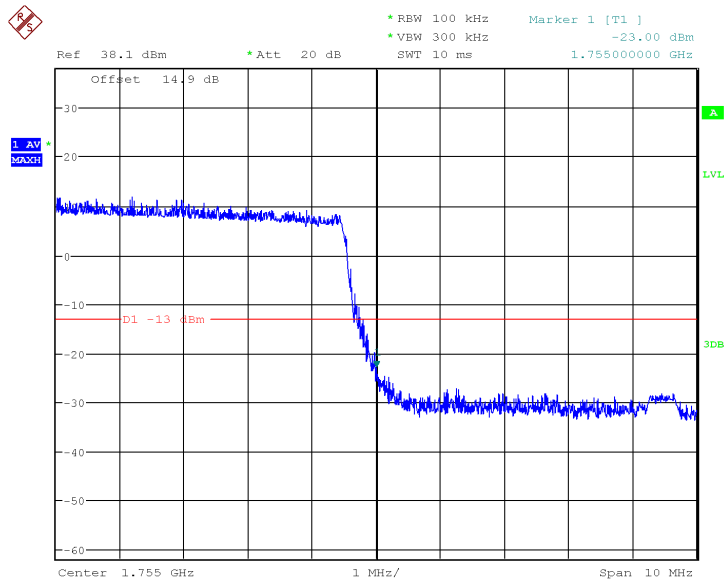

Date: 22.JUN.2017 15:07:38

LTE Band4, 10MHz bandwidth, 16QAM,(50,0) Mode, Above 1755MHz

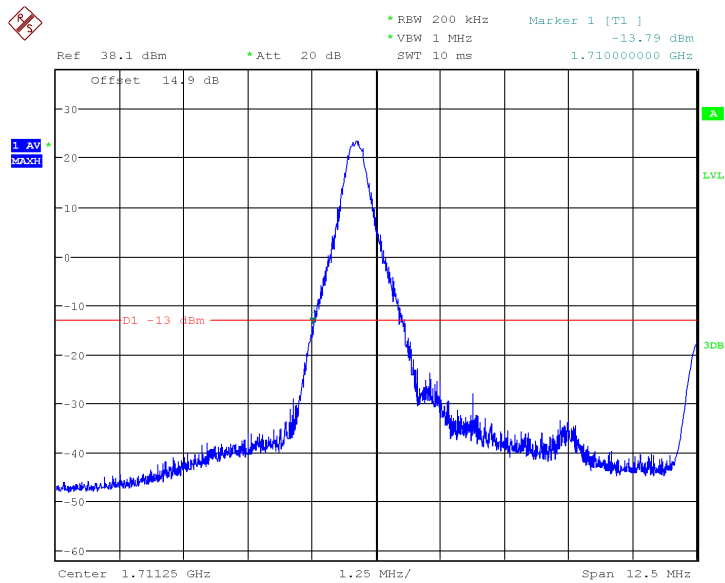

Date: 22.JUN.2017 15:14:32

LTE Band4, 15MHz bandwidth, QPSK,(1,0) Mode , Below 1710MHz

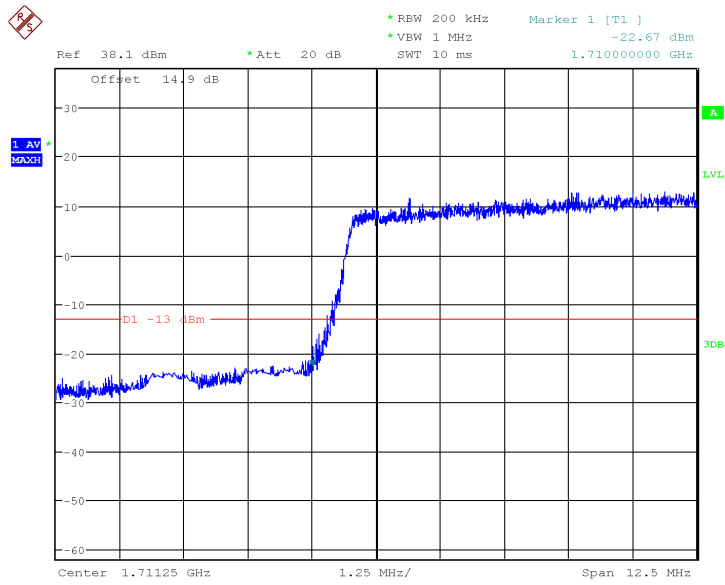

Date: 22.JUN.2017 15:17:27

LTE Band4, 15MHz bandwidth, QPSK,(75,0) Mode , Below 1710MHz

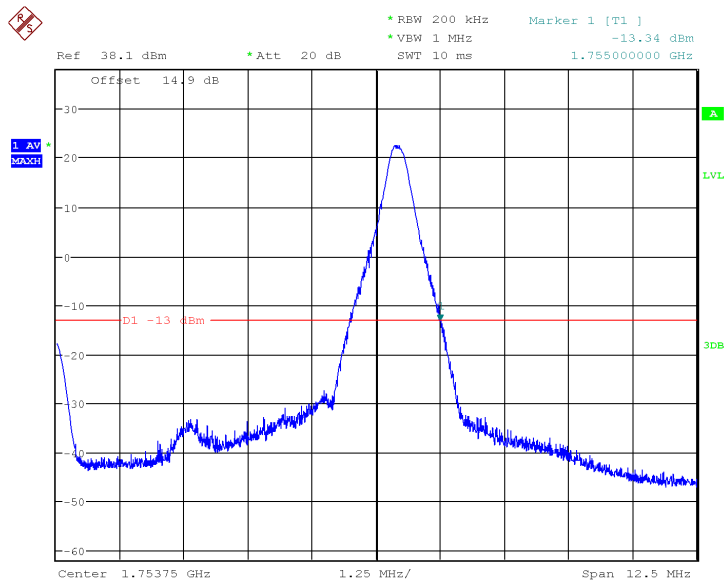

Date: 22.JUN.2017 15:25:35

LTE Band4, 15MHz bandwidth, QPSK,(1,75) Mode, Above 1755MHz

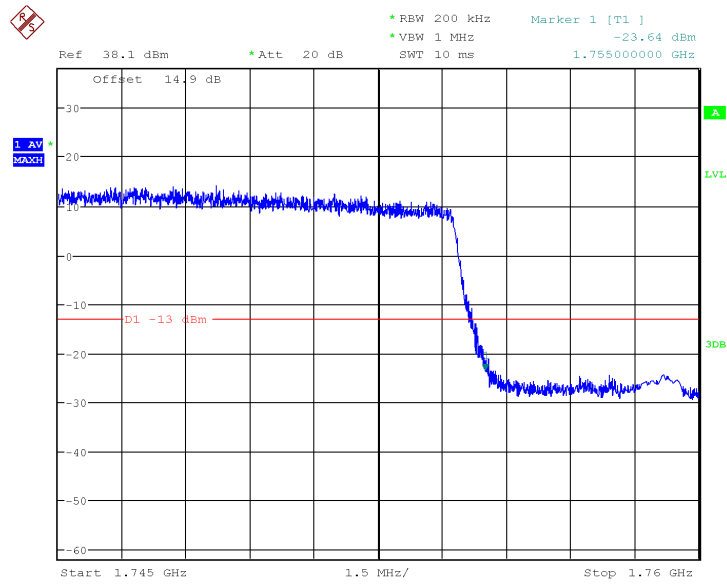

Date: 22.JUN.2017 16:10:59

LTE Band4, 15MHz bandwidth, QPSK,(75,0) Mode, Above 1755MHz

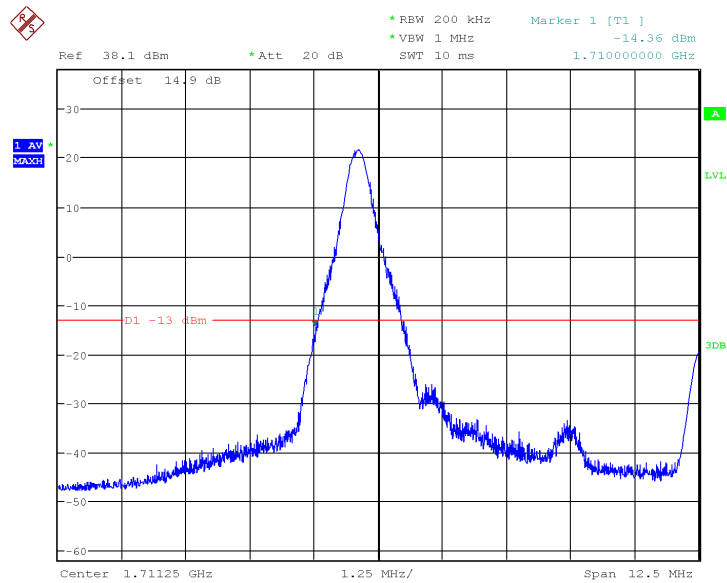

Date: 22.JUN.2017 15:15:59

LTE Band4, 15MHz bandwidth, 16QAM,(1,0) Mode , Below 1710MHz

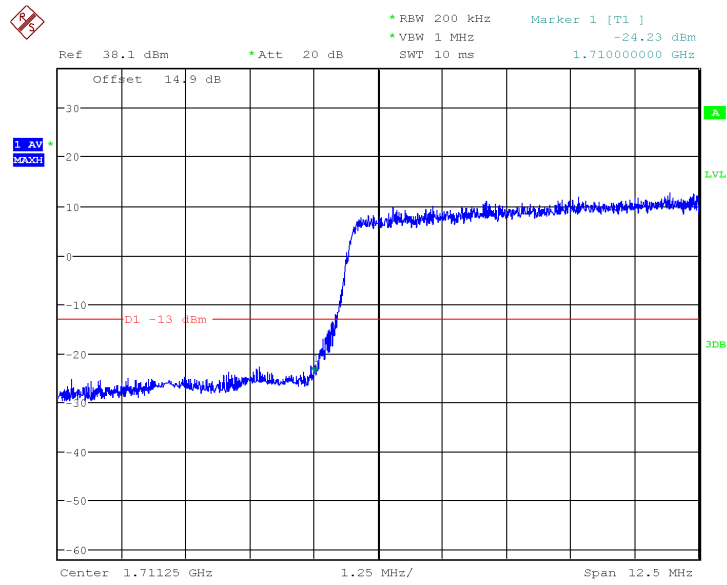

Date: 22.JUN.2017 15:17:01

LTE Band4, 15MHz bandwidth, 16QAM,(75,0) Mode , Below 1710MHz

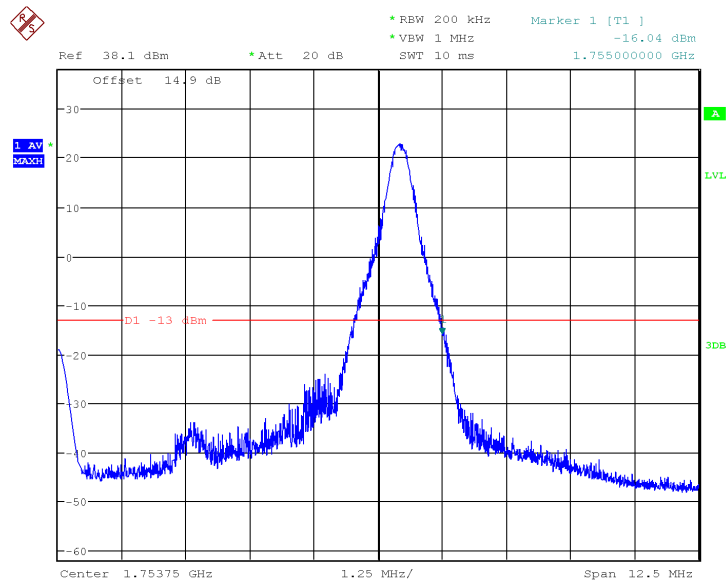

Date: 22.JUN.2017 15:26:01

LTE Band4, 15MHz bandwidth, 16QAM,(1,75) Mode , Above 1755MHz

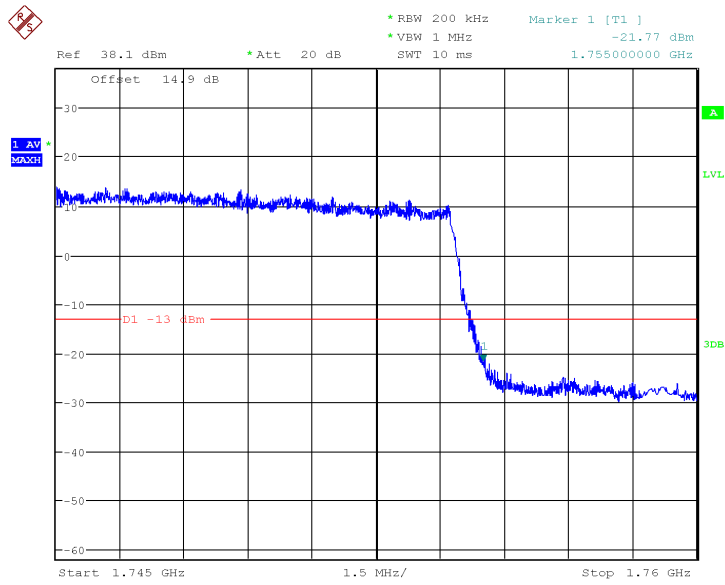

Date: 22.JUN.2017 16:10:26

LTE Band4, 15MHz bandwidth, 16QAM,(75,0) Mode, Above 1755MHz

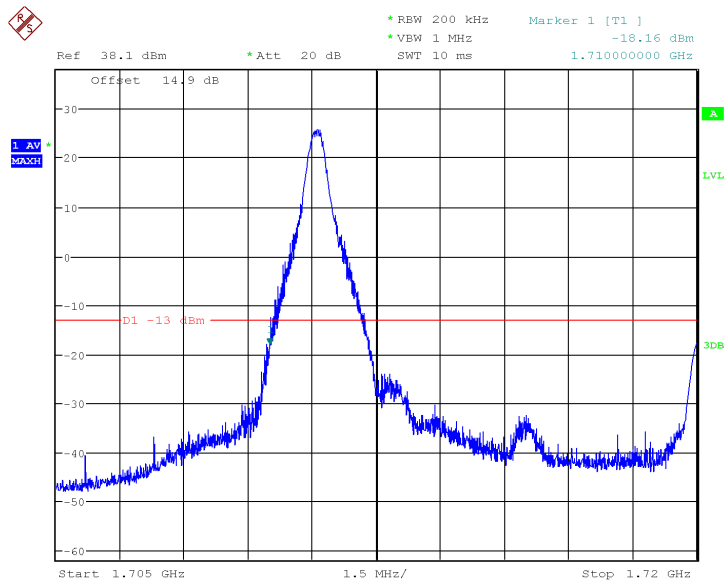

Date: 22.JUN.2017 15:43:45

LTE Band4, 20MHz bandwidth, QPSK,(1,0) Mode , Below 1710MHz

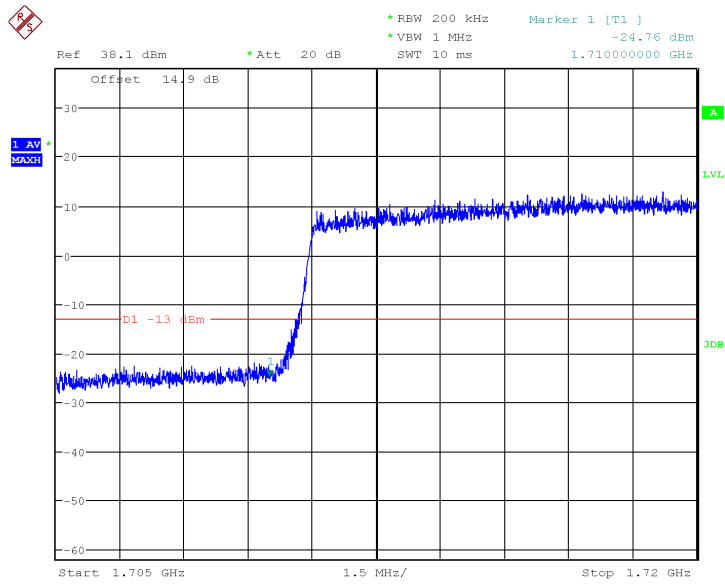

Date: 22.JUN.2017 15:54:38

LTE Band4, 20MHz bandwidth, QPSK,(100,0) Mode , Below 1710MHz

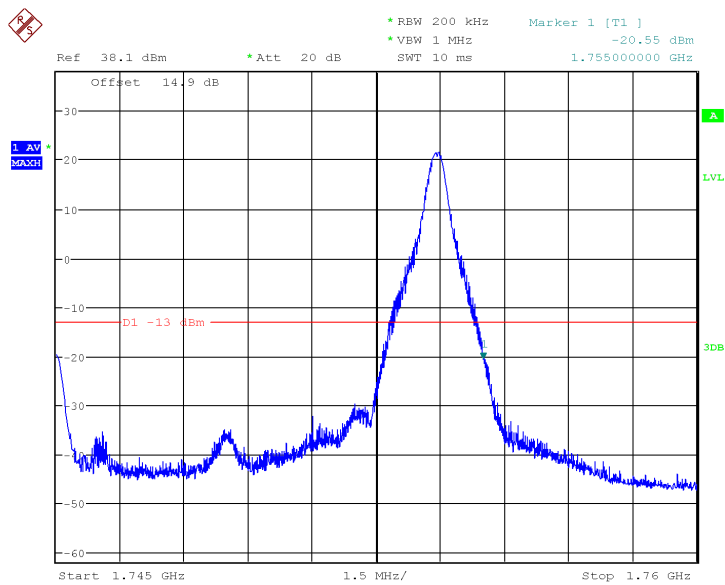

Date: 22.JUN.2017 15:39:19

LTE Band4, 20MHz bandwidth, QPSK,(1,100) Mode, Above 1755MHz

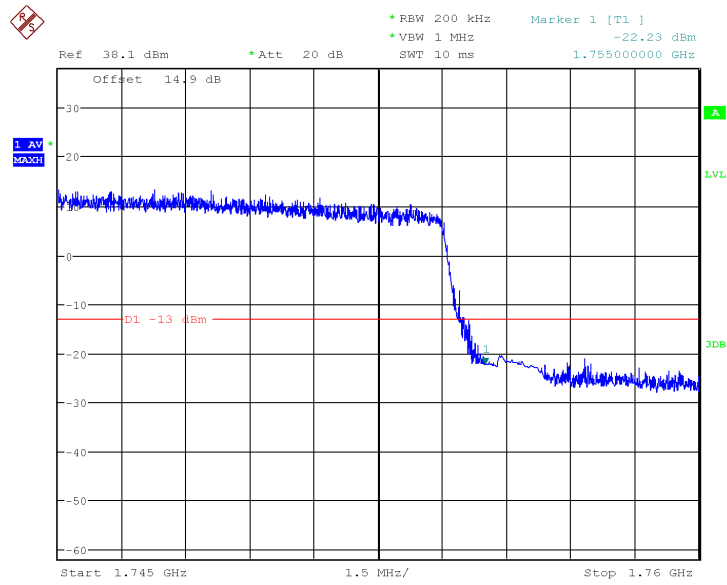

Date: 22.JUN.2017 15:41:30

LTE Band4, 20MHz bandwidth, QPSK,(100,0) Mode, Above 1755MHz

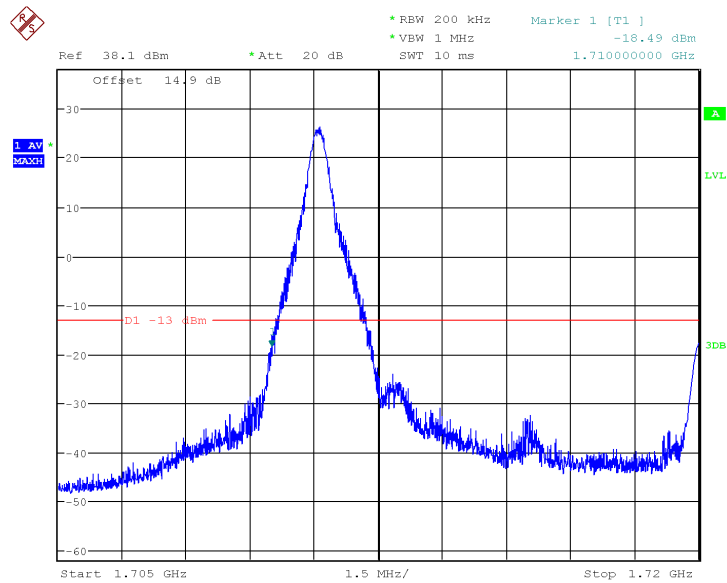

Date: 22.JUN.2017 15:44:09

LTE Band4, 20MHz bandwidth, 16QAM,(1,0) Mode , Below 1710MHz

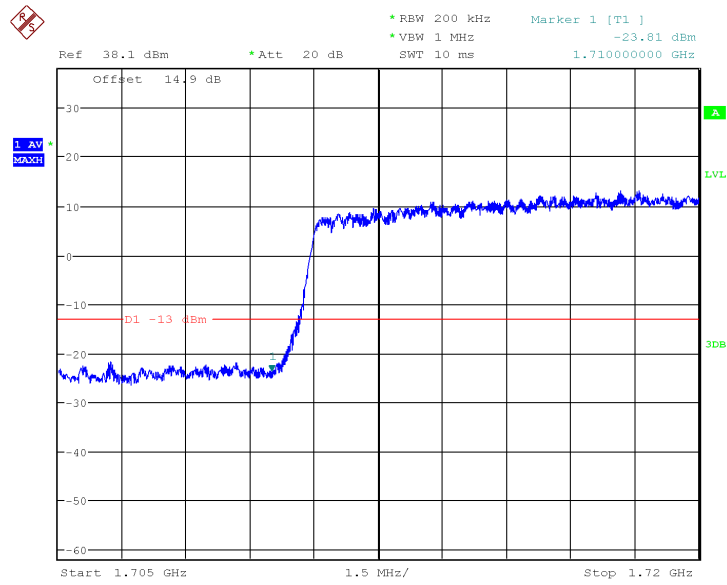

Date: 22.JUN.2017 15:50:59

LTE Band4, 20MHz bandwidth, 16QAM,(100,0) Mode , Below 1710MHz

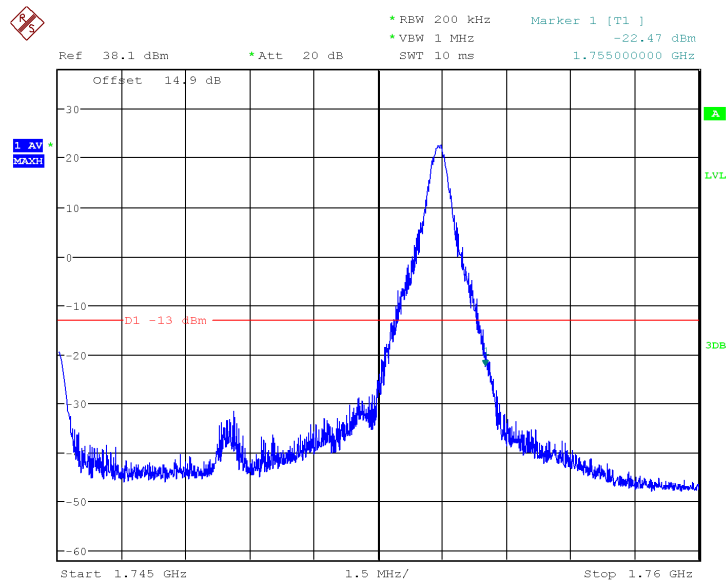

Date: 22.JUN.2017 15:40:00

LTE Band4, 20MHz bandwidth, 16QAM,(1,100) Mode , Above 1755MHz

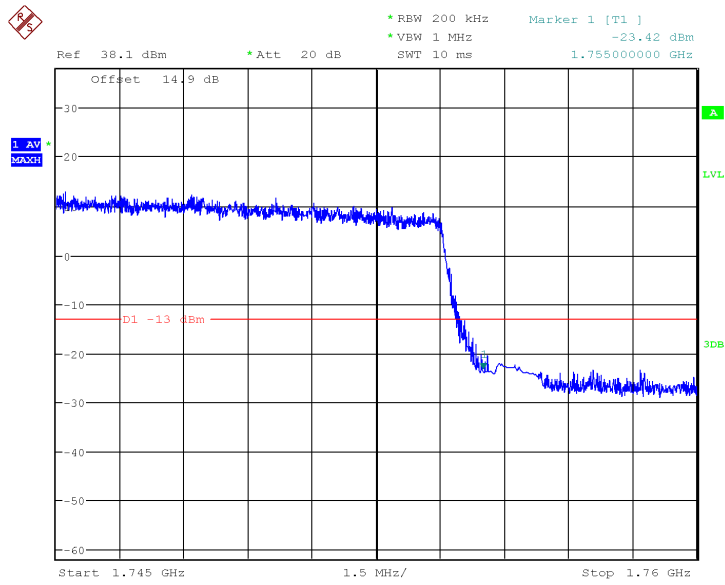

Date: 22.JUN.2017 15:41:04

LTE Band4, 20MHz bandwidth, 16QAM,100,0) Mode, Above 1755MHz

5.5.2 LTE B13 Band Edge Results

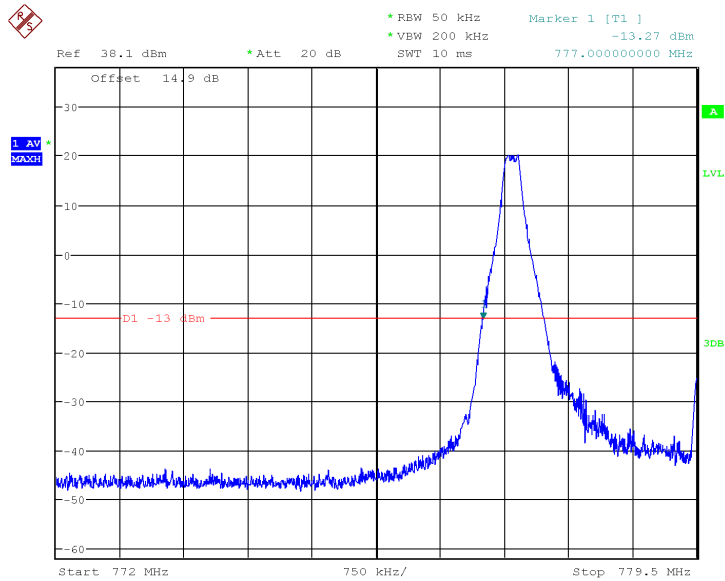

Date: 22.JUN.2017 16:38:22

LTE Band13, 5MHz bandwidth, QPSK,(1,0) Mode, Below 777MHz

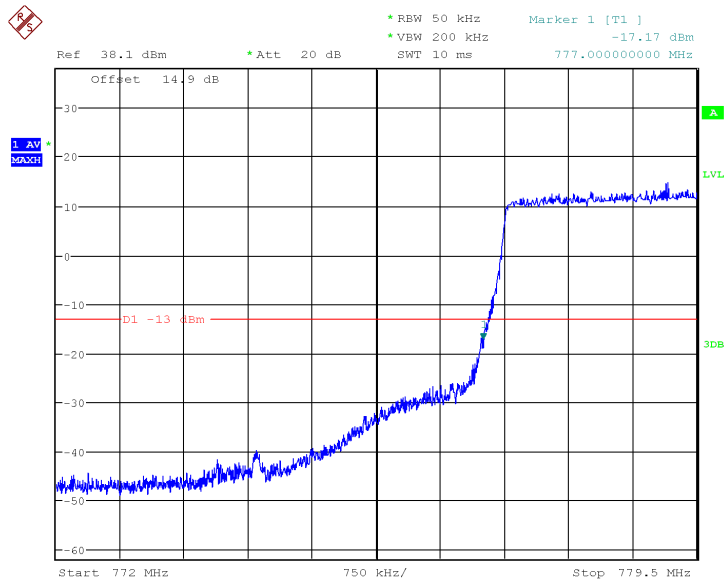

Date: 22.JUN.2017 16:40:15

LTE Band13, 5MHz bandwidth, QPSK,(25,0) Mode, Below 777MHz

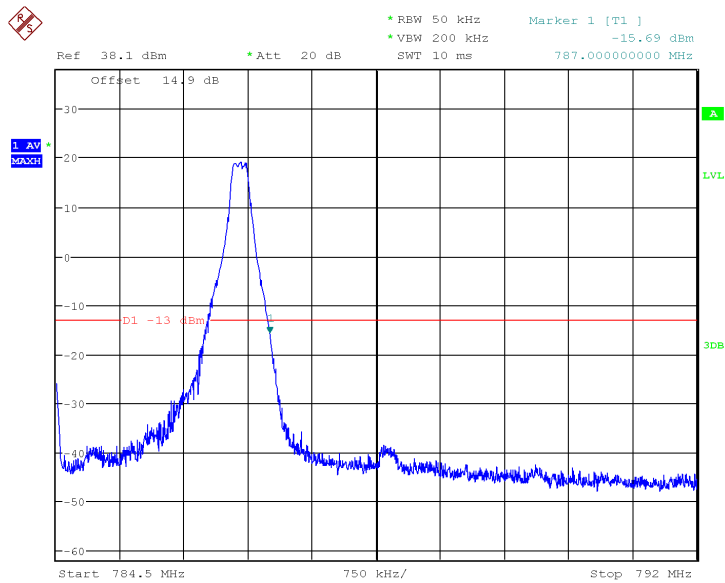

Date: 22.JUN.2017 16:55:11

LTE Band13, 5MHz bandwidth, QPSK,(1,25) Mode, Above 787MHz

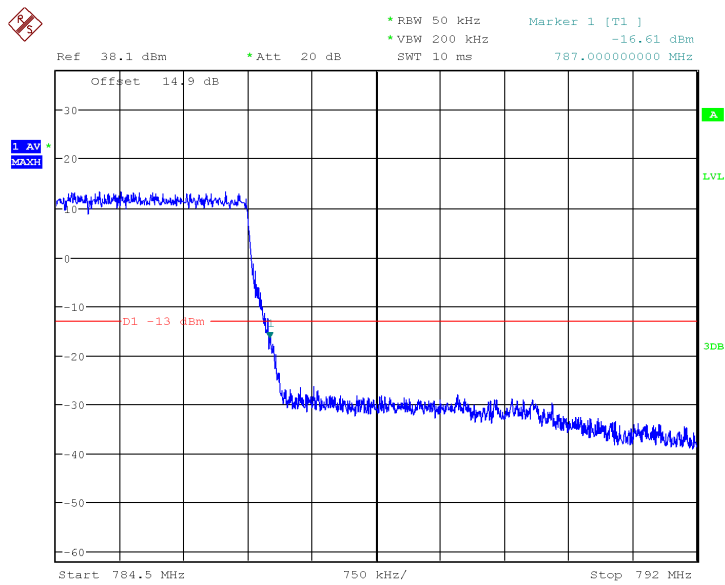

Date: 22.JUN.2017 16:56:52

LTE Band13, 5MHz bandwidth, QPSK,(25,0) Mode, Above 787MHz

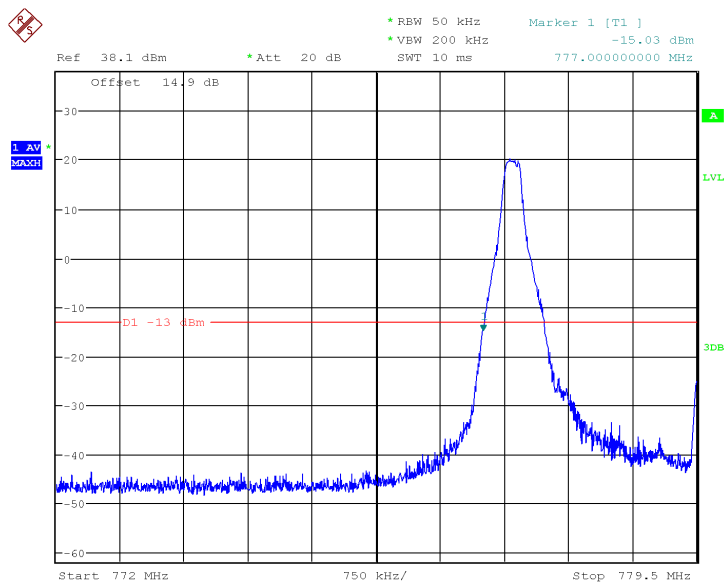

Date: 22.JUN.2017 16:39:10

LTE Band13, 5MHz bandwidth, 16QAM,(1,0) Mode, Below 777MHz

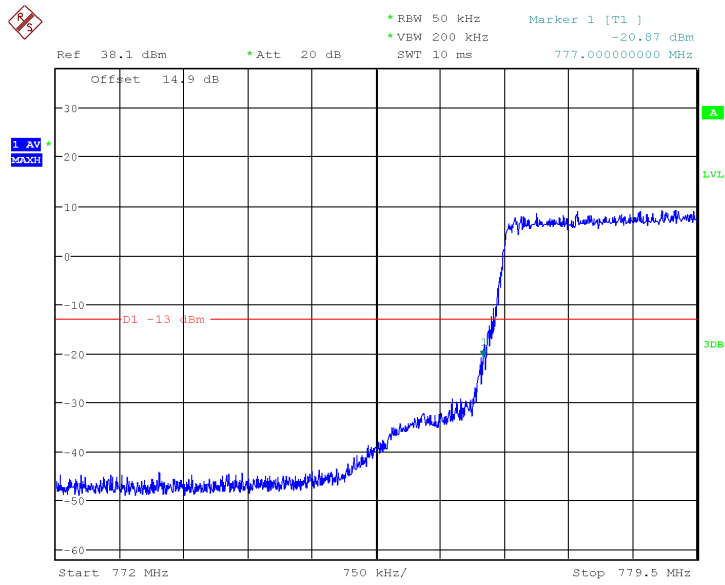

Date: 22.JUN.2017 16:39:41

LTE Band13, 5MHz bandwidth, 16QAM,(25,0) Mode , Below 777MHz

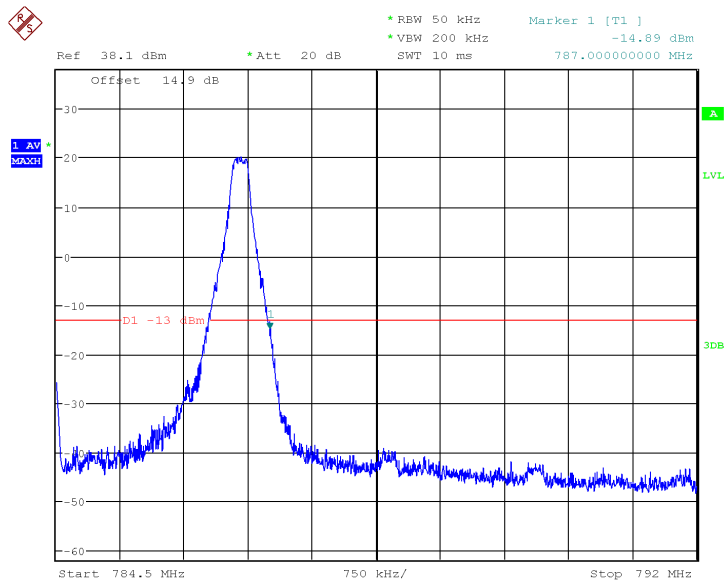

Date: 22.JUN.2017 16:55:40

LTE Band13, 5MHz bandwidth, 16QAM,(1,25) Mode , Above 787MHz

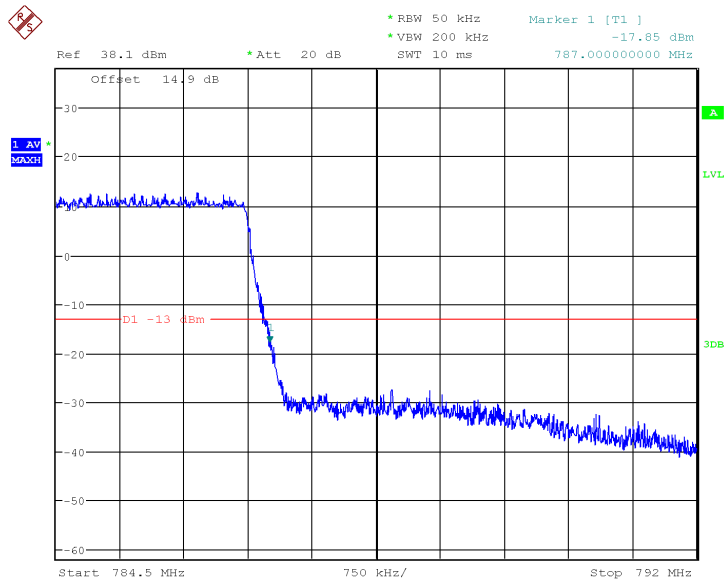

Date: 22.JUN.2017 16:56:32

LTE Band13, 5MHz bandwidth, 16QAM,(25,0) Mode, Above 787MHz

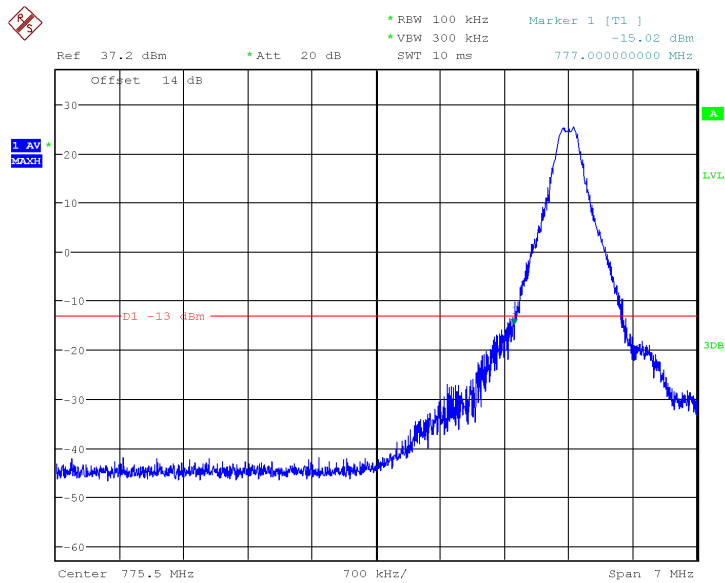

Date: 22.JUN.2017 17:22:06

LTE Band13, 10MHz bandwidth, QPSK,(1,0) Mode , Below 777MHz

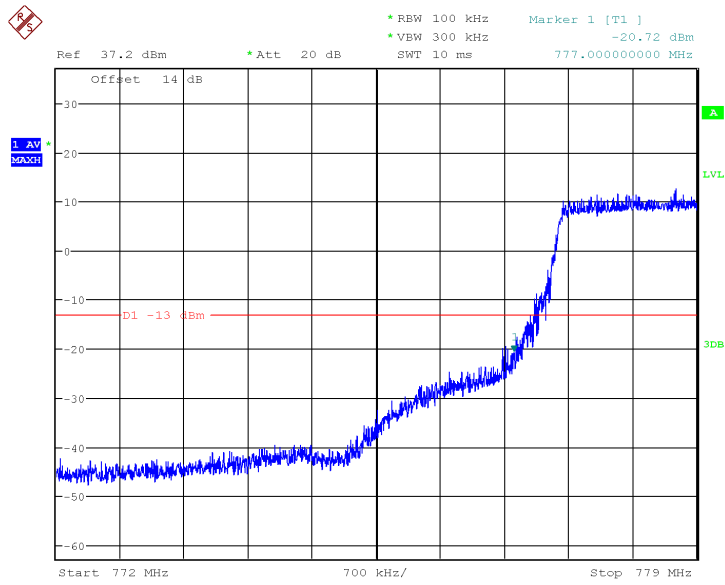

Date: 22.JUN.2017 17:23:49

LTE Band13, 10MHz bandwidth, QPSK,(50,0) Mode , Below 777MHz

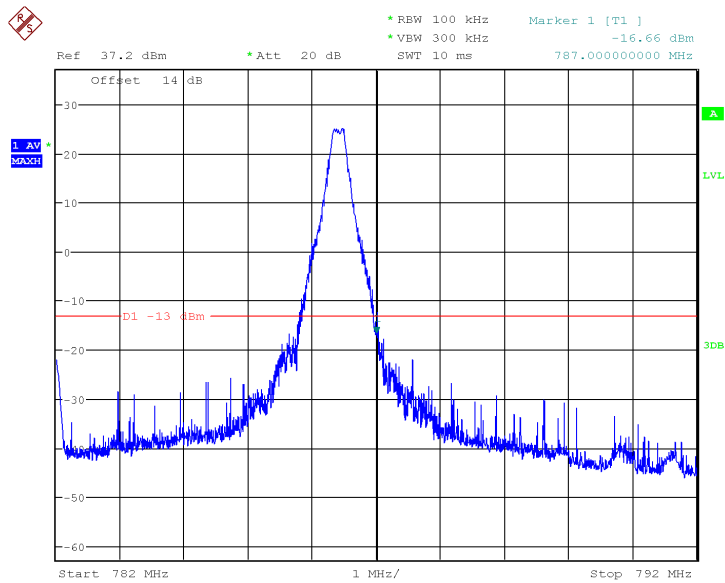

Date: 22.JUN.2017 17:17:56

LTE Band13, 10MHz bandwidth, QPSK,(1,50) Mode , Above 787MHz

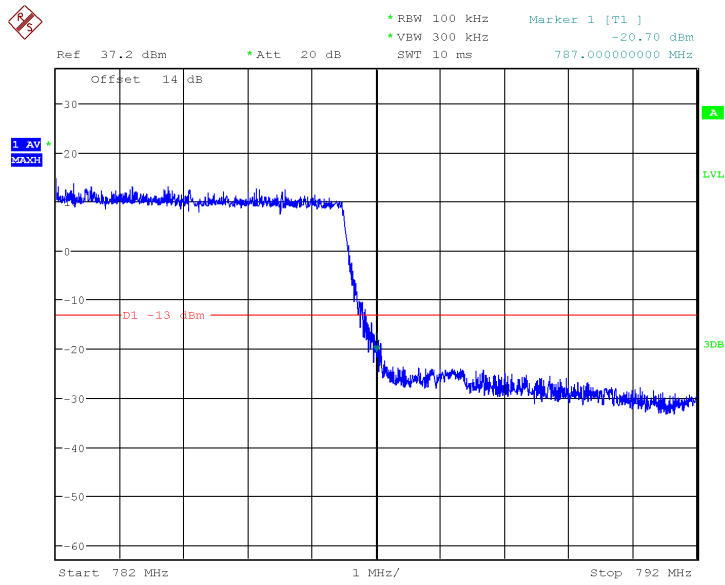

Date: 22.JUN.2017 17:19:28

LTE Band13, 10MHz bandwidth, QPSK,(50,0) Mode, Above 787MHz

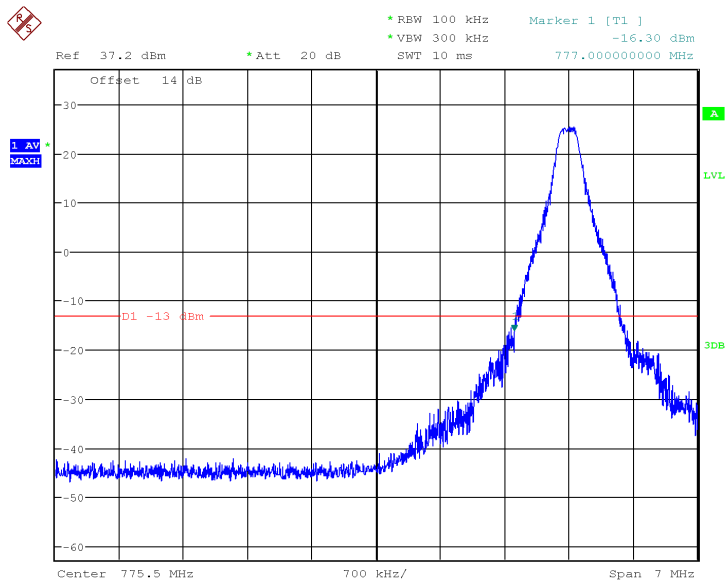

Date: 22.JUN.2017 17:22:37

LTE Band13, 10MHz bandwidth, 16QAM,(1,0) Mode, Below 777MHz

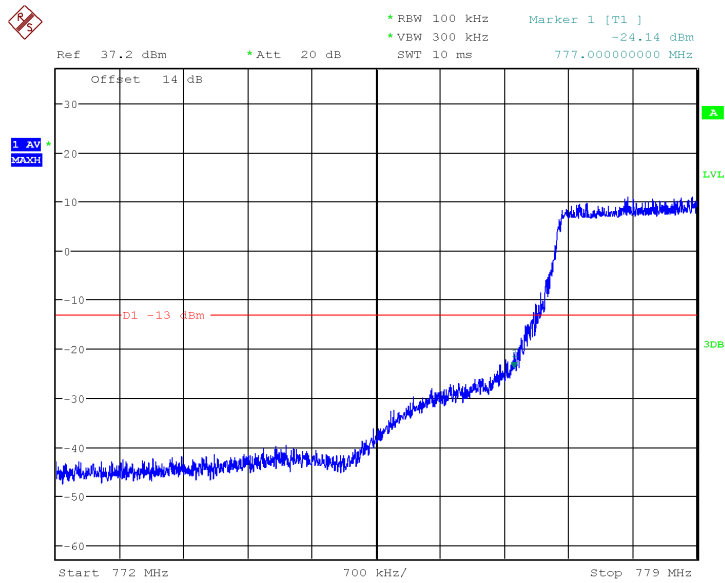

Date: 22.JUN.2017 17:23:37

LTE Band13, 10MHz bandwidth, 16QAM,(50,0) Mode , Below 777MHz

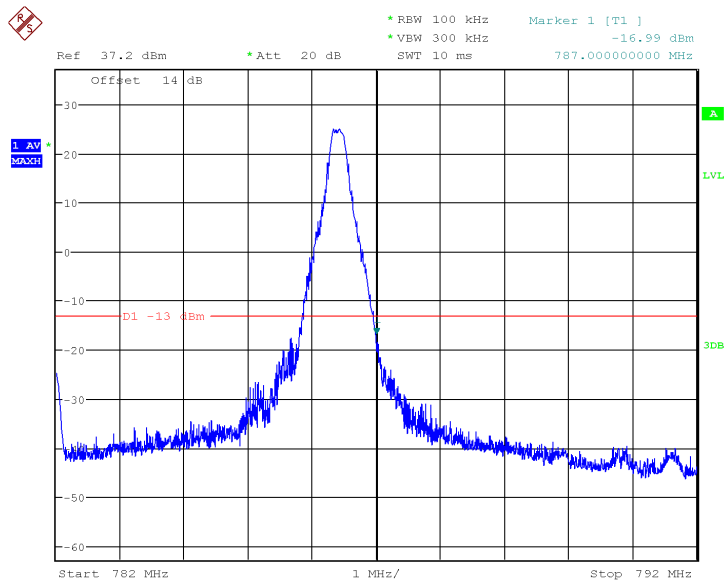

Date: 22.JUN.2017 17:18:34

LTE Band13, 10MHz bandwidth, 16QAM,(1,50) Mode, Above 787MHz

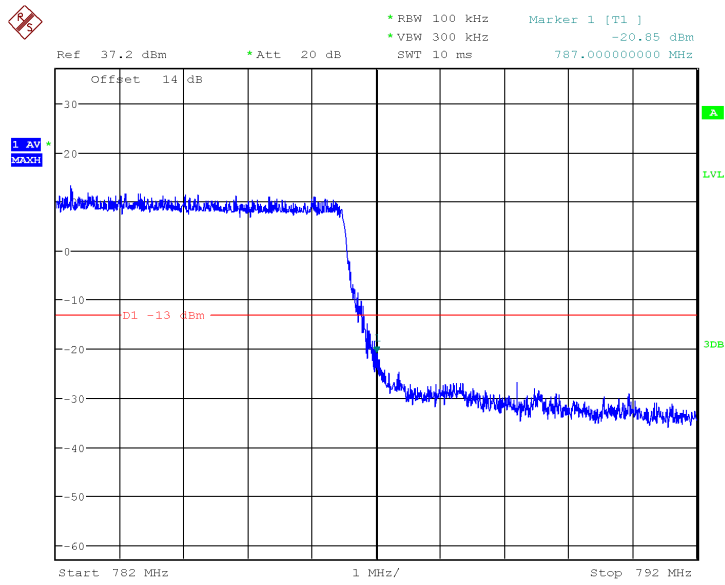

Date: 22.JUN.2017 17:19:05

LTE Band13, 10MHz bandwidth, 16QAM,(50,0) Mode, Above 787MHz

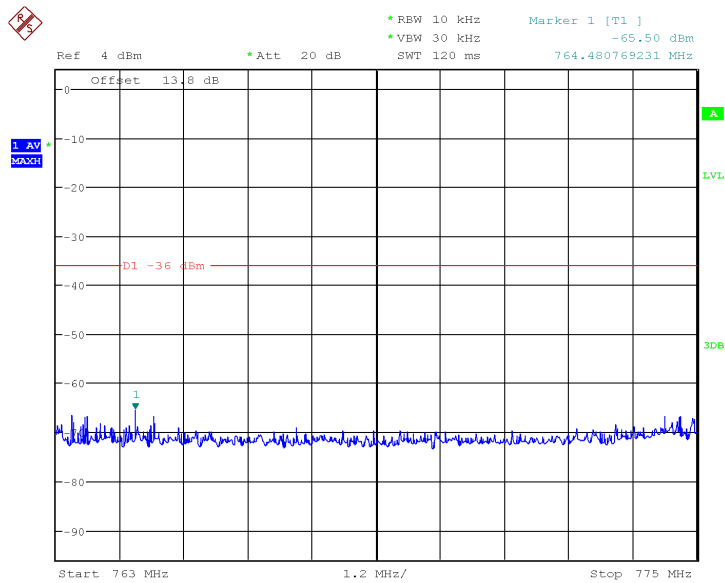

Date: 27.JUN.2017 17:33:56

LTE Band13, 5MHz bandwidth, QPSK,(1,0) Mode, 763MHz-775MHz

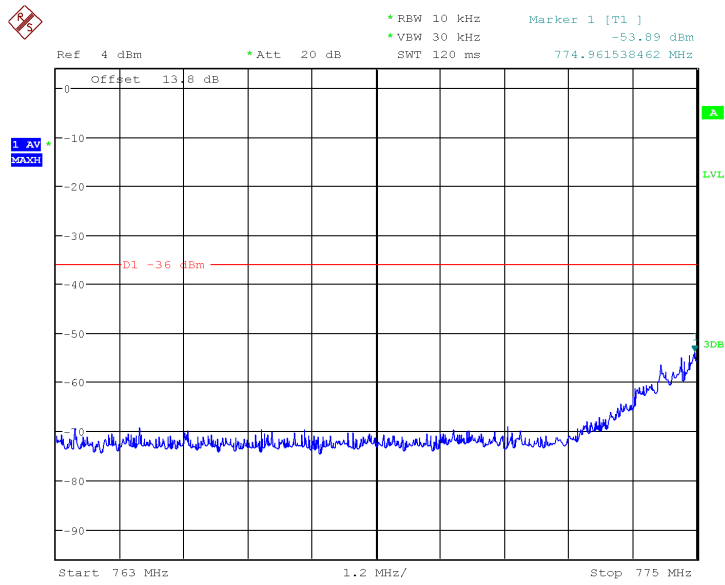

Date: 27.JUN.2017 17:34:46

LTE Band13, 5MHz bandwidth, QPSK,(25,0) Mode, 763MHz-775MHz

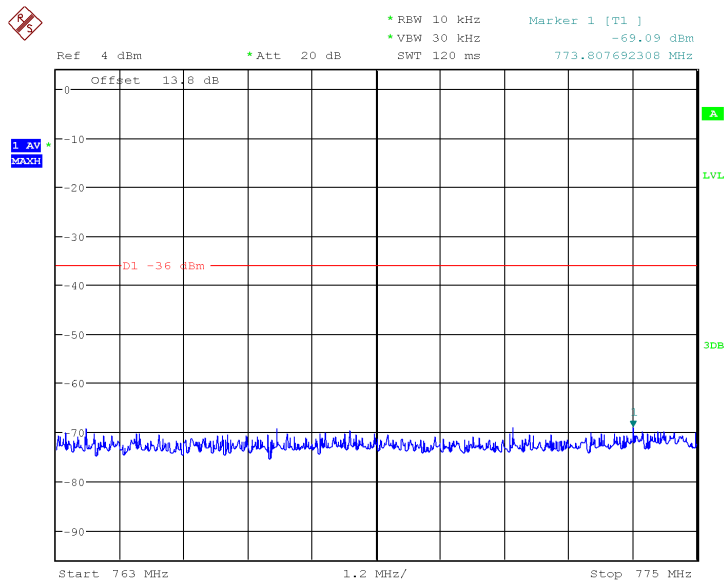

Date: 27.JUN.2017 17:35:16

LTE Band13, 5MHz bandwidth, 16QAM,(1,0) Mode, 763MHz-775MHz

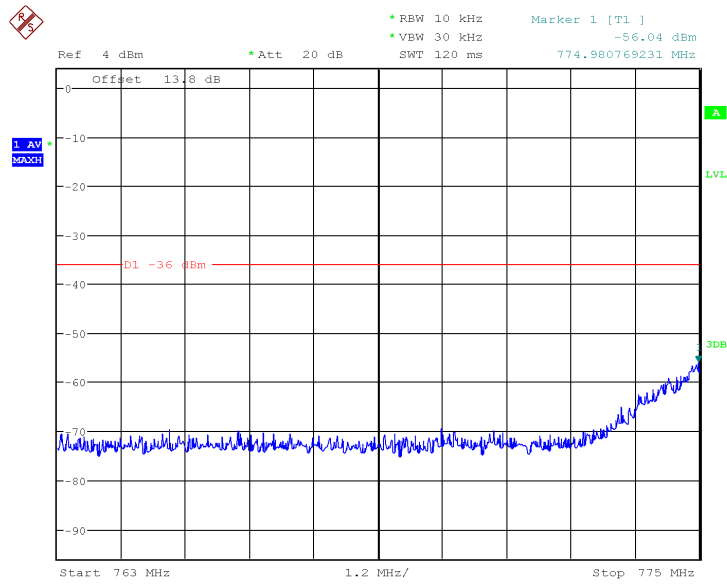

Date: 27.JUN.2017 17:34:58

LTE Band13, 5MHz bandwidth, 16QAM,(25,0) Mode, 763MHz-775MHz

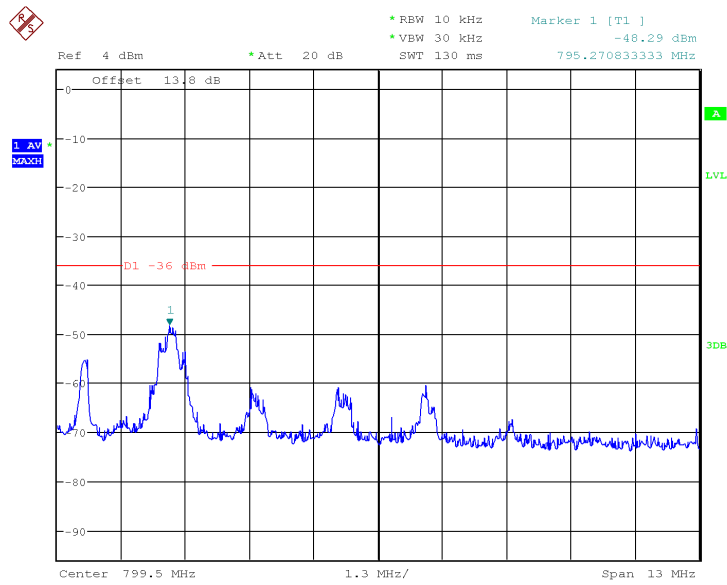

Date: 27.JUN.2017 17:44:13

LTE Band13, 5MHz bandwidth, QPSK,(1,25) Mode, 793MHz-806MHz

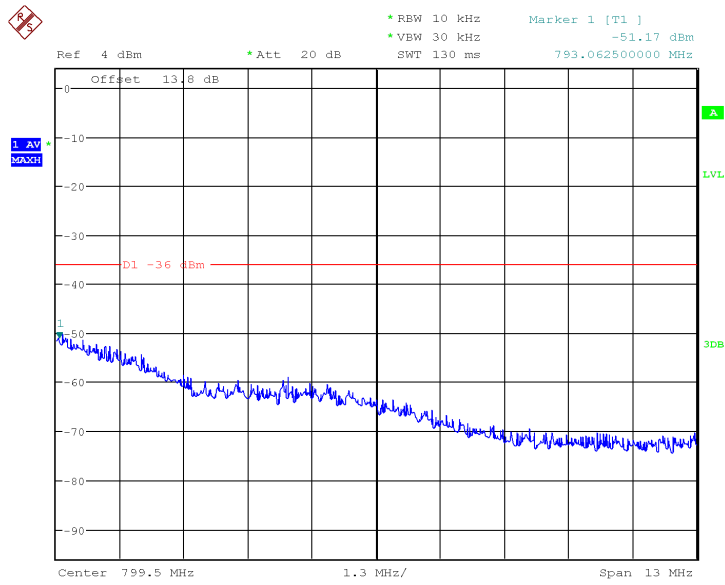

Date: 27.JUN.2017 17:43:44

LTE Band13, 5MHz bandwidth, QPSK,(25,0) Mode, 793MHz-806MHz

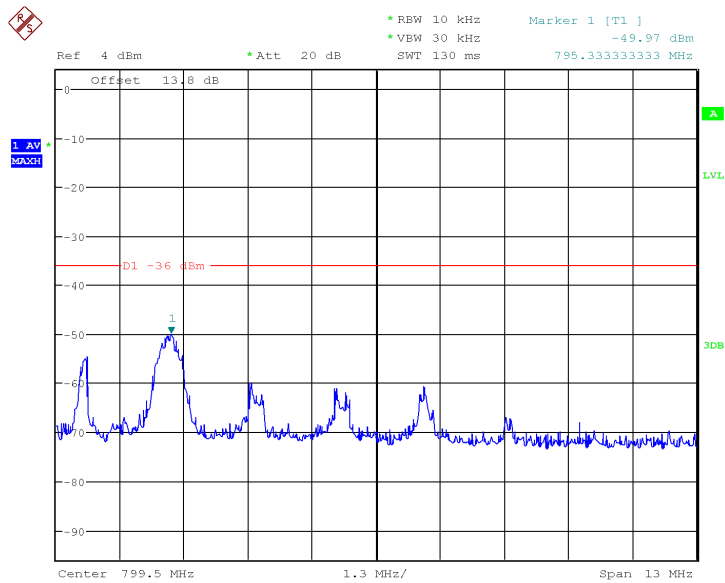

Date: 27.JUN.2017 17:43:00

LTE Band13, 5MHz bandwidth, 16QAM,(1,25) Mode, 793MHz-806MHz

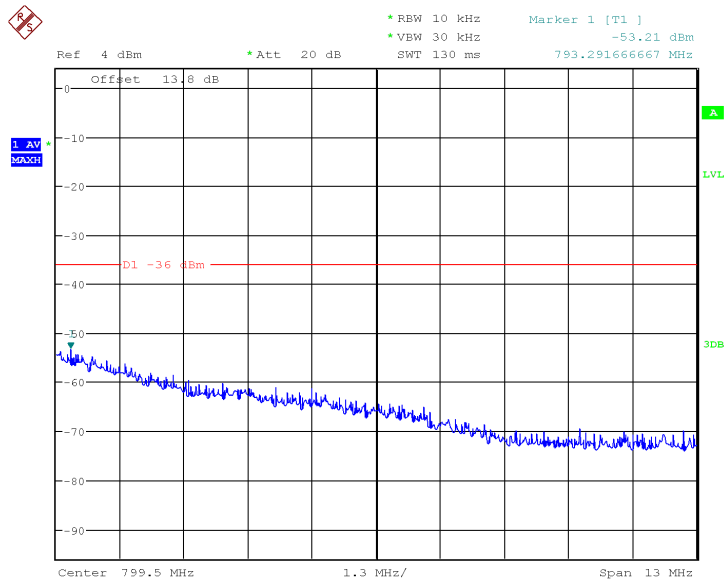

Date: 27.JUN.2017 17:43:24

LTE Band13, 5MHz bandwidth, 16QAM,(25,0) Mode, 793MHz-806MHz

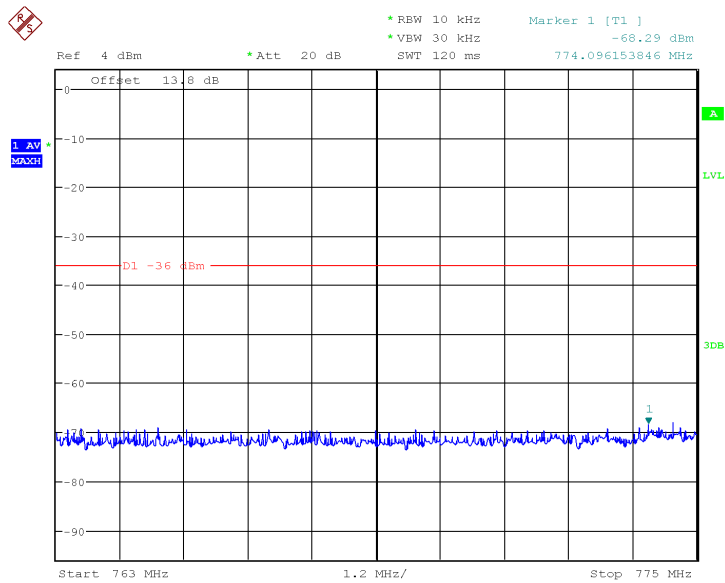

Date: 27.JUN.2017 17:36:42

LTE Band13, 10MHz bandwidth, QPSK,(1,0) Mode, 763MHz-775MHz

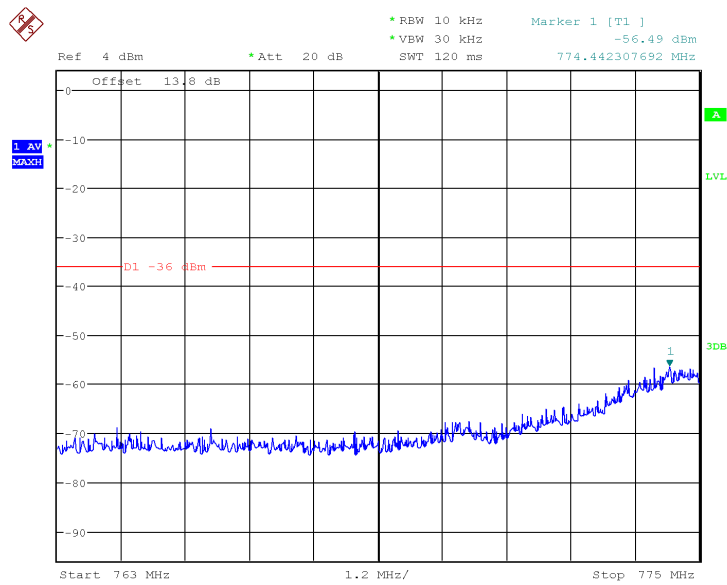

Date: 27.JUN.2017 17:36:58

LTE Band13, 10MHz bandwidth, QPSK,(50,0) Mode, 763MHz-775MHz

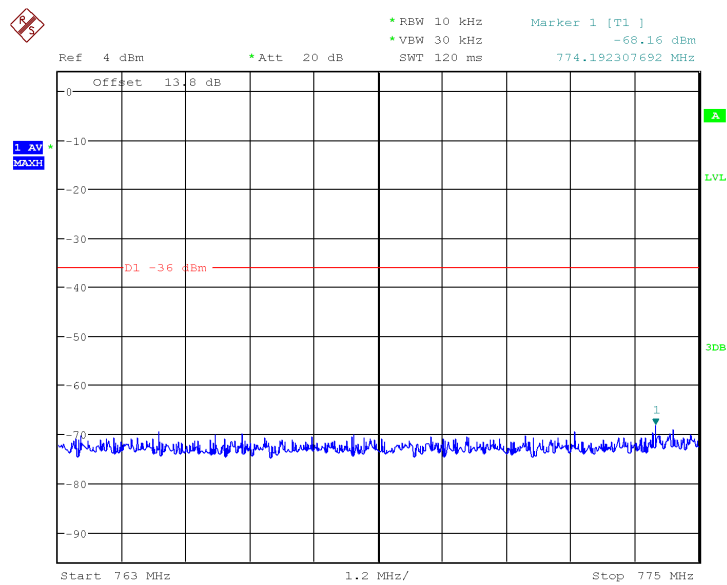

Date: 27.JUN.2017 17:37:28

LTE Band13, 10MHz bandwidth, 16QAM,(1,0) Mode, 763MHz-775MHz

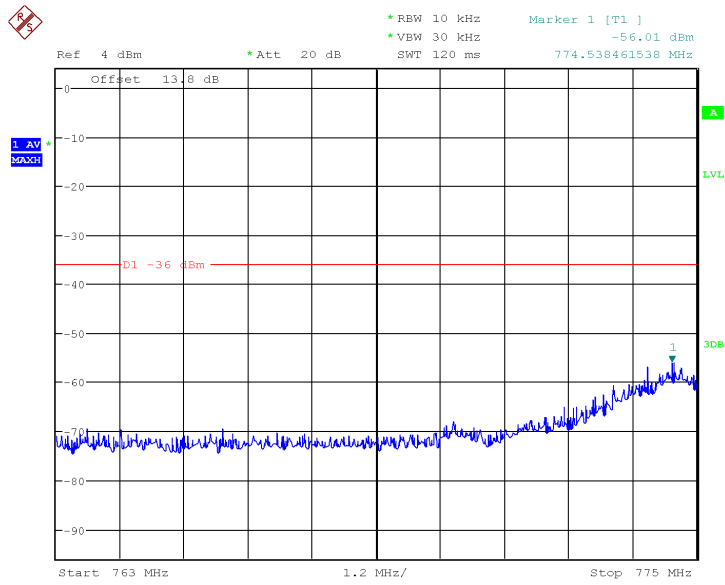

Date: 27.JUN.2017 17:37:13

LTE Band13, 10MHz bandwidth, 16QAM,(50,0) Mode, 763MHz-775MHz

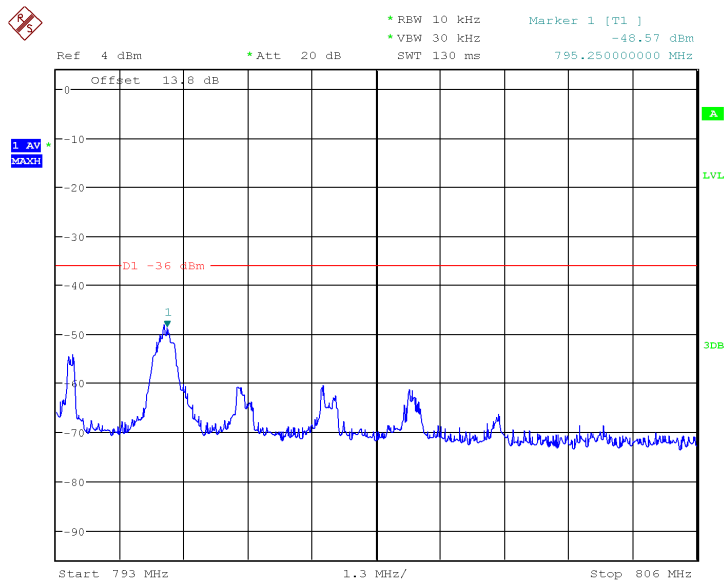

Date: 27.JUN.2017 17:42:01

LTE Band13, 10MHz bandwidth, QPSK,(1,50) Mode, 793MHz-806MHz

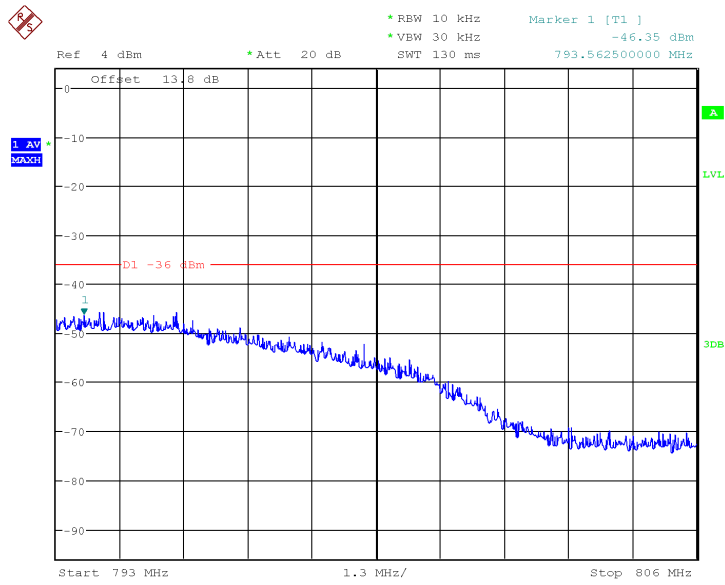

Date: 27.JUN.2017 17:41:17

LTE Band13, 10MHz bandwidth, QPSK,(50,0) Mode, 793MHz-806MHz

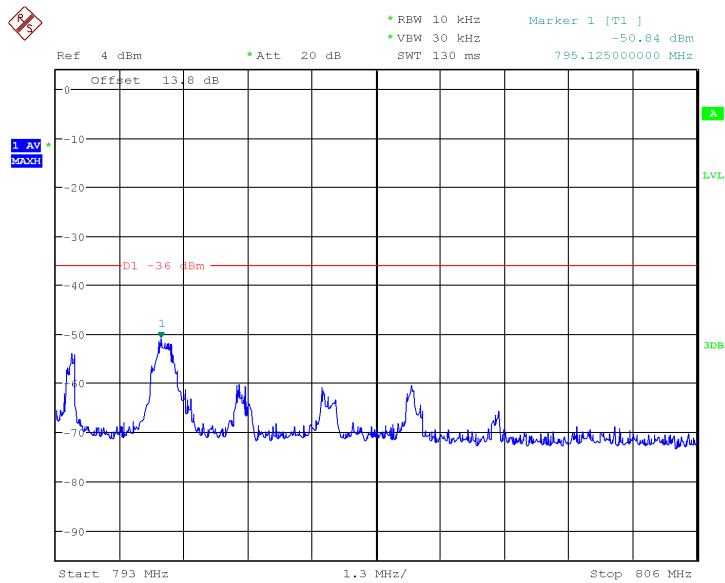

Date: 27.JUN.2017 17:40:31

LTE Band13, 10MHz bandwidth, 16QAM,(1,50) Mode, 793MHz-806MHz



5.6 Frequency Stability over Temperature Variation

Specifications:	FCC Part 2.1055, 27.54 RSS-130 4.3, RSS-139 6.4
DUT Serial Number:	S1: U1708470300603
Test conditions:	Ambient Temperature:15°C-35°C Relative Humidity:30%-60% Air pressure: 86-106kPa
Test Results:	--

Limit	
Frequency deviation[ppm]	±2.5

Test Setup

The EUT was placed in a temperature chamber, demonstrated as figure T. The Wireless Telecommunications Test Set was used to set the Tx channel and power level, modulate the TX signal with different bit patterns and measure the frequency of Tx.

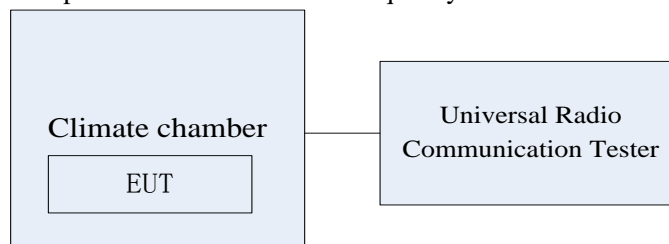

Test Method

- 1、 The EUT was turned off and placed in the temperature chamber.
- 2、 The temperature of the chamber was set to -30°C and allowed to stabilize.
- 3、 The EUT temperature was allowed to stabilize for 45 minutes.
- 4、 The EUT was turned on and set to transmit with Wireless Telecommunications Test Set.
- 5、 The maximum transmit frequency deviation during one minute period was measured by Wireless Communications Test Set.
- 6、 The steps 3-5 were repeated for -30°C,-20°C, -10°C, 0°C, 10°C, 20°C, 30°C, 40°C and 50°C.

5.6.1 LTE Band Frequency Stability over Temperature Variation Results

Band	Offset	Temperature[°C]								
		-30	-20	-10	0	10	20	30	40	50
4	Hz	-1.56	-3.06	-0.76	-1.19	-1.07	-2.70	-2.69	2.85	2.89
	ppm	0.0009	0.0018	0.0004	0.0007	0.0006	0.0016	0.0016	0.0016	0.0017
13	Hz	-0.59	-1.07	0.56	-0.10	0.30	0.97	-0.69	0.83	0.40
	ppm	0.0008	0.0014	0.0007	0.0001	0.0004	0.0012	0.0009	0.0011	0.0005



5.7 Frequency Stability over Voltage Variation

Specifications:	FCC Part 2.1055, 27.54 RSS-130 4.3, RSS-139 6.4
DUT Serial Number:	S1: U1708470300603
Test conditions:	Ambient Temperature:15°C-35°C Relative Humidity:30%-60% Air pressure: 86-106kPa
Test Results:	--

Limit	
Frequency deviation[ppm]	±2.5

Test Setup

The EUT was placed in a shielding chamber and powered by an adjustable power supply, demonstrated as figure V. A Wireless Telecommunications Test Set was used to set the TX channel and power level, modulate the TX signal with different bit patterns and measure the frequency of TX.

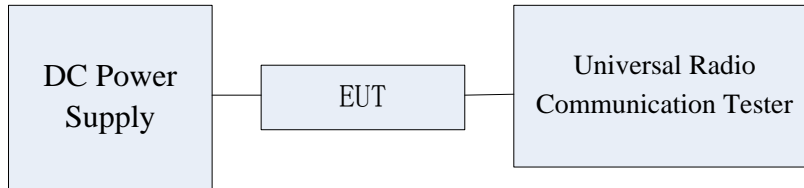

Test Method

The EUT was powered by the adjustable power supply. The frequency stability is measured by the Wireless Telecommunications Test Set.

5.7.1 LTE Band Frequency Stability over Voltage Variation Results

Test data:

Band	Offset	Voltage (V)		
		3.4	3.7	4.3
4	Hz	2.49	2.43	3.13
	ppm	0.0014	0.0014	0.0018
13	Hz	1.19	1.02	0.70
	ppm	0.0015	0.0013	0.0009



5.8 Peak to Average Ratio

Specifications:	FCC Part 27.50, RSS-130 4.4
DUT Serial Number:	S1: U1708470300603
Test conditions:	Ambient Temperature:15°C-35°C Relative Humidity:30%-60% Air pressure: 86-106kPa
Test Results:	--

Limit

The EUT meets the requirement of having a peak to average ratio of less than 13dB.

Test Setup

During the test, the EUT was controlled via the Wireless Communications Test Set to ensure max power transmission and proper modulation and measured by spectrum analyzer.

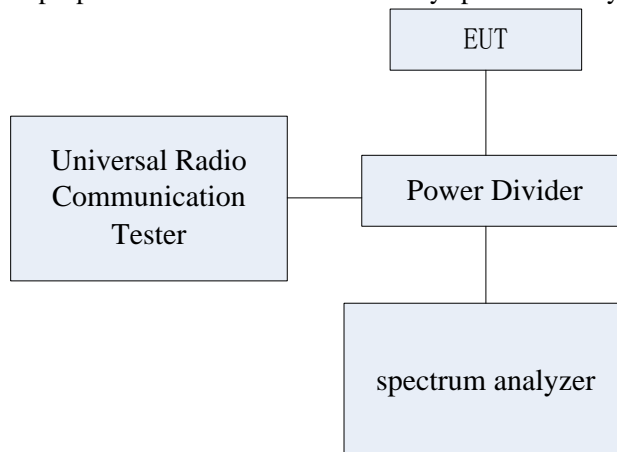

Test Method

The transmitter output was connected to a CMW500 through a coaxial RF cable and directional coupler, and configured to operate at maximum power. The peak to average ratio was measured at the required operating frequencies in each band on the Spectrum Analyzer.

5.8.1 LTE B4 Peak to Average Ratio Results

Frequency (MHz)	EUT channel No.	bandwidth	Modulation	Peak to Average Ratio
1732.5MHz	20175	10MHz	QPSK	5.28
			16QAM	5.23

5.8.2 LTE B13 Peak to Average Ratio Results

Frequency (MHz)	EUT channel No.	bandwidth	Modulation	Peak to Average Ratio
782MHz	23230	10MHz	QPSK	4.77
			16QAM	5.07



Graphical for Peak to Average Ratio Results

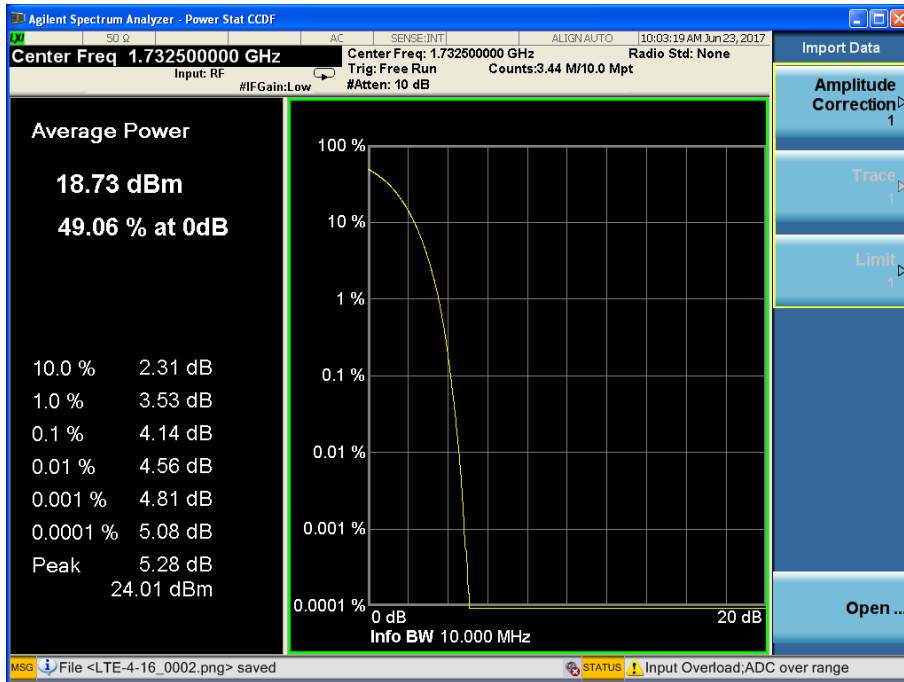

LTE Band4, QPSK

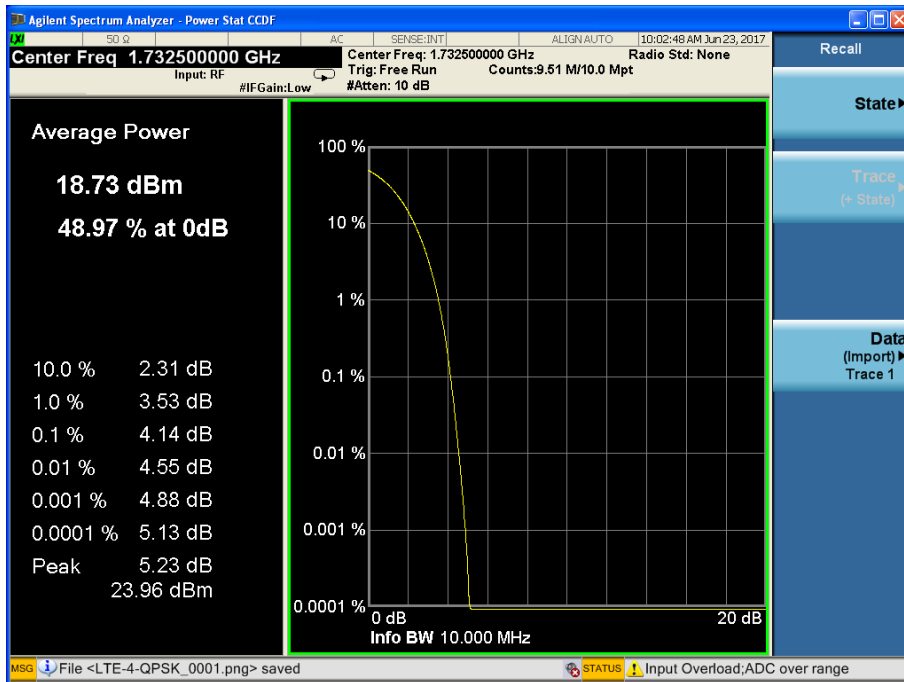

LTE Band4, 16QAM

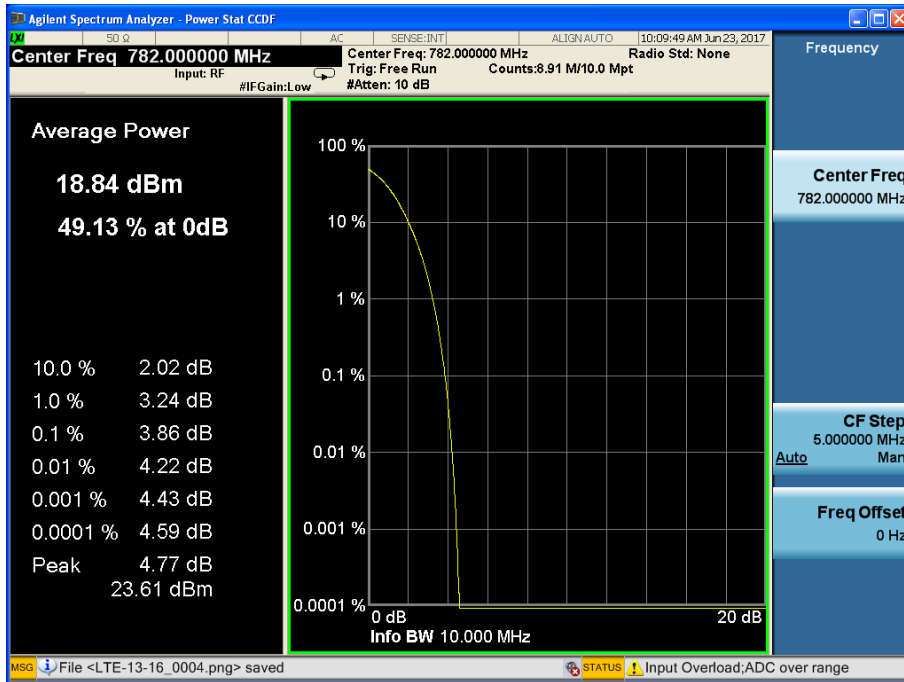

LTE Band13, QPSK

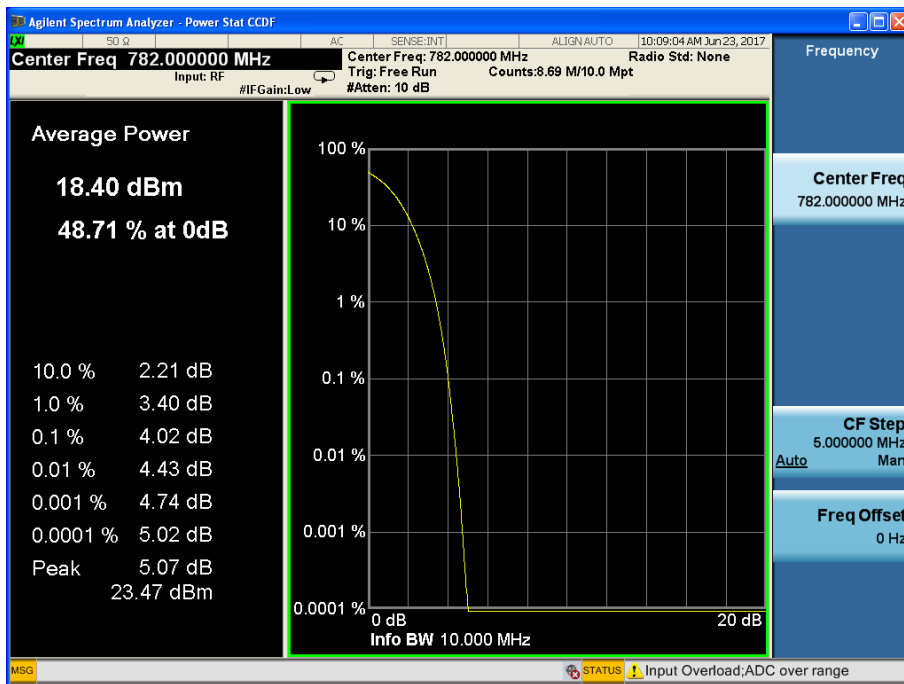

LTE Band13, 16QAM



Annex A EUT Photos

See the document "WP7601-Internal Photos".



ANNEX B Deviations from Prescribed Test Methods

No deviation from Prescribed Test Methods.

*****End Of Report*****