



USB306 Modem

Test Report

FOR

FCC and IC Certifications

IC: 2417C-U306
FCC ID: N7NU306

© 2009 Sierra Wireless, Inc.

This document contains information which is proprietary and confidential to Sierra Wireless, Inc. Disclosure to persons other than the officers, employees, agents, or subcontractors of the Company or licensee of this document without the prior written permission of Sierra Wireless, Inc. is strictly prohibited.

SIERRA WIRELESS, INC.

| | | | |
|--------------------------------|--------|---------------|--------------|
| FCC Part 22, 24 / RSS 132, 133 | USB306 | June 18, 2009 | Page 2 of 74 |
|--------------------------------|--------|---------------|--------------|

Table of Contents

| | | |
|-------|--|----|
| 1 | Introduction and Purpose..... | 4 |
| 2 | Test Summary | 4 |
| 3 | Description of Equipment Under Test | 4 |
| 4 | RF Power Output | 5 |
| 4.1 | Test Procedure | 5 |
| 4.2 | Test Equipment..... | 5 |
| 4.3 | Test Results GSM/EDGE (GMSK: MCS4; 8-PSK: MCS9) | 6 |
| 4.4 | Test Results UMTS..... | 6 |
| 4.4.1 | Test 1: RF Output Power Results for WCDMA R99..... | 6 |
| 4.4.2 | Test 2: RF Output Power Results for HSDPA Rel6 | 7 |
| 4.4.3 | Test 3: RF Output Power Results for HSPA (HSDPA & HSUPA) Rel6..... | 9 |
| 4.5 | Test Settings for UMTS Mode on CMU200..... | 11 |
| 5 | Occupied Bandwidth..... | 15 |
| 5.1 | Test Procedure | 15 |
| 5.2 | Test Equipment..... | 15 |
| 5.3 | Test Results | 15 |
| 5.3.1 | GSM Results | 16 |
| 5.3.2 | WCDMA Results | 16 |
| 5.4 | Test Plots..... | 17 |
| 6 | Out of Band Emissions at Antenna Terminals | 26 |
| 6.1 | Test Procedure | 26 |
| 6.2 | Test Equipment..... | 26 |
| 6.3 | Test Results | 26 |
| 6.4 | Test Plots..... | 28 |
| 7 | Block Edge Compliance..... | 64 |
| 7.1 | Test Procedure | 64 |
| 7.2 | Test Equipment..... | 64 |
| 7.3 | Test Results | 64 |
| 7.4 | Test Plots..... | 65 |
| 8 | Frequency Stability Versus Temperature..... | 71 |
| 8.1 | Summary of Results..... | 71 |
| 8.2 | Test Procedure | 71 |
| 8.3 | Test Equipment..... | 71 |
| 8.4 | Test Results | 72 |
| 8.4.1 | GSM Frequency Error over Temperature | 72 |
| 8.4.2 | UMTS Frequency Error over Temperature | 72 |
| 9 | Frequency Stability Versus Voltage | 73 |
| 9.1 | Summary of Results..... | 73 |
| 9.2 | Test Procedure | 73 |
| 9.3 | Test Equipment..... | 73 |
| 9.4 | Test Results | 74 |

© 2009 Sierra Wireless, Inc.

The contents of this page are subject to the confidentiality information on page one.

SIERRA WIRELESS, INC.

| | | | |
|--------------------------------|--------|---------------|--------------|
| FCC Part 22, 24 / RSS 132, 133 | USB306 | June 18, 2009 | Page 3 of 74 |
|--------------------------------|--------|---------------|--------------|

9.4.1 *GSM Frequency Error over Voltage*..... 74
9.4.2 *UMTS Frequency Error over Voltage* 74

SIERRA WIRELESS, INC.

| | | | |
|--------------------------------|--------|---------------|--------------|
| FCC Part 22, 24 / RSS 132, 133 | USB306 | June 18, 2009 | Page 4 of 74 |
|--------------------------------|--------|---------------|--------------|

1 Introduction and Purpose

This document provides test data for the USB306 modem intended for FCC and Industry Canada certifications. The tests included in this report are limited to all conducted tests required. The radiated tests were performed at an external test facility.

2 Test Summary

| FCC Rule | IC Standards | DESCRIPTION OF TEST | RESULT | PAGE |
|--|------------------------------|---|----------|-------------------|
| 2.1046 | RSS-132, 4.4 RSS-133, 6.4 | RF Power Output | Complies | 5 |
| 2.1049 | RSS-Gen, 4.6 | Occupied Bandwidth | Complies | 15 |
| 2.1051, 22.901(d) 22.917, 24.238(a) | RSS-132, 4.5 RSS-133, 6.5 | Out of Band Emissions at Antenna Terminals | Complies | 26 |
| 2.1053 | RSS-132, 4.5 RSS-133, 6.5 | Field Strength of Spurious Radiation | Complies | See CCS Report |
| 2.1055 | RSS-132, 4.3 RSS-133, 6.3 | Frequency Stability versus Temperature | Complies | 71 |
| 2.1055 | RSS-132, 4.3 RSS-133, 6.3 | Frequency Stability versus Voltage | Complies | 73 |

3 Description of Equipment Under Test

The USB306 modem (referred to as "EUT" hereafter) is a multi-band wireless modem operating on the GSM/GPRS/EDGE/UMTS network. In the US and Canada, only cellular and PCS bands are used for GSM/GPRS/UMTS operation, so this test report only contains data for these two bands (850MHz and 1900MHz).

SIERRA WIRELESS, INC.

4 RF Power Output

FCC 2.1046

4.1 Test Procedure

The transmitter output was connected to a Rohde & Schwarz CMU200 Test Set and configured to operate at maximum power in a call. The power was measured using the spectrum analyzer at three equally spaced operating frequencies for each band. The RBW was set to 300 KHz for the GSM and EDGE measurements and 5MHz for the WCDMA measurements. The spectrum analyzer was set to measure the RF output power with the cable and coupler losses accounted for.

Test Setup

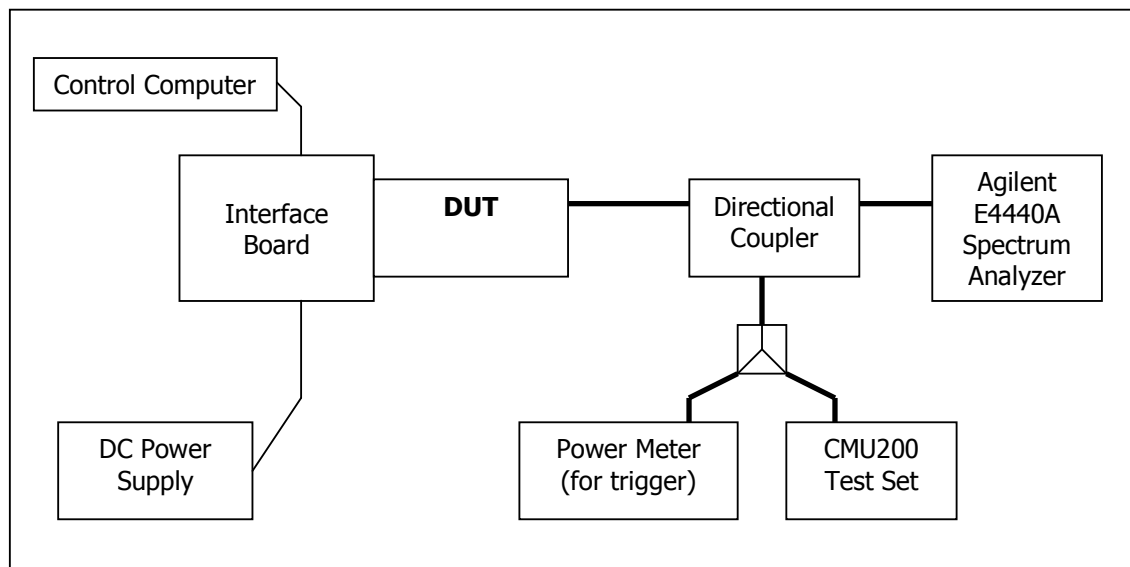

4.2 Test Equipment

| EQUIPMENT | MANUFACTURER | MODEL NO. | SERIAL NO. | CAL. DATE |
|---------------------|-----------------|------------|------------|-------------------|
| Control Computer | TC | Generic PC | 100488 | N/A |
| Wireless Test Set | Rohde & Schwarz | CMU200 | 110520 | November 17, 2009 |
| Spectrum Analyzer | Rohde & Schwarz | FSP | 100060 | November 15, 2009 |
| DC Power Supply | HP | 6632A | 3530A | N/A |
| Interface Board | Shop built | ATEMux | N/A | N/A |
| Directional Coupler | Pasternack | PE2209-10 | N/A | N/A |

© 2009 Sierra Wireless, Inc.

The contents of this page are subject to the confidentiality information on page one.

SIERRA WIRELESS, INC.

| | | | |
|--------------------------------|--------|---------------|--------------|
| FCC Part 22, 24 / RSS 132, 133 | USB306 | June 18, 2009 | Page 6 of 74 |
|--------------------------------|--------|---------------|--------------|

4.3 Test Results GSM/EDGE (GMSK: MCS4; 8-PSK: MCS9)

| Frequency (MHz) | Channel | GMSK Mode | | | | | | | |
|-----------------|---------|-----------------|------------------|-----------------|------------------|-----------------|------------------|-----------------|------------------|
| | | 1 Time Slot | | 2 Time Slots | | 3 Time Slots | | 4 Time Slots | |
| | | RMS Power (dBm) | Peak Power (dBm) | RMS Power (dBm) | Peak Power (dBm) | RMS Power (dBm) | Peak Power (dBm) | RMS Power (dBm) | Peak Power (dBm) |
| 824.2 | 128 | 31.8 | 31.9 | 29.1 | 29.2 | 27.2 | 27.3 | 25.8 | 26.0 |
| 836.6 | 190 | 31.6 | 31.8 | 28.6 | 28.7 | 27.1 | 27.2 | 25.9 | 26.1 |
| 848.8 | 251 | 31.8 | 31.9 | 28.9 | 29.1 | 27.0 | 27.1 | 25.7 | 25.9 |
| 1850.2 | 512 | 29.3 | 29.4 | 25.9 | 26.1 | 24.2 | 24.3 | 23.1 | 23.2 |
| 1880.0 | 661 | 28.9 | 29.1 | 26.1 | 26.2 | 24.2 | 24.4 | 23.0 | 23.2 |
| 1909.8 | 810 | 28.9 | 28.9 | 25.7 | 25.8 | 24.0 | 24.1 | 22.8 | 22.9 |

| Frequency (MHz) | Channel | 8-PSK Mode | | | | | | | |
|-----------------|---------|-----------------|------------------|-----------------|------------------|-----------------|------------------|-----------------|------------------|
| | | 1 Time Slot | | 2 Time Slots | | 3 Time Slots | | 4 Time Slots | |
| | | RMS Power (dBm) | Peak Power (dBm) | RMS Power (dBm) | Peak Power (dBm) | RMS Power (dBm) | Peak Power (dBm) | RMS Power (dBm) | Peak Power (dBm) |
| 824.2 | 128 | 27.1 | 29.9 | 27.1 | 30.2 | 27.0 | 30.1 | 25.7 | 28.8 |
| 836.6 | 190 | 26.8 | 29.6 | 27.2 | 30.2 | 27.1 | 30.2 | 25.8 | 29.0 |
| 848.8 | 251 | 27.0 | 29.9 | 27.1 | 30.1 | 27.0 | 30.1 | 25.6 | 28.7 |
| 1850.2 | 512 | 26.1 | 28.8 | 26.0 | 28.9 | 23.2 | 26.1 | 22.1 | 25.2 |
| 1880.0 | 661 | 26.1 | 28.7 | 26.1 | 28.8 | 23.0 | 26.2 | 22.2 | 25.1 |
| 1909.8 | 810 | 26.2 | 28.8 | 26.1 | 28.8 | 23.0 | 26.1 | 22.1 | 25.2 |

4.4 Test Results UMTS

4.4.1 Test 1: RF Output Power Results for WCDMA R99

The following tests were completed according to the test requirements outlined in section 5.2 of the 3GPP TS34.121-1 V7.5.0 specification. The EUT supports power Class 3, which has a nominal maximum output power of 24 dBm (+1.7/-3.7). RMC 12.2kps is used for this testing.

The test was performed according to section 5.2 of the 3GPP TS34.121-1 V7.5.

| Frequency (MHz) | Channel | WCDMA R99 | |
|-----------------|---------|-----------------|------------------|
| | | RMS Power (dBm) | Peak Power (dBm) |
| 826.4 | 4132 | 22.71 | 25.90 |
| 836.4 | 4182 | 22.78 | 25.80 |
| 846.6 | 4233 | 22.82 | 25.86 |
| 1852.4 | 9262 | 21.68 | 25.22 |
| 1880.0 | 9400 | 21.78 | 25.32 |
| 1907.6 | 9538 | 21.78 | 25.27 |

Note: The results above reflect max power with all up bits.

SIERRA WIRELESS, INC.

| | | | |
|--------------------------------|--------|---------------|--------------|
| FCC Part 22, 24 / RSS 132, 133 | USB306 | June 18, 2009 | Page 7 of 74 |
|--------------------------------|--------|---------------|--------------|

4.4.2 Test 2: RF Output Power Results for HSDPA Rel6

The EUT supports Category 8 FDD HS-DSCH physical layer. As stated in the 3GPP TS25.306 V7.3.0 Table 5.1a, the details of Category 8 are as follows:

- Maximum of 10 E-DSCH received codes
- Minimum 1 inter-TTI interval
- Maximum 14411bits in an E-DSCH transport block received within an E-DSCH TTI
- Total number of soft channel bits is 134400
- Support of QPSK and 16QAM

A detailed list of all settings used is included 4.5.

The following Sub-Tests were completed according to the test requirements outlined in section 5.2A of the 3GPP TS34.121-1 V7.5.0 specification. All TX RMS and Peak power requirements for Power Class 3 were met according to table 5.2AA.5 and achieved through the outlined test procedure in section 5.2AA.4.2. All UE channels and power ratio's are set according to table C10.1.4 in the 3GPP TS34.121-1 V7.5.0 specification. A summary of these settings are illustrated below:

| Subtest | Mode | Call Type | RMC (kbps) | HSDPA FRC | Power Class 3 Max Limit dBm | β_c/β_d | β_{hs} | CM (db) | MPR (db) |
|---------|-------|-----------|------------|--------------|-----------------------------|-------------------|--------------|---------|----------|
| 1 | HSDPA | PS | 12.2 | H-Set 1 QPSK | 24 (+1.7/-3.7 db) | 2 /15 | 4/15 | 0.0 | 0.0 |
| 2 | HSDPA | PS | 12.2 | H-Set 1 QPSK | 24 (+1.7/-3.7 db) | 12 /15 | 24/15 | 1.0 | 0.0 |
| 3 | HSDPA | PS | 12.2 | H-Set 1 QPSK | 23.5 (+2.2/-3.7 db) | 15 /8 | 30/15 | 1.5 | 0.5 |
| 4 | HSDPA | PS | 12.2 | H-Set 1 QPSK | 23.5 (+2.2/-3.7 db) | 15 /4 | 30/15 | 1.5 | 0.5 |

Note: The recommended HSDPA MPRs are implemented as per following sub-tests.

4.4.2.1 Sub-Test 1

$\beta_c=2/15$, $\beta_d=15/15$, $\beta_{hs}=4/15$. MPR=0dB translates the min. and max. power limits to 20.3dBm and 25.7dBm respectively.

| Frequency (MHz) | Channel | Power (dBm) | Comments |
|-----------------|---------|------------------------------------|----------|
| | | 20.3dBm<Measured RMS (dBm)<25.7dBm | |
| 826.4 | 4132 | 22.65 | Pass |
| 836.4 | 4182 | 22.68 | Pass |
| 846.6 | 4233 | 22.80 | Pass |
| 1852.4 | 9262 | 21.42 | Pass |
| 1880.0 | 9400 | 21.30 | Pass |
| 1907.6 | 9538 | 21.15 | Pass |

© 2009 Sierra Wireless, Inc.

The contents of this page are subject to the confidentiality information on page one.

SIERRA WIRELESS, INC.

| | | | |
|--------------------------------|--------|---------------|--------------|
| FCC Part 22, 24 / RSS 132, 133 | USB306 | June 18, 2009 | Page 8 of 74 |
|--------------------------------|--------|---------------|--------------|

4.4.2.2 *Sub-Test 2*

$\beta_c=12/15$, $\beta_d=15/15$, $\beta_{hs}=24/15$. MPR=0dB translates the min. and max. power limits to 20.3dBm and 25.7dBm respectively.

| Frequency (MHz) | Channel | Power (dBm) | Comments |
|-----------------|---------|------------------------------------|----------|
| | | 20.3dBm<Measured RMS (dBm)<25.7dBm | |
| 826.4 | 4132 | 22.50 | Pass |
| 836.4 | 4182 | 22.52 | Pass |
| 846.6 | 4233 | 22.65 | Pass |
| 1852.4 | 9262 | 21.63 | Pass |
| 1880.0 | 9400 | 21.48 | Pass |
| 1907.6 | 9538 | 21.41 | Pass |

4.4.2.3 *Sub-Test 3*

$\beta_c=15/15$, $\beta_d=15/8$, $\beta_{hs}=30/15$. MPR=0.5dB translates the min. and max. power limits to 19.8dBm and 25.7dBm respectively.

| Frequency (MHz) | Channel | Power (dBm) | Comments |
|-----------------|---------|------------------------------------|----------|
| | | 19.8dBm<Measured RMS (dBm)<25.7dBm | |
| 826.4 | 4132 | 21.88 | Pass |
| 836.4 | 4182 | 21.91 | Pass |
| 846.6 | 4233 | 22.03 | Pass |
| 1852.4 | 9262 | 20.61 | Pass |
| 1880.0 | 9400 | 20.48 | Pass |
| 1907.6 | 9538 | 20.34 | Pass |

4.4.2.4 *Sub-Test 4*

$\beta_c=15/15$, $\beta_d=4/15$, $\beta_{hs}=30/15$. MPR=0.5dB translates the min. and max. power limits to 19.8dBm and 25.7dBm respectively.

| Frequency (MHz) | Channel | Power (dBm) | Comments |
|-----------------|---------|------------------------------------|----------|
| | | 19.8dBm<Measured RMS (dBm)<25.7dBm | |
| 826.4 | 4132 | 21.80 | Pass |
| 836.4 | 4182 | 21.89 | Pass |
| 846.6 | 4233 | 22.00 | Pass |
| 1852.4 | 9262 | 20.56 | Pass |
| 1880.0 | 9400 | 20.43 | Pass |
| 1907.6 | 9538 | 20.31 | Pass |

SIERRA WIRELESS, INC.

| | | | |
|--------------------------------|--------|---------------|--------------|
| FCC Part 22, 24 / RSS 132, 133 | USB306 | June 18, 2009 | Page 9 of 74 |
|--------------------------------|--------|---------------|--------------|

4.4.3 Test 3: RF Output Power Results for HSPA (HSDPA & HSUPA) Rel6

The EUT supports Category 5 FDD E-DCH physical layer. As stated in the 3GPP TS25.306 V7.3.0 Table 5.1g, the details of Category 5 are as follows:

- Maximum of 2 E-DCH transmitted codes
- Minimum spreading factor of SF2
- Support for only 10 ms TTI E-DCH
- Maximum 20000 bits in an E-DCH transport block within a 10 ms E-DCH TTI
- Data rate of 2 Mbps
- Support of QPSK only

A detailed list of all settings used is included in section 4.5.

The following five Sub-Tests were completed according to the test requirements outlined in section 5.2B of the 3GPP TS34.121-1 V7.5.0 specification. All TX RMS and Peak power requirements were met according to table 5.2B.5 and achieved through the outlined test procedure in section 5.2B.4.2. All UE channels and power ratio's are set according to table C11.1.3 in the 3GPP TS34.121-1 V7.5.0 specification. A summary of these settings are illustrated below:

| Subtest | Mode | Call Type | RMC (kbps) | HSDPA FRC | Power Class 3 Max Limit dBm | β_c/β_d | β_{hs} | β_{ec} | β_{ed} | CM (db) | MPR (db) |
|---------|------|-----------|------------|--------------|-----------------------------|-------------------|--------------|--------------|--------------|---------|----------|
| 1 | HSPA | PS | 12.2 | H-Set 1 QPSK | 24 (+1.7/-5.2 db) | 11 /15 | 22/15 | 209/225 | 1309/225 | 1.0 | 0.0 |
| 2 | HSPA | PS | 12.2 | H-Set 1 QPSK | 22 (+3.7/-5.2 db) | 6 /15 | 12/15 | 12/15 | 94/75 | 3.0 | 2.0 |
| 3 | HSPA | PS | 12.2 | H-Set 1 QPSK | 23 (+2.7/-5.2 db) | 15 /9 | 30/15 | 30/15 | 47/15 | 2.0 | 1.0 |
| 4 | HSPA | PS | 12.2 | H-Set 1 QPSK | 22 (+1.7/-5.2 db) | 2/15 | 4/15 | 2/15 | 56/75 | 3.0 | 2.0 |
| 5 | HSPA | PS | 12.2 | H-Set 1 QPSK | 24 (+1.7/-5.2 db) | 15/15 | 30/15 | 24/15 | 134/15 | 1.0 | 0.0 |

Note: The recommended HSUPA MPRs are implemented as per following sub-tests.

4.4.3.1 Sub-Test 1:

$\beta_c=11/15$, $\beta_d=15/15$, $\beta_{hs}=22/15$, $\beta_{ec}=209/225$, $\beta_{ed}=1039/225$, AG=20, 1xSF4, E-TFCI=75. MPR=0dB translates the min. and max. power limits to 18.8dBm and 25.7dBm respectively.

| Frequency (MHz) | Channel | Power (dBm) | Comments |
|-----------------|---------|------------------------------------|----------|
| | | 18.8dBm<Measured RMS (dBm)<25.7dBm | |
| 826.4 | 4132 | 21.63 | Pass |
| 836.4 | 4182 | 21.17 | Pass |
| 846.6 | 4233 | 22.25 | Pass |
| 1852.4 | 9262 | 20.76 | Pass |
| 1880.0 | 9400 | 20.65 | Pass |
| 1907.6 | 9538 | 20.49 | Pass |

© 2009 Sierra Wireless, Inc.

The contents of this page are subject to the confidentiality information on page one.

SIERRA WIRELESS, INC.

4.4.3.2 *Sub-Test 2:*

$\beta_c=6/15$, $\beta_d=15/15$, $\beta_{hs}=12/15$, $\beta_{ec}=12/15$, $\beta_{ed}=94/75$, AG=12, 1xSF4, E-TFCI=67. MPR=2dB translates the min. and max. power limits to 16.8dBm and 25.7dBm respectively.

| Frequency (MHz) | Channel | Power (dBm) | Comments |
|-----------------|---------|------------------------------------|----------|
| | | 16.8dBm<Measured RMS (dBm)<25.7dBm | |
| 826.4 | 4132 | 20.88 | Pass |
| 836.4 | 4182 | 20.85 | Pass |
| 846.6 | 4233 | 21.37 | Pass |
| 1852.4 | 9262 | 20.70 | Pass |
| 1880.0 | 9400 | 20.56 | Pass |
| 1907.6 | 9538 | 20.40 | Pass |

4.4.3.3 *Sub-Test 3:*

$\beta_c=15/15$, $\beta_d=9/15$, $\beta_{hs}=30/15$, $\beta_{ec}=30/15$, $\beta_{ed}=47/15$, AG=15, 2xSF4. E-TFCI=92, Note: # of Reference E-TFCI=2. MPR=1dB translates the min. and max. power limits to 17.8dBm and 25.7dBm respectively.

| Frequency (MHz) | Channel | Power (dBm) | Comments |
|-----------------|---------|------------------------------------|----------|
| | | 17.8dBm<Measured RMS (dBm)<25.7dBm | |
| 826.4 | 4132 | 21.53 | Pass |
| 836.4 | 4182 | 21.28 | Pass |
| 846.6 | 4233 | 21.31 | Pass |
| 1852.4 | 9262 | 20.07 | Pass |
| 1880.0 | 9400 | 20.60 | Pass |
| 1907.6 | 9538 | 20.40 | Pass |

4.4.3.4 *Sub-Test 4:*

$\beta_c=2/15$, $\beta_d=15/15$, $\beta_{hs}=4/15$, $\beta_{ec}=2/15$, $\beta_{ed}=56/75$, AG=17, 1xSF4, E-TFCI=71. MPR=2dB translates the min. and max. power limits to 16.8dBm and 25.7dBm respectively.

| Frequency (MHz) | Channel | Power (dBm) | Comments |
|-----------------|---------|------------------------------------|----------|
| | | 16.8dBm<Measured RMS (dBm)<25.7dBm | |
| 826.4 | 4132 | 20.67 | Pass |
| 836.4 | 4182 | 20.73 | Pass |
| 846.6 | 4233 | 20.83 | Pass |
| 1852.4 | 9262 | 20.03 | Pass |
| 1880.0 | 9400 | 20.63 | Pass |
| 1907.6 | 9538 | 20.12 | Pass |

SIERRA WIRELESS, INC.

| | | | |
|--------------------------------|--------|---------------|---------------|
| FCC Part 22, 24 / RSS 132, 133 | USB306 | June 18, 2009 | Page 11 of 74 |
|--------------------------------|--------|---------------|---------------|

4.4.3.5 Sub-Test 5:

$\beta_c=15/15$, $\beta_d=15/15$, $\beta_{hs}=30/15$, $\beta_{ec}=24/15$, $\beta_{ed}=134/15$, AG=21, 1xSF4, E-TFCI=81. MPR=0dB translates the min & max power limits to 18.8dBm and 25.7dBm respectively.

| Frequency (MHz) | Channel | Power (dBm) | Comments |
|-----------------|---------|------------------------------------|----------|
| | | 18.8dBm<Measured RMS (dBm)<25.7dBm | |
| 826.4 | 4132 | 22.40 | Pass |
| 836.4 | 4182 | 22.35 | Pass |
| 846.6 | 4233 | 22.39 | Pass |
| 1852.4 | 9262 | 21.23 | Pass |
| 1880.0 | 9400 | 21.10 | Pass |
| 1907.6 | 9538 | 20.86 | Pass |

4.5 Test Settings for UMTS Mode on CMU200

WCDMA R99 Mode Settings:

UE Power Control Settings

Maximum allowable UE-Power = 24.0 dBm

UL Target Power = 24.0 dBm

Node B Settings

Primary Scrambling Code = 9

Output Channel Power = -51.7 dBm

OCNS = Off

Total Output Power (Ior+Ioc) = -51.7 dBm

RMC Settings

Reference Channel Type: 12.2 kbps Downlink/Uplink

DL DTCH Transport Format: 12.2 kbps

DL Resources in Use: 100 %

UL CRC (Sym. Loop Mode 2): Off

Test Mode: Loop Mode 1

Channel Data Source DTCH: PRBS9

Voice Settings

Voice Source: Echo

Loopback Type: Off

Adaptive Multirate Settings

Active Code Set: Selection A

Codec Mode: 12.2 kbps

Signaling RAB Settings

© 2009 Sierra Wireless, Inc.

The contents of this page are subject to the confidentiality information on page one.

SIERRA WIRELESS, INC.

| | | | |
|--------------------------------|--------|---------------|---------------|
| FCC Part 22, 24 / RSS 132, 133 | USB306 | June 18, 2009 | Page 12 of 74 |
|--------------------------------|--------|---------------|---------------|

SRB Cell DCH: 3.4 kbps

BS Down Link Physical Channels Settings

Ior = -51.7 dBm
P-CPICH = -3.3 dB
P-SCH = -8.3 dB
S-SCH = -8.3 dB
P-CCPCH = -5.3 dB
S-CCPCH = -5.3 dB
S-CCPCH Channel Code = 2
PICH = -8.3 dB
PICH Channel Code = 3
AICH = -8.3 dB
AICH Channel Code = 6
DPDCH = -10.3 dB
DPDCH Channel Code = 96
Power Offset (DPCCH/DPDCH) = 0.0 dB
DL DPCH Timing Offset = 0
Secondary Scrambling Code = 0
Secondary Scrambling Code (HSDPA) = 0
HSDPA Channels = On

TPC Settings

Algorithm = 2
TPC Step Size = 1dB
TPC Pattern Setup = Set 1 (All 1, after linked to get maximum power)

HSDPA Mode Settings:

Node B Settings

Primary Scrambling Code = 9
Output Channel Power = -86 dBm
OCNS = Off
Total Output Power (Ior+Ioc) = -86 dBm

Network Settings

Packet Switched Domain = ON

HSDPA Test Mode Settings

Radiobearer Setup = RMC 12.2 kbps + HSPDA
RMC Test Loop = Loop Mode 1 RLC TM

HSDPA HS-DSCH

CQI Feedback Cycle = 4ms
CQI Repetition Factor = 2
ACK/NACK Repetition Factor = 3

© 2009 Sierra Wireless, Inc.

The contents of this page are subject to the confidentiality information on page one.

SIERRA WIRELESS, INC.

| | | | |
|--------------------------------|--------|---------------|---------------|
| FCC Part 22, 24 / RSS 132, 133 | USB306 | June 18, 2009 | Page 13 of 74 |
|--------------------------------|--------|---------------|---------------|

UE Category = 8
Channel Configuration Type = FRC
H-Set Selection = H-Set 1 QPSK
RV Coding Sequence {0,2,5,6}

HSDPA Gain Factors are set according to each specific sub-test in table C.10.1.4 of 3GPP TS 34.121.

HSPA Mode Settings:

UE Power Control Settings

Maximum allowable UE-Power = 24.0 dBm
UL Target Power: Set according to each specific sub-test in table 5.2B.5 of 3GPP TS 34.121 less 5db for starting point.

UE Packet Data Gain Factors

Bc and Bd: *
 $\Delta\text{ACK}, \Delta\text{NACK}, \Delta\text{CQI}=8$

HSUPA

E-DCH Physical Layer Category = 5
E-TFCI Table Index = 1
Minimum Set E-TFCI = 1*
Maximum Channelisation Code: 1xSF4 or 2xSF4*
Initial Service Grant: *

UE Gain Factors

$\Delta\text{E-DPCCH}$: *
Number of Reference E-TFCIs: **
Reference E-TFCI's: **
E-TFCI Power offsets: **

Node B Settings

Primary Scrambling Code = 9
Output Channel Power = -86 dBm
OCNS = Off
Total Output Power ($I_{or}+I_{oc}$) = -86 dBm

Paket Switched

DCH Type: HSUPA Test Mode
Data Rate: HSDPA/HSUPA
HSDPA Test Mode Settings
Radiobearer Setup = RMC 12.2kbps + HSDPA
RMC Test Loop = Loop Mode 1 RLC TM

HSDPA HS-DSCH

© 2009 Sierra Wireless, Inc.

The contents of this page are subject to the confidentiality information on page one.

SIERRA WIRELESS, INC.

| | | | |
|--------------------------------|--------|---------------|---------------|
| FCC Part 22, 24 / RSS 132, 133 | USB306 | June 18, 2009 | Page 14 of 74 |
|--------------------------------|--------|---------------|---------------|

CQI Feedback Cycle = 4ms
CQI Repetition Factor = 2
ACK/NACK Repetition Factor = 3
UE Category = 8
Channel Configuration Type = FRC
H-Set Selection = H-Set 1 QPSK
RV Coding Sequence {0,2,5,6}

HSUPA Test Mode Settings

Radiobearer Setup = SRB 3.4 + HSPA

HSUPA Settings

TTI mode: 10ms

E-AGCH

Pattern Length: 1 AG Value: *

Downlink Physical Channels

HSUPA Channels: On

E-AGCH: -6.0db

E-AGCH Chan. Code: 6

E-RGCH/E-HICH: -5.0db

E-RGCH Active: Off

E-RGCH/E-HICH Chan. Code: 6

*Set according to each specific sub-test in table C.11.1.3 of 3GPP TS 34.121.

** Set according to each specific sub-test in table 5.2B.2/3 of 3GPP TS 34.121.

5 Occupied Bandwidth

FCC 2.1049

5.1 Test Procedure

The transmitter output was connected to a calibrated coaxial cable and coupler, the other end of which was connected to a spectrum analyzer. The occupied bandwidth (defined as the 99% Power Bandwidth) was measured with the spectrum analyzer at the 3 frequencies in each band. The -26dB bandwidth was also measured and recorded.

Test Setup

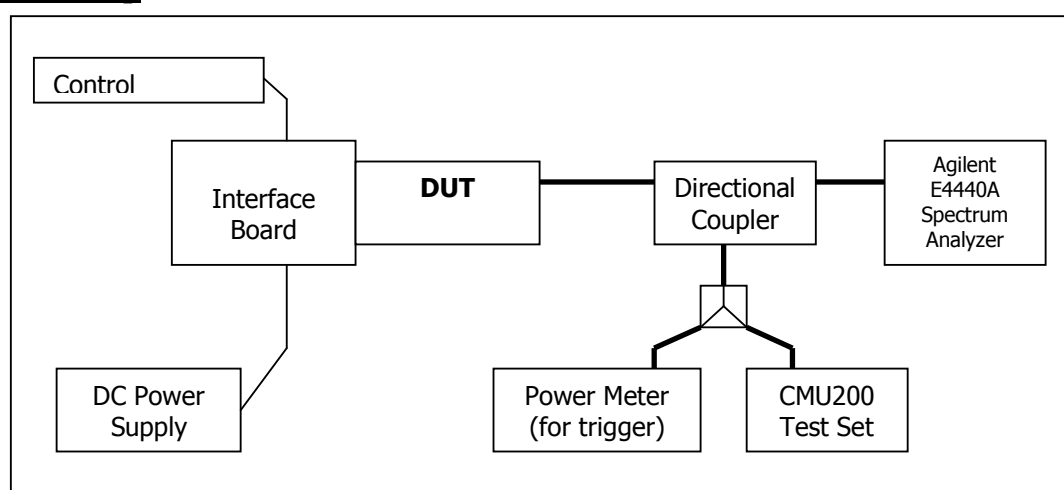

5.2 Test Equipment

| EQUIPMENT | MANUFACTURER | MODEL NO. | SERIAL NO. | CAL. DATE |
|---------------------|-----------------|------------|------------|-------------------|
| Control Computer | TC | Generic PC | 100488 | N/A |
| Wireless Test Set | Rohde & Schwarz | CMU200 | 110520 | November 17, 2009 |
| Spectrum Analyzer | Rohde & Schwarz | FSP | 100060 | November 15, 2009 |
| DC Power Supply | HP | 6632A | 3530A | N/A |
| Interface Board | Shop built | ATEMux | N/A | N/A |
| Directional Coupler | Pasternack | PE2209-10 | N/A | N/A |

5.3 Test Results

The performance of the GSM 850 MHz Cellular band is shown in plots 5.3.1 to 5.3.6.

Performance of the GSM 1900 MHz PCS band is shown in plots 5.3.7 to 5.3.12.

Performance of the UMTS 850 Cellular band is shown in plots 5.3.13 to 5.3.15.

Performance of the UMTS 1900 PCS band is shown in plots 5.3.16 to 5.3.18.

The following GSM test results are based on single slot, and use CS1 for GMSK and MCS9 for 8PSK mode. For WCDMA testing, RMC 12.2kps has been used.

SIERRA WIRELESS, INC.

5.3.1 GSM Results

| Frequency (MHz) | Channel | 99% Occupied Bandwidth (kHz) | | -26dBc Occupied Bandwidth (kHz) | |
|-----------------|---------|------------------------------|------------|---------------------------------|------------|
| | | GMSK Mode | 8-PSK Mode | GMSK Mode | 8-PSK Mode |
| 824.2 | 128 | 246 | 242 | 320 | 322 |
| 836.6 | 190 | 248 | 242 | 326 | 322 |
| 848.8 | 251 | 248 | 240 | 328 | 324 |
| 1850.2 | 512 | 250 | 242 | 340 | 318 |
| 1880.0 | 661 | 250 | 240 | 330 | 318 |
| 1909.8 | 810 | 250 | 240 | 324 | 316 |

5.3.2 WCDMA Results

| Frequency (MHz) | Channel | 99% Occupied Bandwidth (MHz) | -26dBc Occupied Bandwidth (MHz) |
|-----------------|---------|------------------------------|---------------------------------|
| 826.4 | 4132 | 4.20 | 4.68 |
| 836.4 | 4182 | 4.20 | 4.69 |
| 846.6 | 4233 | 4.19 | 4.68 |
| 1852.4 | 9262 | 4.20 | 4.67 |
| 1880.0 | 9400 | 4.20 | 4.67 |
| 1907.6 | 9538 | 4.20 | 4.67 |

SIERRA WIRELESS, INC.

5.4 Test Plots

5.3.1) GMSK Occupied Bandwidth, Cellular Low channel, 824.2 MHz, 99% BW

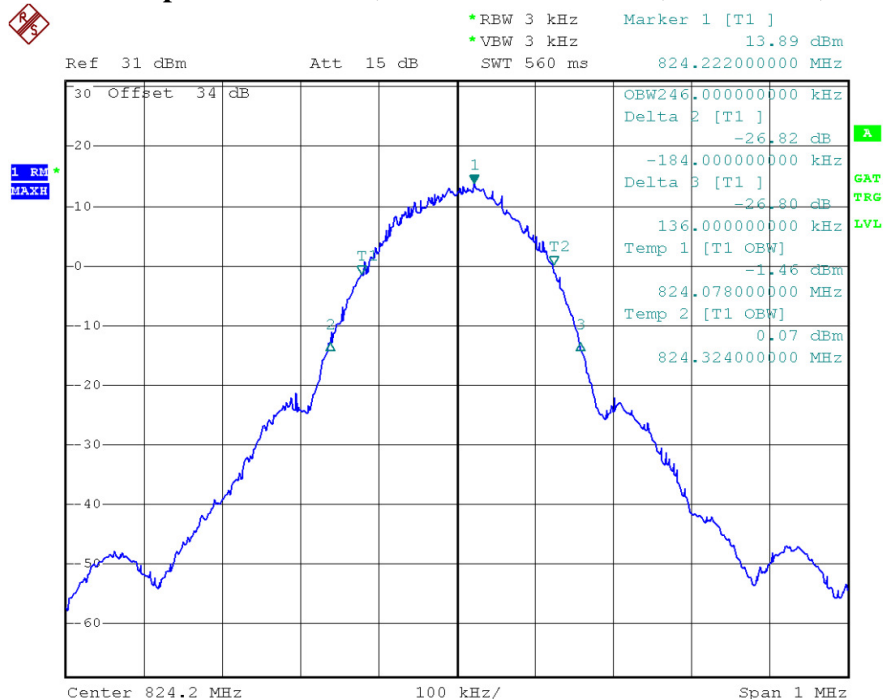

5.3.2) GMSK Occupied Bandwidth, Middle channel, 836.6 MHz, 99% bandwidth

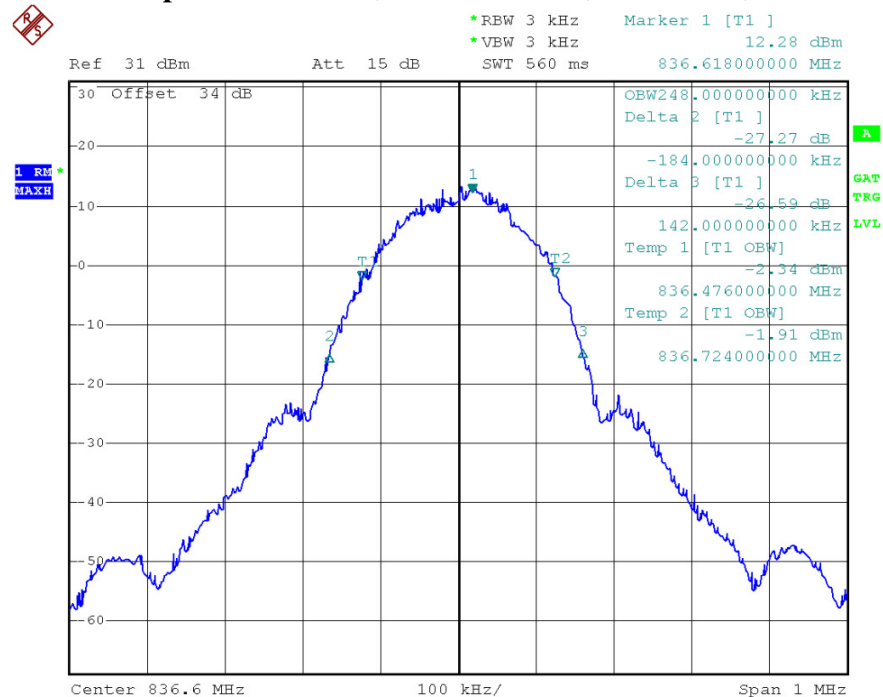

© 2009 Sierra Wireless, Inc.

The contents of this page are subject to the confidentiality information on page one.

SIERRA WIRELESS, INC.

5.3.3) GMSK Occupied Bandwidth, High channel, 848.8 MHz, 99% bandwidth

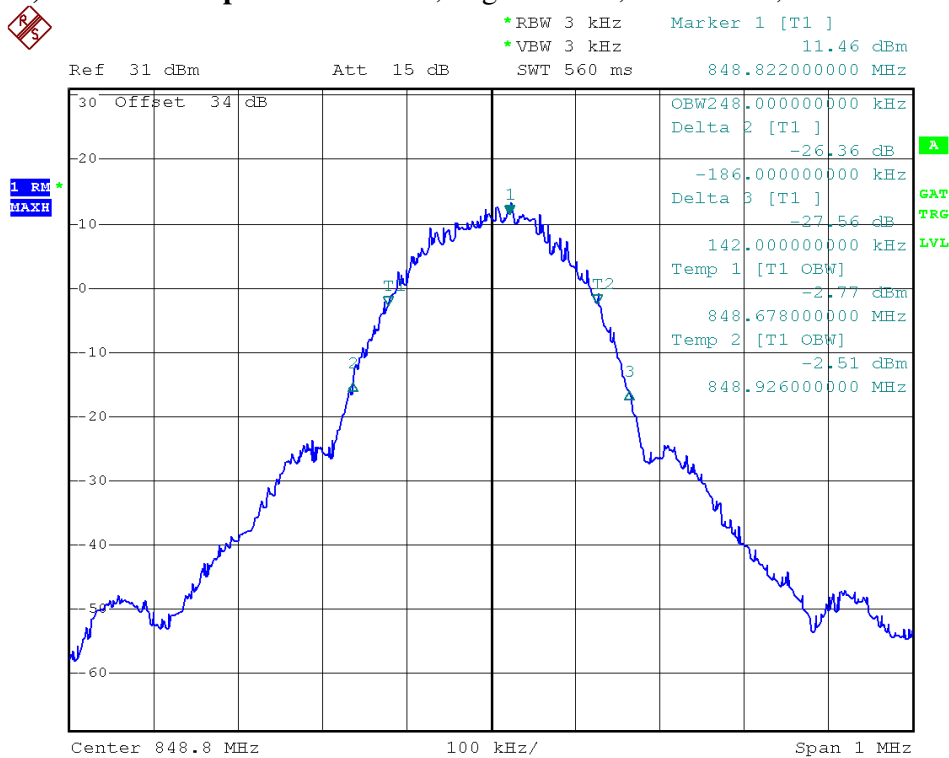

5.3.4) 8-PSK Occupied Bandwidth, Cellular Low channel, 824.2 MHz, 99% BW

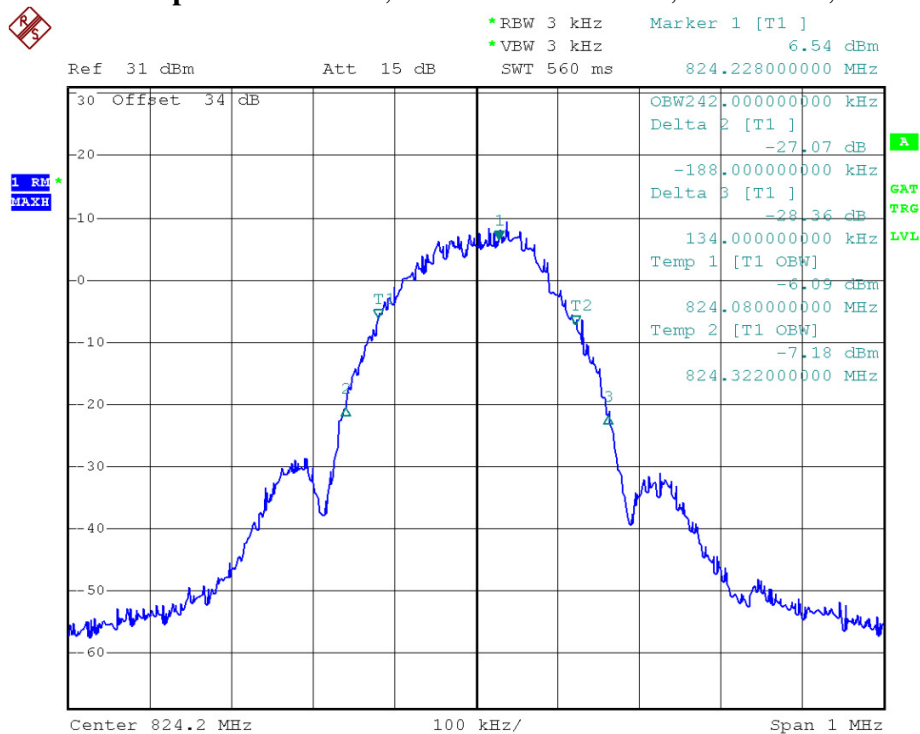

© 2009 Sierra Wireless, Inc.

The contents of this page are subject to the confidentiality information on page one.

SIERRA WIRELESS, INC.

5.3.5) 8-PSK Occupied Bandwidth, Middle channel, 836.6 MHz, 99% bandwidth

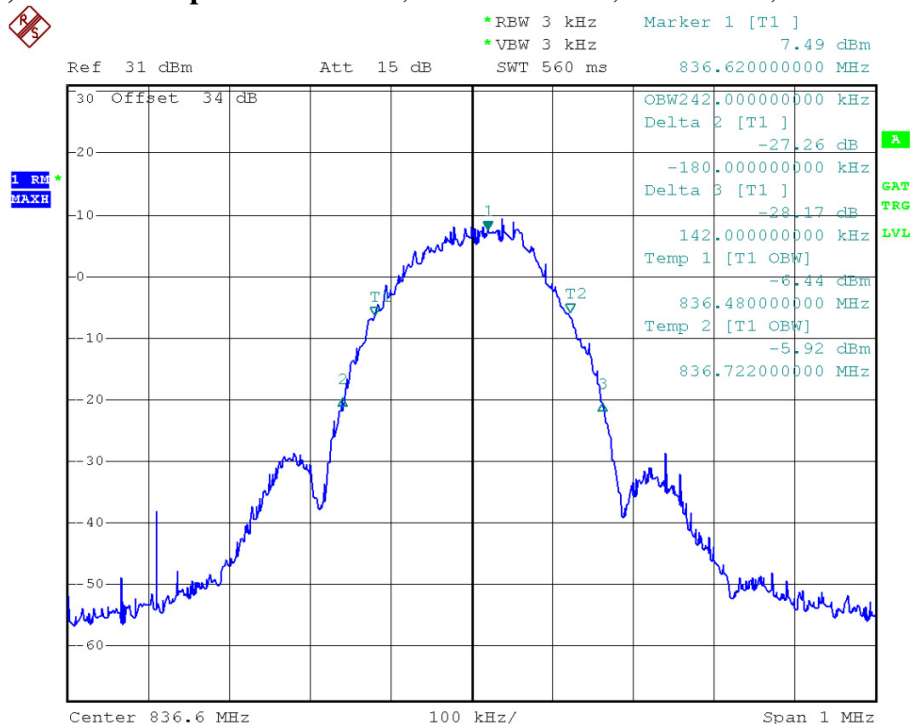

5.3.6) 8-PSK Occupied Bandwidth, High channel, 848.8 MHz, 99% bandwidth

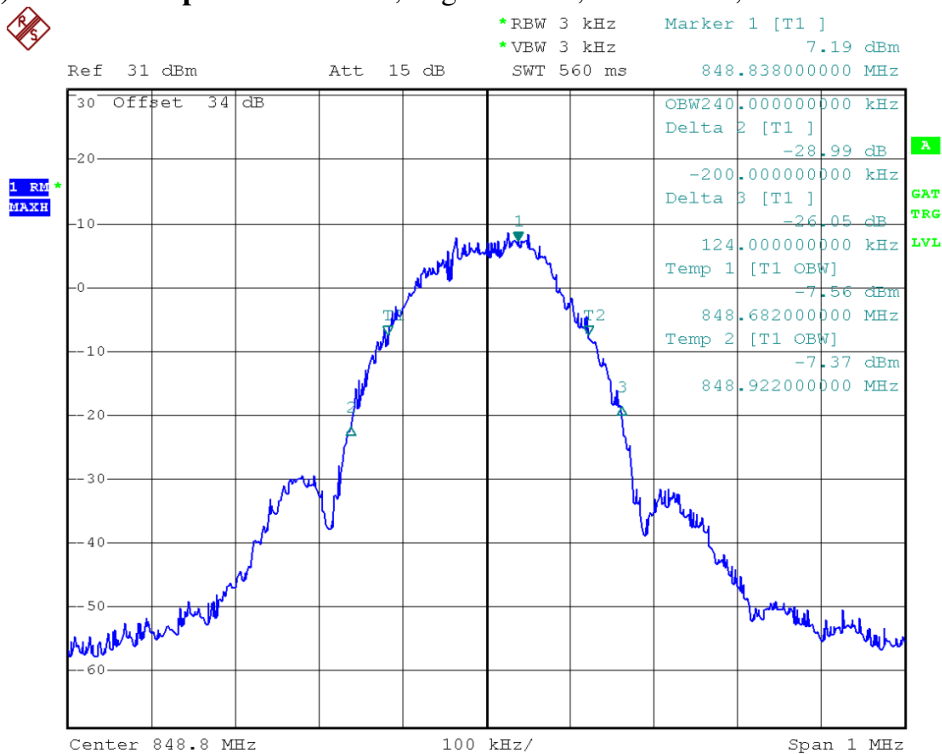

© 2009 Sierra Wireless, Inc.

The contents of this page are subject to the confidentiality information on page one.

SIERRA WIRELESS, INC.

5.3.7) GMSK Occupied Bandwidth, PCS Low channel, 1850.2 MHz, 99% BW

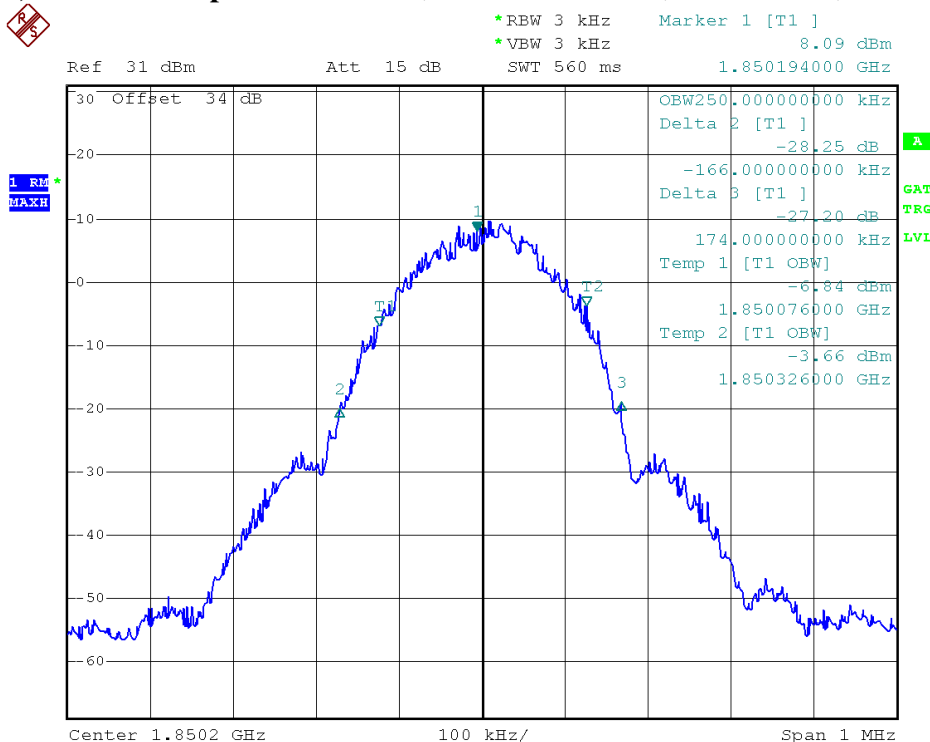

5.3.8) GMSK Occupied Bandwidth, PCS Middle channel, 1880.0 MHz, 99% BW

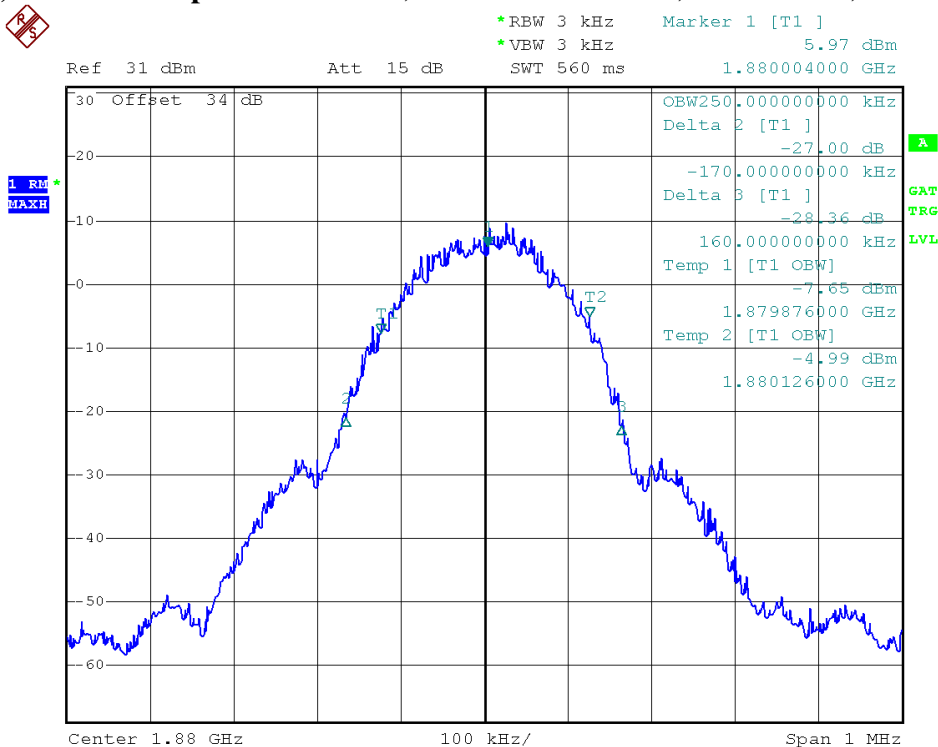

© 2009 Sierra Wireless, Inc.

The contents of this page are subject to the confidentiality information on page one.

SIERRA WIRELESS, INC.

5.3.9) GMSK Occupied Bandwidth, PCS High channel, 1909.8 MHz, 99% BW

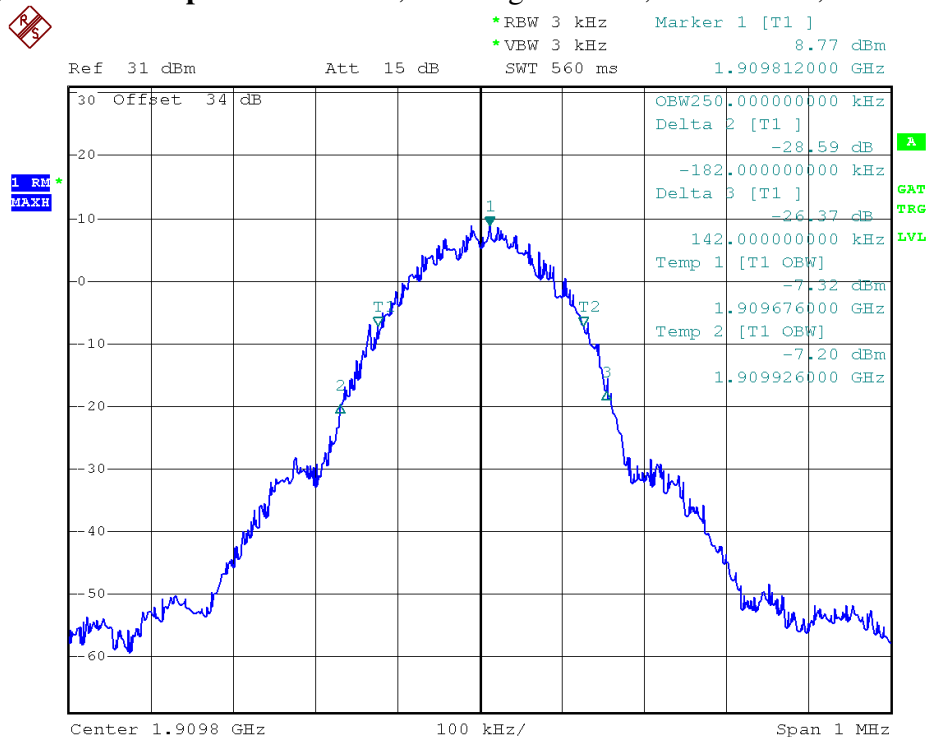

5.3.10) 8-PSK Occupied Bandwidth, PCS Low channel, 1850.2 MHz, 99% BW

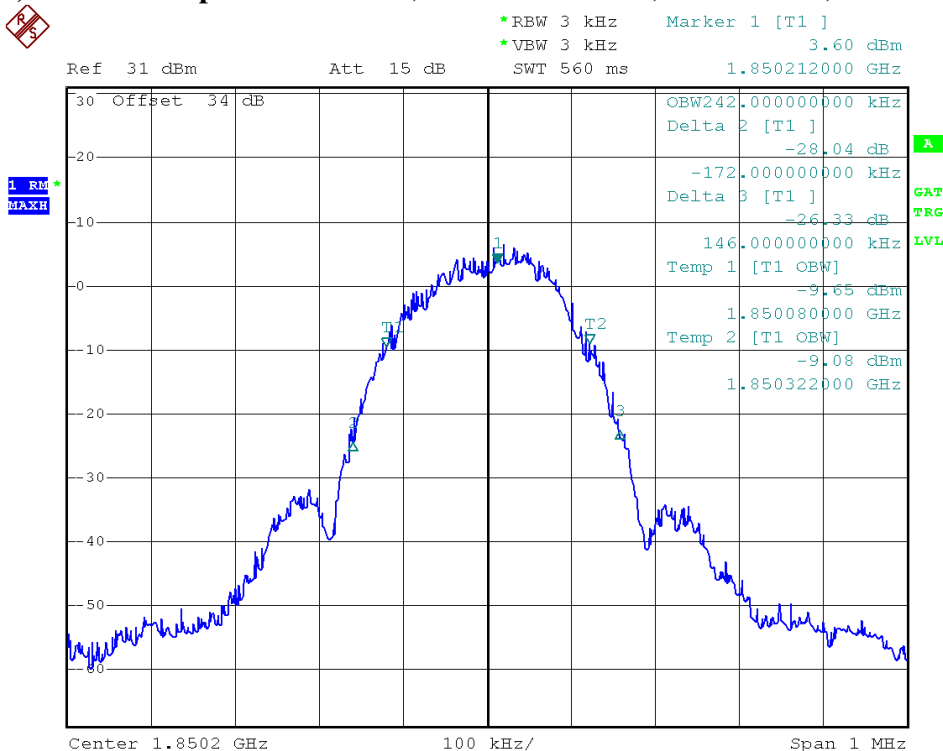

© 2009 Sierra Wireless, Inc.

The contents of this page are subject to the confidentiality information on page one.

SIERRA WIRELESS, INC.

5.3.11) 8-PSK Occupied Bandwidth, PCS Middle channel, 1880.0 MHz, 99% BW

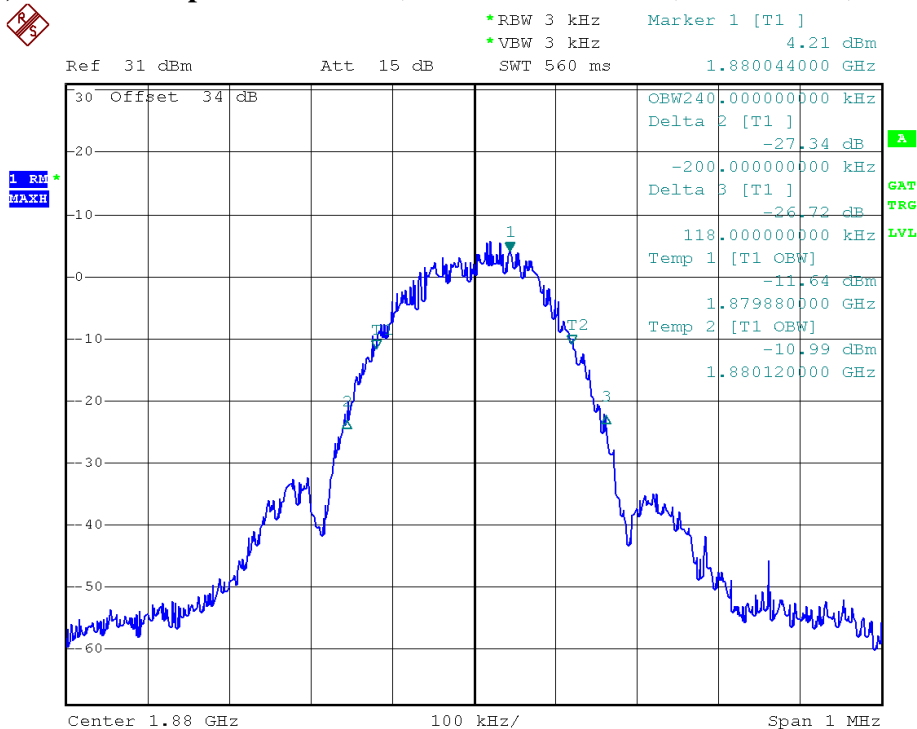

5.3.12) 8-PSK Occupied Bandwidth, PCS High channel, 1909.8 MHz, 99% BW

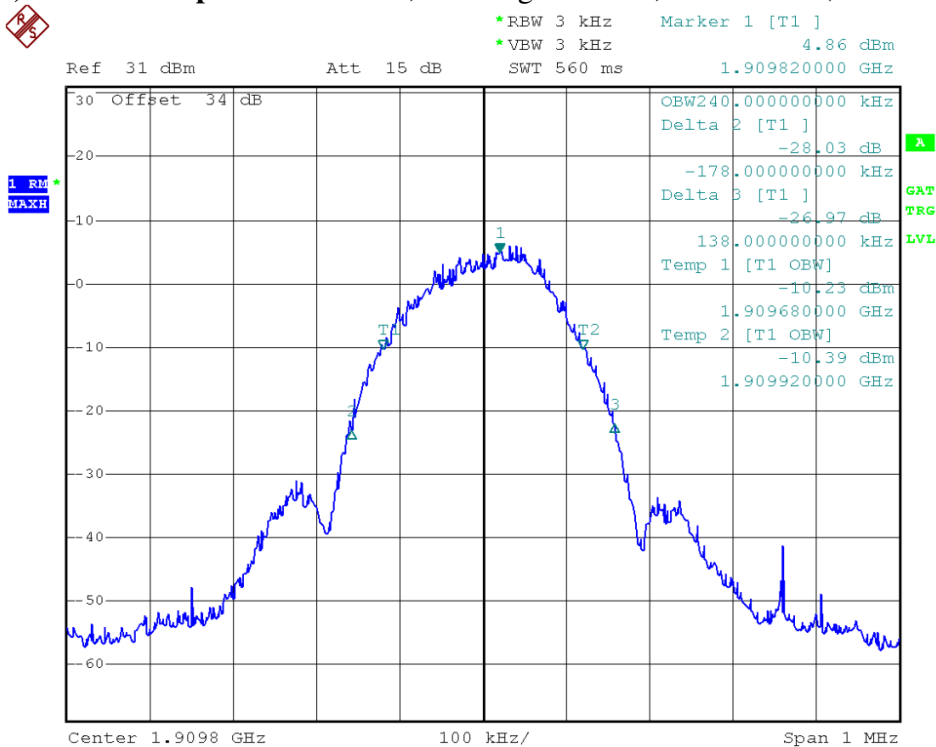

© 2009 Sierra Wireless, Inc.

The contents of this page are subject to the confidentiality information on page one.

SIERRA WIRELESS, INC.

5.3.13) WCDMA Occupied Bandwidth, Cellular Low channel, 826.4 MHz, 99% BW

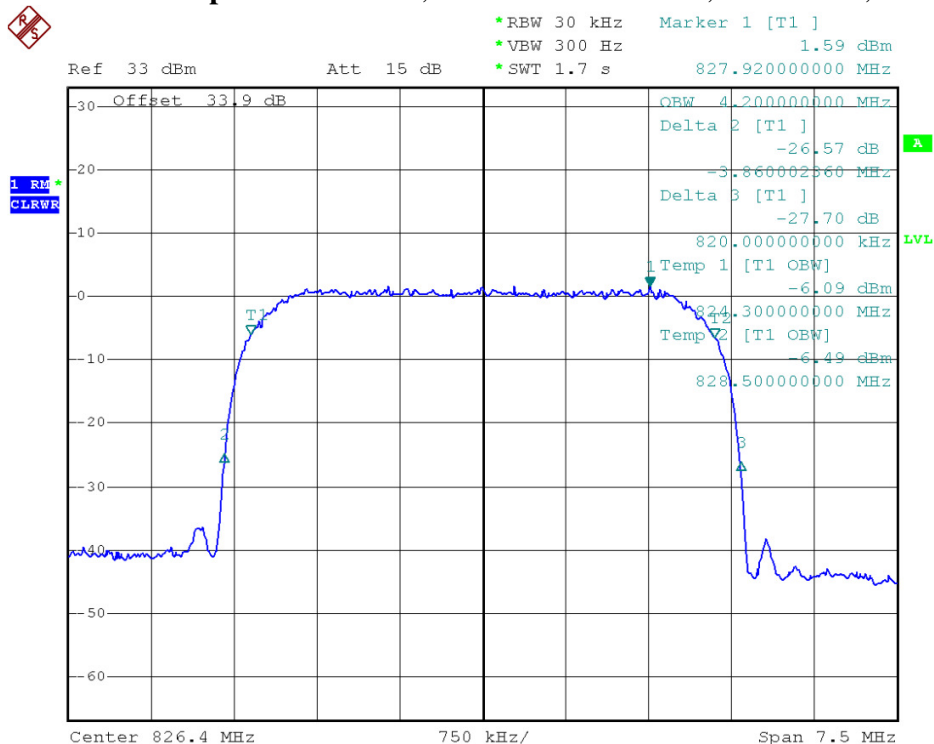

5.3.14) WCDMA Occupied Bandwidth, Cellular Middle channel, 836.4 MHz, 99% BW

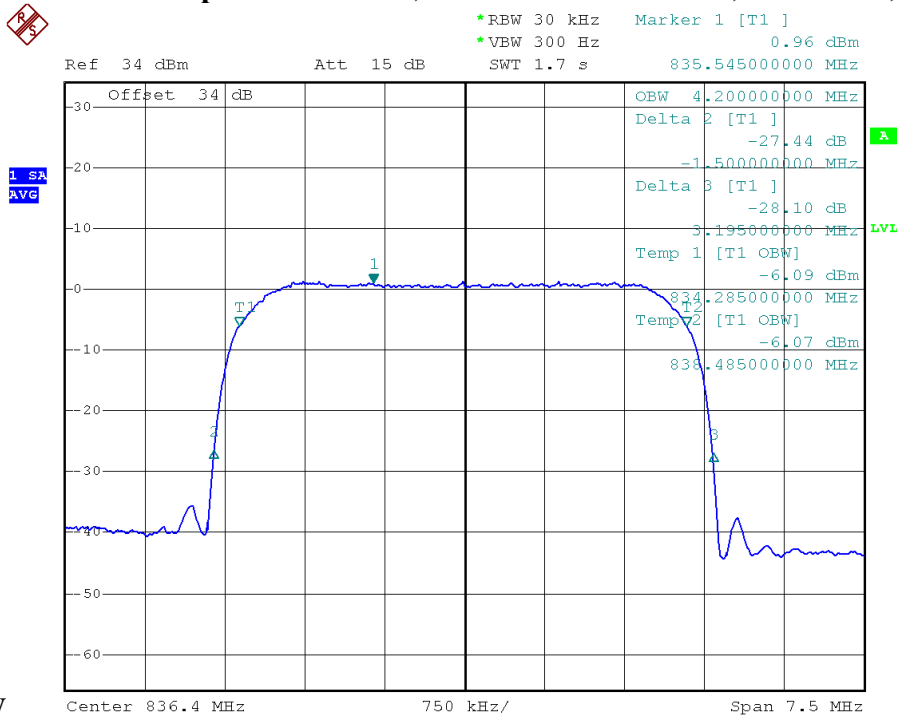

BW

© 2009 Sierra Wireless, Inc.

The contents of this page are subject to the confidentiality information on page one.

SIERRA WIRELESS, INC.

5.3.15) WCDMA Occupied Bandwidth, Cellular High channel, 846.6 MHz, 99% BW

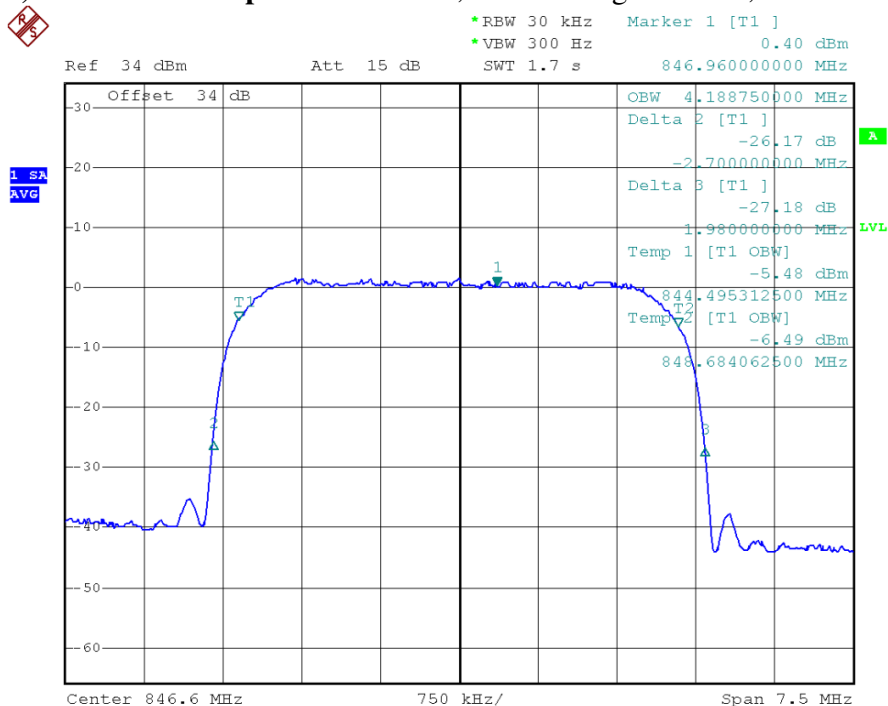

5.3.16) WCDMA Occupied Bandwidth, PCS Low channel, 1852.4 MHz, 99% BW

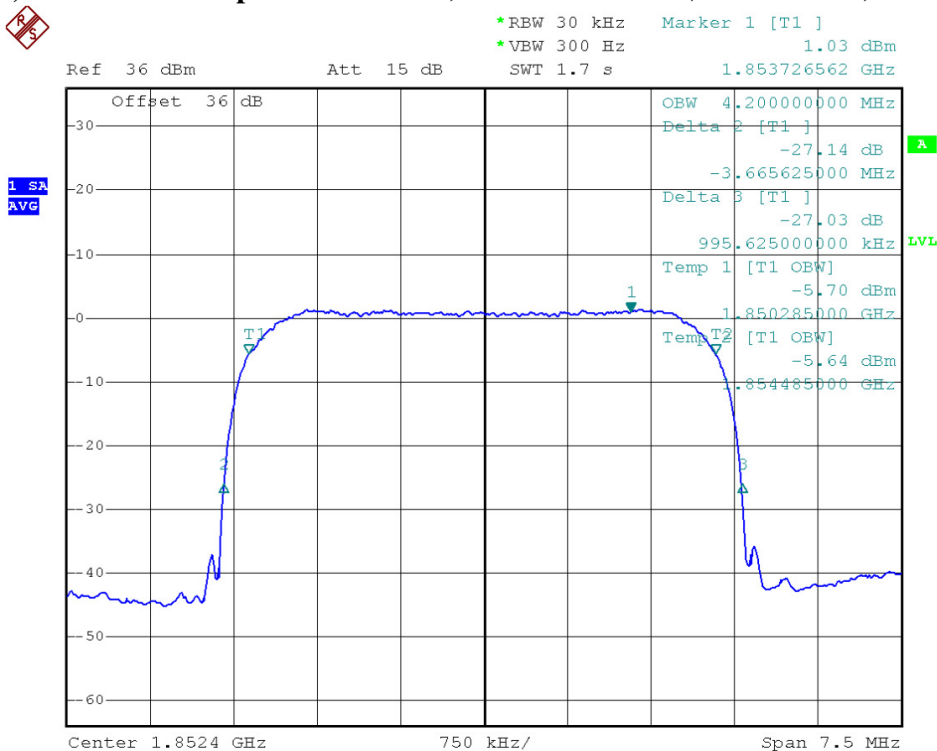

© 2009 Sierra Wireless, Inc.

The contents of this page are subject to the confidentiality information on page one.

SIERRA WIRELESS, INC.

5.3.17) WCDMA Occupied Bandwidth, PCS Middle channel, 1880 MHz, 99% BW

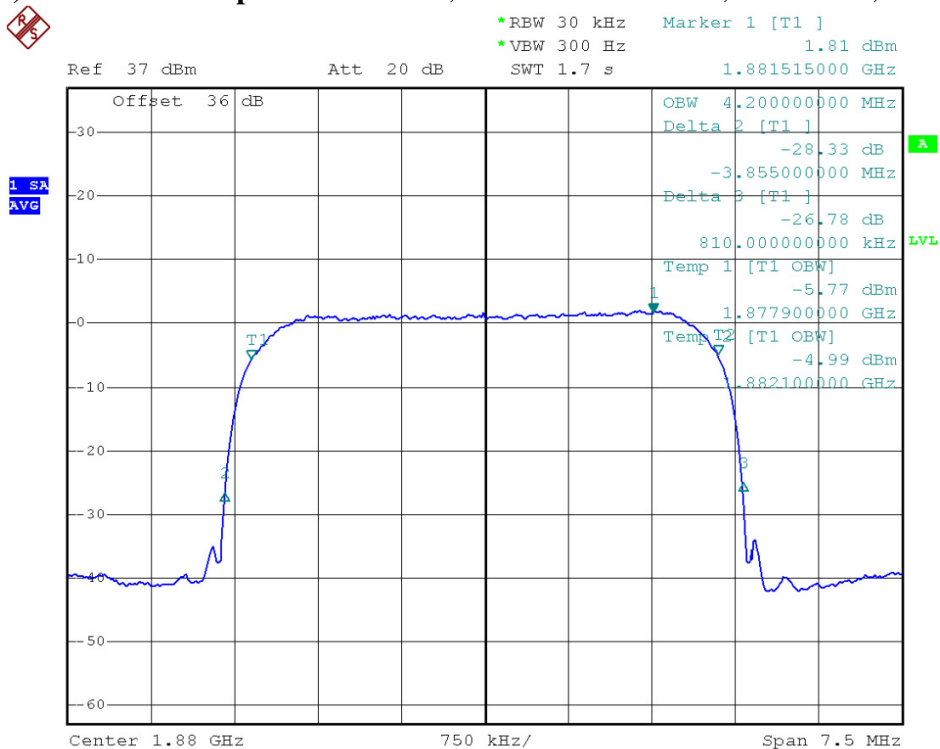

5.3.18) WCDMA Occupied Bandwidth, PCS High channel, 1907.6 MHz, 99%

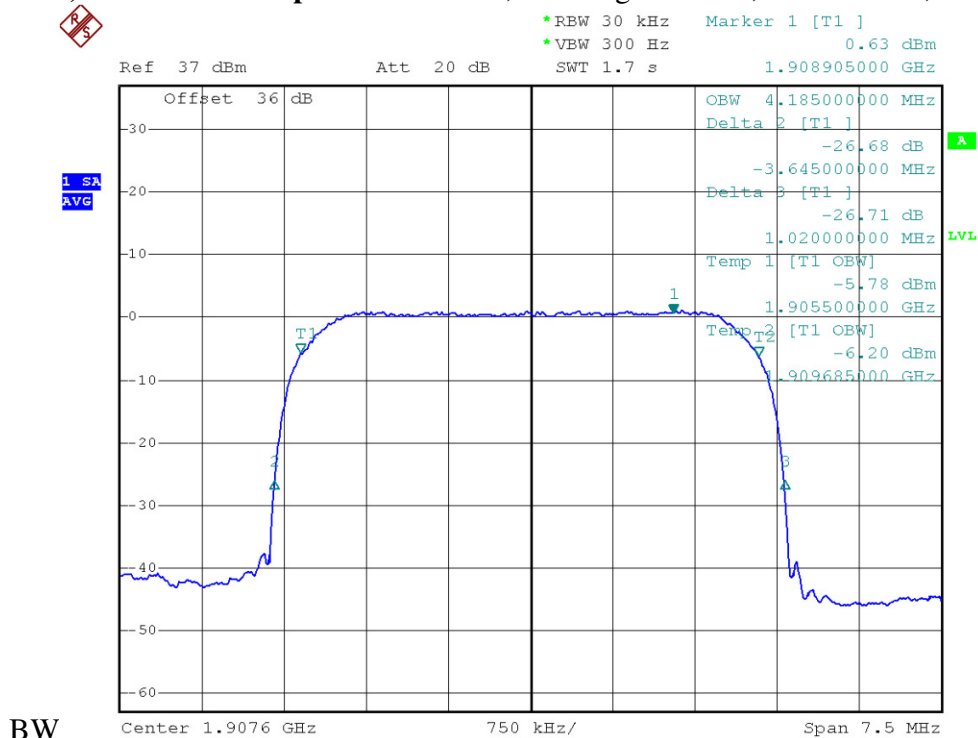

BW

© 2009 Sierra Wireless, Inc.

The contents of this page are subject to the confidentiality information on page one.

SIERRA WIRELESS, INC.

6 Out of Band Emissions at Antenna Terminals

FCC 22.901(d), 22.917, 24.238(a)

Out of Band Emissions:

The mean power of emissions must be attenuated below the mean power of the unmodulated carrier (P) on any frequency outside the frequency band by at least $(43 + 10 \log P)$ dB, which translates to the absolute limit of -13dBm in this case.

6.1 Test Procedure

The RF output of the transmitter was connected to a spectrum analyzer through a calibrated coaxial cable. Sufficient scans were taken to show the out-of-band emissions, if any, up to 10th harmonic. The EUT was scanned for spurious emissions from 1MHz to 20GHz with sufficient bandwidth and video resolution. Data plots are included. The measurement cable path loss at 20GHz (including an attenuator) was 10dB. Multiple sweeps were recorded in maximum hold mode using a peak detector to ensure that the worst-case emissions were captured.

Test Setup

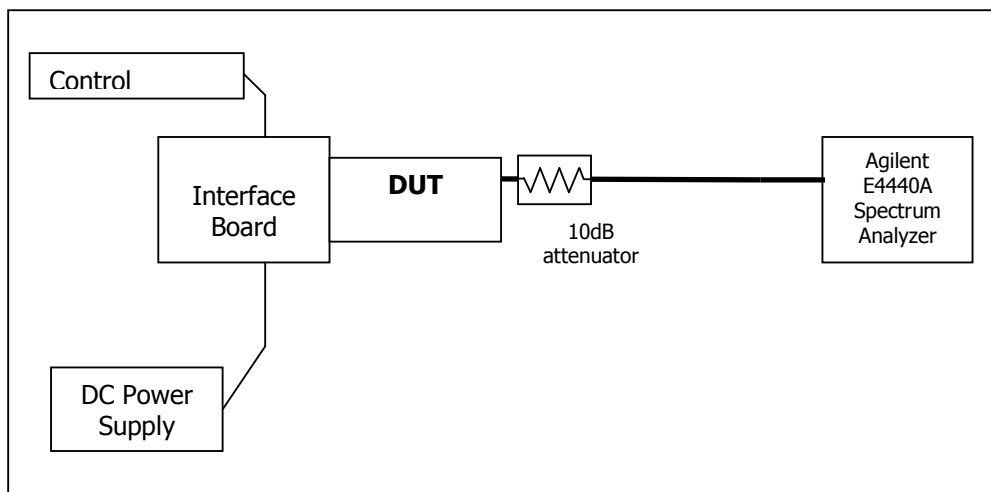

6.2 Test Equipment

| EQUIPMENT | MANUFACTURER | MODEL NO. | SERIAL NO. | CAL. DATE |
|---------------------|-----------------|------------|------------|-------------------|
| Control Computer | TC | Generic PC | 100488 | N/A |
| Wireless Test Set | Rohde & Schwarz | CMU200 | 110520 | November 17, 2009 |
| Spectrum Analyzer | Rohde & Schwarz | FSP | 100060 | November 15, 2009 |
| DC Power Supply | HP | 6632A | 3530A | N/A |
| Interface Board | Shop built | ATEMux | N/A | N/A |
| Directional Coupler | Pasternack | PE2209-10 | N/A | N/A |

6.3 Test Results

Refer to the following plots.

© 2009 Sierra Wireless, Inc.

The contents of this page are subject to the confidentiality information on page one.

SIERRA WIRELESS, INC.

- **Cellular Band**

| Plot Number | Description |
|-----------------|---------------------------------------|
| 6.4.1 – 6.4.3 | GMSK Mode, Low channel, 824.20 MHz |
| 6.4.4 – 6.4.6 | GMSK Mode, Middle Channel, 836.6 MHz |
| 6.4.7 – 6.4.9 | GMSK Mode, High Channel, 848.8 MHz |
| 6.4.10 – 6.4.12 | 8-PSK Mode, Low channel, 824.20 MHz |
| 6.4.13 – 6.4.15 | 8-PSK Mode, Middle Channel, 836.6 MHz |
| 6.4.16 – 6.4.18 | 8-PSK Mode, High Channel, 848.8 MHz |

- **PCS Band**

| Plot Number | Description |
|-----------------|--|
| 6.4.19 – 6.4.21 | GMSK Mode, Low Channel, 1850.2 MHz |
| 6.4.22 – 6.4.24 | GMSK Mode, Middle Channel, 1880.0 MHz |
| 6.4.25 – 6.4.27 | GMSK Mode, High Channel, 1909.8 MHz |
| 6.4.28 – 6.4.30 | 8-PSK, Mode, Low Channel, 1850.2 MHz |
| 6.4.31 – 6.4.33 | 8-PSK Mode, Middle Channel, 1880.0 MHz |
| 6.4.34 – 6.4.36 | 8-PSK Mode, High Channel, 1909.8 MHz |

- **UMTS Cellular Band**

| Plot Number | Description |
|-----------------|---------------------------------------|
| 6.4.37 – 6.4.39 | WCDMA Mode, Low Channel, 826.4 MHz |
| 6.4.40 – 6.4.42 | WCDMA Mode, Middle Channel, 836.4 MHz |
| 6.4.43 – 6.4.45 | WCDMA Mode, High Channel, 846.6 MHz |

- **UMTS PCS Band**

| Plot Number | Description |
|-----------------|--|
| 6.4.46 – 6.4.48 | WCDMA Mode, Low Channel, 1852.4 MHz |
| 6.4.49 – 6.4.51 | WCDMA Mode, Middle Channel, 1880.0 MHz |
| 6.4.52 – 6.4.54 | WCDMA Mode, High Channel, 1907.6 MHz |

The plots below show that the conducted emission limits requirements are met.

SIERRA WIRELESS, INC.

6.4 Test Plots

Plot 6.4.1) Out of Band Emissions at Antenna Terminals

GMSK, Low channel, 824.200 MHz, 1 MHz to 1 GHz

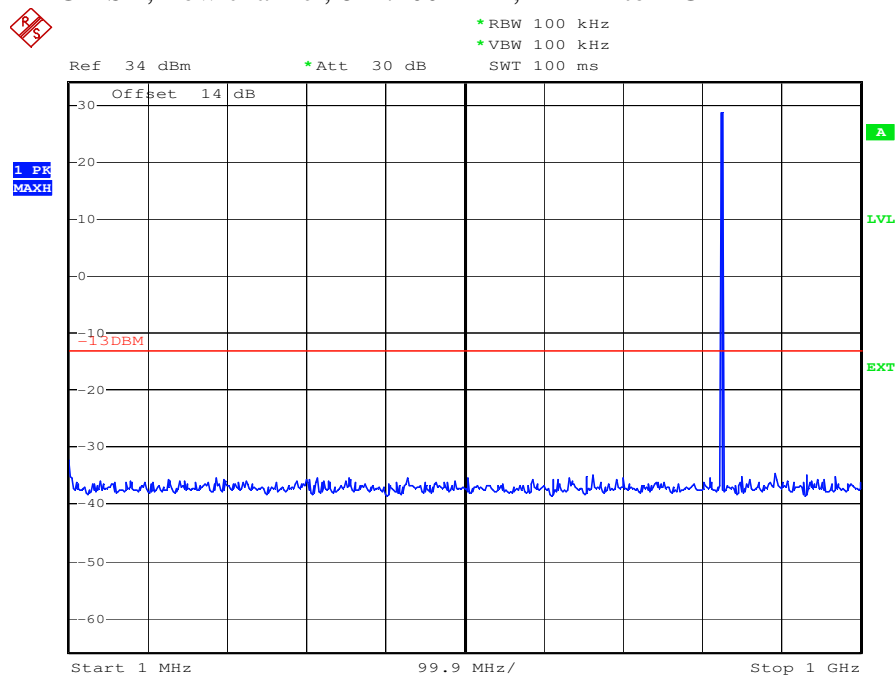

Plot 6.4.2) Out of Band Emissions at Antenna Terminals

GMSK, Low channel, 824.200 MHz, TX signal +/- 20

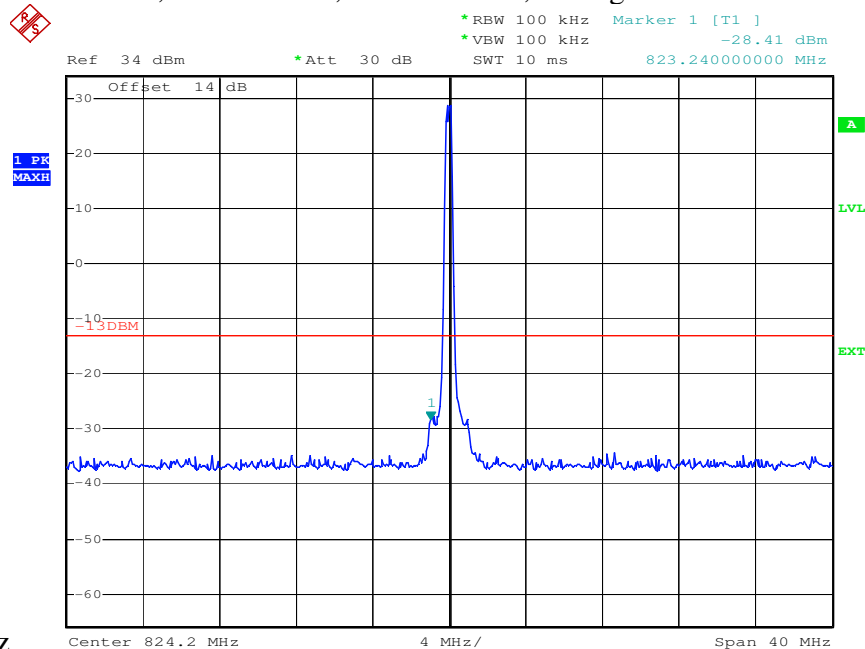

The strong emission shown in each case is the carrier signal.

© 2009 Sierra Wireless, Inc.

The contents of this page are subject to the confidentiality information on page one.

SIERRA WIRELESS, INC.

Plot 6.4.3) Out of Band Emissions at Antenna Terminals GMSK, Low channel, 824.200 MHz, 1 GHz to 20 GHz

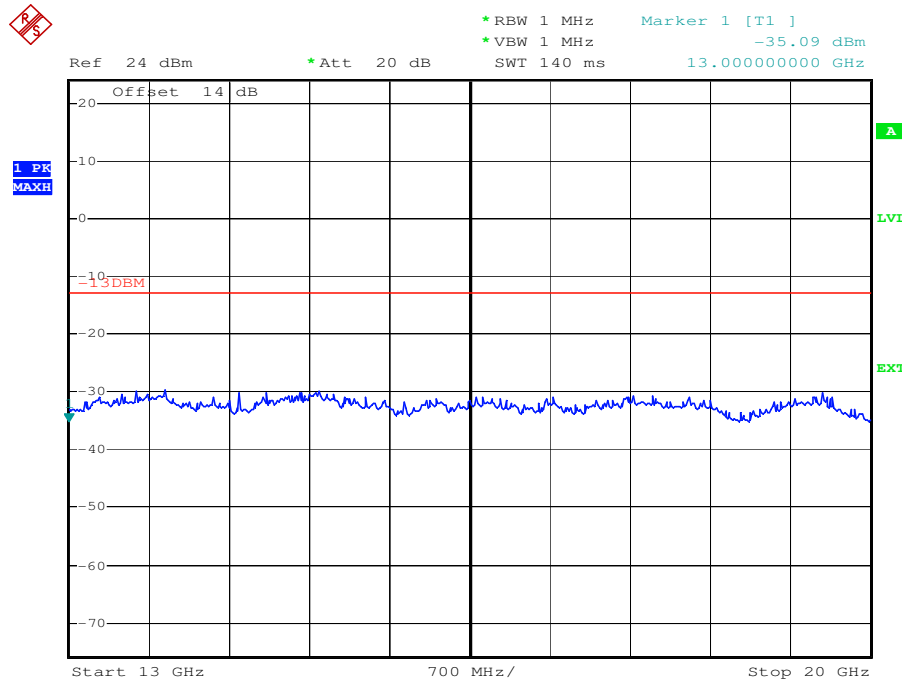
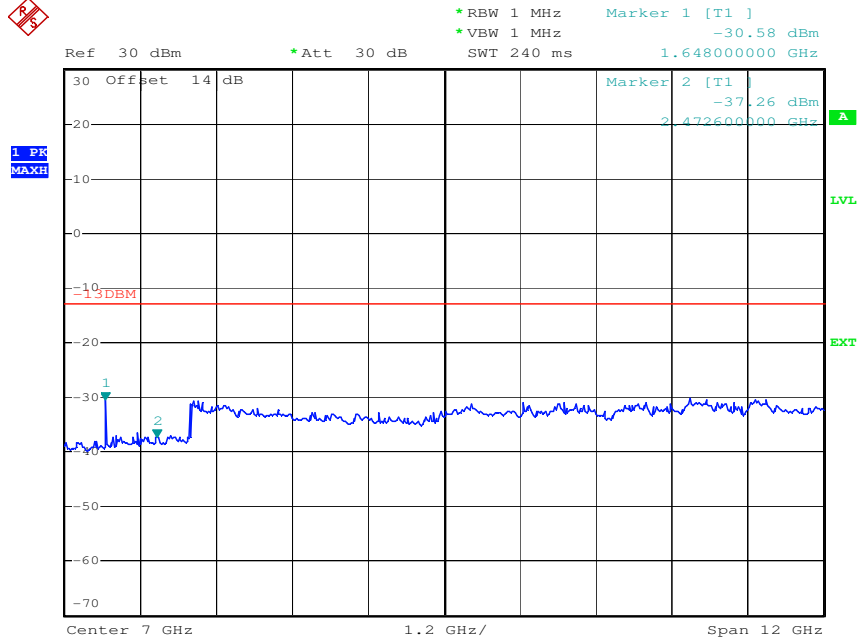

| Cellular Harmonics for Ch. 128 (824.2 MHz) | Level (dBm) |
|---|-----------------------|
| Second | -30.58 dBm |
| Third | --37.26dBm |
| All others | < -35 dBm up to 20GHz |

© 2009 Sierra Wireless, Inc.

The contents of this page are subject to the confidentiality information on page one.

SIERRA WIRELESS, INC.

Plot 6.4.4) Out of Band Emissions at Antenna Terminals
 GMSK, Mid Channel, 836.6 MHz, 1 MHz to 1 GHz

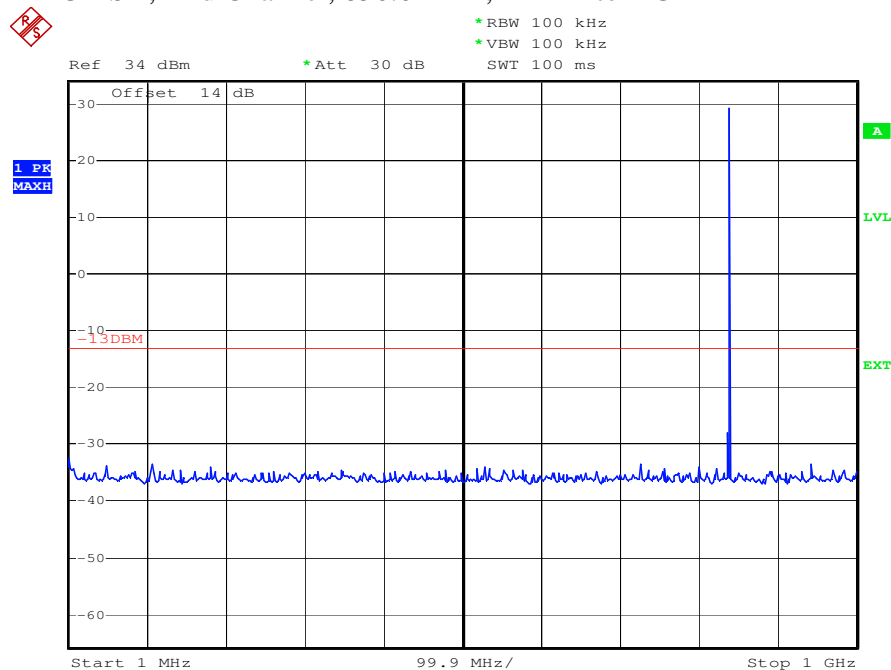

Plot 6.4.5) Out of Band Emissions at Antenna Terminals
 GMSK, Mid Channel, 836.6 MHz, TX signal +/- 20 MHz

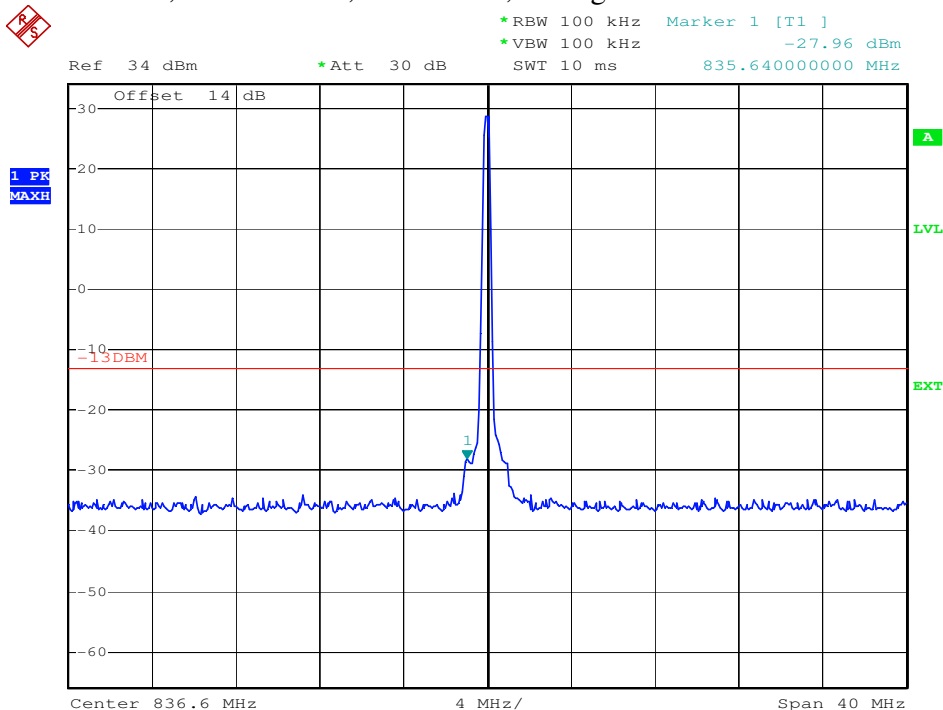

The strong emission shown in each case is the carrier signal.

© 2009 Sierra Wireless, Inc.

The contents of this page are subject to the confidentiality information on page one.

SIERRA WIRELESS, INC.

Plot 6.4.6) Out of Band Emissions at Antenna Terminals GMSK, Mid Channel, 836.6 MHz, 1 GHz to 20

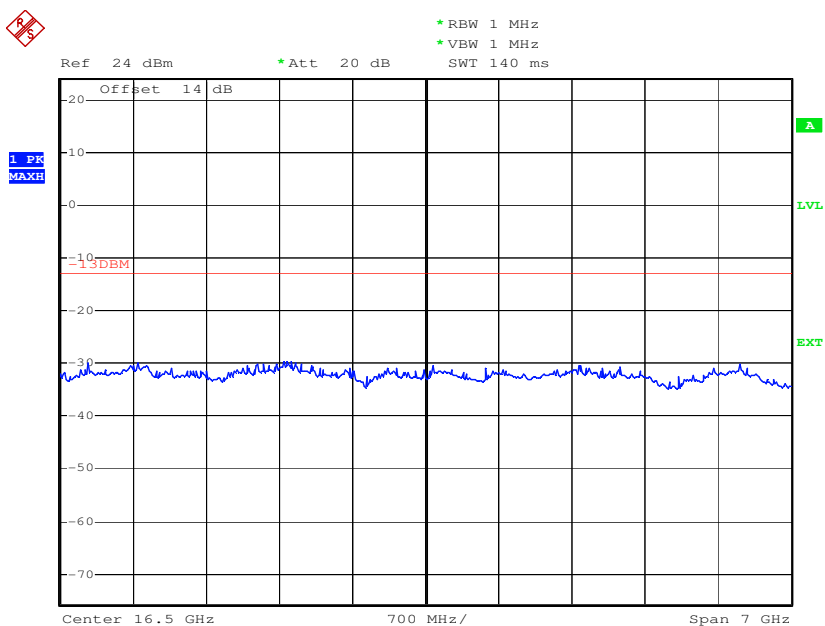
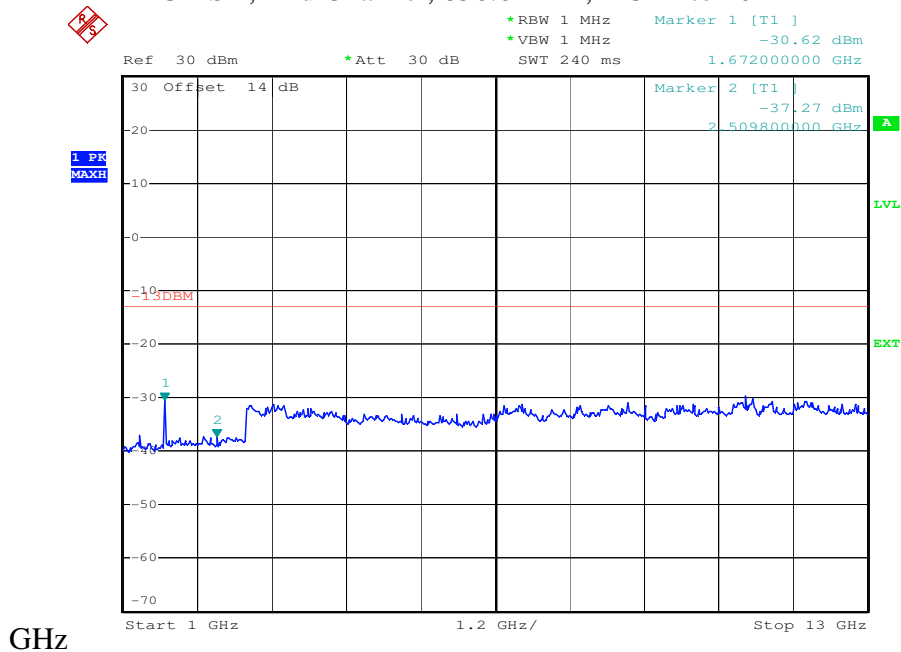

| Cellular Harmonics for Ch. 190 (836.6 MHz) | Level (dBm) |
|--|-----------------------|
| Second | -30.62 dBm |
| Third | -37.27 dBm |
| All others | < -35 dBm up to 20GHz |

© 2009 Sierra Wireless, Inc.

The contents of this page are subject to the confidentiality information on page one.

SIERRA WIRELESS, INC.

Plot 6.4.7) Out of Band Emissions at Antenna Terminals
GMSK, High Channel, 848.8 MHz, 1 MHz to 1 GHz

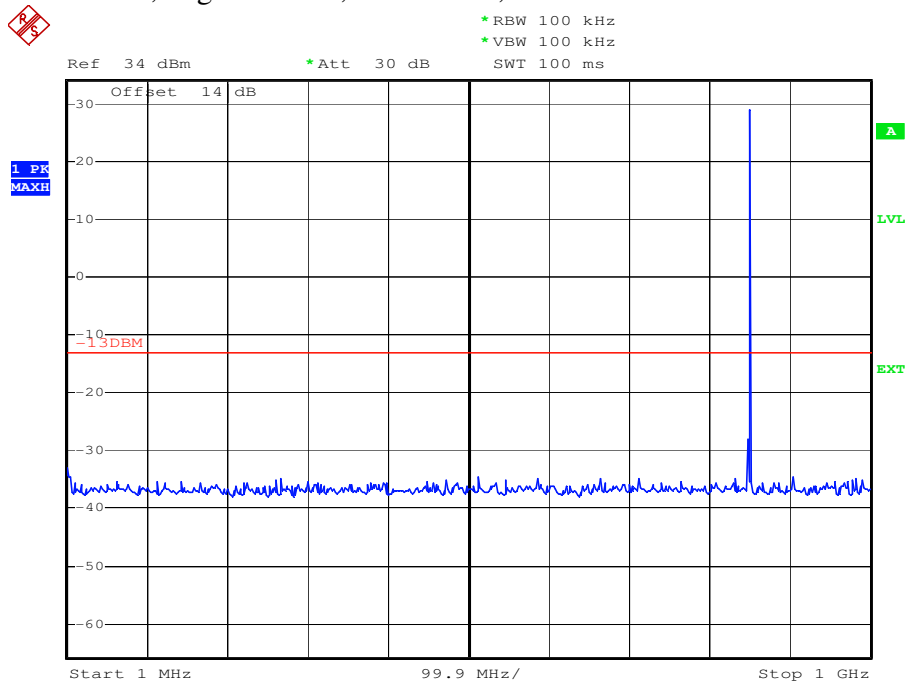

Plot 6.4.8) Out of Band Emissions at Antenna Terminals
GMSK, High Channel, 848.8 MHz, TX signal +/- 20 MHz

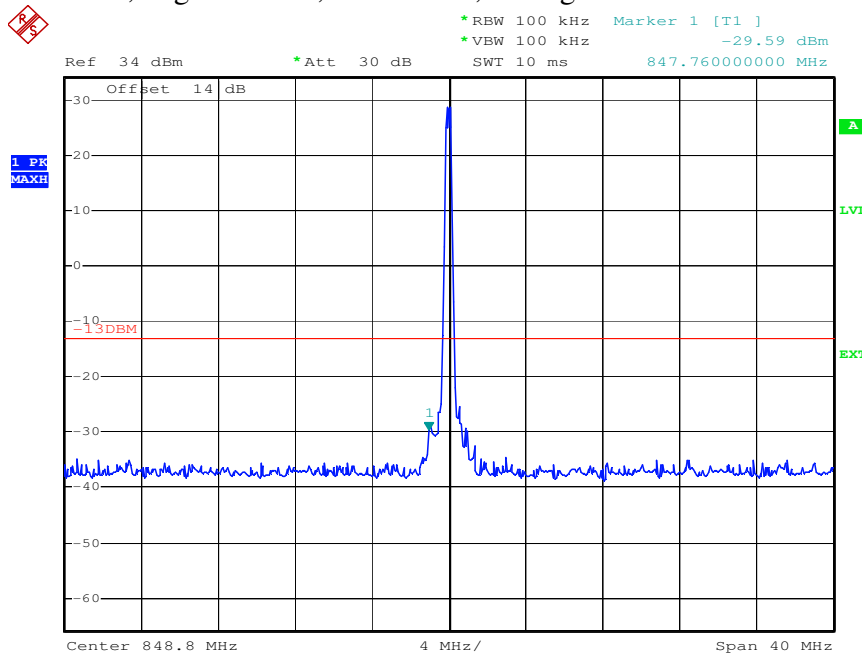

The strong emission shown in each case is the carrier signal.

SIERRA WIRELESS, INC.

Plot 6.4.9) Out of Band Emissions at Antenna Terminals
GMSK, High Channel, 848.8 MHz, 1 GHz to 20 GHz

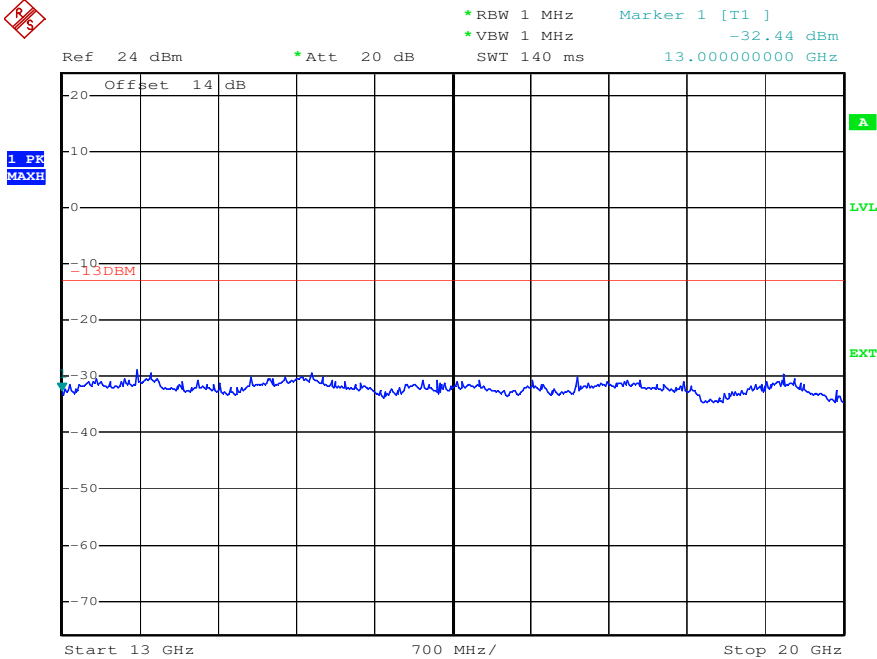
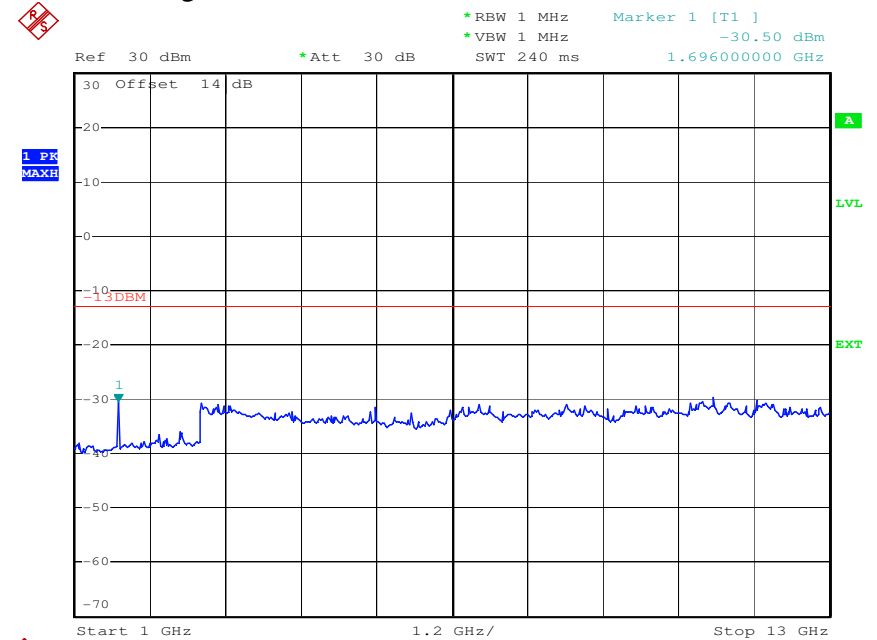

| Cellular Harmonics for Ch. 251 (848.8 MHz) | Level (dBm) |
|--|-----------------------|
| Second | -30.5 dBm |
| Third | ---- |
| All others | < -35 dBm up to 20GHz |

SIERRA WIRELESS, INC.

Plot 6.4.10) Out of Band Emissions at Antenna Terminals
 8-PSK, Low channel, 824.200 MHz, 1 MHz to 1 GHz

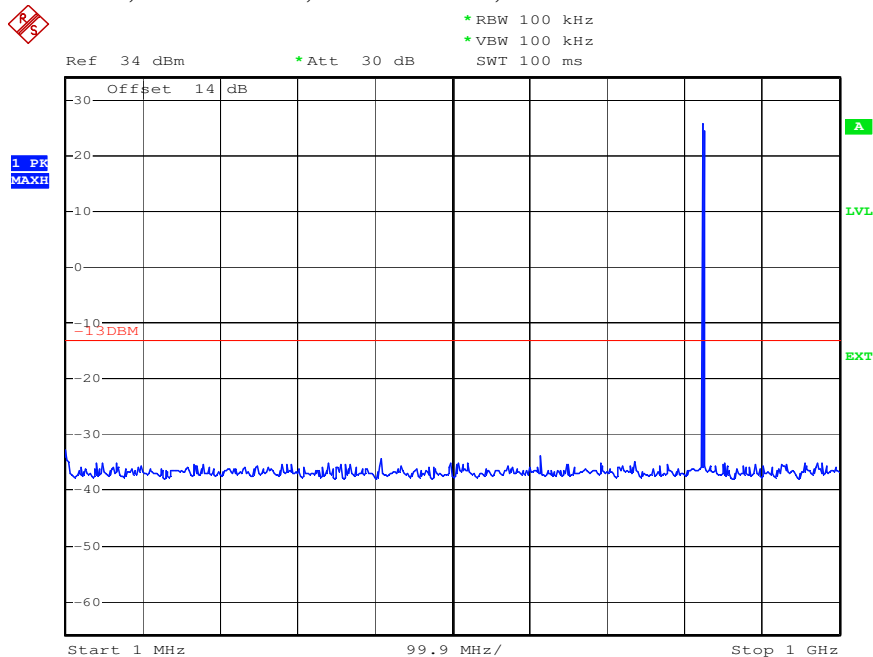

Plot 6.4.11) Out of Band Emissions at Antenna Terminals
 8-PSK, Low channel, 824.200 MHz, TX signal +/- 20 MHz

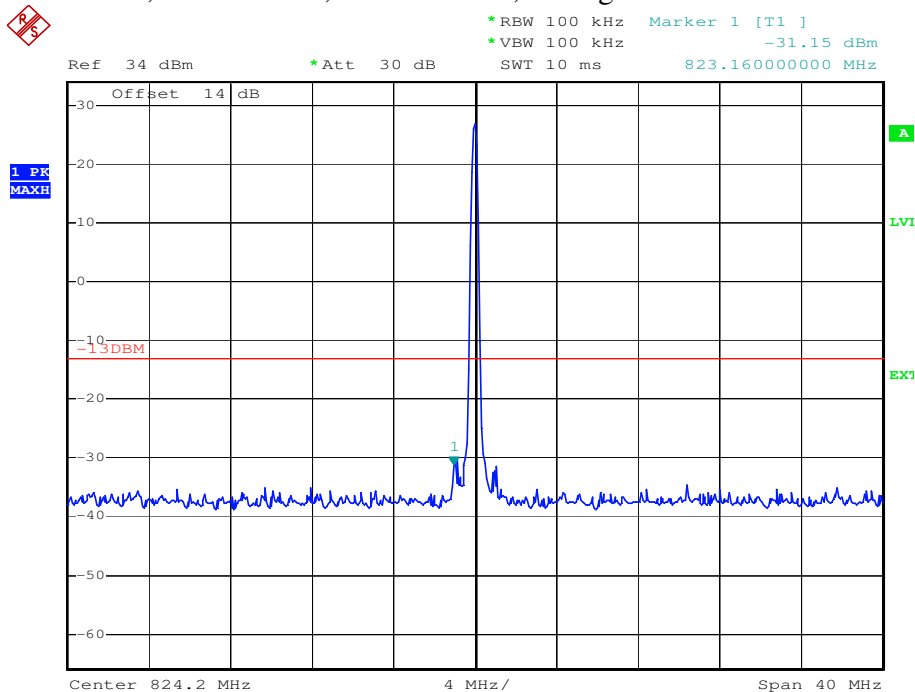

The strong emission shown in each case is the carrier signal.

© 2009 Sierra Wireless, Inc.

The contents of this page are subject to the confidentiality information on page one.

SIERRA WIRELESS, INC.

Plot 6.4.12) Out of Band Emissions at Antenna Terminals 8-PSK, Low channel, 824.200 MHz, 1 GHz to 20 GHz

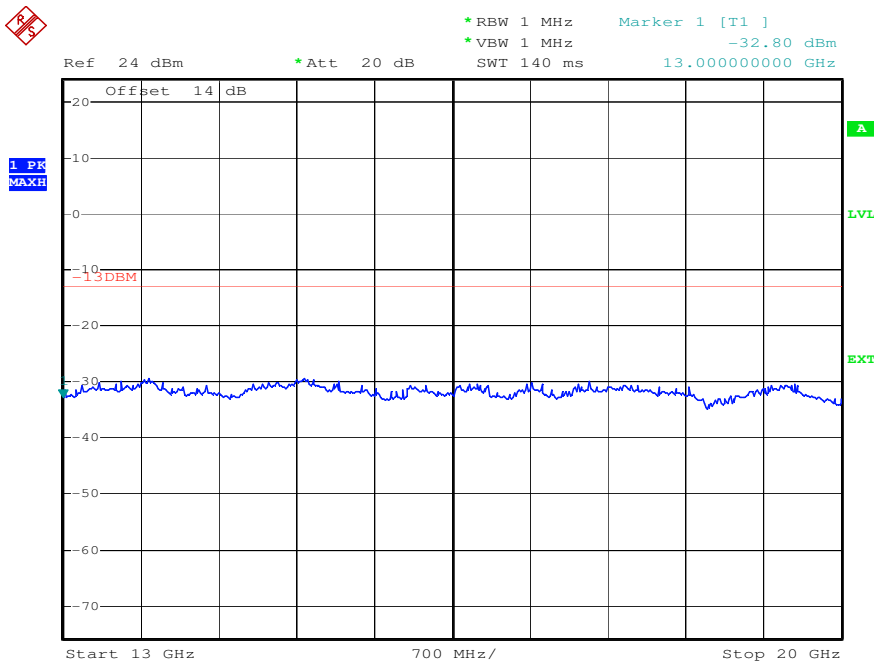
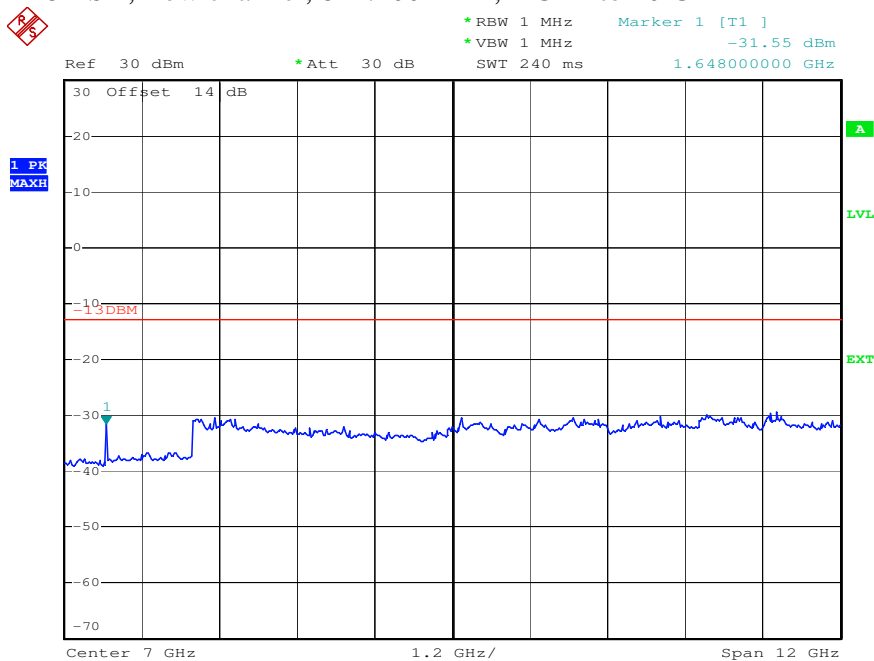

| Cellular Harmonics for Ch. 128 (824.2 MHz) | Level (dBm) |
|---|-----------------------|
| Second | -31.55 dBm |
| Third | ----- dBm |
| All others | < -35 dBm up to 20GHz |

© 2009 Sierra Wireless, Inc.

The contents of this page are subject to the confidentiality information on page one.

SIERRA WIRELESS, INC.

Plot 6.4.13) Out of Band Emissions at Antenna Terminals
8-PSK, Mid Channel, 836.6 MHz, 1 MHz to 1 GHz

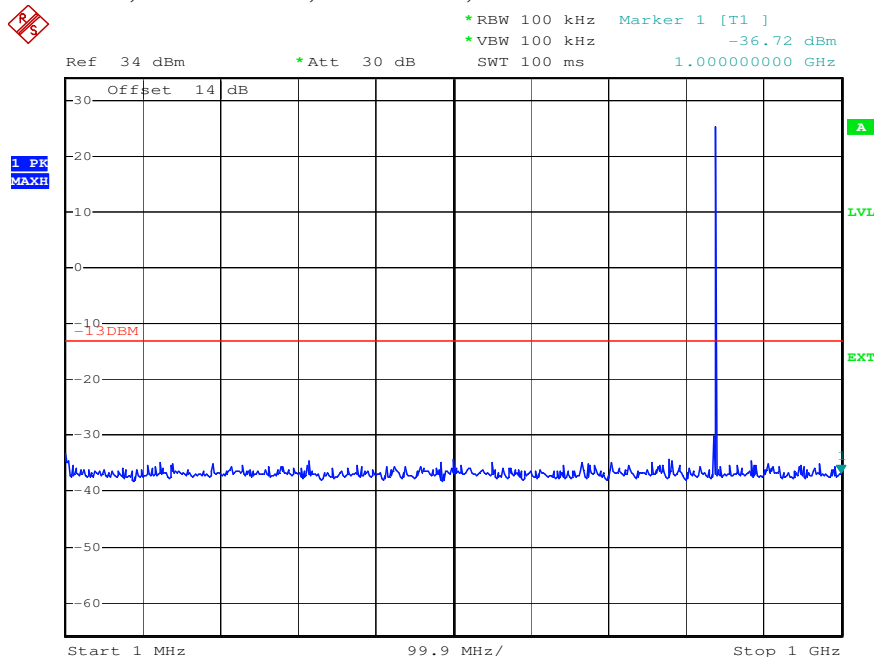

Plot 6.4.14) Out of Band Emissions at Antenna Terminals
8-PSK, Mid Channel, 836.6 MHz, TX signal +/- 20 MHz

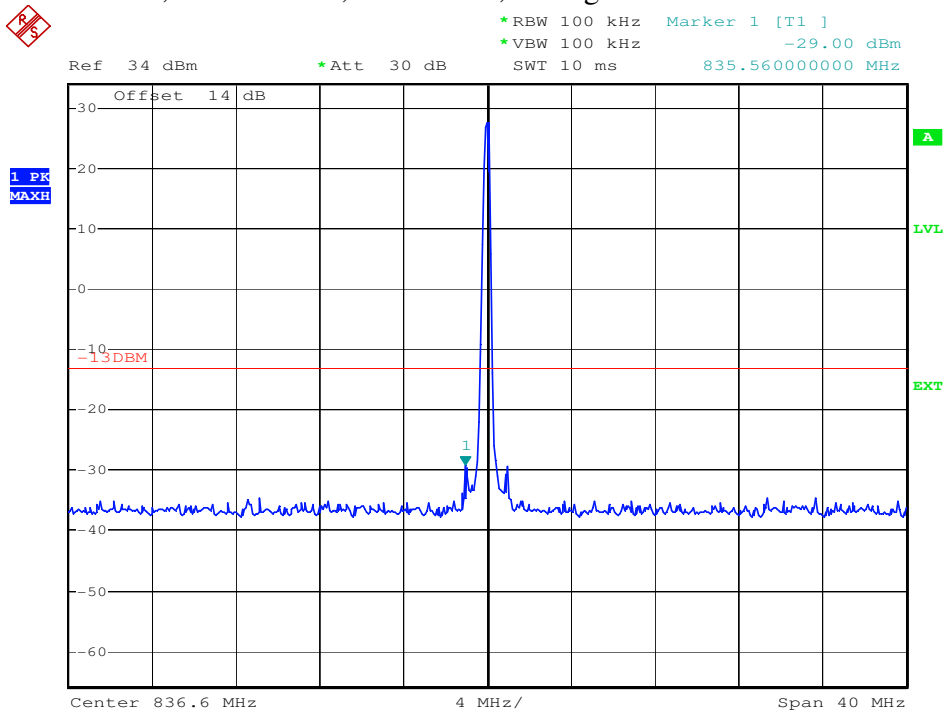

The strong emission shown in each case is the carrier signal.

SIERRA WIRELESS, INC.

Plot 6.4.15) Out of Band Emissions at Antenna Terminals 8-PSK, Mid Channel, 836.6 MHz, 1 GHz to 20 GHz

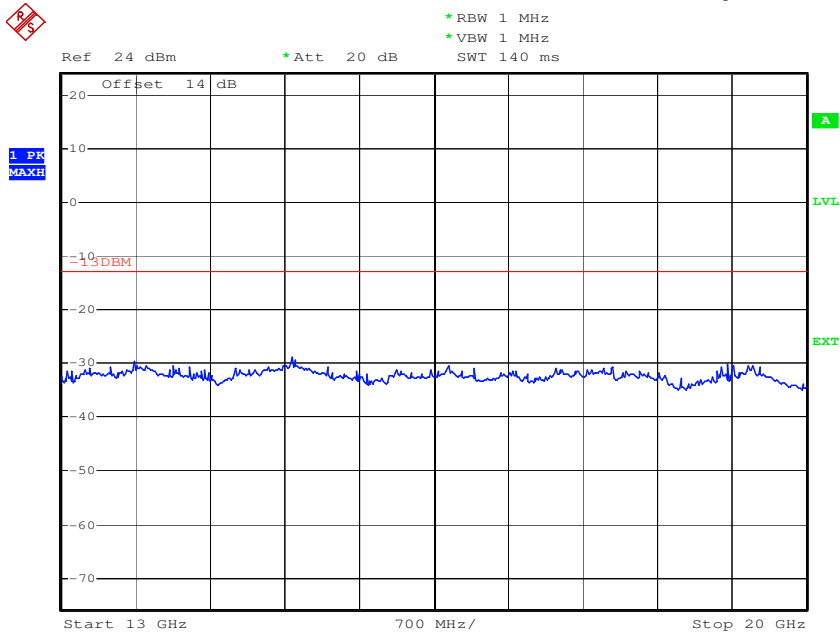
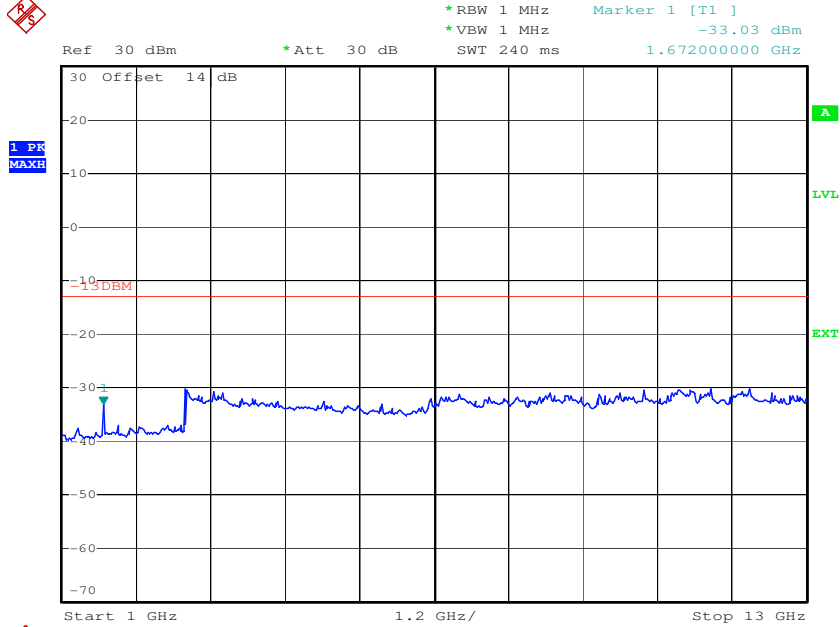

| Cellular Harmonics for Ch. 190 (836.6 MHz) | Level (dBm) |
|---|-----------------------|
| Second | -33.03 dBm |
| Third | ---- |
| All others | < -35 dBm up to 20GHz |

SIERRA WIRELESS, INC.

Plot 6.4.16) Out of Band Emissions at Antenna Terminals
 8-PSK, High Channel, 848.8 MHz, 1 MHz to 1 GHz

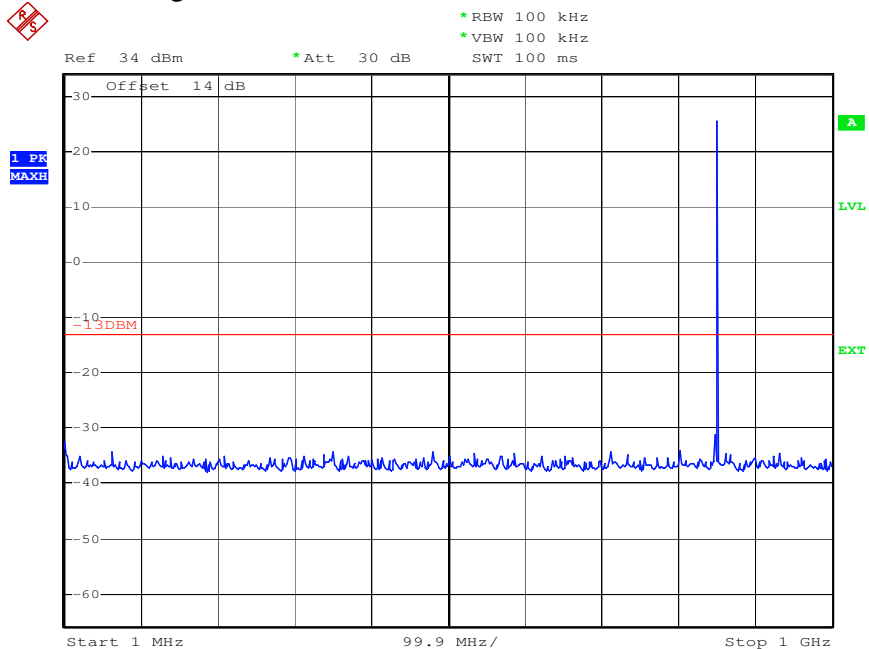

Plot 6.4.17) Out of Band Emissions at Antenna Terminals
 8-PSK, High Channel, 848.8 MHz, TX signal +/- 20 MHz

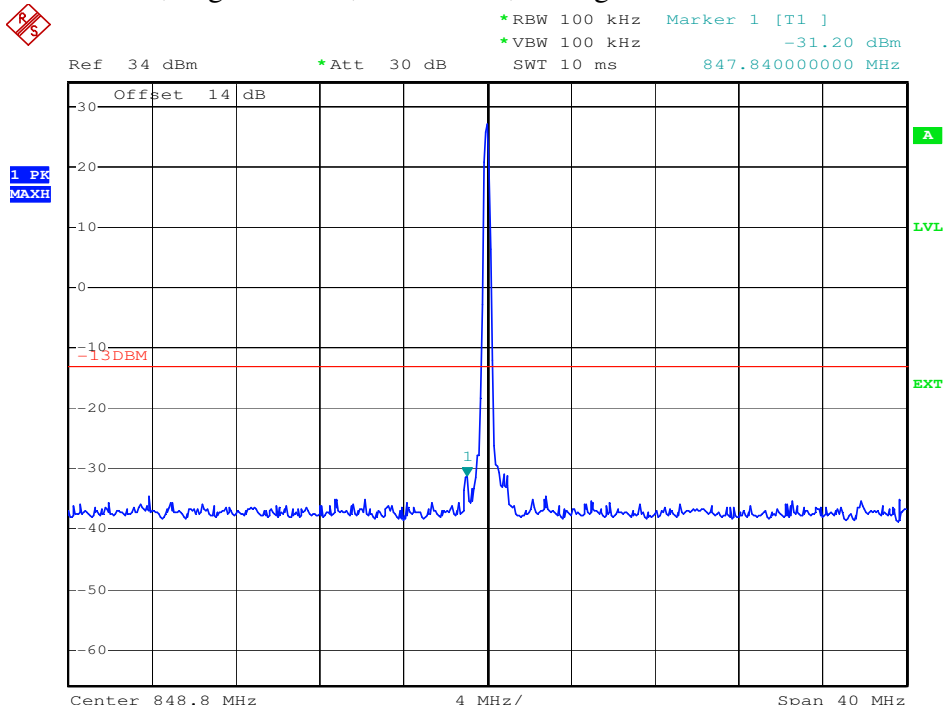

The strong emission shown in each case is the carrier signal.

SIERRA WIRELESS, INC.

Plot 6.4.18) Out of Band Emissions at Antenna Terminals 8-PSK, High Channel, 848.8 MHz, 1 GHz to 20 GHz

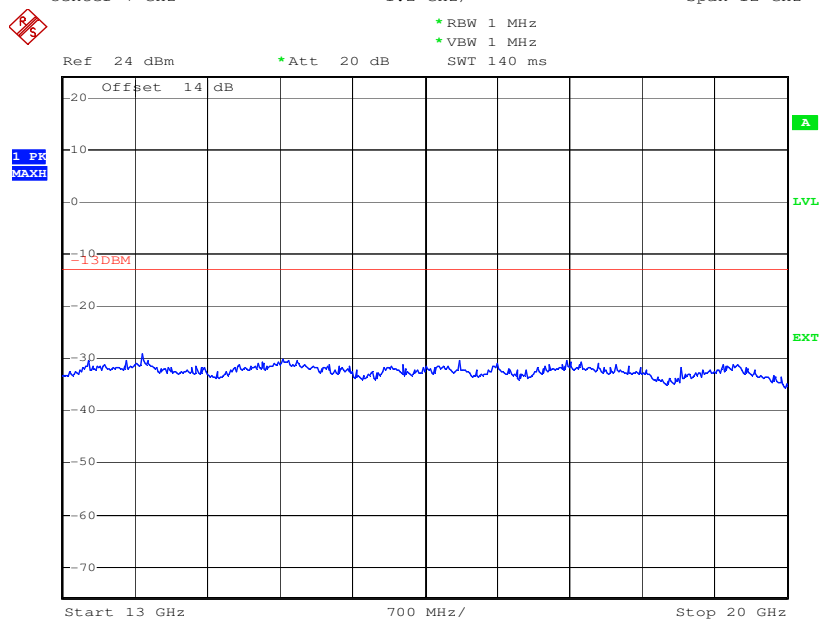
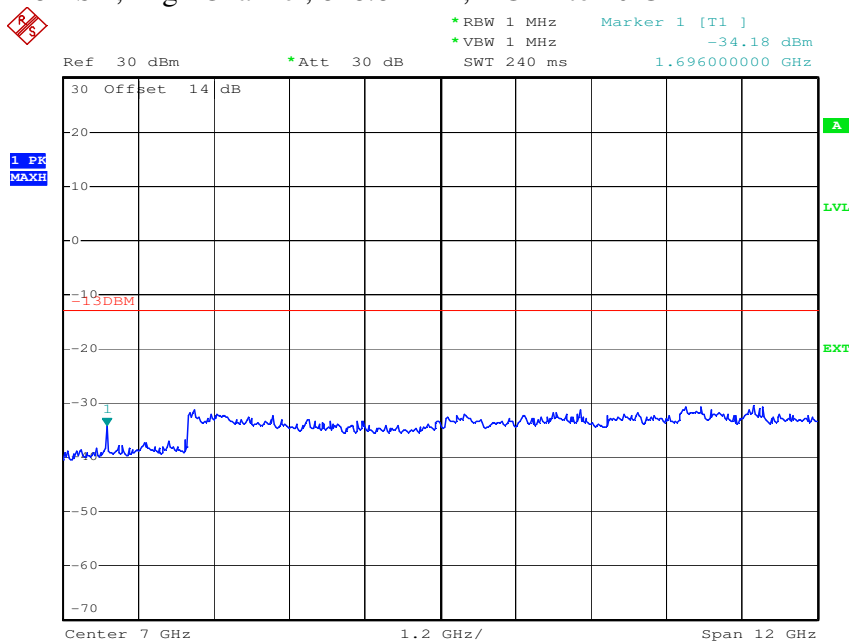

| Cellular Harmonics for Ch. 251 (848.8 MHz) | Level (dBm) |
|--|-----------------------|
| Second | -34.18 dBm |
| Third | ---- |
| All others | < -35 dBm up to 20GHz |

SIERRA WIRELESS, INC.

Plot 6.4.19) Out of Band Emissions at Antenna Terminals
GMSK, Low channel, 1850.2 MHz, 1 MHz to 1 GHz

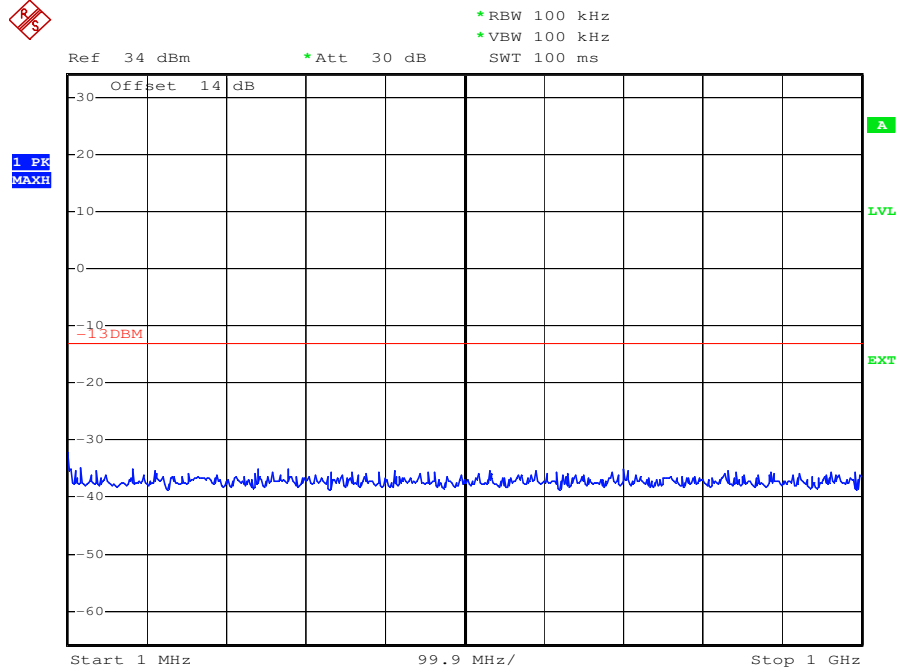

Plot 6.4.20) Out of Band Emissions at Antenna Terminals
GMSK, Low channel, 1850.2 MHz, TX signal +/- 20 MHz

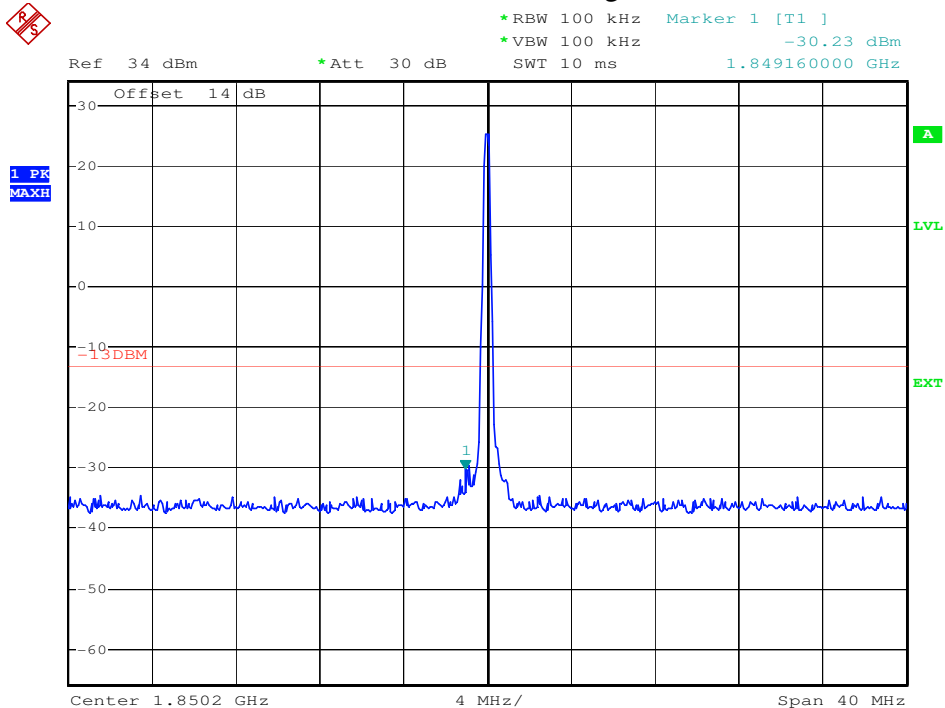

The strong emission shown is the carrier signal.

© 2009 Sierra Wireless, Inc.

The contents of this page are subject to the confidentiality information on page one.

SIERRA WIRELESS, INC.

Plot 6.4.21) Out of Band Emissions at Antenna Terminals
GMSK, Low channel, 1850.2 MHz, 1 GHz to 20 GHz

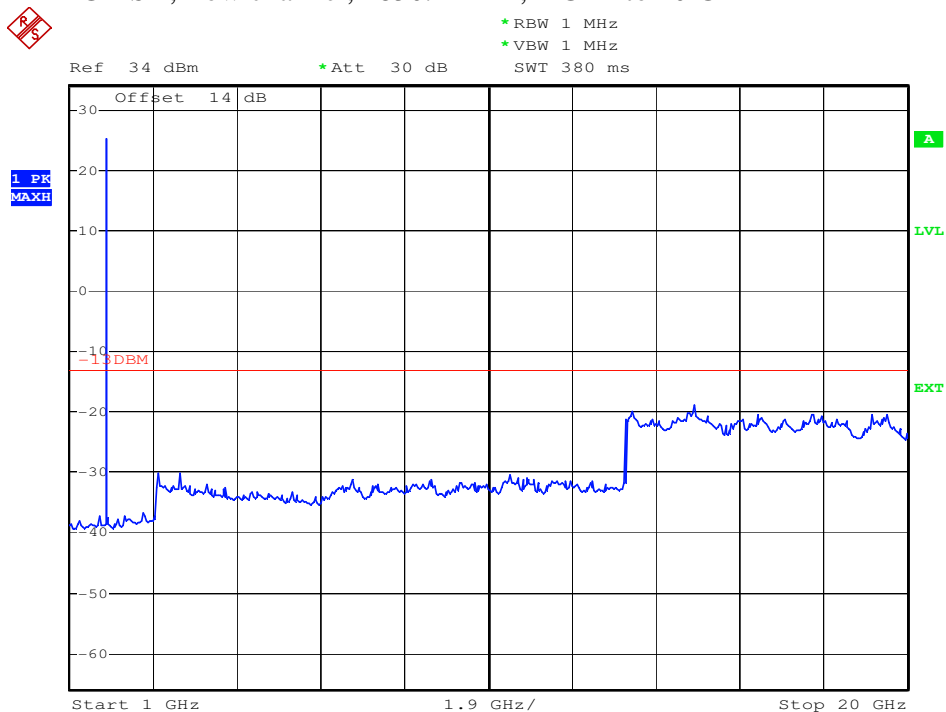

The strong emission shown is the carrier signal.

SIERRA WIRELESS, INC.

Plot 6.4.22) Out of Band Emissions at Antenna Terminals
 GMSK, Middle channel, 1880.0 MHz, 1 MHz to 1 GHz

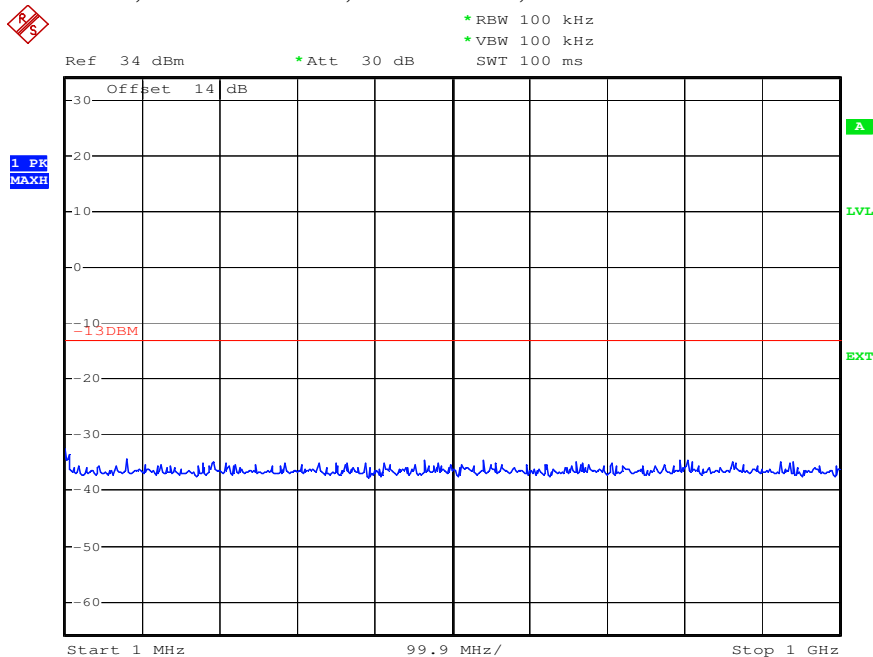

Plot 6.4.23) Out of Band Emissions at Antenna Terminals
 GMSK, Middle channel, 1880.0 MHz, TX signal +/- 20 MHz

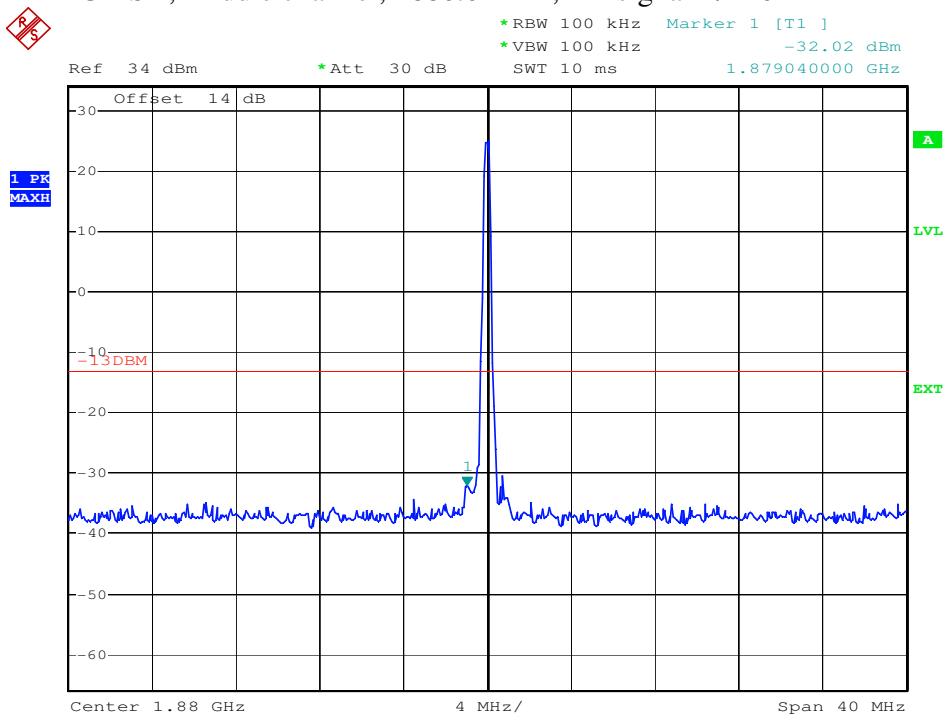

The strong emission shown is the carrier signal.

SIERRA WIRELESS, INC.

Plot 6.4.24) Out of Band Emissions at Antenna Terminals GMSK, Middle channel, 1880.0 MHz, 1 GHz to 20 GHz

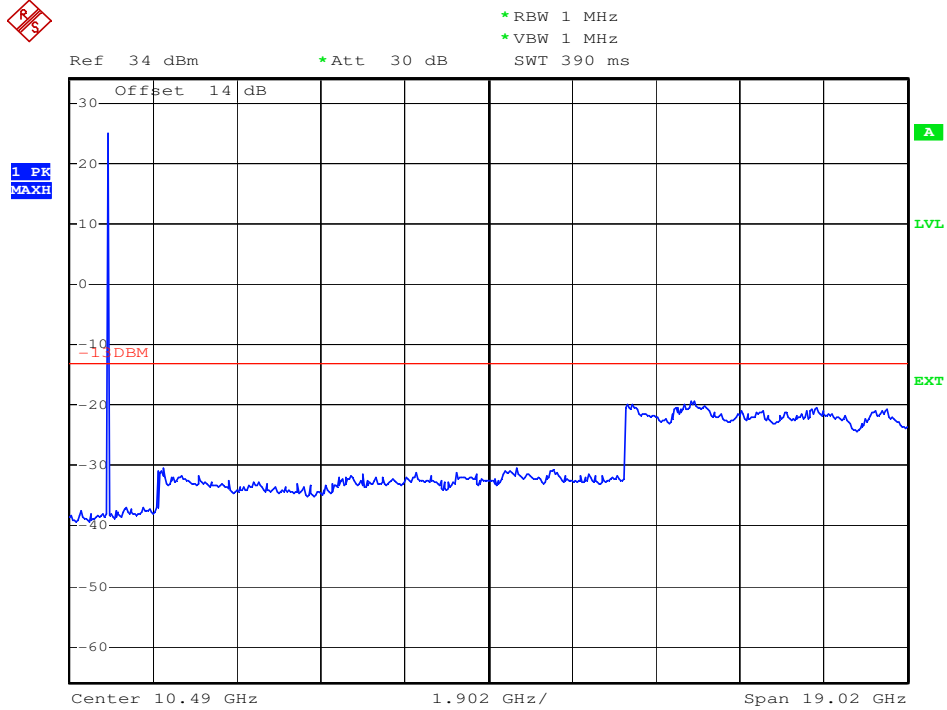

The strong emission shown is the carrier signal.

SIERRA WIRELESS, INC.

Plot 6.4.27) Out of Band Emissions at Antenna Terminals GMSK, High channel, 1909.8 MHz, 1 GHz to 20 GHz

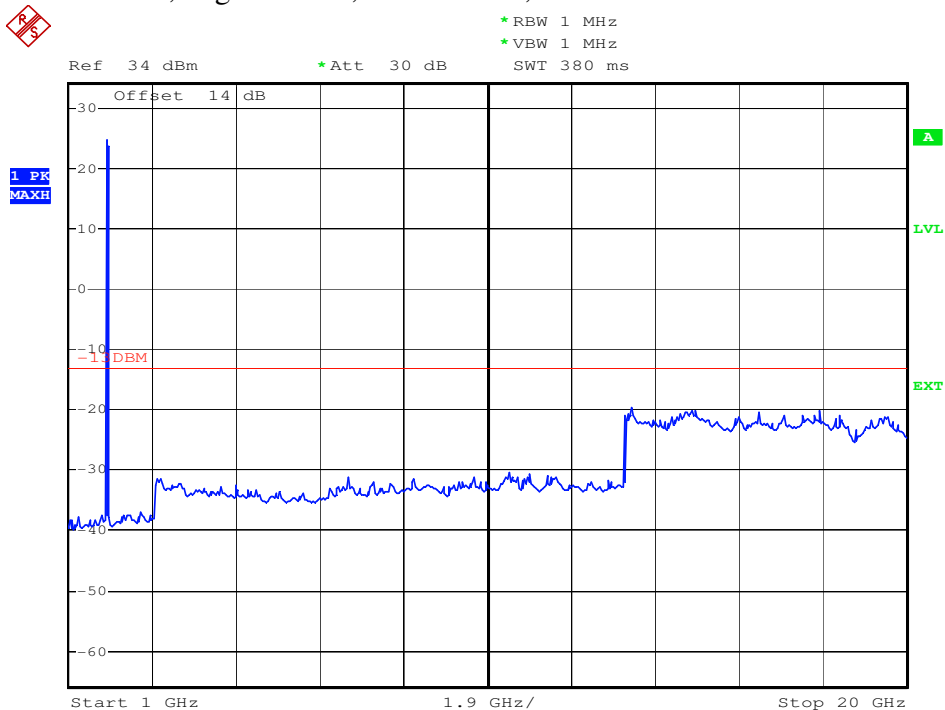

Date: 17.JUN.2009 15:36:32

The strong emission shown is the carrier signal.

SIERRA WIRELESS, INC.

Plot 6.4.28) Out of Band Emissions at Antenna Terminals
 8-PSK, Low channel, 1850.2 MHz, 1 MHz to 1 GHz

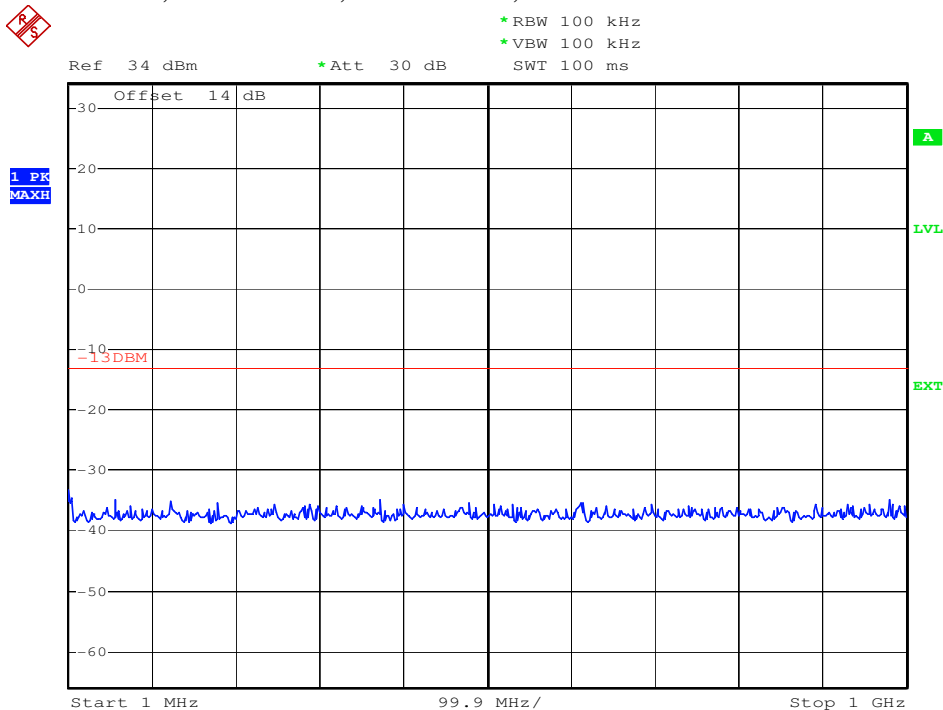

Plot 6.4.29) Out of Band Emissions at Antenna Terminals
 8-PSK, Low channel, 1850.2 MHz, TX signal +/- 20 MHz

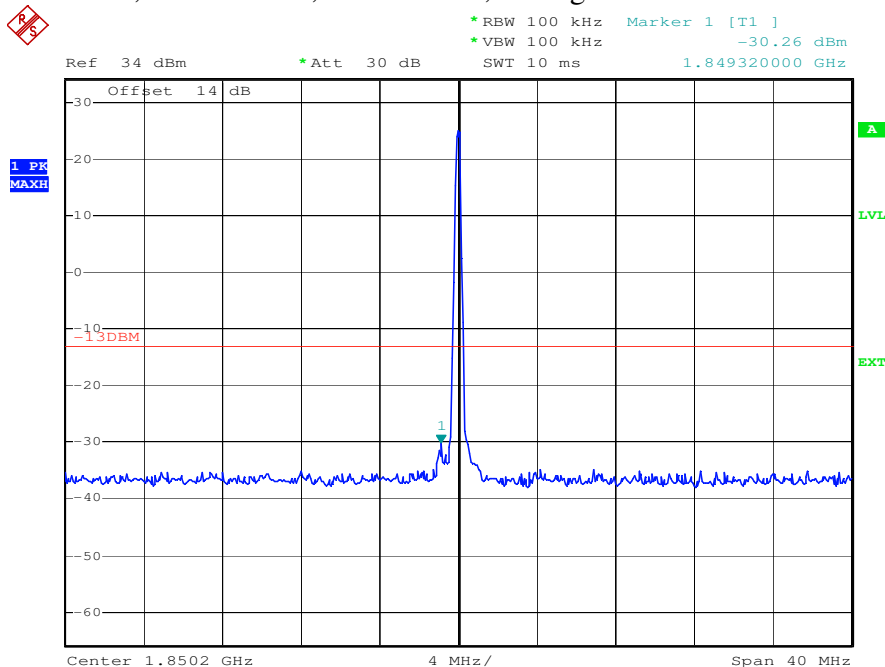

The strong emission shown is the carrier signal.

© 2009 Sierra Wireless, Inc.

The contents of this page are subject to the confidentiality information on page one.

SIERRA WIRELESS, INC.

Plot 6.4.30) Out of Band Emissions at Antenna Terminals
8-PSK, Low channel, 1850.2 MHz, 1 GHz to 20 GHz

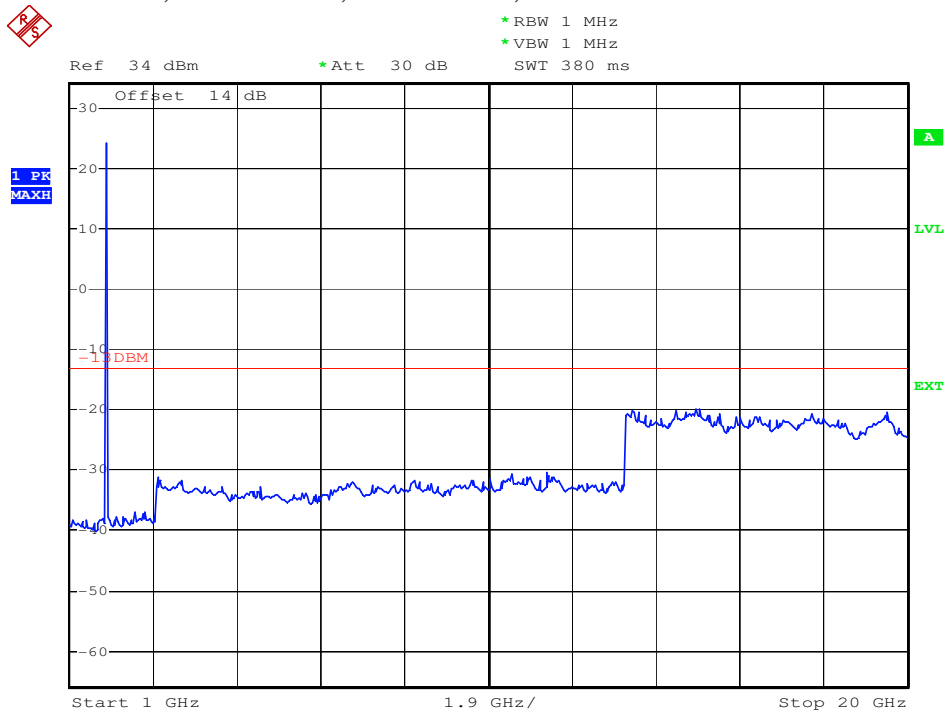

The strong emission shown is the carrier signal.

SIERRA WIRELESS, INC.

Plot 6.4.31) Out of Band Emissions at Antenna Terminals
8-PSK, Middle channel, 1880.0 MHz, 1 MHz to 1 GHz

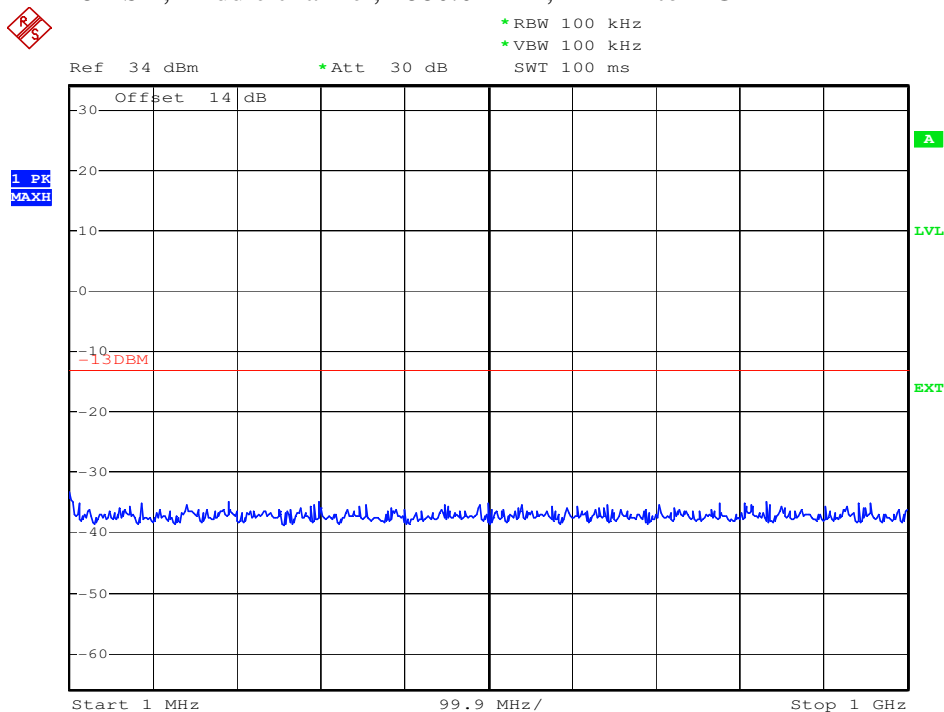

Plot 6.4.32) Out of Band Emissions at Antenna Terminals
8-PSK, Middle channel, 1880.0 MHz, TX signal +/- 20 MHz

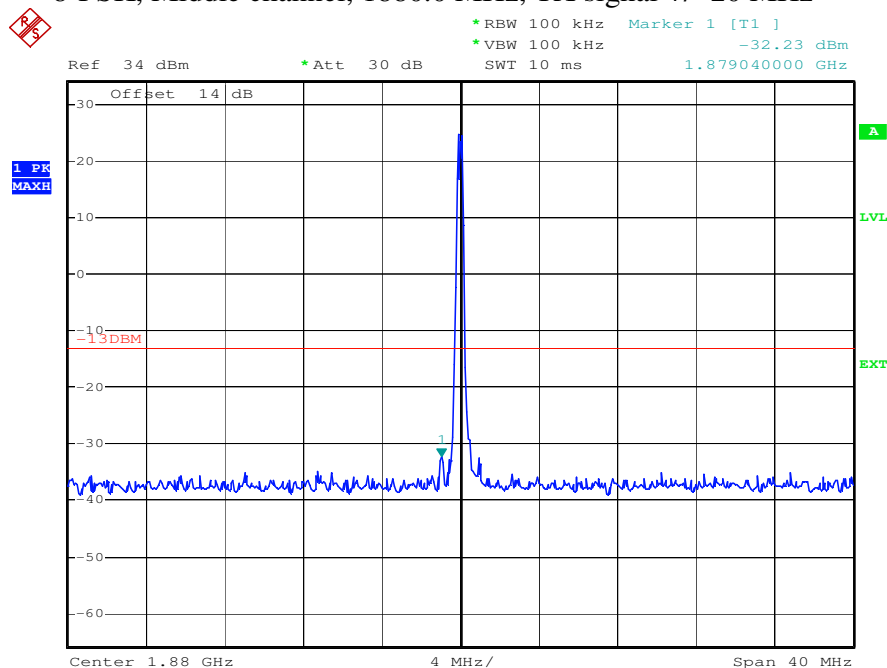

The strong emission shown is the carrier signal.

© 2009 Sierra Wireless, Inc.

The contents of this page are subject to the confidentiality information on page one.

SIERRA WIRELESS, INC.

Plot 6.4.33) Out of Band Emissions at Antenna Terminals
8-PSK, Middle channel, 1880.0 MHz, 1 GHz to 20 GHz

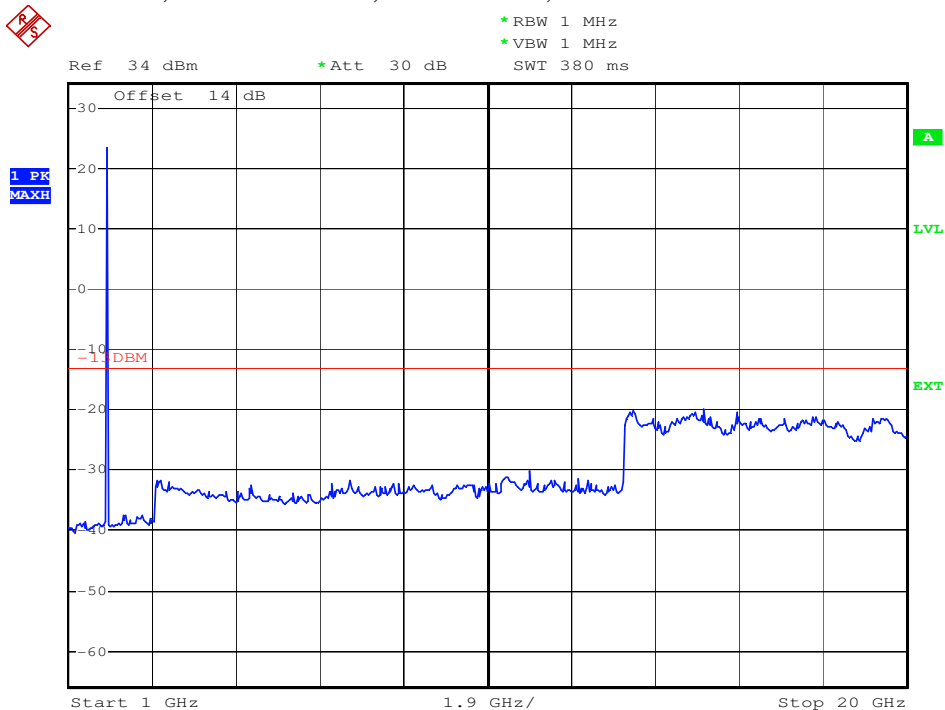

Date: 17.JUN.2009 15:42:35

The strong emission shown is the carrier signal.

SIERRA WIRELESS, INC.

Plot 6.4.34) Out of Band Emissions at Antenna Terminals
 8-PSK, High channel, 1909.8 MHz, 1 MHz to 1 GHz

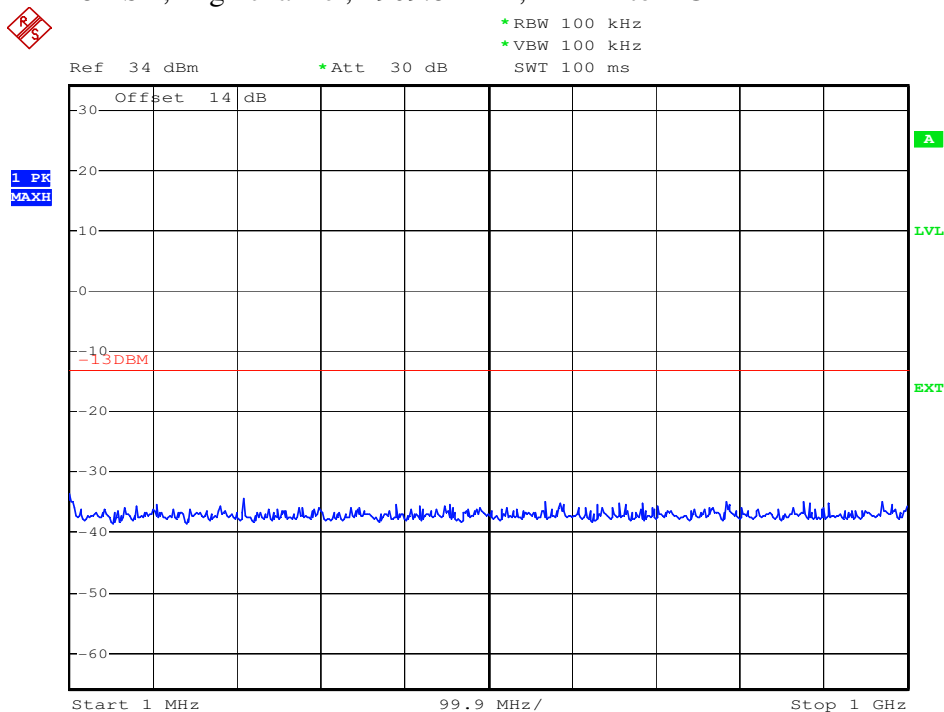

Plot 6.4.35) Out of Band Emissions at Antenna Terminals
 8-PSK, High channel, 1909.8 MHz, TX signal +/- 20 MHz

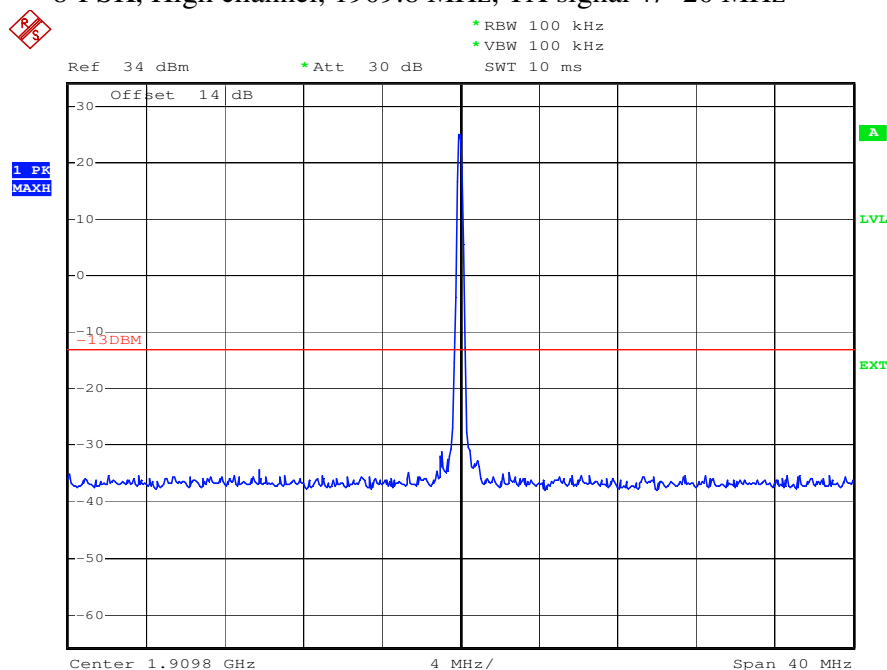

The strong emission shown is the carrier signal.

SIERRA WIRELESS, INC.

Plot 6.4.36) Out of Band Emissions at Antenna Terminals
8-PSK, High channel, 1909.8 MHz, 1 GHz to 20 GHz

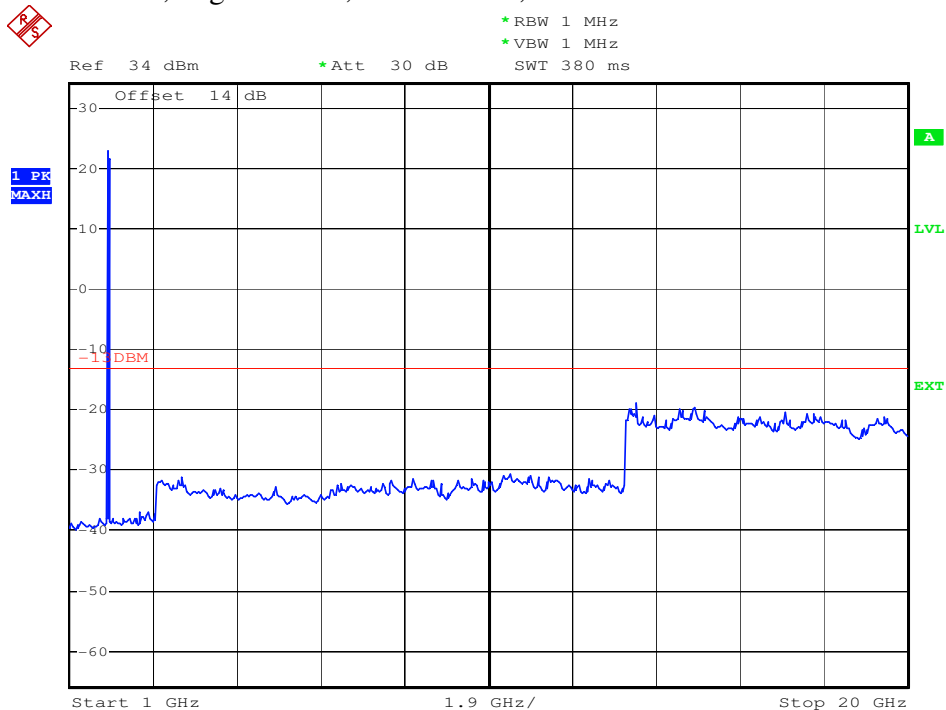

Date: 17.JUN.2009 15:44:59

The strong emission shown is the carrier signal.

Plot 6.4.37) Out of Band Emissions at Antenna Terminals
WCDMA, Low channel, 826.4 MHz, 1 MHz to 1 GHz

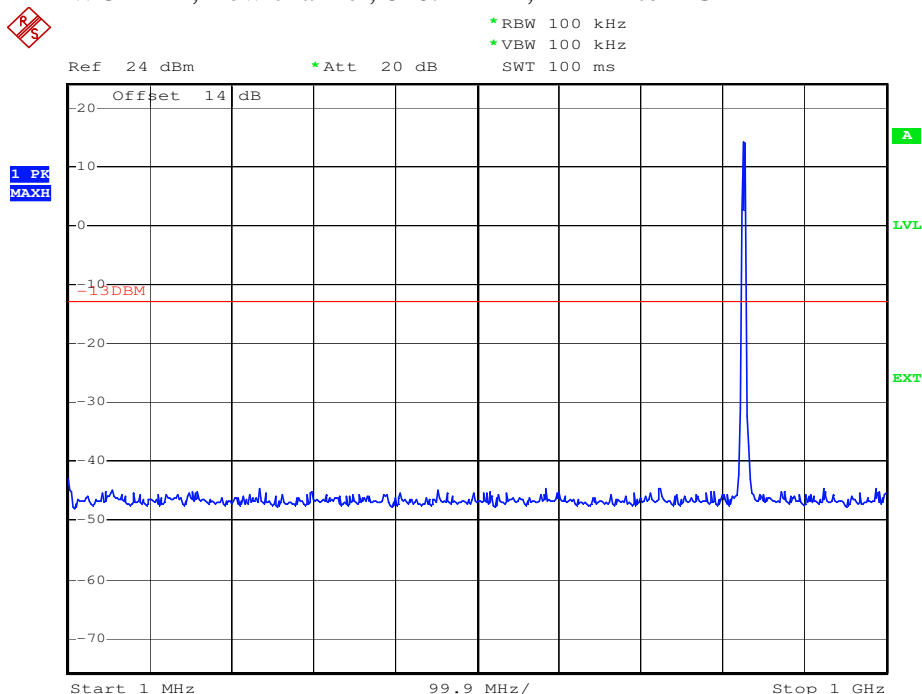

Plot 6.4.38) Out of Band Emissions at Antenna Terminals
WCDMA, Low channel, 826.4 MHz, TX signal +/- 20 MHz

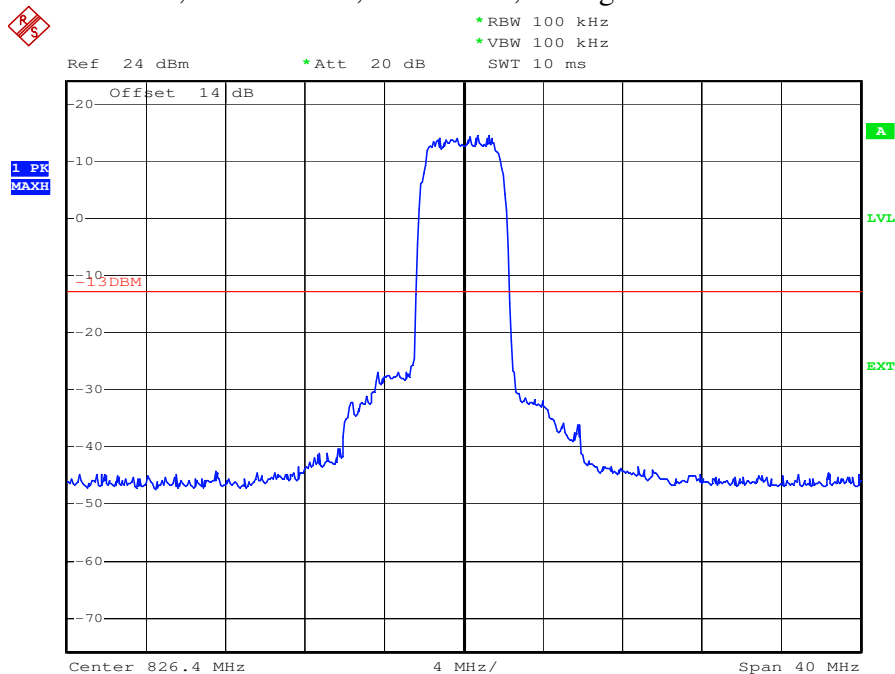

The strong emission shown in each case is the carrier signal.

© 2009 Sierra Wireless, Inc.

The contents of this page are subject to the confidentiality information on page one.

SIERRA WIRELESS, INC.

Plot 6.4.39) Out of Band Emissions at Antenna Terminals
WCDMA, Low channel, 826.4 MHz, 1 GHz to 20 GHz

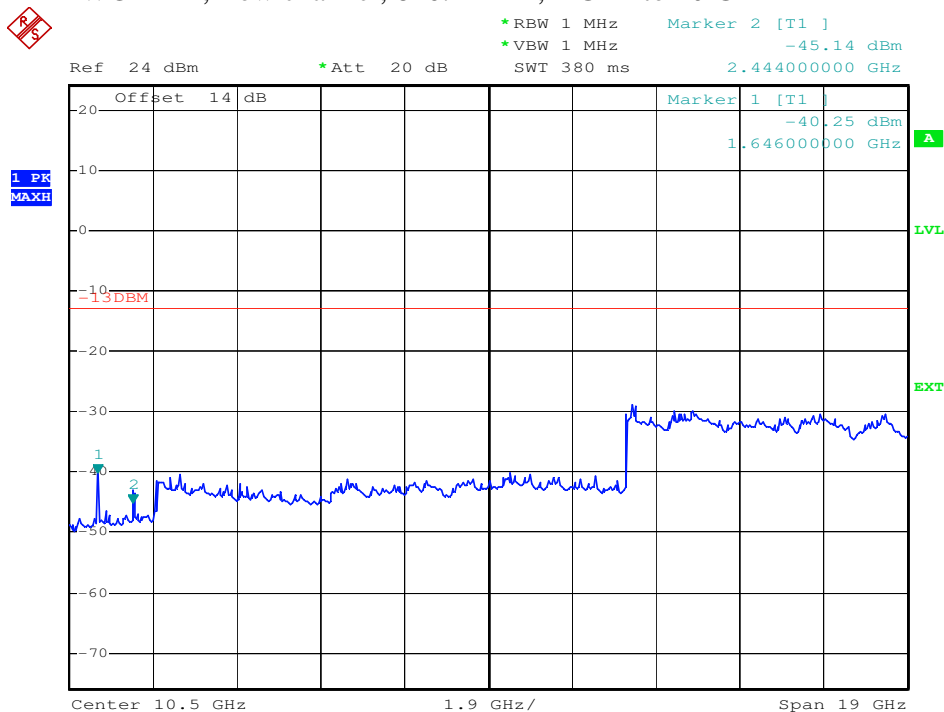

| Cellular Harmonics for Ch. 4132 (826.4 MHz) | Level (dBm) |
|---|-----------------------|
| Second | -40.25 dBm |
| Third | -45.14 dBm |
| All others | < -35 dBm up to 20GHz |

SIERRA WIRELESS, INC.

Plot 6.4.40) Out of Band Emissions at Antenna Terminals

WCDMA, Middle channel, 836.4 MHz, 1 MHz to 1 GHz

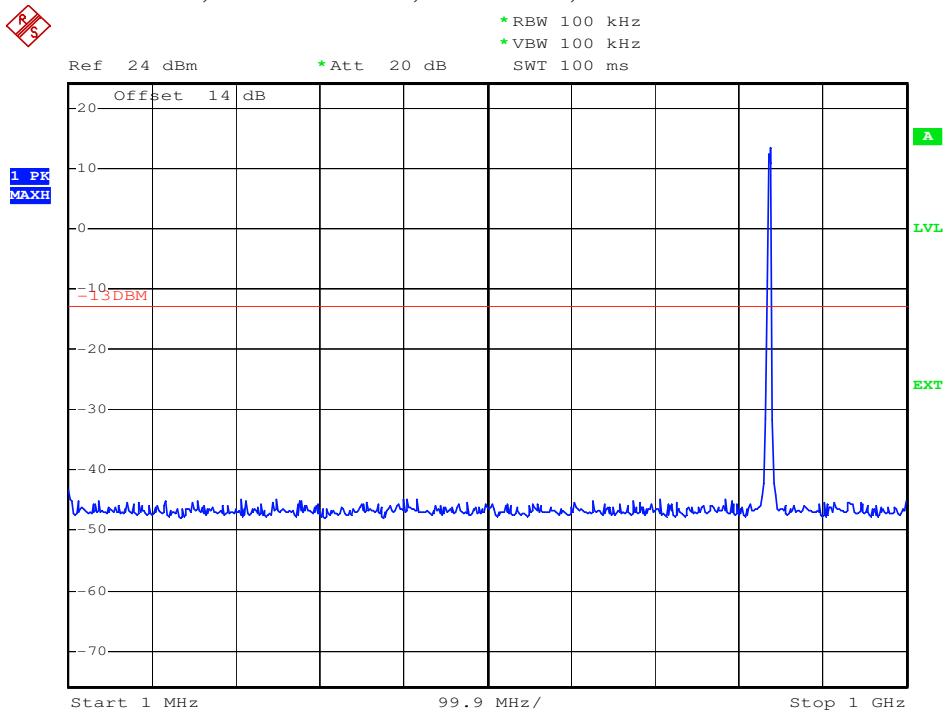

Plot 6.4.41) Out of Band Emissions at Antenna Terminals

WCDMA, Middle channel, 836.4 MHz, TX signal +/- 20 MHz

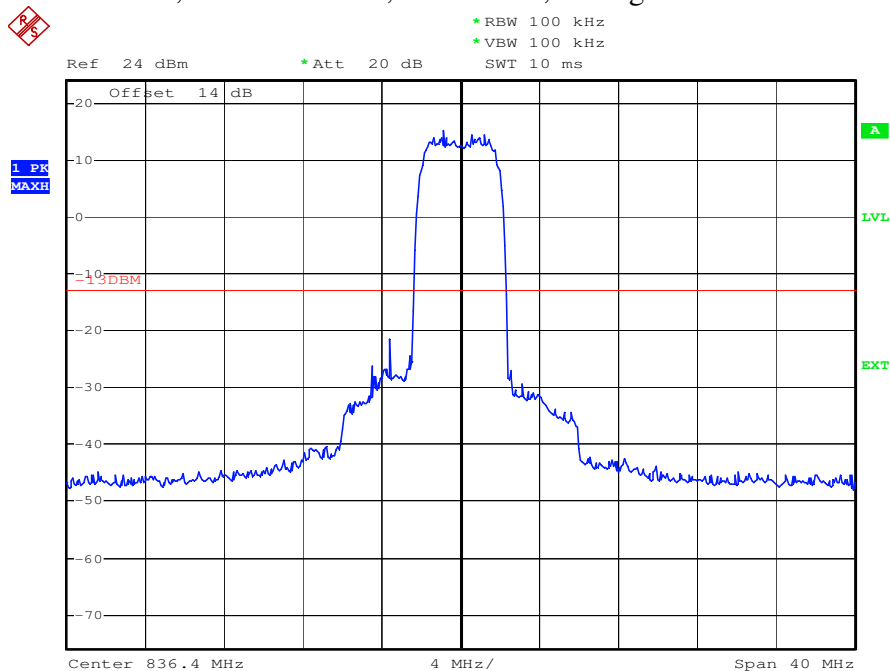

The strong emission shown in each case is the carrier signal.

© 2009 Sierra Wireless, Inc.

The contents of this page are subject to the confidentiality information on page one.

SIERRA WIRELESS, INC.

Plot 6.4.42) Out of Band Emissions at Antenna Terminals
WCDMA, Middle channel, 836.4 MHz, 1 GHz to 20 GHz

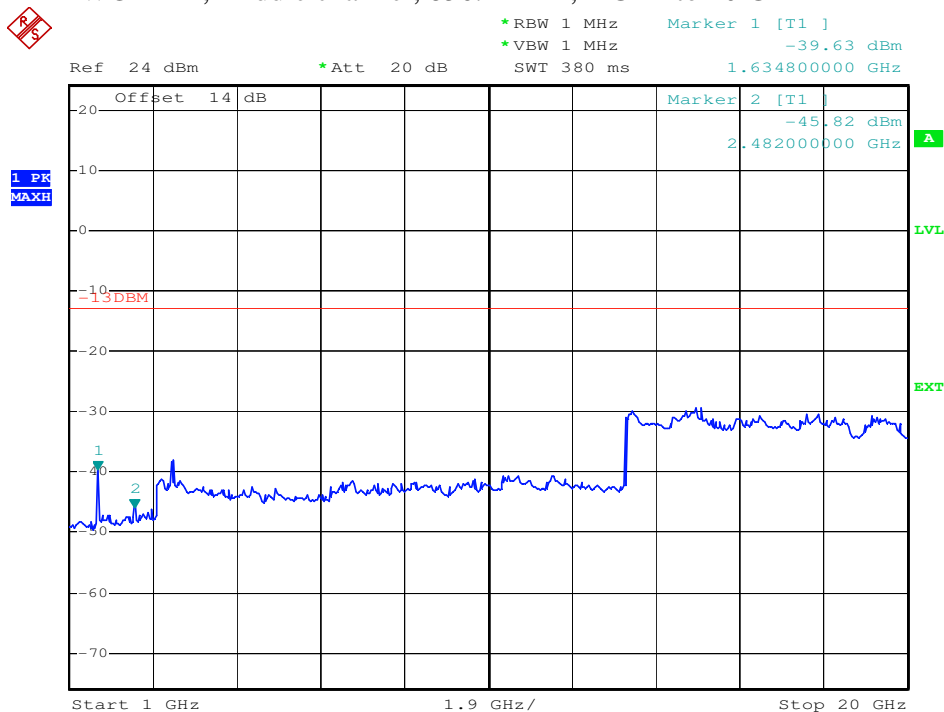

| Cellular Harmonics for Ch. 4182 (836.4 MHz) | Level (dBm) |
|---|-----------------------|
| Second | -39.62 dBm |
| Third | ---- |
| All others | < -35 dBm up to 20GHz |

SIERRA WIRELESS, INC.

Plot 6.4.43) Out of Band Emissions at Antenna Terminals
WCDMA, High Channel, 846.6 MHz, 1 MHz to 1 GHz

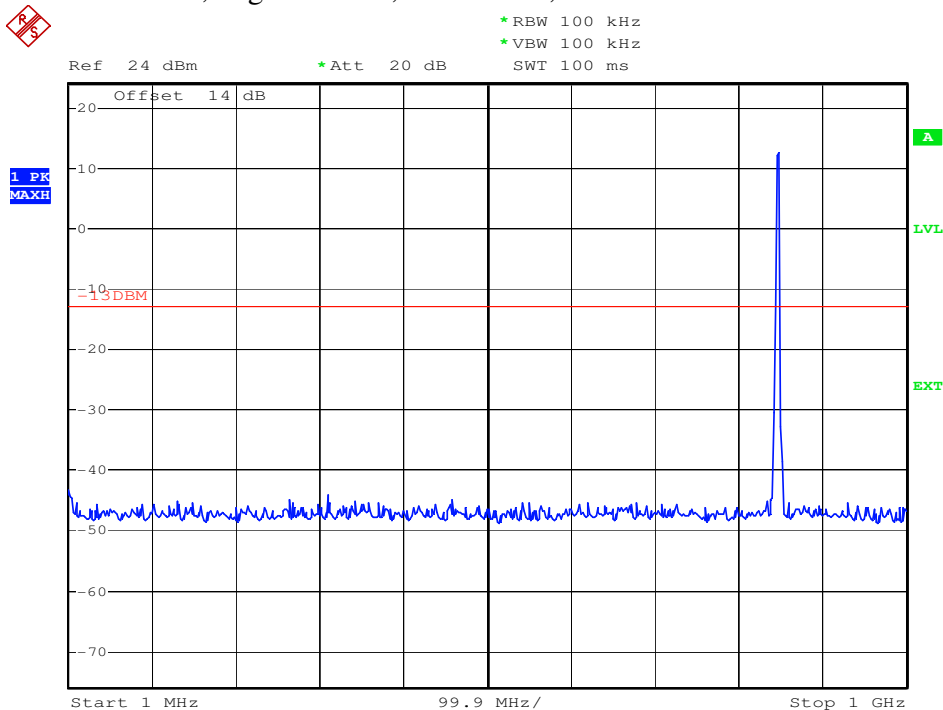

Plot 6.4.44) Out of Band Emissions at Antenna Terminals
WCDMA, High Channel, 846.6 MHz, TX signal +/- 20 MHz

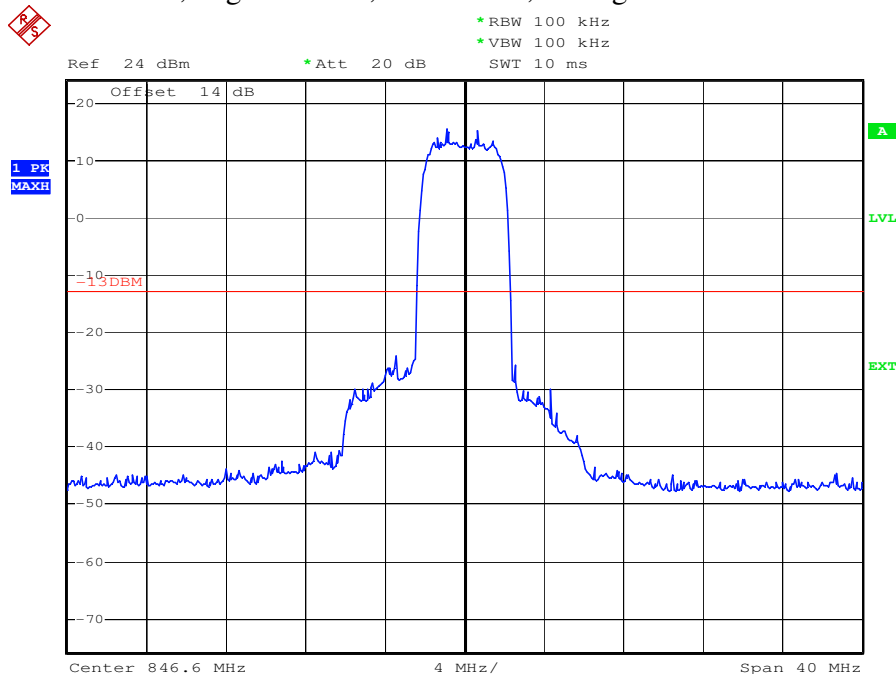

The strong emission shown in each case is the carrier signal.

© 2009 Sierra Wireless, Inc.

The contents of this page are subject to the confidentiality information on page one.

SIERRA WIRELESS, INC.

Plot 6.4.45) Out of Band Emissions at Antenna Terminals
WCDMA, High Channel, 846.6 MHz, 1 GHz to 20 GHz

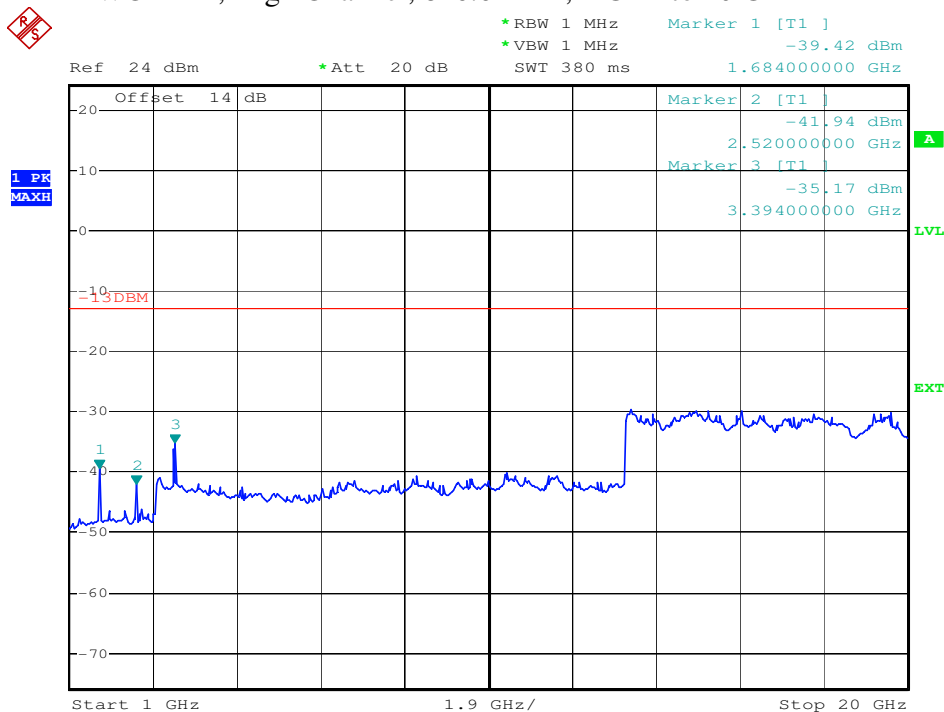

Date: 17.JUN.2009 16:20:38

| Cellular Harmonics for Ch. 4233 (846.6 MHz) | Level (dBm) |
|---|-----------------------|
| Second | -39.42 dBm |
| Third | -41.94 dBm |
| Fourth | -35.17 dBm |
| All others | < -35 dBm up to 20GHz |

SIERRA WIRELESS, INC.

Plot 6.4.48) Out of Band Emissions at Antenna Terminals
WCDMA, Low channel, 1852.4 MHz, 1 GHz to 20 GHz

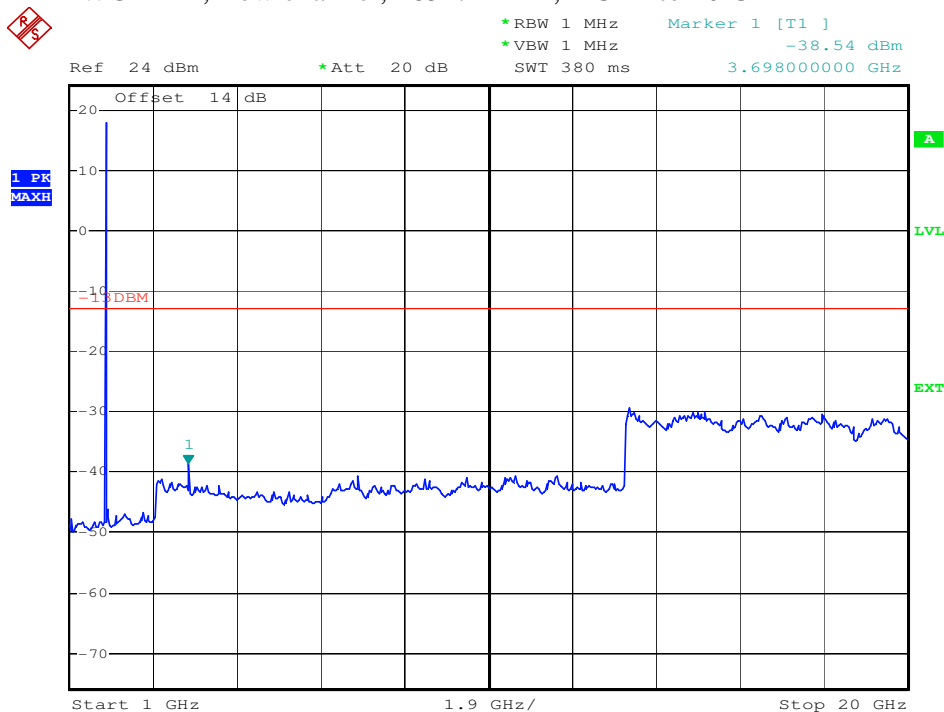

Date: 17.JUN.2009 16:26:25

The strong emission shown is the carrier signal.

| PCS Harmonics for Ch. 9262 (1852.4 MHz) | Level (dBm) |
|---|-----------------------|
| Second | - 38.54 dBm |
| Third | -- |
| All others | < -35 dBm up to 20GHz |

SIERRA WIRELESS, INC.

Plot 6.4.49) Out of Band Emissions at Antenna Terminals

WCDMA, Middle channel, 1880 MHz, 1 MHz to 1 GHz

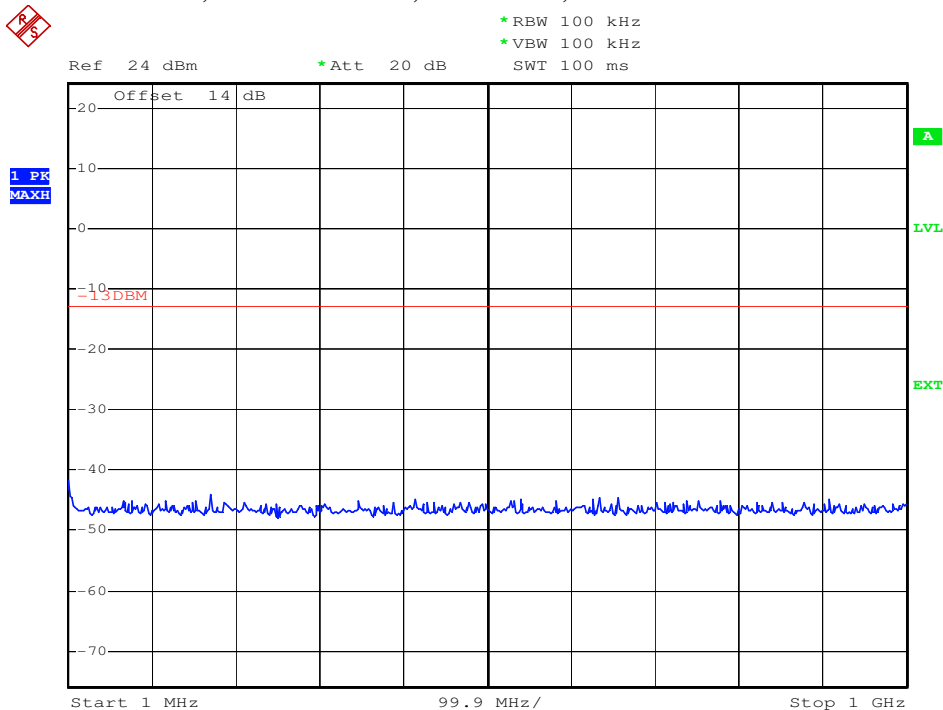

Plot 6.4.50) Out of Band Emissions at Antenna Terminals

WCDMA, Middle channel, 1880 MHz, TX signal +/- 20 MHz

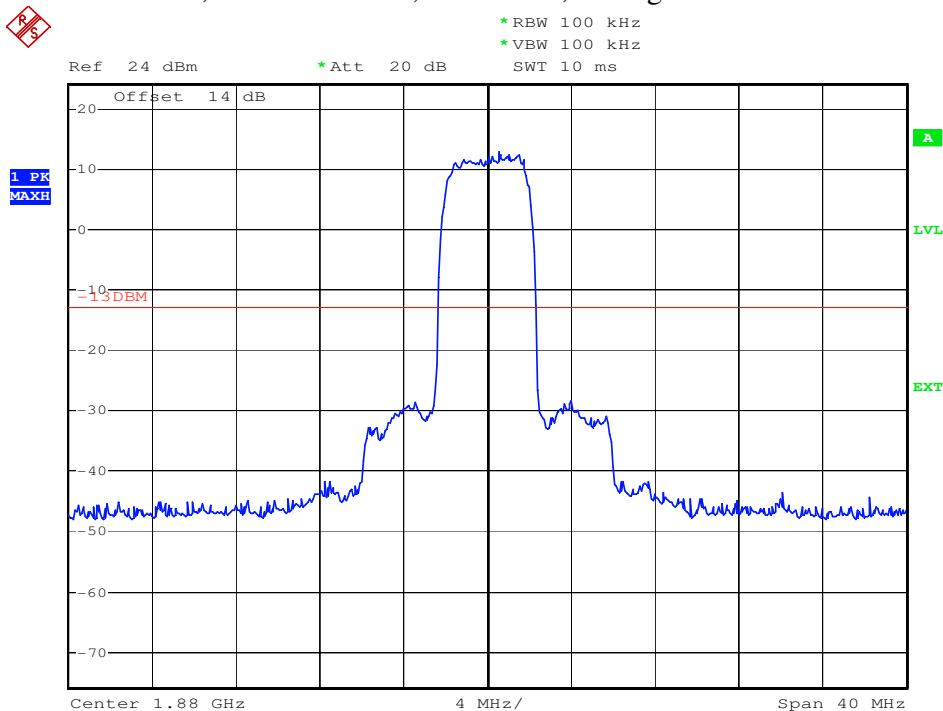

SIERRA WIRELESS, INC.

Plot 6.4.51) Out of Band Emissions at Antenna Terminals
WCDMA, Middle channel, 1880 MHz, 1 GHz to 20 GHz

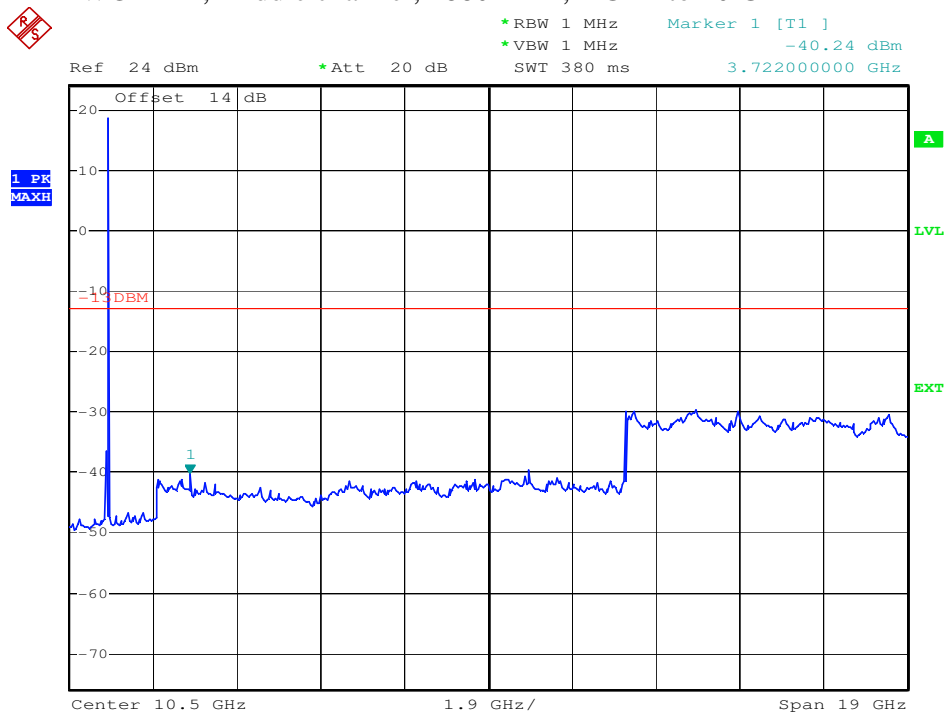

The strong emission shown is the carrier signal.

| PCS Harmonics for Ch. 9400 (1880.0 MHz) | Level (dBm) |
|---|-----------------------|
| Second | -40.2 dBm |
| Third | ---- |
| All others | < -35 dBm up to 20GHz |

SIERRA WIRELESS, INC.

Plot 6.4.54) Out of Band Emissions at Antenna Terminals
WCDMA, High channel, 1907.6 MHz, 1 GHz to 20 GHz

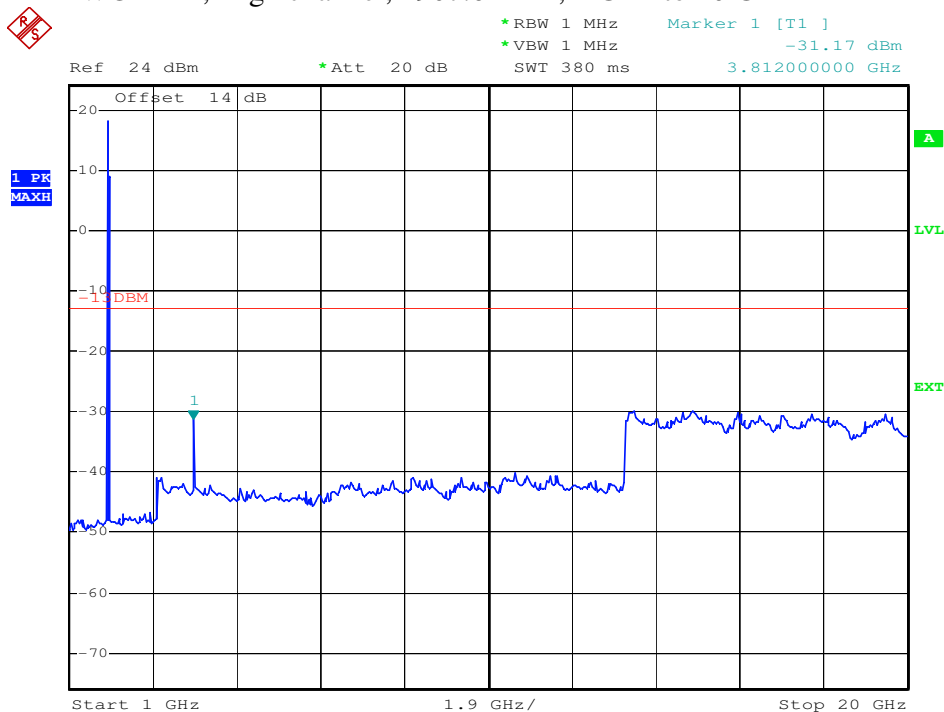

The strong emission shown is the carrier signal.

| PCS Harmonics for Ch. 9538 (1907.6 MHz) | Level (dBm) |
|---|-----------------------|
| Second | -31.17 dBm |
| Third | ---- |
| All others | < -35 dBm up to 20GHz |

SIERRA WIRELESS, INC.

7 Block Edge Compliance

FCC Part 22H/24E

7.1 Test Procedure

The transmitter output was connected to a Rohde & Schwarz CMU200 Test Set and configured to operate at maximum power. The block edge emissions were measured at the required operating frequencies in each band on the Spectrum Analyzer.

Test Setup

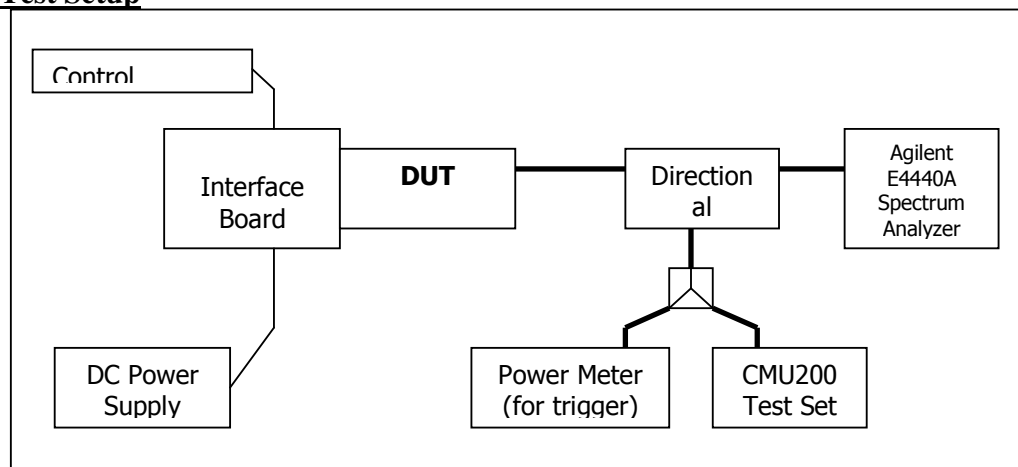

7.2 Test Equipment

| EQUIPMENT | MANUFACTURER | MODEL NO. | SERIAL NO. | CAL. DATE |
|---------------------|-----------------|------------|------------|-------------------|
| Control Computer | TC | Generic PC | 100488 | N/A |
| Wireless Test Set | Rohde & Schwarz | CMU200 | 110520 | November 17, 2009 |
| Spectrum Analyzer | Rohde & Schwarz | FSP | 100060 | November 15, 2009 |
| DC Power Supply | HP | 6632A | 3530A | N/A |
| Interface Board | Shop built | ATEMux | N/A | N/A |
| Directional Coupler | Pasternack | PE2209-10 | N/A | N/A |

7.3 Test Results

| Block Test | Frequency Boundaries (MHz) | Channels Tested | Corresponding Plots | Result |
|------------|-------------------------------------|-----------------|---------------------|----------|
| 1 | GMSK: Below 824 MHz, above 849 MHz | 128, 251 | 7.4.1, 7.4.2 | Complies |
| 2 | 8PSK: Below 824 MHz, above 849 MHz | 128, 251 | 7.4.3, 7.4.4 | Complies |
| 3 | GMSK: Below 1850MHz, above 1910MHz | 512, 810 | 7.4.5, 7.4.6 | Complies |
| 4 | 8PSK: Below 1850MHz, above 1910MHz | 512, 810 | 7.4.7, 7.4.8 | Complies |
| Block Test | Frequency Boundaries (MHz) | Channels Tested | Corresponding Plots | Result |
| 1 | WCDMA: Below 824MHz, above 849MHz | 4132, 4233 | 7.4.9, 7.4.10 | Complies |
| 2 | WCDMA: Below 1850MHz, above 1910MHz | 9262, 9538 | 7.4.11, 7.4.12 | Complies |

© 2009 Sierra Wireless, Inc.

The contents of this page are subject to the confidentiality information on page one.

SIERRA WIRELESS, INC.

7.4 Test Plots

Plot 7.4.1) GSMK; Cellular low channel, below 824 MHz

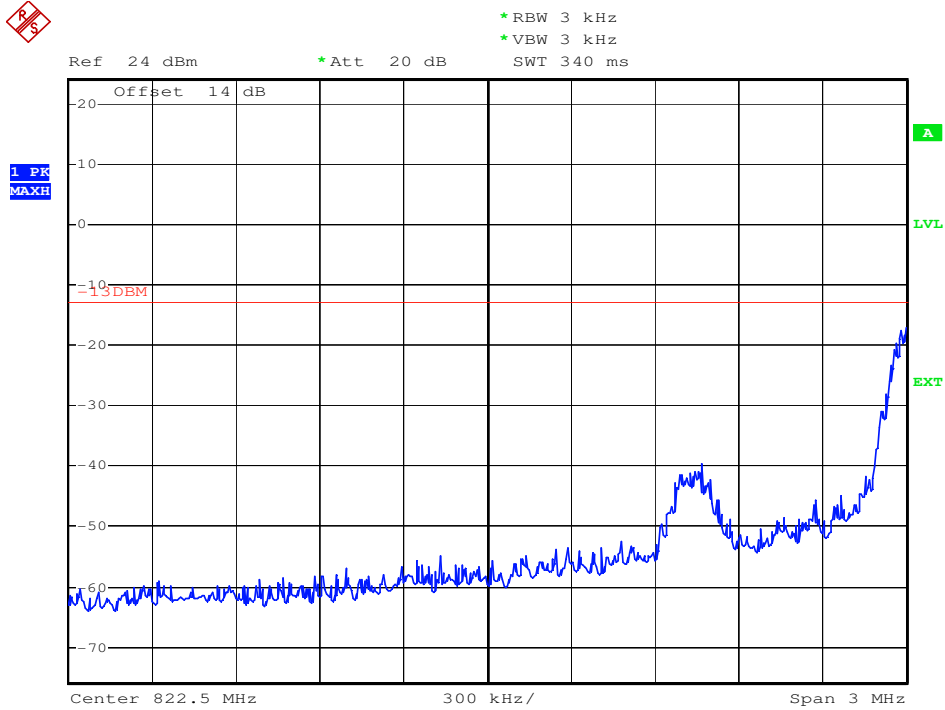

Plot 7.4.2) GMSK; Cellular high channel, above 849 MHz

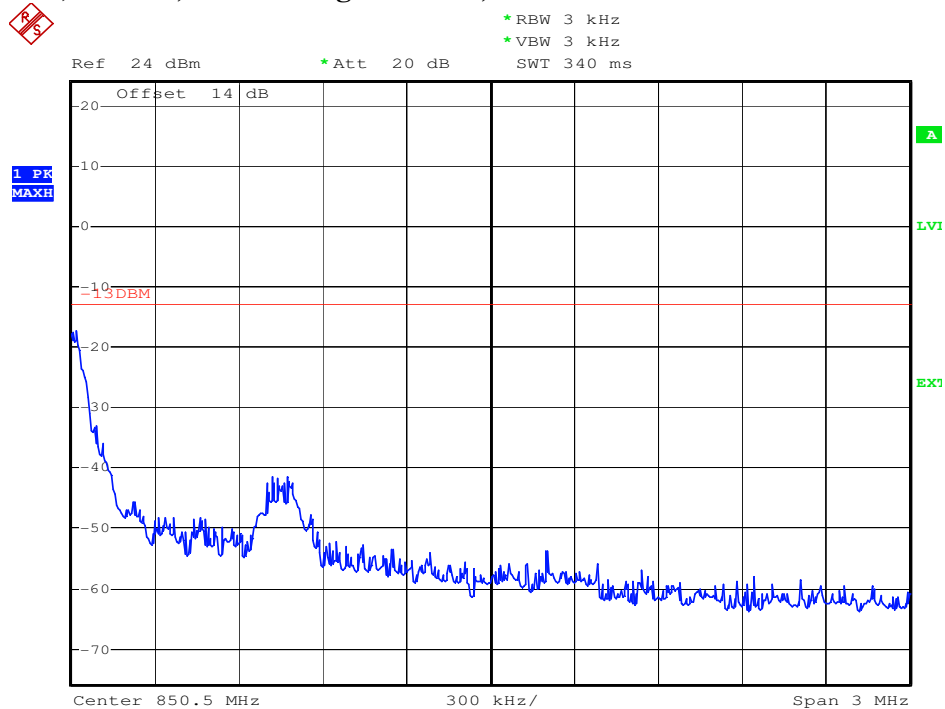

© 2009 Sierra Wireless, Inc.

The contents of this page are subject to the confidentiality information on page one.

SIERRA WIRELESS, INC.

Plot 7.4.3) 8-PSK; Cellular low channel, below 824 MHz

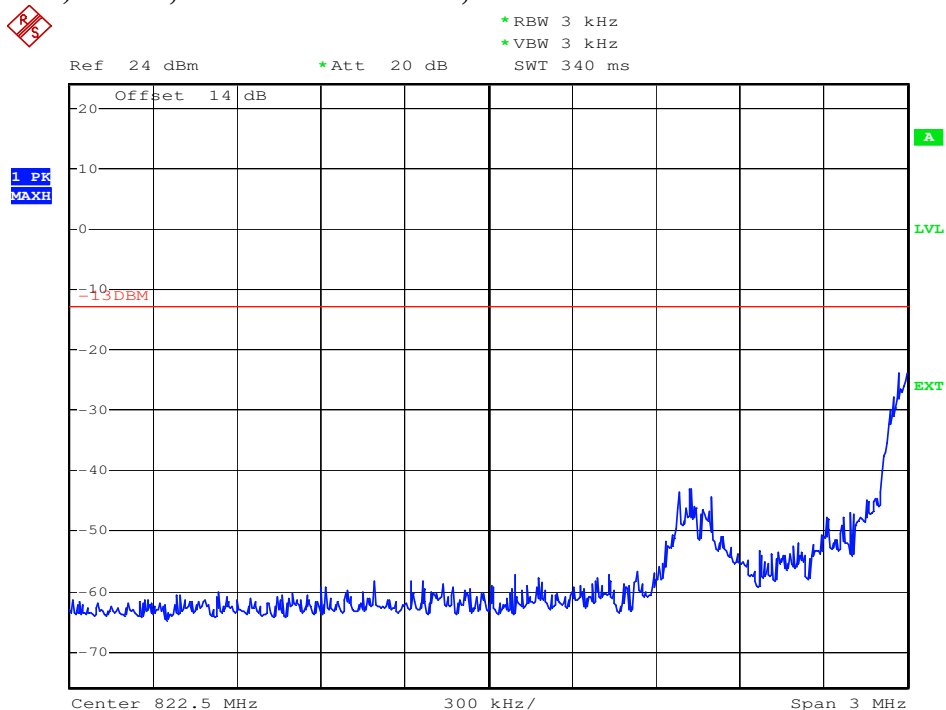

Plot 7.4.4) 8-PSK; Cellular high channel, above 849 MHz

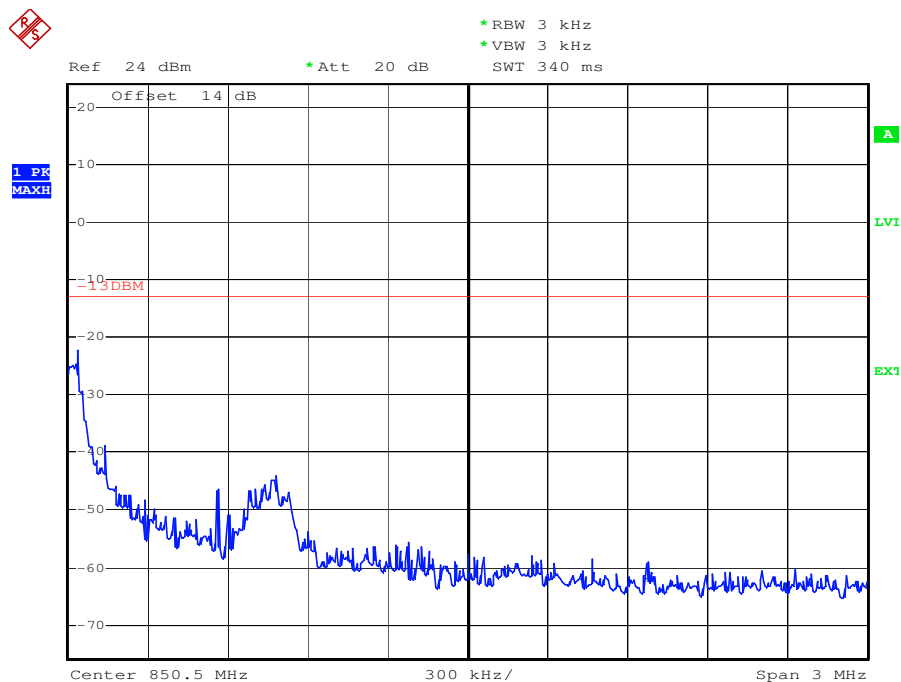

© 2009 Sierra Wireless, Inc.

The contents of this page are subject to the confidentiality information on page one.

SIERRA WIRELESS, INC.

Plot 7.4.5) GMSK; PCS low channel, below 1850 MHz

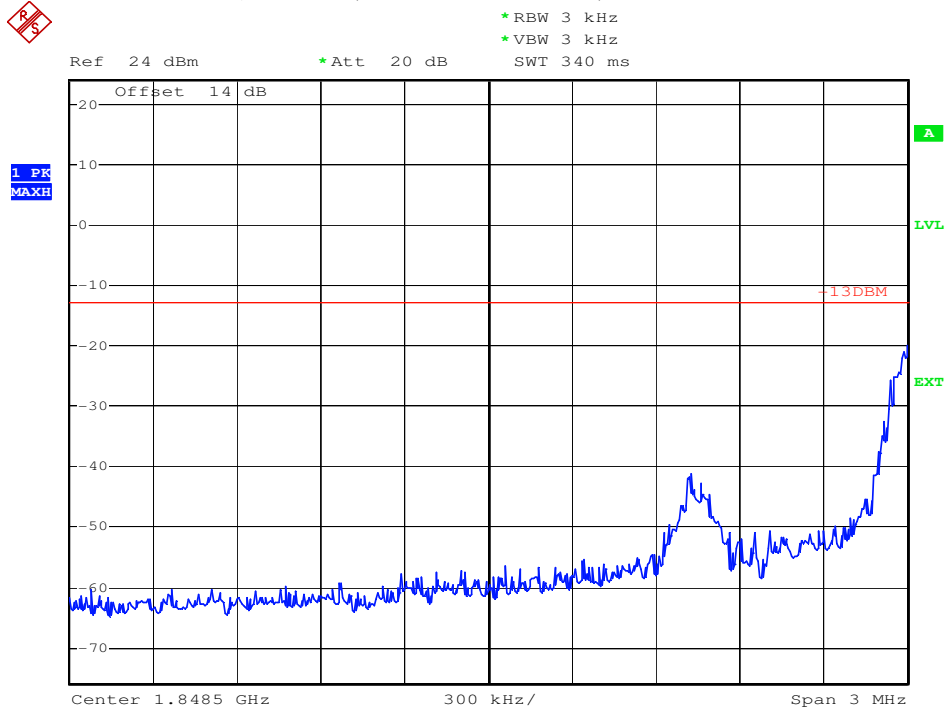

Plot 7.4.6) GMSK; PCS high channel, above 1910 MHz

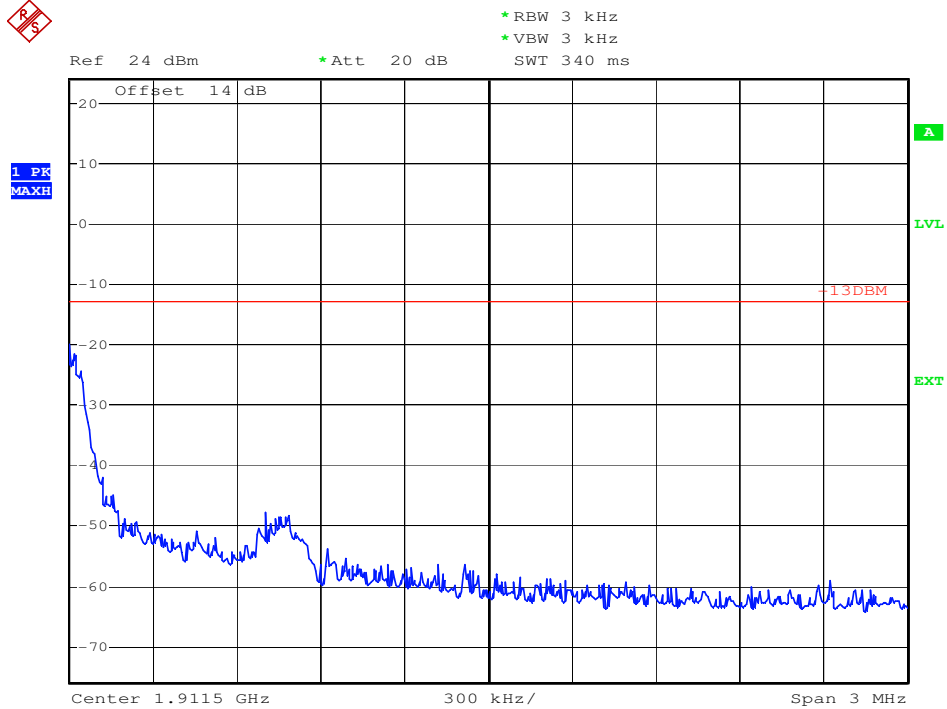

© 2009 Sierra Wireless, Inc.

The contents of this page are subject to the confidentiality information on page one.

SIERRA WIRELESS, INC.

Plot 7.4.7) 8-PSK; PCS low channel, below 1850 MHz

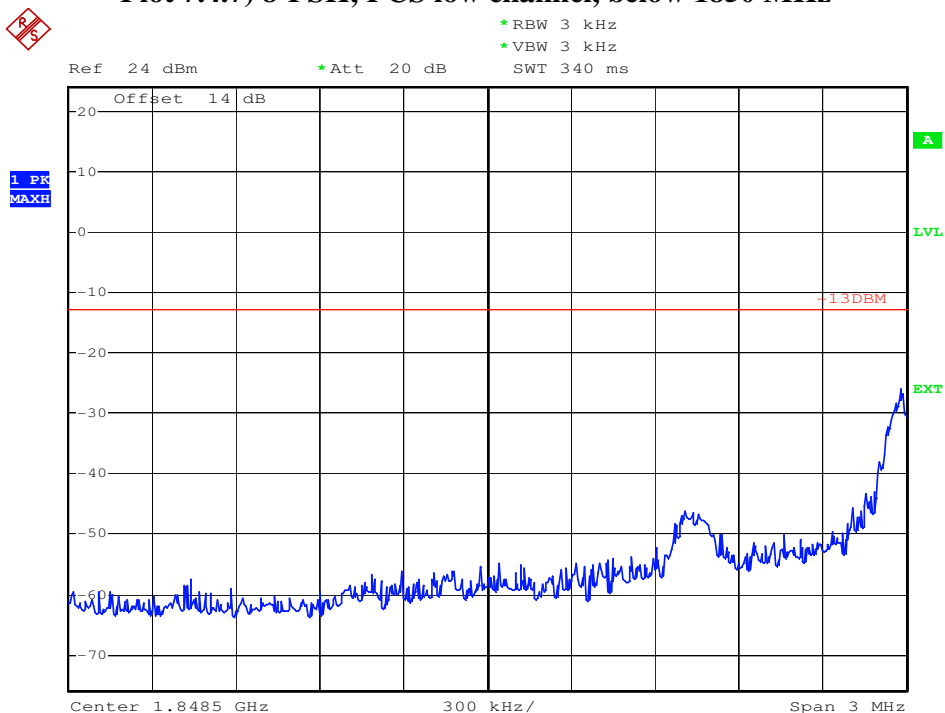

Plot 7.4.8) 8-PSK; PCS high channel, above 1910 MHz

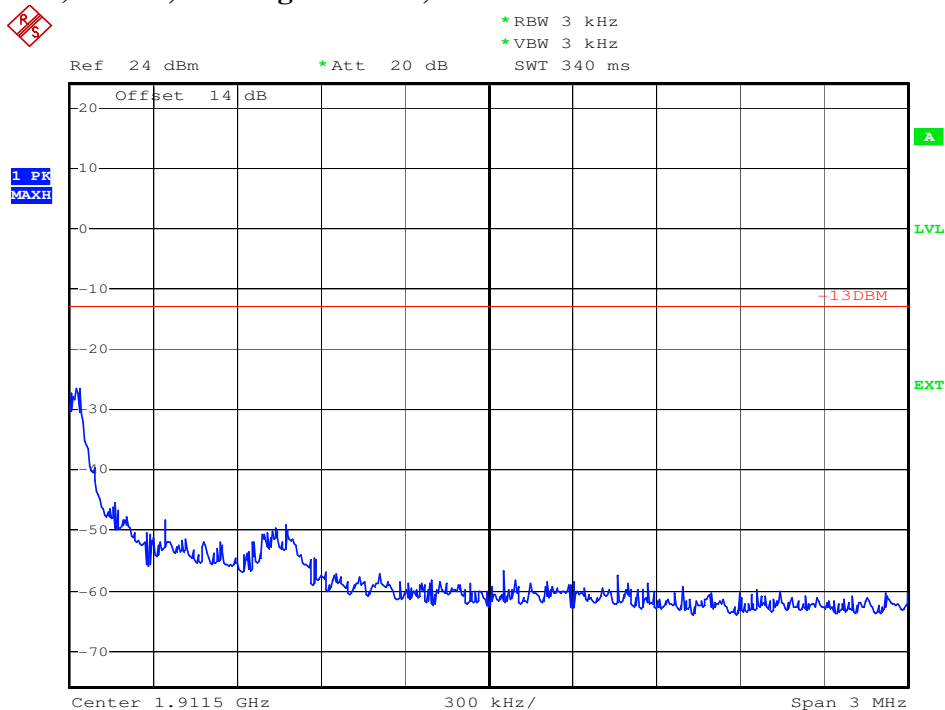

© 2009 Sierra Wireless, Inc.

The contents of this page are subject to the confidentiality information on page one.

SIERRA WIRELESS, INC.

Plot 7.4.9) WCDMA; Cellular low channel, below 824 MHz

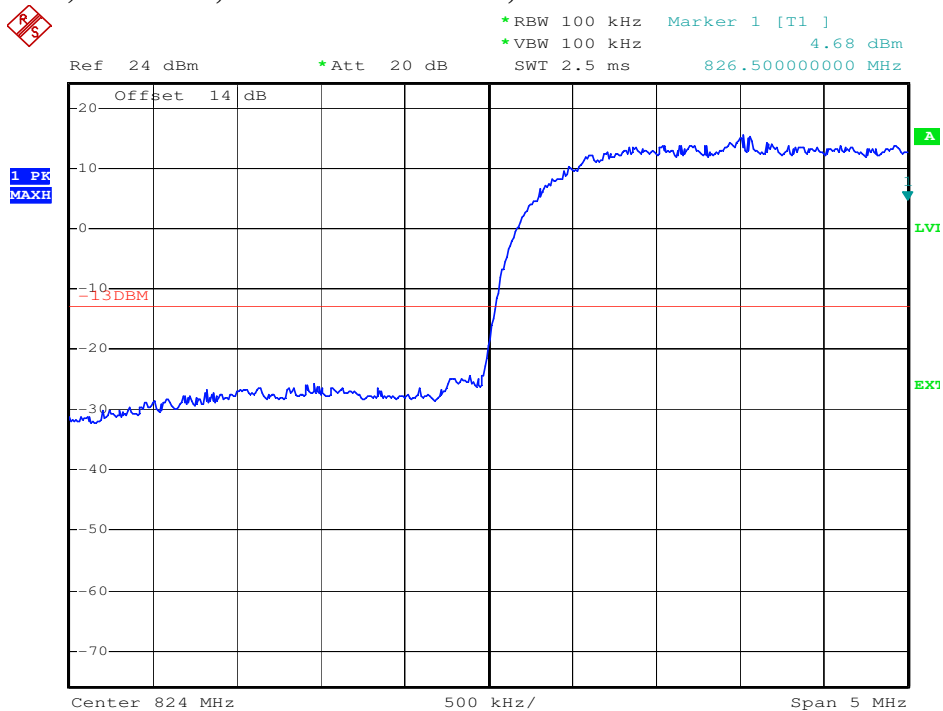

Plot 7.4.10) WCDMA; Cellular high channel, above 849 MHz

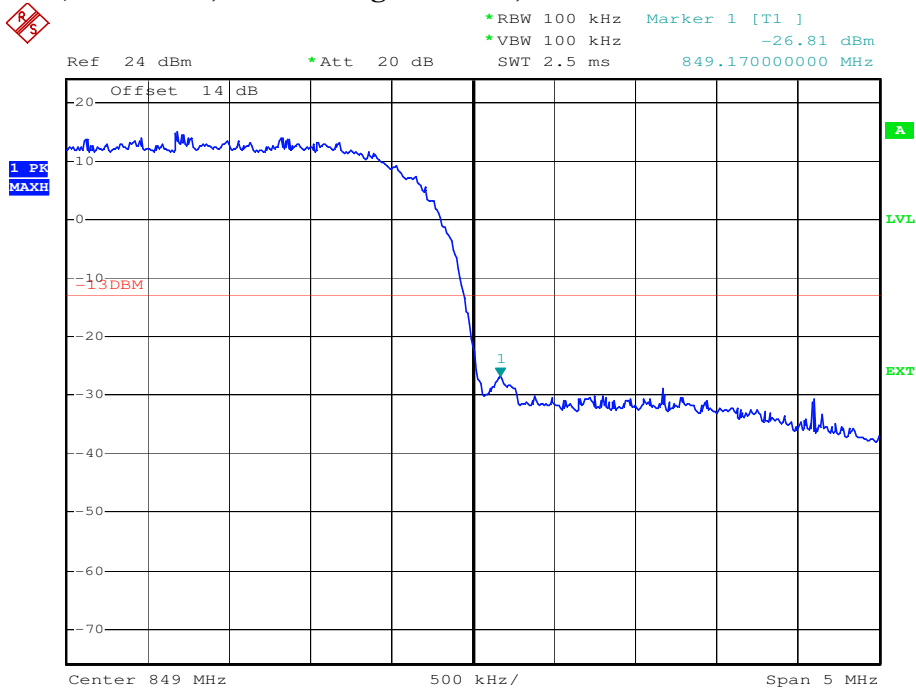

© 2009 Sierra Wireless, Inc.

The contents of this page are subject to the confidentiality information on page one.

SIERRA WIRELESS, INC.

Plot 7.4.11) WCDMA; PCS low channel, below 1850 MHz

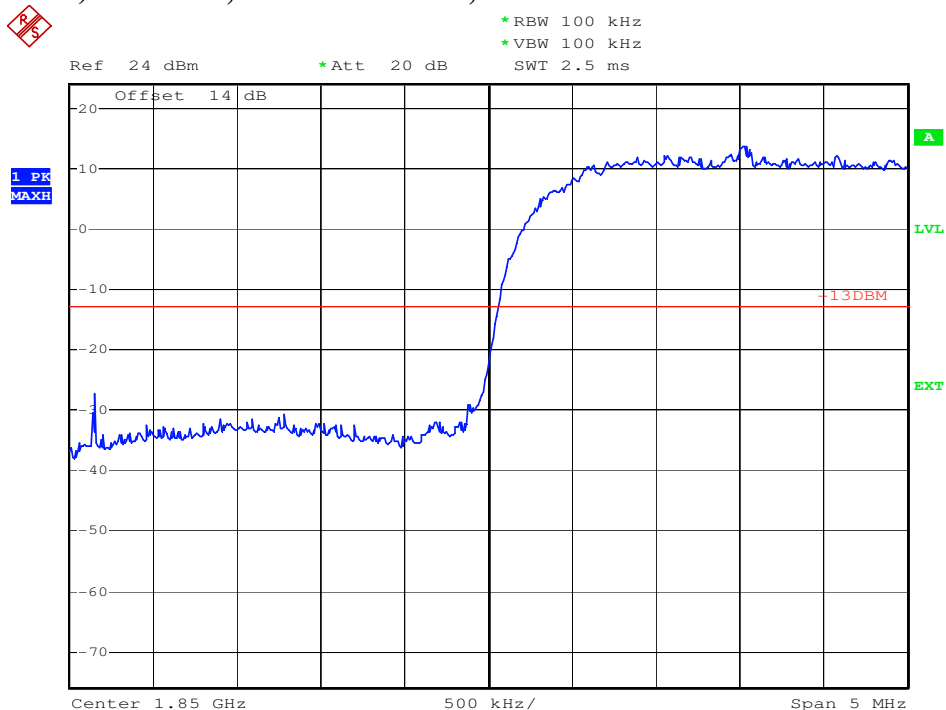

Plot 7.4.12) WCDMA; PCS high channel, above 1910 MHz

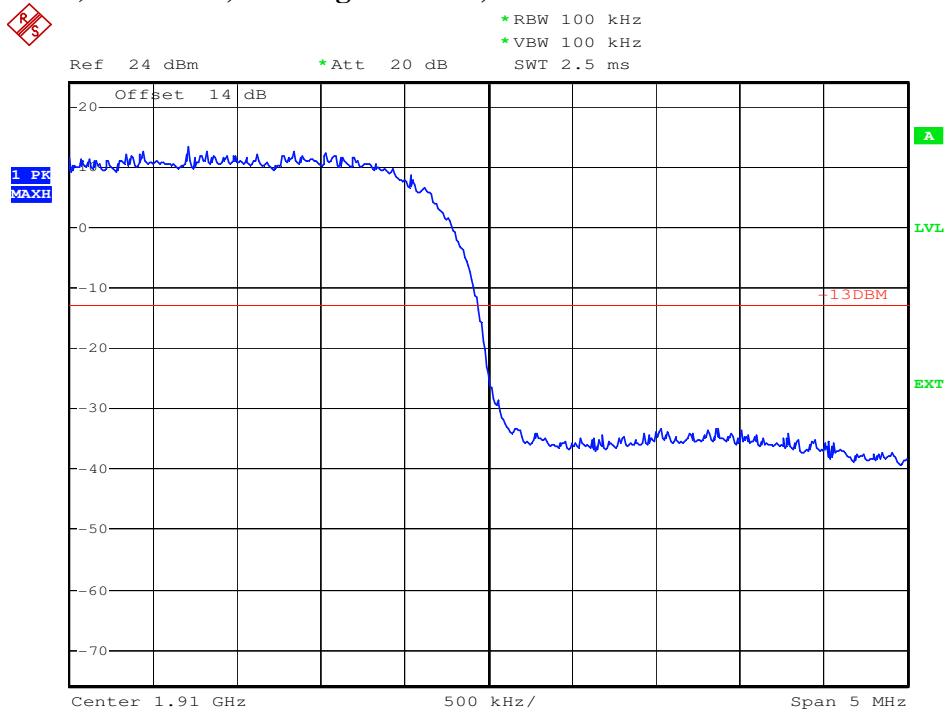

© 2009 Sierra Wireless, Inc.

The contents of this page are subject to the confidentiality information on page one.

SIERRA WIRELESS, INC.

8 Frequency Stability Versus Temperature

FCC 2.1055, FCC 22.355, FCC 24.235

8.1 Summary of Results

The EUT Frequency Stability versus temperature meets the requirements of less than 2.5ppm when temperature varies from -30°C to +50°C.

8.2 Test Procedure

The EUT was placed inside a temperature chamber. The temperature is set to -30°C and allowed to stabilize. After sufficient soak time, the transmitting frequency error is measured. The temperature is then increased by 10 degrees, allowed to stabilize and soak, and the measurement is repeated. This procedure is repeated until +50°C is reached. Frequency metering included internal averaging of the CMU200 to stabilize the reading. Reference power supply voltage for these tests is 5.0 volts.

Test Setup

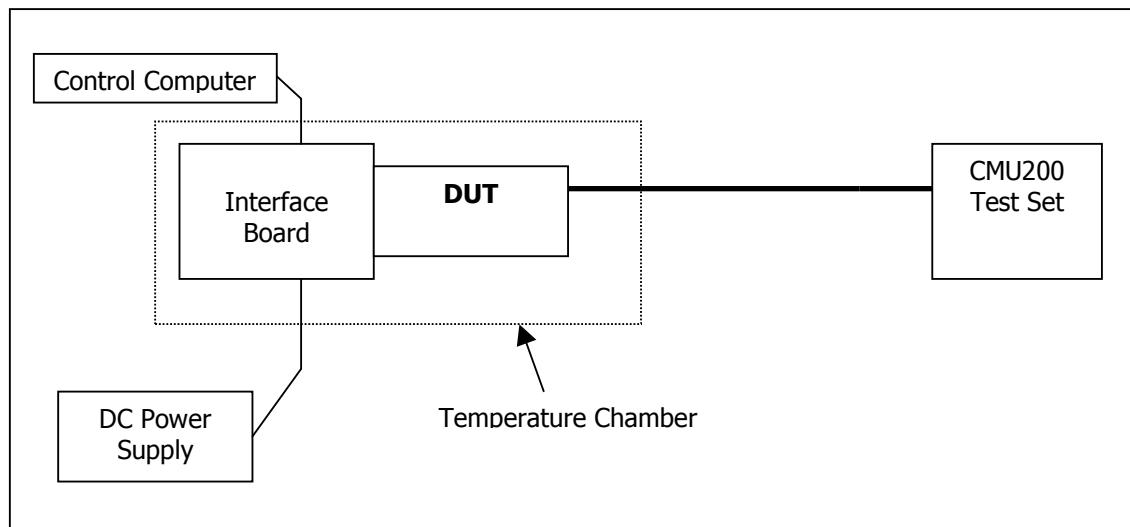

8.3 Test Equipment

| EQUIPMENT | MANUFACTURER | MODEL NO. | SERIAL NO. | CAL. DATE |
|---------------------|-----------------|------------|------------|-------------------|
| Control Computer | TC | Generic PC | 100488 | N/A |
| Wireless Test Set | Rohde & Schwarz | CMU200 | 110520 | November 17, 2009 |
| Spectrum Analyzer | Rohde & Schwarz | FSP | 100060 | November 15, 2009 |
| DC Power Supply | HP | 6632A | 3530A | N/A |
| Interface Board | Shop built | ATEMux | N/A | N/A |
| Directional Coupler | Pasternack | PE2209-10 | N/A | N/A |

© 2009 Sierra Wireless, Inc.

The contents of this page are subject to the confidentiality information on page one.

SIERRA WIRELESS, INC.

| | | | |
|--------------------------------|--------|---------------|---------------|
| FCC Part 22, 24 / RSS 132, 133 | USB306 | June 18, 2009 | Page 72 of 74 |
|--------------------------------|--------|---------------|---------------|

8.4 Test Results

8.4.1 GSM Frequency Error over Temperature

| Temp (°C) | Cellular Band: 824MHz to 848MHz | | | | PCS Band: 1850MHz to 1910MHz | | | |
|--------------|---------------------------------|-----------------|----------------|-----------------|------------------------------|-----------------|----------------|-----------------|
| | GMSK Mode | | 8PSK Mode | | GMSK Mode | | 8PSK Mode | |
| | Offset (Hz) | Offset (ppm) | Offset (Hz) | Offset (ppm) | Offset (Hz) | Offset (ppm) | Offset (Hz) | Offset (ppm) |
| -20 | -18 | -0.0215 | -29 | -0.0346 | -42 | -0.0223 | -73 | -0.0388 |
| -10 | -21 | -0.0251 | -32 | -0.0382 | -20 | -0.0106 | -12 | -0.0064 |
| 0 | -14 | -0.0167 | -50 | -0.0597 | -41 | -0.0218 | -61 | -0.0324 |
| 10 | -12 | -0.0143 | -8 | -0.0096 | -68 | -0.0362 | -68 | -0.0362 |
| 20 | -30 | -0.0358 | -44 | -0.0526 | -63 | -0.0335 | -66 | -0.0351 |
| 30 | -11 | -0.0131 | -10 | -0.0119 | -46 | -0.0245 | -69 | -0.0367 |
| 40 | -48 | -0.0573 | -42 | -0.0501 | -21 | -0.0112 | -26 | -0.0138 |
| 50 | -20 | -0.0239 | -7 | -0.0083 | -41 | -0.0218 | -48 | -0.0255 |

Note: EUT stops transmission at -30°C for both GMSK and 8PSK mode on GSM850 and PCS1900 bands.

8.4.2 UMTS Frequency Error over Temperature

| Temp (°C) | UMTS Mode | | | |
|-----------|--------------|--------------|---------------|--------------|
| | 850 MHz Band | | 1900 MHz Band | |
| | Offset (Hz) | Offset (ppm) | Offset (Hz) | Offset (ppm) |
| -30 | -1 | -0.0012 | -2 | -0.0011 |
| -20 | 0.49 | 0.0006 | 2.53 | 0.0013 |
| -10 | -0.56 | -0.0007 | -3.17 | -0.0017 |
| 0 | -1.34 | -0.0016 | -0.24 | -0.0001 |
| 10 | -1.31 | -0.0016 | 1.24 | 0.0007 |
| 20 | -2.01 | -0.0024 | 0.18 | 0.0001 |
| 30 | -0.64 | -0.0008 | -1.07 | -0.0006 |
| 40 | 0.93 | 0.0011 | -2.01 | -0.0011 |
| 50 | 0.11 | 0.0001 | 1.97 | 0.0010 |

SIERRA WIRELESS, INC.

9 Frequency Stability Versus Voltage

FCC 2.1055, FCC 22.355, FCC 24.235

9.1 Summary of Results

The EUT is specified to operate with a supply voltage varying between 4.2VDC and 5.8VDC having a nominal voltage of 5.0 VDC. It meets the frequency stability limit of less than 2.5ppm when supply voltage varies within the specified limits. Operation above or below these voltage limits is prohibited by firmware in order to prevent improper operation.

9.2 Test Procedure

The EUT was connected to a DC Power Supply and a UMTS test set (CMU 200) with frequency error measurement capability. The power supply output is adjusted to the test voltage as measured at the input terminals to the module while transmitting. A voltmeter was used to confirm the terminal voltage. The peak frequency error is recorded (worst case). The test voltages are 4.2 volts to 5.8 volts.

Test Setup

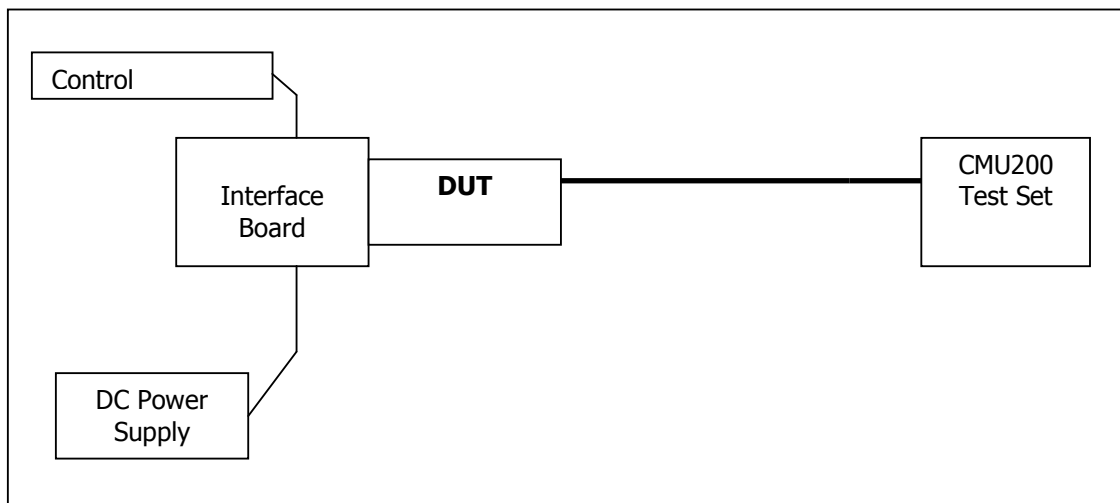

9.3 Test Equipment

| EQUIPMENT | MANUFACTURER | MODEL NO. | SERIAL NO. | CAL. DATE |
|---------------------|-----------------|------------|------------|-------------------|
| Control Computer | TC | Generic PC | 100488 | N/A |
| Wireless Test Set | Rohde & Schwarz | CMU200 | 110520 | November 17, 2009 |
| Spectrum Analyzer | Rohde & Schwarz | FSP | 100060 | November 15, 2009 |
| DC Power Supply | HP | 6632A | 3530A | N/A |
| Interface Board | Shop built | ATEMux | N/A | N/A |
| Directional Coupler | Pasternack | PE2209-10 | N/A | N/A |

SIERRA WIRELESS, INC.

9.4 Test Results

9.4.1 GSM Frequency Error over Voltage

| Voltage (V) | Cellular Band: 824MHz to 848MHz | | | | PCS Band: 1850MHz to 1910MHz | | | |
|-------------|---------------------------------|--------------|-------------|--------------|------------------------------|--------------|-------------|--------------|
| | GMSK Mode | | 8PSK Mode | | GMSK Mode | | 8PSK Mode | |
| | Offset (Hz) | Offset (ppm) | Offset (Hz) | Offset (ppm) | Offset (Hz) | Offset (ppm) | Offset (Hz) | Offset (ppm) |
| 4.2 | -15 | -0.0179 | -32 | -0.0382 | -50 | -0.0266 | -50 | -0.0266 |
| 5.0 | -15 | -0.0179 | 11 | 0.0131 | -31 | -0.0165 | -19 | -0.0102 |
| 5.8 | -40 | -0.0478 | -40 | -0.0478 | -27 | -0.0144 | -37 | -0.0197 |

9.4.2 UMTS Frequency Error over Voltage

| Voltage (V) | UMTS Mode | | | |
|-------------|--------------|--------------|---------------|--------------|
| | 850 MHz Band | | 1900 MHz Band | |
| | Offset (Hz) | Offset (ppm) | Offset (Hz) | Offset (ppm) |
| 4.2 | -1.71 | -0.0020 | 0.28 | 0.0001 |
| 5.0 | -0.88 | -0.0010 | -0.11 | -0.0001 |
| 5.8 | 1.69 | 0.0020 | -0.81 | -0.0004 |