



SL8080 Modem

Test Report

FOR

FCC and IC Certifications

IC: 2417C-SL8080
FCC ID: N7NSL8080

© 2010 Sierra Wireless, Inc.

This document contains information which is proprietary and confidential to Sierra Wireless, Inc. Disclosure to persons other than the officers, employees, agents, or subcontractors of the Company or licensee of this document without the prior written permission of Sierra Wireless, Inc. is strictly prohibited.

Table of Contents

1	Introduction and Purpose	4
2	Test Summary	4
3	Description of Equipment under Test	4
4	RF Power Output	5
4.1	Test Procedure	5
4.2	Test Equipment	5
4.3	Test Results GSM/EDGE (GMSK: MCS4; 8-PSK: MCS9)	6
4.4	Test Results UMTS	6
4.4.1	Test 1: RF Output Power Results for WCDMA R99	6
4.4.2	Test 2: RF Output Power Results for HSDPA Rel6	7
4.5	Test Settings for UMTS Mode on CMU200	9
5	Occupied Bandwidth	13
5.1	Test Procedure	13
5.2	Test Equipment	13
5.3	Test Results	13
5.3.1	GSM Results	14
5.3.2	WCDMA Results	14
5.4	Test Plots	15
6	Out of Band Emissions at Antenna Terminals	24
6.1	Test Procedure	24
6.2	Test Equipment	24
6.3	Test Results	25
6.4	Test Plots	26
7	Block Edge Compliance	62
7.1	Test Procedure	62
7.2	Test Equipment	62
7.3	Test Results	62
7.4	Test Plots	63
8	Frequency Stability versus Temperature	69
8.1	Summary of Results	69
8.2	Test Procedure	69
8.3	Test Equipment	69
8.4	Test Results	70
8.4.1	GSM Frequency Error over Temperature	70
8.4.2	UMTS Frequency Error over Temperature	70
9	Frequency Stability versus Voltage	71
9.1	Summary of Results	71
9.2	Test Procedure	71
9.3	Test Equipment	71
9.4	Test Results	72
9.4.1	GSM Frequency Error over Voltage	72

SIERRA WIRELESS, INC.

FCC Part 22, 24 / RSS 132, 133	SL8080	July 21, 2010	Page 3 of 72
--------------------------------	--------	---------------	--------------

9.4.2 *UMTS Frequency Error over Voltage* 72

SIERRA WIRELESS, INC.

FCC Part 22, 24 / RSS 132, 133	SL8080	July 21, 2010	Page 4 of 72
--------------------------------	--------	---------------	--------------

1 Introduction and Purpose

This document provides test data for the SL8080 modem intended for FCC and Industry Canada certifications. The tests included in this report are limited to all conducted tests required. The radiated tests were performed at an external test facility.

2 Test Summary

FCC Rule	IC Standards	DESCRIPTION OF TEST	RESULT	PAGE
2.1046	RSS-132, 4.4 RSS-133, 6.4	RF Power Output	Complies	6
2.1049	RSS-Gen, 4.6	Occupied Bandwidth	Complies	13
2.1051, 22.901(d) 22.917, 24.238(a)	RSS-132, 4.5 RSS-133, 6.5	Out of Band Emissions at Antenna Terminals	Complies	26
2.1053	RSS-132, 4.5 RSS-133, 6.5	Field Strength of Spurious Radiation	Complies	See CCS Report
2.1055	RSS-132, 4.3 RSS-133, 6.3	Frequency Stability versus Temperature	Complies	71
2.1055	RSS-132, 4.3 RSS-133, 6.3	Frequency Stability versus Voltage	Complies	73

3 Description of Equipment under Test

The SL8080 modem, referred to as "EUT" hereafter, is a multi-band wireless modem operating on the GSM/GPRS/EDGE/UMTS networks. In the US and Canada, only cellular and PCS bands are used for GSM/GPRS/UMTS operation, so this test report only contains data for these two bands (850MHz and 1900MHz).

4 RF Power Output

FCC 2.1046

4.1 Test Procedure

The transmitter output was connected to a Rohde & Schwarz CMU200 Test Set and configured to operate at maximum power in a call. The power was measured using the spectrum analyzer at three equally spaced operating frequencies for each band. The RBW was set to 300 KHz for the GSM and EDGE measurements and 5MHz for the WCDMA measurements. The spectrum analyzer was set to measure the RF output power with the cable and coupler losses accounted for.

Test Setup

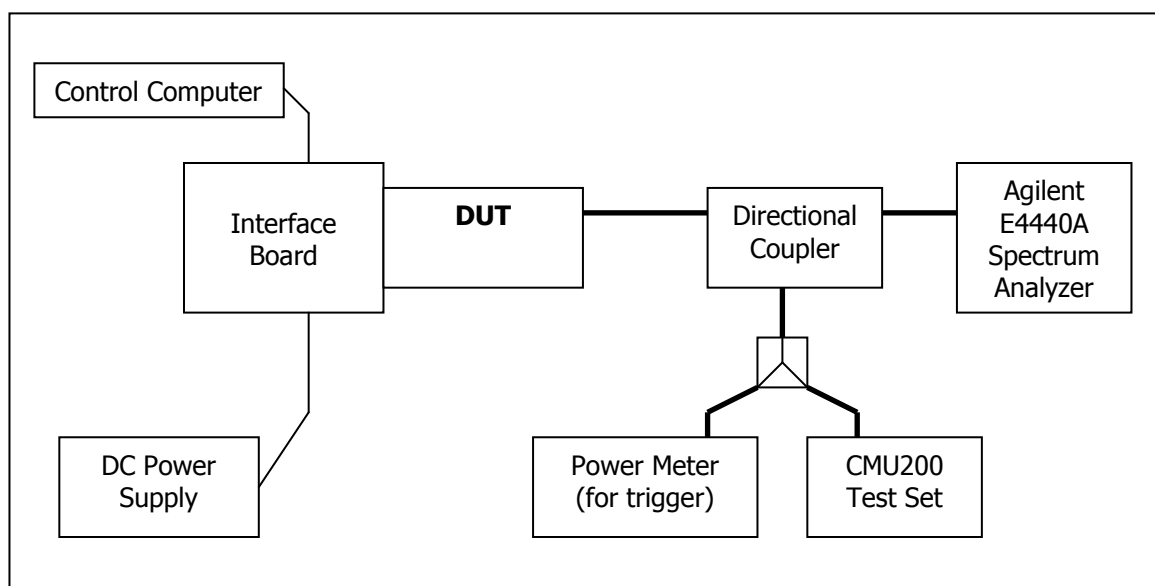

4.2 Test Equipment

EQUIPMENT	MANUFACTURER	MODEL NO.	SERIAL NO.	CAL. DATE
Control Computer	TC	Generic PC	100974	N/A
Wireless Test Set	Rohde & Schwarz	CMU200	107902	November 13, 2009
Spectrum Analyzer	Rohde & Schwarz	FSP	100060	November 24, 2009
DC Power Supply	HP	6632A	3145A	N/A
Interface Board	Shop built	ATEMux	N/A	N/A
Directional Coupler	Pasternack	PE2209-10	N/A	N/A

SIERRA WIRELESS, INC.

4.3 Test Results GSM/EDGE (GMSK: MCS4; 8-PSK: MCS9)

Frequency (MHz)	Channel	GMSK Mode							
		1 Time Slot		2Time Slots		3Time Slots		4Time Slots	
		RMS Power (dBm)	Peak Power (dBm)	RMS Power (dBm)	Peak Power (dBm)	RMS Power (dBm)	Peak Power (dBm)	RMS Power (dBm)	Peak Power (dBm)
824.2	128	30.92	31.06	31.96	31.95	GPRS Class 10 Only two TX slots	GPRS Class 10 Only two TX slots		
836.6	190	32.07	32.20	32.05	32.05				
848.8	251	32.29	32.41	32.27	32.26				
1850.2	512	29.06	29.20	29.07	29.21				
1880.0	661	28.96	29.09	28.96	29.09				
1909.8	810	29.05	29.19	29.04	28.66				

Frequency (MHz)	Channel	8-PSK Mode							
		1 Time Slot		2Time Slots		3Time Slots		4Time Slots	
		RMS Power (dBm)	Peak Power (dBm)	RMS Power (dBm)	Peak Power (dBm)	RMS Power (dBm)	Peak Power (dBm)	RMS Power (dBm)	Peak Power (dBm)
824.2	128	26.07	29.27	26.09	29.25	26.09	29.18	25.59	28.70
836.6	190	26.21	29.38	26.23	29.34	26.22	29.41	25.73	28.92
848.8	251	26.42	29.60	26.43	29.65	26.42	29.60	25.93	29.13
1850.2	512	25.26	28.41	25.27	28.49	25.31	28.45	24.81	28.01
1880.0	661	25.15	28.28	25.19	28.30	25.18	28.31	24.68	28.08
1909.8	810	25.15	28.32	25.19	28.39	25.18	28.43	24.67	28.03

4.4 Test Results UMTS

4.4.1 Test 1: RF Output Power Results for WCDMA R99

The following tests were completed according to the test requirements outlined in section 5.2 of the 3GPP TS34.121-1 V7.5.0 specification. The EUT supports power Class 3, which has a nominal maximum output power of 24 dBm (+1.7/-3.7). RMC 12.2kps is used for this testing.

The test was performed according to section 5.2 of the 3GPP TS34.121-1 V7.5.

Frequency (MHz)	Channel	WCDMA R99	
		RMS Power (dBm)	Peak Power (dBm)
826.4	4132	22.5	25.64
836.4	4182	22.5	25.7
846.6	4233	22.51	25.64
1852.4	9262	23.15	26.4
1880.0	9400	22.7	26.2
1907.6	9538	22.74	26.03

Note: The results above reflect max power with all up bits.

SIERRA WIRELESS, INC.

FCC Part 22, 24 / RSS 132, 133	SL8080	July 21, 2010	Page 7 of 72
--------------------------------	--------	---------------	--------------

4.4.2 Test 2: RF Output Power Results for HSDPA Rel6

The EUT supports Category 8 FDD HS-DSCH physical layer. As stated in the 3GPP TS25.306 V7.3.0 Table 5.1a, the details of Category 8 are as follows:

- Maximum of 10 E-DSCH received codes
- Minimum 1 inter-TTI interval
- Maximum 14411bits in an E-DSCH transport block received within an E-DSCH TTI
- Total number of soft channel bits is 134400
- Support of QPSK and 16QAM

A detailed list of all settings used is included 4.5.

The following Sub-Tests were completed according to the test requirements outlined in section 5.2A of the 3GPP TS34.121-1 V7.5.0 specification. All TX RMS and Peak power requirements for Power Class 3 were met according to table 5.2AA.5 and achieved through the outlined test procedure in section 5.2AA.4.2. All UE channels and power ratio's are set according to table C10.1.4 in the 3GPP TS34.121-1 V7.5.0 specification. A summary of these settings is illustrated below:

Subtest	Mode	Call Type	RMC (kbps)	HSDPA FRC	Power Class 3 Max Limit dBm	β_c/β_d	β_{hs}	CM (db)	MPR (db)
1	HSDPA	PS	12.2	H-Set 1 QPSK	24 (+1.7/-3.7 db)	2 /15	4/15	0.0	0.0
2	HSDPA	PS	12.2	H-Set 1 QPSK	24 (+1.7/-3.7 db)	12 /15	24/15	1.0	0.0
3	HSDPA	PS	12.2	H-Set 1 QPSK	23.5 (+2.2/-3.7 db)	15 /8	30/15	1.5	0.5
4	HSDPA	PS	12.2	H-Set 1 QPSK	23.5 (+2.2/-3.7 db)	15 /4	30/15	1.5	0.5

Note: The recommended HSDPA MPRs are implemented as per following sub-tests.

4.4.2.1 Sub-Test 1

$\beta_c=2/15$, $\beta_d=15/15$, $\beta_{hs}=4/15$. MPR=0dB translates the min. and max. power limits to 20.3dBm and 25.7dBm respectively.

Frequency (MHz)	Channel	Power (dBm)	Comments
		20.3dBm<Measured RMS (dBm)<25.7dBm	
826.4	4132	22.34	Pass
836.4	4182	22.42	Pass
846.6	4233	22.5	Pass
1852.4	9262	23.13	Pass
1880.0	9400	22.7	Pass
1907.6	9538	22.77	Pass

SIERRA WIRELESS, INC.

FCC Part 22, 24 / RSS 132, 133	SL8080	July 21, 2010	Page 8 of 72
--------------------------------	--------	---------------	--------------

4.4.2.2 Sub-Test 2

$\beta_c=12/15$, $\beta_d=15/15$, $\beta_{hs}=24/15$. MPR=0dB translates the min. and max. power limits to 20.3dBm and 25.7dBm respectively.

Frequency (MHz)	Channel	Power (dBm)	Comments
		20.3dBm<Measured RMS (dBm)<25.7dBm	
826.4	4132	22.2	Pass
836.4	4182	22.23	Pass
846.6	4233	22.24	Pass
1852.4	9262	23.28	Pass
1880.0	9400	22.47	Pass
1907.6	9538	22.7	Pass

4.4.2.3 Sub-Test 3

$\beta_c=15/15$, $\beta_d=15/8$, $\beta_{hs}=30/15$. MPR=0.5dB translates the min. and max. power limits to 19.8dBm and 25.7dBm respectively.

Frequency (MHz)	Channel	Power (dBm)	Comments
		19.8dBm<Measured RMS (dBm)<25.7dBm	
826.4	4132	21.22	Pass
836.4	4182	21.02	Pass
846.6	4233	20.97	Pass
1852.4	9262	21.8	Pass
1880.0	9400	21.38	Pass
1907.6	9538	21.54	Pass

4.4.2.4 Sub-Test 4

$\beta_c=15/15$, $\beta_d=4/15$, $\beta_{hs}=30/15$. MPR=0.5dB translates the min. and max. power limits to 19.8dBm and 25.7dBm respectively.

Frequency (MHz)	Channel	Power (dBm)	Comments
		19.8dBm<Measured RMS (dBm)<25.7dBm	
826.4	4132	20.08	Pass
836.4	4182	20.06	Pass
846.6	4233	20.05	Pass
1852.4	9262	20.77	Pass
1880.0	9400	20.37	Pass
1907.6	9538	20.56	Pass

4.5 Test Settings for UMTS Mode on CMU200

WCDMA R99 Mode Settings:

UE Power Control Settings

Maximum allowable UE-Power = 24.0 dBm

UL Target Power = 24.0 dBm

Node B Settings

Primary Scrambling Code = 9

Output Channel Power = -51.7 dBm

OCNS = Off

Total Output Power (Ior+Ioc) = -51.7 dBm

RMC Settings

Reference Channel Type: 12.2 kbps Downlink/Uplink

DL DTCH Transport Format: 12.2 kbps

DL Resources in Use: 100 %

UL CRC (Sym. Loop Mode 2): Off

Test Mode: Loop Mode 1

Channel Data Source DTCH: PRBS9

Voice Settings

Voice Source: Echo

Loopback Type: Off

Adaptive Multirate Settings

Active Code Set: Selection A

Codec Mode: 12.2 kbps

Signaling RAB Settings

SRB Cell DCH: 3.4 kbps

BS Down Link Physical Channels Settings

Ior = -51.7 dBm

P-CPICH = -3.3 dB

P-SCH = -8.3 dB

S-SCH = -8.3 dB

P-CCPCH = -5.3 dB

S-CCPCH = -5.3 dB

S-CCPCH Channel Code = 2

PICH = -8.3 dB

PICH Channel Code = 3

AICH = -8.3 dB

AICH Channel Code = 6

DPDCH = -10.3 dB
DPDCH Channel Code = 96
Power Offset (DPCCH/DPDCH) = 0.0 dB
DL DPCH Timing Offset = 0
Secondary Scrambling Code = 0
Secondary Scrambling Code (HSDPA) = 0
HSDPA Channels = On

TPC Settings

Algorithm = 2
TPC Step Size = 1dB
TPC Pattern Setup = Set 1 (All 1, after linked to get maximum power)

HSDPA Mode Settings:

Node B Settings

Primary Scrambling Code = 9
Output Channel Power = -86 dBm
OCNS = Off
Total Output Power (I_{or}+I_{oc}) = -86 dBm

Network Settings

Packet Switched Domain = ON

HSDPA Test Mode Settings

Radiobearer Setup = RMC 12.2 kbps + HSPDA
RMC Test Loop = Loop Mode 1 RLC TM

HSDPA HS-DSCH

CQI Feedback Cycle = 4ms
CQI Repetition Factor = 2
ACK/NACK Repetition Factor = 3
UE Category = 5
Channel Configuration Type = FRC
H-Set Selection = H-Set 1 QPSK
RV Coding Sequence {0,2,5,6}

HSDPA Gain Factors are set according to each specific sub-test in table C.10.1.4 of 3GPP TS 34.121.

HSPA Mode Settings:

UE Power Control Settings

Maximum allowable UE-Power = 24.0 dBm
UL Target Power: Set according to each specific sub-test in table 5.2B.5 of 3GPP TS 34.121 less 5db for starting point.

UE Packet Data Gain Factors

Bc and Bd: *

Δ ACK, Δ NACK, Δ CQI=8

HSUPA

E-DCH Physical Layer Category = 5

E-TFCI Table Index = 1

Minimum Set E-TFCI = 1*

Maximum Channelisation Code: 1xSF4 or 2xSF4*

Initial Service Grant: *

UE Gain Factors

Δ E-DPCCH: *

Number of Reference E-TFCIs: **

Reference E-TFCI's: **

E-TFCI Power offsets: **

Node B Settings

Primary Scrambling Code = 9

Output Channel Power = -86 dBm

OCNS = Off

Total Output Power (Ior+Ioc) = -86 dBm

Paket Switched

DCH Type: HSUPA Test Mode

Data Rate: HSDPA/HSUPA

HSDPA Test Mode Settings

Radiobearer Setup = RMC 12.2kbps + HSDPA

RMC Test Loop = Loop Mode 1 RLC TM

HSDPA HS-DSCH

CQI Feedback Cycle = 4ms

CQI Repetition Factor = 2

ACK/NACK Repetition Factor = 3

UE Category = 8

Channel Configuration Type = FRC

H-Set Selection = H-Set 1 QPSK

RV Coding Sequence {0,2,5,6}

HSUPA Test Mode Settings

Radiobearer Setup = SRB 3.4 + HSPA

HSUPA Settings

TTI mode: 10ms

E-AGCH

Pattern Length: 1 AG Value: *

SIERRA WIRELESS, INC.

FCC Part 22, 24 / RSS 132, 133	SL8080	July 21, 2010	Page 12 of 72
--------------------------------	--------	---------------	---------------

Downlink Physical Channels

HSUPA Channels: On

E-AGCH: -6.0db

E-AGCH Chan. Code: 6

E-RGCH/E-HICH: -5.0db

E-RGCH Active: Off

E-RGCH/E-HICH Chan. Code: 6

*Set according to each specific sub-test in table C.11.1.3 of 3GPP TS 34.121.

** Set according to each specific sub-test in table 5.2B.2/3 of 3GPP TS 34.121.

5 Occupied Bandwidth

FCC 2.1049

5.1 Test Procedure

The transmitter output was connected to a spectrum analyzer through a calibrated coaxial cable and a coupler. The occupied bandwidth (defined as the 99% Power Bandwidth) was measured with the spectrum analyzer at low, middle, and high frequencies in each band. The -26dB bandwidth was also measured and recorded.

Test Setup

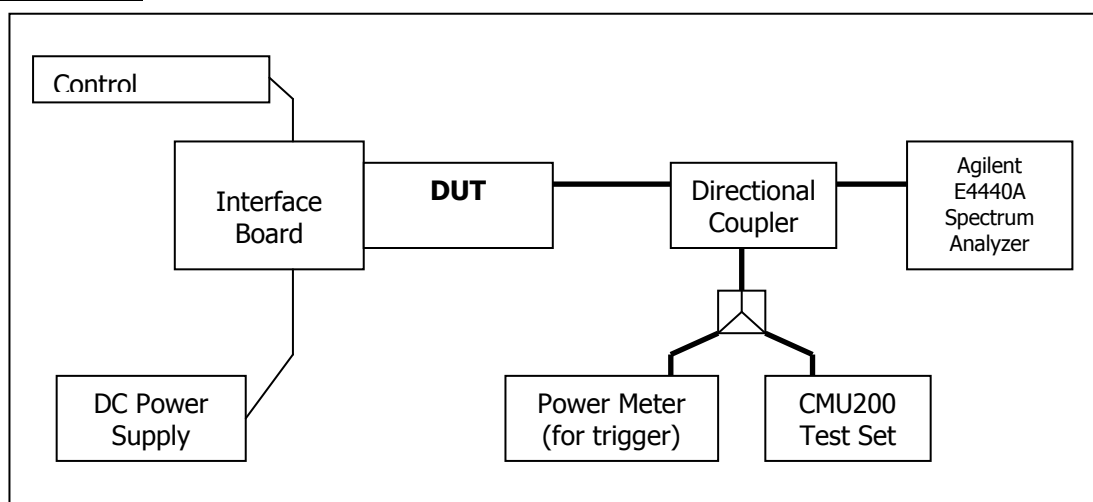

5.2 Test Equipment

EQUIPMENT	MANUFACTURER	MODEL NO.	SERIAL NO.	CAL. DATE
Control Computer	TC	Generic PC	100974	N/A
Wireless Test Set	Rohde & Schwarz	CMU200	107902	November 13, 2009
Spectrum Analyzer	Rohde & Schwarz	FSP	100060	November 24, 2009
DC Power Supply	HP	6632A	3145A	N/A
Interface Board	Shop built	ATEMux	N/A	N/A
Directional Coupler	Pasternack	PE2209-10	N/A	N/A

5.3 Test Results

The performance of the GSM 850 MHz Cellular band is shown in plots 5.3.1 to 5.3.6.
 Performance of the GSM 1900 MHz PCS band is shown in plots 5.3.7 to 5.3.12.
 Performance of the UMTS 850 Cellular band is shown in plots 5.3.13 to 5.3.15.
 Performance of the UMTS 1900 PCS band is shown in plots 5.3.16 to 5.3.18.

The following GSM test results are based on single slot, and use CS1 for GMSK and MCS9 for 8PSK mode. For WCDMA testing, RMC 12.2kps has been used.

SIERRA WIRELESS, INC.

5.3.1 GSM Results

Frequency (MHz)	Channel	99% Occupied Bandwidth (kHz)		-26dBc Occupied Bandwidth (kHz)	
		GMSK Mode	8-PSK Mode	GMSK Mode	8-PSK Mode
824.2	128	244	242	318	310
836.6	190	244	243	320	304
848.8	251	242	240	315	306
1850.2	512	243	243	316	313
1880.0	661	244	242	316	308
1909.8	810	242	242	315	302

5.3.2 WCDMA Results

Frequency (MHz)	Channel	99% Occupied Bandwidth (MHz)	-26dBc Occupied Bandwidth (MHz)
826.4	4132	4.17	4.65
836.4	4182	4.1175	4.62
846.6	4233	4.1325	4.6425
1852.4	9262	4.17	4.65
1880.0	9400	4.1625	4.65
1907.6	9538	4.155	4.65

5.4 Test Plots

5.3.1) GMSK Occupied Bandwidth, Cellular Low channel, 824.2 MHz, 99% BW

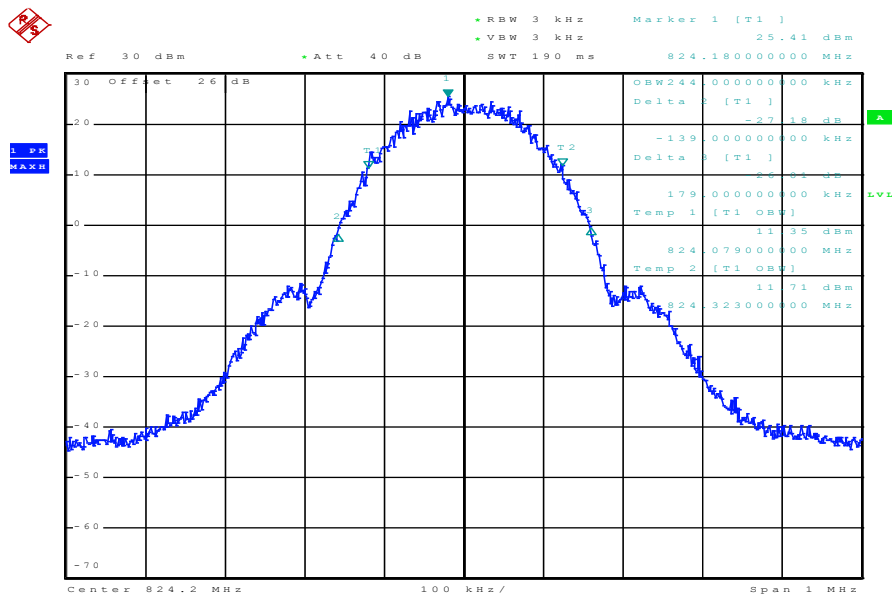

Date: 20.JUL.2010 11:24:10

5.3.2) GMSK Occupied Bandwidth, Middle channel, 836.6 MHz, 99% bandwidth

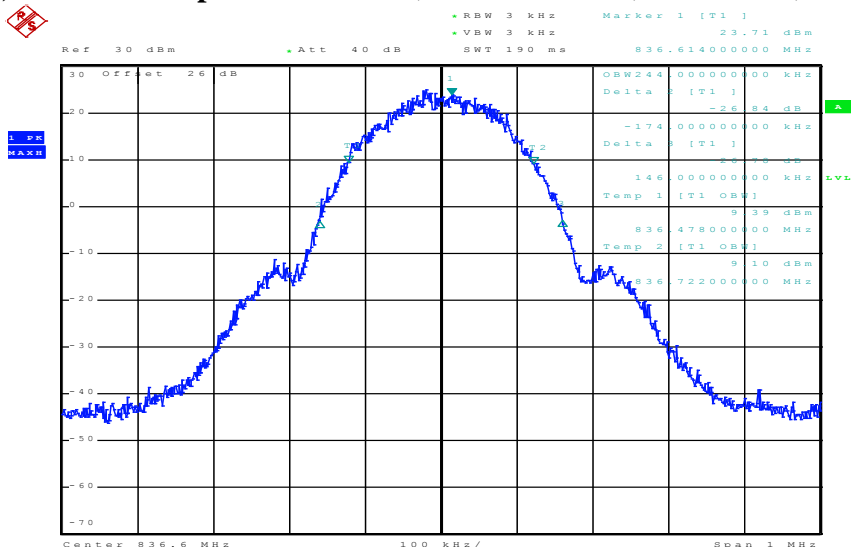

Date: 20.JUL.2010 11:43:56

5.3.3) GMSK Occupied Bandwidth, High channel, 848.8 MHz, 99% bandwidth

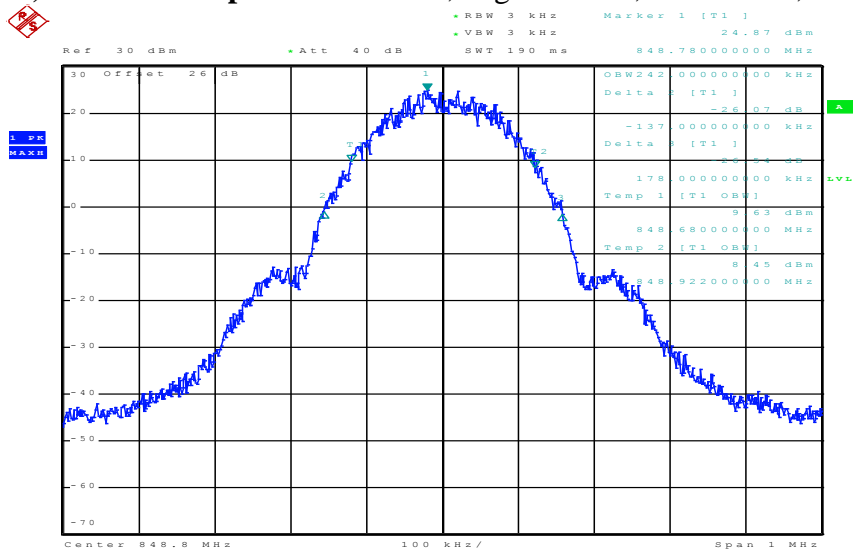

Date: 20.JUL.2010 11:49:18

5.3.4) 8-PSK Occupied Bandwidth, Cellular Low channel, 824.2 MHz, 99% BW

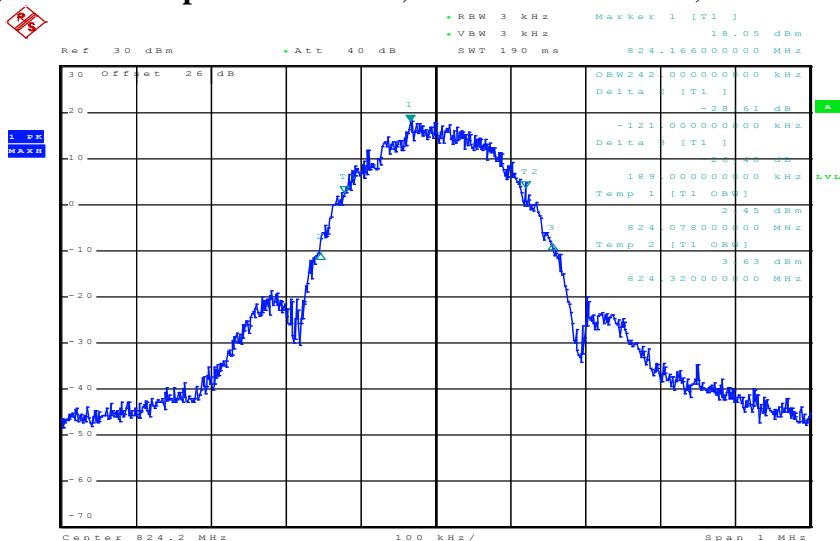

Date: 20.JUL.2010 13:46:11

5.3.5) 8-PSK Occupied Bandwidth, Middle channel, 836.6 MHz, 99% bandwidth

© 2009 Sierra Wireless, Inc.

The contents of this page are subject to the confidentiality information on page one.

SIERRA WIRELESS, INC.

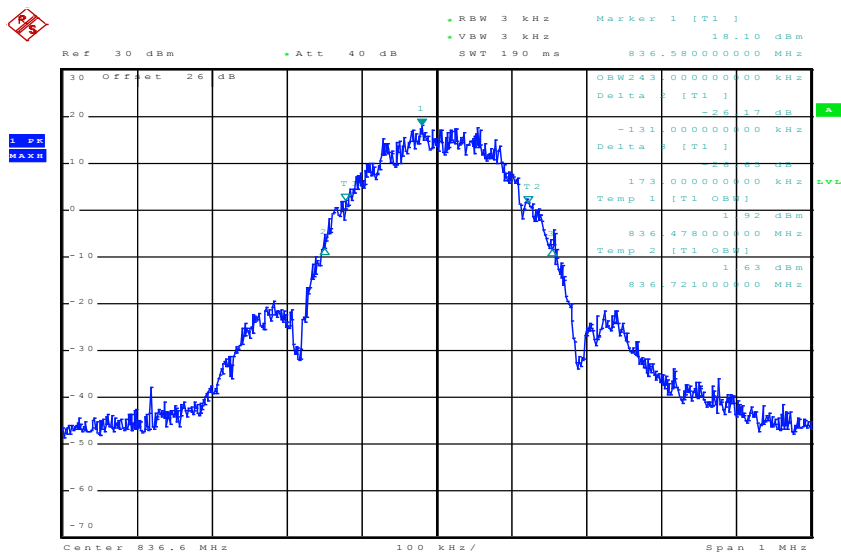

Date: 20.JUL.2010 13:48:07

5.3.6) 8-PSK Occupied Bandwidth, High channel, 848.8 MHz, 99% bandwidth

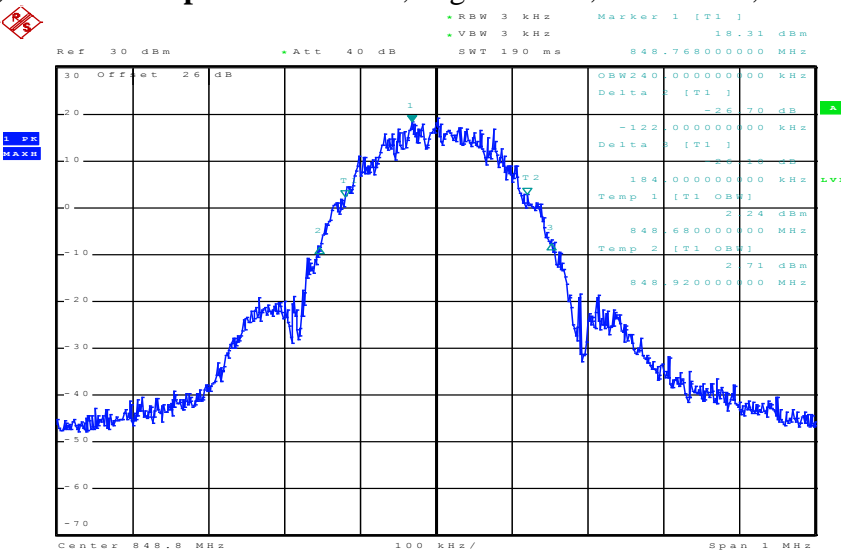

Date: 20.JUL.2010 13:51:25

SIERRA WIRELESS, INC.

5.3.7) GMSK Occupied Bandwidth, PCS Low channel, 1850.2 MHz, 99% BW

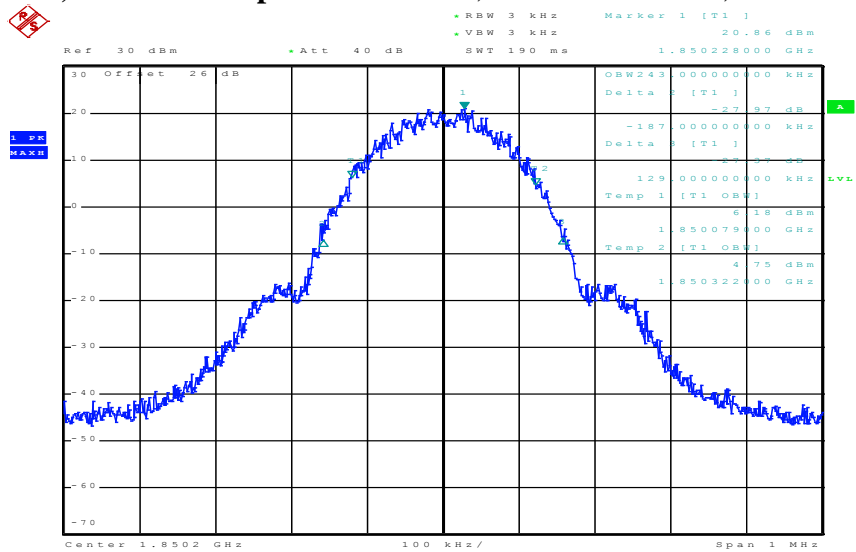

Date: 20.JUL.2010 13:26:05

5.3.8) GMSK Occupied Bandwidth, PCS Middle channel, 1880.0 MHz, 99% BW

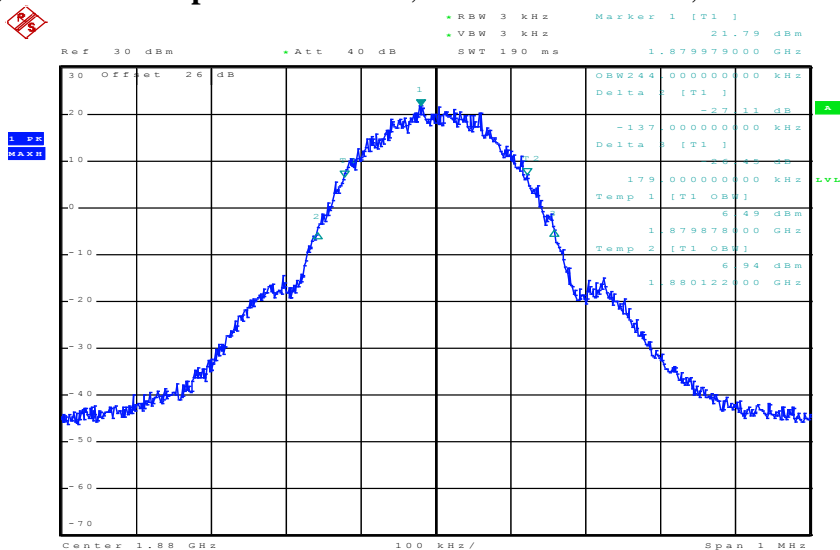

Date: 20.JUL.2010 13:29:57

5.3.9) GMSK Occupied Bandwidth, PCS High channel, 1909.8 MHz, 99% BW

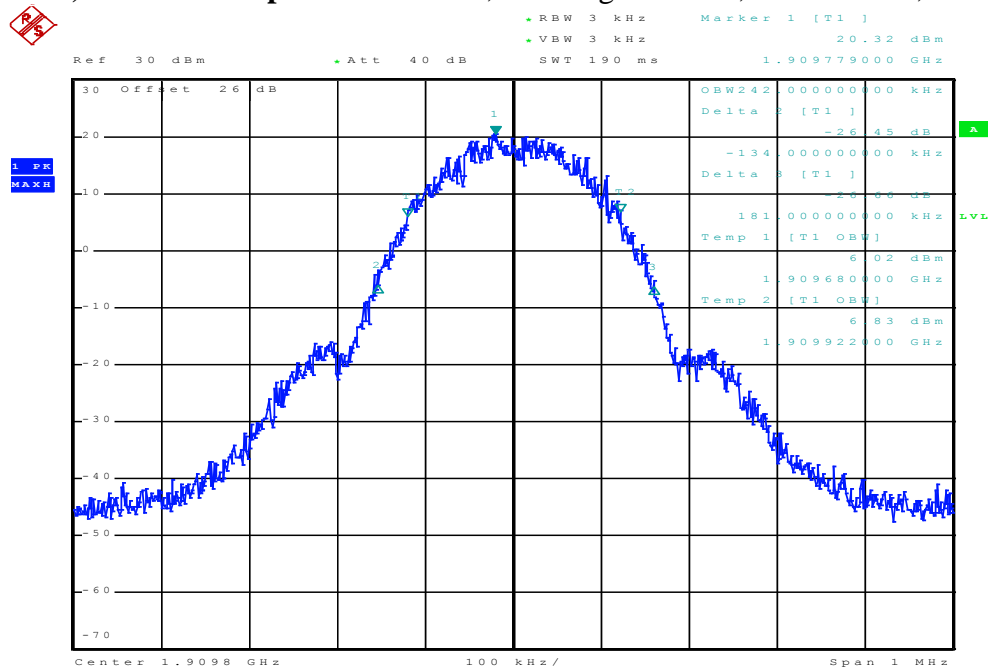

Date: 20.JUL.2010 13:33:32

5.3.10) 8-PSK Occupied Bandwidth, PCS Low channel, 1850.2 MHz, 99% BW

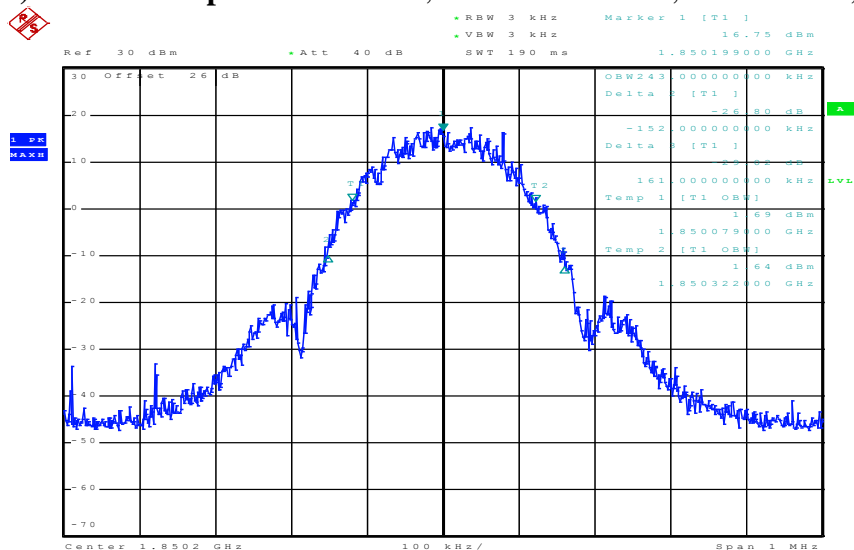

Date: 20.JUL.2010 13:36:52

5.3.11) 8-PSK Occupied Bandwidth, PCS Middle channel, 1880.0 MHz, 99% BW

© 2009 Sierra Wireless, Inc.

The contents of this page are subject to the confidentiality information on page one.

SIERRA WIRELESS, INC.

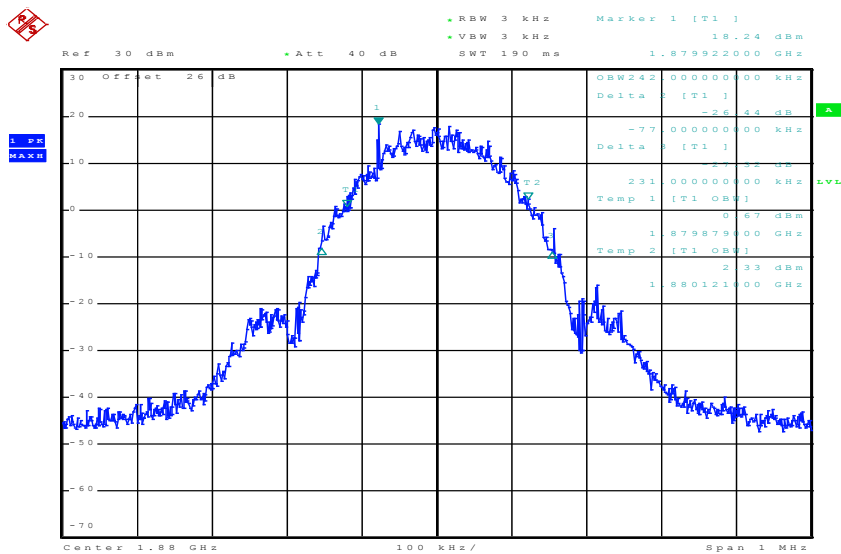

Date: 20.JUL.2010 13:39:12

5.3.12) 8-PSK Occupied Bandwidth, PCS High channel, 1909.8 MHz, 99% BW

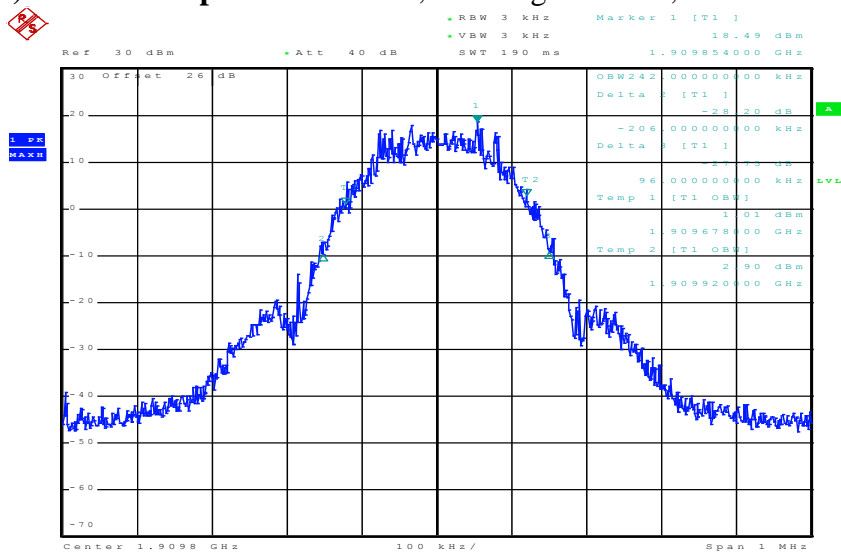

Date: 20.JUL.2010 13:41:13

5.3.13) WCDMA Occupied Bandwidth, Cellular Low channel, 826.4 MHz, 99% BW

SIERRA WIRELESS, INC.

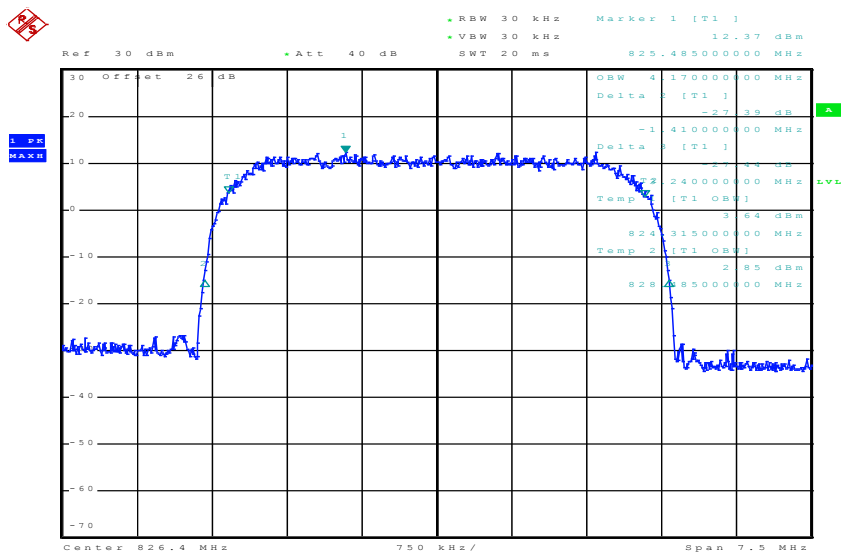

5.3.14) WCDMA Occupied Bandwidth, Cellular Middle channel, 836.4 MHz, 99% BW

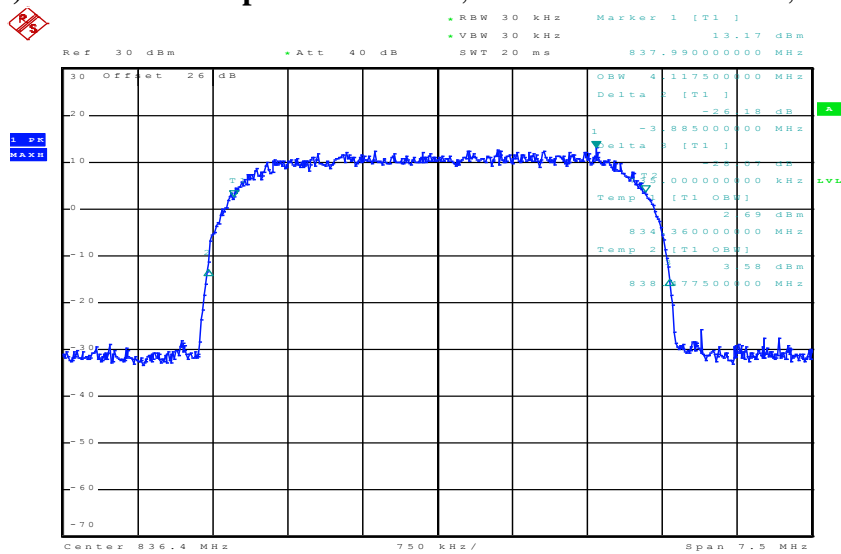

SIERRA WIRELESS, INC.

5.3.15) WCDMA Occupied Bandwidth, Cellular High channel, 846.6 MHz, 99% BW

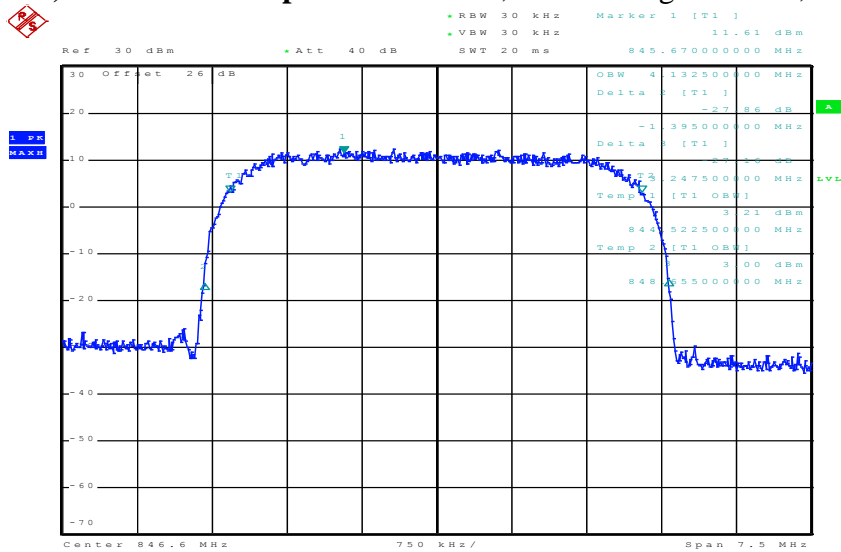

Date: 20.JUL.2010 14:15:12

5.3.16) WCDMA Occupied Bandwidth, PCS Low channel, 1852.4 MHz, 99% BW

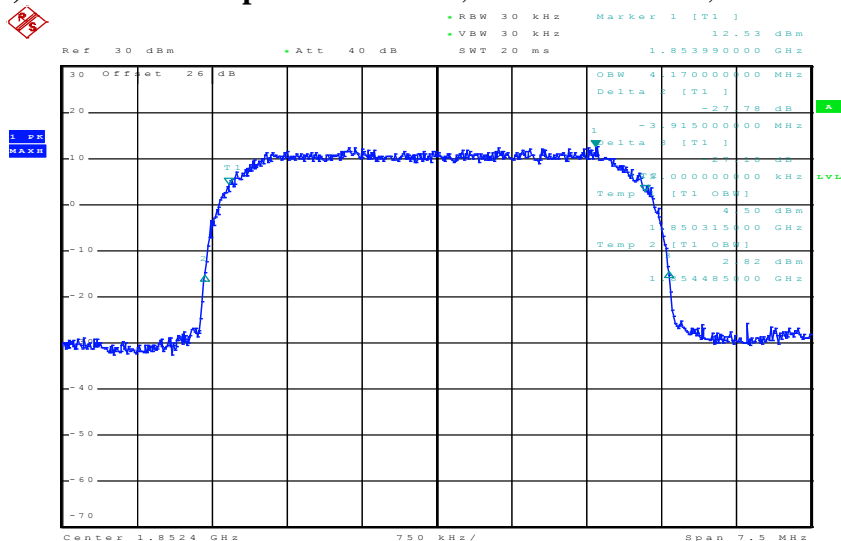

Date: 20.JUL.2010 14:17:05

5.3.17) WCDMA Occupied Bandwidth, PCS Middle channel, 1880 MHz, 99% BW

© 2009 Sierra Wireless, Inc.

The contents of this page are subject to the confidentiality information on page one.

SIERRA WIRELESS, INC.

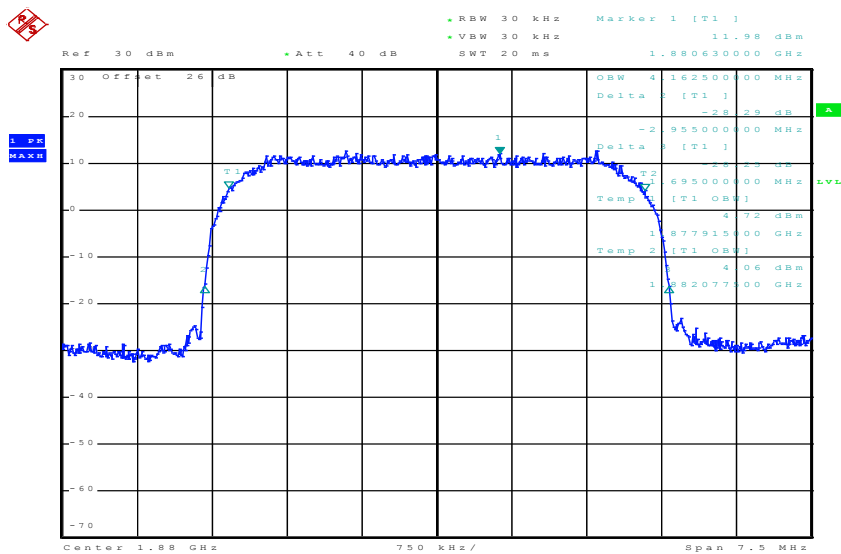

Date: 20.JUL.2010 14:19:20

5.3.18) WCDMA Occupied Bandwidth, PCS High channel, 1907.6 MHz, 99% BW

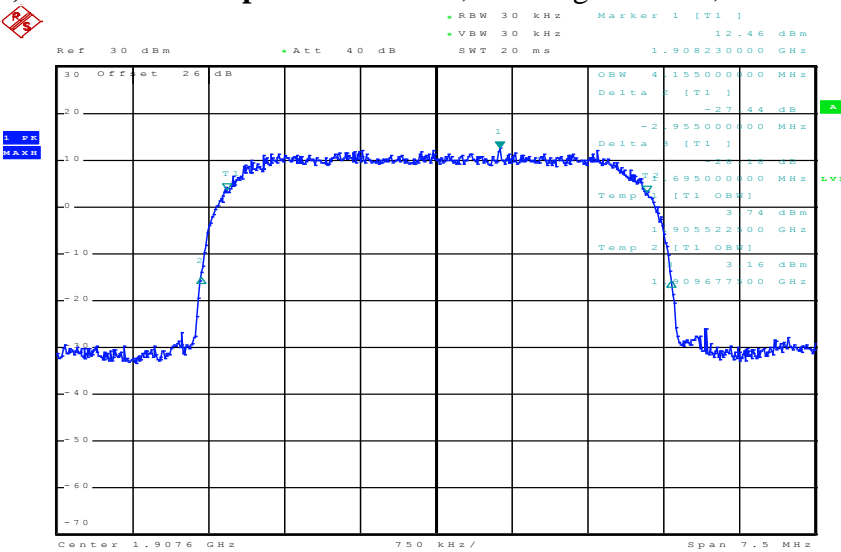

Date: 20.JUL.2010 14:20:54

6 Out of Band Emissions at Antenna Terminals

FCC 22.901(d), 22.917, 24.238(a)

Out of Band Emissions:

The mean power of emissions must be attenuated below the mean power of the unmodulated carrier (P) on any frequency outside the frequency band by at least $(43 + 10 \log P)$ dB. The out of band emission limit translates to a worst case absolute limit of -13dBm in this case.

6.1 Test Procedure

The RF output of the transmitter was connected to a spectrum analyzer through a calibrated coaxial cable. Sufficient scans were taken to show the out-of-band emissions, if any, up to 10th harmonic. The EUT was scanned for spurious emissions from 1MHz to 20GHz with sufficient bandwidth and video resolution. Data plots are included. Multiple sweeps were recorded in maximum hold mode using a peak detector to ensure that the worst-case emissions were captured.

Test Setup

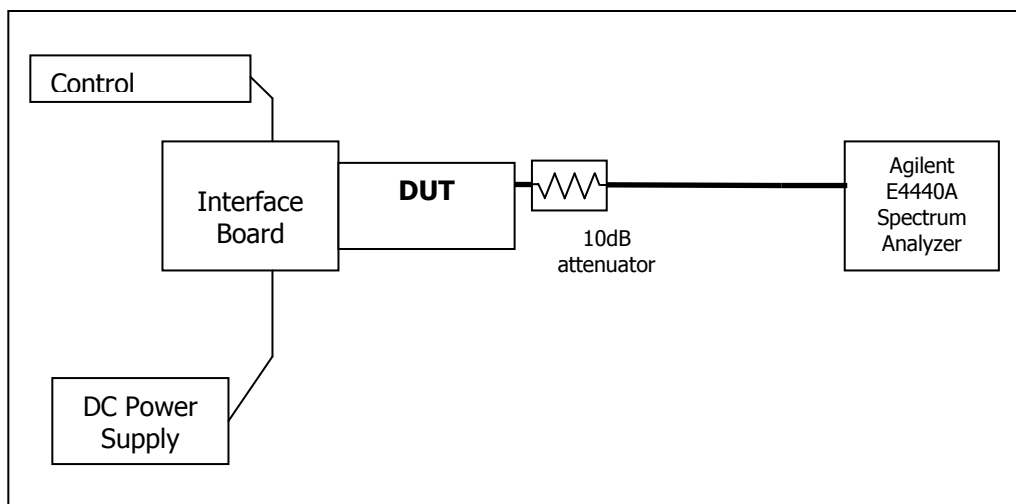

6.2 Test Equipment

EQUIPMENT	MANUFACTURER	MODEL NO.	SERIAL NO.	CAL. DATE
Control Computer	TC	Generic PC	100974	N/A
Wireless Test Set	Rohde & Schwarz	CMU200	107902	November 13, 2009
Spectrum Analyzer	Rohde & Schwarz	FSP	100060	November 24, 2009
DC Power Supply	HP	6632A	3145A	N/A
Interface Board	Shop built	ATEMux	N/A	N/A
Directional Coupler	Pasternack	PE2209-10	N/A	N/A

SIERRA WIRELESS, INC.

6.3 Test Results

Refer to the following plots.

- **Cellular Band**

Plot Number	Description
6.4.1 – 6.4.3	GMSK Mode, Low channel, 824.20 MHz
6.4.4 – 6.4.6	GMSK Mode, Middle Channel, 836.6 MHz
6.4.7 – 6.4.9	GMSK Mode, High Channel, 848.8 MHz
6.4.10 – 6.4.12	8-PSK Mode, Low channel, 824.20 MHz
6.4.13 – 6.4.15	8-PSK Mode, Middle Channel, 836.6 MHz
6.4.16 – 6.4.18	8-PSK Mode, High Channel, 848.8 MHz

- **PCS Band**

Plot Number	Description
6.4.19 – 6.4.21	GMSK Mode, Low Channel, 1850.2 MHz
6.4.22 – 6.4.24	GMSK Mode, Middle Channel, 1880.0 MHz
6.4.25 – 6.4.27	GMSK Mode, High Channel, 1909.8 MHz
6.4.28 – 6.4.30	8-PSK, Mode, Low Channel, 1850.2 MHz
6.4.31 – 6.4.33	8-PSK Mode, Middle Channel, 1880.0 MHz
6.4.34 – 6.4.36	8-PSK Mode, High Channel, 1909.8 MHz

- **UMTS Cellular Band**

Plot Number	Description
6.4.37 – 6.4.39	WCDMA Mode, Low Channel, 826.4 MHz
6.4.40 – 6.4.42	WCDMA Mode, Middle Channel, 836.4 MHz
6.4.43 – 6.4.45	WCDMA Mode, High Channel, 846.6 MHz

- **UMTS PCS Band**

Plot Number	Description
6.4.46 – 6.4.48	WCDMA Mode, Low Channel, 1852.4 MHz
6.4.49 – 6.4.51	WCDMA Mode, Middle Channel, 1880.0 MHz
6.4.52 – 6.4.54	WCDMA Mode, High Channel, 1907.6 MHz

The plots below show that the conducted emission limits requirements are met.

6.4 Test Plots

Plot 6.4.1) Out of Band Emissions at Antenna Terminals
 GMSK, Low channel, 824.200 MHz, 1 MHz to 1 GHz

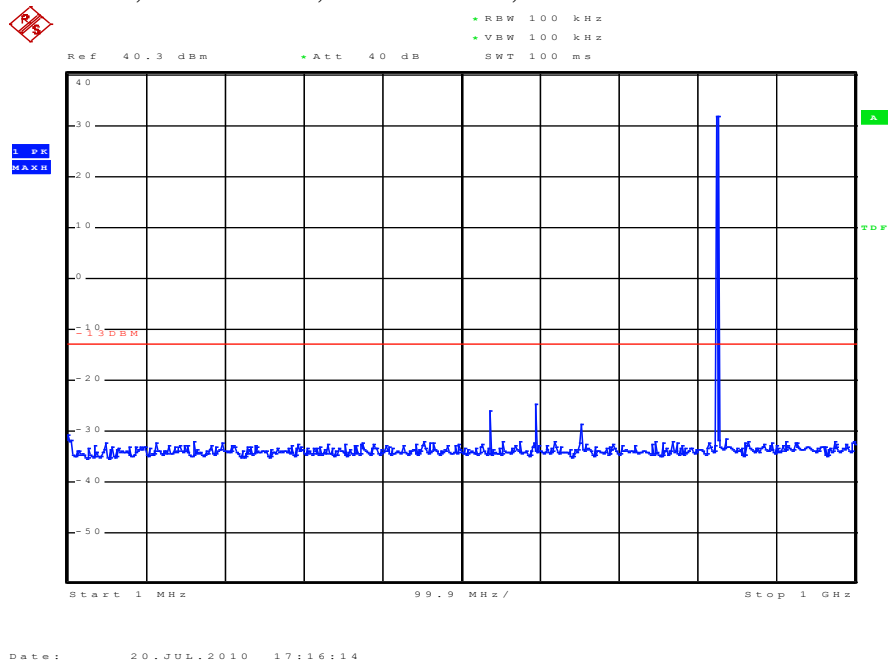

Plot 6.4.2) Out of Band Emissions at Antenna Terminals
 GMSK, Low channel, 824.200 MHz, TX signal +/- 20 MHz

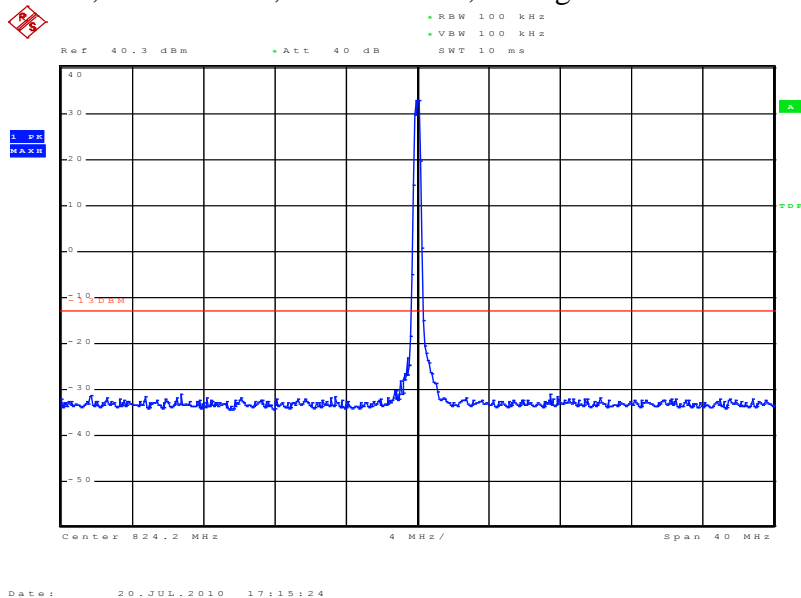

The strong emission shown in each case is the carrier signal.

SIERRA WIRELESS, INC.

Plot 6.4.3) Out of Band Emissions at Antenna Terminals
 GSMK, Low channel, 824.200 MHz, 1 GHz to 20 GHz

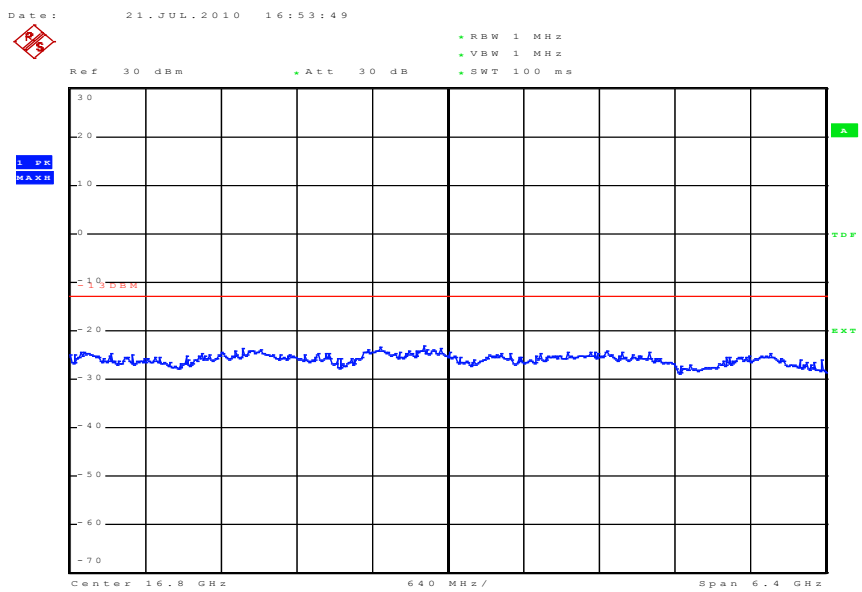
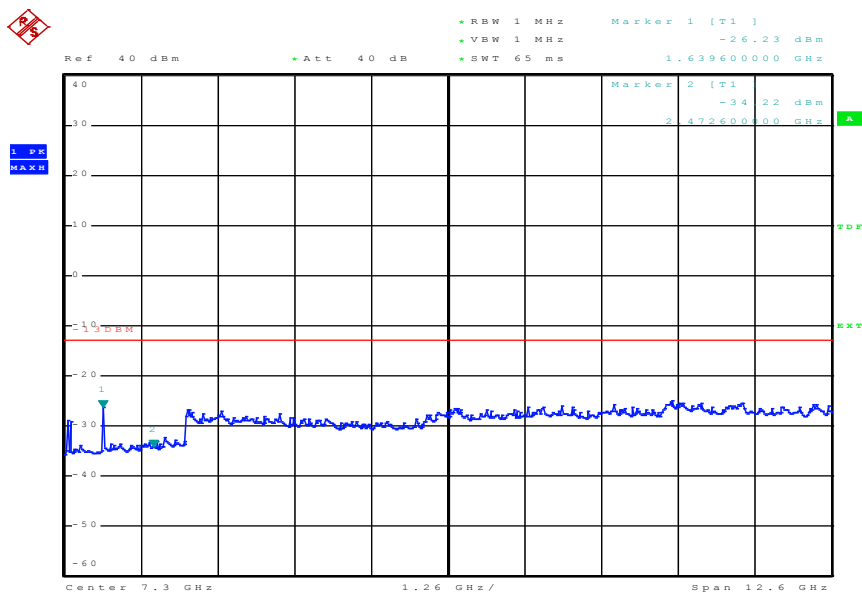

Date: 21.JUL.2010 17:10:56

Cellular Harmonics for Ch. 128 (824.2 MHz)	Level (dBm)
Second	-26.23 dBm
Third	-34.22 dBm
Others	----

Plot 6.4.4) Out of Band Emissions at Antenna Terminals
 GMSK, Mid Channel, 836.6 MHz, 1 MHz to 1 GHz

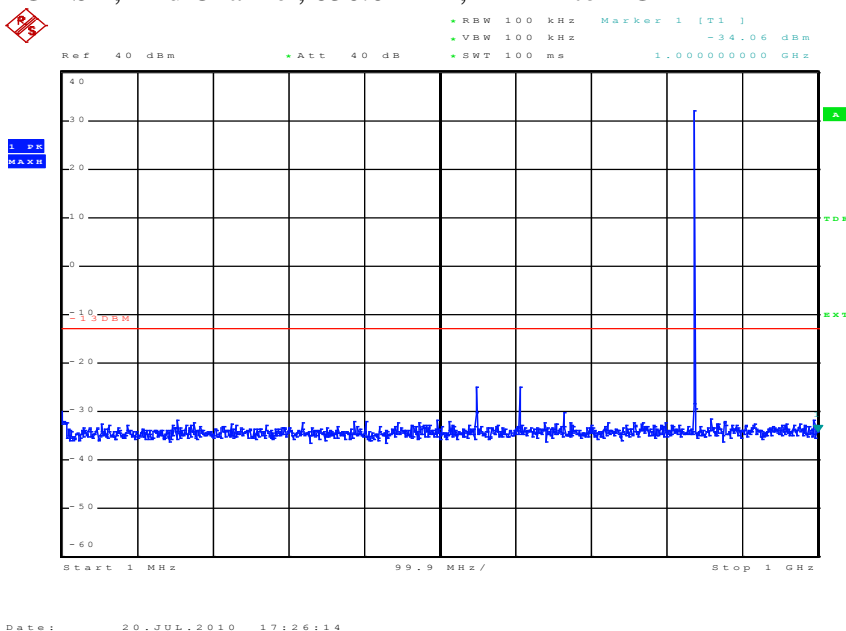

Plot 6.4.5) Out of Band Emissions at Antenna Terminals
 GMSK, Mid Channel, 836.6 MHz, TX signal +/- 20 MHz

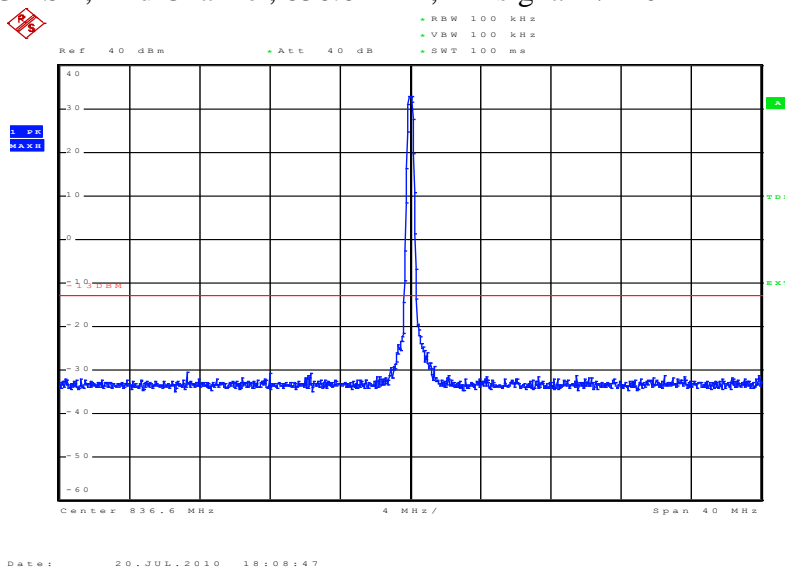

The strong emission shown in each case is the carrier signal.

SIERRA WIRELESS, INC.

Plot 6.4.6) Out of Band Emissions at Antenna Terminals GMSK, Mid Channel, 836.6 MHz, 1 GHz to 20 GHz

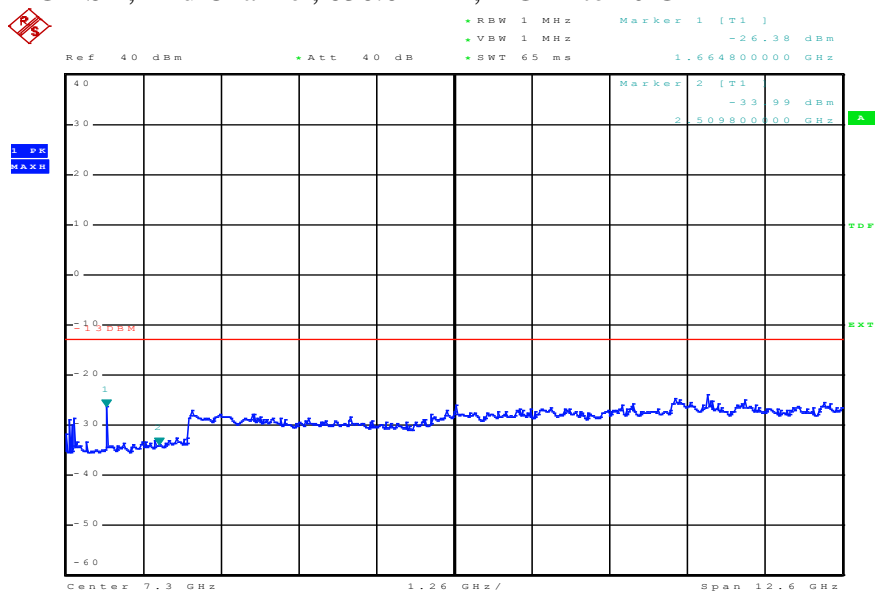

Date: 21.JUL.2010 16:56:10

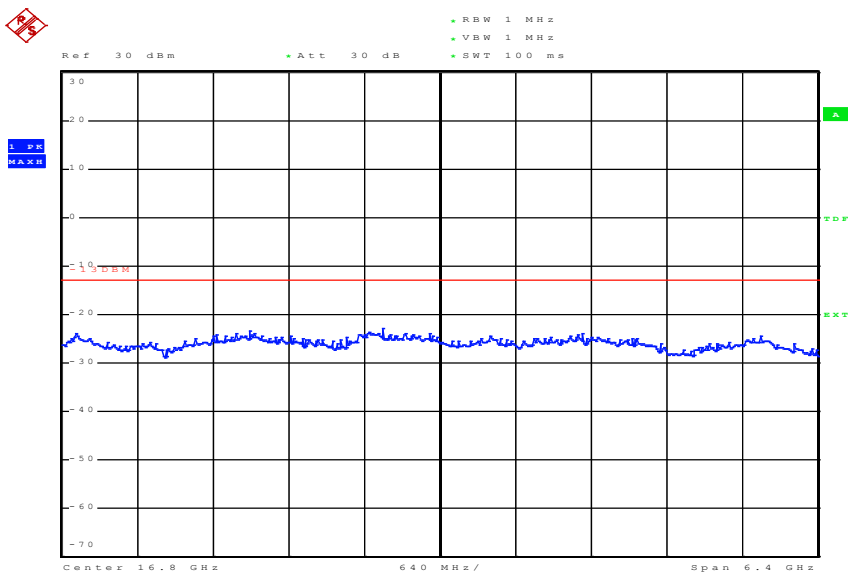

Date: 21.JUL.2010 17:10:23

Cellular Harmonics for Ch. 190 (836.6 MHz)	Level (dBm)
Second	-26.38 dBm
Third	-33.99 dBm
Others	----

Plot 6.4.7) Out of Band Emissions at Antenna Terminals
 GMSK, High Channel, 848.8 MHz, 1 MHz to 1 GHz

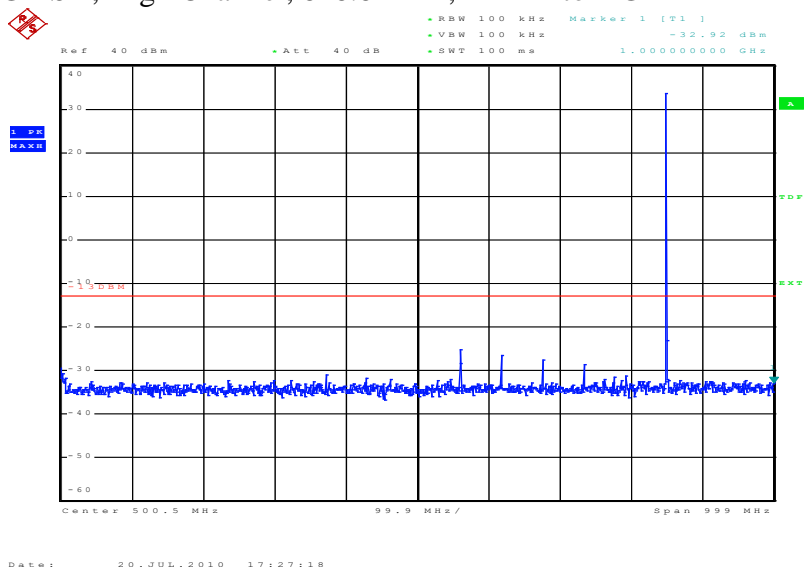

Plot 6.4.8) Out of Band Emissions at Antenna Terminals
 GMSK, High Channel, 848.8 MHz, TX signal +/- 20 MHz

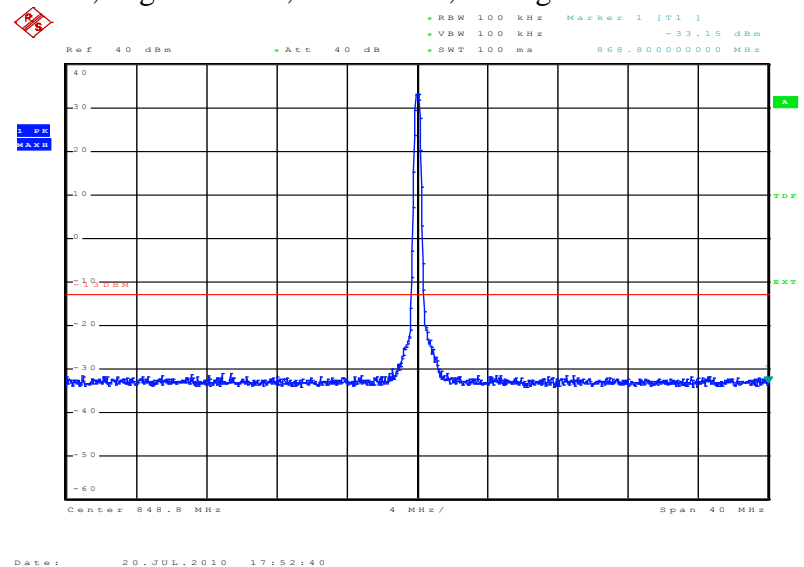

The strong emission shown in each case is the carrier signal.

Plot 6.4.9) Out of Band Emissions at Antenna Terminals
GMSK, High Channel, 848.8 MHz, 1 GHz to 20 GHz

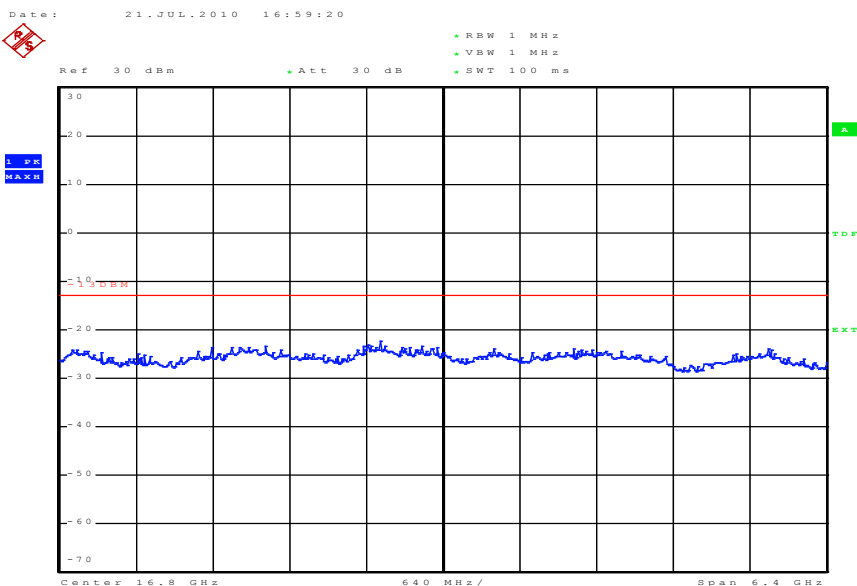
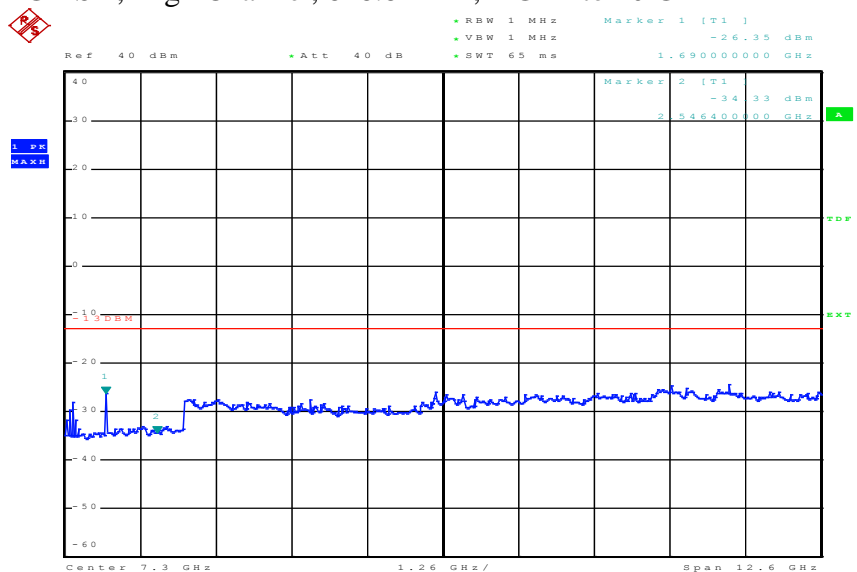

Date: 21.JUL.2010 17:09:52

Cellular Harmonics for Ch. 251 (848.8 MHz)	Level (dBm)
Second	-26.35 dBm
Third	-34.33 dBm
Others	----

Plot 6.4.10) Out of Band Emissions at Antenna Terminals
 8-PSK, Low channel, 824.200 MHz, 1 MHz to 1 GHz

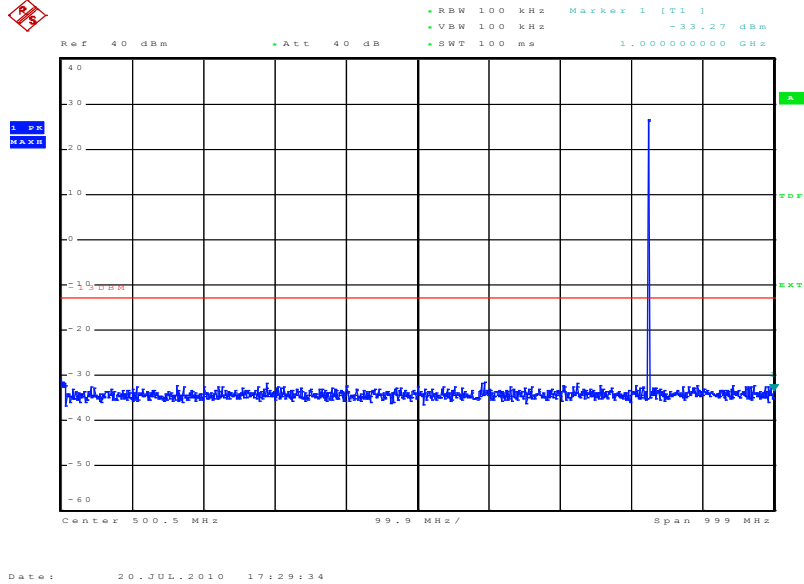

Plot 6.4.11) Out of Band Emissions at Antenna Terminals
 8-PSK, Low channel, 824.200 MHz, TX signal +/- 20 MHz

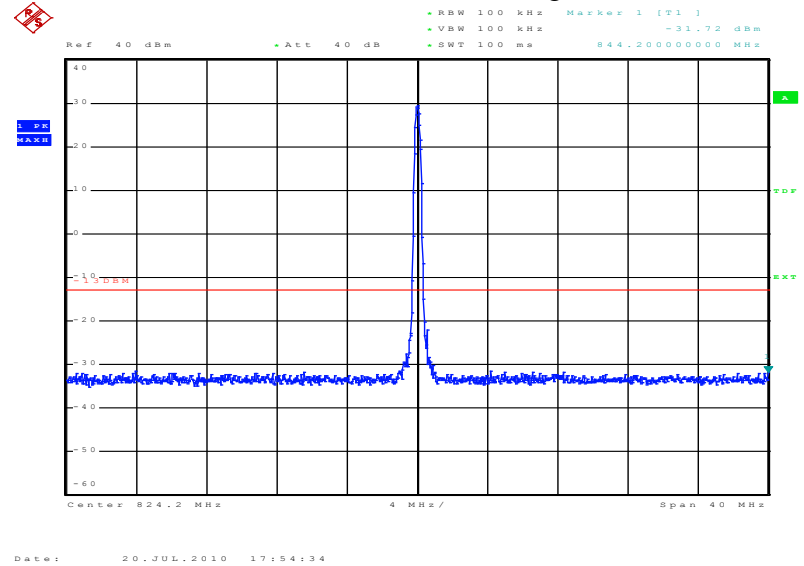

The strong emission shown in each case is the carrier signal.

Plot 6.4.12) Out of Band Emissions at Antenna Terminals
 8-PSK, Low channel, 824.200 MHz, 1 GHz to 20 GHz

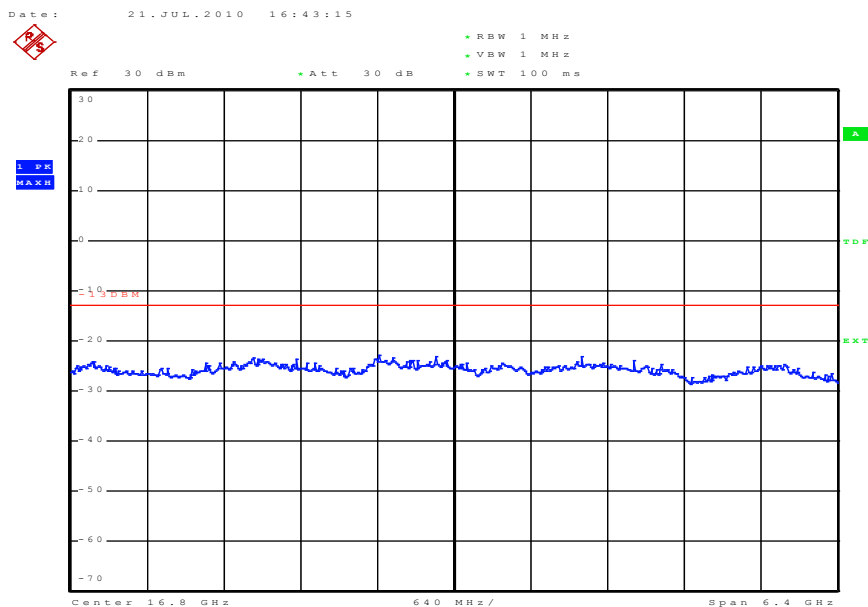
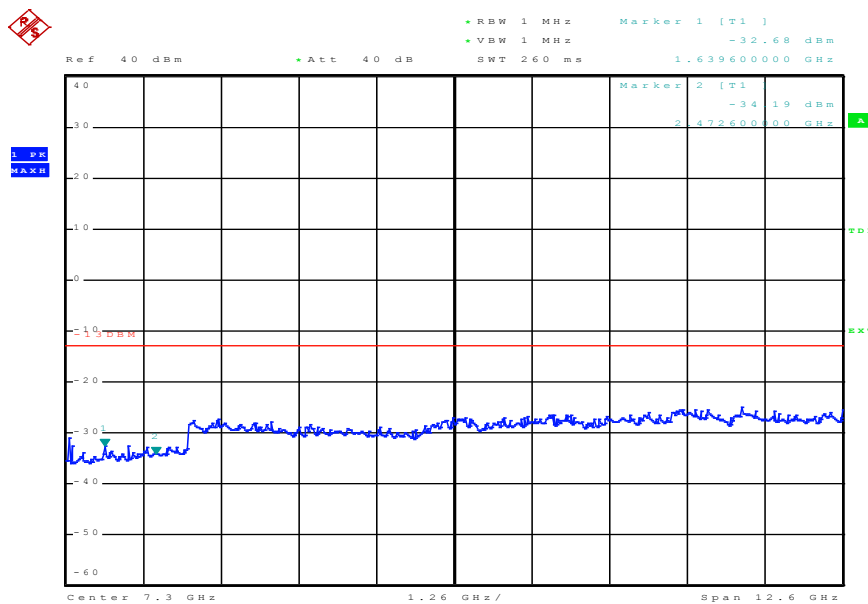

Date: 21.JUL.2010 17:08:13

Cellular Harmonics for Ch. 128 (824.2 MHz)	Level (dBm)
Second	-32.68 dBm
Third	-34.19 dBm
Others	----

Plot 6.4.13) Out of Band Emissions at Antenna Terminals
 8-PSK, Mid Channel, 836.6 MHz, 1 MHz to 1 GHz

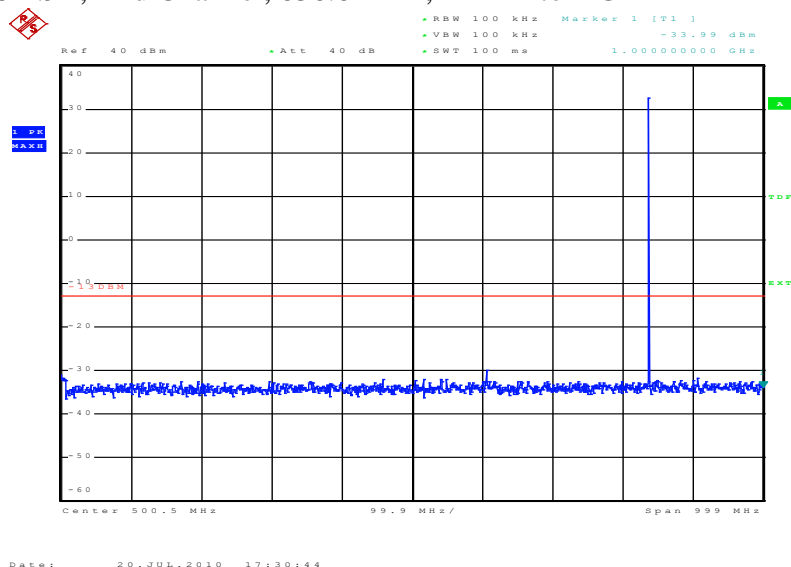

Plot 6.4.14) Out of Band Emissions at Antenna Terminals
 8-PSK, Mid Channel, 836.6 MHz, TX signal +/- 20 MHz

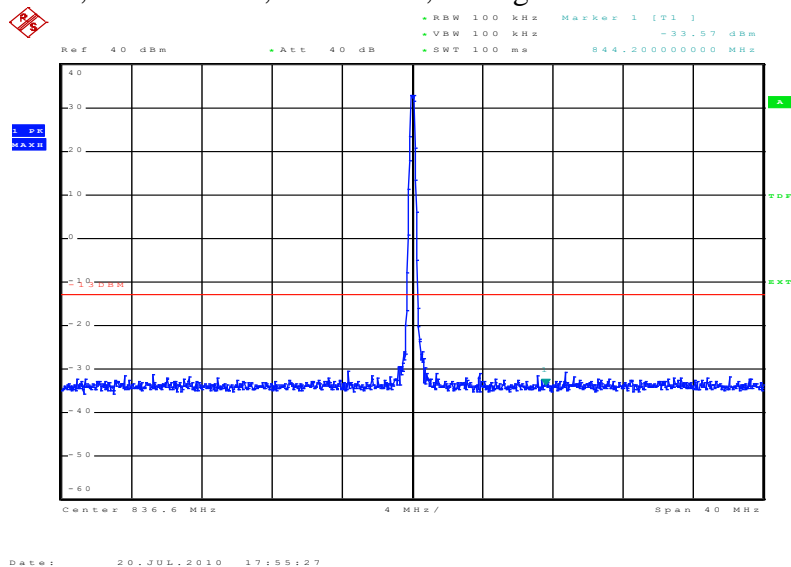

The strong emission shown in each case is the carrier signal.

Plot 6.4.15) Out of Band Emissions at Antenna Terminals
 8-PSK, Mid Channel, 836.6 MHz, 1 GHz to 20 GHz

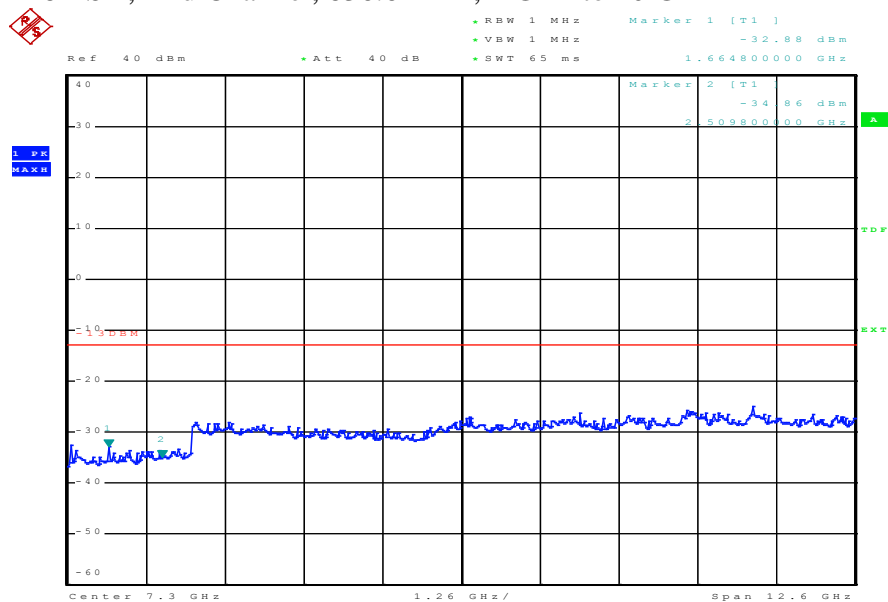

Date: 21.JUL.2010 16:48:29

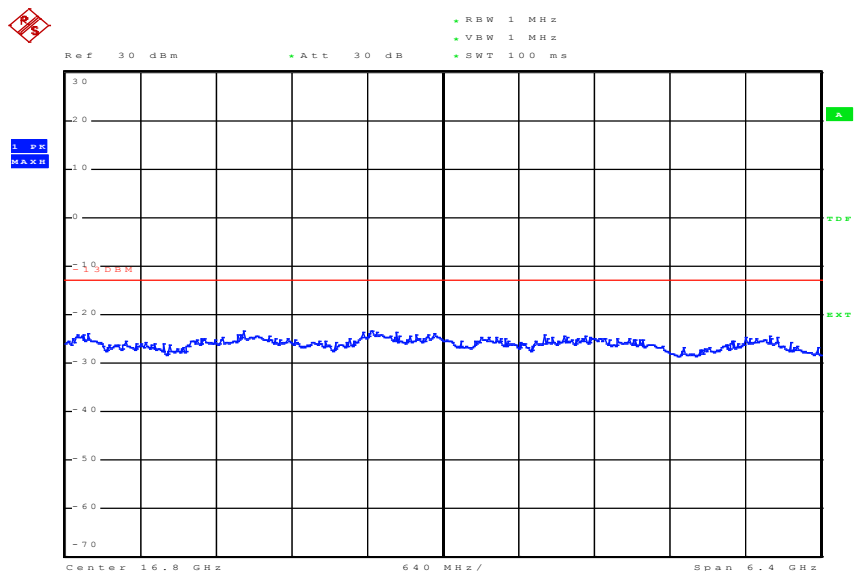

Date: 21.JUL.2010 17:07:37

Cellular Harmonics for Ch. 190 (836.6 MHz)	Level (dBm)
Second	-32.88 dBm
Third	-34.86 dBm
Others	----

Plot 6.4.16) Out of Band Emissions at Antenna Terminals
 8-PSK, High Channel, 848.8 MHz, 1 MHz to 1 GHz

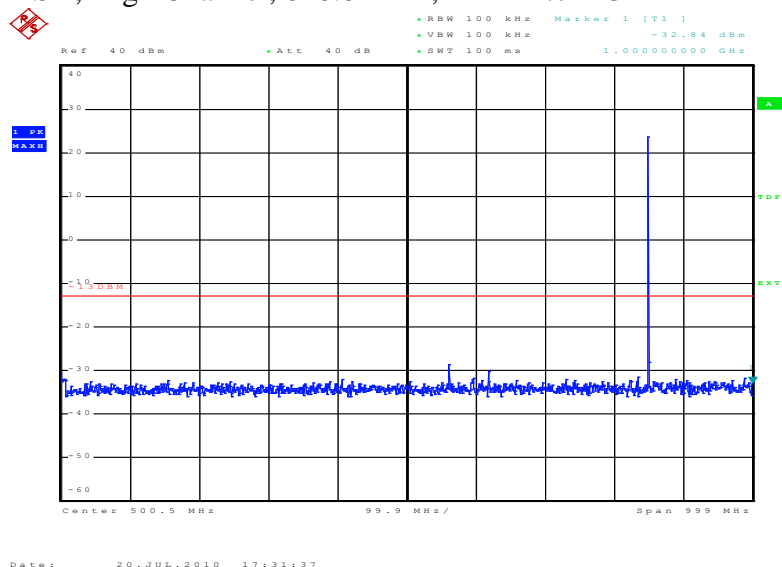

Plot 6.4.17) Out of Band Emissions at Antenna Terminals
 8-PSK, High Channel, 848.8 MHz, TX signal +/- 20 MHz

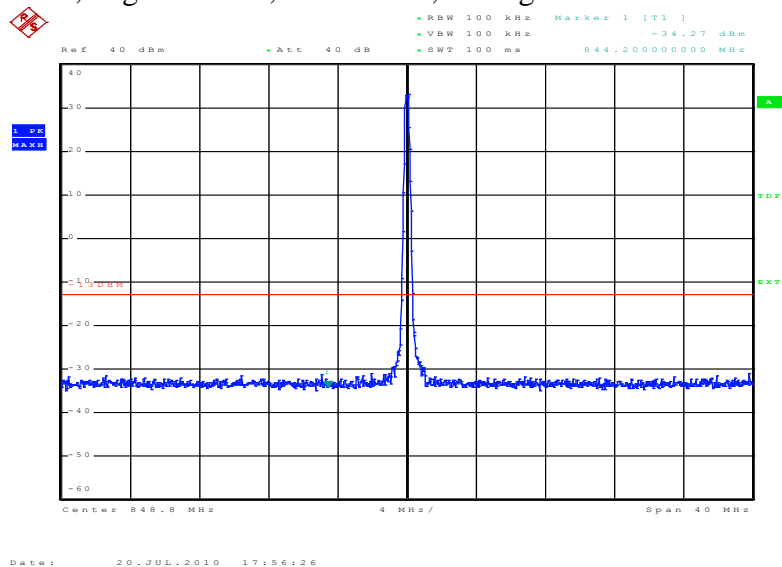

The strong emission shown in each case is the carrier signal.

Plot 6.4.18) Out of Band Emissions at Antenna Terminals
 8-PSK, High Channel, 848.8 MHz, 1 GHz to 20 GHz

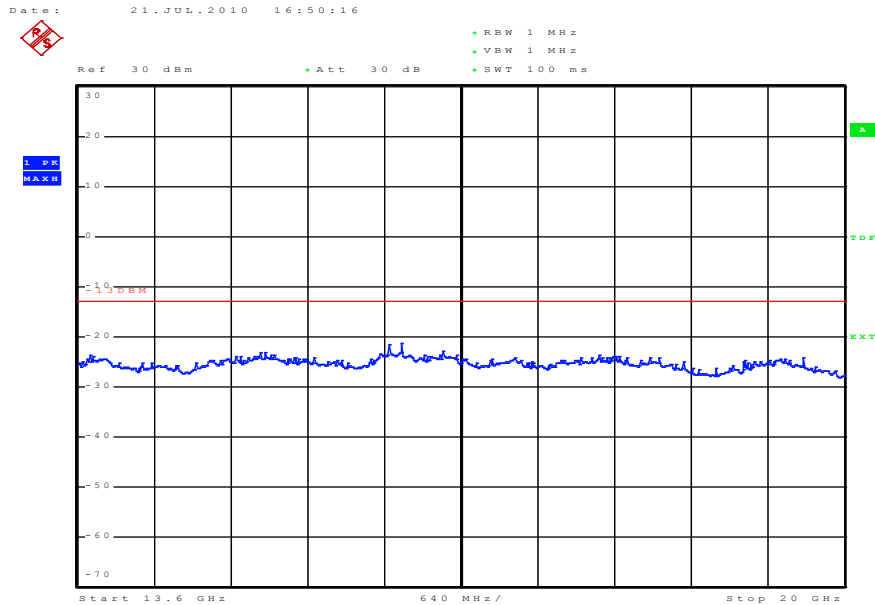
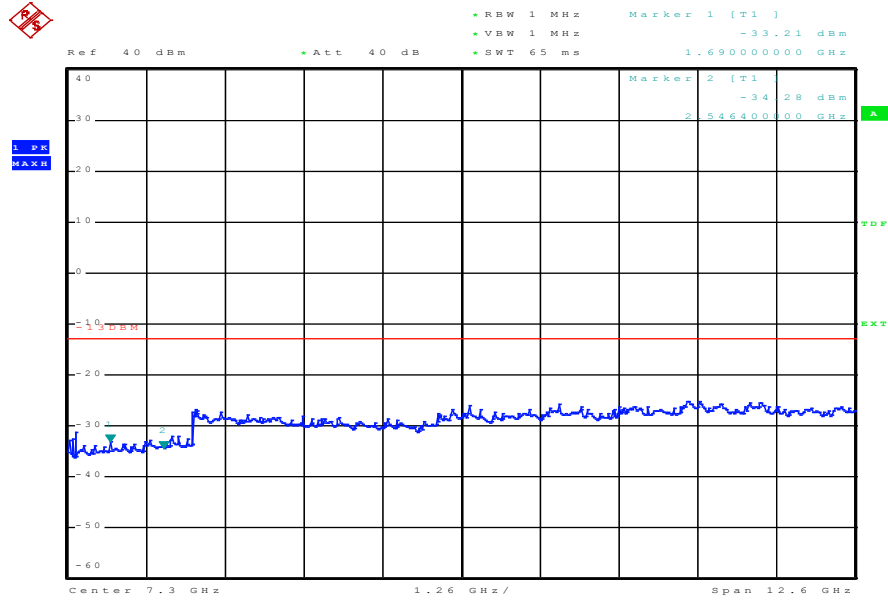

Date: 21.JUL.2010 17:06:59

Cellular Harmonics for Ch. 251 (848.8 MHz)	Level (dBm)
Second	-33.21 dBm
Third	-34.28 dBm
Others	----

Plot 6.4.19) Out of Band Emissions at Antenna Terminals
 GSMK, Low channel, 1850.2 MHz, 1 MHz to 1 GHz

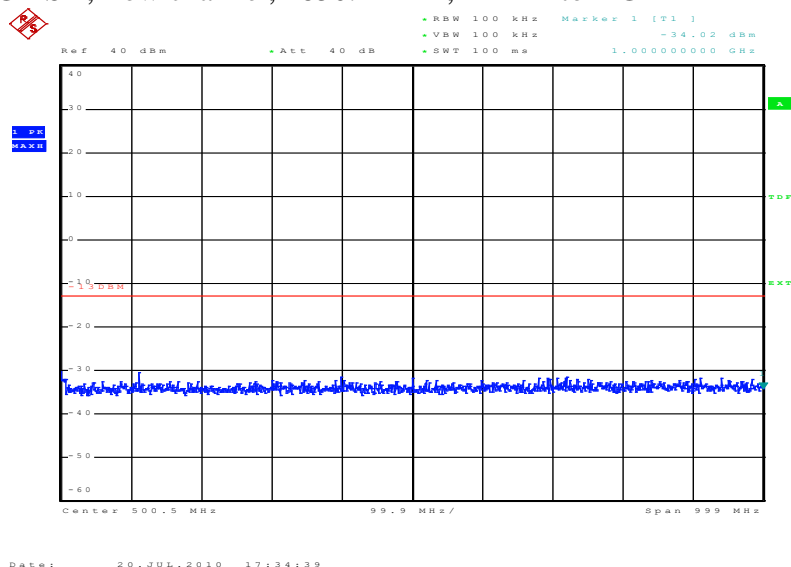

Plot 6.4.20) Out of Band Emissions at Antenna Terminals
 GSMK, Low channel, 1850.2 MHz, TX signal +/- 20 MHz

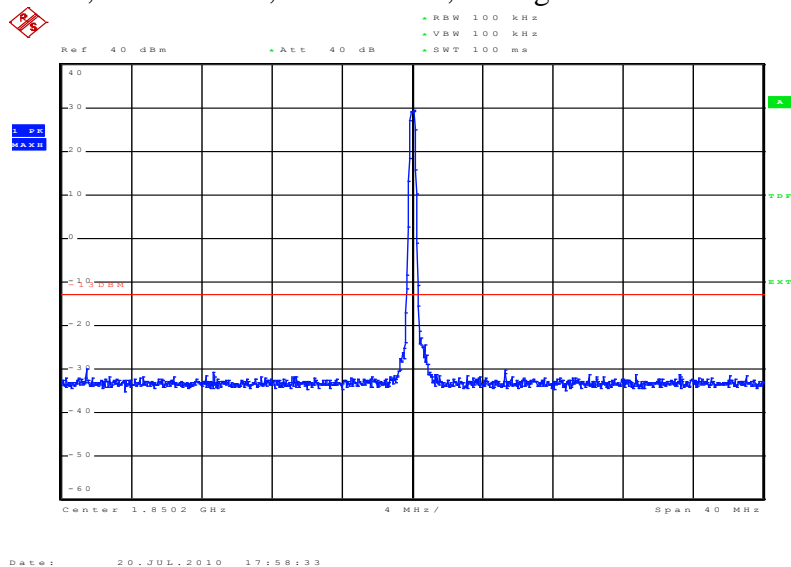

The strong emission shown is the carrier signal.

Plot 6.4.21) Out of Band Emissions at Antenna Terminals
GMSK, Low channel, 1850.2 MHz, 1 GHz to 20 GHz

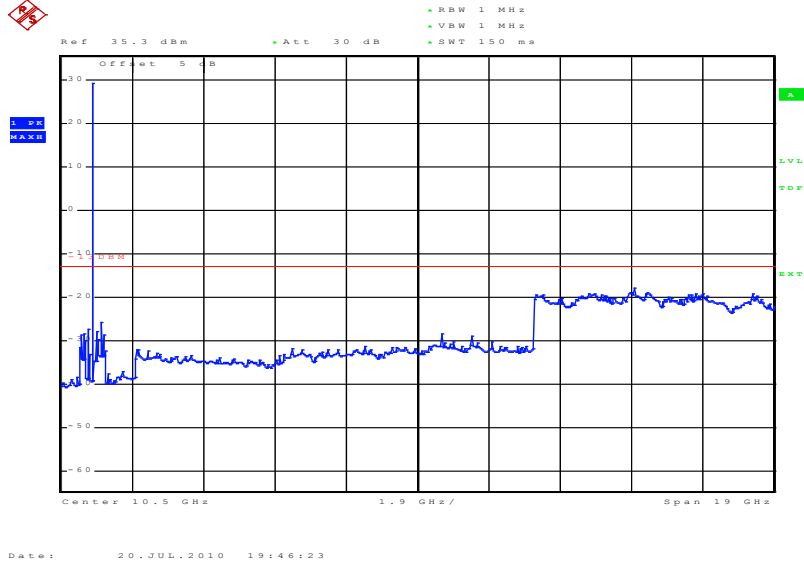

The strong emission shown is the carrier signal.

Plot 6.4.22) Out of Band Emissions at Antenna Terminals
 GSMK, Middle channel, 1880.0 MHz, 1 MHz to 1 GHz

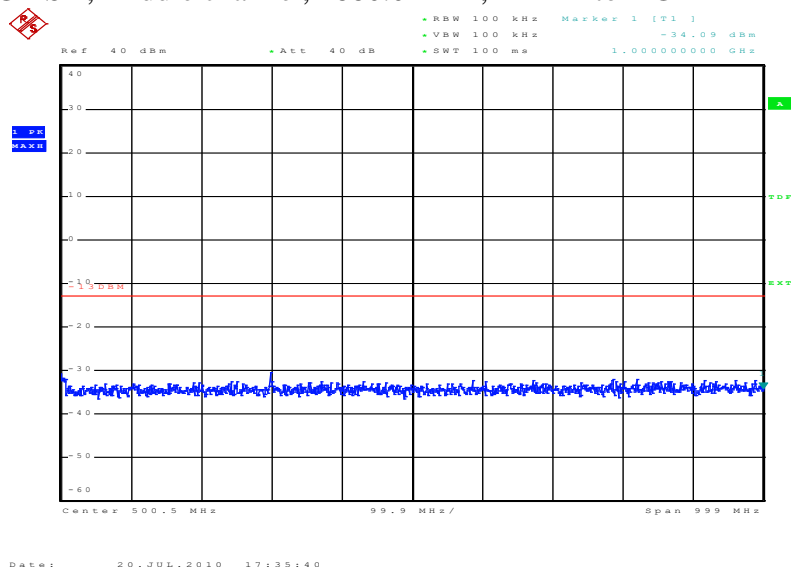

Plot 6.4.23) Out of Band Emissions at Antenna Terminals
 GSMK, Middle channel, 1880.0 MHz, TX signal +/- 20 MHz

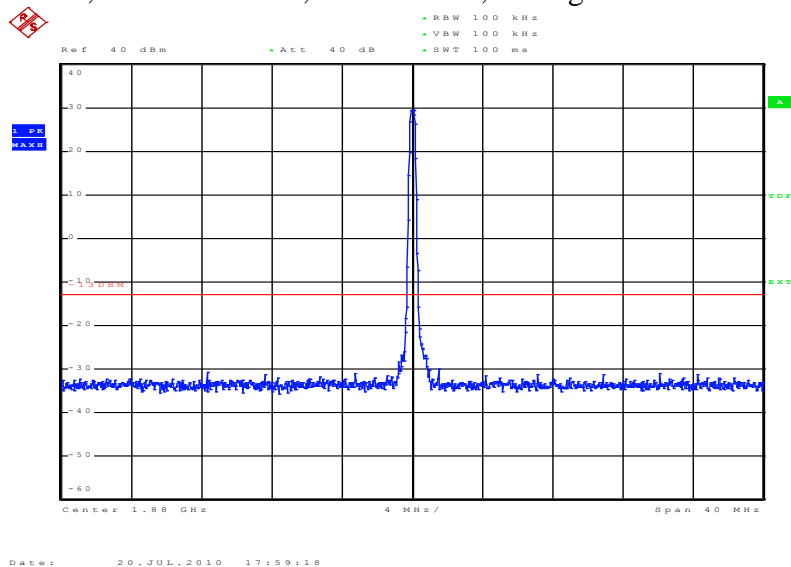

The strong emission shown is the carrier signal.

Plot 6.4.24) Out of Band Emissions at Antenna Terminals
GMSK, Middle channel, 1880.0 MHz, 1 GHz to 20 GHz

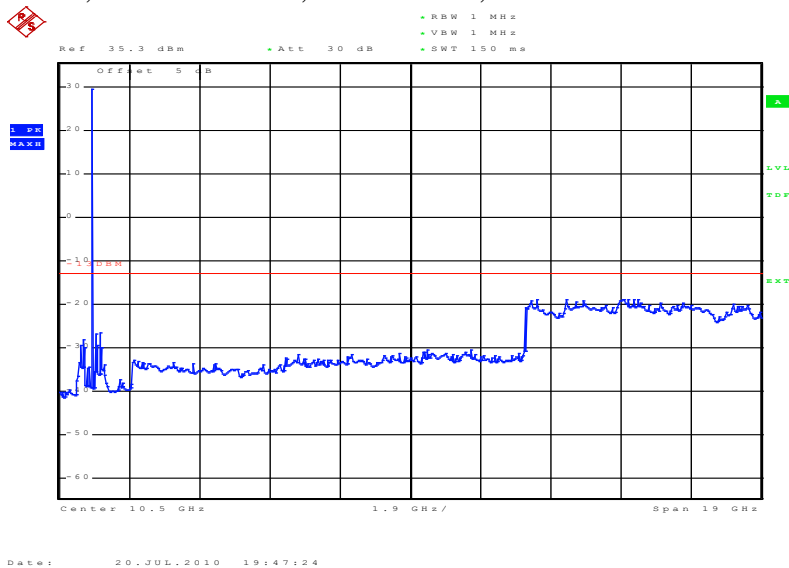

The strong emission shown is the carrier signal.

Plot 6.4.25) Out of Band Emissions at Antenna Terminals
 GMSK, High channel, 1909.8 MHz, 1 MHz to 1 GHz

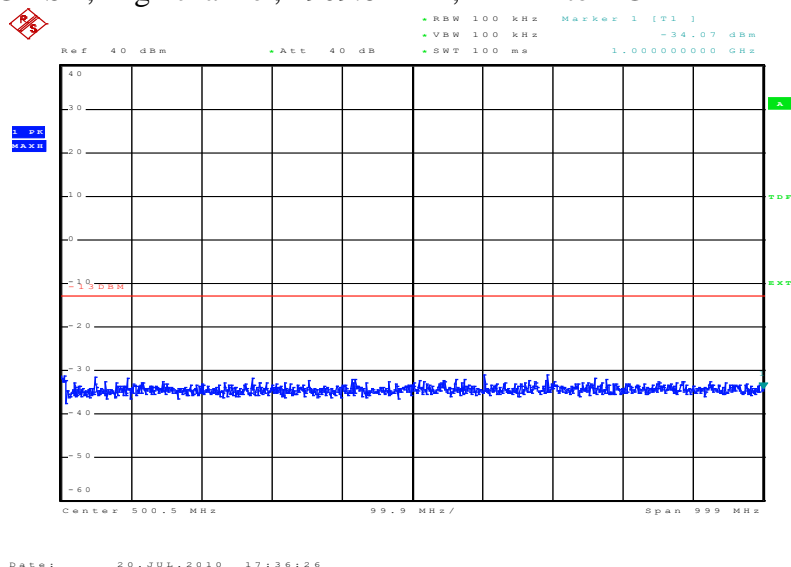

Plot 6.4.26) Out of Band Emissions at Antenna Terminals
 GMSK, High channel, 1909.8 MHz, TX signal +/- 20 MHz

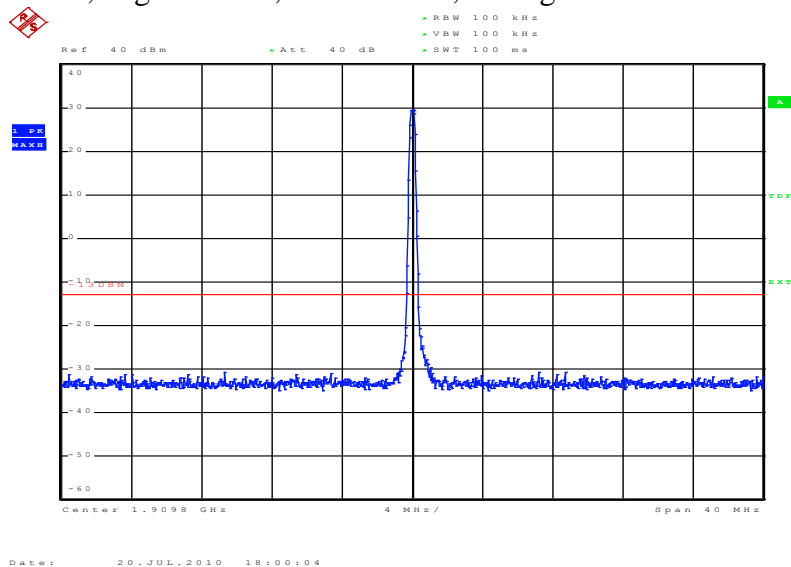

The strong emission shown is the carrier signal.

Plot 6.4.27) Out of Band Emissions at Antenna Terminals
GMSK, High channel, 1909.8 MHz, 1 GHz to 20 GHz

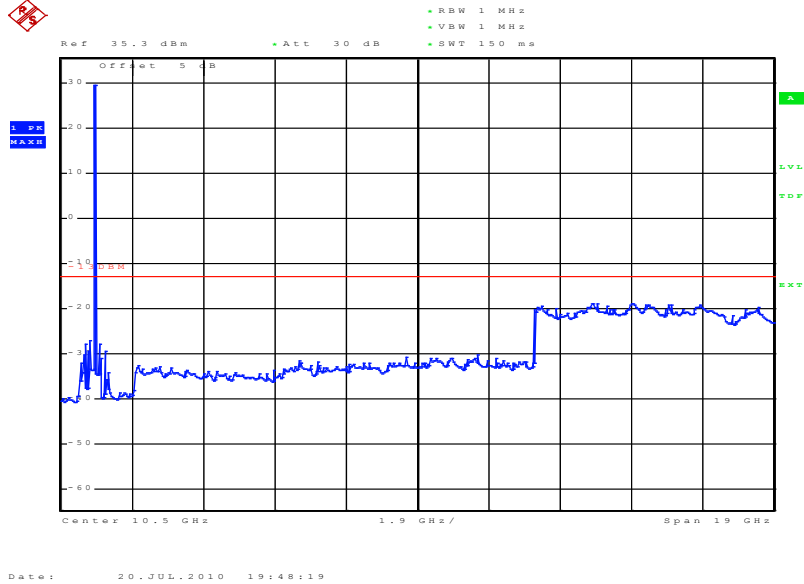

The strong emission shown is the carrier signal.

Plot 6.4.28) Out of Band Emissions at Antenna Terminals
 8-PSK, Low channel, 1850.2 MHz, 1 MHz to 1 GHz

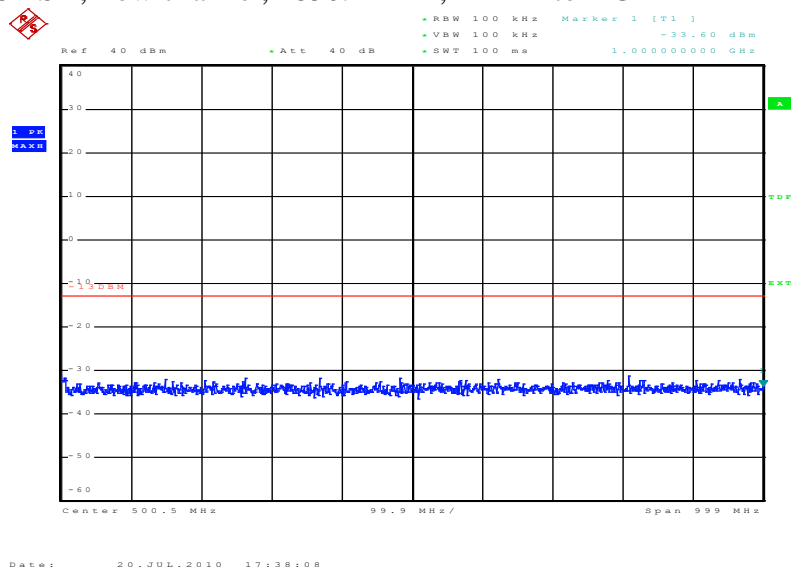

Plot 6.4.29) Out of Band Emissions at Antenna Terminals
 8-PSK, Low channel, 1850.2 MHz, TX signal +/- 20 MHz

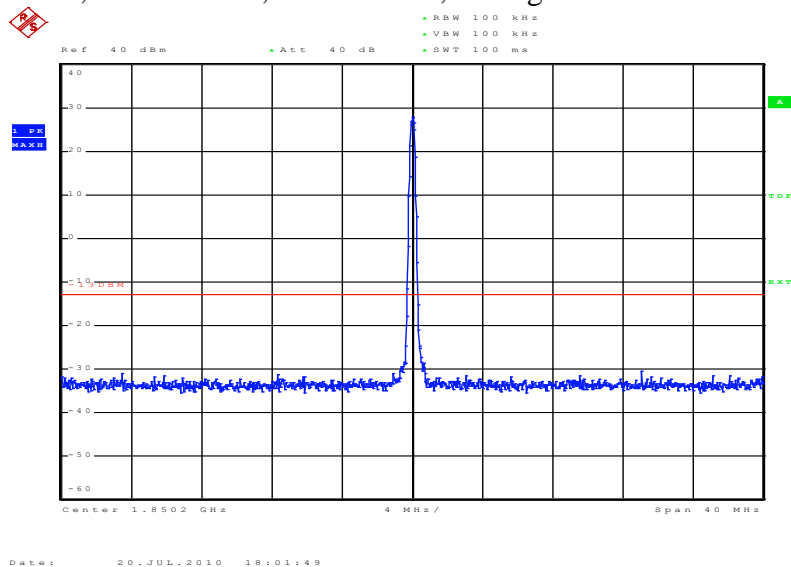

The strong emission shown is the carrier signal.

Plot 6.4.30) Out of Band Emissions at Antenna Terminals
8-PSK, Low channel, 1850.2 MHz, 1 GHz to 20 GHz

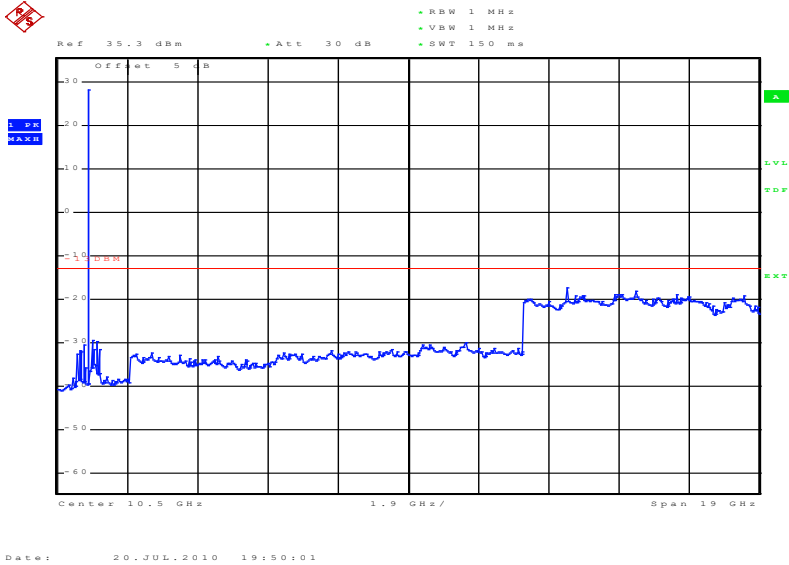

The strong emission shown is the carrier signal.

Plot 6.4.31) Out of Band Emissions at Antenna Terminals
 8-PSK, Middle channel, 1880.0 MHz, 1 MHz to 1 GHz

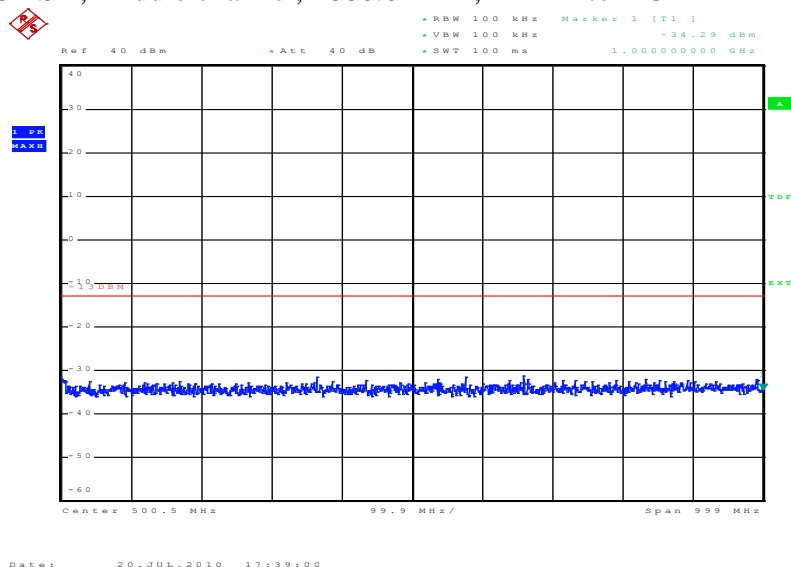

Plot 6.4.32) Out of Band Emissions at Antenna Terminals
 8-PSK, Middle channel, 1880.0 MHz, TX signal +/- 20 MHz

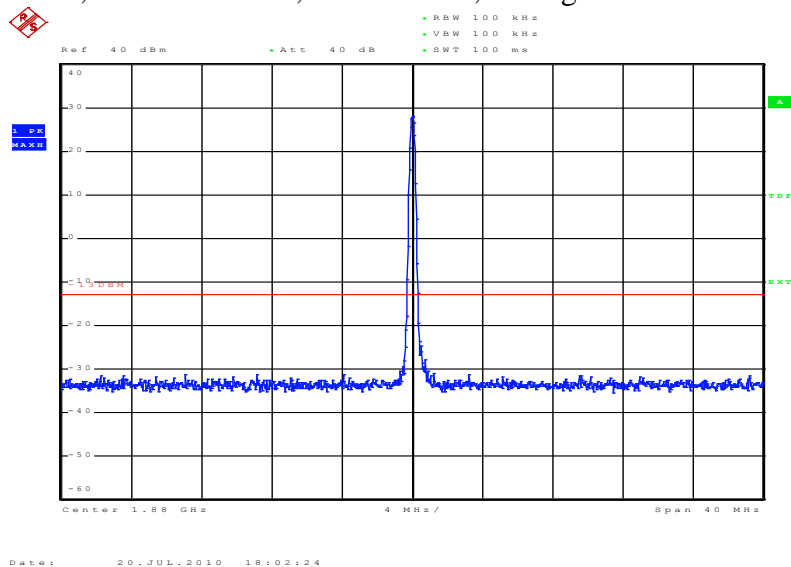

The strong emission shown is the carrier signal.

Plot 6.4.33) Out of Band Emissions at Antenna Terminals
8-PSK, Middle channel, 1880.0 MHz, 1 GHz to 20 GHz

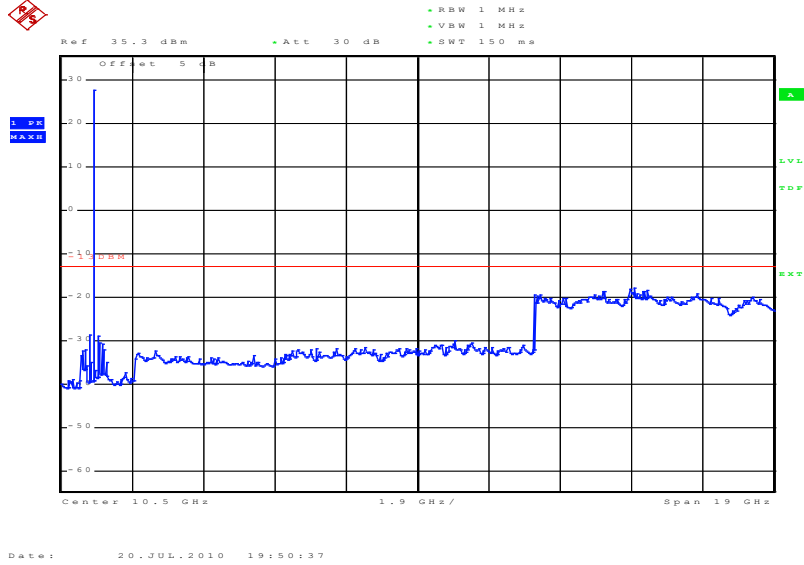

The strong emission shown is the carrier signal.

Plot 6.4.34) Out of Band Emissions at Antenna Terminals
 8-PSK, High channel, 1909.8 MHz, 1 MHz to 1 GHz

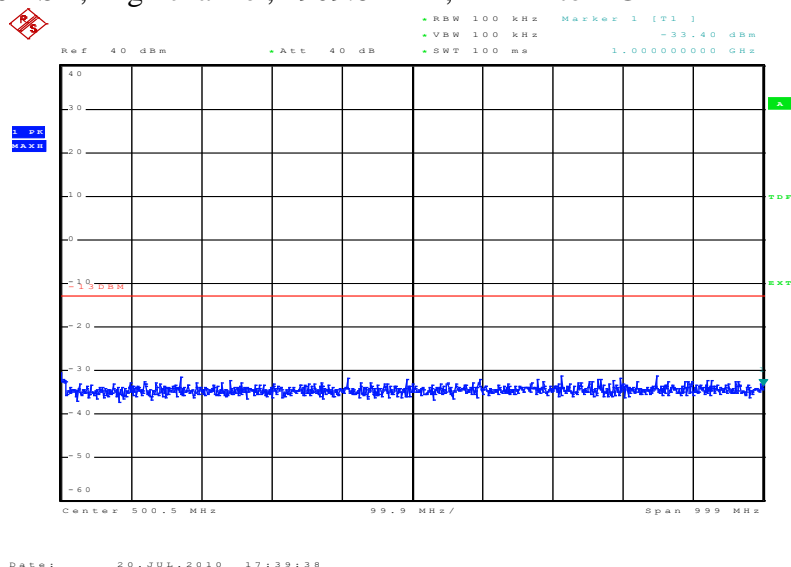

Plot 6.4.35) Out of Band Emissions at Antenna Terminals
 8-PSK, High channel, 1909.8 MHz, TX signal +/- 20 MHz

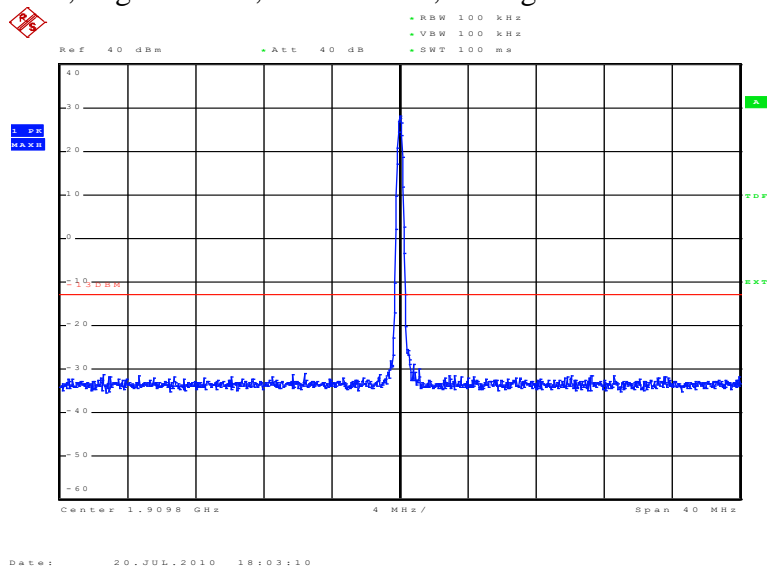

The strong emission shown is the carrier signal.

Plot 6.4.36) Out of Band Emissions at Antenna Terminals
8-PSK, High channel, 1909.8 MHz, 1 GHz to 20 GHz

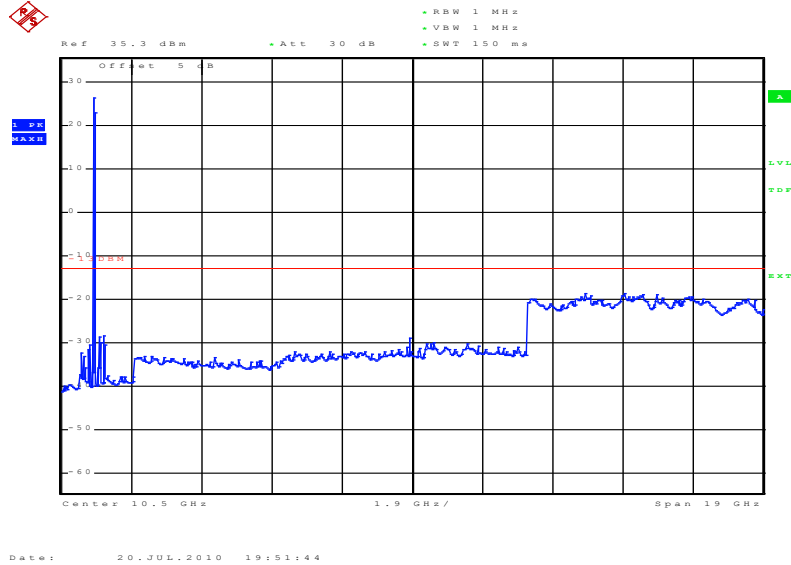

The strong emission shown is the carrier signal.

Plot 6.4.37) Out of Band Emissions at Antenna Terminals
WCDMA, Low channel, 826.4 MHz, 1 MHz to 1 GHz

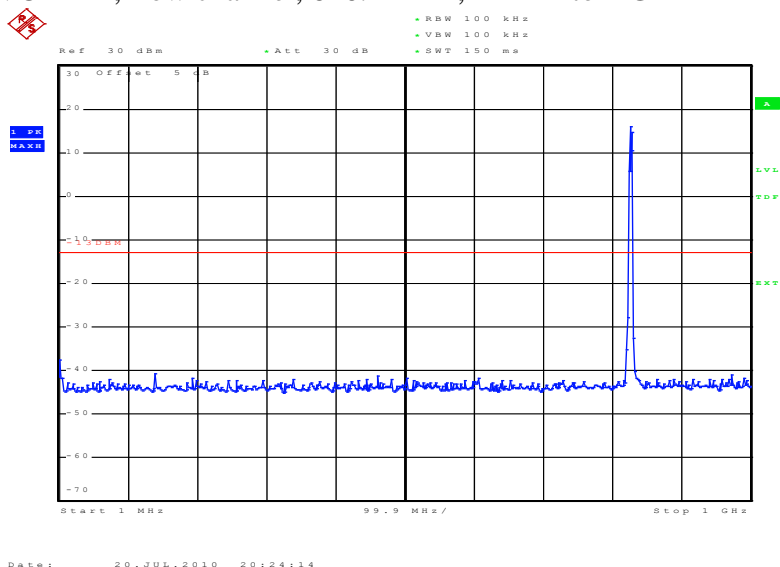

Plot 6.4.38) Out of Band Emissions at Antenna Terminals
WCDMA, Low channel, 826.4 MHz, TX signal +/- 20 MHz

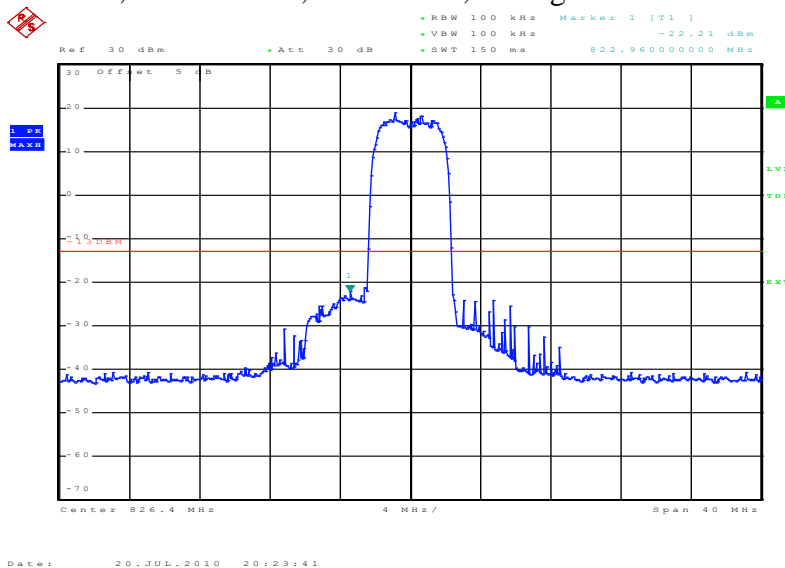

The strong emission shown in each case is the carrier signal.

SIERRA WIRELESS, INC.

Plot 6.4.39) Out of Band Emissions at Antenna Terminals
WCDMA, Low channel, 826.4 MHz, 1 GHz to 20 GHz

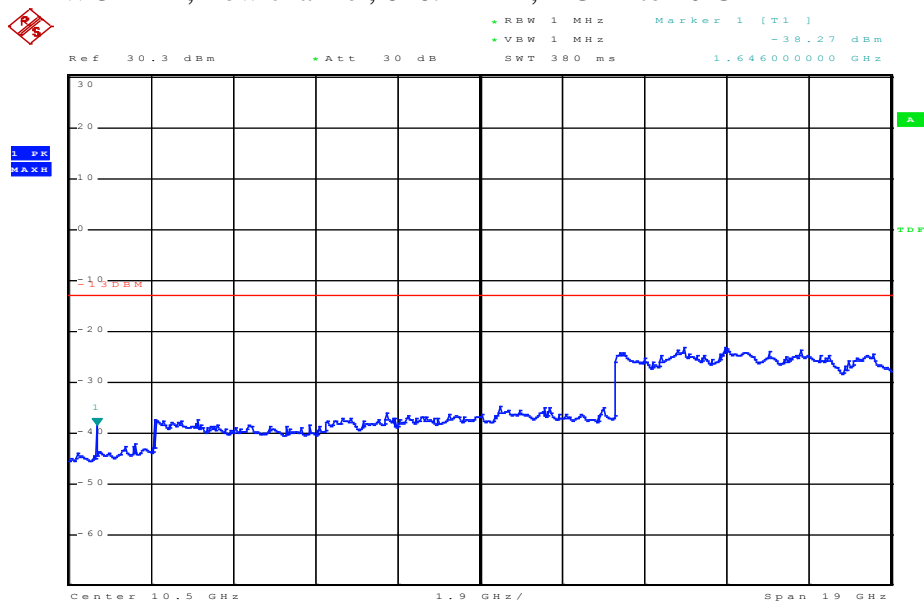

Date: 23.JUL.2010 15:37:54

Cellular Harmonics for Ch. 4132 (826.4 MHz)	Level (dBm)
Second	-38.27 dBm
Third	----
Others	----

Plot 6.4.40) Out of Band Emissions at Antenna Terminals
WCDMA, Middle channel, 836.4 MHz, 1 MHz to 1 GHz

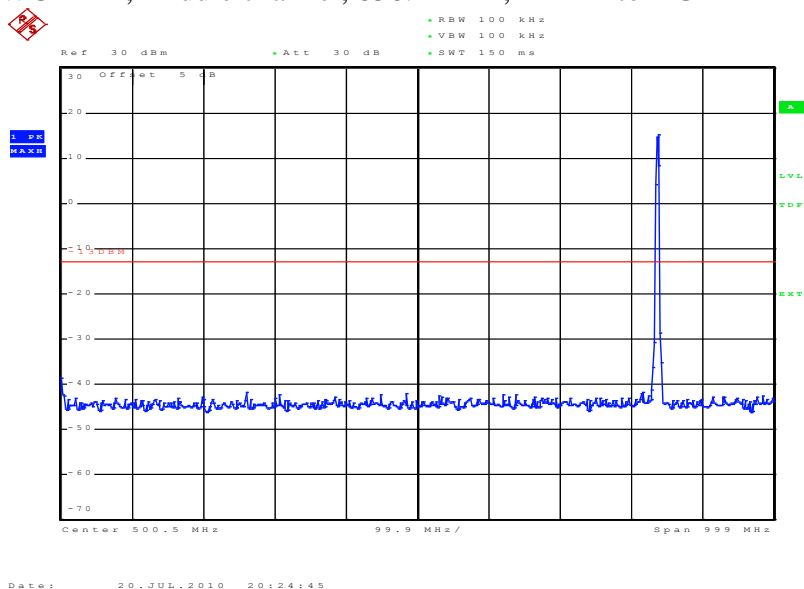

Plot 6.4.41) Out of Band Emissions at Antenna Terminals
WCDMA, Middle channel, 836.4 MHz, TX signal +/- 20 MHz

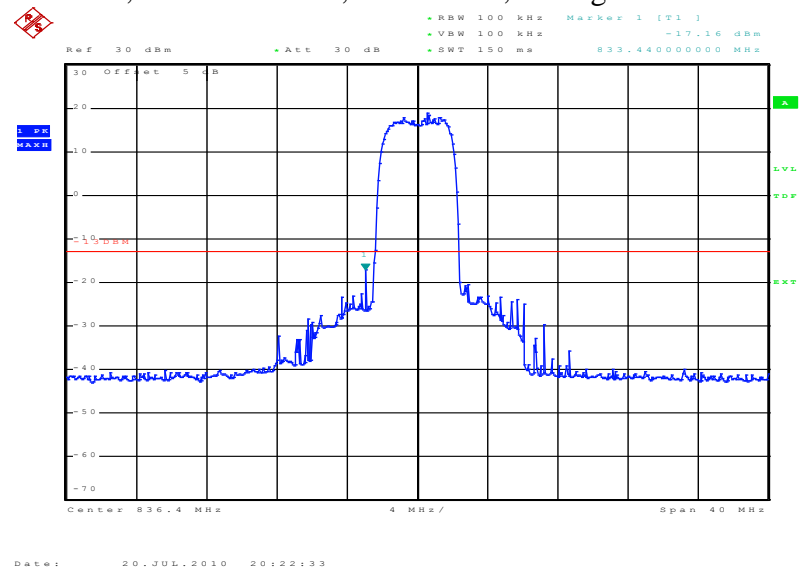

The strong emission shown in each case is the carrier signal.

SIERRA WIRELESS, INC.

Plot 6.4.42) Out of Band Emissions at Antenna Terminals
WCDMA, Middle channel, 836.4 MHz, 1 GHz to 20 GHz

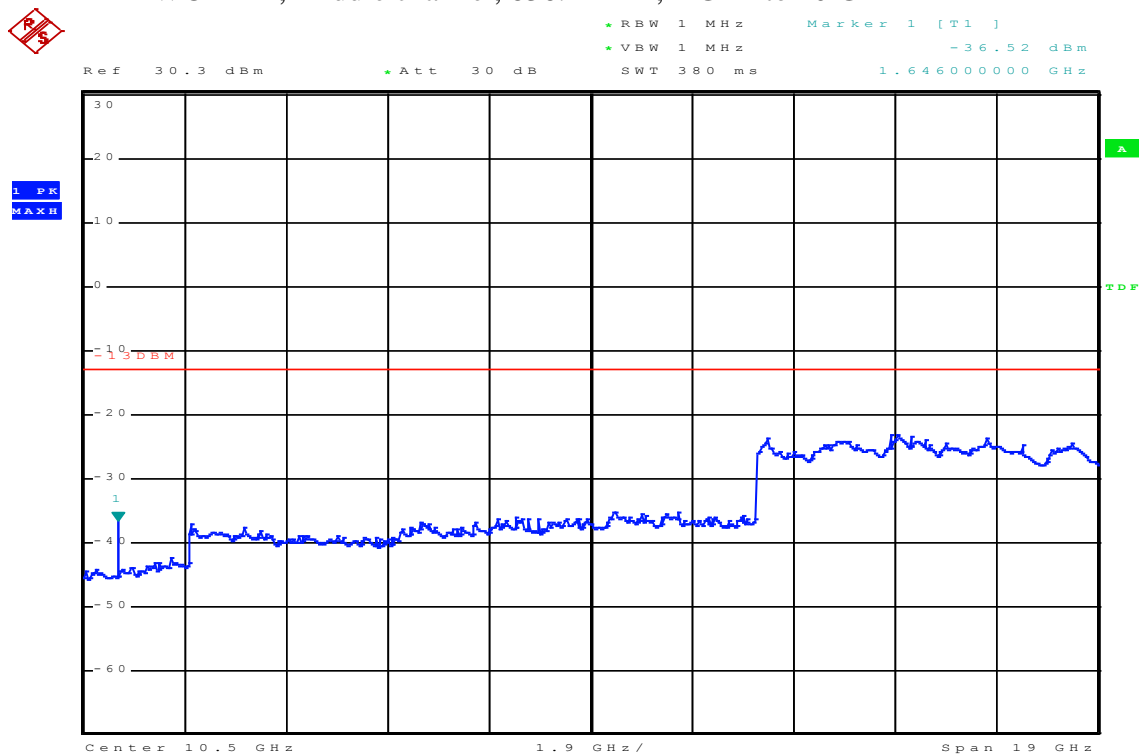

Date: 23.JUL.2010 15:40:11

Cellular Harmonics for Ch. 4182 (836.4 MHz)	Level (dBm)
Second	-36.52 dBm
Third	----
Others	----

Plot 6.4.43) Out of Band Emissions at Antenna Terminals
WCDMA, High Channel, 846.6 MHz, 1 MHz to 1 GHz

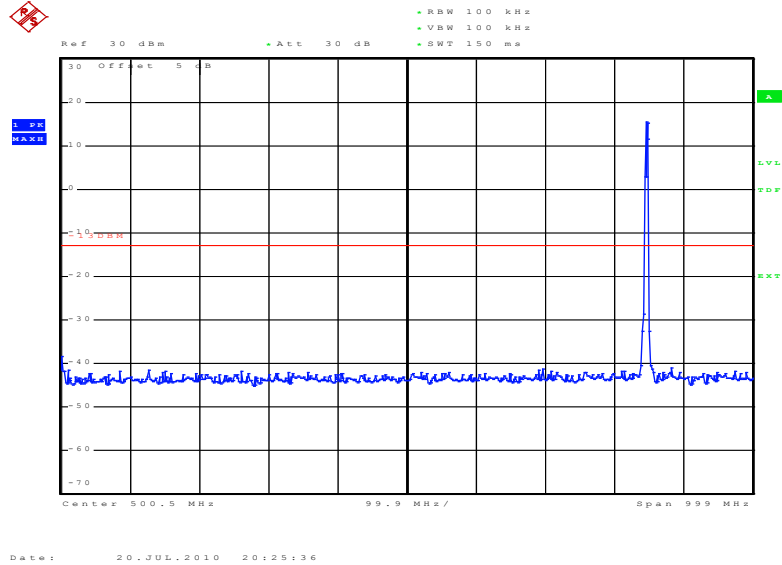

Plot 6.4.44) Out of Band Emissions at Antenna Terminals
WCDMA, High Channel, 846.6 MHz, TX signal +/- 20 MHz

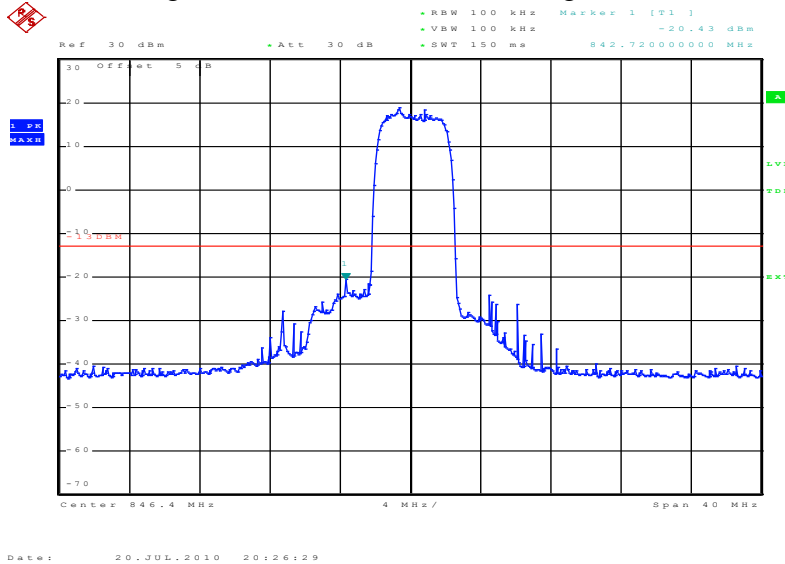

The strong emission shown in each case is the carrier signal.

SIERRA WIRELESS, INC.

Plot 6.445) Out of Band Emissions at Antenna Terminals WCDMA, High Channel, 846.6 MHz, 1 GHz to 20 GHz

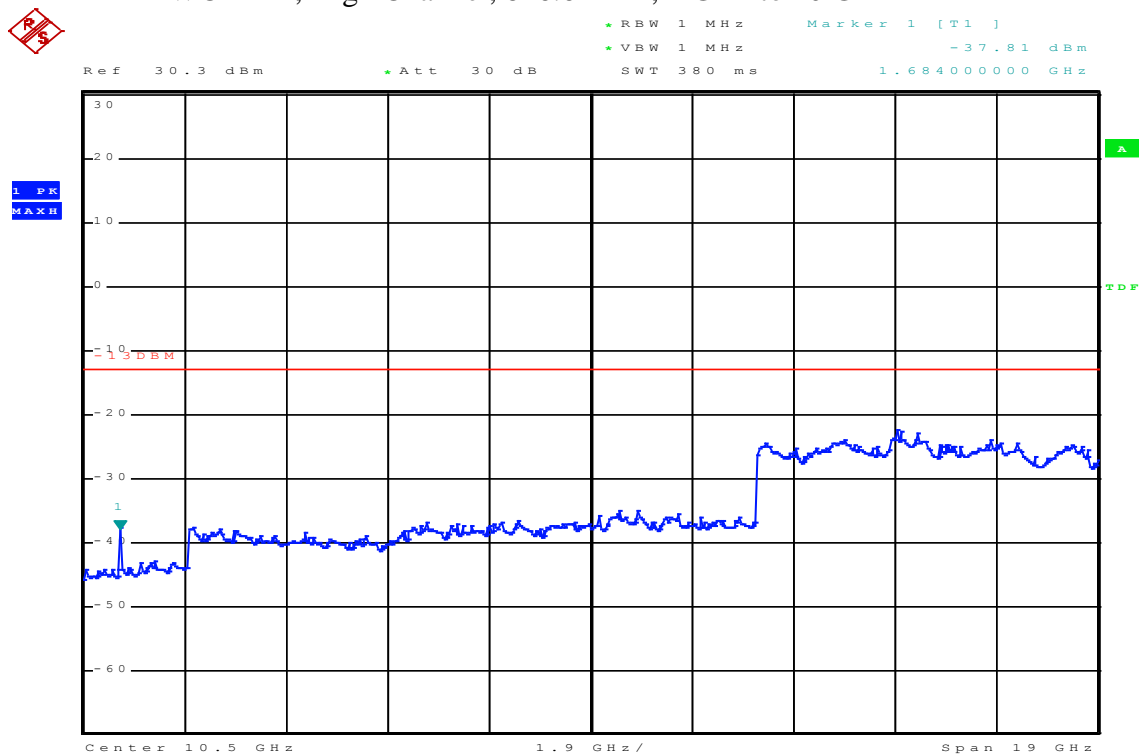

Date: 23.JUL.2010 15:41:09

Cellular Harmonics for Ch. 4233 (846.6 MHz)	Level (dBm)
Second	-37.81 dBm
Third	---
Others	----

Plot 6.4.46) Out of Band Emissions at Antenna Terminals
WCDMA, Low channel, 1852.4 MHz, 1 MHz to 1 GHz

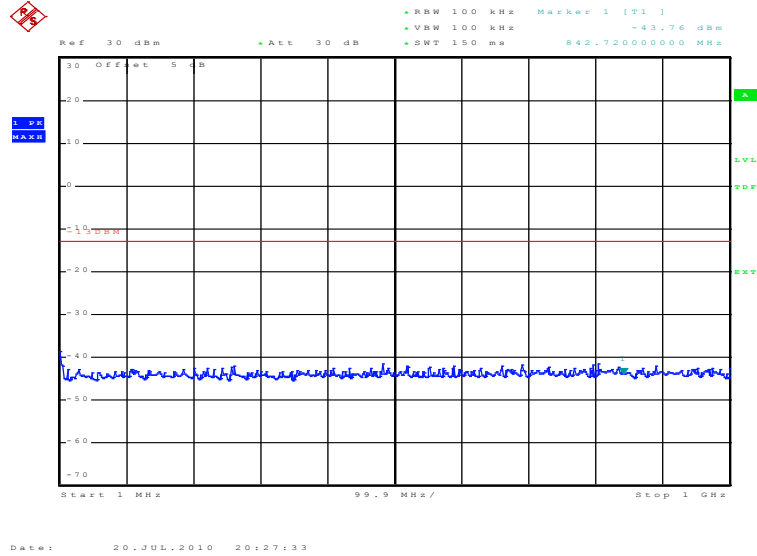

Plot 6.4.47) Out of Band Emissions at Antenna Terminals
WCDMA, Low channel, 1852.4 MHz, TX signal +/- 20 MHz

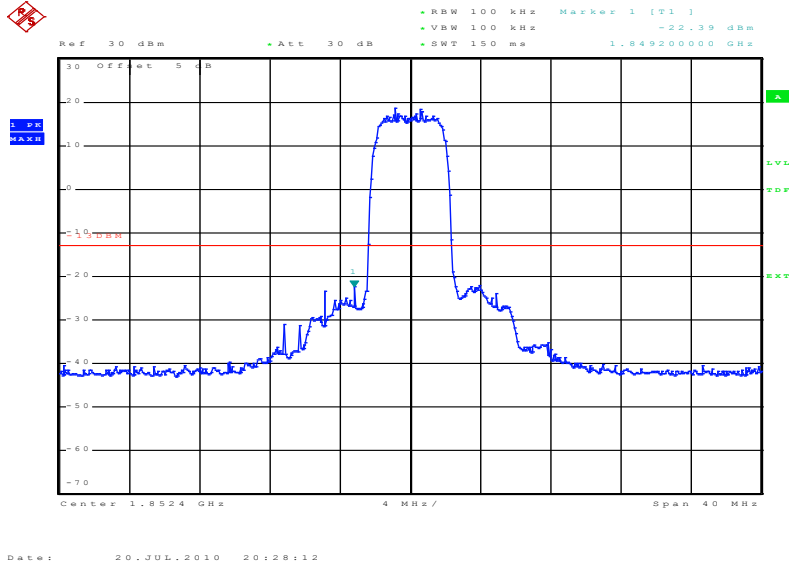

Plot 6.4.48) Out of Band Emissions at Antenna Terminals
WCDMA, Low channel, 1852.4 MHz, 1 GHz to 20 GHz

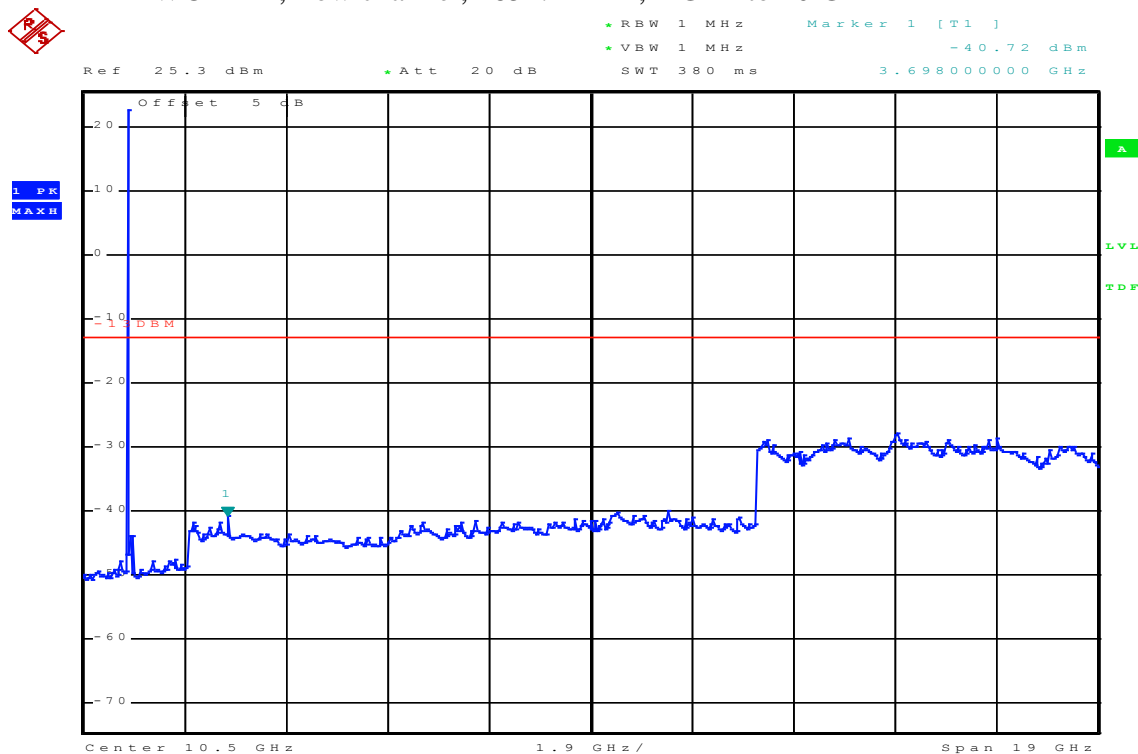

Date: 23.JUL.2010 15:58:10

The strong emission shown is the carrier signal.

PCS Harmonics for Ch. 9262 (1852.4 MHz)	Level (dBm)
Second	- 40.72dBm
Third	----
Others	----

Plot 6.4.49) Out of Band Emissions at Antenna Terminals
WCDMA, Middle channel, 1880 MHz, 1 MHz to 1 GHz

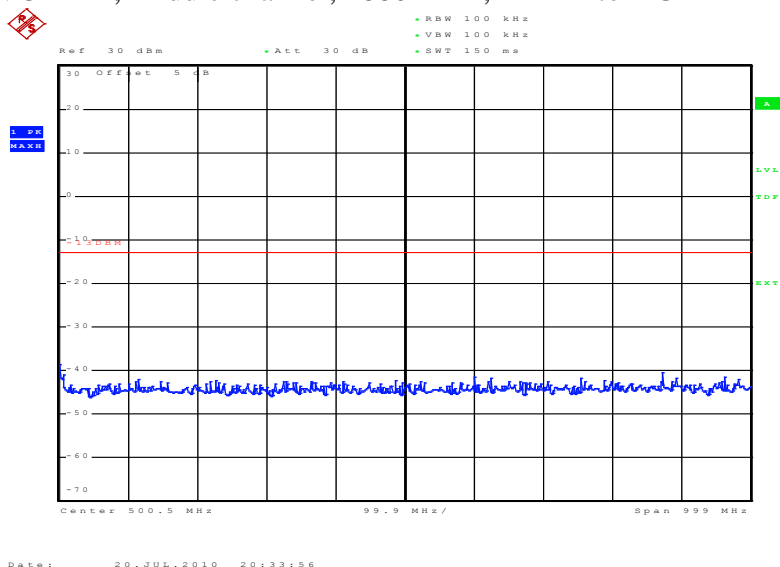

Plot 6.4.50) Out of Band Emissions at Antenna Terminals
WCDMA, Middle channel, 1880 MHz, TX signal +/- 20 MHz

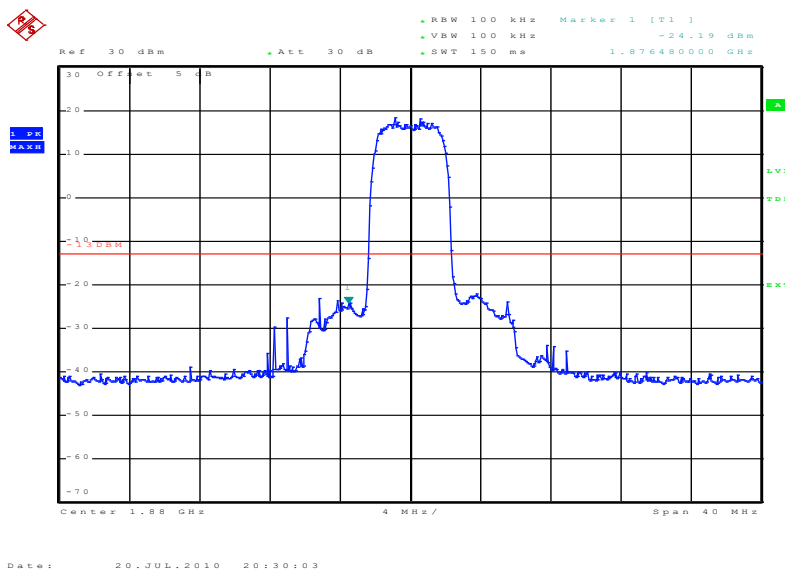

SIERRA WIRELESS, INC.

Plot 6.4.51) Out of Band Emissions at Antenna Terminals WCDMA, Middle channel, 1880 MHz, 1 GHz to 20 GHz

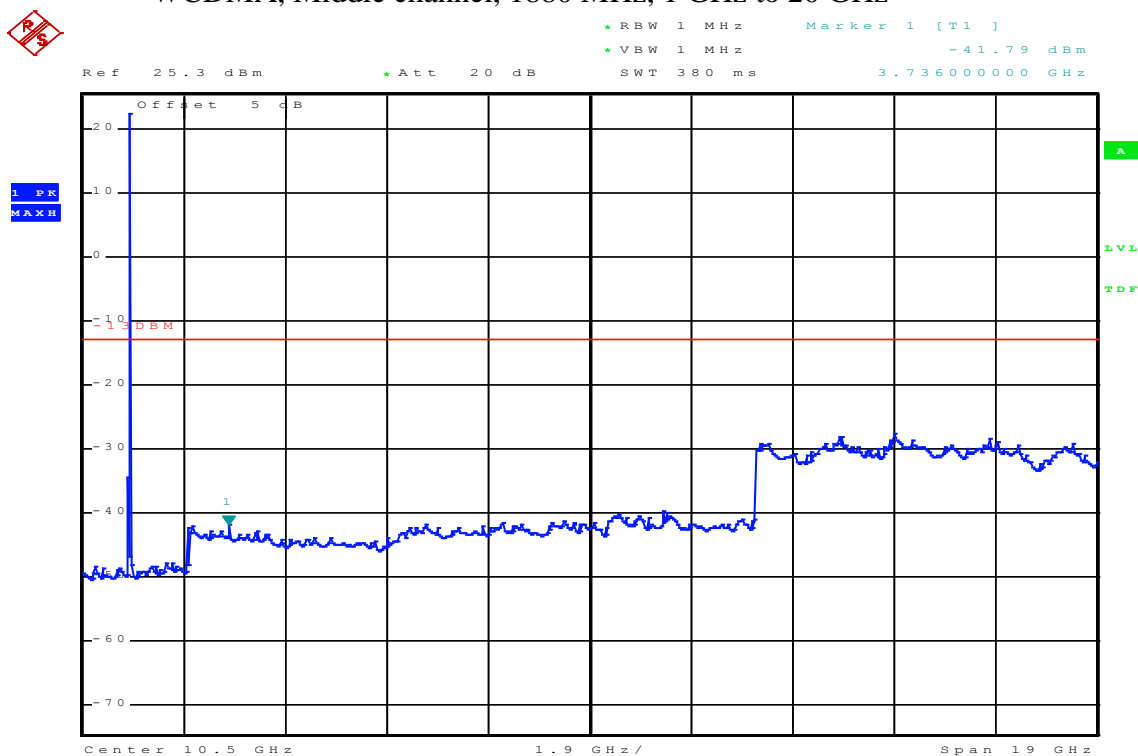

Date: 23.JUL.2010 15:59:03

The strong emission shown is the carrier signal.

PCS Harmonics for Ch. 9400 (1880.0 MHz)	Level (dBm)
Second	-41.79 dBm
Third	----
Others	----

Plot 6.4.52) Out of Band Emissions at Antenna Terminals
WCDMA, High channel, 1907.6 MHz, 1 MHz to 1 GHz

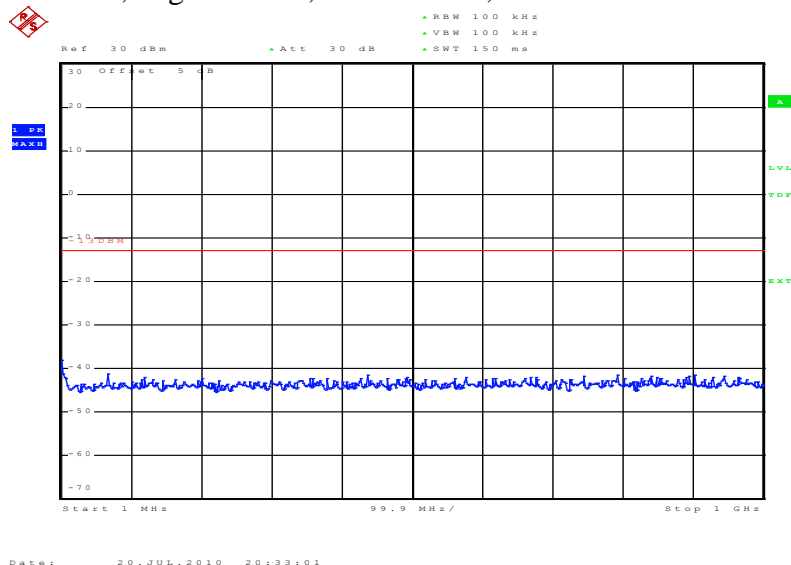

Plot 6.4.53) Out of Band Emissions at Antenna Terminals
WCDMA, High channel, 1907.6 MHz, TX signal +/- 20 MHz

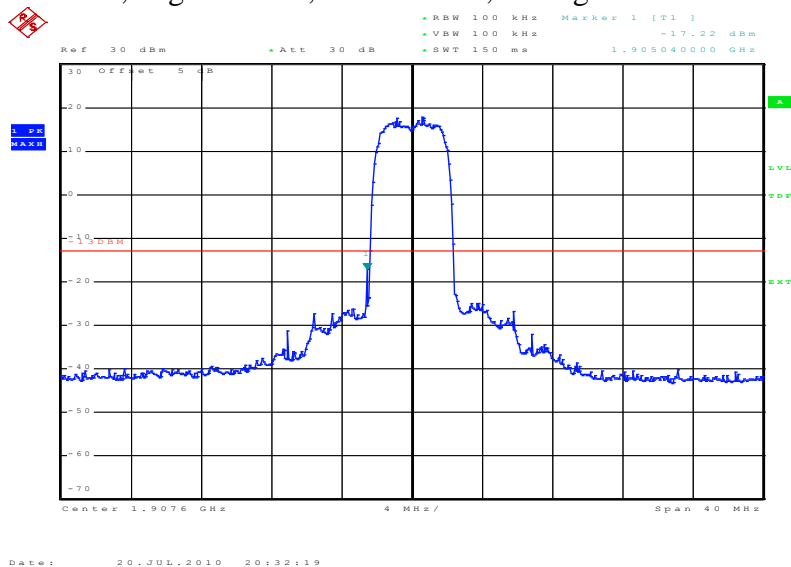

Plot 6.4.54) Out of Band Emissions at Antenna Terminals
WCDMA, High channel, 1907.6 MHz, 1 GHz to 20 GHz

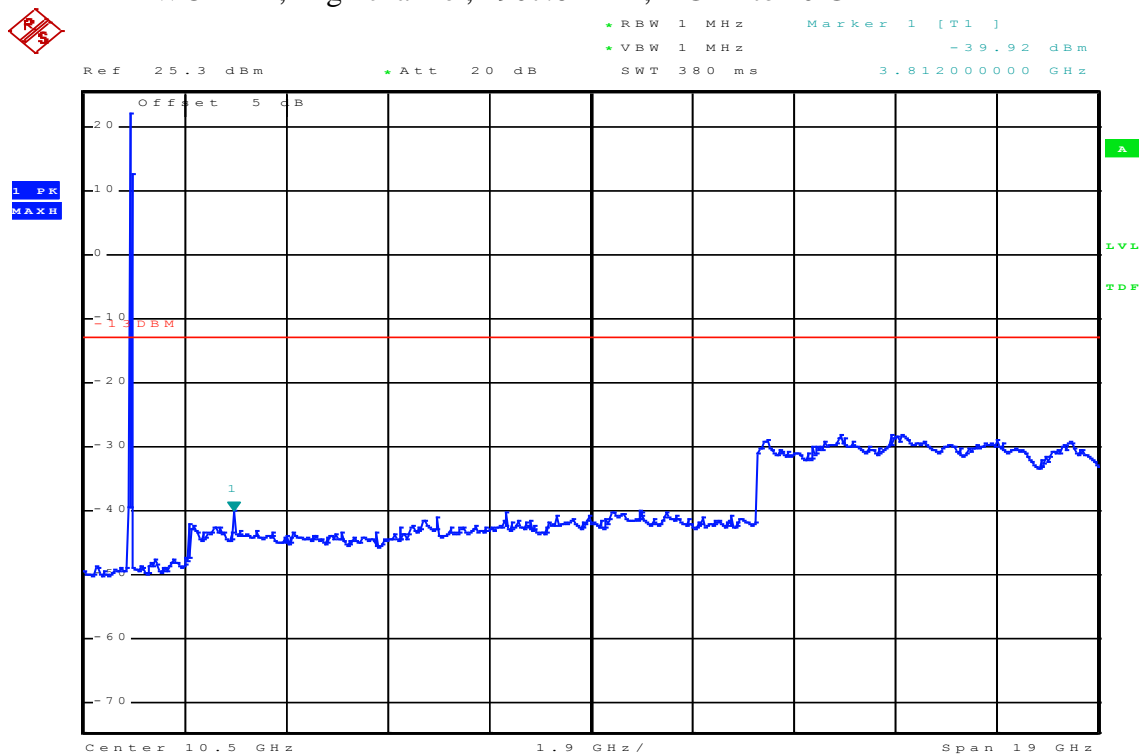

Date: 23.JUL.2010 16:00:17

The strong emission shown is the carrier signal.

PCS Harmonics for Ch. 9538 (1907.6 MHz)	Level (dBm)
Second	-39.92 dBm
Third	----
Others	----

7 Block Edge Compliance

FCC Part 22H/24E

7.1 Test Procedure

The transmitter output was connected to a Rohde & Schwarz CMU200 Test Set, through a coaxial RF cable and a directional coupler, and configured to operate at maximum power. The block edge emissions were measured at the required operating frequencies in each band on the Spectrum Analyzer.

Test Setup

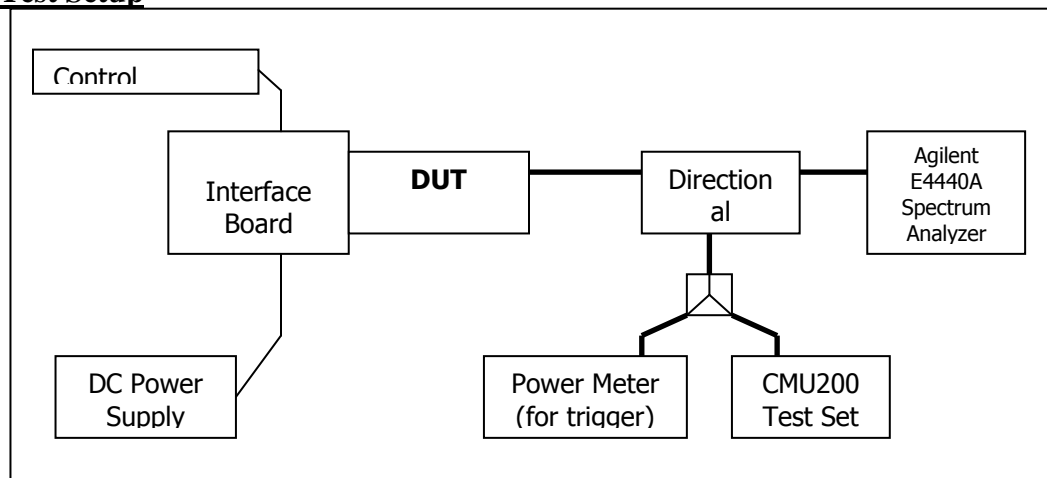

7.2 Test Equipment

EQUIPMENT	MANUFACTURER	MODEL NO.	SERIAL NO.	CAL. DATE
Control Computer	TC	Generic PC	100974	N/A
Wireless Test Set	Rohde & Schwarz	CMU200	107902	November 13, 2009
Spectrum Analyzer	Rohde & Schwarz	FSP	100060	November 24, 2009
DC Power Supply	HP	6632A	3145A	N/A
Interface Board	Shop built	ATEMux	N/A	N/A
Directional Coupler	Pasternack	PE2209-10	N/A	N/A

7.3 Test Results

Block Test	Frequency Boundaries (MHz)	Channels Tested	Corresponding Plots	Result
1	GMSK: Below 824 MHz, above 849 MHz	128, 251	7.4.1, 7.4.2	Complies
2	8PSK: Below 824 MHz, above 849 MHz	128, 251	7.4.3, 7.4.4	Complies
3	GMSK: Below 1850MHz, above 1910MHz	512, 810	7.4.5, 7.4.6	Complies
4	8PSK: Below 1850MHz, above 1910MHz	512, 810	7.4.7, 7.4.8	Complies
Block Test	Frequency Boundaries (MHz)	Channels Tested	Corresponding Plots	Result
1	WCDMA: Below 824MHz, above 849MHz	4132, 4233	7.4.9, 7.4.10	Complies
2	WCDMA: Below 1850MHz, above 1910MHz	9262, 9538	7.4.11, 7.4.12	Complies

7.4 Test Plots

Plot 7.4.1) GSMK; Cellular low channel, below 824 MHz

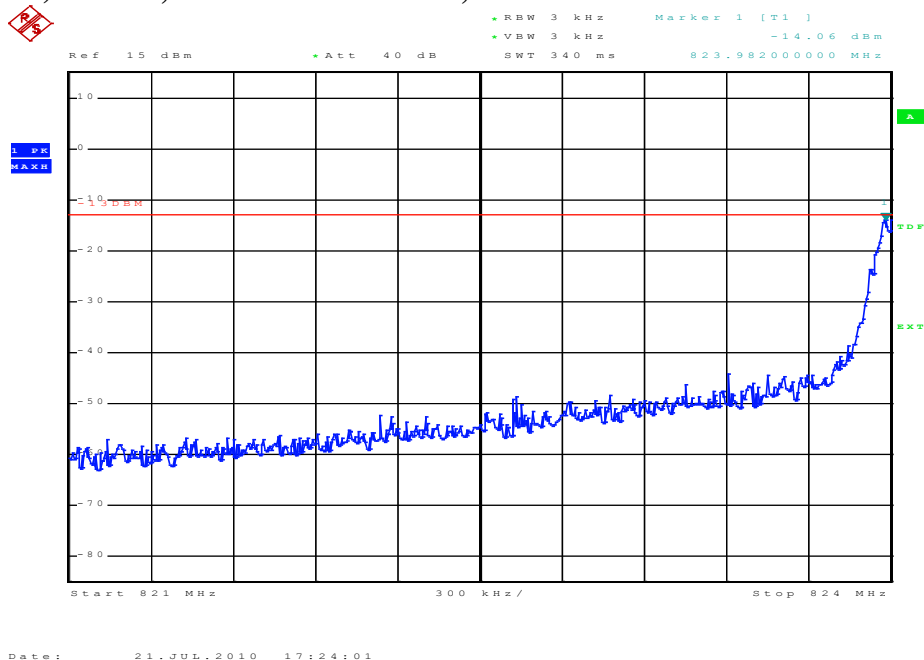

Plot 7.4.2) GSMK; Cellular high channel, above 849 MHz

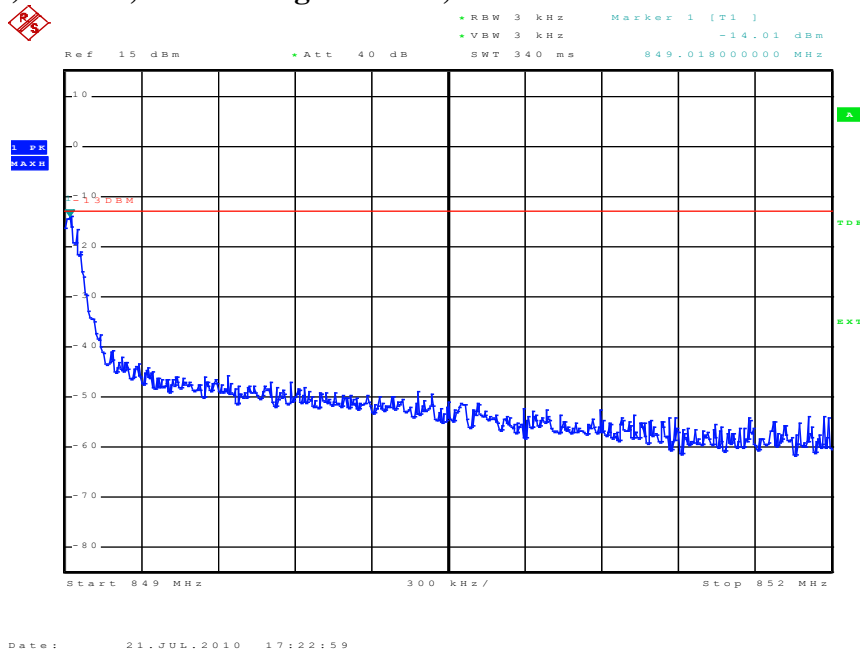

Plot 7.4.3) 8-PSK; Cellular low channel, below 824 MHz

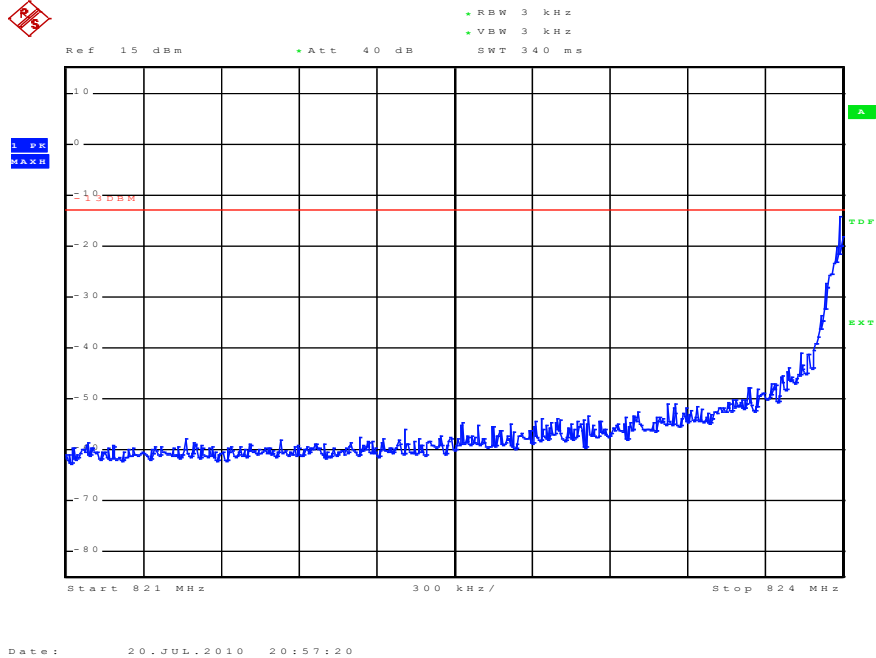

Plot 7.4.4) 8-PSK; Cellular high channel, above 849 MHz

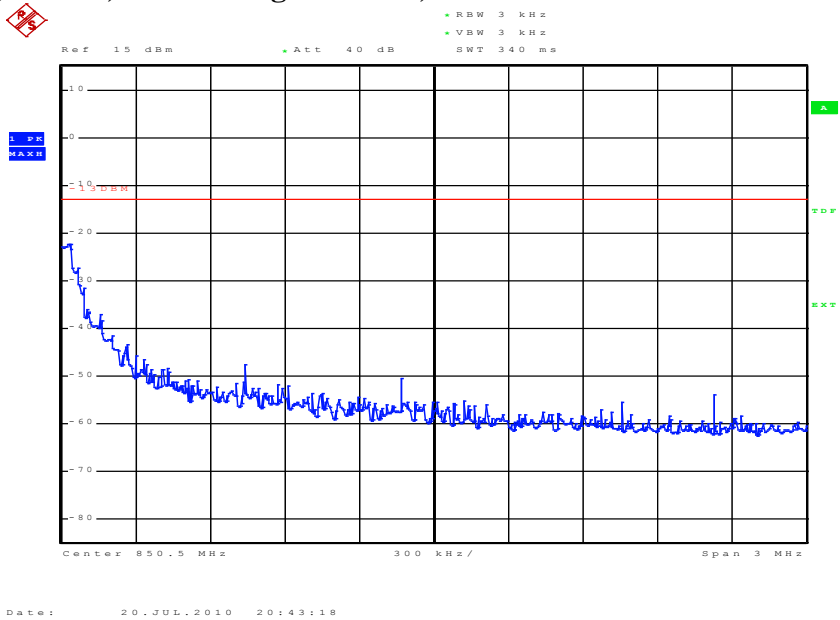

Plot 7.4.5) GMSK; PCS low channel, below 1850 MHz

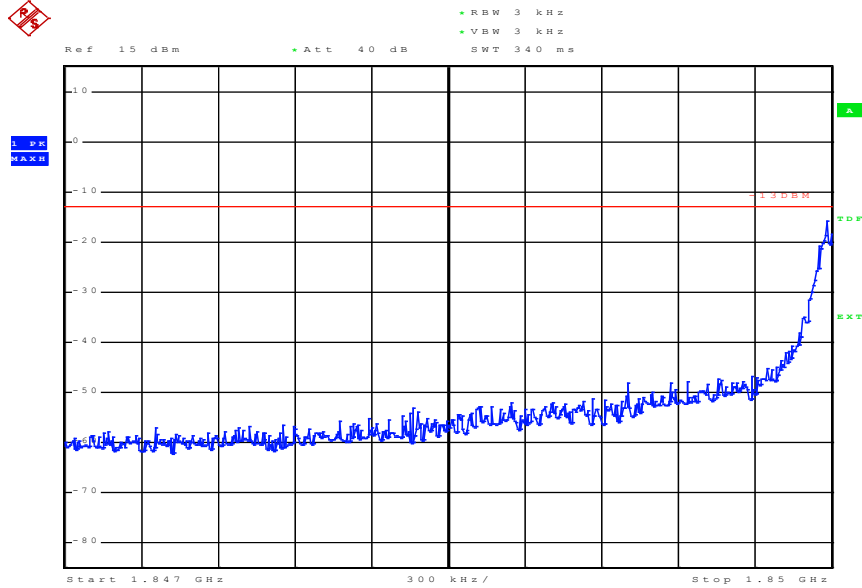

Date: 20.JUL.2010 20:48:24

Plot 7.4.6) GMSK; PCS high channel, above 1910 MHz

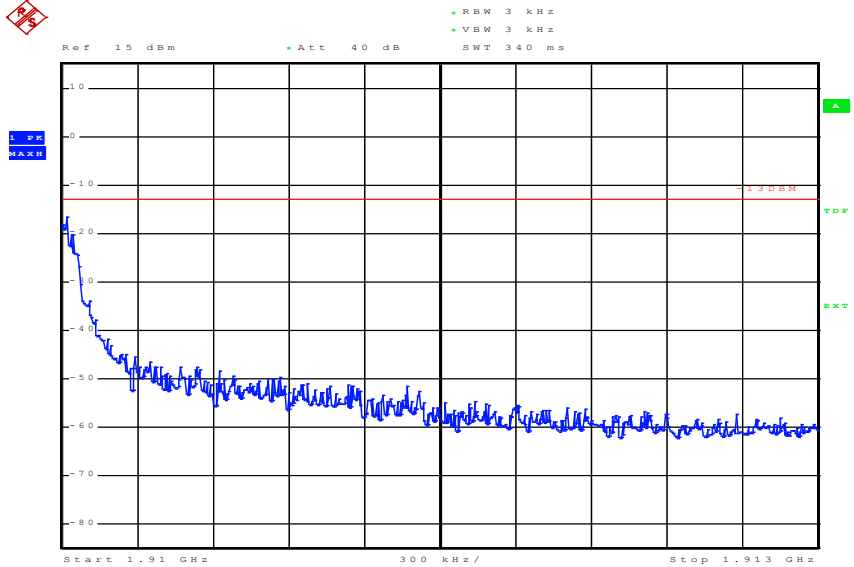

Date: 20.JUL.2010 20:49:12

SIERRA WIRELESS, INC.

Plot 7.4.7) 8-PSK; PCS low channel, below 1850 MHz

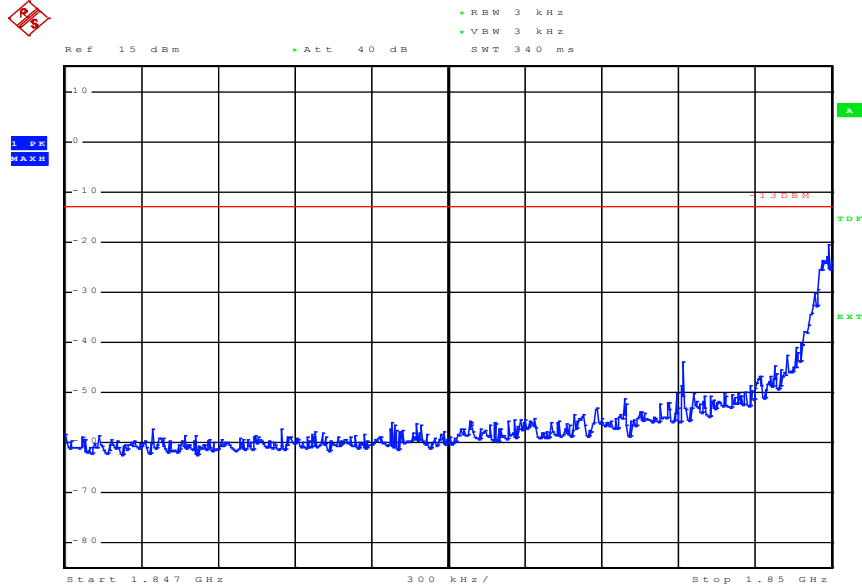

Date: 20.JUL.2010 20:53:09

Plot 7.4.8) 8-PSK; PCS high channel, above 1910 MHz

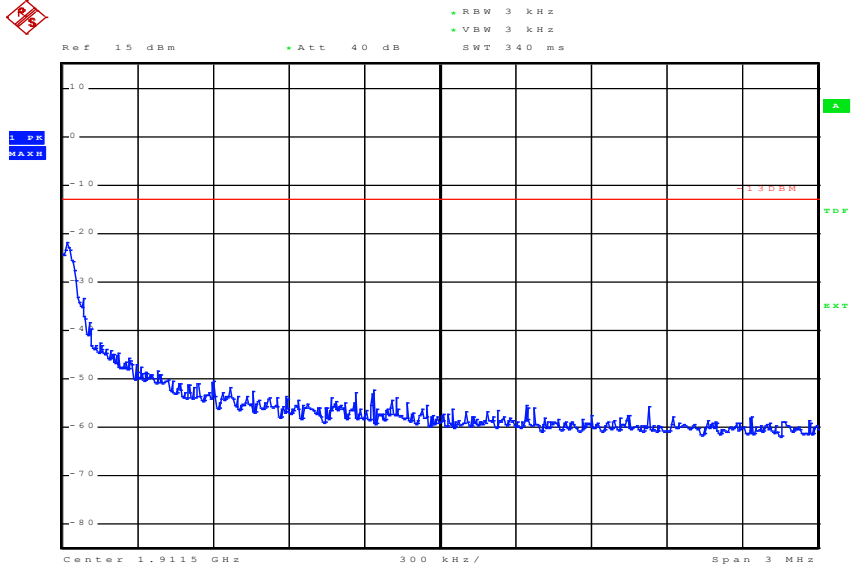

Date: 20.JUL.2010 20:55:12

SIERRA WIRELESS, INC.

Plot 7.4.9) WCDMA; Cellular low channel, below 824 MHz

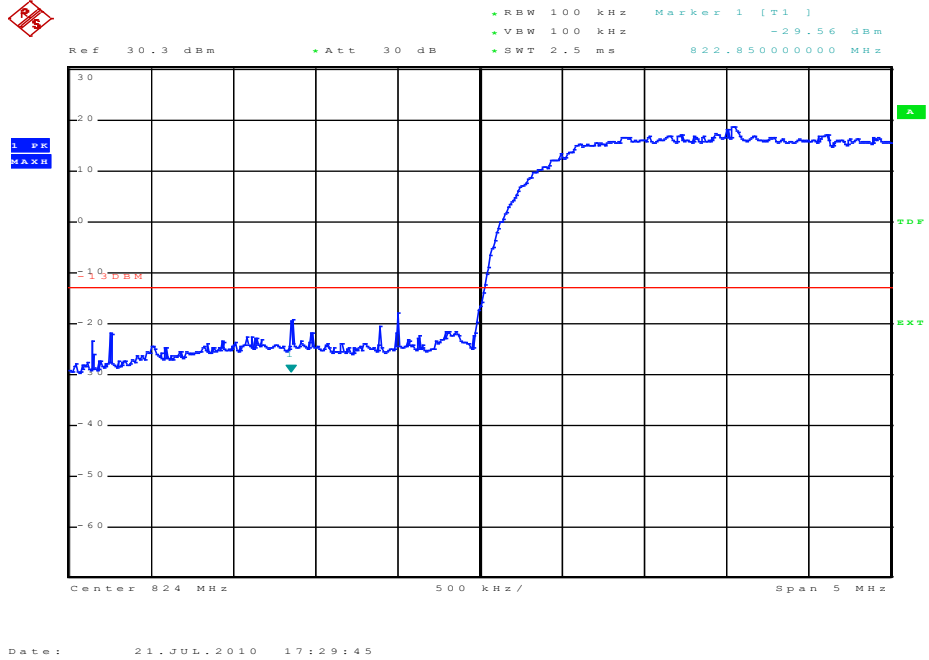

Plot 7.4.10) WCDMA; Cellular high channel, above 849 MHz

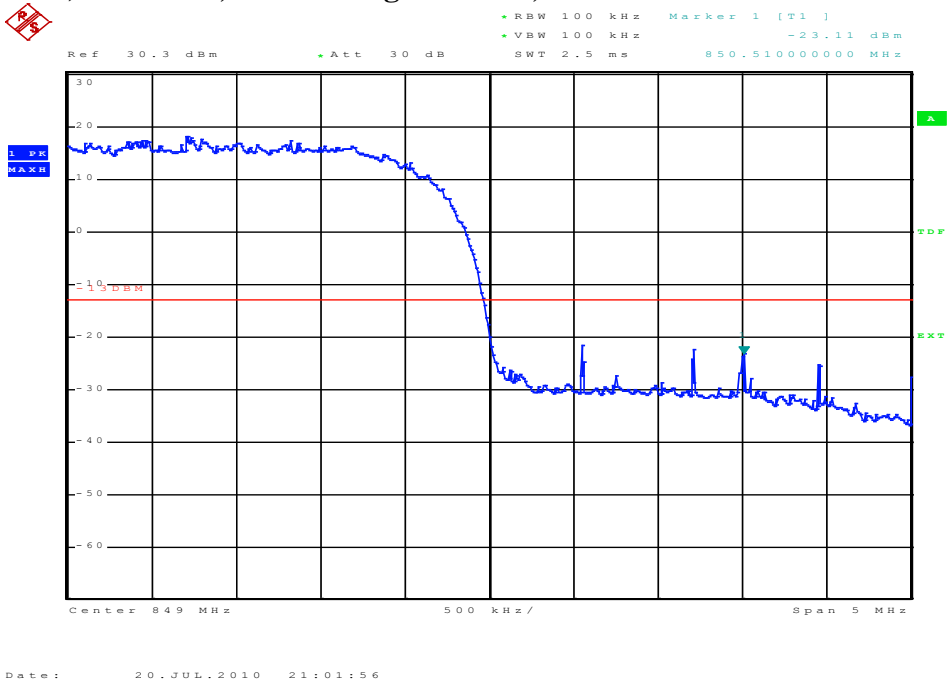

SIERRA WIRELESS, INC.

Plot 7.4.11) WCDMA; PCS low channel, below 1850 MHz

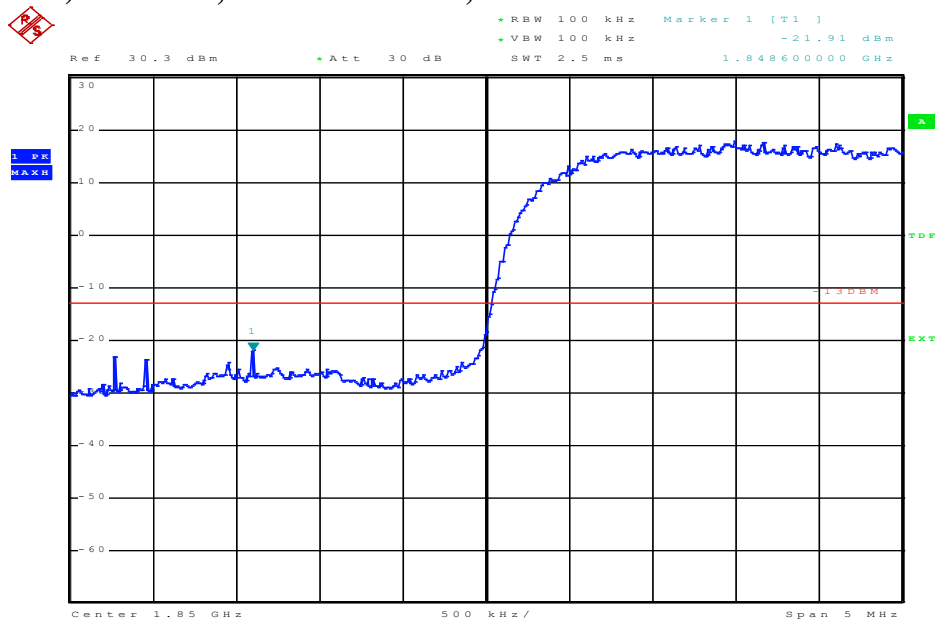

Date: 20.JUL.2010 21:03:54

Plot 7.4.12) WCDMA; PCS high channel, above 1910 MHz

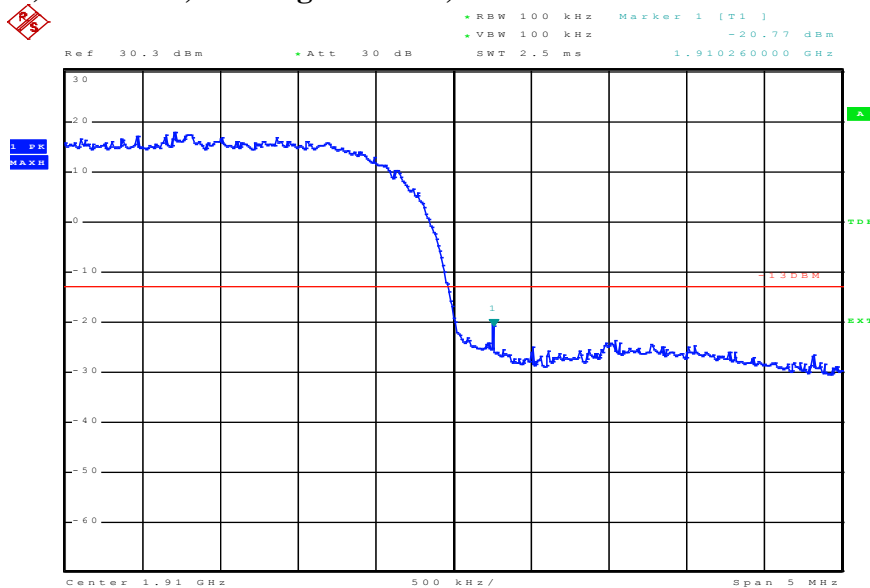

Date: 20.JUL.2010 21:04:49

8 Frequency Stability versus Temperature

FCC 2.1055, FCC 22.355, FCC 24.235

8.1 Summary of Results

The EUT's Frequency Stability versus temperature meets the requirements of less than 2.5ppm when temperature varies from -30°C to +50°C.

8.2 Test Procedure

The EUT was placed inside a temperature chamber. The temperature was set to -30°C and maintained to stabilize. After sufficient soak time, the transmitting frequency error was measured. The temperature was then increased by 10 degrees, maintained to stabilize, and the measurement was repeated. This procedure was repeated until +50°C is reached. Frequency metering included internal averaging of the CMU200 to stabilize the reading. Reference power supply voltage for these tests is 3.6 volts.

Test Setup

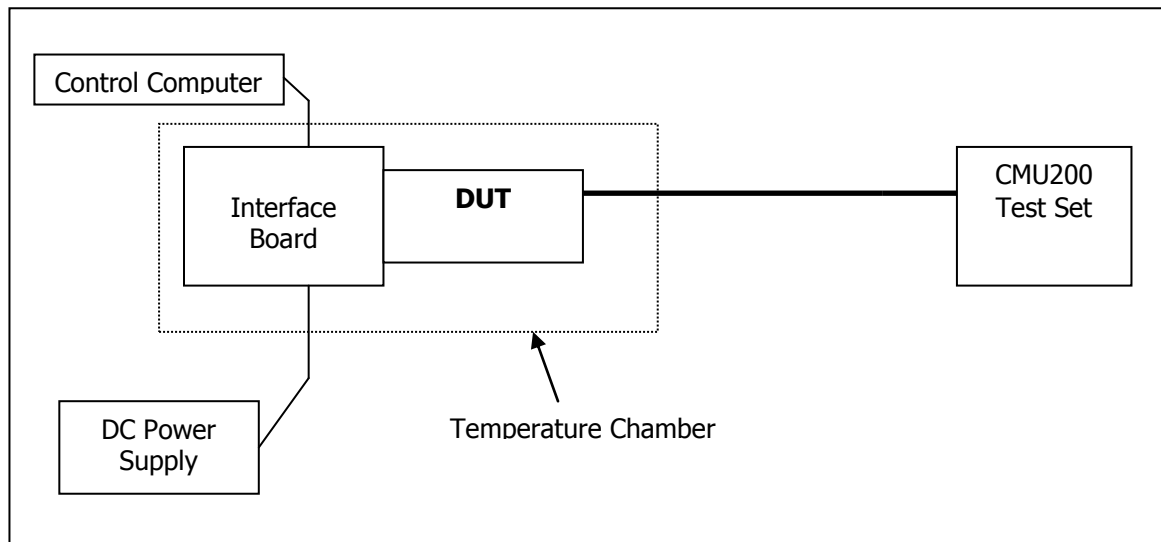

8.3 Test Equipment

EQUIPMENT	MANUFACTURER	MODEL NO.	SERIAL NO.	CAL. DATE
Control Computer	TC	Generic PC	100974	N/A
Wireless Test Set	Rohde & Schwarz	CMU200	107902	November 13, 2009
Spectrum Analyzer	Rohde & Schwarz	FSP	100060	November 24, 2009
DC Power Supply	HP	6632A	3145A	N/A
Interface Board	Shop built	ATEMux	N/A	N/A
Directional Coupler	Pasternack	PE2209-10	N/A	N/A

SIERRA WIRELESS, INC.

8.4 Test Results

8.4.1 GSM Frequency Error over Temperature

Temp (°C)	Cellular Band: 824MHz to 848MHz				PCS Band: 1850MHz to 1910MHz			
	GMSK Mode		8PSK Mode		GMSK Mode		8PSK Mode	
	Offset (Hz)	Offset (ppm)	Offset (Hz)	Offset (ppm)	Offset (Hz)	Offset (ppm)	Offset (Hz)	Offset (ppm)
-30	19.82	0.023691	28.22	0.033732	15.30	0.008138	23.34	0.012415
-20	-8.6	-0.01027	29.15	0.034843	14.08	0.007489	12.87	0.006845
-10	-15.43	-0.01844	4.94	0.005905	-16.34	-0.00869	9.62	0.005117
0	-31.25	-0.03735	-28.02	-0.03349	-28.41	-0.01511	-48.65	-0.02588
10	-23.89	-0.02856	-37.94	-0.04535	-35.26	-0.01876	-41.42	-0.02203
20	-26.41	-0.03157	-47.94	-0.0573	-34.88	-0.01855	-44.49	-0.02366
30	-28.56	-0.03413	-40.52	-0.04843	-33.51	-0.01782	-37.55	-0.01997
40	-29.96	-0.03581	-12.85	-0.01536	-29.44	-0.01566	-36.26	-0.01929
50	-27.64	-0.03304	-36.48	-0.04361	-28.22	-0.01501	-23.47	-0.01248

8.4.2 UMTS Frequency Error over Temperature

Temp (°C)	UMTS Mode			
	850 MHz Band		1900 MHz Band	
	Offset (Hz)	Offset (ppm)	Offset (Hz)	Offset (ppm)
-30	-0.9	-0.00108	-1.89	-0.00101
-20	-4.47	-0.00534	-6.9	-0.00367
-10	-3.46	-0.00414	31.56	0.016787
0	-5.59	-0.00668	-5.08	-0.0027
10	-4.76	-0.00569	23.73	0.012622
20	-2.11	-0.00252	-0.38	-0.0002
30	-0.76	-0.00091	0.72	0.000383
40	-1.07	-0.00128	1.79	0.000952
50	-1.95	-0.00233	-5.83	-0.0031

9 Frequency Stability versus Voltage

FCC 2.1055, FCC 22.355, FCC 24.235

9.1 Summary of Results

The EUT is specified to operate with a supply voltage varying between 3.0VDC and 3.6VDC, having a nominal voltage of 3.3 VDC. It meets the frequency stability limit of less than 2.5ppm when supply voltage varies within the specified limits. Operation above or below these voltage limits is prohibited by firmware in order to prevent improper operation.

9.2 Test Procedure

The EUT was connected to a DC Power Supply and a UMTS test set (CMU 200) with frequency error measurement capability. The power supply output was adjusted to the test voltage as measured at the input terminals to the device while transmitting. A voltmeter was used to confirm the terminal voltage. The peak frequency error is recorded (worst case). The test voltages are 3.0 volts to 3.6 volts.

NOTE: Below 3.0V and above 3.6V, the device stops transmitting.

Test Setup

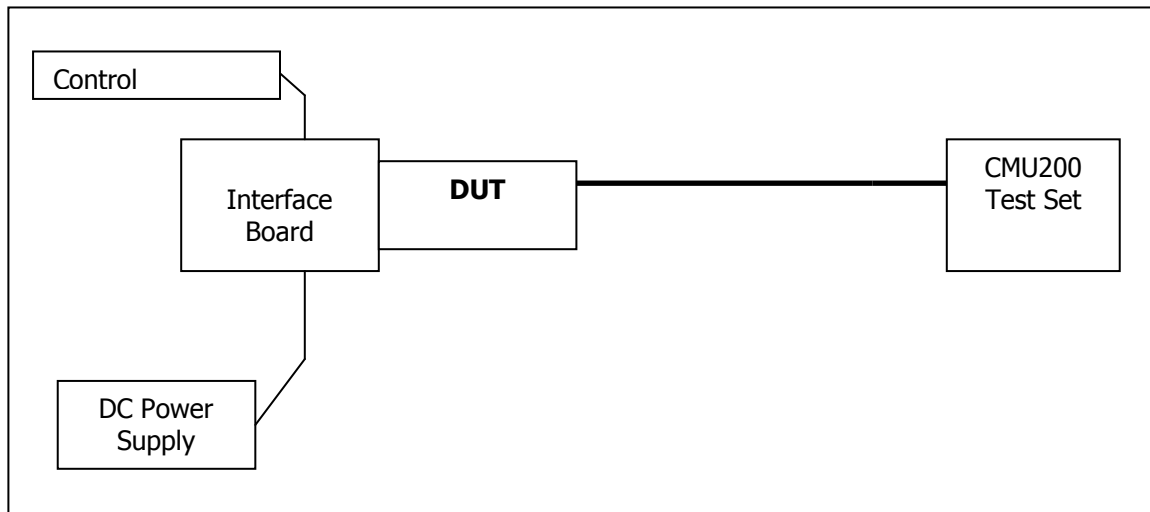

9.3 Test Equipment

EQUIPMENT	MANUFACTURER	MODEL NO.	SERIAL NO.	CAL. DATE
Control Computer	TC	Generic PC	100974	N/A
Wireless Test Set	Rohde & Schwarz	CMU200	107902	November 13, 2009
Spectrum Analyzer	Rohde & Schwarz	FSP	100060	November 24, 2009
DC Power Supply	HP	6632A	3145A	N/A
Interface Board	Shop built	ATEMux	N/A	N/A
Directional Coupler	Pasternack	PE2209-10	N/A	N/A

SIERRA WIRELESS, INC.

9.4 Test Results

9.4.1 GSM Frequency Error over Voltage

Voltage (V)	Cellular Band: 824MHz to 848MHz				PCS Band: 1850MHz to 1910MHz			
	GMSK Mode		8PSK Mode		GMSK Mode		8PSK Mode	
	Offset (Hz)	Offset (ppm)	Offset (Hz)	Offset (ppm)	Offset (Hz)	Offset (ppm)	Offset (Hz)	Offset (ppm)
3.3	-22.28	-0.02663	-29.41	-0.03515	-50.3	-0.02676	-43.46	-0.02312
3.6	-24.15	-0.02887	-34.22	-0.0409	-32.48	-0.01728	-42.81	-0.02277
4.3	-13.56	-0.01621	-37.29	-0.04457	-42.42	-0.02256	-27.25	-0.01449

9.4.2 UMTS Frequency Error over Voltage

Voltage (V)	UMTS Mode			
	850 MHz Band		1900 MHz Band	
	Offset (Hz)	Offset (ppm)	Offset (Hz)	Offset (ppm)
3.3	-6.18	-0.00739	-7.02	-0.00373
3.6	-0.99	-0.00118	-3.25	-0.00173
4.3	-4.58	-0.00547	9.74	0.005181