

Plot 7.4.5) GMSK; PCS low channel, below 1850 MHz

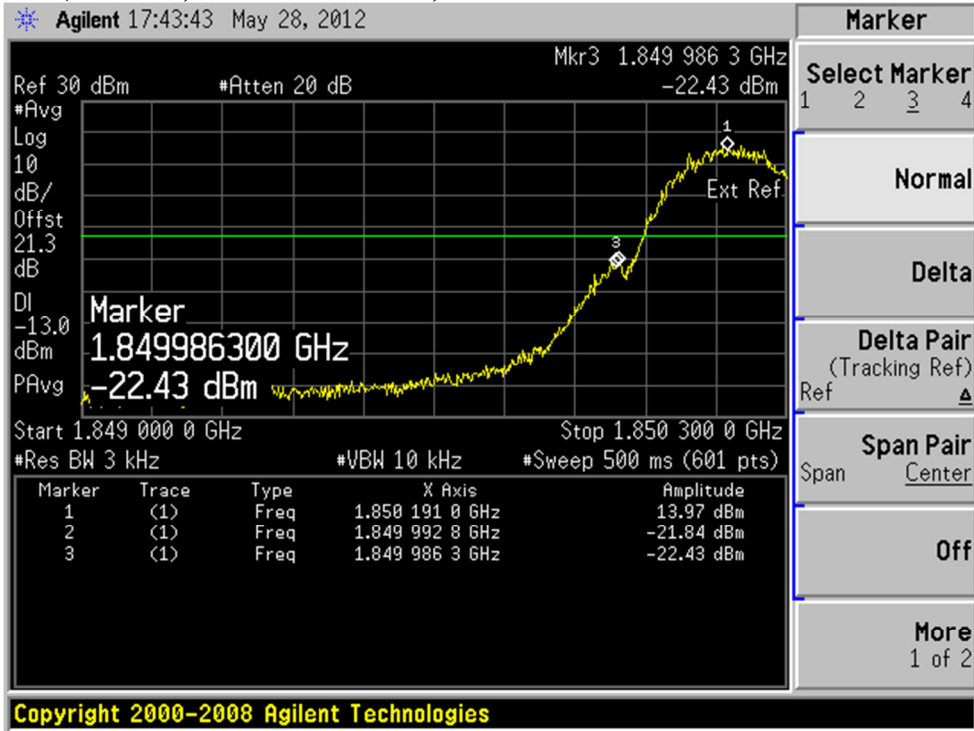

Plot 7.4.6) GMSK; PCS high channel, above 1910 MHz

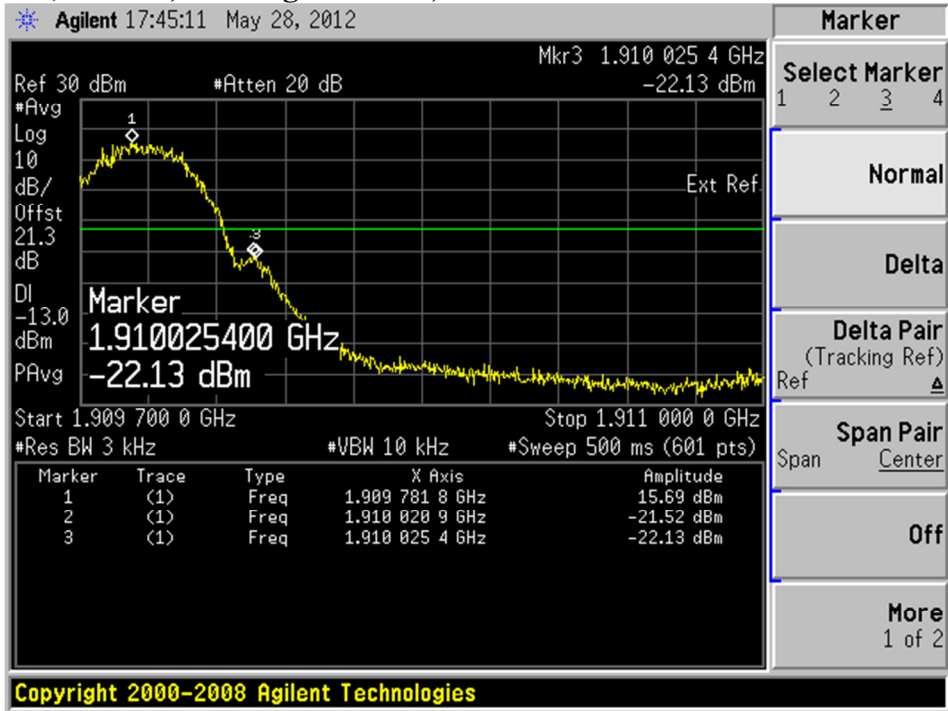

Plot 7.4.7) 8-PSK; PCS low channel, below 1850 MHz

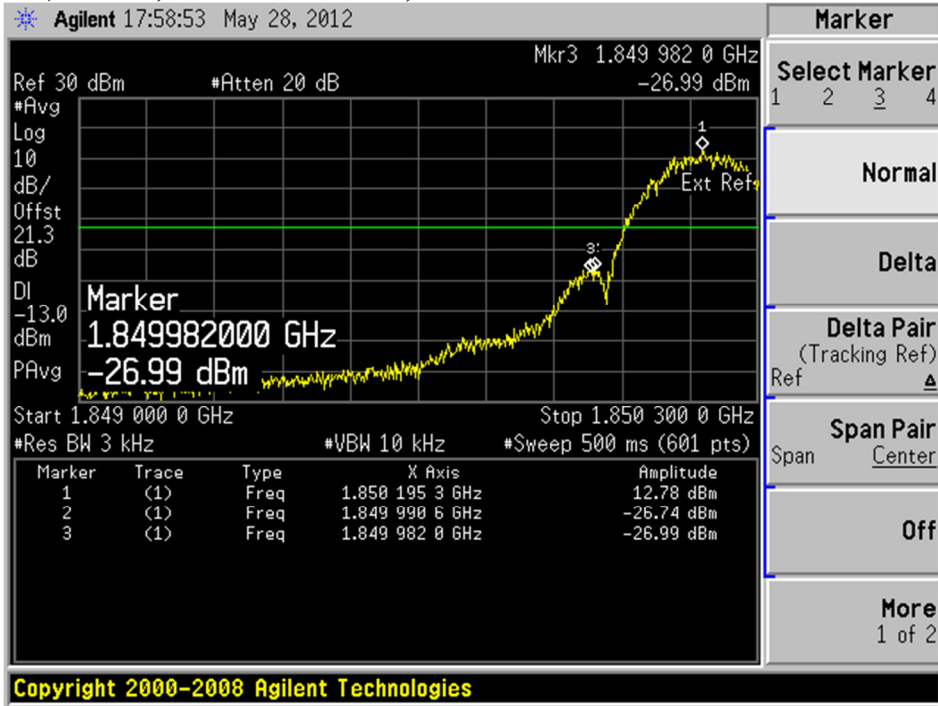

Plot 7.4.8) 8-PSK; PCS high channel, above 1910 MHz

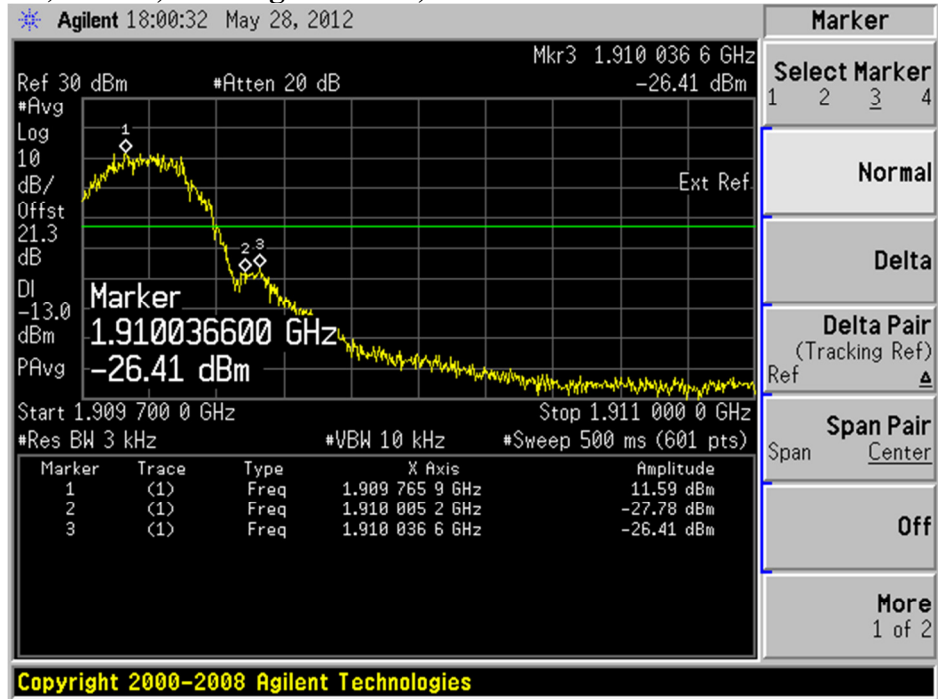

Plot 7.4.9) WCDMA; Cellular low channel, below 824 MHz

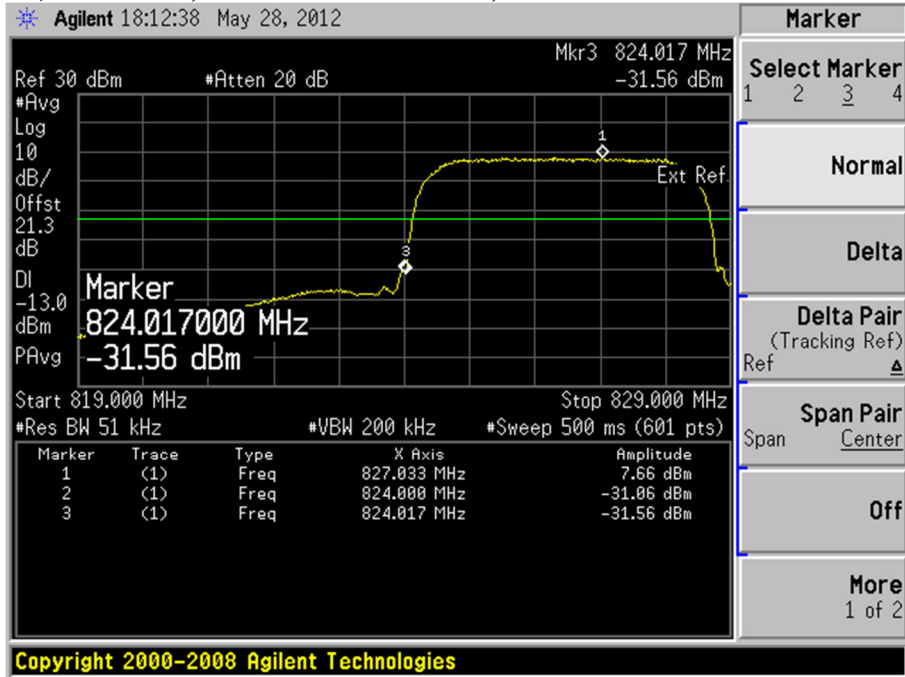

Plot 7.4.10) WCDMA; Cellular high channel, above 849 MHz

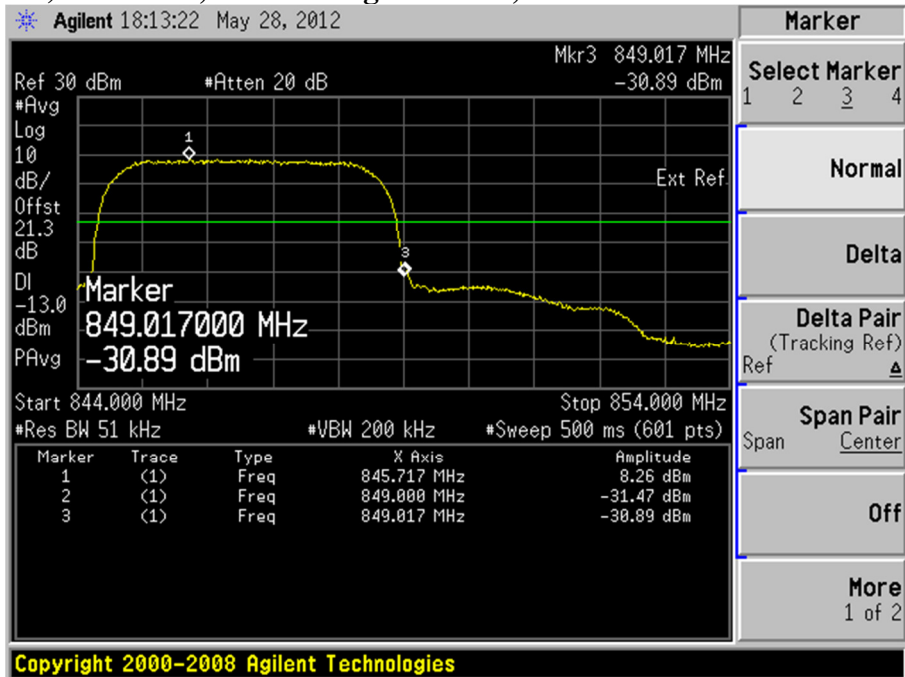

Plot 7.4.11) WCDMA; PCS low channel, below 1850 MHz

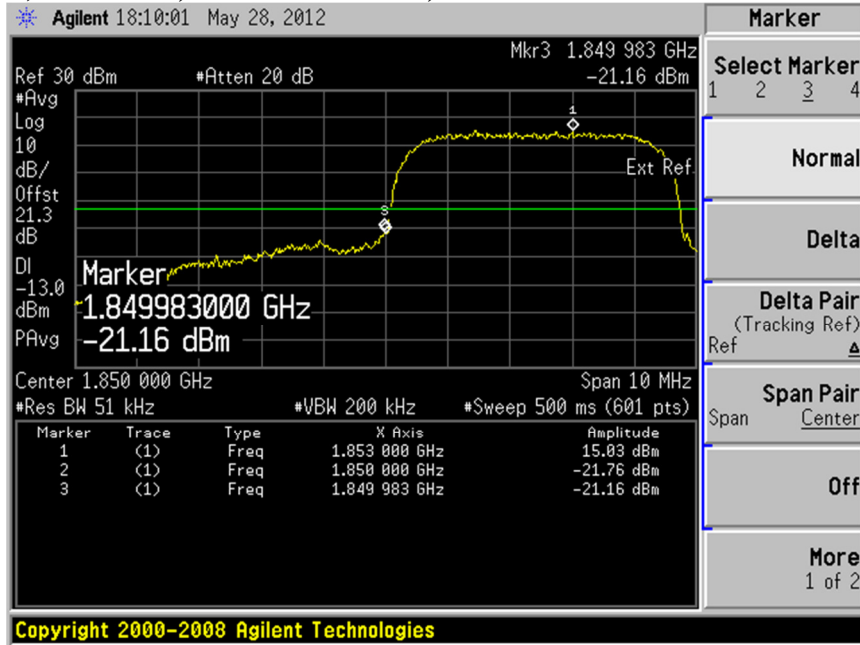

Plot 7.4.12) WCDMA; PCS high channel, above 1910 MHz

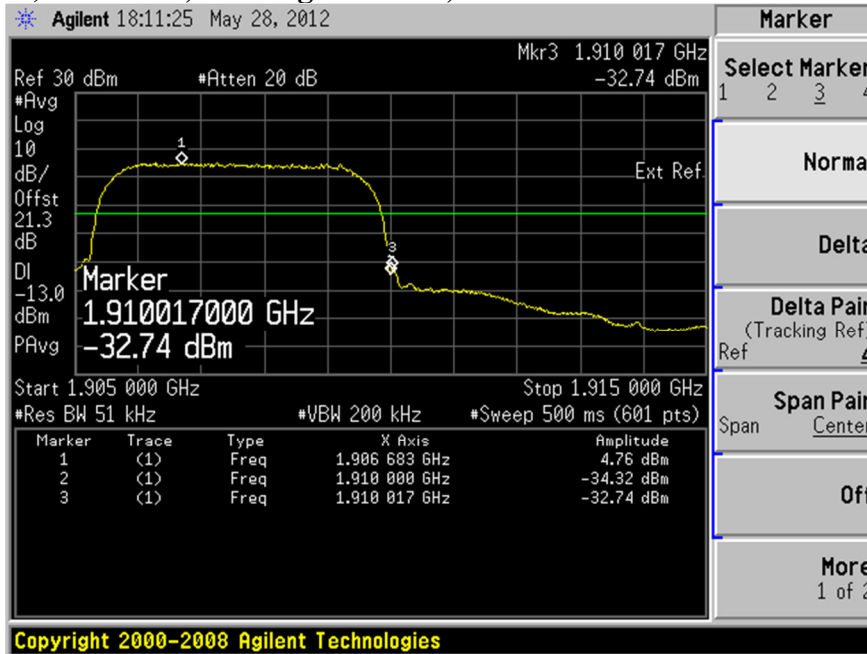

8 Frequency Stability versus Temperature

FCC 2.1055, FCC 22.355, FCC 24.235

8.1 Summary of Results

The EUT's Frequency Stability versus temperature meets the requirements of less than 2.5ppm when temperature varies from -30°C to +70°C.

8.2 Test Procedure

The EUT was placed inside a temperature chamber. The temperature was set to -30°C and maintained to stabilize. After sufficient soak time, the transmitting frequency error was measured. The temperature was then increased by 10 degrees, maintained to stabilize, and the measurement was repeated. This procedure was repeated until +70°C is reached. Frequency metering included internal averaging of the CMU200 to stabilize the reading. Reference power supply voltage for these tests is 3.8 volts.

Test Setup

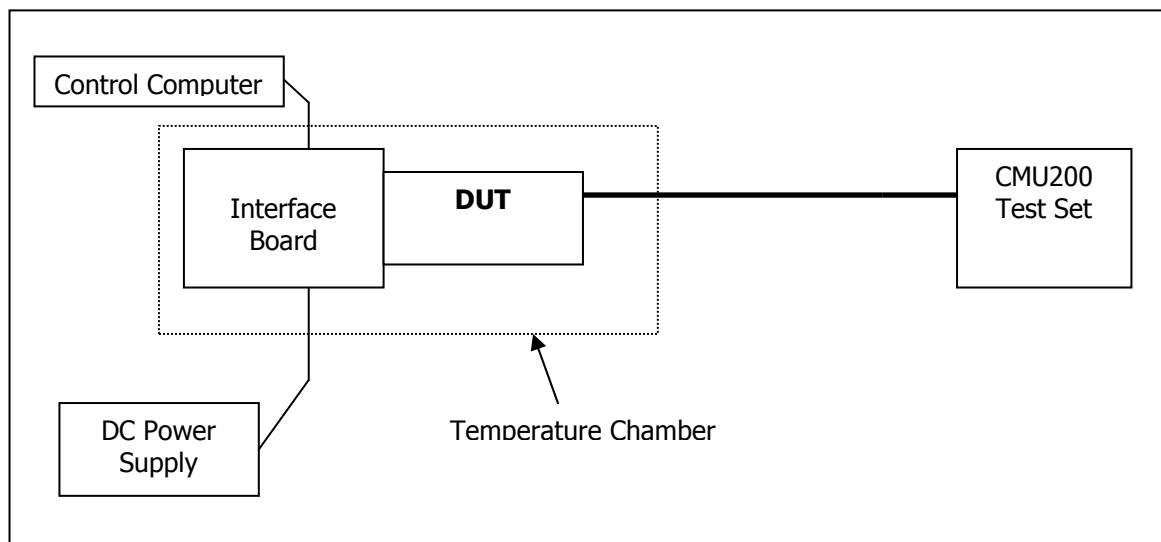

8.3 Test Equipment

EQUIPMENT	MANUFACTURER	MODEL NO.	SERIAL NO.	CAL. DATE
Control Computer	TC	Generic PC	100488	N/A
Wireless Test Set	Rohde & Schwarz	CMU200	117788	November 17, 2011
Spectrum Analyzer	Rohde & Schwarz	FSU	200078	November 15, 2011
DC Power Supply	HP	6632A	3530A	N/A
Interface Board	Shop built	ATEMux	N/A	N/A
Directional Coupler	Pasternack	PE2209-10	N/A	N/A

SIERRA WIRELESS, INC.

8.4 Test Results

8.4.1 GSM Frequency Error over Temperature

Temp (°C)	Cellular Band: 824MHz to 848MHz				PCS Band: 1850MHz to 1910MHz			
	GMSK Mode		8PSK Mode		GMSK Mode		8PSK Mode	
	Offset (Hz)	Offset (ppm)	Offset (Hz)	Offset (ppm)	Offset (Hz)	Offset (ppm)	Offset (Hz)	Offset (ppm)
-30	10.0	-0.0180	-39.91	-0.0363	-16.40	-0.0087	-43.65	-0.0232
-20	9.17	0.0192	16.14	0.0095	-8.27	-0.0044	14.69	0.0078
-10	18.6	0.0149	22.73	-0.0199	-4.78	-0.0025	0.97	0.0005
0	-1.16	-0.0014	38.97	0.0015	-7.17	-0.0038	18.27	0.0097
10	2.97	0.0036	25.18	0.0039	-0.84	-0.0004	21.41	0.0114
20	-21.10	-0.0252	25.01	0.0012	-16.50	-0.0088	-30.45	-0.0162
30	-5.10	-0.0061	37	-0.0223	-20.00	-0.0106	-32.77	-0.0174
40	-26.50	-0.0317	39.58	-0.0177	-39.50	-0.0210	-27.64	-0.0147
50	-29.10	-0.0348	18.27	-0.0480	-57.90	-0.0308	-67.22	-0.0358
60	-22.10	-0.0252	30.58	-0.0107	-32.77	-0.0174	-27.64	-0.0147
70	22.73	-0.0199	38.97	0.0015	-39.50	-0.0210	39.58	-0.0177

8.4.2 UMTS Frequency Error over Temperature

Temp (°C)	UMTS Mode			
	850 MHz Band		1900 MHz Band	
	Offset (Hz)	Offset (ppm)	Offset (Hz)	Offset (ppm)
-30	1.92	0.0023	-2.91	-0.0016
-20	-1.59	-0.0019	3.16	0.0017
-10	2.17	0.0026	2.24	0.0012
0	-1.91	-0.0023	1.08	0.0006
10	1.62	0.0019	2.96	0.0016
20	0.89	0.0011	3.88	0.0021
30	1.11	0.0013	-2.44	-0.0013
40	-0.81	-0.0010	2.9	0.0015
50	-0.76	-0.0009	3.33	0.0018
60	-2.44	-0.0013	2.24	0.0012
70	2.17	0.0026	3.16	0.0017

9 Frequency Stability versus Voltage

FCC 2.1055, FCC 22.355, FCC 24.235

9.1 Summary of Results

The EUT is specified to operate with a supply voltage varying between 3.4VDC and 4.2VDC, having a nominal voltage of 3.8 VDC. It meets the frequency stability limit of less than 2.5ppm when supply voltage varies within the specified limits. Operation above or below these voltage limits is prohibited by firmware in order to prevent improper operation.

9.2 Test Procedure

The EUT was connected to a DC Power Supply and a UMTS test set (CMU 200) with frequency error measurement capability. The power supply output was adjusted to the test voltage as measured at the input terminals to the device while transmitting. A voltmeter was used to confirm the terminal voltage. The peak frequency error is recorded (worst case). The test voltages are 3.4 volts to 4.2 volts.

NOTE: Below 3.4V and above 4.2V, the device stops transmitting.

Test Setup

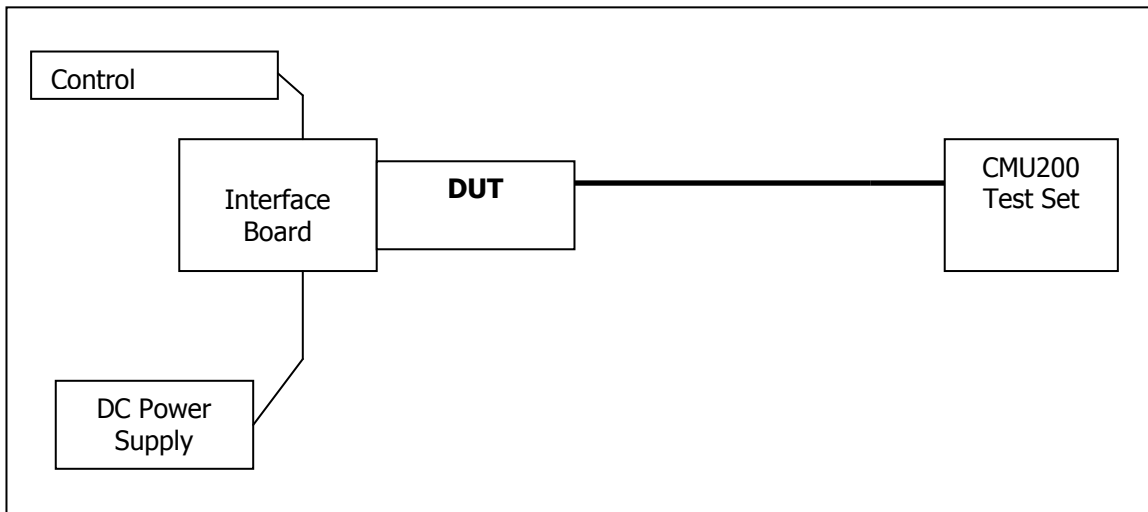

9.3 Test Equipment

EQUIPMENT	MANUFACTURER	MODEL NO.	SERIAL NO.	CAL. DATE
Control Computer	TC	Generic PC	100488	N/A
Wireless Test Set	Rohde & Schwarz	CMU200	117788	November 17, 2011
Spectrum Analyzer	Rohde & Schwarz	FSU	200078	November 15, 2011
DC Power Supply	HP	6632A	3530A	N/A
Interface Board	Shop built	ATEMux	N/A	N/A
Directional Coupler	Pasternack	PE2209-10	N/A	N/A

SIERRA WIRELESS, INC.

9.4 Test Results

9.4.1 GSM Frequency Error over Voltage

Voltage (V)	Cellular Band: 824MHz to 848MHz				PCS Band: 1850MHz to 1910MHz			
	GMSK Mode		8PSK Mode		GMSK Mode		8PSK Mode	
	Offset (Hz)	Offset (ppm)	Offset (Hz)	Offset (ppm)	Offset (Hz)	Offset (ppm)	Offset (Hz)	Offset (ppm)
3.4	-193.00	-0.2307	-153.29	-0.1832	-60.15	-0.0320	-69.94	-0.0372
3.8	-30.06	-0.0359	-28.31	-0.0338	-37.20	-0.0198	-27.30	-0.0145
4.2	20.88	0.0250	-22.69	-0.0271	-30.10	-0.0160	-37.86	-0.0201

9.4.2 UMTS Frequency Error over Voltage

Voltage (V)	UMTS Mode			
	850 MHz Band		1900 MHz Band	
	Offset (Hz)	Offset (ppm)	Offset (Hz)	Offset (ppm)
3.4	1.23	0.0015	-20.95	-0.0111
3.8	-0.69	-0.0008	4.35	0.0023
4.2	2.04	0.0024	2.75	0.0015