

**APPLICATION FOR
TYPE ACCEPTANCE**

Sierra Wireless Inc.

FCC ID: N7NOEM2

MODEL: SB300

Prepared by:
Sierra Wireless Inc.

#150 - 13575 Commerce Parkway
Richmond, B.C.
V6V 2L1

Dec.7, 1998

Table Of Contents

<i>Table Of Contents</i> _____	2
<i>Letter of Submittal and Compliance</i> _____	3
<i>Applicant Introduction</i> _____	4
SB300 Operational Modes _____	4
<i>Expository Statement 2.983 – Modem Detailed Circuit Description</i> _____	5
SB300 Modem Logic General Description _____	5
Description of Terminology _____	5
Detail Circuit Description _____	5
MCU _____	6
MEMORY _____	7
DSP _____	7
DRAIN _____	7
Logic Board I/O Description _____	8
Electrical Specifications – Logic Board _____	9
SB300 Radio General Description _____	10
SB320 Radio Electrical Specifications _____	11
SB300 Radio Block Diagram _____	13
<i>User Manual Pages With FCC Disclaimers</i> _____	16
<i>Calculation of Necessary Bandwidth for FCC ID: N7NOEM2</i> _____	19
For CDPD 19.2Kbps Transmission (emission type FXW) _____	19
<i>Performance Test Data</i> _____	20
RF Output Power (2.985) _____	20
Modulation Characteristics (2.987) _____	21
Occupied Bandwidth (2.989) _____	22
Spurious Emissions at Antenna Terminals (2.991) _____	25
Field Intensity Measurements of Spurious Radiation (2.993) _____	29
Operation Stability Performance (2.995) _____	30
<i>Test Equipment List</i> _____	33
<i>FCC Sample Label</i> _____	34
Finished Product Label: _____	34
Finished Product Label Location: _____	35
 <i>Owners Manual</i> _____	 <i>Enclosed</i>
<i>Equipment Photographs</i> _____	<i>Enclosed</i>
<i>Schematics</i> _____	<i>Enclosed</i>

Letter of Submittal and Compliance



Dec.7, 1998

Federal Communications Commission
Authorization and Standards Division
7435 Oakland Mills Rd.
Columbia, M.D. 21046

Gentlemen:

Sierra Wireless Incorporated has tested this transmitter in accordance with the requirements contained in the appropriate Commission Regulations. To the best of my knowledge, these tests were performed using measurement procedures consistent with the Industry or Commission standards and demonstrates that the equipment complies with the published standard. We are unable to warrant against unpublished changes in requirements. The applicable rules are listed in the following test report.

Sincerely

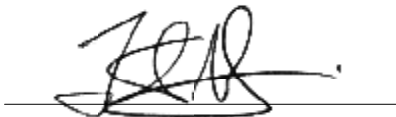

Trent McKeen
RF Engineer

Applicant Introduction

Sierra Wireless, Inc., located in Richmond, B.C., Canada, designs and manufactures wireless data modems for use on Cellular networks. The company was incorporated in May of 1993 around a core engineering staff with special expertise in development of products for use in commercial mobile data systems.

SB300 Operational Modes

CDPD

The modem transmits using CDPD signaling only. The modulation used in this case is GMSK at a single data rate of 19.2kbps. Deviation in this mode is factory adjusted to 4.8kHz peak $\pm 5\%$.

Expository Statement 2.983 – Modem Detailed Circuit Description

The SB300 modem is a wireless modem, which operates on CDPD networks. The product operates as a stand alone modem which may connect to host device (such as a personal computer) through an available serial port.

The SB300 modem consists of 2 different subcircuits which are packaged together in a PCMCIA Type III housing. These circuits are

1. Modem Logic
2. Radio

Each subcircuit is discussed separately in the subsequent sections.

SB300 Modem Logic General Description

Description of Terminology

CDPD	cellular digital packet data
DSP	digital signal processor
EEPROM	electrically erasable programmable read-only memory
MCU	micro controller unit

Detail Circuit Description

The logic board can be divided into various subsystems: MCU, DSP, and Memory. Figure 2-1 shows a block diagram of system.

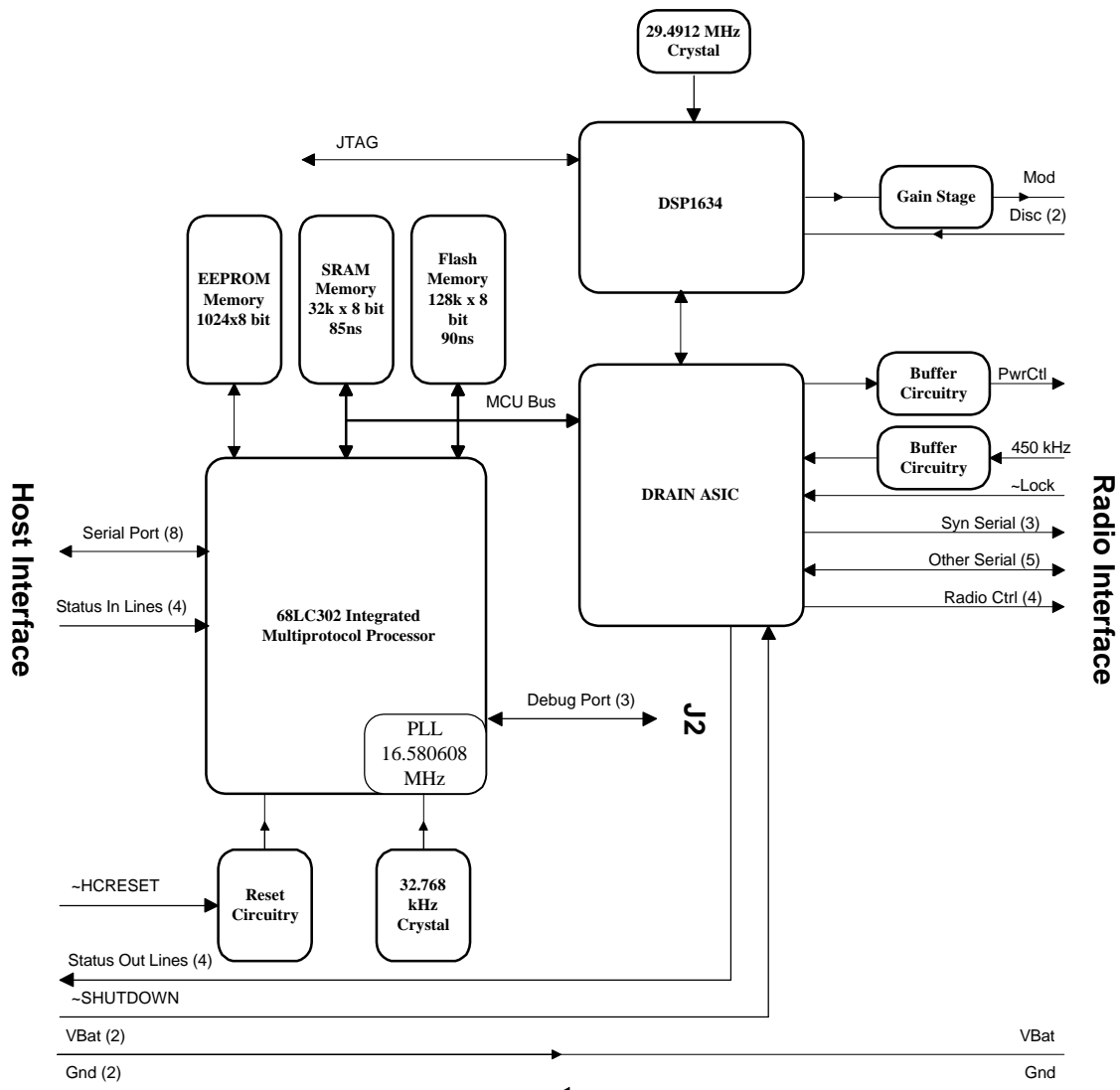

Figure 2-1: Logic Board Block Diagram

MCU

The MCU subsystem is responsible for the communicating with the host and running application software. It talks to the DSP through the DRAIN ASIC interface. The subsystem consists of an MC68LC302 CPU, a reset generator, and a 32kHz crystal. The MC68LC302 has an MC68000 core with two independent serial communication controllers (SCC) and various general-purpose parallel port pins. The first serial port is used as a debug port and the second is used for the host interface. The debug port has only the RX, TX and GND lines while the host port has full handshaking with DCD, RX, TX, DTR, DSR, RTS, CTS, RI, and ground. The CPU has a 16-bit bus but the upper eight bits have been disabled to allow the use of 8-bit memory devices. The CPU has 20 address lines and 4 chip select lines that allow it to address up to 4 Mbytes. Address line A0 is used as WEH (Write Enable High) in 8 bit wide data bus mode. The CPU uses two I/O lines to implement an I²C protocol to talk to the EEPROM, one I/O line to reset the

DSP, and 4 I/O lines to read the 4 status in signals. One interrupt is wired to the host RX line to facilitate waking up from sleep mode when a character is received and the another interrupt is wired to the DRAIN to implement handshaking with the DSP.

The MCU clock is generated by an internal PLL, which multiplies the input 32.768kHz crystal frequency 715 times to 16.580608MHz. The reset generator is used to insure the reset pulse is 2.3s (min) when the modem is powered on. This is done in order to insure the MCU PLL has had enough time to lock. The reset generator also monitors the power for a brown out condition. If the input voltage falls below threshold of 4.3V the reset generator will pull reset low until the voltage rises above 4.5V and 2.3s (min) passes.

MEMORY

The MCU is connection to three banks of memory: RAM, FLASH, and EEPROM. The RAM and the FLASH memory are connected directly to the MCU's bus while the EEPROM is connected with a serial interface.

The RAM is used to store program data variables. It consists of a 128k x 8-bit device. The device is rated up to 85ns which is sufficient for the MCU to operate at zero wait states and clocked up to 21.4MHz.

The FLASH memory allows for field reprogramming (upgrade) of system software. It is used to store the program code and constants. It is made up of one 512k x 8-bit device. The device is rated up to 90ns which is sufficient for the MCU to operate at zero wait states and clocked up to 20.5MHz.

The EEPROM is used as non-volatile storage, which the MCU communicates to through two serial wires (data and clock) with the I²C protocol at approximately 100kHz. Its size is 1024 x 8-bit.

DSP

The DSP subsystem is responsible for performing all of the DSP functions. It consists of an AT&T DSP1634 DSP, the FPGA, and two buffers.

The DSP1634 has a DSP16A core with built in address decoding, wait states generator, baseband codec and JTAG port. The built in address decoding and wait states generator within the DSP 1634 simplifies memory interfacing. The baseband codec consists of a 16-bit sigma-delta analog-to-digital converter as well as a sigma-delta digital-to-analog converter. The sigma-delta converters provide variable amount of resolution depending on the converter clock rate. The gain stage is there to amplify the modulation signal going to the radio.

DRAIN

The interface DRAIN (Dsp Radio Interface) ASIC is responsible for providing an interface between the MCU, and the DSP. Internally, the ASIC contains 8 mailboxes which is the primary mean of communication between the MCU and DSP. It also provides serial ports, general purpose I/O for the radio interface, a PWM output which is used as a DAC, a frequency counter, a codec clock generator and a watch dog timer for the KEY line to the radio.

Currently the DRAIN is implemented with an FPGA until the ASIC is available (expected Q1/99). The FPGA has an external prom, which

initializes the FPGA look-up tables. No baseband modulation signals are affected by changing the FPGA to an ASIC.

Logic Board I/O Description

I/O Line	Interface	Type	Description
~DCD	Host J3-1	Output	Serial port Carrier Detect
RXD	Host J3-2	Output	Serial port receive line
TXD	Host J3-3	Input	Serial port transmit line
~DTR	Host J3-4	Input	Serial port Data Terminal Ready
GND	Host J3-5	Power	Serial port signal ground
~DSR	Host J3-6	Output	Serial port Data Set Ready
~RTS	Host J3-7	Input	Serial port Ready To Send
~CTS	Host J3-8	Output	Serial port Clear To Send
~RI	Host J3-9	Output	Serial port Ring Indicator
~HCRESET	Host J3-10	Input	Modem Reset Line
~SHUTDOWN	Host J3-12	Input	Modem Shutdown Line
~STATUS_OUT1	Host J3-13	Output	Status Output line
~STATUS_OUT2/ KEY	Host J3-14	Output	Status Output line / Key indicator
~STATUS_OUT3	Host J3-15	Output	Status Output line / Okay to shutdown
~STATUS_IN1	Host J3-16	Input	General Purpose Input
~STATUS_IN2	Host J3-17	Input	General Purpose Input
~STATUS_IN3	Host J3-18	Input	General Purpose Input
~STATUS_IN4	Host J3-19	Input	General Purpose Input
VBAT	Host J3-23	Power	Power for the modem
VBAT	Host J3-24	Power	Power for the modem
GND	Host J3-25	Power	Ground for the modem
GND	Host J3-26	Power	Ground for the modem
GND	Host J3-27	Power	Ground for the modem
GND	Host J3-28	Power	Ground for the modem
DISC+	Host J3-30	Analog Output	Discriminator output used for calibration at the factory.
Debug RX	Debug J2-1	Output	Debug serial port receive line
Debug TX	Debug J2-2	Input	Debug serial port transmit line
Debug GND	Debug J2-3	Power	Debug serial port ground line
~RAMP	Radio JR4-1	Output	Power ramp control line for radio PA
PWRCTL	Radio JR4-2	Analog Output	Output power control line for PA
+5V	Radio JR4-3	Power	Power for the radio
GND	Radio JR4-4	Power	Ground for the radio
RXON	Radio JR4-5	Output	Receiver enable control line
MOD	Radio JR4-6	Analog Output	Transmitter modulation line
KEY	Radio JR4-7	Output	Transmitter key line
SYNCLK	Radio JR3-2	Output	Synthesizer serial port clock line
SYNDAT	Radio JR3-3	Output	Synthesizer serial port data line
~SYNLE	Radio JR3-4	Output	Synthesizer serial port enable line
~LOCK	Radio JR5-1	Input	Synthesizer lock status
~PREKEY	Radio JR5-2	Output	Transmitter enable control line
A2DOUT	Radio JR5-3	Input	ADC serial port data return line
~A2DEN	Radio JR5-4	Output	ADC serial port enable line
~D2AEN	Radio JR5-5	Output	DAC serial port enable line

I/O Line	Interface	Type	Description
CLK	Radio JR5-6	Output	ADC/DAC serial port clock line
DAT	Radio JR5-7	Output	ADC/DAC serial port data line
DISC -	Radio JR2-1	Analog Input	Negative half of the deferential discriminator output
DISC +	Radio JR2-2	Analog Input	Positive half of the deferential discriminator output
450kHz	Radio JR2-4	Analog Input	450kHz signal for the receiver IF

Electrical Specifications – Logic Board

Parameter	Specification
Power Supply	+5 ± 5% VDC maximum noise DC to 100KHz 10mVpp
Current Drain	20mA sleep (max) 150mA active (max)
Operating Temperature Range	-30 to +85°C
Storage Temperature Range	-40 to +85°C
<u>Host Interface</u>	See reference [3]
Input High Voltage	2.5 V Min
Input Low Voltage	0.8 V Max
Output High Voltage	3.86 V Min
Output Low Voltage	0.4 V Max
<u>Clocks and Access Times</u>	
MCU PLL Input Frequency	32.768 kHz
MCU Frequency	Min: DC Max: 16.67 MHz Operating: 16.580608 +/- 120 ppm
DSP Frequency	29.4912 MHz +/- 50 ppm
RAM Speed	<85 ns
FLASH Speed	<90 ns
<u>Reset</u>	
Threshold	↓ 4.3V +/- 0.125V, ↑ 4.5V +/- 0.125V
Pulse Length	2.35s (min)
<u>Radio Interface</u>	See reference [2]
Input High Voltage	2.0 V Min
Input Low Voltage	0.8 V Max
Output High Voltage	3.86 V Min
Output Low Voltage	0.4 V Max
450kHz	1.0 VDC + 0.4 Vpp (Measured)
Disc	0.5 Vpp +/- 25%
Mod	2.5 VDC +/- 0.7 VAC

SB300 Radio General Description

The TAZ! radio architecture is a cost reduced, bear bones refinement of the AirCard (aka Tomcat) radio architecture (FCC ID LL9ACRD1). This new radio platform shares the same frequency plan and virtually the same level budget as AirCard.

Key features of this narrow band FM transceiver include:

- capable of full duplex operation in the North American 800MHz cellular band (forward 869 – 894MHz; reverse 824 – 849MHz),
- supports CDPD GMSK, V.34 AMPS, voice and wideband control data modulation and demodulation,
- 30kHz channel spacing with mixture of synthesized and crystal based frequency generation,
- 600mW transmit power with six programmable power output steps (28dBm, 24dBm, 20dBm, 16dBm, 12dBm, 8dBm),

We learned a great deal about making PCMCIA cellular radios during the AirCard development and were able to use this knowledge for another kick at the development can. The principal intent behind this design was to lower material and assembly cost and improve defect rates for high volume production. To achieve the lowest possible parts cost, we eliminated all custom components and selected only high volume stable parts that were well down on their cost curves. We also placed a restriction on the power supply requirements that eliminated four voltage regulators from the original AirCard DataPhone design.

So with this basic introduction, here we go. The following sections provide sufficient detail to understand this simple radio's architecture and operation.

SB320 Radio Electrical Specifications

The TAZ! radio meets or exceeds all specification requirements of CDPD 1.1, RSS-128, and FCC Parts 15 & 22.

Table 1. Transceiver Specifications at standard temperature and pressure.

Supply Requirements	5V \pm 5% 10mVpp ripple DC to 100kHz
Current Consumption	Sleep: 1mA Receive: 45mA Transmit: 700mA
Transmit Frequency	824 to 849MHz
Receive Frequency	869 to 894MHz
Channel Spacing & Number of Channels	30kHz, 833 channels
Modes	Sleep, Receive (Standby), Full duplex transmit
Modulation	Direct FM, \pm 14kHz maximum
Modulation Frequency Response	Flat 10Hz to 10kHz (\pm 1dB)
Performance Bandwidth	25MHz
Temperature Compensated Reference Frequency & Stability	14.85MHz \pm 2.5ppm
Local Oscillator Frequency	926MHz \pm 12.5MHz
TX Output Power (Conducted)	28dBm to 8dBm in six programmable steps of 4dB
TX Spurious Outputs	Per FCC Part 22
TX ramp up/down	Per CDPD 1.1
TX Modulated LO	30MHz crystal oscillator, tripled to yield 90MHz
RX Sensitivity (Conducted)	-108dBm (CDPD 5% BLER) -116dBm (AMPS 12dB SINAD C-Message weighted, 750 μ s de-emphasis)
Receiver Intermediate Frequencies	1 ST IF 45MHz 2 ND IF 450kHz
Demodulation Frequency Response	Flat 10Hz to 10kHz (\pm 1dB)
RX Adjacent Channel Selectivity	16dB at \pm 30kHz 60dB at \pm 60kHz
RX Intermodulation Response Rejection	57dB (per CDPD 1.1) 65dB (per EIA 19-B)
RX Scan Time	60ms max band edge to band edge
RX Spurious Emissions	Per FCC Part 22
RX Unintended Emissions	Per FCC Part 15

SB300 Radio Block Diagram

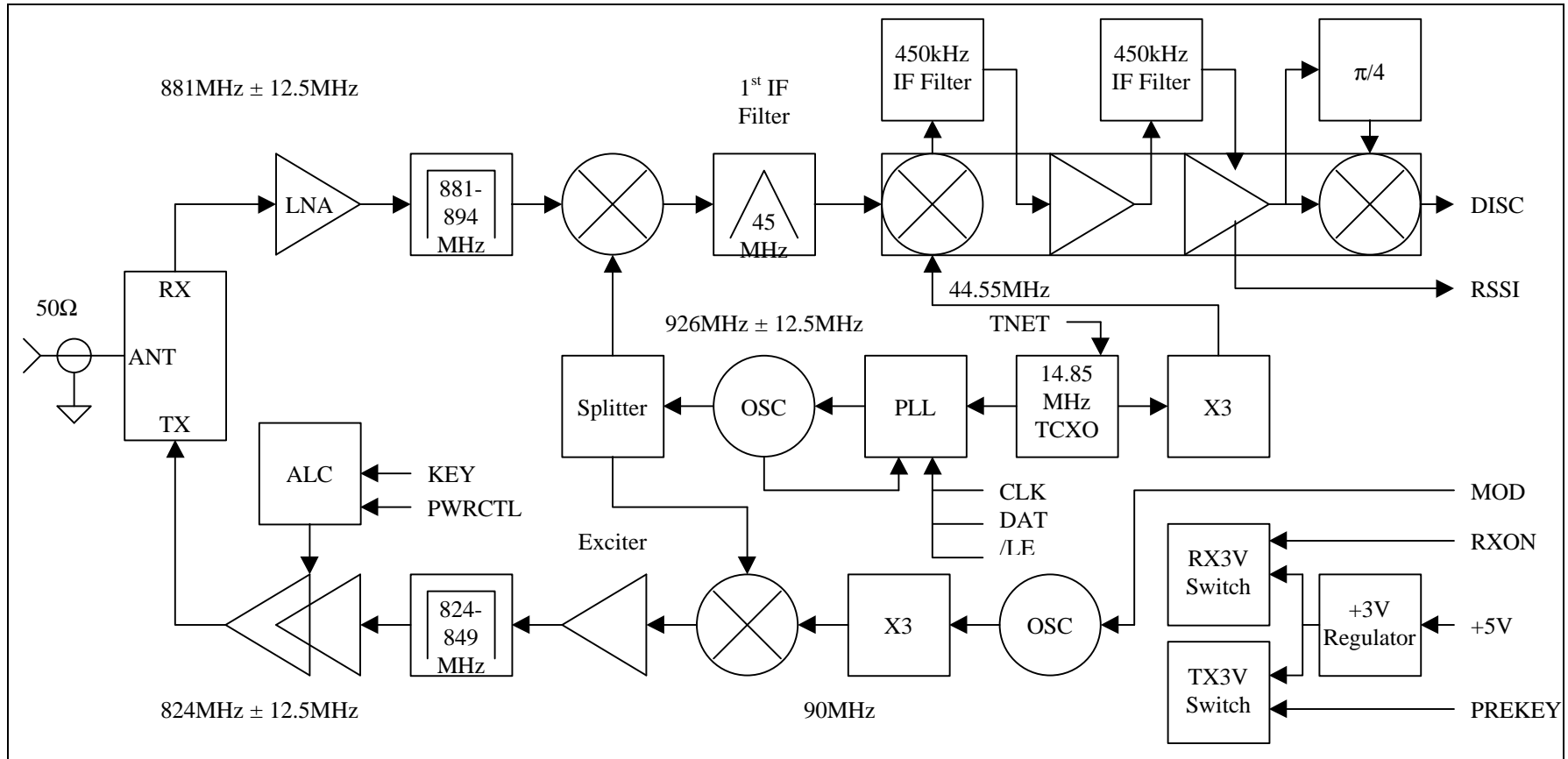

Figure 1. TAZ! Transceiver Block Diagram.

Power Supply

Consists of a single 3V linear regulator (TOKO TK11230BM) and two current switches (Zetex FMMT717 and Motorola MMBT3906LT1).

With an active high control signal from the logic (RXON) the regulator applies RX3V to the receiver, FGU, ADC, and DAC.

With an active low control signal from the logic (/PREKEY) TX3V is applied to the transmit modulator, upconverter, negative voltage generator, and PA automatic level control circuits.

Programming Interface

This is a dumb radio – there is no onboard microcontroller or memory. The radio is programmed for a desired channel through a three line SPI (Serial Peripheral Interface) port to the PLL (Phase Locked Loop).

Transmit power output is selected by a calibrated DC voltage applied to the PWRCTL line.

The RAMP signal prevents excess transient signal splatter during transmit state change. This feature is not required by any North American specification but is designed by Sierra Wireless to protect the congested electromagnetic spectrum.

Transceiver temperature and RSSI (Receiver Signal Strength Indicator) are measured by the ADC (Analog to Digital Converter; Burr-Brown ADS7841). This is also a three wire SPI programmable device.

The receiver discriminator quadrature circuit (QTUNE) and PLL reference oscillator (TNET) are both tuned by the DAC (Digital to Analog Converter, Micro Linear ML2330). This is also a three wire SPI programmable device

Frequency Generation Unit

Consists of a PLL (Phase Locked Loop, National LM1511 + Fujitsu Towa VC-3R0A20-0926-B VCO + Motorola Components KXN1398A TCXO) which generates the Receive and Transmit Local Oscillator signals (RXLO & TXLO) and a tripler circuit which generates the Receive 2ND LO from the reference oscillator (TCXO).

The PLL produces an LO at 926MHz \pm 12.5MHz. This signal is fed directly to the first down converter to produce a 45MHz 1ST IF (Intermediate Frequency). The LO is also fed to the TX mixer which when mixed with the 90MHz modulator output produces the reverse channel signal (836MHz \pm 12.5MHz).

The desired channel is selected by programming the PLL with the correct reference and main loop integer dividers. This one loop produces channel select signals for both receive and transmit paths simultaneously.

To simplify the architecture, we eliminated a 2ND LO synthesizer and generated this signal by tripling the 14.85MHz TCXO to produce 44.55MHz.

Receiver

Consists of half the duplex filter (Taiyo Yuden CFU7BA08360881 or equivalent), an LNA/MIXER GaAs front end (TriQuint TQ9223C), image filter (Murata SAFC881N5MA70N), 1st IF 45MHz crystal filter (Motorola KFN6121), and backend IF strip (Philips SA676DK).

Outputs from the receiver include: DISC+ & DISC-; and RSSI.

Transmitter

The desired reverse channel signal is produced by mixing the TXLO with a tripled output of a 30MHz crystal modulator. The crystal is modulated by the MOD signal. By its very nature a crystal has flat audio modulation response from near DC to well above 10kHz. Careful selection of this crystal was necessary to ensure both wide pullability and tight temperature stability.

The modulated sub-carrier is converted to the desired reverse channel through the upmixer (NEC UPC8106TB). The PA consists of an exciter (NEC UPC2710), noise limiter (Murata SAFC836N5MA70N), power amplifier (ITT GaAsTEK ITT3102BD), and the other half of the duplex filter.

User Manual Pages With FCC Disclaimers

Important Notice

Because of the nature of wireless communications, transmission and reception of data can never be guaranteed. Data may be delayed, corrupted (i.e., have errors) or be totally lost. Although significant delays or losses of data are rare when wireless devices such as the Sierra Wireless modem are used in a normal manner with a well-constructed network, the Sierra Wireless modem should not be used in situations where failure to transmit or receive data could result in damage of any kind to the user or any other party, including but not limited to personal injury, death, or loss of property. Sierra Wireless, Inc., accepts no responsibility for damages of any kind resulting from delays or errors in data transmitted or received using the Sierra Wireless modem, or for failure of the Sierra Wireless modem to transmit or receive such data.

©1998 Sierra Wireless, Inc. All rights reserved.

Printed in Canada.

No part of this publication may be reproduced, stored in a retrieval system, or transmitted in any form or by any means, without the prior permission of the publisher.

The Watcher software described in this manual is copyright 1996 Sierra Wireless, Inc. All rights reserved.

AT is a trademark of Hayes Microcomputer Products, Inc.

Hayes is a registered trademark of Hayes Microcomputer Products, Inc.

Windows is a trademark of Microsoft Corporation.

Microsoft is a registered trademark of Microsoft Corporation.

All other trademarks are owned by their respective companies.

The information in this manual is subject to change without notice and does not represent a commitment on the part of Sierra Wireless, Inc. Sierra Wireless, Inc. shall not be liable for incidental or consequential damages resulting from the furnishing, performance, or use of this manual.

Patents

"Portions of this product are covered by some or all of the following US patents: D367062; D372248; D372701; 5515013; 5617106; 5629960; other patents pending"

Regulatory Information

The equipment certifications appropriate to your device are marked on the device and the accompanying product specific information. Where appropriate, the use of the equipment is subject to the following conditions:

Caution

Unauthorized modifications or changes not expressly approved by Sierra Wireless, Inc. could void compliance with regulatory rules, and thereby your authority to use this equipment.

Warning (EMI) - United States

This equipment has been tested and found to comply with the limits pursuant to Part 15 of the FCC Rules. These limits are designed to provide reasonable protection against harmful interference in an appropriate installation. This equipment generates, uses, and can radiate radio frequency energy and, if not installed and used in accordance with the instructions, may cause harmful interference to radio communication. However, there is no guarantee that interference will not occur in a particular installation. If this equipment does cause harmful interference to radio or television reception, which can be determined by turning the equipment off and on, the user is encouraged to try to correct the interference by one or more of the following measures:

- Reorient or relocate the receiving antenna.
- Increase the separation between the equipment and receiver.
- Connect the equipment into an outlet on a circuit different from that to which the receiver is connected.
- Consult the dealer or an experienced radio/TV technician for help.

Warning (EMI) - Canada

This digital apparatus does not exceed the limits for radio noise emissions from digital apparatus set out in the radio interference regulations of the Canadian Department of Communications.

"Cet appareil numérique respecte les limites de bruits radioélectriques applicables aux appareils numériques de Classe B prescrites dans la norme sur le matériel brouilleur: 'Appareils Numériques', NHB-003 édictée par le ministre des Communications."

RSA Licensee



If you have purchased this product under a United States Government contract, it shall be subject to restrictions as set forth in subparagraph (c)(1)(ii) of Defense Federal Acquisitions Regulations (DFARs) Section 252.227-7013 for Department of Defense contracts and as set forth in Federal Acquisitions Regulations (FARs) Section 52.227-19 for civilian agency contracts or any successor regulations. If further government regulations apply, it is your responsibility to ensure compliance with such regulations.

Safety and Hazards

Do not operate the Sierra Wireless modem in areas where blasting is in progress, where explosive atmospheres may be present, near medical equipment, near life support equipment, or any equipment which may be susceptible to any form of radio interference. In such areas, the Sierra Wireless modem **MUST BE TURNED OFF**. The Sierra Wireless modem can transmit signals, which could interfere with this equipment.

Do not operate the Sierra Wireless modem in any aircraft, whether the aircraft is on the ground or in flight. In aircraft, the Sierra Wireless modem **MUST BE TURNED OFF**. The reason for this is that when operating in the CDPD or cellular circuit switched mode, the Sierra Wireless modem can transmit signals that could interfere with various onboard equipment systems.

The driver or operator of any vehicle should not operate the Sierra Wireless modem while in control of a vehicle. Doing so will detract from the driver or operator's control and operation of that vehicle. In some states and provinces, operating such communications devices while in control of a vehicle is an offence.

Calculation of Necessary Bandwidth for FCC ID: N7NOEM2

For CDPD 19.2Kbps Transmission (emission type FXW)

The data rate is 19200 bits per second.

Necessary Bandwidth = $2M + 2DK$

$M = 10$ kHz

$D = 4.8$ kHz

$K = 1.2$

So necessary bandwidth = $2 \times 10 + 2 \times 4.8 \times 1.2 = 31.5$ kHz

Performance Test Data

RF Output Power (2.985)

Name of Test:	RF Power Output
FCC ID:	N7NOEM2
Grantee:	Sierra Wireless
Serial No.:	20600052674
Manufacturing Rating:	0.00631 to 0.631 Watt +8dBm to +28dBm in 4 dB steps (Controlled by Cell Base Station)
Equipment Authorization Procedure:	Para. 2.985(a)
Test Equipment:	HP8920B Communications Test Set HP3631A DC power supply Zegna 486 PC Computer
Duty Cycle:	Portable (intermittent)

Block Diagram of Test Set-up

The computer is used to select the channel and key the transmitter.

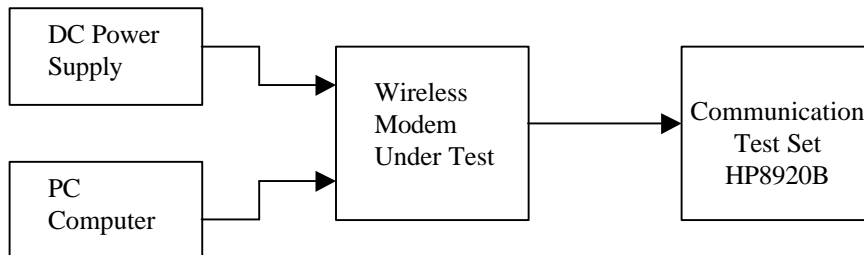

Final Radio Frequency Amplifying Device

ITT333102BD

ITT PA Module

	LOW POWER	HIGH POWER
Drain Current, (I_C) =	85 mA	445 mA
Drain Voltage, (V_C)=	4.8 V	4.8 V
Total Transmitter Load	105 mA	465 mA
DC Input Voltage	5.0 V	5.0 V
Power Input = (I_C)(V_C) = P_{in} =	0.408 W	2.14 W
Measured Power Output = P_{out} =	7.95 dBm	27.3 dBm
Rated Power Output	8.0 dBm	28.0 dBm

Modulation Characteristics (2.987)

Name of Test:	Modulation Characteristics
FCC ID:	N7NOEM2
Grantee:	Sierra Wireless
Serial No.:	20600052674
Minimum Standard Specified	Para. 22.907 (a)
Test Results	N/A
Equipment Authorization Procedure	Para 2.987 (a) and (b)
Test Equipment:	HP8921A Cell Site Test Set HP35665A Dynamic Signal Analyser HP3631A DC power supply Zegna 486 PC Computer

Note: These tests are not applicable as the device is not capable of voice transmission.

Occupied Bandwidth (2.989)

Name of Test:	Occupied Bandwidth
FCC ID:	N7NOEM2
Grantee:	Sierra Wireless
Serial No.:	20600052674
Minimum Standard Specified	Para. 22.907 (b) and (d)
Test Results	Equipment is Compliant with Standard
Equipment Authorization Procedure	Para 2.989 (c)(1)
Test Equipment:	HP8593E Spectrum Analyzer HP3631A DC power supply Zegna 486 PC Computer

Test Setup Block Diagram

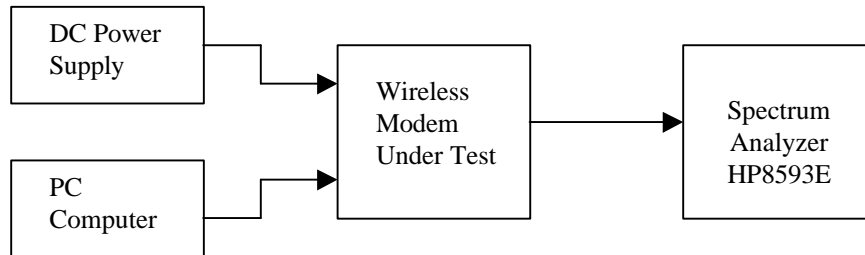

Measurement Data

Spectrum Analyzer:
Settings:

Hewlett Packard 8593E
 Resolution Bandwidth 300 Hz
 Video Filter 300 Hz
 Scan Time 3.33 sec
 Scan Width 100 kHz
 Center Frequency 837.00 MHz

Data Or Signaling Type

1) CDPD, Cellular Digital Packet Data (19.2 kbaud)

Tx Deviation
4.8 kHz

Emission Designator
31K5FXW

CDPD (FXW) Occupied Spectrum - 2.989

12/03/98 SB300 serial# 0x9B356A5F 19.2kbps, 4.8kHz Deviation, 8dBm Output Power

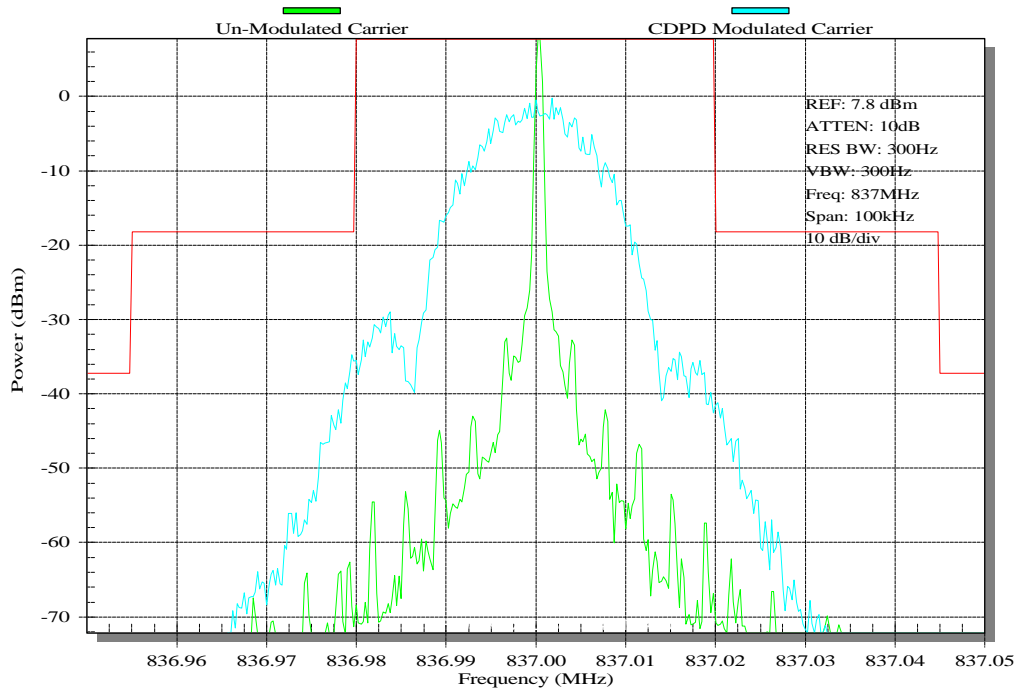

CDPD (FXW) Occupied Spectrum - 2.989

12/03/98 SB300 serial# 0x9B356A5F 19.2kbps, 4.8kHz Deviation, 28dBm Output Power

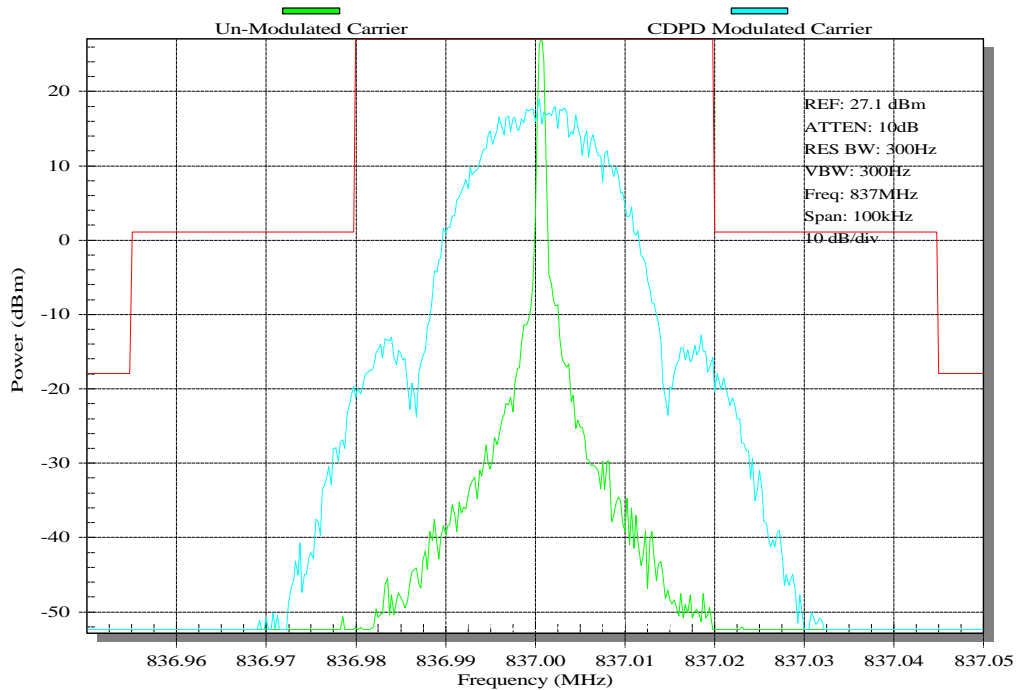

Spurious Emissions at Antenna Terminals (2.991)

Name of Test:	Spurious Emissions at Antenna Terminals
FCC ID:	N7NOEM2
Grantee:	Sierra Wireless
Serial No.:	20600052674
Minimum Standard Specified	Para. 22.106
Test Results	Equipment Compliant with Standard
Equipment Authorization Procedure	Para. 2.993
Frequency Range Observed	0 to 9 GHz
Operating Frequency	837.000 MHz
Crystal Frequency	14.85 MHz TCXO
Power Output	0.00631 to 4.0 Watt (8 to 36 dBm) in 4 dB steps
Spurious Limit = 43dB + 10Log₁₀ (P_O)	-21 to -41 dBm
=	

Test Setup Block Diagram

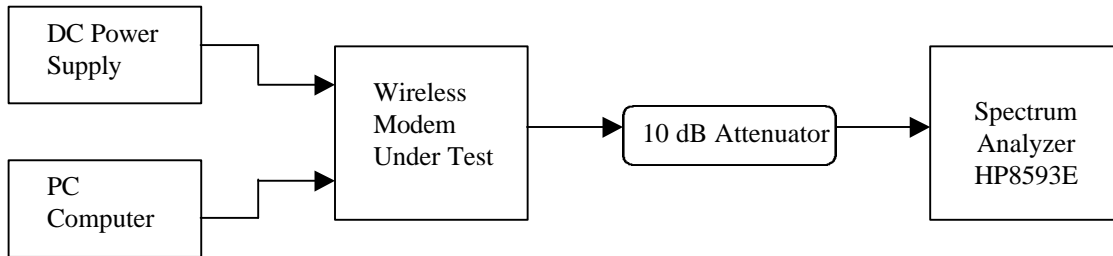

Measurement Data

Formula	Frequency (MHz)	Level (dB below carrier)	
		Low Power	High Power
f_o	837.0	- 0 -	- 0 -
$2f_o$	1647.0	-	-
$3f_o$	2511.0	-	-
$4f_o$	3348.0	-	-
$7f_o$	5859.0	-	-
$8f_o$	6696.0	-	-

Note: All emissions were greater than 20dB below the spurious limit. Plots of the spurs reported in the table can be seen on the following 2 pages.

Low Power (8dBm Nominal)

Spurious Emissions at Antenna Terminals - 2.991

12/04/98 SB300 serial# 0x9B356A5F 19.2kbps, 4.8kHz Deviation, 8dBm Output Power

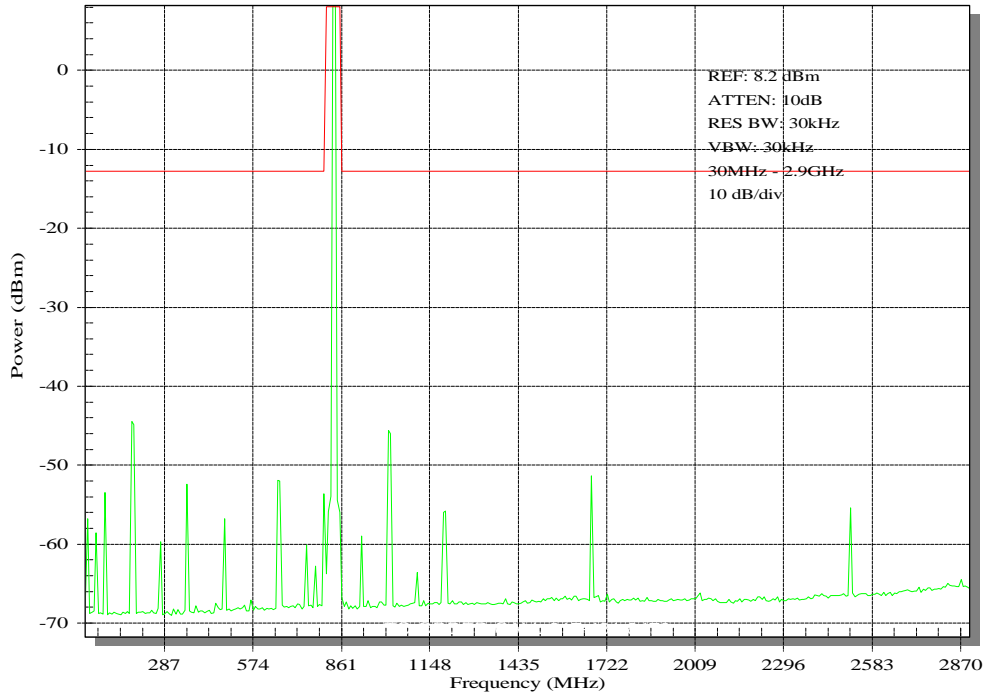

Spurious Emissions at Antenna Terminals - 2.991

12/04/98 SB300 serial# 0x9B356A5F 19.2kbps, 4.8kHz Deviation, 8dBm Output Power

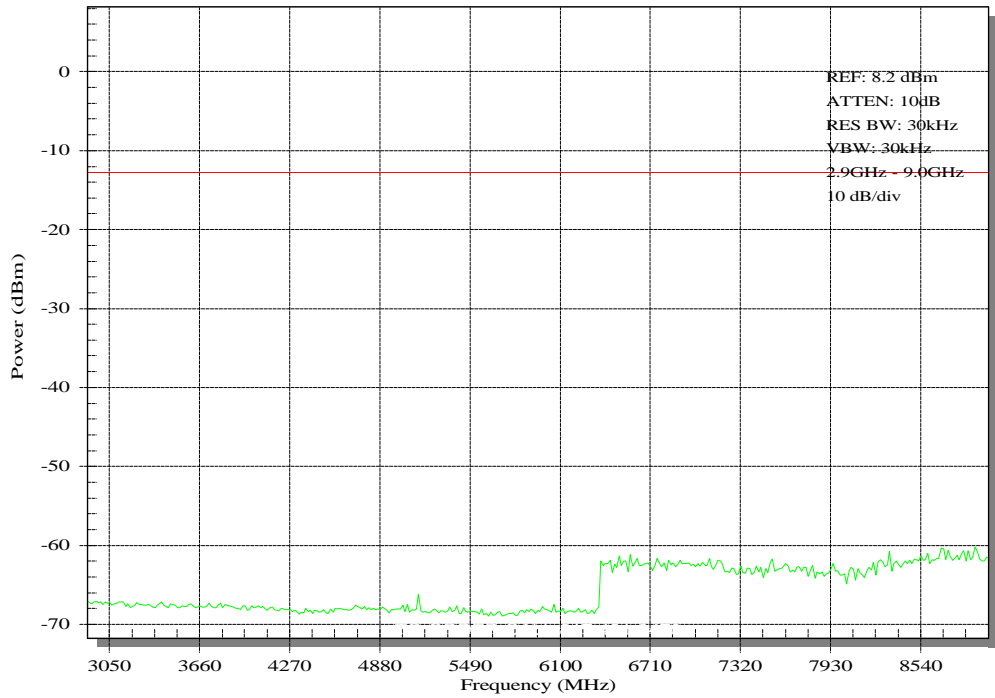

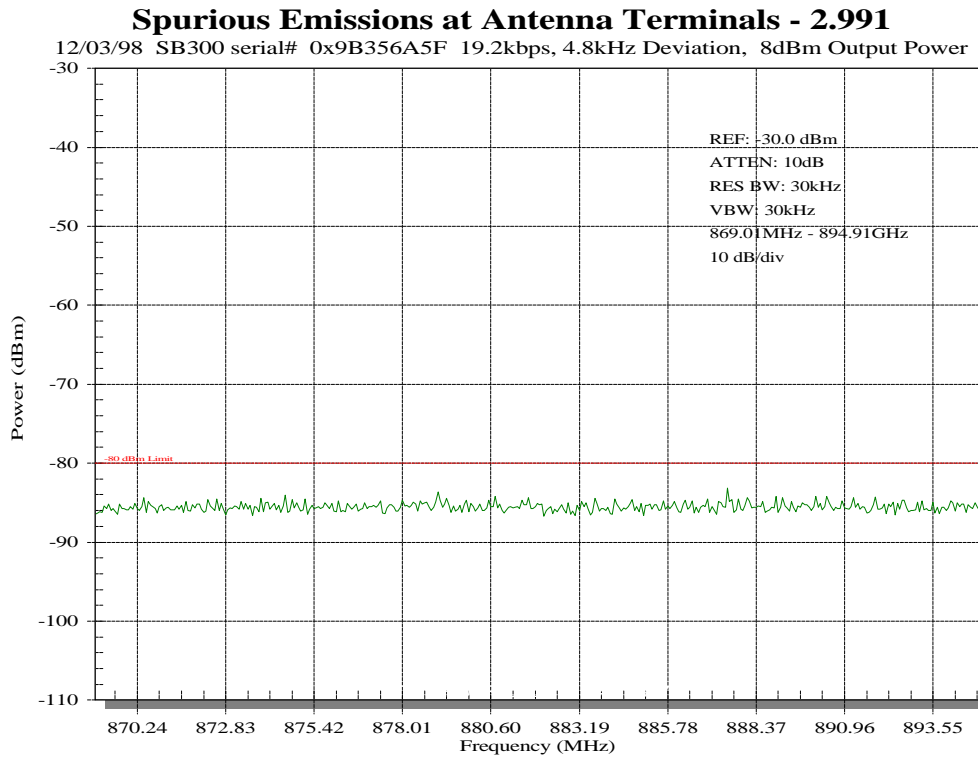

High Power (28dBm Nominal)

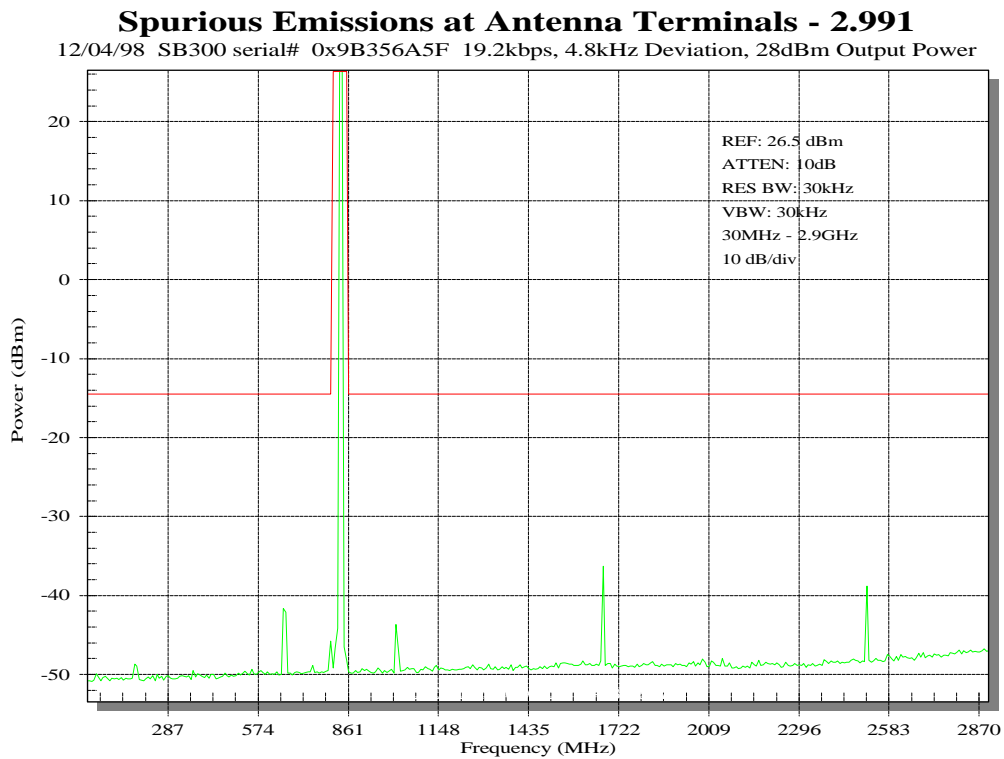

Spurious Emissions at Antenna Terminals - 2.991

12/04/98 SB300 serial# 0x9B356A5F 19.2kbps, 4.8kHz Deviation, 28dBm Output Power

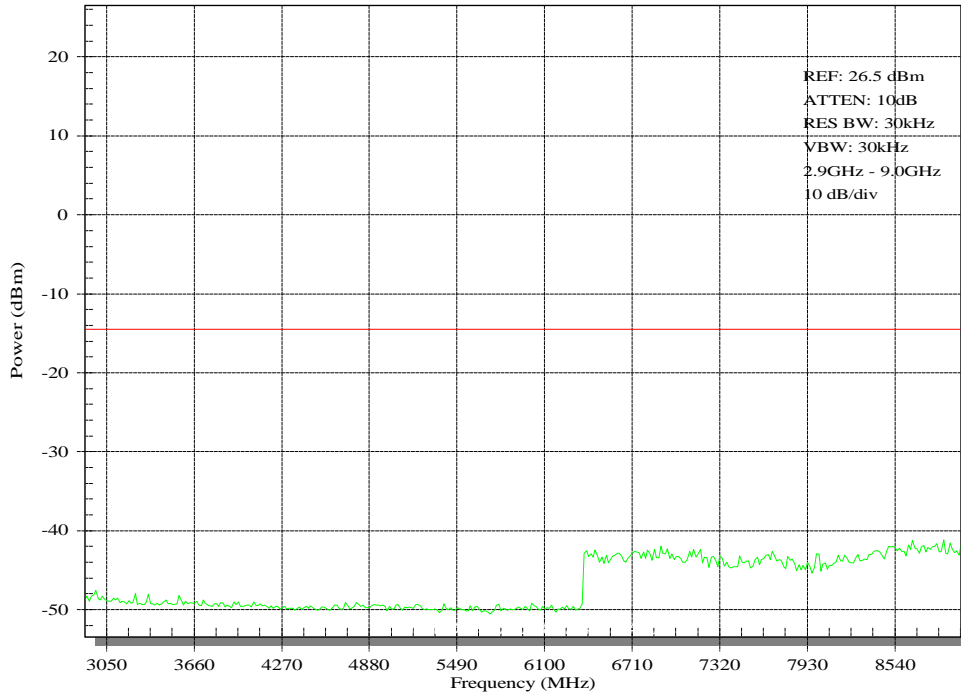

Spurious Emissions at Antenna Terminals - 2.991

12/03/98 SB300 serial# 0x9B356A5F 19.2kbps, 4.8kHz Deviation, 28dBm Output Power

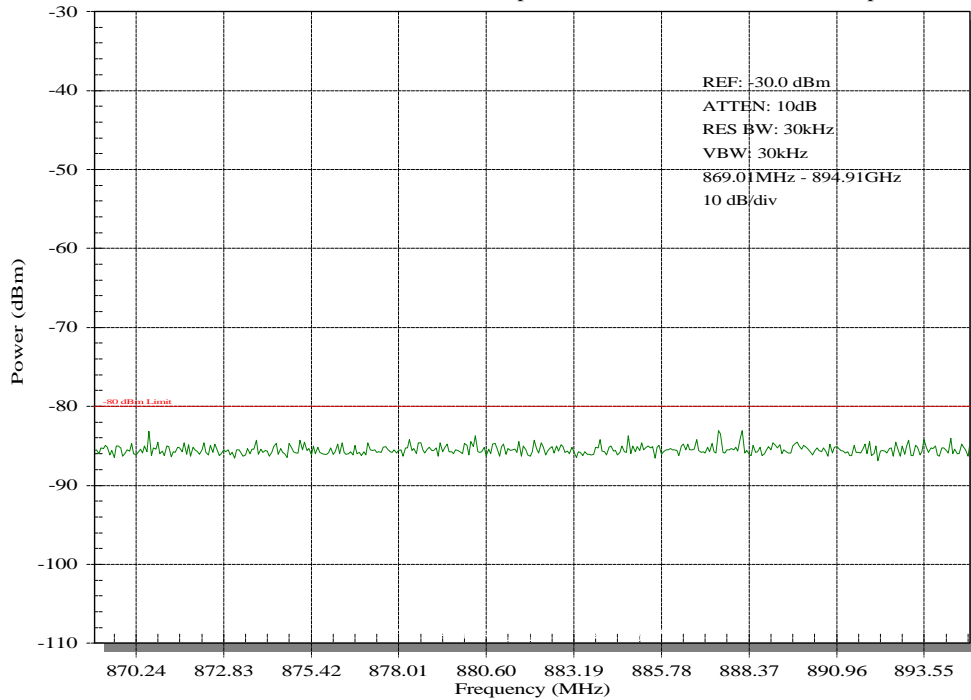

Field Intensity Measurements of Spurious Radiation (2.993)

Name of Test:	Field Intensity Measurements of Spurious Radiation
FCC ID:	N7NOEM2
Grantee:	Sierra Wireless
Serial No.:	20600052674
Minimum Standard Specified	Para. 22.106
Test Results	Equipment is Compliant with Standard
Equipment Authorization Procedure	Para. 2.993
Frequency Range Observed	0 MHz to 9 GHz
Spurious Limit = $43\text{dB} + 10\text{Log}_{10} P_{\text{O}}$	-21 to -49 dB

Note: This test was performed at:

**Intertek Testing Services NA Inc.
1365 Adams Court
Menlo Park, CA 94025**

Operation Stability Performance (2.995)

Name of Test:	Operational Stability Performance
FCC ID:	N7NOEM2
Grantee:	Sierra Wireless
Serial No.:	20600052674
Minimum Standard Specified	Para. 22.101 (a)
Equipment Authorization Procedure	Para. 2.995
Test Results	Equipment is Compliant with Standard
Test Equipment	HP8920B Cell Site Test Set Tenney Jr environmental chamber HP3631A DC power supply Zegna 486 PC Computer
Standard Test Frequency	837.00 MHz

Notes : Tolerance = +/- 2091 Hz or 2.5 ppm

Block Diagram of Test Set-up

Measurements were performed using an automated test facility which includes a switch matrix to route transmitter power to the test set. Path loss is accounted for automatically in our test software.

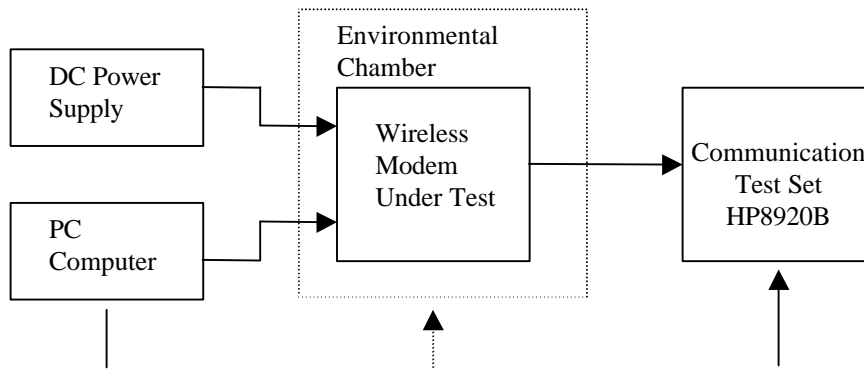

EUT set up in test chamber with temperature probe located adjacent to EUT in chamber center to observe ambient.

NOTE: The EUT has an internal voltage detector which disables the modem if power supply deviates more the 0.25V from nominal. Testing was therefore performed at nominal voltage (5.0V) and the upper and lower threshold of operability permitted by the voltage supervisor, 5.25V and 4.75V respectively.

Measurement Data

Table 1: Tx Stability Varying +5V Supply

Temp (°C)	Freq. Stability (rated voltage 5.0V) (ppm)	Freq. Stability (max voltage 5.25V) (ppm)	Freq. Stability (min. voltage 4.75V) (ppm)	Worst Case Relative to Rated Freq. Stability (ppm)
-30	-0.50	-0.50	-0.50	-0.50
-20	-0.54	-0.53	-0.54	-0.54
-10	-0.44	-0.43	-0.42	-0.44
0	0.21	0.22	0.24	0.24
10	0.15	0.14	0.16	0.16
20	0.62	0.62	0.63	0.63
30	1.16	1.17	1.17	1.17
40	1.26	1.27	1.29	1.29
50	1.82	1.83	1.85	1.85
60	1.69	1.68	1.69	1.69
70	1.30	1.30	1.30	1.30
80	0.58	0.58	0.59	0.59

Frequency Stability over Temperature and Voltage - 2.995

Worst case

12/02/98 SB300 serial# 0x9B356A5F

- 2.5 ppm.

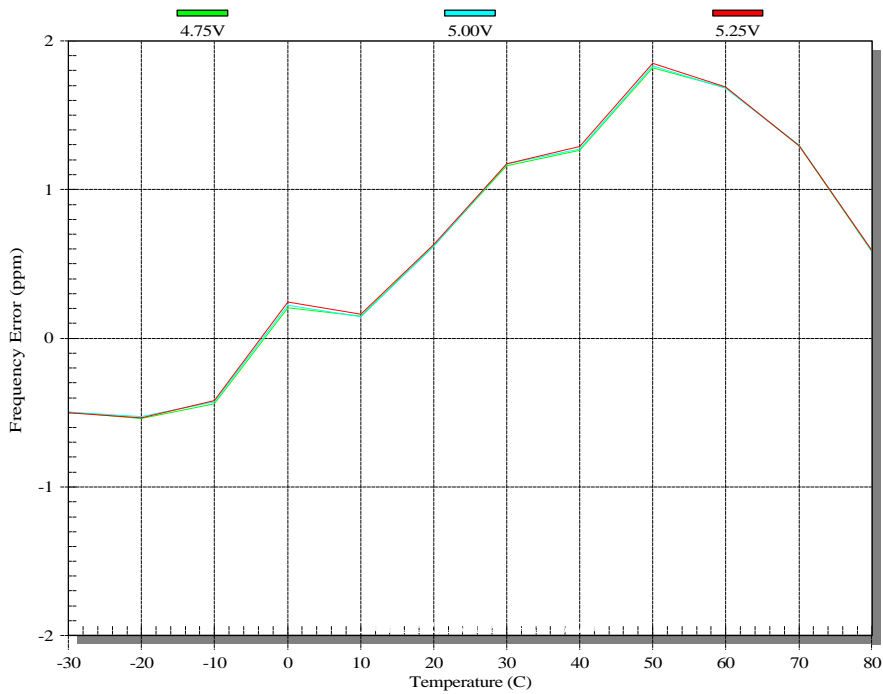

Test Equipment List

Sierra Wireless, Inc.

<u>Type</u>	<u>Manufacturer and Model No.</u>	<u>Serial no.</u>	<u>Accuracy</u>
Spectrum Analyzer	Hewlett Packard HP8593E Opt. 041, 101, 130	3801A03362	
Cell Site Test Set	Hewlett Packard HP8920B Opt. 001, 004, 006, 013, 102	US37423716	0.05PPM +/-1Hz, +/- 5% +/-0.01mW
Power Supply	Hewlett Packard HP3631A	KR53600263	DCV +/- 0.1% +5mV
Multimeter	Hewlett Packard HP3457A	3114A14978	
Attenuators	Mini-Circuits CAT-10	9406 13	
Thermometer	Fluke 52	3965185	+/- (0.1% reading +/-0.7 deg C)

FCC Sample Label

Finished Product Label:

See the photos and label diagram accompanying this report for the layout and positioning of the FCC label.

Finished Product Label Location:

See the photos accompanying this report for the layout and positioning of the FCC label.