



MC/EM8805 Modem

Test Report

FOR
WCDMA / HSPA

Rev.2

FCC and IC Certifications

IC: 2417C-MC8805
FCC ID: N7NMC8805

© 2010 Sierra Wireless, Inc.

This document contains information which is proprietary and confidential to Sierra Wireless, Inc. Disclosure to persons other than the officers, employees, agents, or subcontractors of the Company or licensee of this document without the prior written permission of Sierra Wireless, Inc. is strictly prohibited.

SIERRA WIRELESS, INC.

FCC Part 22/24, RSS-132/133	MC/EM8805	Jan 14, 2013	Page 2 of 19
-----------------------------	-----------	--------------	--------------

Table of Contents

1	Introduction and Purpose	3
1.1	Revision history.....	3
2	Test Summary	3
3	Description of Equipment under Test.....	3
4	Compliance Test Equipment List	4
5	Test Setup Block Diagrams	4
5.1	Test Setup 1	4
5.2	Test Setup 2.....	5
6	RF Power Output	5
6.1	Test Procedure	5
6.1.1	WCDMA/HSDPA/HSUPA Max Power setup	5
6.2	Maximum Transmit Power Test Results	8
6.2.1	Test Results for WCDMA/HSDPA/HSUPA Output Power.....	8
7	Occupied Bandwidth.....	8
7.1	Test Procedure	8
7.2	Test Results	8
7.2.1	WCDMA Summary Results	8
7.2.2	WCDMA Rel99 Test Plots	9
7.2.3	HSUPA Rel6 (Subtest 5) Test Plots.....	10
8	Out of Band Emissions at Antenna Terminals	10
8.1	Test Procedure	11
8.2	Test Results	11
8.2.1	WCDMA Rel99 Test Plots	11
9	Block Edge Compliance	13
9.1	Test Procedure.....	13
9.2	Test Results	14
9.2.1	WCDMA Test Plots.....	14
10	Frequency Stability versus Temperature.....	17
10.1	Summary of Results.....	17
10.2	Test Procedure.....	17
10.3	Test Results	17
10.3.1	UMTS Frequency Error over Temperature	17
11	Frequency Stability versus Voltage.....	17
11.1	Summary of Results.....	17
11.2	Test Procedure.....	18
11.3	Test Results	18
11.3.1	UMTS Frequency Error over Voltage	18
12	Peak to Average Ratio	18
12.1	Summary of Results.....	18
12.2	Test Procedure.....	18
12.3	Test Results	18
12.3.1	Test Plots.....	19

© 2010 Sierra Wireless, Inc.

The contents of this page are subject to the confidentiality information on page one.

SIERRA WIRELESS, INC.

FCC Part 22/24, RSS-132/133	MC/EM8805	Jan 14, 2013	Page 3 of 19
-----------------------------	-----------	--------------	--------------

1 Introduction and Purpose

This document provides test data for the MC/EM8805 modem output power intended for FCC and Industry Canada certifications.

1.1 Revision history

Rev	Date	Author	Summary of changes	ECO #
1.0	Dec. 16, 2012	Darryl Simpson	First Release	
2.0	Jan. 14, 2013	Markus Myers	Updated tables with channel frequencies.	

2 Test Summary

FCC Rule	IC Standards	DESCRIPTION OF TEST	RESULT	PAGE
2.1046	RSS-132, 4.4 RSS-133, 6.4	RF Power Output	Complies	5
2.1049	RSS-Gen, 4.6	Occupied Bandwidth	Complies	
2.1051, 22.917, 24.238	RSS-132, 4.5 RSS-133, 6.5	Out of Band Emissions at Antenna Terminals	Complies	
22.917, 24.238	RSS-Gen, 4.6	Block Edge Compliance	Complies	
2.1055, 22.355, 24.235,	RSS-132, 4.3 RSS-133, 6.3	Frequency Stability versus Temperature	Complies	
2.1055, 22.355, 24.235,	RSS-132, 4.3 RSS-133, 6.3	Frequency Stability versus Voltage	Complies	
24.232		Peak to Average Ratio	Complies	

3 Description of Equipment under Test

The MC/EM8805 modem, referred to as “EUT” hereafter, is a multi-band wireless modem operating on the GSM/GPRS/EDGE/UMTS networks. The table below shows the supported North American bands for the device. The MC8805 and EM8805 differ only in PCB length and host interface connector. Both products utilize the same PCB RF layout, components and firmware. Please refer to document “MCEM8805 Comparison.pdf”.

This report only contains the test data for WCDMA/HSPA technologies.

SIERRA WIRELESS, INC.

4 Compliance Test Equipment List

EQUIPMENT	MANUFACTURER	MODEL NO.	SERIAL NO.	CAL. DATE
Control Computer	TC	Generic PC	100488	N/A
Wireless Test Set	Rohde & Schwarz	CMU200	110521	October 30, 2012
Wireless Test Set	Rohde & Schwarz	CMW500	101060	June 08, 2014
Spectrum Analyzer	Rohde & Schwarz	FSP	100060	October 31, 2012
DC Power Supply	HP	6632A	3530A	N/A
Interface Board	Shop built	ATEMux	N/A	N/A
Directional Coupler	Pasternack	PE2209-10	N/A	N/A

5 Test Setup Block Diagrams

5.1 Test Setup 1

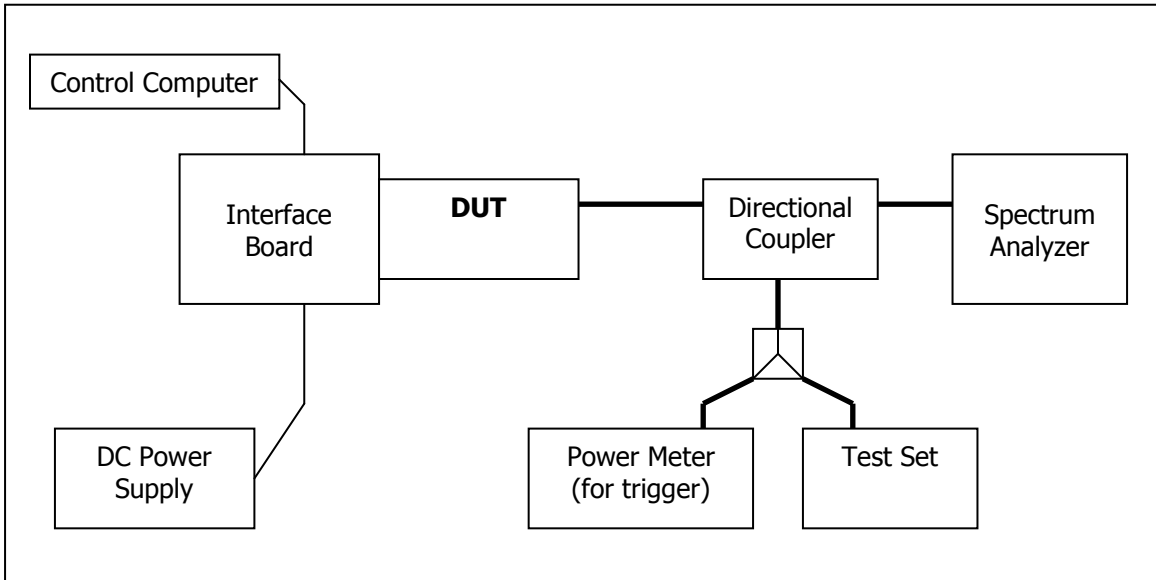

5.2 Test Setup 2

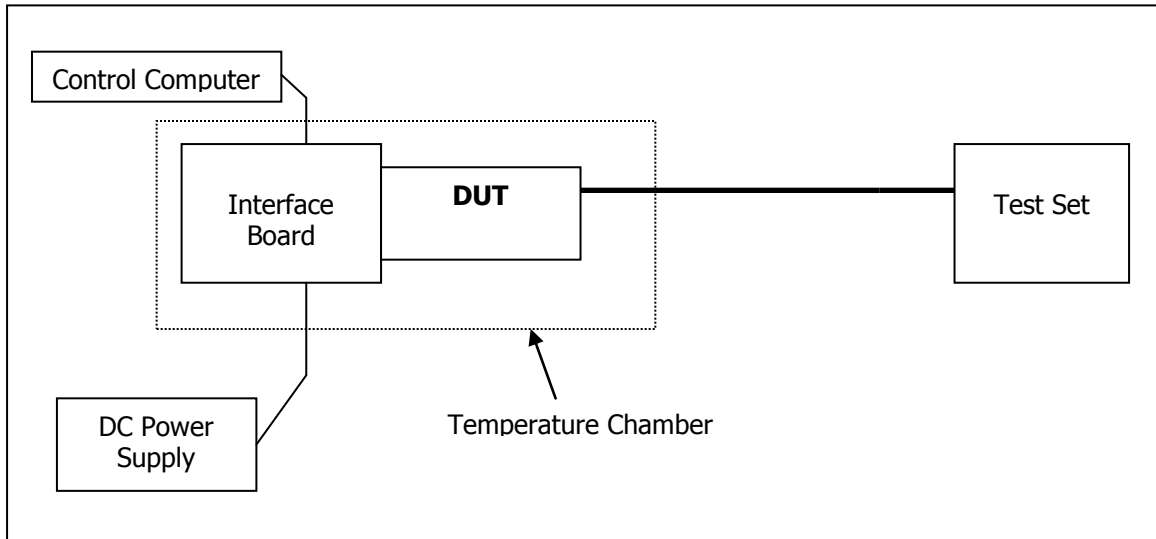

6 RF Power Output

FCC 2.1046

6.1 Test Procedure

The transmitter output was connected to a Rohde & Schwarz CMU200 Test Set and configured to operate at maximum power in a call. The power was measured using the Average Power measurement of the CMU200. Refer to Test Setup 1.

6.1.1 WCDMA/HSDPA/HSUPA Max Power setup

Configure the call box to support all WCDMA tests in respect to the 3GPP 34.121 (listed in Table 4.2). Measure the power at Ch4132, 4182 and 4233 for US cell; Ch9262, 9400 and 9538 for US PCS band.

For Rel99 per 3GPP 35.121 5.2

- Set a Test Mode 1 loop back with a 12.2kbps Reference Measurement Channel (RMC)
- Set and send continuously Up power control commands to the MC/EM8805 module.
- Measure the power at the MC/EM8805 module antenna connector using the power meter with average detector

For HSDPA Rel 7 3 per GPP 35.121 5.2AA

- Establish a Test Mode 1 look back with both 1 12.2kbps RMC channel and an H-Set1 Fixed Reference Channel (FRC). With the CMU200 this is accomplished by setting

© 2010 Sierra Wireless, Inc.

The contents of this page are subject to the confidentiality information on page one.

SIERRA WIRELESS, INC.

FCC Part 22/24, RSS-132/133	MC/EM8805	Jan 14, 2013	Page 6 of 19
-----------------------------	-----------	--------------	--------------

the signal Channel Coding to “Fixed Reference Channel” and configuring for HSET-1 QKSP.

- Set beta values and HSDPA settings for HSDPA Subtest1 according to Table 4.2
- Send continuously Up power control commands to the MC/EM8805 module
- Measure the power at the MC/EM8805 module antenna connector using the power meter with modulated average detector
- Repeat the measurement for the HSDPA Subtest2, 3 and 4 as given in Table 4.2

For HSUPA Rel 6 per 3GPP 35.121 5.2B

- Use UL RMC 12.2kbps and FRC H-Set1 QPSK, Test Mode 1 loop back. With the CMU200 this is accomplished by setting the signal Channel Coding to “E-DCH Test Channel” and configuring the equipment category to Cat5_10ms.
- Set the Absolute Grant for HSUPA Subtest1 according to Table 4.2
- Set the MC/EM8805 module power to be at least 5dB lower than the Maximum output power
- Send power control bits to give one TPC_cmd = +1 command to the UNDP. If UNDP doesn’t send any E-DPCH data with decreased E-TFCI within 500ms, then repeat this process until the decreased E-TFCI is reported.
- Confirm that the E-TFCI transmitted by the MC/EM8805 module is equal to the target E-TFCI in Table 4.2. If the E-TFCI transmitted by the MC/EM8805 module is not equal to the target E-TFCI, then send power control bits to give one TPC_cmd = -1 command to the UE. If UE sends any E-DPCH data with decreased E-TFCI within 500 ms, send new power control bits to give one TPC_cmd = -1 command to the UE. Then confirm that the E-TFCI transmitted by the UE is equal to the target E-TFCI in Table 4.2. If the E-TFCI transmitted by the UE is not equal to the target E-TFCI, then fail the UE
- Measure the power using the power meter with an average detector
- Repeat the measurement for the HSUPA Subtest2, 3 and 4 as given in Table 4.2
- Test case 5 is tested using all up bits for maximum output power per 3GPP 34.521.

Table 4.2 3GPP Rel99/HSPA Subtest Settings

						Common Settings					HSDPA Specific Settings						HSUPA Sepcific Settings			HSUPA Additional Info		
Subtest	Mode	Loopback Mode	Rel99 RMC	HDP A FRC	HSUPA Test	β_c	β_d	C M	M PR	Power Class 3 limit (dBm)	$\Delta A CK$	$\Delta N AK$	$\Delta C QI$	ACK-NAK repetition factor	CQI Feedback (Table 5.2B.4)	CQI Repetition Factor (Table 5.2B.4)	Ahs = β_{hs} / β_c	$\Delta E-DPC CH$	$\Delta H A R Q$	AG Index	ERFCI (from 34.121 Table C.11.1.3)	Associated Max UL Data Rate kbps
1	Rel99	Testmode 1	12.2k bps	-	-			-		24 (+1.7/-3.7 dB)												
1	Rel6 HSDPA	Testmode 1	12.2k bps	H-Set 1	-	2/15	15/15	0	0	24 (+1.7/-3.7 dB)	8	8	8	3	4 ms	2	30/15					
2	Rel6 HSDPA	Testmode 1	12.2k bps	H-Set 1	-	12/15	15/15	1	0	24 (+1.7/-3.7 dB)	8	8	8	3	4 ms	2	30/15					
3	Rel6 HSDPA	Testmode 1	12.2k bps	H-Set 1	-	15/15	8/15	1.5	0.5	23.5 (+2.2/-3.7 dB)	8	8	8	3	4 ms	2	30/15					
4	Rel6 HSDPA	Testmode 1	12.2k bps	H-Set 1	-	15/15	4/15	1.5	0.5	23.5 (+2.2/-3.7 dB)	8	8	8	3	4 ms	2	30/15					
1	Rel6 HSUPA	Testmode 1	12.2k bps	H-Set 1	HSUPA Loopback	11/15	15/15	1	0	24 (+1.7/-3.7 dB)	8	8	8	3	4 ms	2	30/15	6	0	20	75	242.1
2	Rel6 HSUPA	Testmode 1	12.2k bps	H-Set 1	HSUPA Loopback	6/15	15/15	3	2	22 (+3.7/-3.7 dB)	8	8	8	3	4 ms	2	30/15	8	0	12	67	174.9
3	Rel6 HSUPA	Testmode 1	12.2k bps	H-Set 1	HSUPA Loopback	15/15	9/15	2	1	23 (+2.7/-3.7 dB)	8	8	8	3	4 ms	2	30/15	8	0	15	92	482.8
4	Rel6 HSUPA	Testmode 1	12.2k bps	H-Set 1	HSUPA Loopback	2/15	15/15	3	2	22 (+3.7/-3.7 dB)	8	8	8	3	4 ms	2	30/15	5	0	17	71	205.8
5	Rel6 HSUPA	Testmode 1	12.2k bps	H-Set 1	HSUPA Loopback	15/15	15/15	1	0	24 (+1.7/-3.7 dB)	8	8	8	3	4 ms	2	30/15	7	0	81	81	308.9

© 2010 Sierra Wireless, Inc.

This document contains information which is proprietary and confidential to Sierra Wireless, Inc. Disclosure to persons other than the officers, employees, agents, or subcontractors of the Company or licensee of this document without the prior written permission of Sierra Wireless, Inc. is strictly prohibited.

6.2 Maximum Transmit Power Test Results

6.2.1 Test Results for WCDMA/HSDPA/HSUPA Output Power

Mode	3GPP Subtest	B5 (800 MHz) Channel Power (dBm)			B2 (1900 MHz) Channel Power (dBm)			MPR
		4132 (826.4 MHz)	4182 (836.4 MHz)	4233 (846.6 MHz)	9262 (1852.4 MHz)	9400 (1880.0 MHz)	9538 (1907.6 MHz)	
Rel99	1	22.89	22.99	22.92	23.36	22.95	23.24	N/A
Rel6 HSDPA	1	22.38	22.47	22.43	22.9	22.3	22.63	0
	2	22.27	22.65	22.38	22.88	22.48	22.56	0
	3	21.75	22.05	21.99	22.48	21.9	22.01	0.5
	4	21.82	22.07	21.87	22.51	21.91	22.09	0.5
Rel6 HSUPA	1	21.76	22.38	22.43	22.23	22.49	22.2	0
	2	20.5	20.76	20.22	20.45	20.54	20.54	2
	3	21.58	21.36	21.41	21.79	21.35	21.67	1
	4	21.34	21.34	21.3	21.19	21.26	20.93	2
	5	22.37	22.53	22.37	22.67	22.2	22.56	0

7 Occupied Bandwidth

FCC 2.1049

7.1 Test Procedure

The transmitter output was connected to a spectrum analyzer through a calibrated coaxial cable and a directional coupler. The occupied bandwidth (defined as the 99% Power Bandwidth) was measured with the spectrum analyzer at low, middle, and high frequencies in each band. The -26dB bandwidth was also measured and recorded. Refer to Test Setup 1.

7.2 Test Results

For WCDMA testing, Rel 99 setup used RMC 12.2kps and R6 HSUPA used setup for 3GPP subtest 5.

7.2.1 WCDMA Summary Results

Mode	Band	Frequency (MHz)	Channel	99% Occupied Bandwidth (MHz)	-26dBc Occupied Bandwidth (MHz)	Corresponding Plot number
B2	Rel99	1880	9400	4.20	4.72	7.2.2.1
	Rel 6 (HSUPA)	1880	9400	4.20	4.76	7.2.3.1

© 2010 Sierra Wireless, Inc.

This document contains information which is proprietary and confidential to Sierra Wireless, Inc. Disclosure to persons other than the officers, employees, agents, or subcontractors of the Company or licensee of this document without the prior written permission of Sierra Wireless, Inc. is strictly prohibited.

SIERRA WIRELESS, INC.

FCC Part 22/24, RSS-132/133	MC/EM8805	Jan 14, 2013	Page 9 of 19
-----------------------------	-----------	--------------	--------------

B5	Rel99	836.4	4182	4.18	4.68	7.2.2.2
	Rel 6 (HSUPA)	836.4	4182	4.16	4.70	7.2.3.2

7.2.2 WCDMA Rel99 Test Plots

7.2.2.1 WCDMA Occupied Bandwidth, B2 Middle channel, 1880 MHz, 99% BW

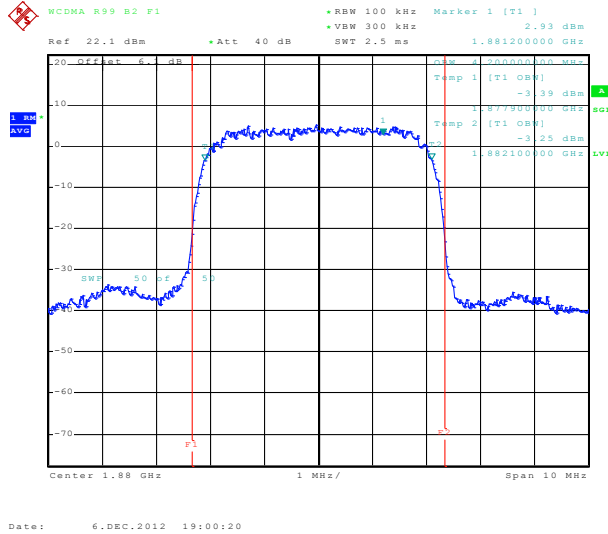

7.2.2.2 WCDMA Occupied Bandwidth, B5 Middle channel, 836.4 MHz, 99% BW

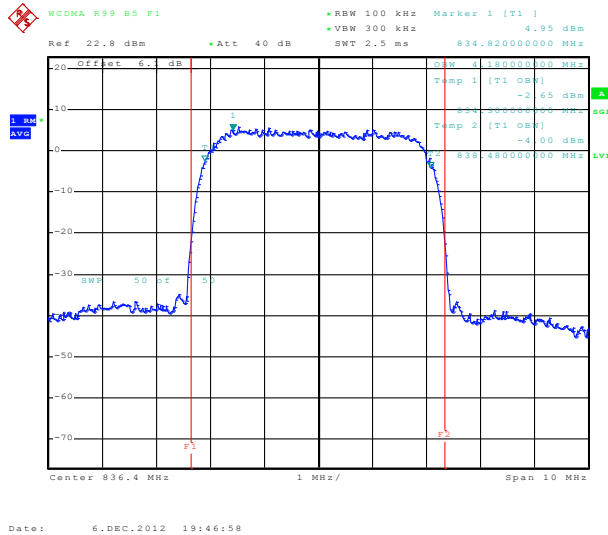

7.2.3 HSUPA Rel6 (Subtest 5) Test Plots

7.2.3.1 WCDMA Rel. 6 Occupied Bandwidth, B2 Middle channel, 1880 MHz, 99% BW

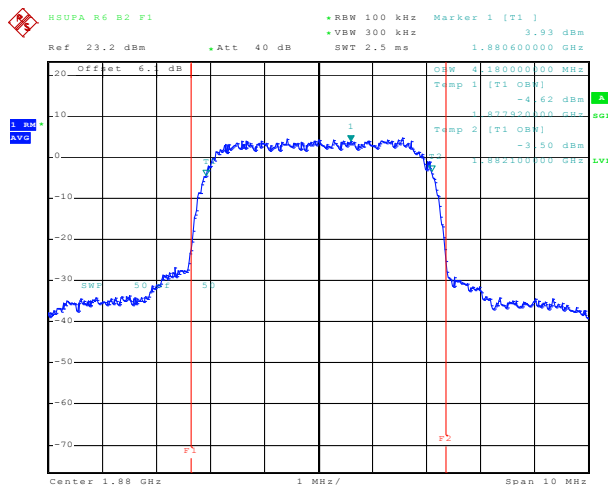

7.2.3.2 WCDMA Rel. 6 Occupied Bandwidth, B5 Middle channel, 836.4 MHz, 99% BW

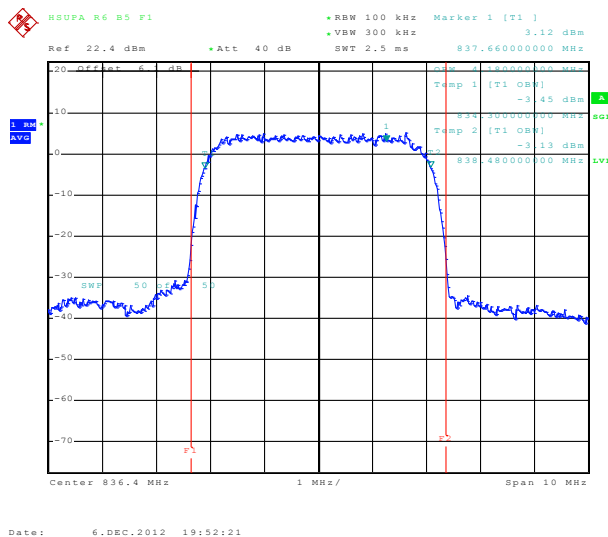

8 Out of Band Emissions at Antenna Terminals

FCC 22.901(d), 22.917, 24.238(a)

Out of Band Emissions:

The mean power of emissions must be attenuated below the mean power of the unmodulated carrier (P) on any frequency outside the frequency band by at least $(43 + 10 \log P)$ dB. The out of band emission limit translates to a worst case absolute limit of -13dBm in this case.

SIERRA WIRELESS, INC.

8.1 Test Procedure

The RF output of the transmitter was connected to a spectrum analyzer through a calibrated coaxial cable. Sufficient scans were taken to show the out-of-band emissions, if any, up to 10th harmonic. The EUT was scanned for spurious emissions from 1MHz to 20GHz with sufficient bandwidth and video resolution. Data plots are included. Multiple sweeps were recorded in maximum hold mode using a peak detector to ensure that the worst-case emissions were captured. Refer to Test Setup 1.

8.2 Test Results

Refer to the following plots.

Mode	Band	Frequency (MHz)	Channel	Corresponding Plot number
Rel99	B2	1880	9400	Plot 8.2.1.1 – 8.2.1.3
	B5	836.4	4182	Plot 8.2.1.4 – 8.2.1.5

The plots below show that the conducted emission limits requirements are met.

8.2.1 WCDMA Rel99 Test Plots

8.2.1.1 Out of Band Emissions at Antenna Terminals WCDMA B2, Middle channel, 1880 MHz, 2 Hz to 1 GHz

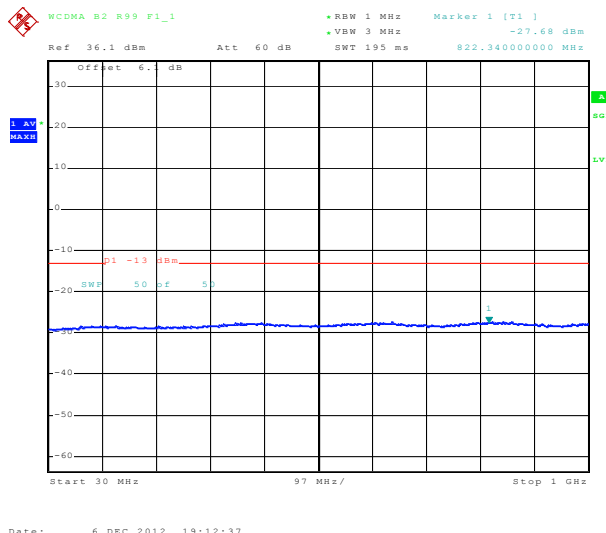

SIERRA WIRELESS, INC.

8.2.1.2 Out of Band Emissions at Antenna Terminals WCDMA B2, Middle channel, 1880 MHz, 1 GHz to 10 GHz

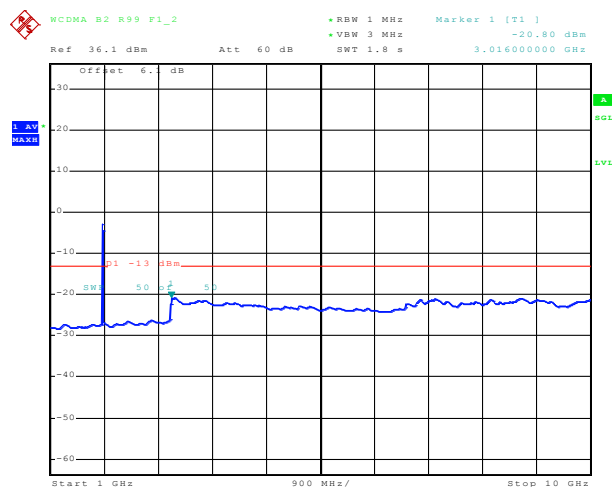

Date: 6.DEC.2012 19:14:51

Note: The strong emission shown is the carrier signal.

8.2.1.3 Out of Band Emissions at Antenna Terminals WCDMA B2, Middle channel, 1880 MHz, 10 GHz to 20 GHz

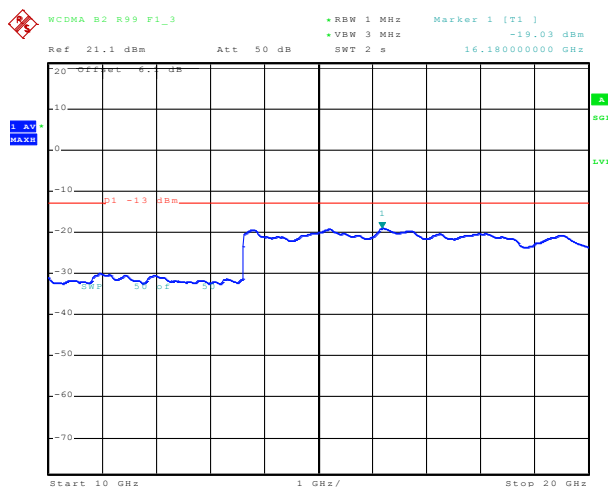

Date: 6.DEC.2012 19:16:59

SIERRA WIRELESS, INC.

8.2.1.4 Out of Band Emissions at Antenna Terminals WCDMA B5, Middle channel, 836.4 MHz, 2 Hz to 1 GHz

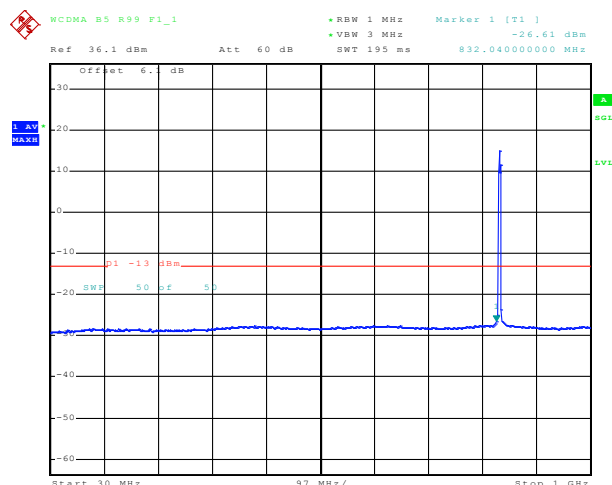

Date: 6.DEC.2012 19:57:06

Note: The strong emission shown in each case is the carrier signal.

8.2.1.5 Out of Band Emissions at Antenna Terminals WCDMA B5, Middle channel, 836.4 MHz, 1 GHz to 10 GHz

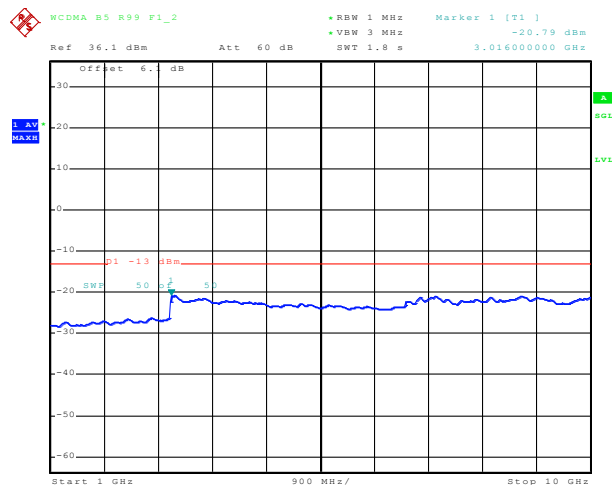

Date: 6.DEC.2012 19:59:20

9 Block Edge Compliance

FCC Part 22(h)/24(e)

9.1 Test Procedure

The transmitter output was connected to a Rohde & Schwarz CMU200 Test Set, through a coaxial RF cable and a directional coupler, and configured to operate at maximum

SIERRA WIRELESS, INC.

power. The block edge emissions were measured at the required operating frequencies in each band on the Spectrum Analyzer. Refer to Test Setup 1.

The resolution bandwidth was set to at least 1% of the emission bandwidth (where applicable). The power was scaled accordingly:

$$\text{Power offset} = 10 * \log(\text{FCC_RBW} / \text{Measurement_RBW})$$

9.2 Test Results

Block Test	Band	Frequency Boundaries (MHz)	Channels Tested	Channel Frequencies (MHz)	Corresponding Plots	Result
WCDMA	B2	Below 1850 MHz, above 1910 MHz	9262, 9538	1852.4, 1907.6	9.2.1.1, 9.2.1.2	Complies
	B5	Below 824 MHz, above 849 MHz	4132, 4233	826.4, 846.6	9.2.1.5, 9.2.1.6	Complies

9.2.1 WCDMA Test Plots

9.2.1.1 WCDMA B2 low channel, below 1850 MHz

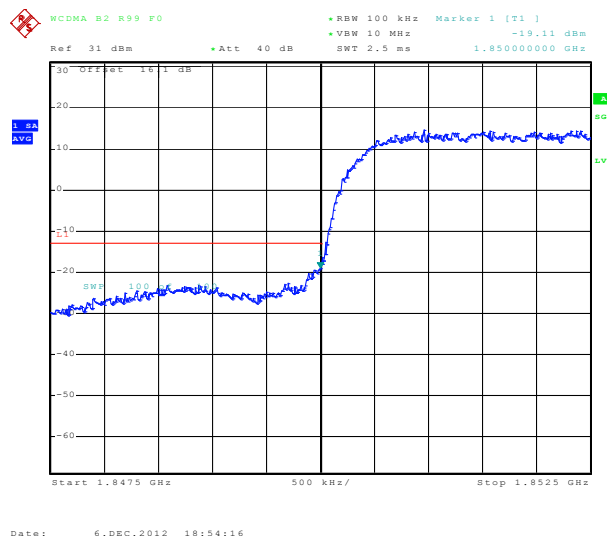

SIERRA WIRELESS, INC.

9.2.1.2 WCDMA B2 R99 F1, above 1910 MHz

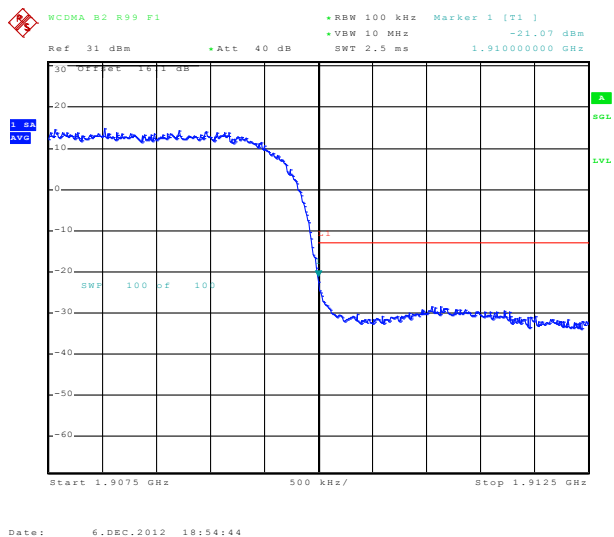

9.2.1.3 WCDMA B5 low channel, below 824 MHz

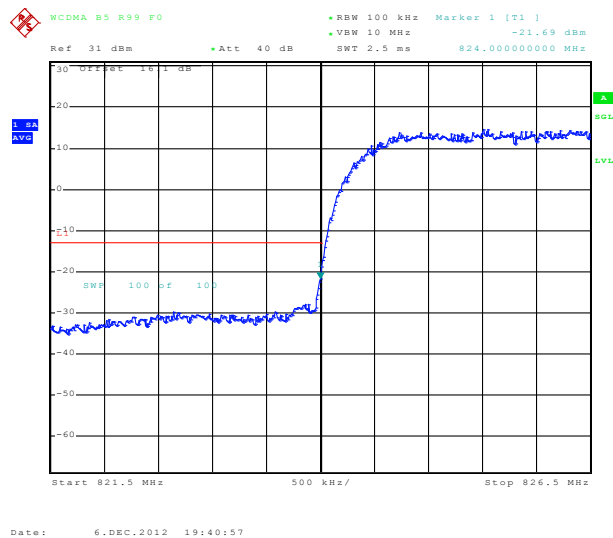

SIERRA WIRELESS, INC.

9.2.1.4 WCDMA B5 high channel, above 849 MHz

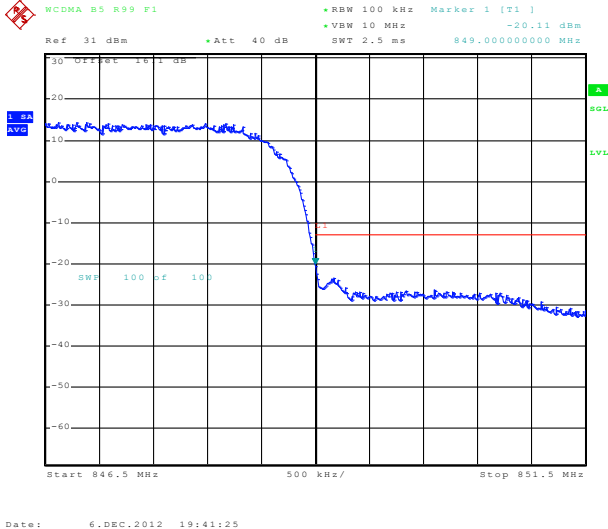

10 Frequency Stability versus Temperature

FCC 2.1055, FCC 22.355, FCC 24.235

10.1 Summary of Results

The EUT's Frequency Stability versus temperature meets the requirements of less than 2.5ppm when temperature varies from -30°C to +50°C.

10.2 Test Procedure

The EUT was placed inside a temperature chamber. The temperature was set to -30°C and maintained to stabilize. After sufficient soak time, the transmitting frequency error was measured. The temperature was then increased by 10 degrees, maintained to stabilize, and the measurement was repeated. This procedure was repeated until +50°C is reached. Frequency metering included internal averaging of the CMU200 to stabilize the reading. Reference power supply voltage for these tests is 3.3 volts. Refer to Test Setup 2.

10.3 Test Results

10.3.1 UMTS Frequency Error over Temperature

Temp (°C)	WCDMA R99 MODE			
	B2 (1900 MHz)		B5 (850 MHz)	
	Offset (Hz)	Offset (ppm)	Offset (Hz)	Offset (ppm)
-30	-3.4	-0.0018	2.1	0.0025
-20	-3.2	-0.0017	2.2	0.0026
-10	-3.6	-0.0019	2.1	0.0025
0	-1.9	-0.0010	1.7	0.0021
10	-1.8	-0.0009	2.2	0.0027
20	-1.6	-0.0008	1.8	0.0021
30	-0.4	-0.0002	0.7	0.0008
40	-0.1	-0.0001	2.1	0.0025
50	-0.2	-0.0001	2.4	0.0029

11 Frequency Stability versus Voltage

FCC 2.1055, FCC 22.355, FCC 24.235

11.1 Summary of Results

The EUT is specified to operate with a supply voltage varying between 3.0 VDC and 4.2 VDC, having a nominal voltage of 3.3 VDC. It meets the frequency stability limit of less than 2.5ppm when supply voltage varies within the specified limits. Operation above or below these voltage limits is prohibited by firmware in order to prevent improper operation.

SIERRA WIRELESS, INC.

FCC Part 22/24, RSS-132/133	MC/EM8805	Jan 14, 2013	Page 18 of 19
-----------------------------	-----------	--------------	---------------

11.2 Test Procedure

The EUT was connected to a DC Power Supply and a UMTS test set (CMU 200) with frequency error measurement capability. The power supply output was adjusted to the test voltage as measured at the input terminals to the device while transmitting. A voltmeter was used to confirm the terminal voltage. The peak frequency error is recorded (worst case). The test voltages are 3.0 volts to 4.2 volts. Refer to Test Setup 2.

11.3 Test Results

11.3.1 UMTS Frequency Error over Voltage

Voltage (V)	WCDMA R99 MODE			
	B2 (1900 MHz)		B5 (850 MHz)	
	Offset (Hz)	Offset (ppm)	Offset (Hz)	Offset (ppm)
3	1.7	0.0009	-1.4	-0.0016
3.3	1.2	0.0006	-2.3	-0.0027
4.2	1.7	0.0009	-1.5	-0.0018

12 Peak to Average Ratio

FCC 24.232

12.1 Summary of Results

The EUT meets the requirement of having a peak to average ratio of less than 13dB.

12.2 Test Procedure

The transmitter output was connected to a Rohde & Schwarz CMU200 through a coaxial RF cable and directional coupler, and configured to operate at maximum power. The peak to average ratio was measured at the required operating frequencies in each band on the Spectrum Analyzer. Refer to Test Setup 1.

12.3 Test Results

Band	Frequency (MHz)	Channel	Modulation	Plots	Peak to Average Ratio (dB)
B2	1880	9400	QPSK	12.3.1.1	3.40
B5	836.4	4182		12.3.1.2	3.14

12.3.1 Test Plots

12.3.1.1 WCDMA peak to average ratio, QPSK Band 2, Mid channel, 1880 MHz

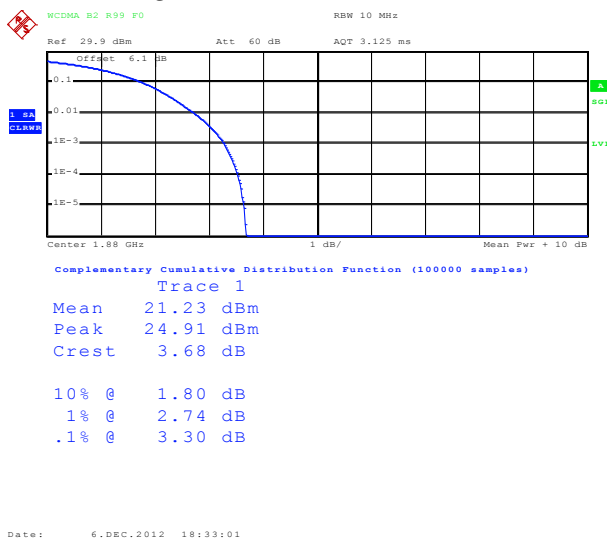

12.3.1.2 WCDMA peak to average ratio, QPSK Band 5, Mid channel, 836.4 MHz

