

FCC Part22H&24E Test Report

Industry Canada RSS-132/RSS-133

Product Name : GSM/GPRS/EDGE/HSDPA/HSUPA/
HSPA+/RELEASE 8 MODULE
Model No. : MC8801
FCC ID : N7NMC8801
IC : 2417C-MC8801

Applicant : Sierra Wireless Inc.
Address : 13811 Wireless Way Richmond, British Columbia
Canada, V6V 3A4.

Date of Receipt : Aug. 23, 2010
Test Date : Aug. 24, 2010 ~ Sep. 05, 2010
Issued Date : Dec. 07, 2010
Report No. : 108S040R-HP-US-P07V01
Report Version : V 8.0

The test results relate only to the samples tested.

The test results shown in the test report are traceable to the national/international standard through the calibration of the equipment and evaluated measurement uncertainty herein.

This report must not be used to claim product endorsement by TAF, NVLAP, NIST or any agency of the Government.

The test report shall not be reproduced except in full without the written approval of QuieTek Corporation.

Test Report Certification

Issued Date : Dec. 07, 2010

Report No. : 108S040R-HP-US-P07V01



Product Name : GSM/GPRS/EDGE/HSDPA/HSUPA/HSPA+/RELEASE 8
MODULE

Applicant : Sierra Wireless Inc.

Address : 13811 Wireless Way Richmond, British Columbia Canada,
V6V 3A4.

Model No. : MC8801

FCC ID : N7NMC8801

IC : 2417C-MC8801

EUT Voltage : HV: 3.6 / LV: 3.0 / Normal 3.3V

Trade Name : SIERRA WIRELESS

Applicable Standard : FCC CFR Title 47 Part 2, TIA/EIA 603-C, RSS-GEN Issue 2
FCC Part22 Subpart H, FCC Part24 Subpart E
Industry Canada RSS-132, Issue 2
Industry Canada RSS-133, Issue 5

Test Result : Complied

Performed Location : Suzhou EMC Laboratory
No.99 Hongye Rd., Suzhou Industrial Park Loufeng Hi-Tech
Development Zone., Suzhou, China
TEL: +86-512-6251-5088 / FAX: +86-512-6251-5098
FCC Registration Number: 800392; IC Lab Code: 4075B

Documented By : *Alice Ni*
(Engineering ADM: Alice Ni)

Reviewed By : *Marlin Chen*
(Engineering Supervisor: Marlin Chen)

Approved By : *Dream Cao*
(Engineering Manager: Dream Cao)

Laboratory Information

We, **Quietek Corporation**, are an independent EMC and safety consultancy that was established the whole facility in our laboratories. The test facility has been accredited/accepted(audited or listed) by the following related bodies in compliance with ISO 17025, EN 45001 and specified testing scope:

Taiwan R.O.C.	: BSMI, NCC, TAF
Germany	: TUV Rheinland
Norway	: Nemko, DNV
USA	: FCC, NVLAP
Japan	: VCCI

The related certificate for our laboratories about the test site and management system can be downloaded from Quietek Corporation's Web Site : <http://www.quietek.com/tw/ctg/cts/accreditations.htm>
 The address and introduction of Quietek Corporation's laboratories can be founded in our Web site : <http://www.quietek.com/>
 If you have any comments, Please don't hesitate to contact us. Our contact information is as below:

HsinChu Testing Laboratory :

No.75-2, 3rd Lin, Wangye Keng, Yonghxing Tsuen, Qionglin Shiang, Hsinchu County 307, Taiwan, R.O.C.
 TEL:+886-3-592-8858 / FAX:+886-3-592-8859 E-Mail : service@quietek.com



LinKou Testing Laboratory :

No. 5-22, Ruei-Shu Valley, Ruei-Ping Tsuen, Lin-Kou Shiang, Taipei, Taiwan, R.O.C.
 TEL : 886-2-8601-3788 / FAX : 886-2-8601-3789 E-Mail : service@quietek.com



Suzhou (China) Testing Laboratory :

No. 99 Hongye Rd., Suzhou Industrial Park Loufeng Hi-Tech Development Zone., Suzhou,China.
 TEL : +86-512-6251-5088 / FAX : +86-512-6251-5098 E-Mail : service@quietek.com



TABLE OF CONTENTS

Description	Page
1. General Information	6
1.1. EUT Description	6
1.2. Mode of Operation	7
1.3. Tested System Details	8
1.4. Configuration of Tested System	9
1.5. EUT Exercise Software	10
2. Technical Test	11
2.1. Summary of Test Result	11
2.2. Test Environment	12
3. Peak Output Power.....	13
3.1. Test Equipment	13
3.2. Test Setup	14
3.3. Limit	14
3.4. Test Procedure	15
3.5. Uncertainty	17
3.6. Test Result	18
4. Occupied Bandwidth.....	21
4.1. Test Equipment	21
4.2. Test Setup	21
4.3. Limit	22
4.4. Test Procedure	22
4.5. Uncertainty	22
4.6. Test Result	23
5. Spurious Emission At Antenna Terminals (+/- 1MHz).....	43
5.1. Test Equipment	43
5.2. Test Setup	43
5.3. Limit	44
5.4. Test Procedure	44
5.5. Uncertainty	44
5.6. Test Result	45
6. Spurious Emission	55
6.1. Test Equipment	55
6.2. Test Setup	56
6.3. Limit	56
6.4. Test Procedure	57
6.5. Uncertainty	58

6.6.	Test Result	59
7.	Frequency Stability Under Temperature & Voltage Variations	69
7.1.	Test Equipment	69
7.2.	Test Setup	69
7.3.	Limit	70
7.4.	Test Procedure	70
7.5.	Uncertainty	70
7.6.	Test Result	71
8.	Receiver Spurious Emission for RSS 132/133.....	81
8.1.	Test Equipment	81
8.2.	Test Setup	82
8.3.	Limit	83
8.4.	Test Procedure	83
8.5.	Uncertainty	84
8.6.	Test Result	85
9.	Appendix 1 – Test Setup Photograph	101

1. General Information

1.1. EUT Description

Product Name		GSM/GPRS/EDGE/HSDPA/HSUPA/ HSPA+/RELEASE 8 MODULE		
Brand Name		Sierra		
Model No.		MC8801		
Working Voltage		DC 3.3V		
Mode	GPRS/EDGE	Band	UL Frequency (MHz)	DL Frequency (MHz)
		850	824~849	869~894
	1900	1850~1910	1930~1990	
	WCDMA R99 HSDPA R5 HSUPA R6	Band	UL Frequency (MHz)	DL Frequency (MHz)
		II	1850~1910	1930~1990
		V	824~849	869~894
Channel Control		Auto		

1.2. Mode of Operation

Quietek has verified the construction and function in typical operation. All the test modes were carried out with the EUT in normal operation, which was shown in this test report and defined as:

Test Mode
Mode 1: GPRS850
Mode 2: GPRS1900
Mode 3: EDGE850
Mode 4: EDGE1900
Mode 5: WCDMA Band II
Mode 6: WCDMA Band V
Mode 7: HSDPA Band II
Mode 8: HSDPA Band V
Mode 9: HSUPA Band II
Mode 10: HSUPA Band V

1.3. Tested System Details

The types for all equipments, plus descriptions of all cables used in the tested system (including inserted cards) are:

Product		Manufacturer	Model No.	Serial No.	Power Cord
1	CMU200	R&S	CMU200	N/A	N/A

1.4. Configuration of Tested System

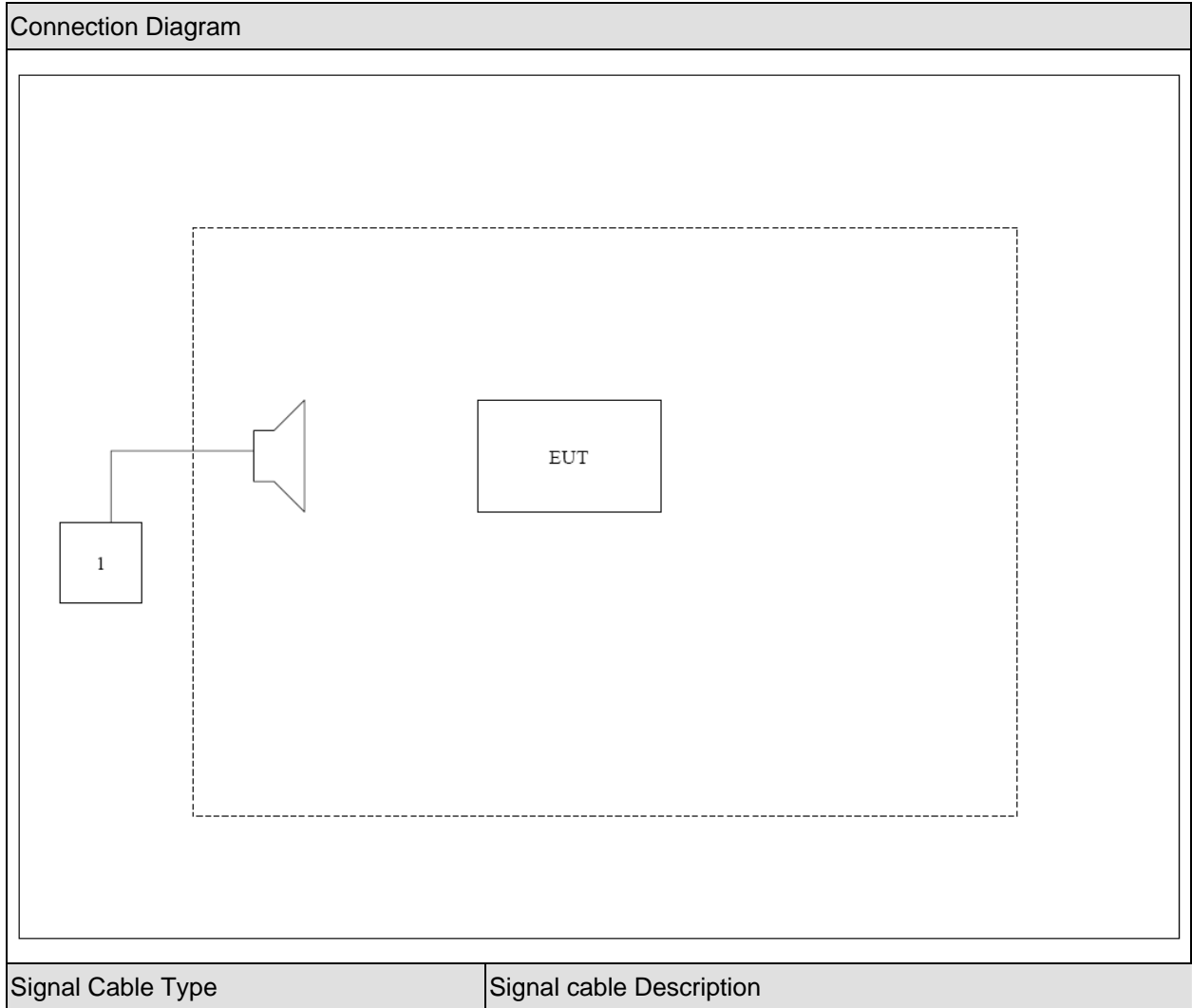

1.5. EUT Exercise Software

1	Setup the EUT and simulators as shown on above.
2	Turn on the power of all equipment.
3	EUT Communicate with CMU200, then select channel to test.

2. Technical Test

2.1. Summary of Test Result

- No deviations from the test standards
- Deviations from the test standards as below description:

For GSM850, and WCDMA Band V (FCC Part 22H & Part 2)

Performed Item	Section in CFR 47	Section in RSS GEN or RSS-132	Test Performed	Deviation
Peak Output Power	FCC Part 22.913(a)(2) and Part 2.1046	4.4	Yes	No
Modulation Characteristic	FCC Part 2.1047(d)	4.2	Yes	No
Occupied Bandwidth	FCC Part 2.1049	RSS GEN 4.6	Yes	No
Spurious Emission At Antenna Terminals (+/- 1MHz)	FCC Part 22.917(a) and Part 2.1049	4.5	Yes	No
Spurious Emission	FCC Part 22.917(b) and Part 2.1051, 2.1053	4.5, 4.6	Yes	No
Frequency Stability Under Temperature & Voltage Variations	FCC Part 22.355 and 2.1055	4.3	Yes	No

For PCS1900, and WCDMA Band II (FCC Part 24E & Part 2)

Performed Item	Section in CFR 47	Section in RSS GEN or RSS-133	Test Performed	Deviation
Peak Output Power	FCC Part 24.232(b) and Part 2.1046	6.4	Yes	No
Modulation Characteristic	FCC Part 2.1047(d)	6.2	Yes	No
Occupied Bandwidth	FCC Part 24.238(b) and Part 2.1049	RSS GEN 4.6	Yes	No
Spurious Emission At Antenna Terminals (+/- 1MHz)	FCC Part 24.238(a) and Part 2.1049	6.5	Yes	No
Spurious Emission	FCC Part 24.238(b) and Part 2.1051, 2.1053	6.5, 6.6	Yes	No
Frequency Stability Under Temperature & Voltage Variations	FCC Part 24.235 and 2.1055	6.3	Yes	No

2.2. Test Environment

Items	Required (IEC 68-1)	Actual
Temperature (°C)	15-35	23
Humidity (%RH)	25-75	52
Barometric pressure (mbar)	860-1060	950-1000

3. Peak Output Power

3.1. Test Equipment

Peak Output Power / AC-5

Instrument	Manufacturer	Type No.	Serial No	Cal. Date
PSA Series Spectrum Analyzer	Agilent	E4440A	MY49420184	2010.04.10
Radio Communication Tester	R&S	CMU 200	117088	2010.07.12
Dual Directional Coupler	Agilent	778D	20160	2010.04.20
10dB Coaxial Coupler	Agilent	87300C	MY44300299	2010.04.20
PSG Analog Signal Generator	Agilent	E8257D	MY44321116	2010.04.23
Preamplifier	QuieTek	AP-025C	CHM-0503006	2010.05.05
Preamplifier	Miteq	NSP1800-25	1364185	2010.05.05
Bilog Antenna	Teseq GmbH	CBL6112D	27612	2009.11.12
Half Wave Tuned Dipole Antenna	COM-POWER	AD-100	40137	2009.11.24
Broad-Band Horn Antenna	Schwarzbeck	BBHA9120D	737	2009.11.24
Broad-Band Horn Antenna	Schwarzbeck	BBHA9120D	499	2010.06.11
Temperature/Humidity Meter	Zhicheng	ZC1-2	AC5-TH	2010.01.14

3.2. Test Setup

Conducted Power Measurement:

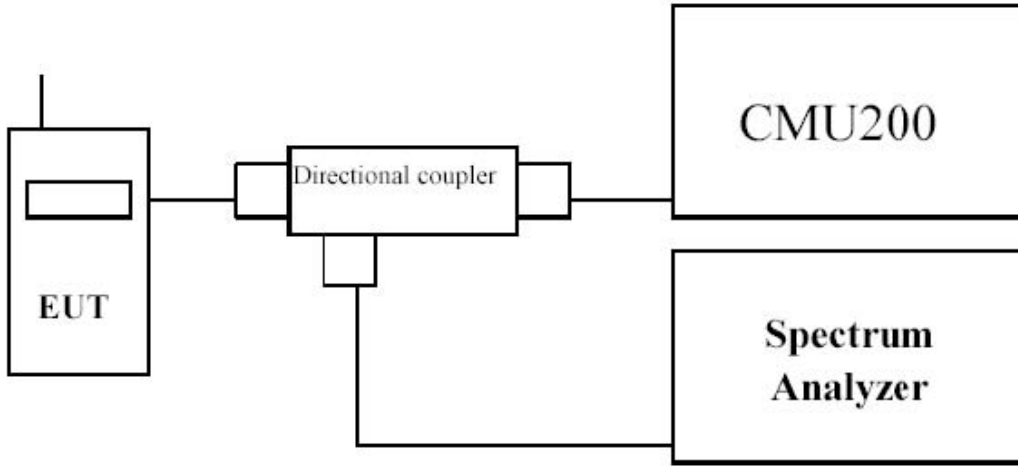

Radiated Power Measurement:

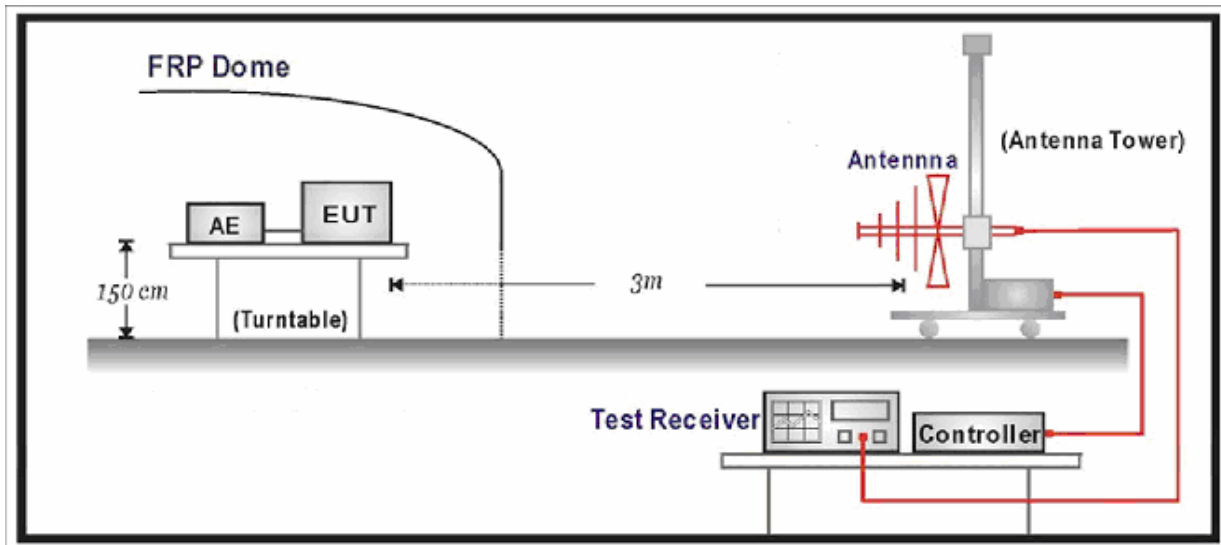

3.3. Limit

For FCC Part 22.913(a)(2):

The ERP of mobile transmitters and auxiliary test transmitters must not exceed 7 Watts.

For FCC Part 24.232(b):

The EIRP of mobile transmitters and auxiliary test transmitters must not exceed 2 Watts.

3.4. Test Procedure

Conducted Power Measurement:

- a) Place the EUT on a bench and set it in transmitting mode.
- b) Connect a low loss RF cable from the antenna port to a spectrum analyzer and CMU200 by a Directional Couple.
- c) EUT Communicate with CMU200, then selects a channel for testing.
- d) Add a correction factor to the display of spectrum, and then test.

Radiated Power Measurement:

- e) The EUT shall be placed at the specified height on a support, and in the position closest to normal use as declared by provider.
- f) The test antenna shall be oriented initially for vertical polarization and shall be chosen to correspond to the frequency of the transmitter
- g) The output of the test antenna shall be connected to the measuring receiver.
- h) The transmitter shall be switched on and the measuring receiver shall be tuned to the frequency of the transmitter under test.
- i) The test antenna shall be raised and lowered through the specified range of height until a maximum signal level is detected by the measuring receiver.
- j) The transmitter shall then be rotated through 360° in the horizontal plane, until the maximum signal level is detected by the measuring receiver.
- k) The test antenna shall be raised and lowered again through the specified range of height until a maximum signal level is detected by the measuring receiver.
- l) The maximum signal level detected by the measuring receiver shall be noted.
- m) The transmitter shall be replaced by a substitution antenna.
- n) The substitution antenna shall be orientated for vertical polarization and the length of the substitution antenna shall be adjusted to correspond to the frequency of the transmitter.
- o) The substitution antenna shall be connected to a calibrated signal generator.
- p) If necessary, the input attenuator setting of the measuring receiver shall be adjusted in order to increase the sensitivity of the measuring receiver.
- q) The test antenna shall be raised and lowered through the specified range of height to ensure that the maximum signal is received.
- r) The input signal to the substitution antenna shall be adjusted to the level that produces a level detected by the measuring receiver, that is equal to the level noted while the transmitter radiated power was measured, corrected for the change of input attenuator setting of the measuring receiver.
- s) The measurement shall be repeated with the test antenna and the substitution antenna orientated for horizontal polarization.

- t) The measure of the effective radiated power is the larger of the two levels recorded at the input to the substitution antenna, corrected for gain of the substitution antenna if necessary.

Base station simulator settings for each test mode:

1. For GSM/GPRS/EDGE

Configure R&S CMU200 to support GMSK and 8PSK call respectively, and set one timeslot transmission for GMSK GSM/GPRS and 8PSK EDGE.

Measure and record power outputs for both modulations.

2. For WCDMA/HSDPA

Configure the CMU-200 to support all WCDMA tests in respect to the 3GPP 34.121.

Measure the EUT output power at 826.4MHz, 836.6MHz and 846.6MHz for WCDMA Band V and 1852.4MHz, 1880MHz and 1907.6MHz for WCDMA Band II.

For Rel 99

- Set a Test Mode 1 loop back with a 12.2kbps Reference Measurement Channel (RMC)
- Set and send continuously Up power control commands to the Gobi2000
- Measure the power at the Gobi2000 Module antenna connector by using CMU-200.

For HSDPA Rel 5

- Establish a Test Mode 1 look back with both 12.2kbps RMC channel and a H-Set1 Fixed Reference Channel (FRC). With the CMU-200 this is accomplished by setting the signal Channel Coding to “Fixed Reference Channel” and configuring for HSET-1 QKSP.
- Set beta values and HSDPA settings for HSDPA Subtest1 according to Table C.10.1.4
- Send continuously Up power control commands to the Gobi2000
- Measure the power at the Gobi2000 Module antenna connector by using CMU-200 mean power.
- The mean power shall be averaged over at least one timeslot.
- Repeat the measurement for the HSDPA Subtest2, 3 and 4 as given in Table C.10.1.4

3GPP HSDPA Sub-test Setting from TS 34 121

Table C.10.1.4: β values for transmitter characteristics tests with HS-DPCCH

Sub-test	β_c	β_d	β_c/β_d	β_{HS}	CM (dB)	MPR (dB)
1	2/15	15/15	2/15	4/15	0.0	0.0
2	12/15	15/15	12/15	24/15	1.0	0.0
3	15/15	8/15	15/8	30/15	1.5	0.5
4	15/15	4/15	15/4	30/15	1.5	0.5

3GPP HSUPA Sub-test Setting from TS 34 121

Table C.11.1.3: β values for transmitter characteristics tests with HS-DPCCH and E-DCH

Sub-test	β_c	β_d	β_c/β_d	β_{HS}	β_{ec}	β_{ed}	CM (dB)	MPR (dB)	AG Index	E-TFCI
1	11/15	15/15	11/15	22/15	209/225	1309/225	1.0	0.0	20	75
2	6/15	15/15	6/15	12/15	12/15	94/75	3.0	2.0	12	67
3	15/15	9/15	15/9	30/15	30/15	47/15	2.0	1.0	15	92
4	2/15	15/15	2/15	4/15	2/15	56/75	3.0	2.0	17	71
5	15/15	15/15	15/15	30/15	24/15	134/15	1.0	0.0	21	81

HSUPA Reference E-TFCIs

Subtest	1,2,4,5				
Number of Ref. ETFCIs	5				
Reference of E-TFCI	11	67	71	75	81
Ref. E-TFCI Power Offset	4	18	23	26	27

HSUPA Reference E-TFCIs

Subtest	3	
Number of Ref. ETFCIs	2	
Reference of E-TFCI	11	92
Ref. E-TFCI Power Offset	4	18

3.5. Uncertainty

The measurement uncertainty is defined as for Conducted Power Measurement ± 1.2 dB, for Radiated Power Measurement ± 3.2 dB

3.6. Test Result

GSM/GPRS/EDGE

GPRS 850

Channel No.	Frequency (MHz)	Modulation	Conducted Output Power (dBm)
128	824.2	GMSK	32.88
189	836.4	GMSK	32.90
251	848.8	GMSK	32.91

GPRS1900

Channel No.	Frequency (MHz)	Modulation	Conducted Output Power (dBm)
512	1850.2	GMSK	29.56
661	1880.0	GMSK	29.45
810	1909.8	GMSK	29.31

EDGE 850

Channel No.	Frequency (MHz)	Modulation	Conducted Output Power (dBm)
128	824.2	8PSK	27.11
189	836.4	8PSK	26.97
251	848.8	8PSK	27.02

EDGE 1900

Channel No.	Frequency (MHz)	Modulation	Conducted Output Power (dBm)
512	1850.2	8PSK	25.31
661	1880.0	8PSK	25.02
810	1909.8	8PSK	25.01

Note: All conducted measurements are based on a peak detector.

WCDMA/HSDPA/HSUPA

Mode	3GPP Subtest	Band II (1900MHz) Channel			MPR
		Conducted Power (dBm)			
		9262	9400	9538	
WCDMA R99	1	23.51	23.43	23.45	N/A
Rel5 HSDPA	1	23.10	22.55	22.48	0
	2	22.90	22.19	22.22	0
	3	22.25	21.56	21.62	0.5
	4	22.28	21.60	21.67	0.5
Rel6 HSUPA	1	22.46	21.71	21.64	0.0
	2	22.09	22.33	22.31	2.0
	3	22.04	21.77	21.78	1.0
	4	22.71	21.86	21.92	2.0
	5	22.37	21.80	21.72	0.0

Mode	3GPP Subtest	Band V (850MHz) Channel			MPR
		Conducted Power (dBm)			
		4132	4182	4233	
WCDMA R99	1	23.87	23.50	24.37	N/A
Rel5 HSDPA	1	23.26	23.24	23.40	0
	2	23.13	22.93	23.14	0
	3	22.50	22.42	22.67	0.5
	4	22.49	22.39	22.54	0.5
Rel6 HSUPA	1	23.41	22.83	23.76	0.0
	2	23.13	22.31	22.57	2.0
	3	22.52	22.14	22.74	1.0
	4	23.50	23.10	22.89	2.0
	5	22.72	22.51	23.43	0.0

Note: All conducted measurements are based on an average detector.

4. Occupied Bandwidth

4.1. Test Equipment

Occupied Bandwidth / AC-6

Instrument	Manufacturer	Type No.	Serial No	Cal. Date
PSA Series Spectrum Analyzer	Agilent	E4440A	MY49420184	2010.04.10
Radio Communication Tester	R&S	CMU 200	117088	2010.07.12
Dual Directional Coupler	Agilent	778D	20160	2010.04.20
10dB Coaxial Coupler	Agilent	87300C	MY44300299	2010.04.20
Temperature/Humidity Meter	Zhicheng	ZC1-2	AC6-TH	2010.01.14

4.2. Test Setup

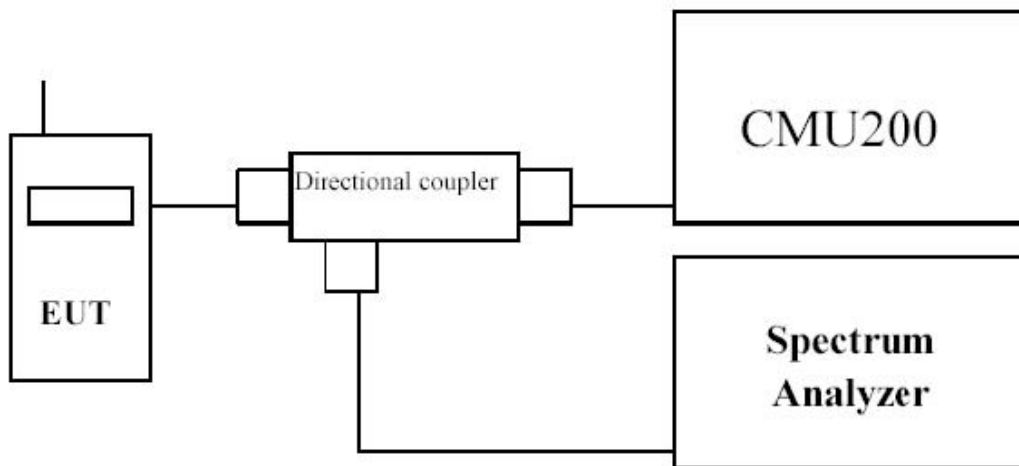

4.3. Limit

N/A

4.4. Test Procedure

Using Occupied Bandwidth measurement function of spectrum analyzer, and setting as follows:

For GPRS/EDGE 850/1900 test --- RBW = 3 kHz and VBW = 10 kHz

For WCDMA/HSDPA FDD Band II/V test --- RBW = 50 kHz and VBW = 200 kHz

4.5. Uncertainty

The measurement uncertainty is defined as ± 10 Hz

4.6. Test Result

Product	GSM/GPRS/EDGE/HSDPA/HSUPA/HSPA+/RELEASE 8 MODULE		
Test Item	Occupied Bandwidth		
Test Mode	Mode 1: GSM850 GPRS Link		
Date of Test	2010/09/03	Test Site	AC-6

Channel No.	Frequency (MHz)	-26dB Occupied Bandwidth (kHz)	99% Occupied Bandwidth (kHz)
128	824.20	310.55	241.40
189	836.40	316.12	240.30
251	848.80	314.11	243.53

Figure Channel 128 (824.20MHz)

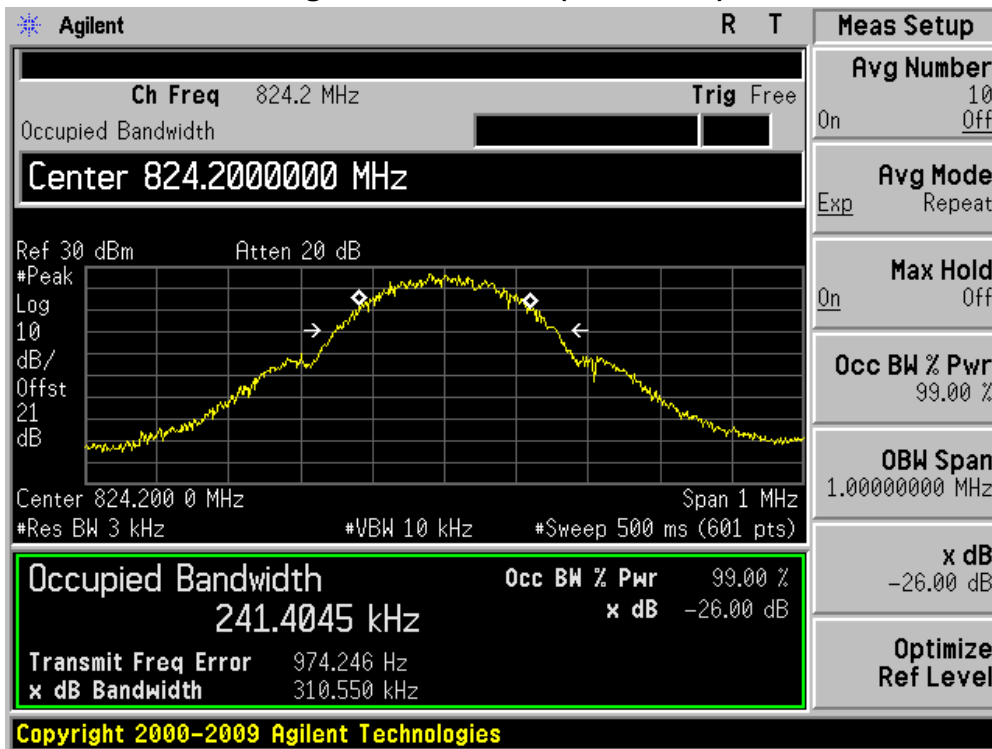

Figure Channel 189 (836.40MHz)

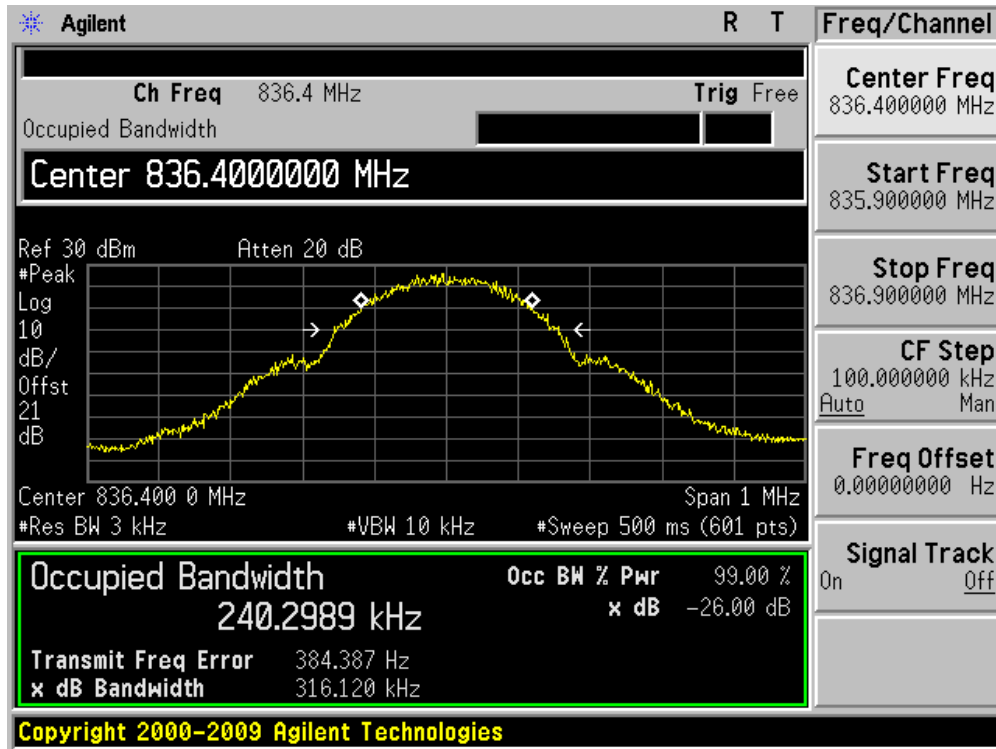
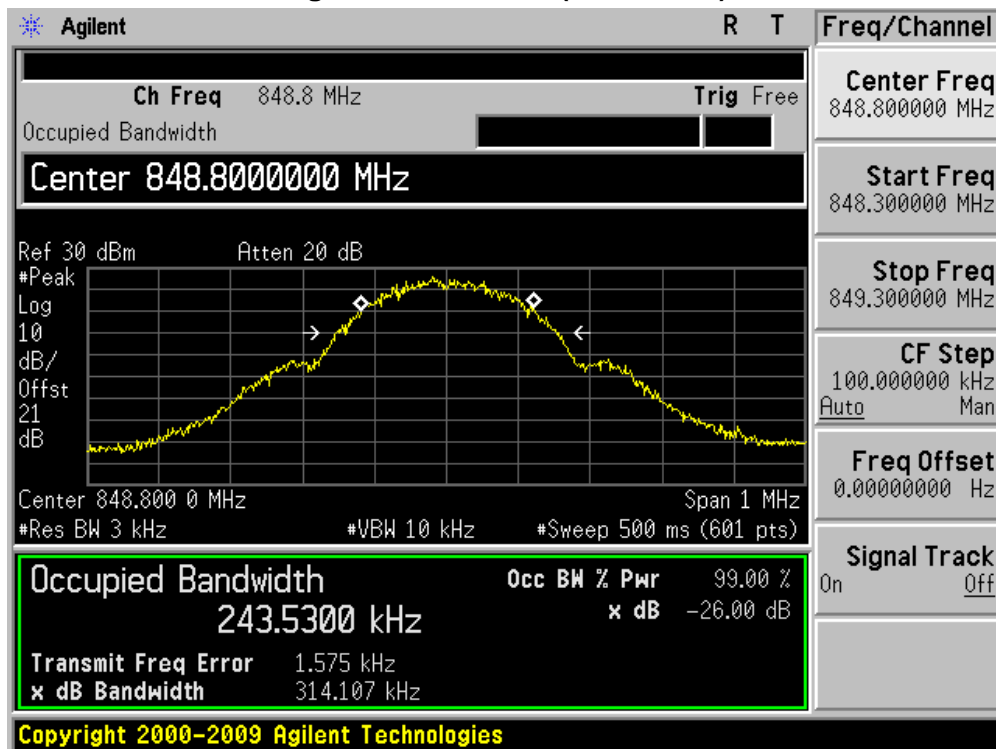

Figure Channel 251 (848.80MHz)



Product	GSM/GPRS/EDGE/HSDPA/HSUPA/HSPA+/RELEASE 8 MODULE		
Test Item	Occupied Bandwidth		
Test Mode	Mode 2: PCS1900 GPRS Link		
Date of Test	2010/09/03	Test Site	AC-6

Channel No.	Frequency (MHz)	-26dB Occupied Bandwidth (kHz)	99% Occupied Bandwidth (kHz)
512	1850.20	315.34	243.44
661	1880.00	313.38	243.34
810	1909.80	315.11	244.67

Figure Channel 512 (1850.20MHz)

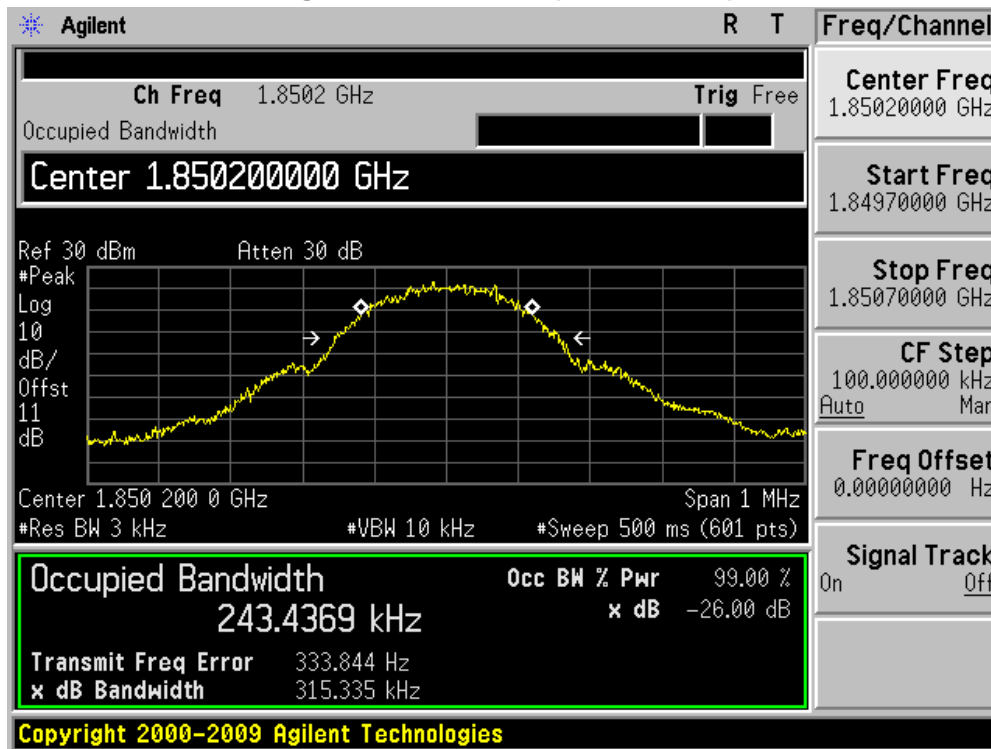

Figure Channel 661 (1880.00MHz)

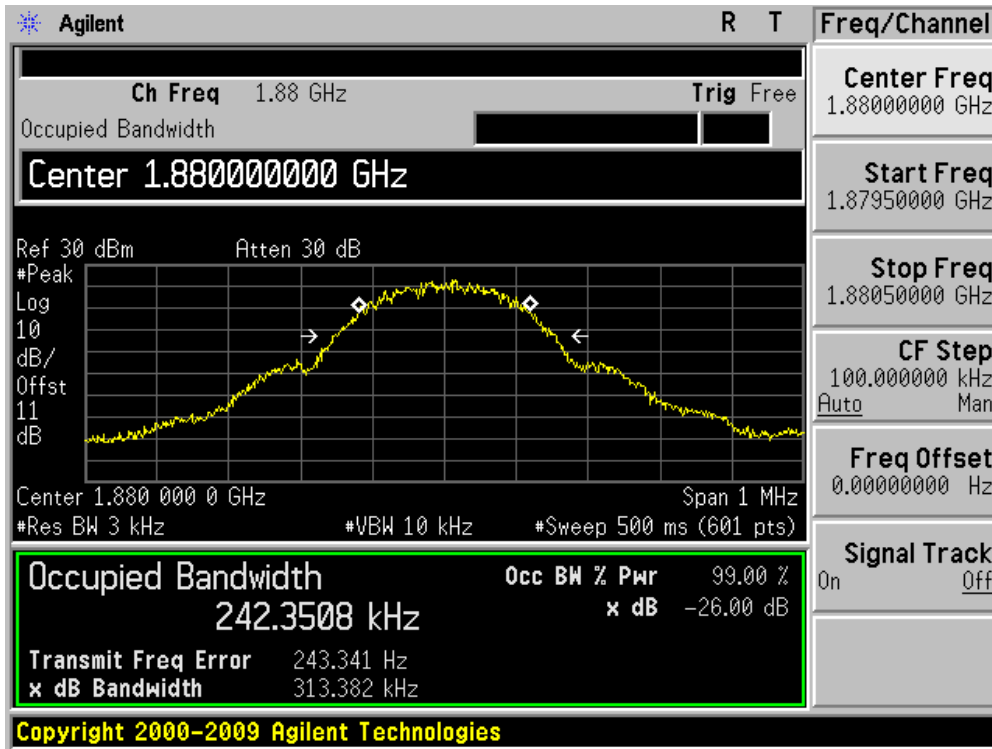

Figure Channel 810 (1909.80MHz)



Product	GSM/GPRS/EDGE/HSDPA/HSUPA/HSPA+/RELEASE 8 MODULE		
Test Item	Occupied Bandwidth		
Test Mode	Mode 3: GSM850 EDGE Link		
Date of Test	2010/09/03	Test Site	AC-6

Channel No.	Frequency (MHz)	-26dB Occupied Bandwidth (kHz)	99% Occupied Bandwidth (kHz)
128	824.20	305.06	247.40
189	836.40	304.61	245.74
251	848.80	309.14	247.79

Figure Channel 128 (824.20MHz)

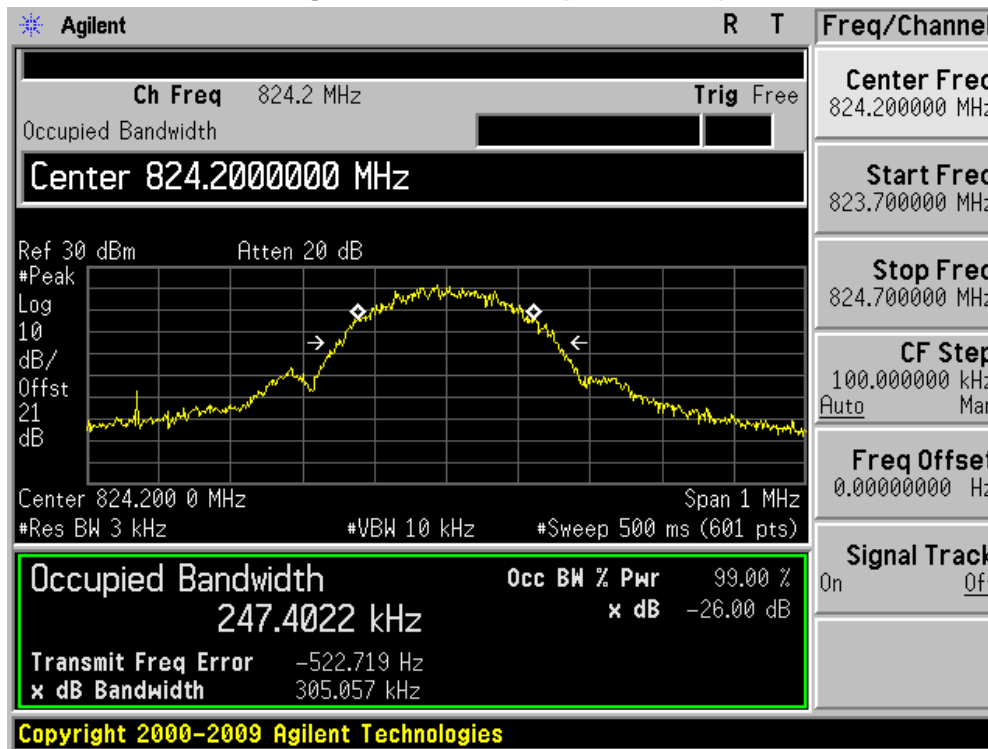

Figure Channel 189 (836.40MHz)

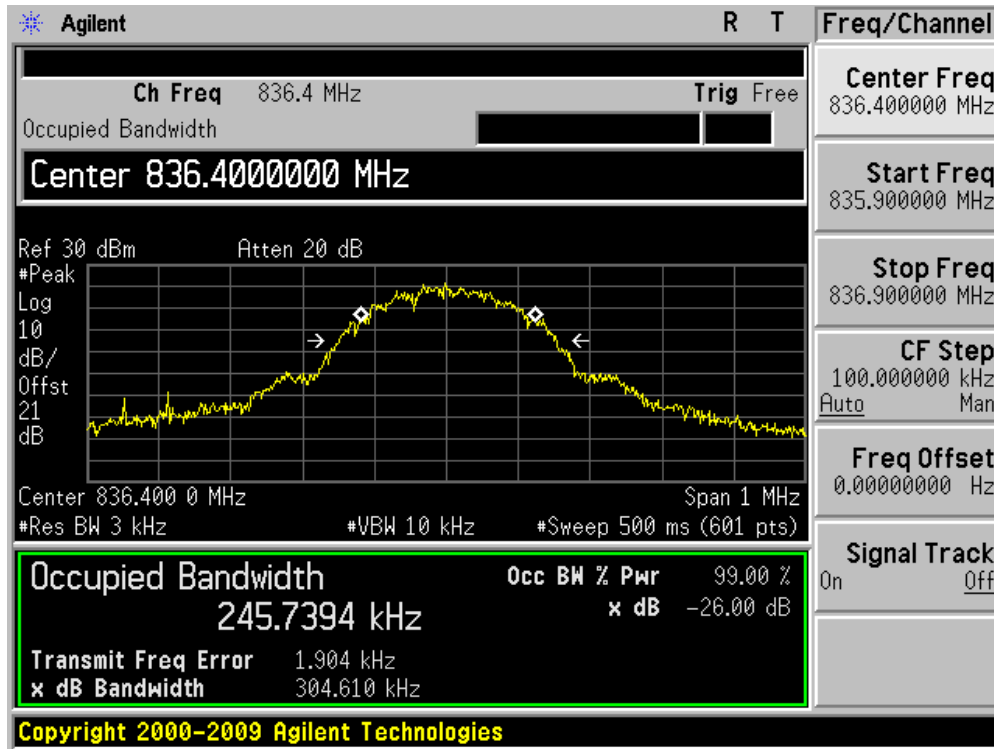
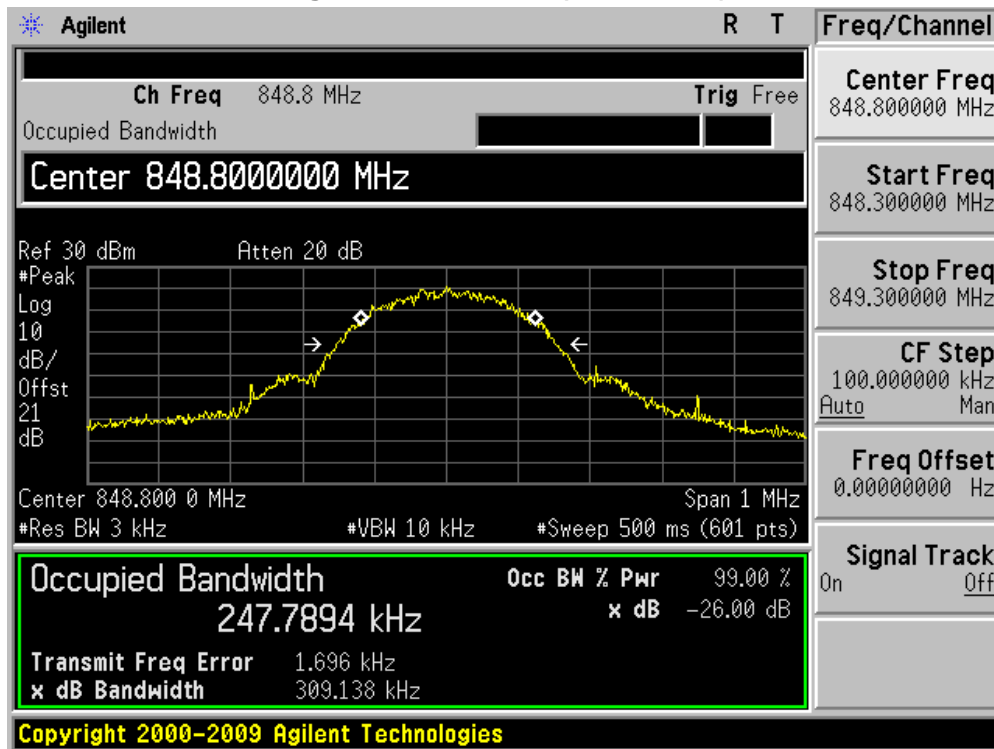

Figure Channel 251 (848.80MHz)



Product	GSM/GPRS/EDGE/HSDPA/HSUPA/HSPA+/RELEASE 8 MODULE		
Test Item	Occupied Bandwidth		
Test Mode	Mode 4: PCS1900 EDGE Link		
Date of Test	2010/09/03	Test Site	AC-6

Channel No.	Frequency (MHz)	-26dB Occupied Bandwidth (kHz)	99% Occupied Bandwidth (kHz)
512	1850.20	312.30	240.15
661	1880.00	313.26	240.96
810	1909.80	311.63	244.10

Figure Channel 512 (1850.20MHz)

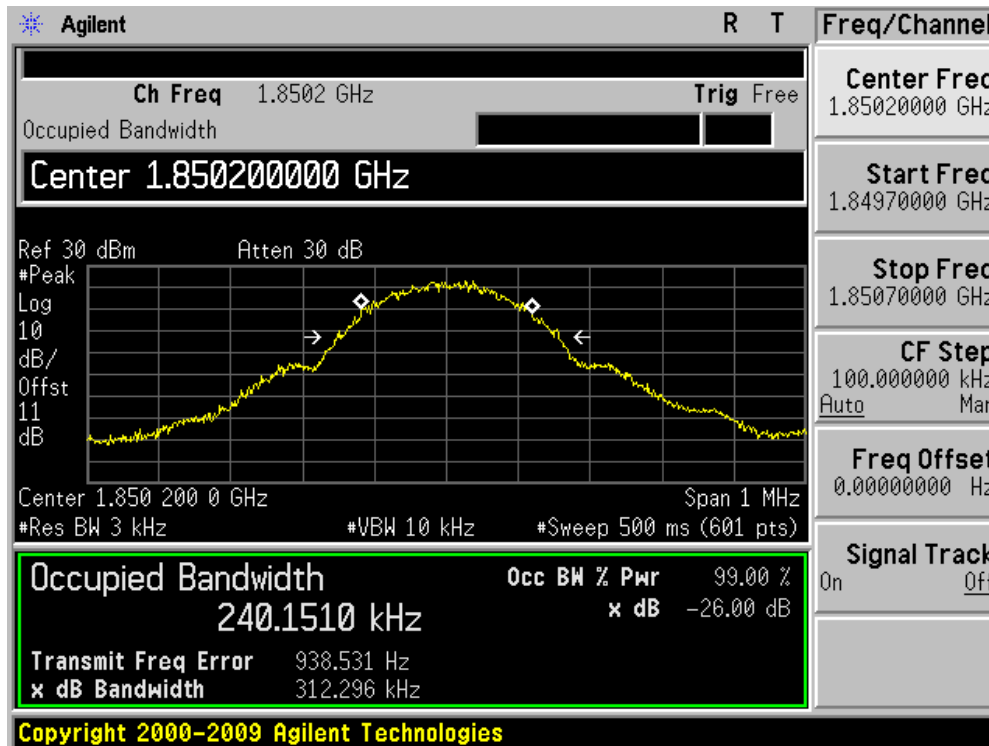

Figure Channel 661 (1880.00MHz)

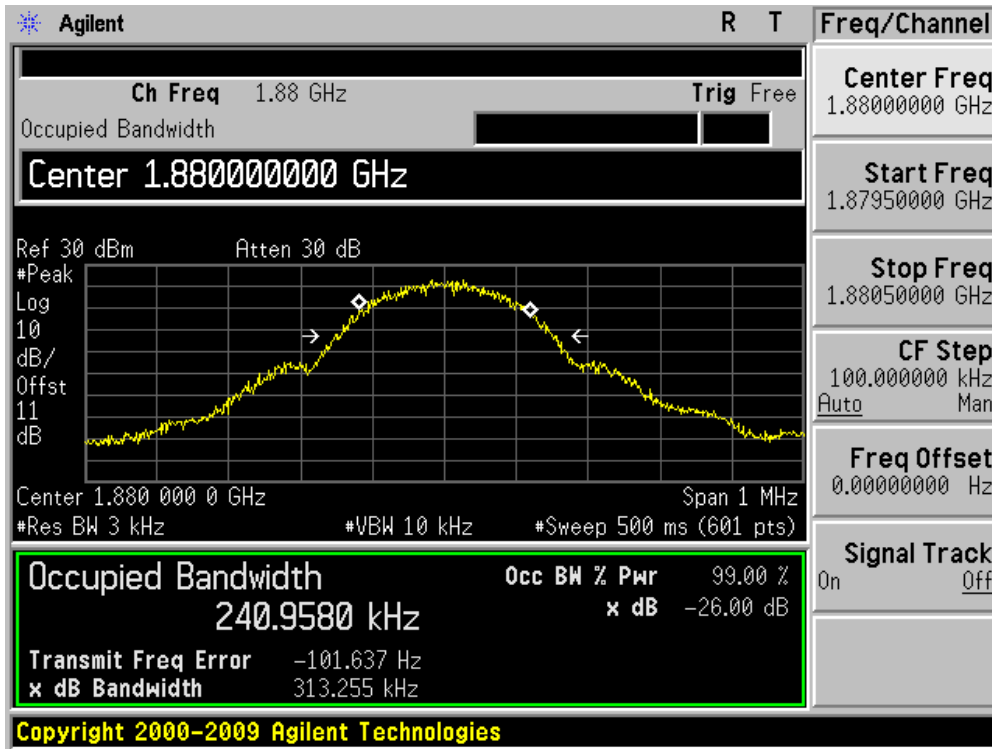
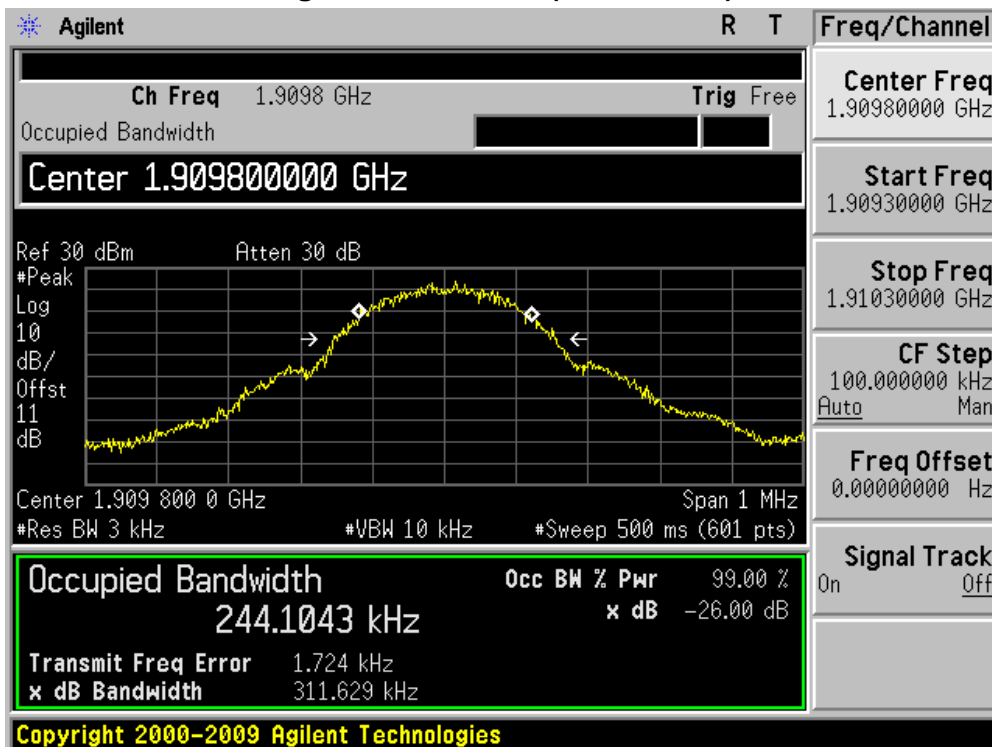

Figure Channel 810 (1909.80MHz)



Product	GSM/GPRS/EDGE/HSDPA/HSUPA/HSPA+/RELEASE 8 MODULE		
Test Item	Occupied Bandwidth		
Test Mode	Mode 5: WCDMA Band II Link		
Date of Test	2010/09/03	Test Site	AC-6

Channel No.	Frequency (MHz)	-26dB Occupied Bandwidth (MHz)	99% Occupied Bandwidth (MHz)
9262	1852.4	4.632	4.1390
9400	1880.0	4.638	4.1295
9538	1907.6	4.638	4.1299

Figure Channel 9262 (1852.4MHz)

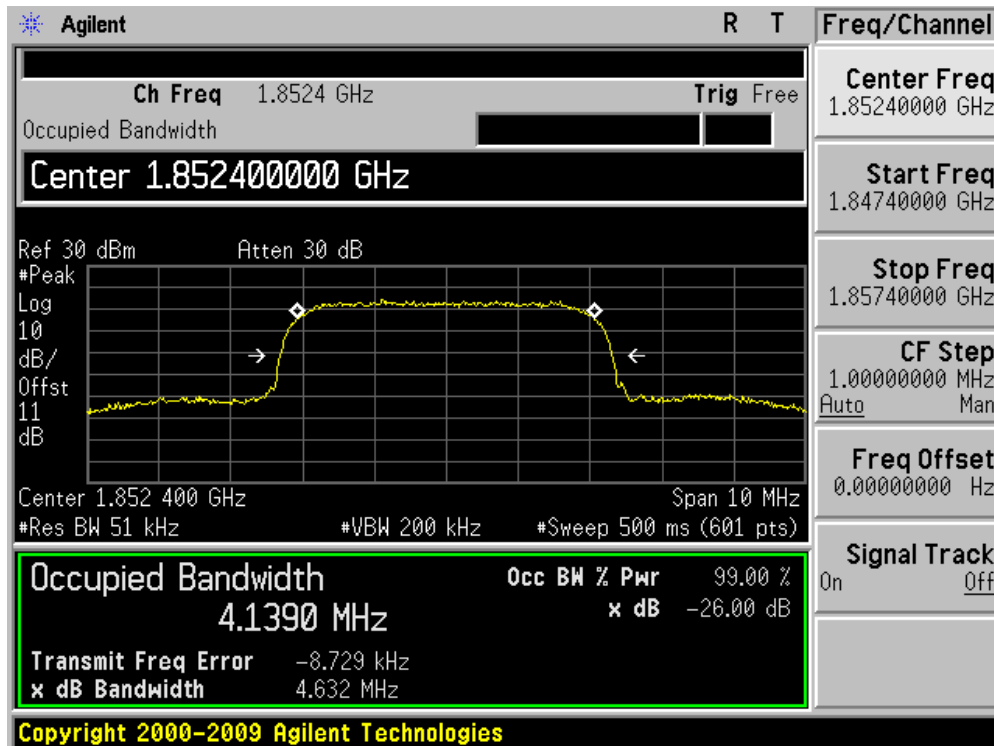

Figure Channel 9400 (1880.0MHz)

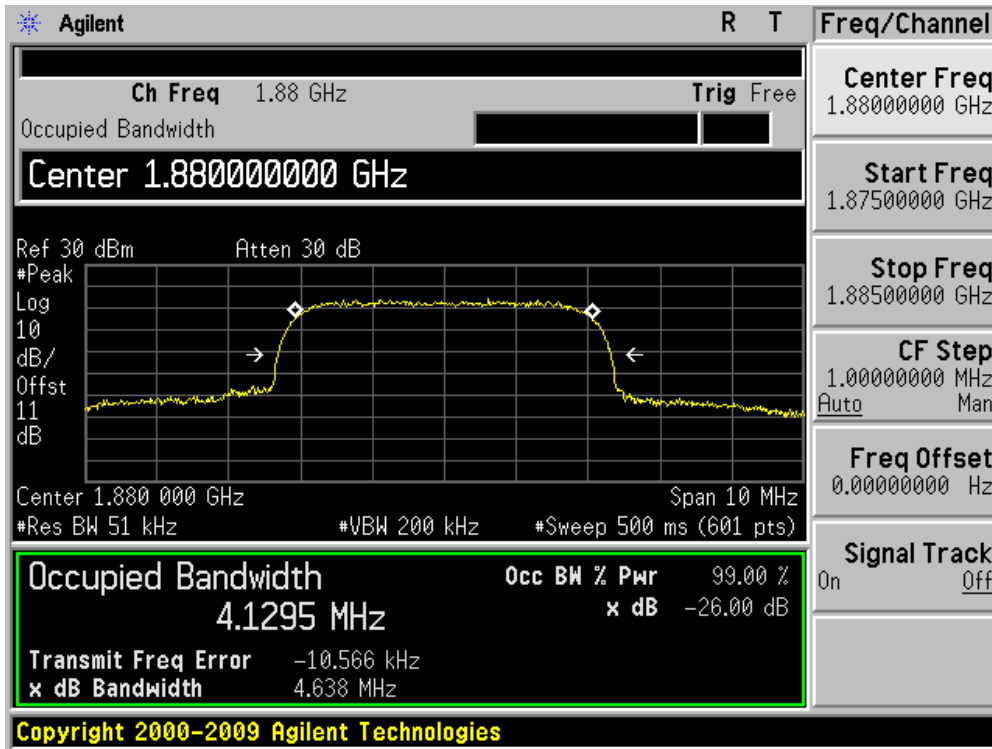
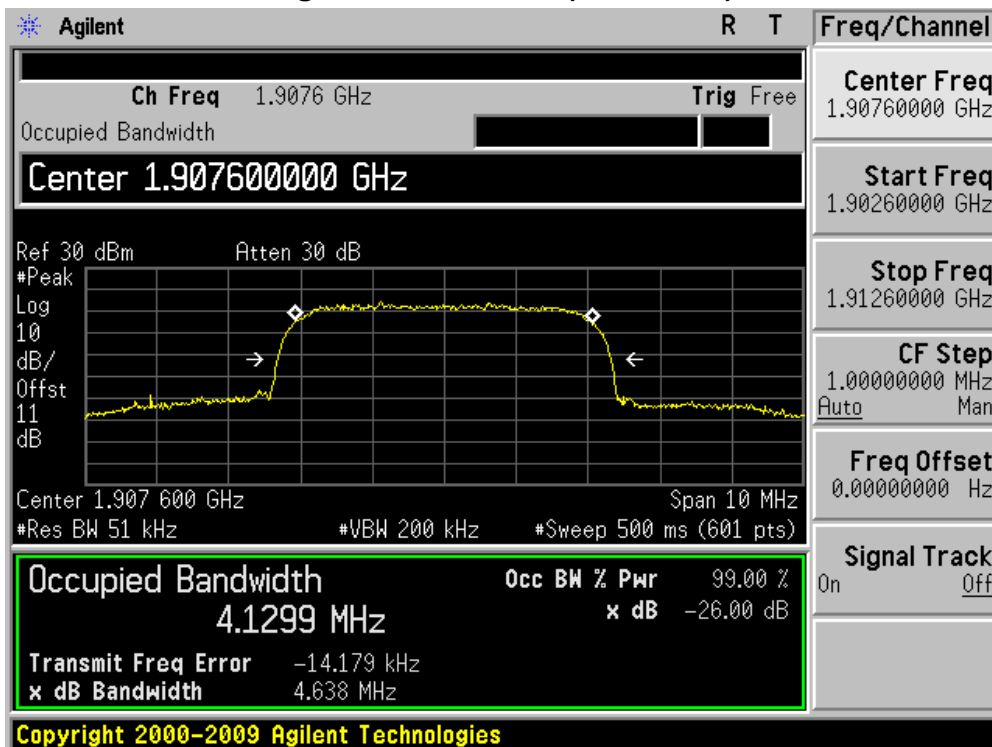

Figure Channel 9538 (1907.6MHz)



Product	GSM/GPRS/EDGE/HSDPA/HSUPA/HSPA+/RELEASE 8 MODULE		
Test Item	Occupied Bandwidth		
Test Mode	Mode 6: WCDMA Band V Link		
Date of Test	2010/09/03	Test Site	AC-6

Channel No.	Frequency (MHz)	-26dB Occupied Bandwidth (MHz)	99% Occupied Bandwidth (MHz)
4132	826.4	4.603	4.1246
4182	836.4	4.623	4.1261
4233	846.6	4.626	4.1269

Figure Channel 4132 (826.4MHz)

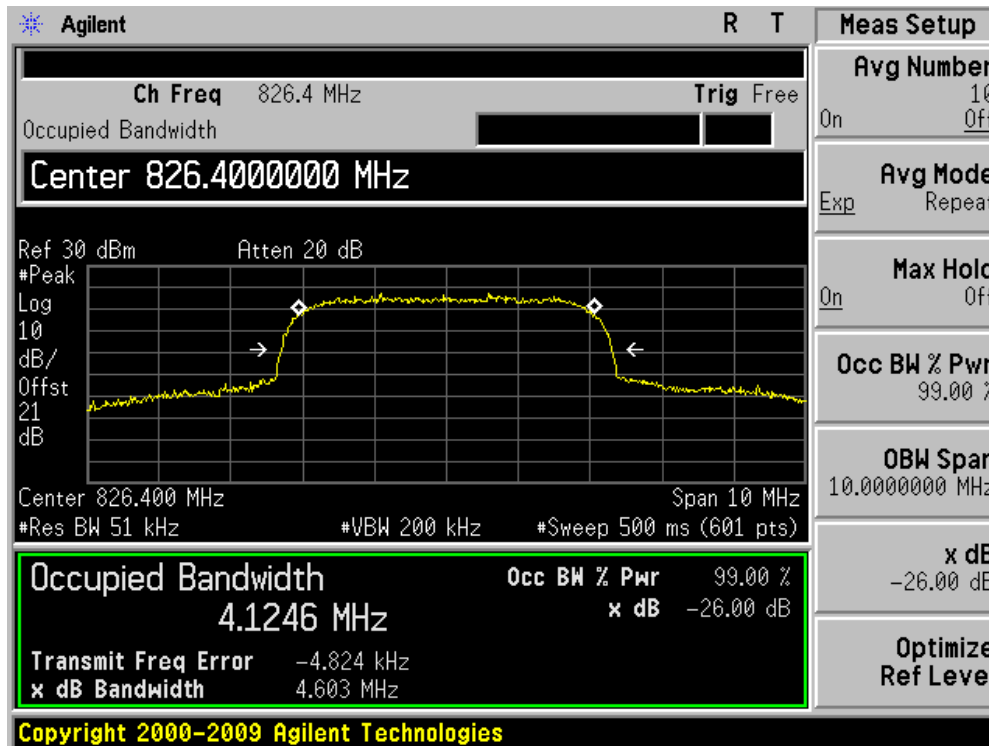

Figure Channel 4182 (836.40MHz)

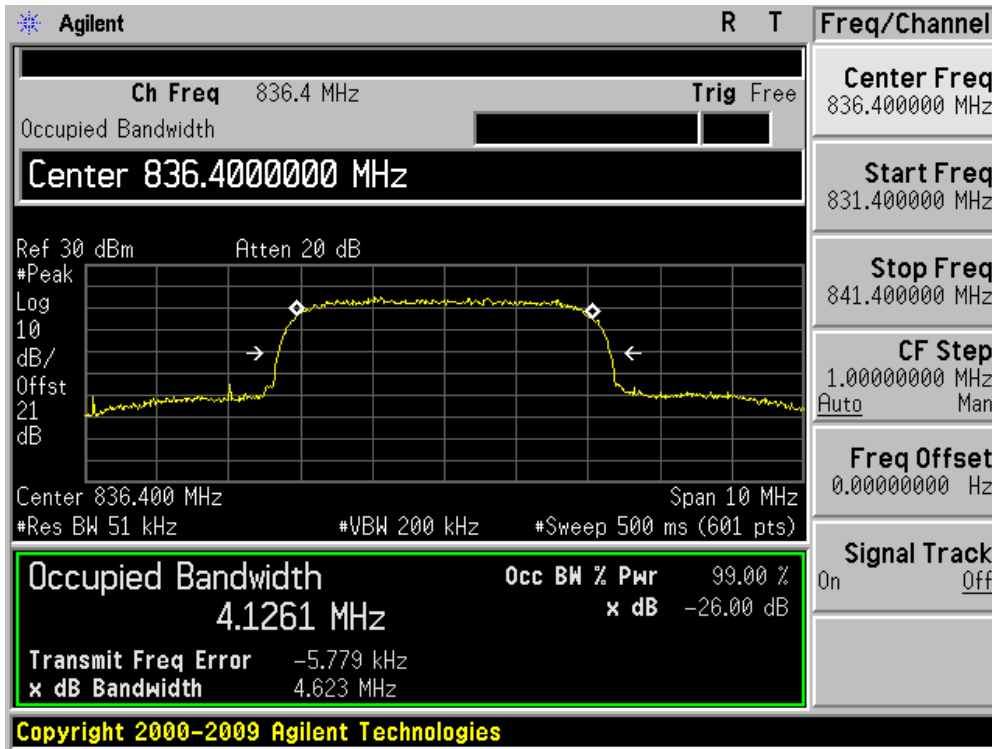
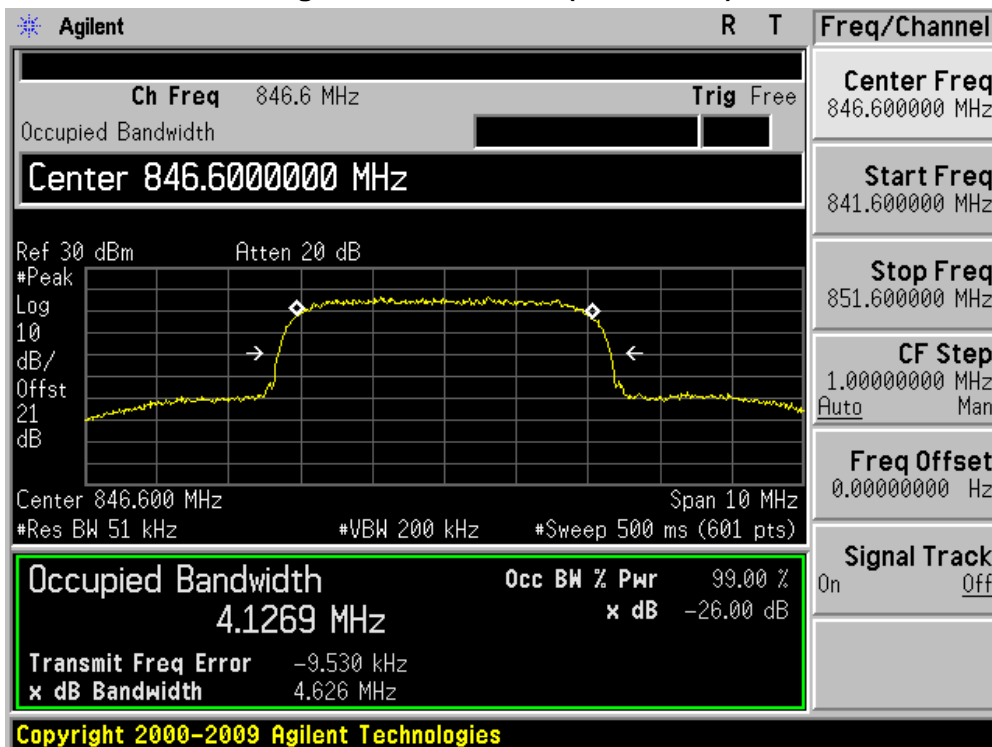

Figure Channel 4233 (846.60MHz)



Product	GSM/GPRS/EDGE/HSDPA/HSUPA/HSPA+/RELEASE 8 MODULE		
Test Item	Occupied Bandwidth		
Test Mode	Mode 7: HSDPA Band II Link		
Date of Test	2010/09/03	Test Site	AC-6

Channel No.	Frequency (MHz)	-26dB Occupied Bandwidth (MHz)	99% Occupied Bandwidth (MHz)
9262	1852.4	4.640	4.1411
9400	1880.0	4.638	4.1295
9538	1907.6	4.623	4.1279

Figure Channel 9262 (1852.4MHz)

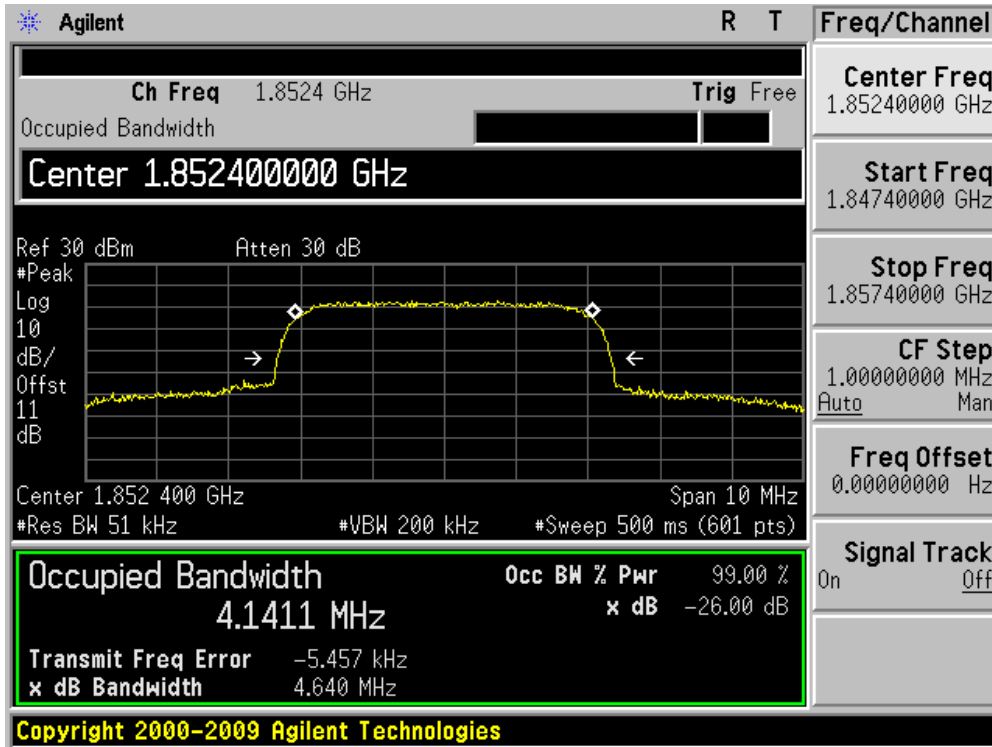

Figure Channel 9400 (1880MHz)

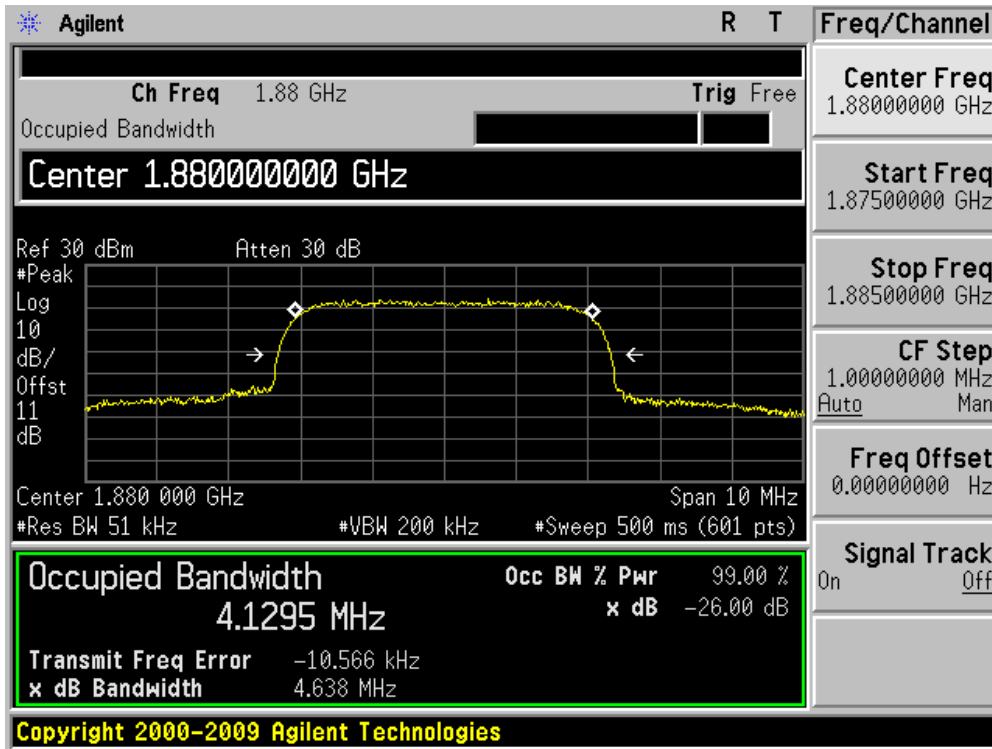
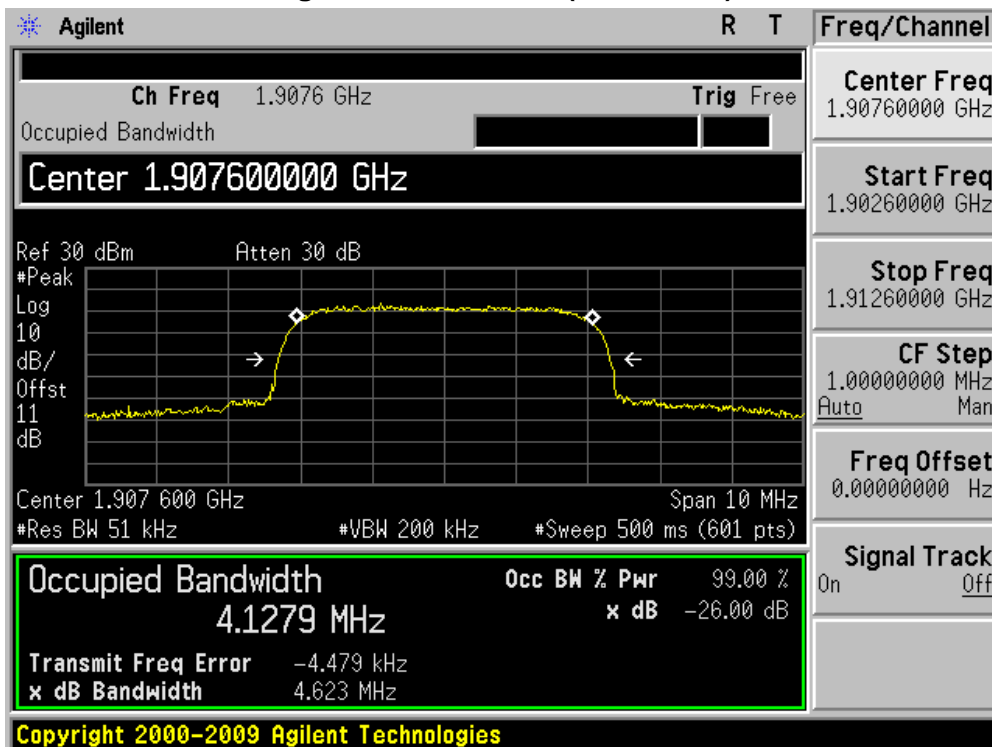

Figure Channel 9538 (1907.6MHz)



Product	GSM/GPRS/EDGE/HSDPA/HSUPA/HSPA+/RELEASE 8 MODULE		
Test Item	Occupied Bandwidth		
Test Mode	Mode 8: HSDPA Band V Link		
Date of Test	2010/09/03	Test Site	AC-6

Channel No.	Frequency (MHz)	-26dB Occupied Bandwidth (MHz)	99% Occupied Bandwidth (MHz)
4132	826.4	4.603	4.1246
4182	836.4	4.623	4.1303
4233	846.6	4.625	4.1306

Figure Channel 4132 (826.4MHz)

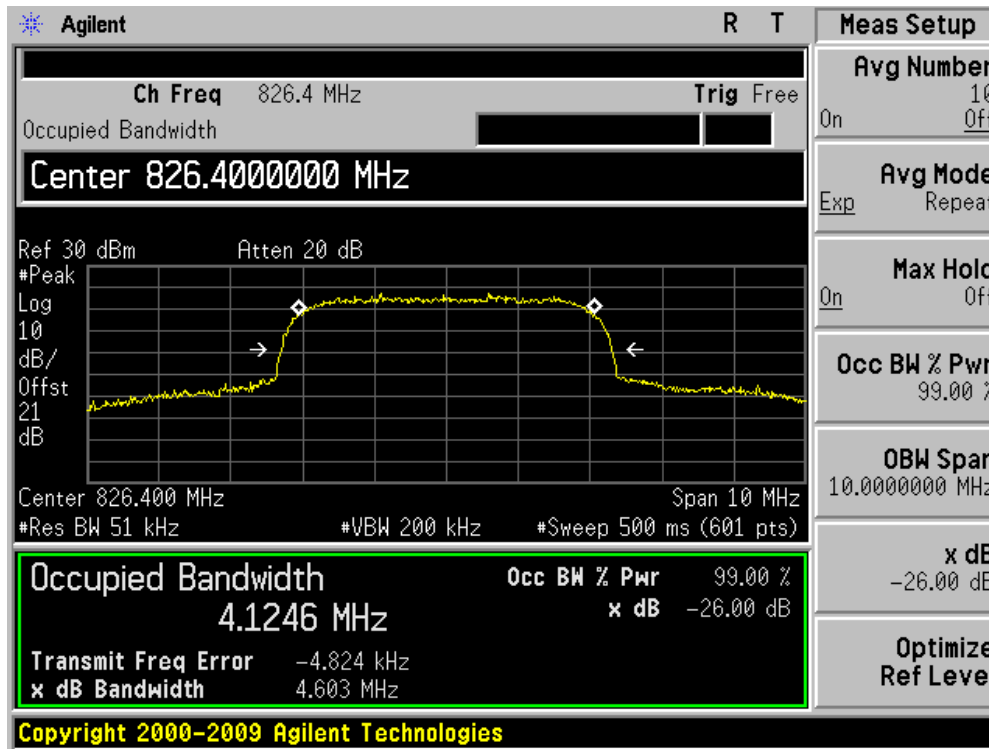

Figure Channel 4182 (836.40MHz)

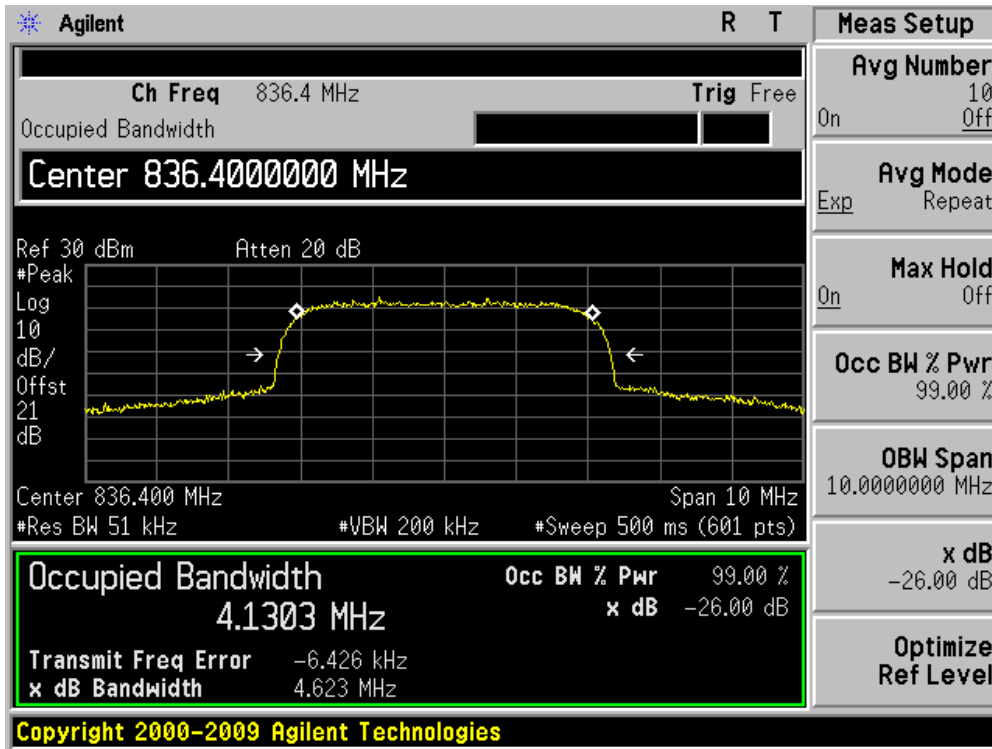
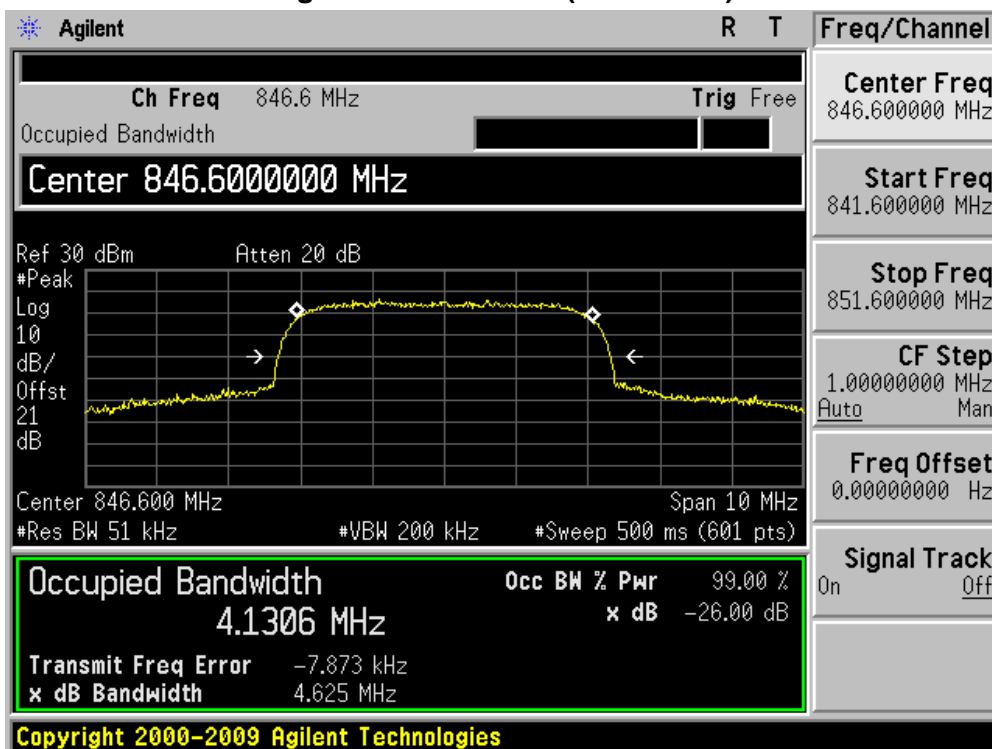

Figure Channel 4233 (846.60MHz)



Product	GSM/GPRS/EDGE/HSDPA/HSUPA/HSPA+/RELEASE 8 MODULE		
Test Item	Occupied Bandwidth		
Test Mode	Mode 9: HSUPA Band II Link		
Date of Test	2010/09/03	Test Site	AC-6

Channel No.	Frequency (MHz)	-26dB Occupied Bandwidth (MHz)	99% Occupied Bandwidth (MHz)
9262	1852.4	4.634	4.1406
9400	1880.0	4.625	4.1317
9538	1907.6	4.633	4.1360

Figure Channel 9262 (1852.4MHz)

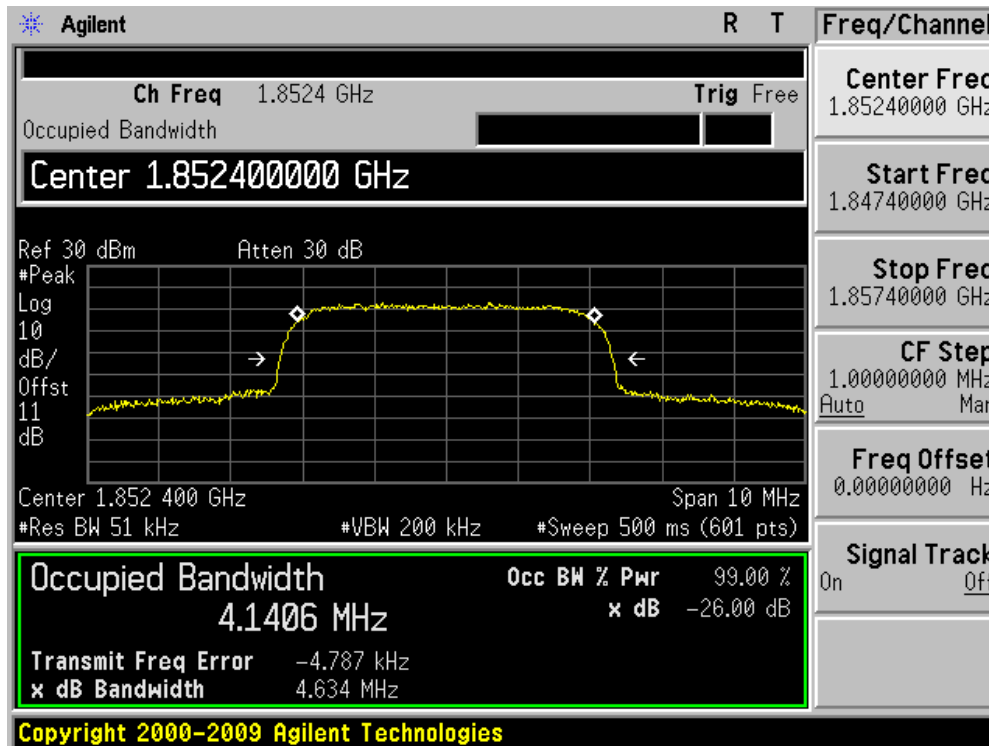

Figure Channel 9400 (1880MHz)

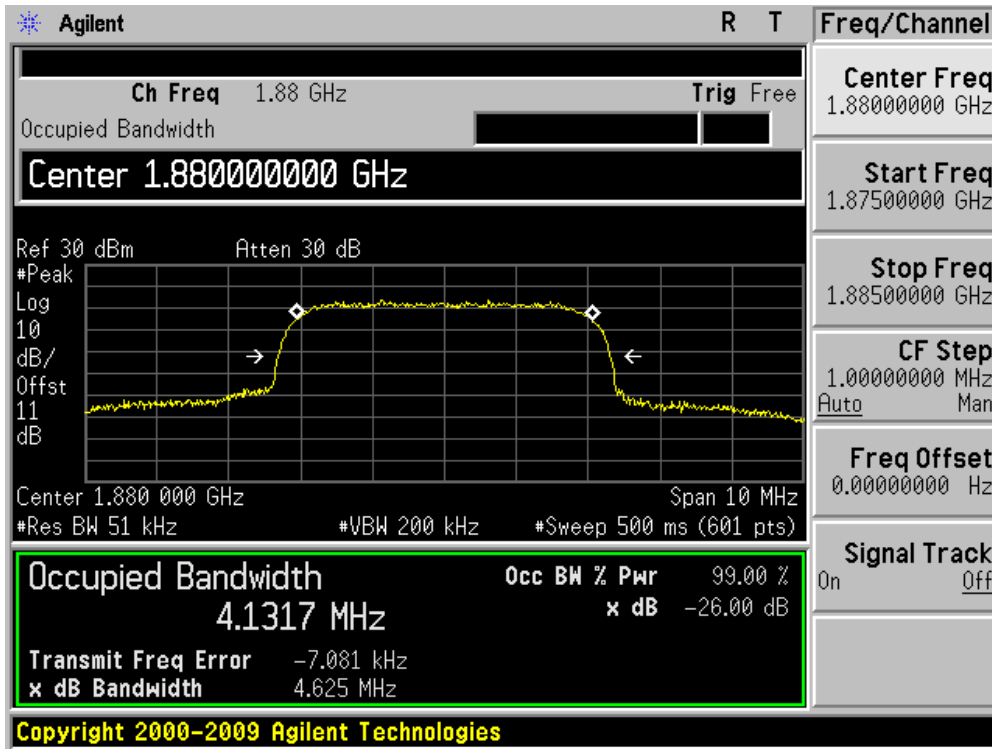
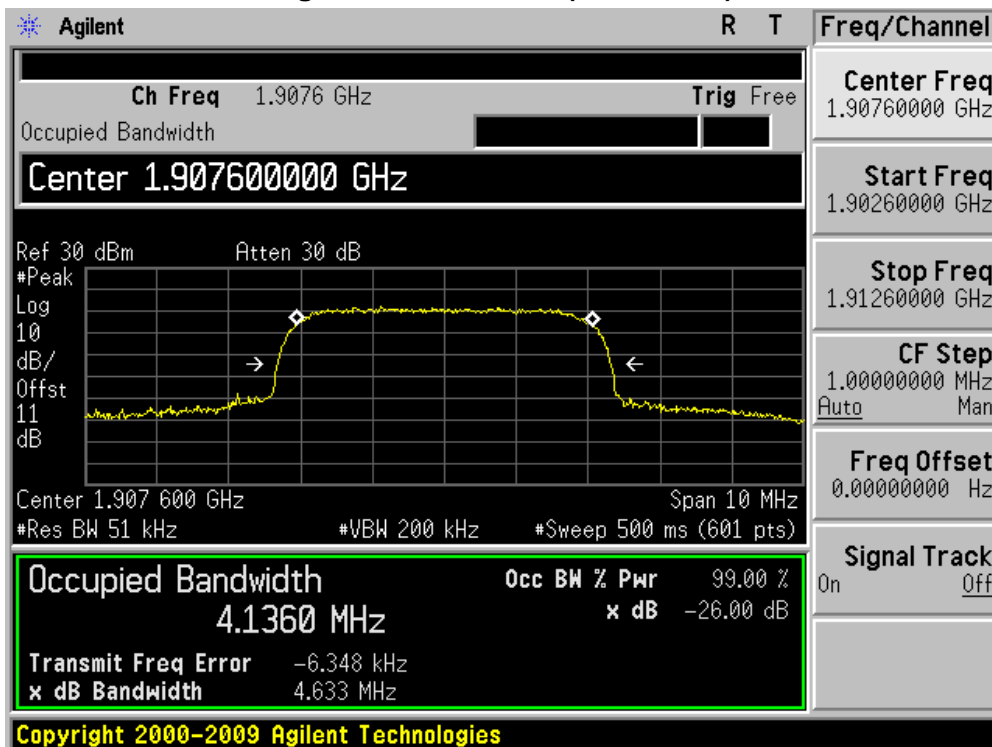

Figure Channel 9538 (1907.6MHz)



Product	GSM/GPRS/EDGE/HSDPA/HSUPA/HSPA+/RELEASE 8 MODULE		
Test Item	Occupied Bandwidth		
Test Mode	Mode 10: HSUPA Band V Link		
Date of Test	2010/09/03	Test Site	AC-6

Channel No.	Frequency (MHz)	-26dB Occupied Bandwidth (MHz)	99% Occupied Bandwidth (MHz)
4132	826.4	4.626	4.1374
4182	836.4	4.621	4.1319
4233	846.6	4.638	4.1299

Figure Channel 4132 (826.4MHz)

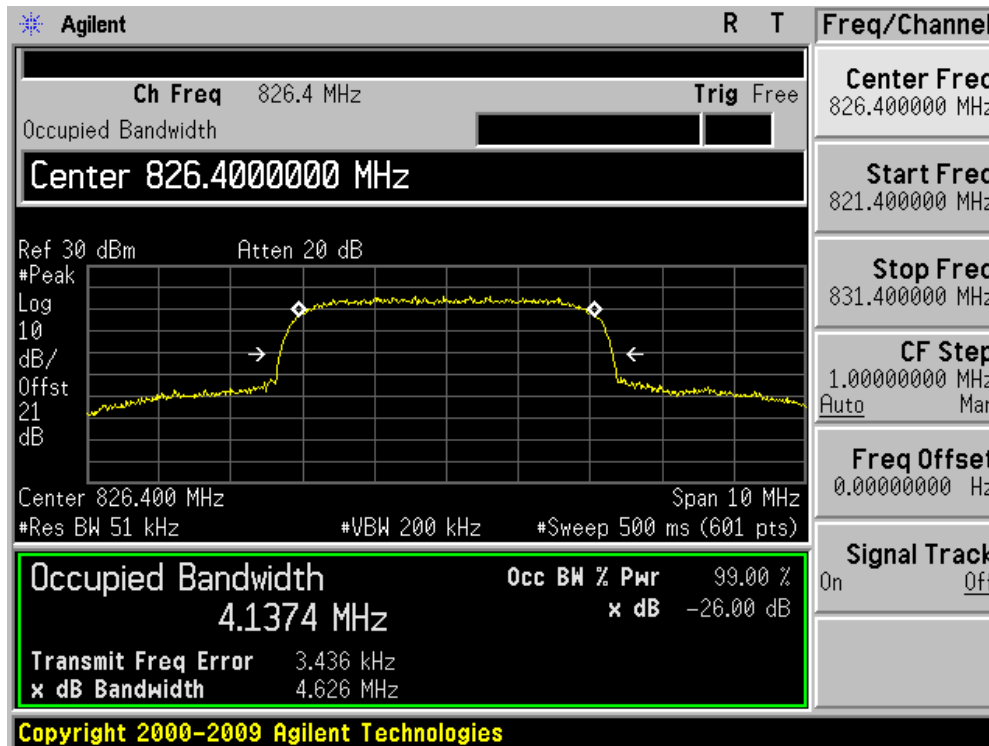

Figure Channel 4182 (836.40MHz)

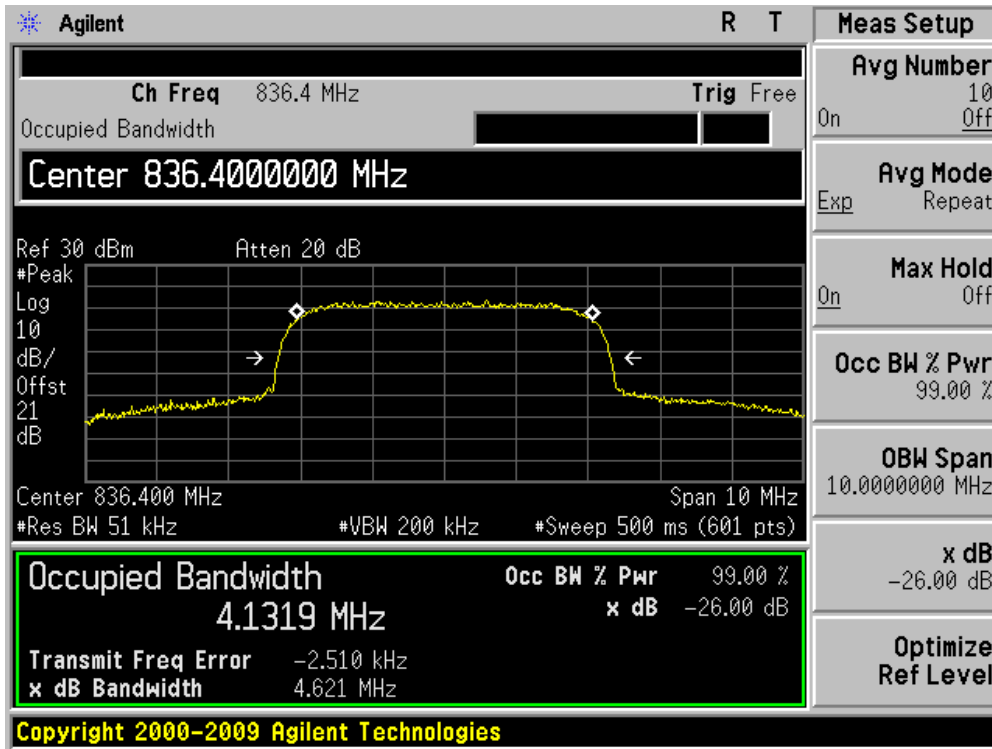
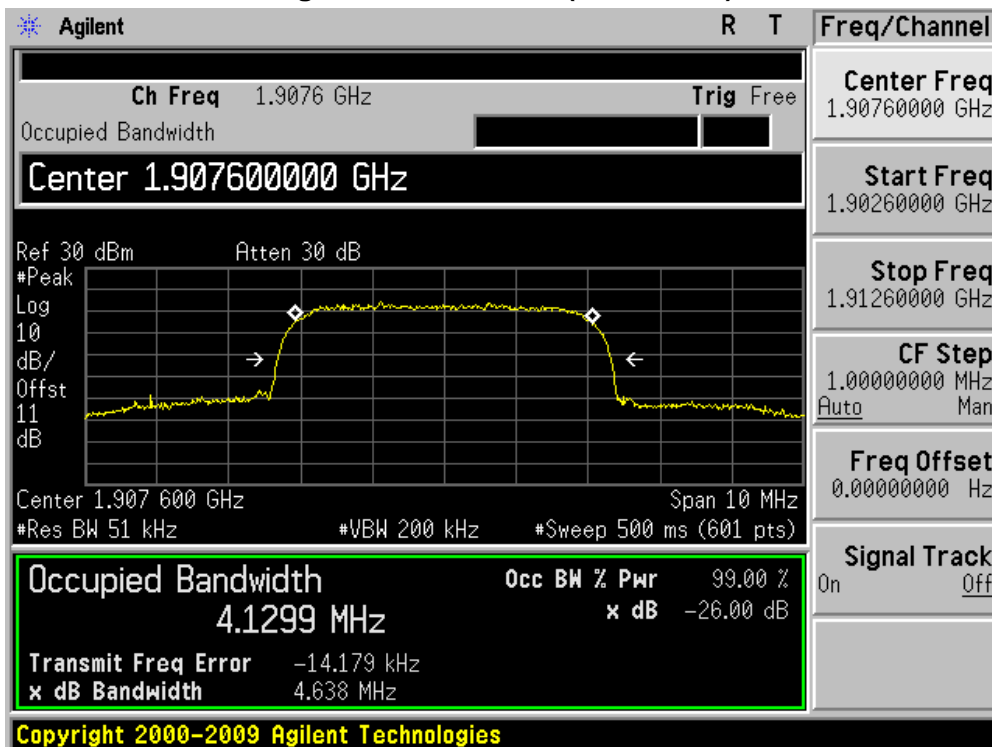

Figure Channel 4233 (846.60MHz)



5. Spurious Emission At Antenna Terminals (+/- 1MHz)

5.1. Test Equipment

Spurious Emission At Antenna Terminals (+/- 1MHz) / AC-6

Instrument	Manufacturer	Type No.	Serial No	Cal. Date
PSA Series Spectrum Analyzer	Agilent	E4440A	MY49420184	2010.04.10
Radio Communication Tester	R&S	CMU 200	117088	2010.07.12
Dual Directional Coupler	Agilent	778D	20160	2010.04.20
10dB Coaxial Coupler	Agilent	87300C	MY44300299	2010.04.20
Temperature/Humidity Meter	Zhicheng	ZC1-2	AC6-TH	2010.01.14

5.2. Test Setup

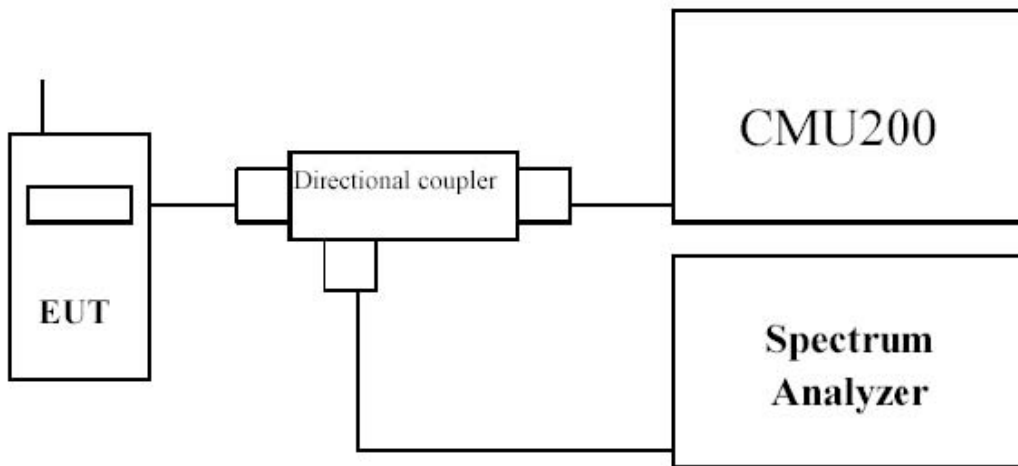

5.3. Limit

The power of any emission outside of the authorized operating frequency ranges must be attenuated below the transmitting power (P) by a factor of at least $43 + 10\log(P)$ dB.

5.4. Test Procedure

In the 1MHz bands immediately outside and adjacent to the frequency block a resolution bandwidth of at least one percent of the emission bandwidth of the fundamental emission of the transmitter may be employed to measure the out of band Emissions.

5.5. Uncertainty

The measurement uncertainty is defined as ± 1.2 dB.

5.6. Test Result

Product	GSM/GPRS/EDGE/HSDPA/HSUPA/HSPA+/RELEASE 8 MODULE		
Test Item	Spurious Emission At Antenna Terminals (+/- 1MHz)		
Test Mode	Mode 1: GSM850 GPRS Link		
Date of Test	2010/09/03	Test Site	AC-6

Figure Channel 128 (824.20MHz)

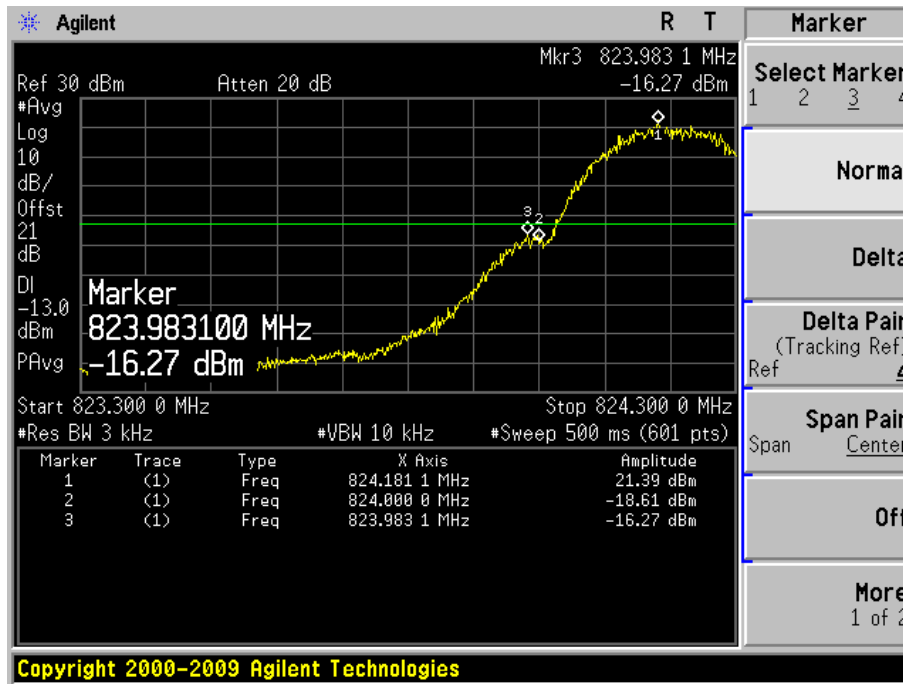
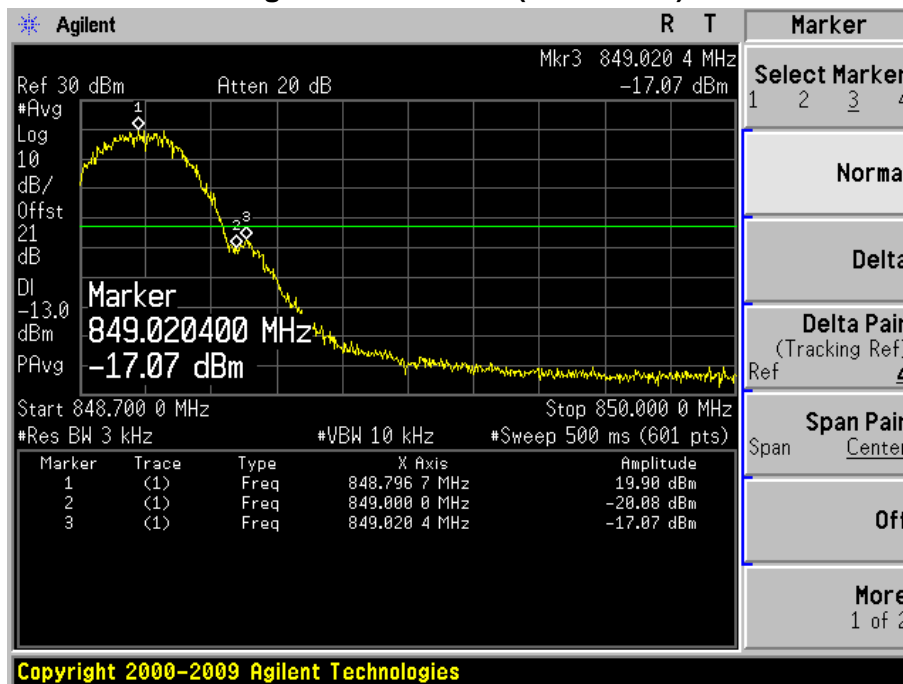

Figure Channel 251 (848.80MHz)



Product	GSM/GPRS/EDGE/HSDPA/HSUPA/HSPA+/RELEASE 8 MODULE		
Test Item	Spurious Emission At Antenna Terminals (+/- 1MHz)		
Test Mode	Mode 2: GSM850 EDGE Link		
Date of Test	2010/09/03	Test Site	AC-6

Figure Channel 128 (824.20MHz)

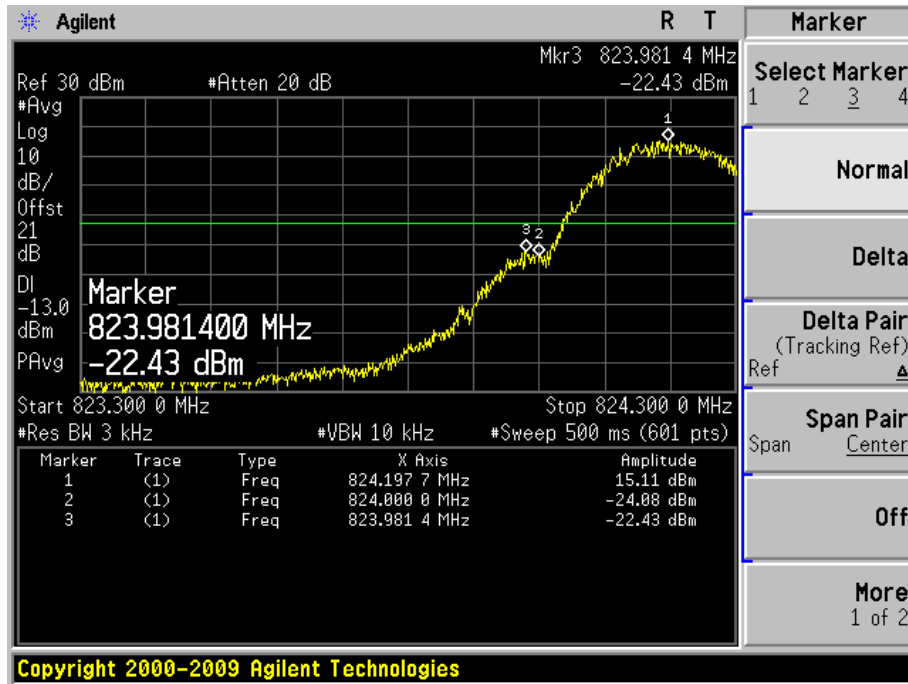
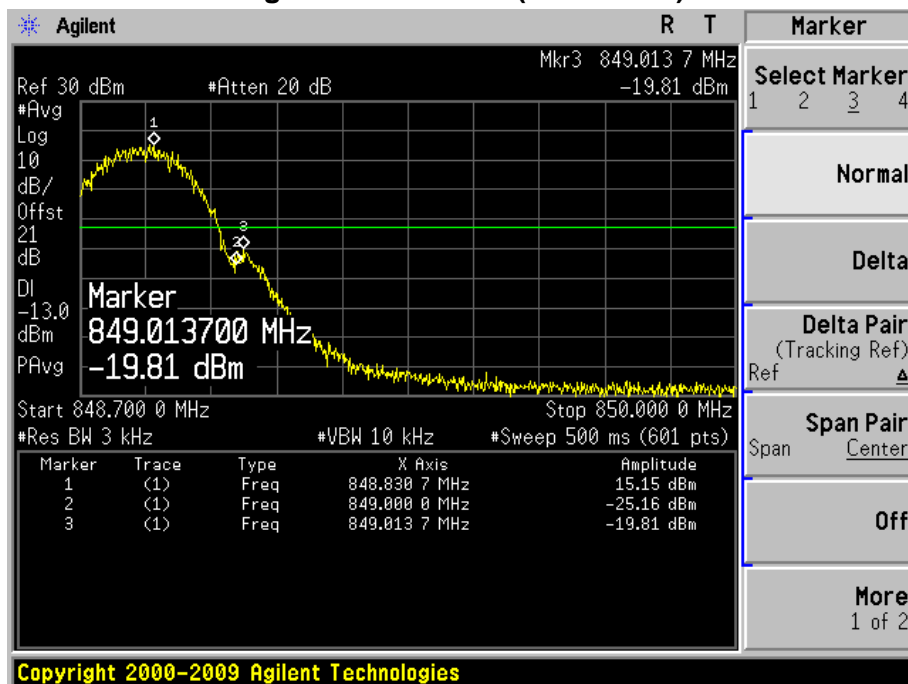

Figure Channel 251 (848.80MHz)



Product	GSM/GPRS/EDGE/HSDPA/HSUPA/HSPA+/RELEASE 8 MODULE		
Test Item	Spurious Emission At Antenna Terminals (+/- 1MHz)		
Test Mode	Mode 3: PCS1900 GPRS Link		
Date of Test	2010/09/03	Test Site	AC-6

Figure Channel 512 (1850.20MHz)

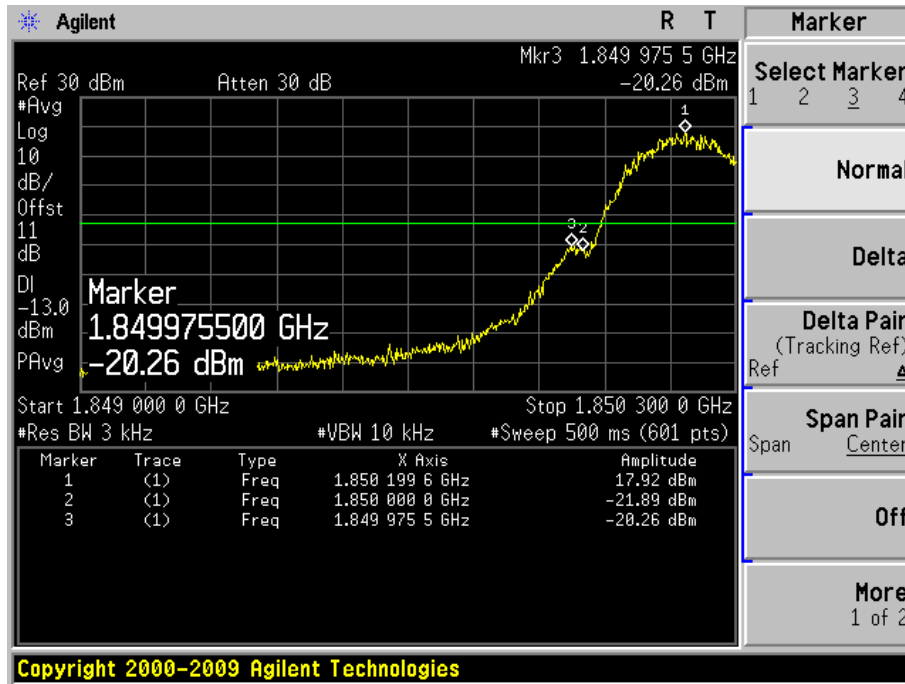
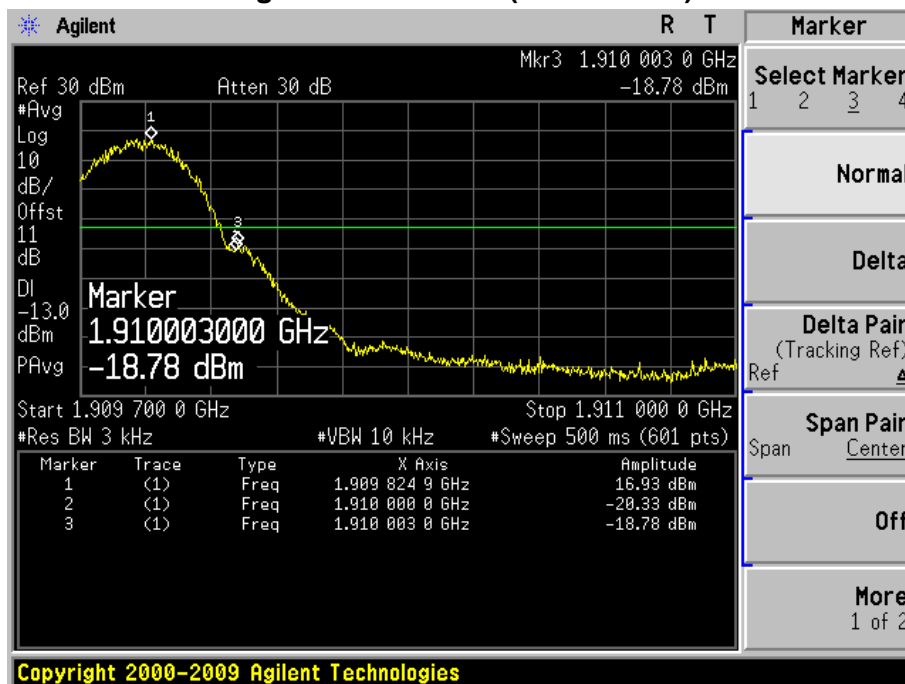

Figure Channel 810 (1909.80MHz)



Product	GSM/GPRS/EDGE/HSDPA/HSUPA/HSPA+/RELEASE 8 MODULE		
Test Item	Spurious Emission At Antenna Terminals (+/- 1MHz)		
Test Mode	Mode 4: PCS1900 EDGE Link		
Date of Test	2010/09/03	Test Site	AC-6

Figure Channel 512 (1850.20MHz)

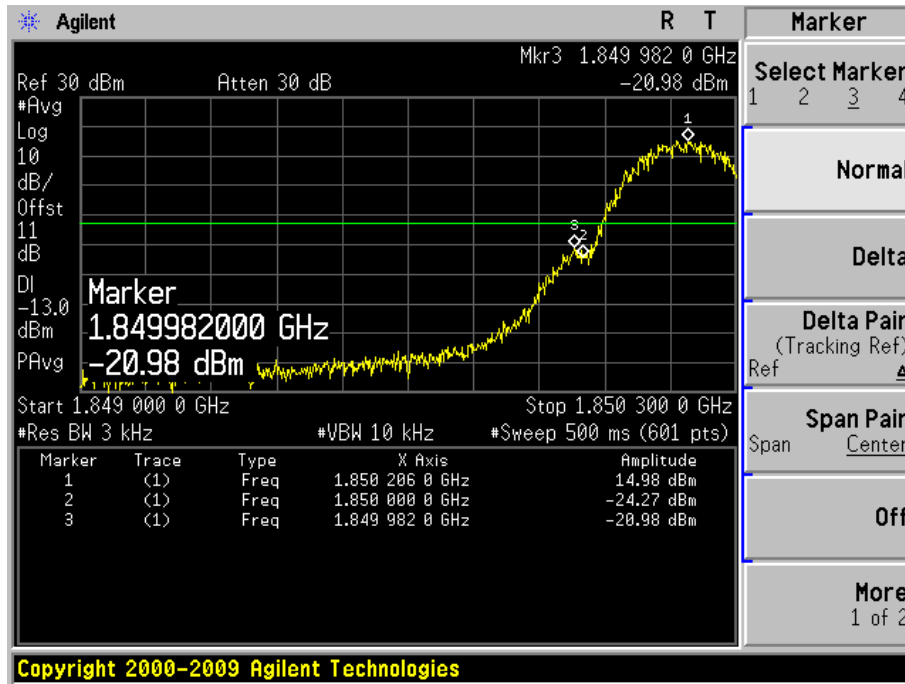
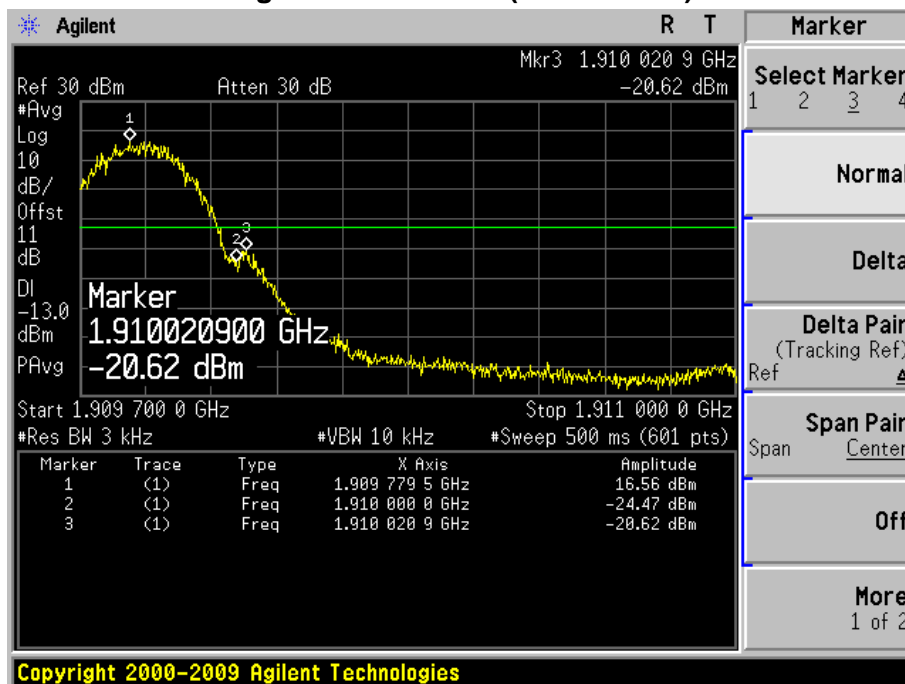

Figure Channel 810 (1909.80MHz)



Product	GSM/GPRS/EDGE/HSDPA/HSUPA/HSPA+/RELEASE 8 MODULE		
Test Item	Spurious Emission At Antenna Terminals (+/- 1MHz)		
Test Mode	Mode 5: WCDMA Band II Link		
Date of Test	2010/09/03	Test Site	AC-6

Figure Channel 9262 (1852.4MHz)

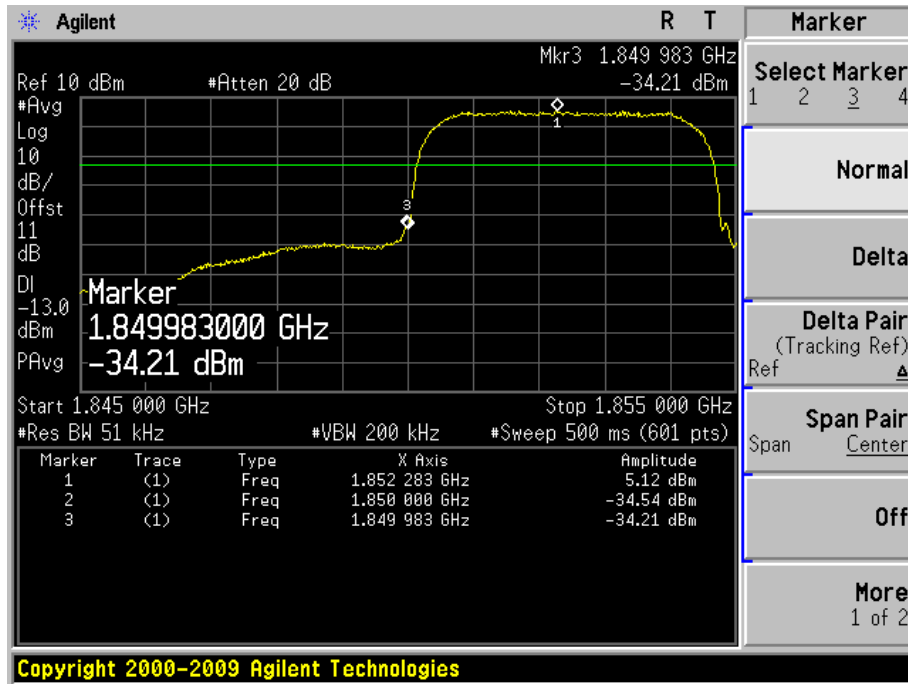
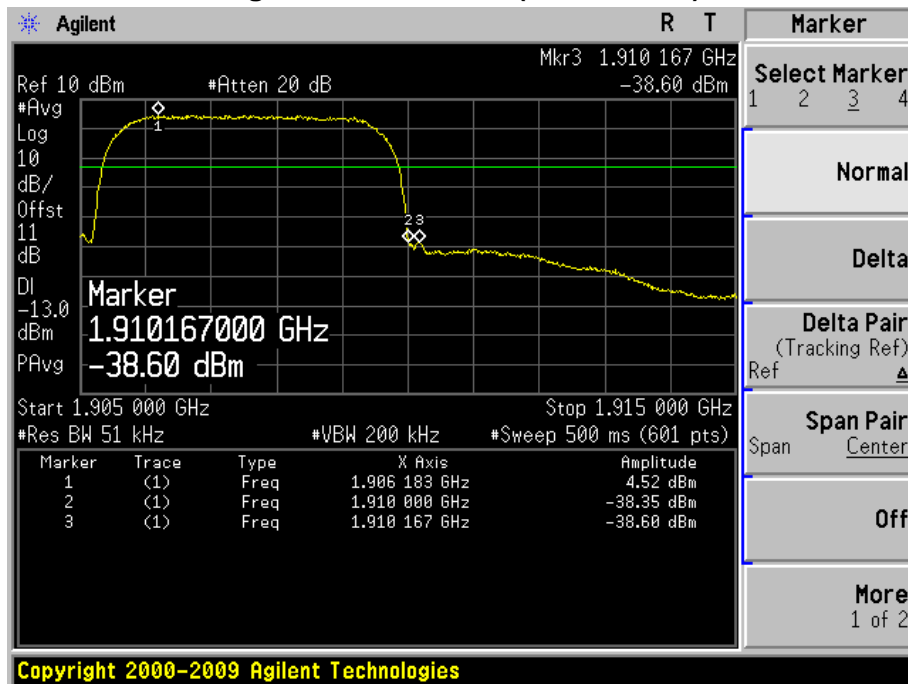

Figure Channel 9538 (1907.60MHz)



Product	GSM/GPRS/EDGE/HSDPA/HSUPA/HSPA+/RELEASE 8 MODULE		
Test Item	Spurious Emission At Antenna Terminals (+/- 1MHz)		
Test Mode	Mode 6: WCDMA Band V Link		
Date of Test	2010/09/03	Test Site	AC-6

Figure Channel 4132 (826.4MHz)

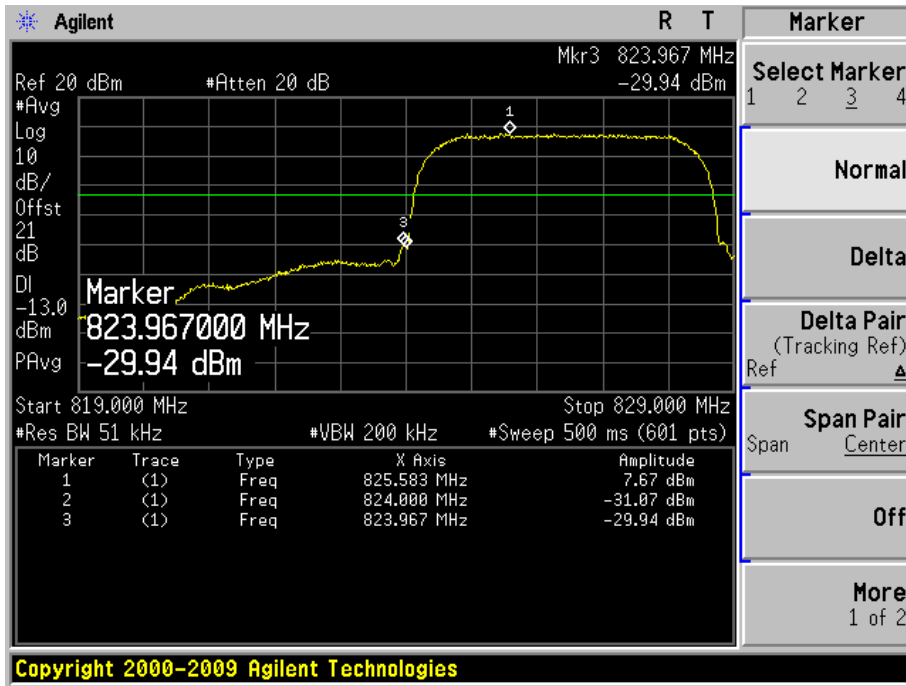
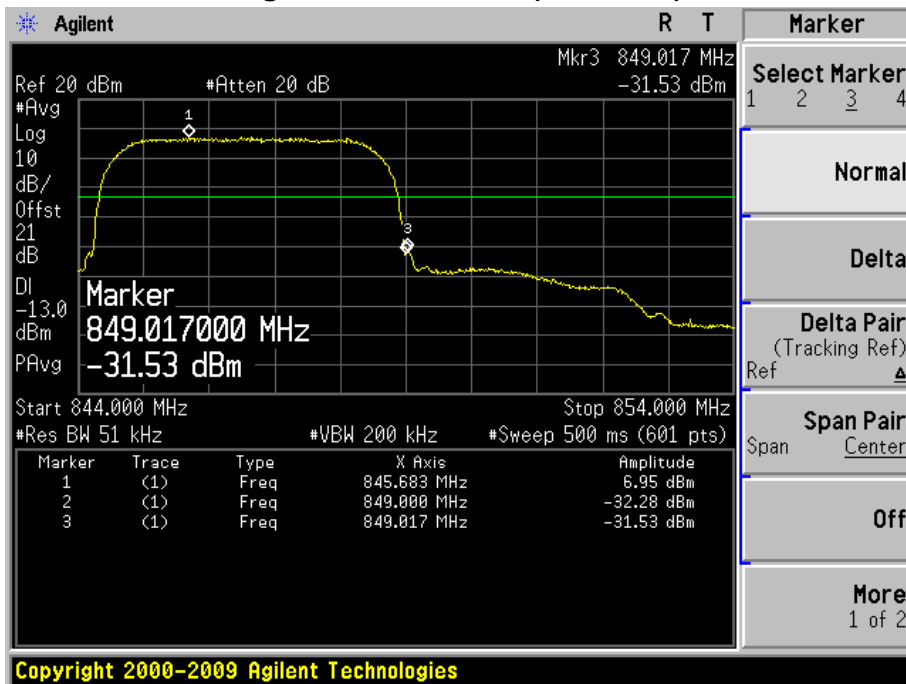

Figure Channel 4233 (846.6MHz)



Product	GSM/GPRS/EDGE/HSDPA/HSUPA/HSPA+/RELEASE 8 MODULE		
Test Item	Spurious Emission At Antenna Terminals (+/- 1MHz)		
Test Mode	Mode 7: HSDPA Band II Link		
Date of Test	2010/09/03	Test Site	AC-6

Figure Channel 9262 (1852.4MHz)

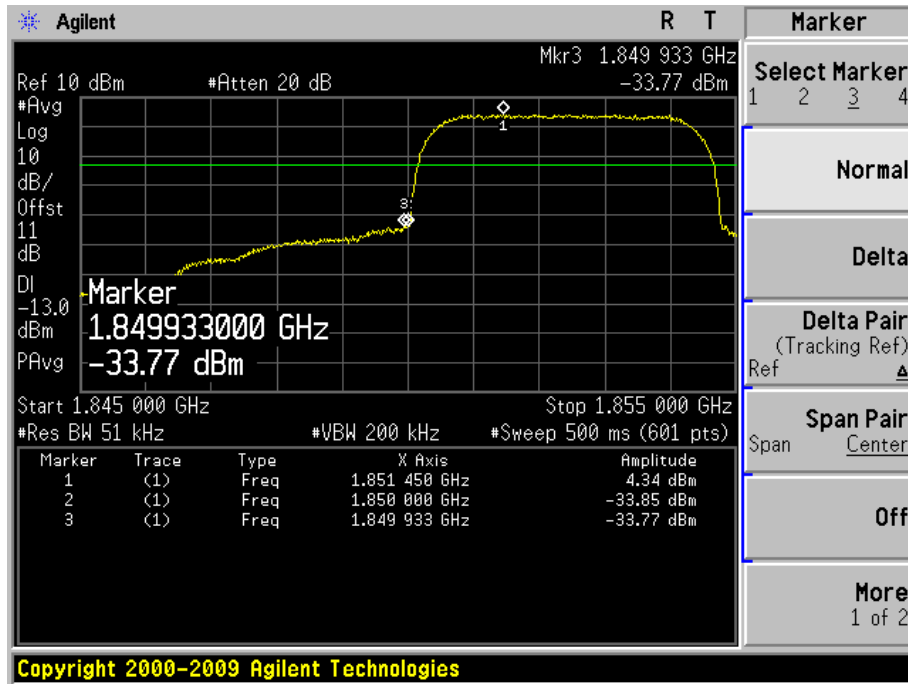
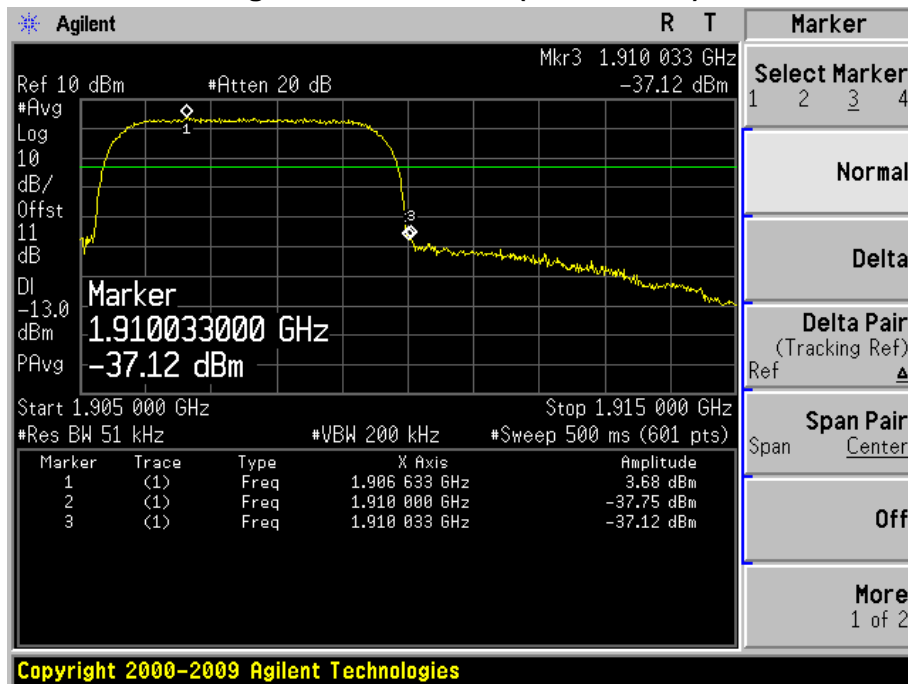

Figure Channel 9538 (1907.60MHz)



Product	GSM/GPRS/EDGE/HSDPA/HSUPA/HSPA+/RELEASE 8 MODULE		
Test Item	Spurious Emission At Antenna Terminals (+/- 1MHz)		
Test Mode	Mode 8: HSDPA Band V Link		
Date of Test	2010/09/03	Test Site	AC-6

Figure Channel 4132 (826.4MHz)

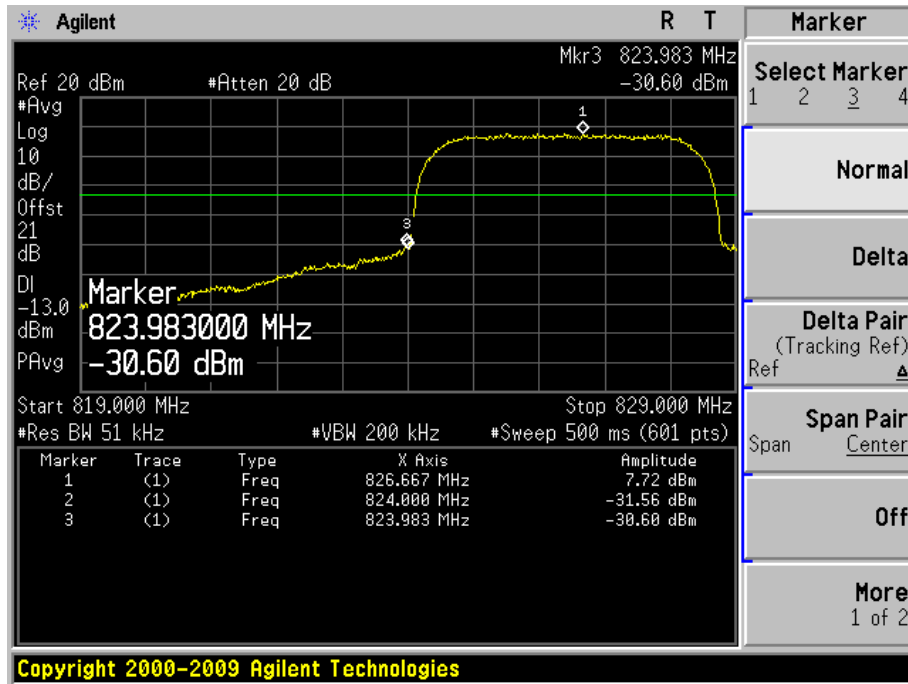
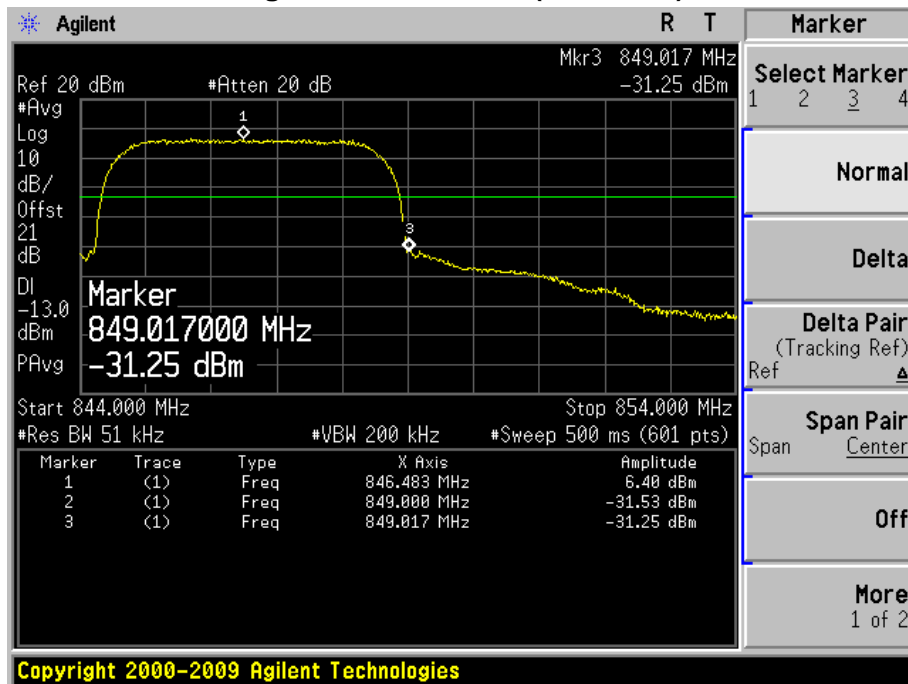

Figure Channel 4233 (846.6MHz)



Product	GSM/GPRS/EDGE/HSDPA/HSUPA/HSPA+/RELEASE 8 MODULE		
Test Item	Spurious Emission At Antenna Terminals (+/- 1MHz)		
Test Mode	Mode 9: HSUPA Band II Link		
Date of Test	2010/09/03	Test Site	AC-6

Figure Channel 9262 (1852.4MHz)

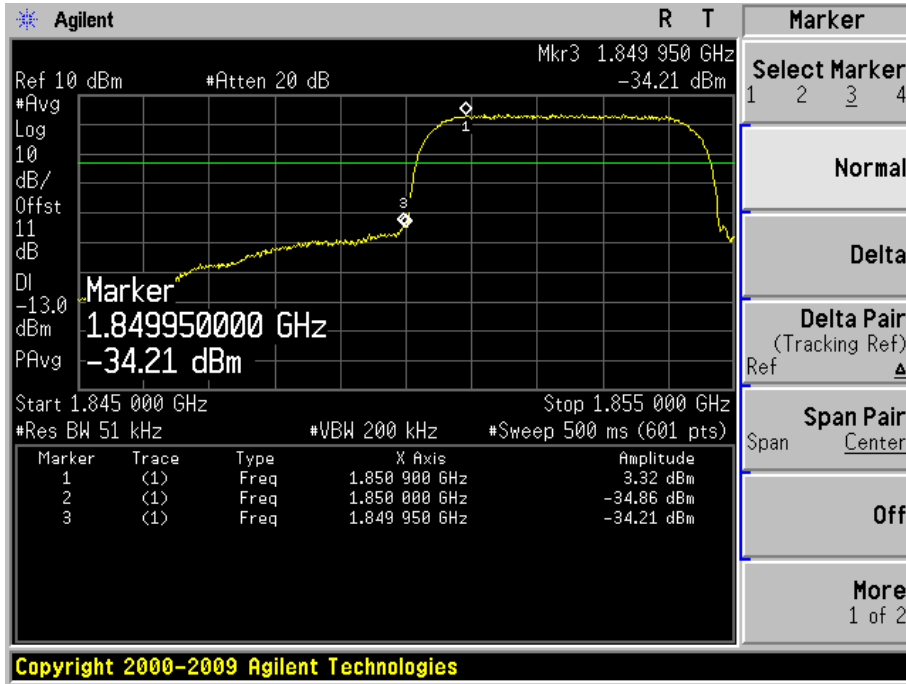
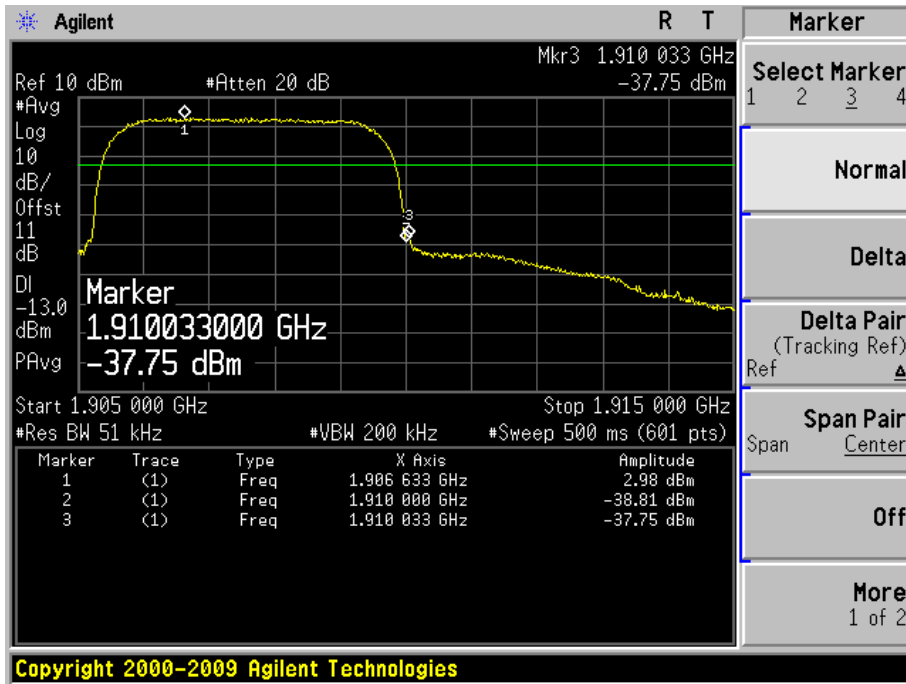

Figure Channel 9538 (1907.6MHz)



Product	GSM/GPRS/EDGE/HSDPA/HSUPA/HSPA+/RELEASE 8 MODULE		
Test Item	Spurious Emission At Antenna Terminals (+/- 1MHz)		
Test Mode	Mode 10: HSUPA Band V Link		
Date of Test	2010/09/03	Test Site	AC-6

Figure Channel 4132 (826.4MHz)

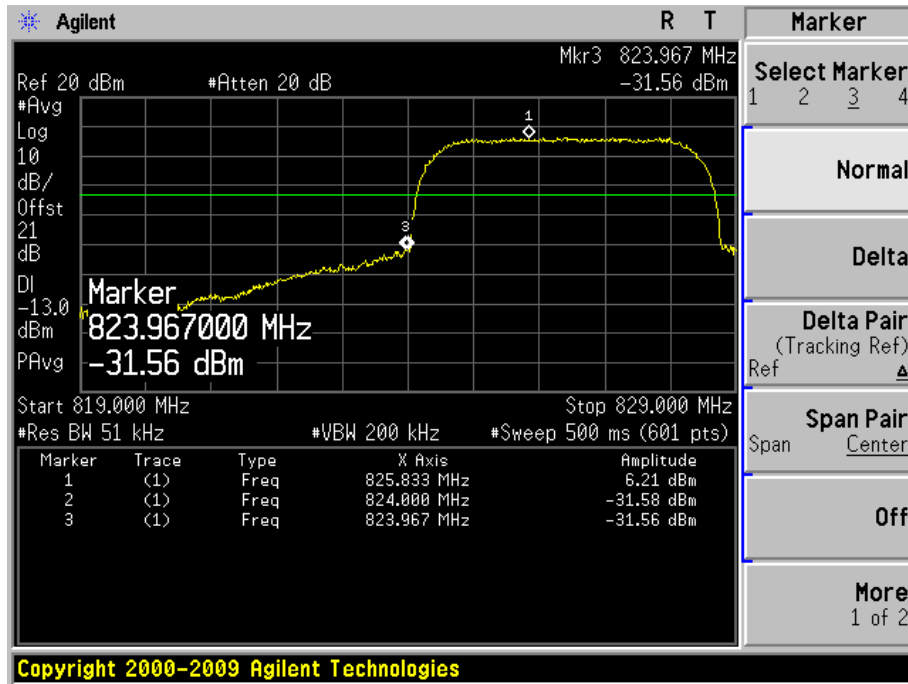
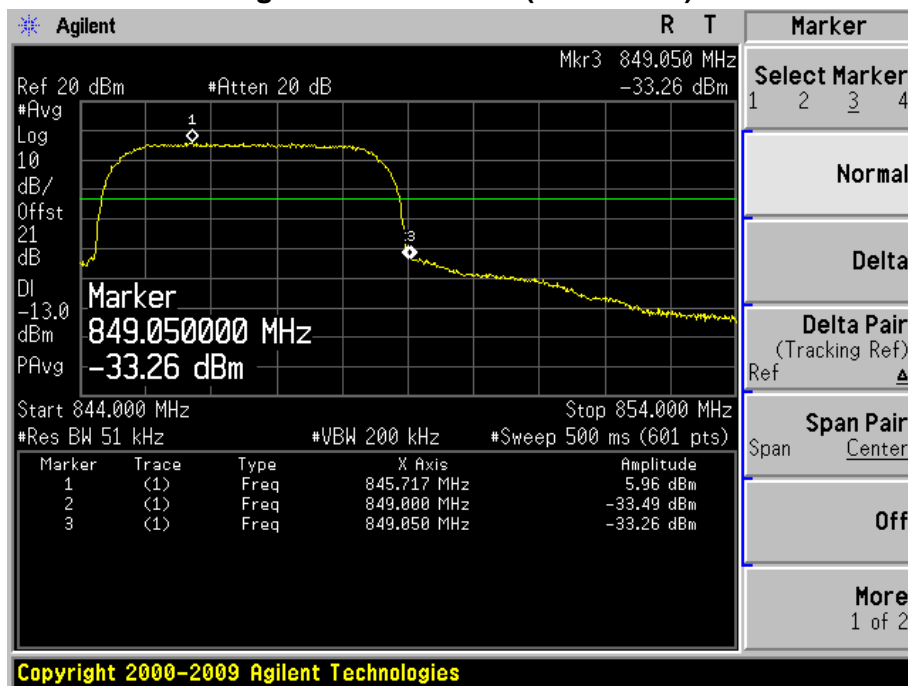

Figure Channel 4233 (846.60MHz)



6. Spurious Emission

6.1. Test Equipment

Spurious Emission / AC-5

Instrument	Manufacturer	Type No.	Serial No	Cal. Date
PSA Series Spectrum Analyzer	Agilent	E4440A	MY49420184	2010.04.10
Radio Communication Tester	R&S	CMU 200	117088	2010.07.12
Dual Directional Coupler	Agilent	778D	20160	2010.04.20
10dB Coaxial Coupler	Agilent	87300C	MY44300299	2010.04.20
PSG Analog Signal Generator	Agilent	E8257D	MY44321116	2010.04.23
Preamplifier	QuieTek	AP-025C	CHM-0503006	2010.05.05
Preamplifier	Miteq	NSP1800-25	1364185	2010.05.05
Bilog Antenna	Teseq GmbH	CBL6112D	27612	2009.11.12
Half Wave Tuned Dipole Antenna	COM-POWER	AD-100	40137	2009.11.24
Broad-Band Horn Antenna	Schwarzbeck	BBHA9120D	737	2009.11.24
Broad-Band Horn Antenna	Schwarzbeck	BBHA9120D	499	2010.06.11
Temperature/Humidity Meter	Zhicheng	ZC1-2	AC5-TH	2010.01.14

6.2. Test Setup

Conducted Spurious Measurement:

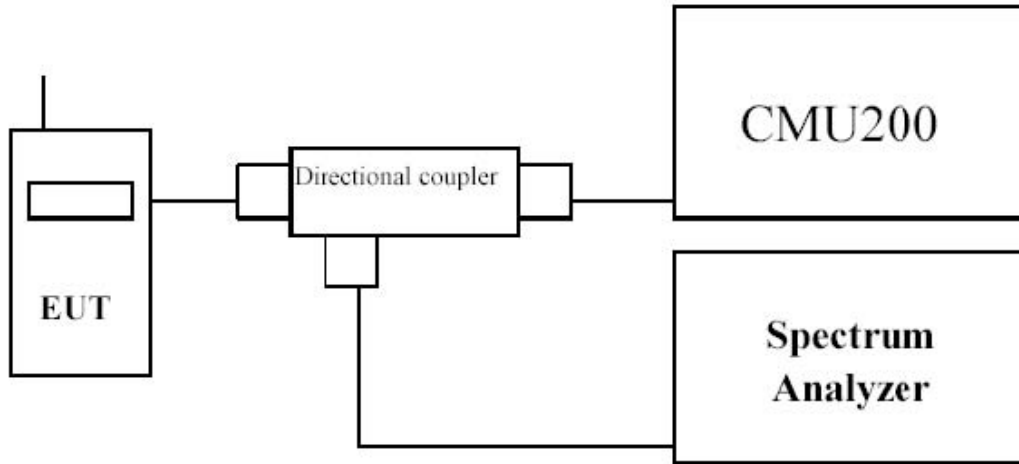

Radiated Spurious Measurement:

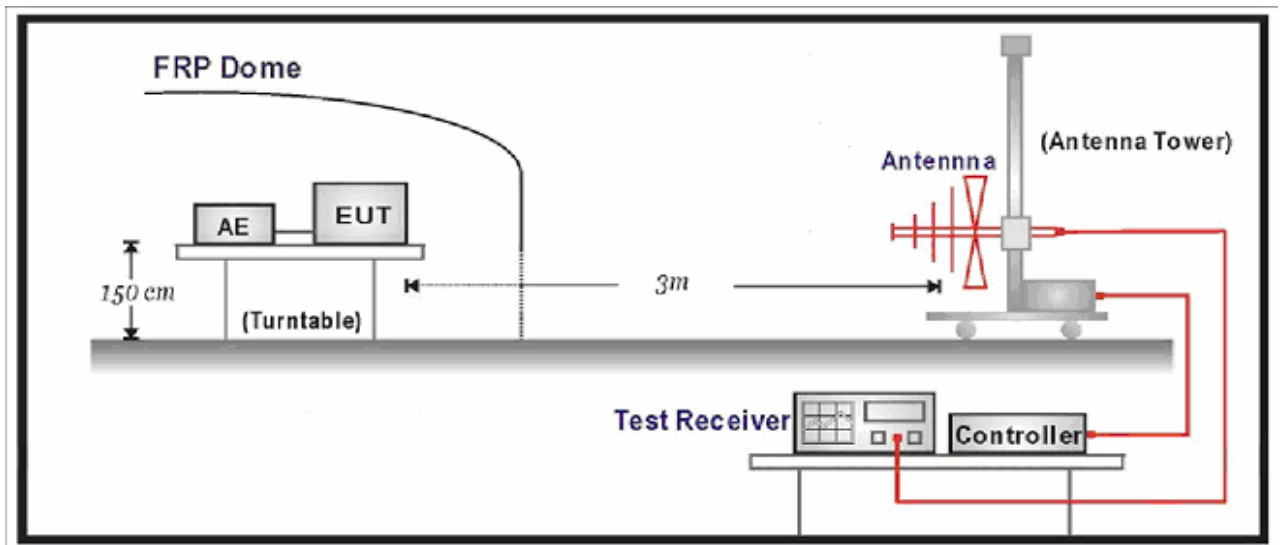

6.3. Limit

The power of any emission outside of the authorized operating frequency ranges must be attenuated below the transmitting power (P) by a factor of at least $43 + 10\log(P)$ dB.

6.4. Test Procedure

Conducted Spurious Measurement:

- a) Place the EUT on a bench and set it in transmitting mode.
- b) Connect a low loss RF cable from the antenna port to a spectrum analyzer and CMU200 by a Directional Couple.
- c) EUT Communicate with CMU200, then select a channel for testing.
- d) Add a correction factor to the display of spectrum, and then test.
- e) The resolution bandwidth of the spectrum analyzer was set at 1 MHz, sufficient scans were taken to show the out of band Emission if any up to 10th harmonic.

Radiated Spurious Measurement:

- a) The EUT shall be placed at the specified height on a support, and in the position closest to normal use as declared by provider.
- b) The test antenna shall be oriented initially for vertical polarization and shall be chosen to correspond to the frequency of the transmitter
- c) The output of the test antenna shall be connected to the measuring receiver.
- d) The transmitter shall be switched on and the measuring receiver shall be tuned to the frequency of the transmitter under test.
- e) The test antenna shall be raised and lowered through the specified range of height until a maximum signal level is detected by the measuring receiver.
- f) The transmitter shall then be rotated through 360° in the horizontal plane, until the maximum signal level is detected by the measuring receiver.
- g) The test antenna shall be raised and lowered again through the specified range of height until a maximum signal level is detected by the measuring receiver.
- u) The maximum signal level detected by the measuring receiver shall be noted.
- h) The transmitter shall be replaced by a substitution antenna.
- i) The substitution antenna shall be orientated for vertical polarization and the length of the substitution antenna shall be adjusted to correspond to the frequency of the transmitter.
- j) The substitution antenna shall be connected to a calibrated signal generator.
- k) If necessary, the input attenuator setting of the measuring receiver shall be adjusted in order to increase the sensitivity of the measuring receiver.
- l) The test antenna shall be raised and lowered through the specified range of height to ensure that the maximum signal is received.
- m) The input signal to the substitution antenna shall be adjusted to the level that produces a level detected by the measuring receiver, that is equal to the level noted while the transmitter radiated power was measured, corrected for the change of input attenuator setting of the measuring receiver.

- n) The measurement shall be repeated with the test antenna and the substitution antenna orientated for horizontal polarization.
- o) The measure of the effective radiated power is the larger of the two levels recorded at the input to the substitution antenna, corrected for gain of the substitution antenna if necessary.
- p) The frequency range was checked up to 10th harmonic.

6.5. Uncertainty

The measurement uncertainty is defined as 3.2 dB for Radiated Power Measurement.

6.6. Test Result

Product	GSM/GPRS/EDGE/HSDPA/HSUPA/HSPA+/RELEASE 8 MODULE		
Test Item	Spurious Emission		
Test Mode	Mode 1: GSM850 GPRS Link		
Date of Test	2010/09/03	Test Site	AC-6

Frequency (MHz)	SA Reading (dBm)	Ant.Pol. (H/V)	SG Reading (dBm)	Cable Loss (dB)	Gain (dBi)	EIRP (dBm)	Limit (dBm)	Margin (dB)
Low Channel 128 (824.20MHz)								
1603.5	-34.10	V	-53.10	2.45	9.50	-46.05	-13.00	-33.05
2496.0	-40.96	V	-56.00	3.18	10.58	-48.60	-13.00	-35.60
1603.5	-34.78	H	-53.92	2.45	9.50	-46.87	-13.00	-33.87
2496.0	-42.08	H	-57.08	3.18	10.58	-49.68	-13.00	-36.68
Middle Channel 189 (836.40MHz)								
1671.5	-33.74	V	-53.12	2.50	9.90	-45.72	-13.00	-32.72
2513.0	-41.79	V	-56.87	3.18	10.62	-49.43	-13.00	-36.43
1671.5	-21.92	H	-40.63	2.50	9.90	-33.23	-13.00	-20.23
2513.0	-33.46	H	-48.48	3.18	10.62	-41.04	-13.00	-28.04
High Channel 251 (848.80MHz)								
1697.0	-23.43	V	-42.10	2.54	10.10	-34.54	-13.00	-21.54
2547.0	-36.89	V	-52.11	3.14	10.68	-44.57	-13.00	-31.57
1697.0	-25.12	H	-43.69	2.54	10.10	-36.13	-13.00	-23.13
2547.0	-35.74	H	-50.81	3.14	10.68	-43.27	-13.00	-30.27

Product	GSM/GPRS/EDGE/HSDPA/HSUPA/HSPA+/RELEASE 8 MODULE		
Test Item	Spurious Emission		
Test Mode	Mode 2: GSM1900 GPRS Link		
Date of Test	2010/09/03	Test Site	AC-6

Frequency (MHz)	SA Reading (dBm)	Ant.Pol. (H/V)	SG Reading (dBm)	Cable Loss (dB)	Gain (dBi)	EIRP (dBm)	Limit (dBm)	Margin (dB)
Low Channel 512 (1850.20MHz)								
3703.0	-46.30	V	-58.05	3.84	12.69	-49.20	-13.00	-36.20
5556.0	-46.81	V	-53.45	4.82	13.15	-45.12	-13.00	-32.12
3703.0	-42.73	H	-54.06	3.84	12.69	-45.21	-13.00	-32.21
5556.0	-50.79	H	-57.54	4.82	13.15	-49.21	-13.00	-36.21
Middle Channel 661 (1880.00MHz)								
3762.5	-43.15	V	-54.20	3.75	12.73	-45.22	-13.00	-32.22
5998.0	-47.26	V	-53.57	5.00	13.00	-45.57	-13.00	-32.57
3762.5	-41.63	H	-52.74	3.75	12.73	-43.76	-13.00	-30.76
5998.0	-50.70	H	-57.19	5.00	13.00	-49.19	-13.00	-36.19
High Channel 810 (1909.80MHz)								
3822.0	-47.32	V	-57.65	4.02	12.73	-48.94	-13.00	-35.94
5554.5	-47.25	V	-53.85	4.82	13.10	-45.57	-13.00	-32.57
3822.0	-47.70	H	-58.40	4.02	12.73	-49.69	-13.00	-36.69
5554.5	-51.81	H	-58.51	4.82	13.10	-50.23	-13.00	-37.23

Product	GSM/GPRS/EDGE/HSDPA/HSUPA/HSPA+/RELEASE 8 MODULE		
Test Item	Spurious Emission		
Test Mode	Mode 3: GSM850 EDGE Link		
Date of Test	2010/09/03	Test Site	AC-6

Frequency (MHz)	SA Reading (dBm)	Ant.Pol. (H/V)	SG Reading (dBm)	Cable Loss (dB)	Gain (dBi)	EIRP (dBm)	Limit (dBm)	Margin (dB)
Low Channel 128 (824.20MHz)								
1646.0	-18.45	V	22.73	2.50	9.80	30.03	-13.00	43.03
2470.5	-39.08	V	-54.08	3.12	10.48	-46.72	-13.00	-33.72
1646.0	-18.70	H	-37.60	2.50	9.80	-30.30	-13.00	-17.30
2470.5	-34.85	H	-49.80	3.12	10.48	-42.44	-13.00	-29.44
Middle Channel 189 (836.40MHz)								
1603.5	-31.94	V	-50.84	2.45	9.40	-43.89	-13.00	-30.89
2496.0	-38.59	V	-53.63	3.18	10.58	-46.23	-13.00	-33.23
1603.5	-23.34	H	-41.59	2.45	9.40	-34.64	-13.00	-21.64
2496.0	-35.63	H	-50.61	3.18	10.58	-43.21	-13.00	-30.21
High Channel 251 (848.80MHz)								
1697.0	-26.61	V	-39.27	8.54	10.10	-37.71	-13.00	-24.71
2547.0	-39.02	V	-54.20	3.14	10.68	-46.66	-13.00	-33.66
1697.0	-26.29	H	-38.87	8.54	10.10	-37.31	-13.00	-24.31
2547.0	-38.13	H	-53.20	3.14	10.68	-45.66	-13.00	-32.66

Product	GSM/GPRS/EDGE/HSDPA/HSUPA/HSPA+/RELEASE 8 MODULE		
Test Item	Spurious Emission		
Test Mode	Mode 4: GSM1900 EDGE Link		
Date of Test	2010/09/03	Test Site	AC-6

Frequency (MHz)	SA Reading (dBm)	Ant.Pol. (H/V)	SG Reading (dBm)	Cable Loss (dB)	Gain (dBi)	EIRP (dBm)	Limit (dBm)	Margin (dB)
Low Channel 512 (1850.20MHz)								
3703.0	-45.63	V	-57.38	3.84	12.69	-48.53	-13.00	-35.53
5998.0	-47.38	V	-53.69	5.00	13.00	-45.69	-13.00	-32.69
3703.0	-47.56	H	-58.89	3.84	12.69	-50.04	-13.00	-37.04
5998.0	-50.71	H	-57.14	5.00	13.00	-49.14	-13.00	-36.14
Middle Channel 661 (1880.00MHz)								
3762.5	-45.91	V	-56.97	3.75	12.73	-47.99	-13.00	-34.99
5530.5	-46.29	V	-52.93	4.82	13.14	-44.61	-13.00	-31.61
3762.5	-47.12	H	-58.21	3.75	12.73	-49.23	-13.00	-36.23
5530.5	-51.21	H	-57.98	4.82	13.14	-49.66	-13.00	-36.66
High Channel 810 (1909.80MHz)								
3822.0	-44.97	V	-55.3	4.02	12.73	-46.59	-13.00	-33.59
5998.0	-47.66	V	-53.97	5.00	13.00	-45.97	-13.00	-32.97
3822.0	-51.60	H	-62.80	4.02	12.73	-54.09	-13.00	-41.09
5998.0	-50.57	H	-57.11	5.00	13.00	-49.11	-13.00	-36.11

Product	GSM/GPRS/EDGE/HSDPA/HSUPA/HSPA+/RELEASE 8 MODULE		
Test Item	Spurious Emission		
Test Mode	Mode 5: WCDMA Band II Link		
Date of Test	2010/09/03	Test Site	AC-6

Frequency (MHz)	SA Reading (dBm)	Ant. Pol. (H/V)	SG Reading (dBm)	Cable Loss (dB)	Gain (dBi)	EIRP (dBm)	Limit (dBm)	Margin (dB)
Low Channel 9262 (1852.40MHz)								
3703.0	-50.04	V	-63.94	3.84	12.69	-55.09	-13.00	-42.09
5607.0	-50.65	V	-59.31	4.80	13.14	-50.97	-13.00	-37.97
3703.0	-50.97	H	-64.44	3.84	12.69	-55.59	-13.00	-42.59
5607.0	51.00	H	-59.91	4.80	13.14	-51.57	-13.00	-38.57
Middle Channel 9400 (1880.00MHz)								
3745.5	-50.02	V	-63.22	3.74	12.71	-54.25	-13.00	-41.25
5539.0	-50.82	V	-59.48	4.82	13.14	-51.16	-13.00	-38.16
3745.5	-50.98	H	-64.33	3.74	12.71	-55.36	-13.00	-42.36
5539.0	-50.61	H	-59.52	4.82	13.14	-51.20	-13.00	-38.20
High Channel 9538 (1907.60MHz)								
3839.0	-50.19	V	-62.7	4.05	12.72	-54.03	-13.00	-41.03
5998.0	-47.44	V	-55.91	5.00	13.00	-47.91	-13.00	-34.91
3839.0	-49.67	H	-62.45	4.05	12.72	-53.78	-13.00	-40.78
5998.0	-51.68	H	-60.16	5.00	13.00	-52.16	-13.00	-39.16

Product	GSM/GPRS/EDGE/HSDPA/HSUPA/HSPA+/RELEASE 8 MODULE		
Test Item	Spurious Emission		
Test Mode	Mode 6: WCDMA Band V Link		
Date of Test	2010/09/03	Test Site	AC-6

Frequency (MHz)	SA Reading (dBm)	Ant.Pol. (H/V)	SG Reading (dBm)	Cable Loss (dB)	Gain (dBi)	EIRP (dBm)	Limit (dBm)	Margin (dB)
Low Channel 4132 (826.40MHz)								
1654.5	-44.83	V	-61.49	2.49	9.80	-54.18	-13.00	-41.18
2334.5	-50.59	V	-61.88	3.00	9.8	-55.08	-13.00	-42.08
1654.5	-43.66	H	-60.32	2.49	9.8	-53.01	-13.00	-40.01
2334.5	-49.60	H	-61.62	3.00	9.8	-54.82	-13.00	-41.82
Middle Channel 4182 (836.40MHz)								
1595.0	-32.99	V	-49.77	2.46	9.41	-42.82	-13.00	-29.82
2487.5	-39.36	V	-52.19	3.16	10.52	-44.83	-13.00	-31.83
1595.0	-37.39	H	-54.28	2.46	9.41	-47.33	-13.00	-34.33
2487.5	-42.99	H	-55.8	3.16	10.52	-48.44	-13.00	-35.44
High Channel 4233 (846.6MHz)								
1603.5	-34.74	V	-51.58	2.45	9.50	-44.53	-13.00	-31.53
2487.5	-38.52	V	-51.37	3.16	10.52	-44.01	-13.00	-31.01
1603.5	-37.88	H	-54.84	2.45	9.50	-47.79	-13.00	-34.79
2487.5	-44.00	H	-56.81	3.16	10.52	-49.45	-13.00	-36.45

Product	GSM/GPRS/EDGE/HSDPA/HSUPA/HSPA+/RELEASE 8 MODULE		
Test Item	Spurious Emission		
Test Mode	Mode 7: HSDPA Band II Link		
Date of Test	2010/09/03	Test Site	AC-6

Frequency (MHz)	SA Reading (dBm)	Ant. Pol. (H/V)	SG Reading (dBm)	Cable Loss (dB)	Gain (dBi)	EIRP (dBm)	Limit (dBm)	Margin (dB)
Low Channel 9262 (1852.40MHz)								
3703.0	-50.08	V	-63.98	3.84	12.69	-55.13	-13.00	-42.13
5556.0	-50.34	V	-59.16	4.82	13.15	-50.83	-13.00	-37.83
3703.0	-50.59	H	-64.07	3.84	12.69	-55.22	-13.00	-42.22
5556.0	-50.88	H	-59.78	4.82	13.15	-51.45	-13.00	-38.45
Middle Channel 9400 (1880.00MHz)								
3796.5	-51.10	V	-63.7	3.9	12.74	-54.86	-13.00	-41.86
5998.0	-47.49	V	-55.96	5.00	13.00	-47.96	-13.00	-34.96
3796.5	-51.47	H	-64.8	3.9	12.74	-55.96	-13.00	-42.96
5998.0	-51.18	H	-59.82	5.00	13.00	-51.82	-13.00	-38.82
High Channel 9538 (1907.60MHz)								
3813.5	-50.75	V	-63.22	4.00	12.74	-54.48	-13.00	-41.48
5726.0	-47.53	V	-56.23	4.87	13.11	-47.99	-13.00	-34.99
3813.5	-49.42	H	-62.28	4.00	12.74	-53.54	-13.00	-40.54
5726.0	-51.67	H	-60.39	4.87	13.11	-52.15	-13.00	-39.15

Product	GSM/GPRS/EDGE/HSDPA/HSUPA/HSPA+/RELEASE 8 MODULE		
Test Item	Spurious Emission		
Test Mode	Mode 8: HSDPA Band V Link		
Date of Test	2010/09/03	Test Site	AC-6

Frequency (MHz)	SA Reading (dBm)	Ant.Pol. (H/V)	SG Reading (dBm)	Cable Loss (dB)	Gain (dBi)	EIRP (dBm)	Limit (dBm)	Margin (dB)
Low Channel 4132 (826.40MHz)								
1603.5	-32.67	V	-49.52	2.45	9.50	-42.47	-13.00	-29.47
2496.0	-38.78	V	-51.67	3.18	10.58	-44.27	-13.00	-31.27
1603.5	-35.86	H	-52.85	2.45	9.50	-45.80	-13.00	-32.80
2496.0	-42.45	H	-55.30	3.18	10.58	-47.9	-13.00	-34.90
Middle Channel 4182 (836.40MHz)								
1595.0	-32.99	V	-49.74	2.46	9.41	-42.79	-13.00	-29.79
2487.5	-38.30	V	-51.15	3.16	10.52	-43.79	-13.00	-30.79
1595.0	-35.89	H	-52.78	2.46	9.41	-45.83	-13.00	-32.83
2487.5	-43.24	H	-56.05	3.16	10.52	-48.69	-13.00	-35.69
High Channel 4233 (846.6MHz)								
1603.5	-32.85	V	-49.69	2.45	9.50	-42.64	-13.00	-29.64
2496.0	-38.61	V	-51.50	3.18	10.58	-44.10	-13.00	-31.10
1603.5	-36.09	H	-53.04	2.45	9.50	-45.99	-13.00	-32.99
2496.0	-43.90	H	-56.75	3.18	10.58	-49.35	-13.00	-36.35

Product	GSM/GPRS/EDGE/HSDPA/HSUPA/HSPA+/RELEASE 8 MODULE		
Test Item	Spurious Emission		
Test Mode	Mode 09: HSUPA Band II Link		
Date of Test	2010/09/03	Test Site	AC-6

Frequency (MHz)	SA Reading (dBm)	Ant.Pol. (H/V)	SG Reading (dBm)	Cable Loss (dB)	Gain (dBi)	EIRP (dBm)	Limit (dBm)	Margin (dB)
Low Channel 9262 (1852.40MHz)								
3839.0	-50.88	V	-63.4	4.05	12.72	-54.73	-13.00	-41.73
5998.0	-47.79	V	-56.26	5.00	13.00	-48.26	-13.00	-35.26
3839.0	-50.84	H	-64.16	4.05	12.72	-55.49	-13.00	-42.49
5998.0	-51.10	H	-59.58	5.00	13.00	-51.58	-13.00	-38.58
Middle Channel 9400 (1880.00MHz)								
3779.5	-51.26	V	-64.29	3.90	12.74	-55.45	-13.00	-42.45
5522.0	-47.45	V	-56.23	4.82	13.14	-47.91	-13.00	-34.91
3779.5	-51.12	H	-64.14	3.90	12.74	-55.30	-13.00	-42.30
5522.0	-51.07	H	-60.00	4.82	13.14	-51.68	-13.00	-38.68
High Channel 9538 (1907.60MHz)								
3839.0	-50.95	V	-63.46	4.05	12.72	-54.79	-13.00	-41.79
5998.0	-47.11	V	-55.58	5.00	13.00	-47.58	-13.00	-34.58
3839.0	-51.09	H	-64.02	4.05	12.72	-55.35	-13.00	-42.35
5998.0	-51.95	H	-60.43	5.00	13.00	-52.43	-13.00	-39.43

Product	GSM/GPRS/EDGE/HSDPA/HSUPA/HSPA+/RELEASE 8 MODULE		
Test Item	Spurious Emission		
Test Mode	Mode 10: HSUPA Band V Link		
Date of Test	2010/09/03	Test Site	AC-6

Frequency (MHz)	SA Reading (dBm)	Ant.Pol. (H/V)	SG Reading (dBm)	Cable Loss (dB)	Gain (dBi)	EIRP (dBm)	Limit (dBm)	Margin (dB)
Low Channel 4132 (826.40MHz)								
1603.5	-32.78	V	-49.62	2.45	9.50	-42.57	-13.00	-29.57
2496.0	-38.81	V	-51.70	3.18	10.58	-44.30	-13.00	-31.30
1603.5	-35.69	H	-52.65	2.45	9.50	-45.60	-13.00	-32.60
2496.0	-42.99	H	-55.84	3.18	10.58	-48.44	-13.00	-35.44
Middle Channel 4182 (836.40MHz)								
1603.5	-32.62	V	-49.47	2.45	9.50	-42.42	-13.00	-29.42
2496.0	-38.89	V	-51.78	3.18	10.58	-44.38	-13.00	-31.38
1603.5	-36.08	H	-53.04	2.45	9.50	-45.99	-13.00	-32.99
2496.0	-43.02	H	-55.87	3.18	10.58	-48.47	-13.00	-35.47
High Channel 4233 (846.6MHz)								
1595.0	-32.79	V	-49.54	2.46	9.41	-42.59	-13.00	-29.59
2487.5	-38.85	V	-51.70	3.16	10.52	-44.34	-13.00	-31.34
1595.0	-35.93	H	-52.82	2.46	9.41	-45.87	-13.00	-32.87
2487.5	-42.79	H	-55.60	3.16	10.52	-48.24	-13.00	-35.24

7. Frequency Stability Under Temperature & Voltage Variations

7.1. Test Equipment

Frequency Stability Under Temperature & Voltage Variations / AC-6

Instrument	Manufacturer	Type No.	Serial No	Cal. Date
PSA Series Spectrum Analyzer	Agilent	E4440A	MY49420184	2010.04.10
Radio Communication Tester	R&S	CMU 200	117088	2010.07.12
Dual Directional Coupler	Agilent	778D	20160	2010.04.20
10dB Coaxial Coupler	Agilent	87300C	MY44300299	2010.04.20
DC Power Supply	IDRC	CD-035-020PR	977272	2009.10.21
Temperature & Humidity Chamber	Gaoyu	TH-1P-B	WIT-05121302	2010.01.19
Temperature/Humidity Meter	Zhicheng	ZC1-2	AC6-TH	2010.01.14

7.2. Test Setup

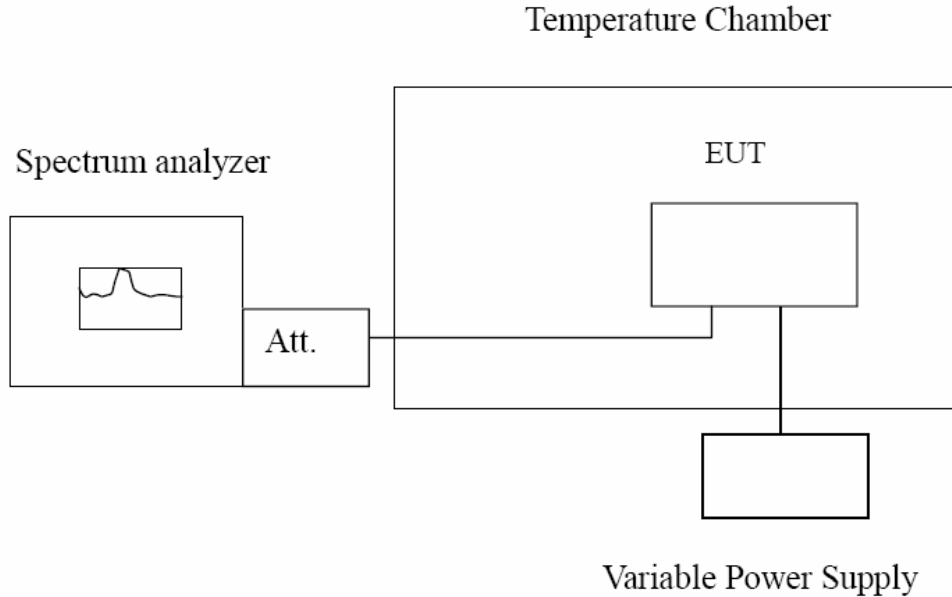

7.3. Limit

The frequency stability shall be sufficient to ensure that the fundamental emission stays within the authorized frequency block.

Limit	$< \pm 2.5 \text{ ppm}$
-------	-------------------------

7.4. Test Procedure

Frequency Stability Under Temperature Variations:

The equipment under test was connected to an external AC or DC power supply and input rated voltage. RF output was connected to a frequency counter or spectrum analyzer via feed through attenuators. The EUT was placed inside the temperature chamber. Set the spectrum analyzer RBW low enough to obtain the desired frequency resolution and measure EUT 20°C operating frequency as reference frequency. Turn EUT off and set the chamber temperature to -30°C. After the temperature stabilized for approximately 30 minutes recorded the frequency. Repeat step measure with 10°C increased per stage until the highest temperature of +50°C reached.

Frequency Stability Under Voltage Variations:

Set chamber temperature to 20°C. Use a variable AC power supply / DC power source to power the EUT and set the voltage to rated voltage. Set the spectrum analyzer RBW low enough to obtain the desired frequency resolution and recorded the frequency. Reduce the input voltage to specify extreme voltage variation ($\pm 15\%$) and endpoint, record the maximum frequency change.

7.5. Uncertainty

The measurement uncertainty is defined as $\pm 10 \text{ Hz}$.

7.6. Test Result

Product	GSM/GPRS/EDGE/HSDPA/HSUPA/HSPA+/RELEASE 8 MODULE		
Test Item	Frequency Stability Under Temperature & Voltage Variations		
Test Mode	Mode 1: GSM850 GPRS Link		
Date of Test	2009/09/01	Test Site	AC-6

Frequency Stability under Temperature

Temperature Interval (°C)	Test Frequency (MHz)	Deviation (Hz)	Limit (kHz)
-30	836.40	47	± 2091
-20	836.40	43	± 2091
-10	836.40	39	± 2091
0	836.40	36	± 2091
10	836.40	40	± 2091
20	836.40	42	± 2091
30	836.40	45	± 2091
40	836.40	48	± 2091
50	836.40	52	± 2091

Frequency Stability under Voltage

DC Voltage (V)	Test Frequency (MHz)	Deviation (Hz)	Limit (KHz)
3.795	836.40	39	± 2091
3.300	836.40	36	± 2091
2.805	836.40	41	± 2091

Product	GSM/GPRS/EDGE/HSDPA/HSUPA/HSPA+/RELEASE 8 MODULE		
Test Item	Frequency Stability Under Temperature & Voltage Variations		
Test Mode	Mode 2: GSM850 EDGE Link		
Date of Test	2009/09/01	Test Site	AC-6

Frequency Stability under Temperature

Temperature Interval (°C)	Test Frequency (MHz)	Deviation (Hz)	Limit (kHz)
-30	836.40	44	± 2091
-20	836.40	35	± 2091
-10	836.40	25	± 2091
0	836.40	30	± 2091
10	836.40	28	± 2091
20	836.40	32	± 2091
30	836.40	35	± 2091
40	836.40	40	± 2091
50	836.40	46	± 2091

Frequency Stability under Voltage

DC Voltage (V)	Test Frequency (MHz)	Deviation (Hz)	Limit (KHz)
3.795	836.40	-41	± 2091
3.300	836.40	30	± 2091
2.805	836.40	-46	± 2091

Product	GSM/GPRS/EDGE/HSDPA/HSUPA/HSPA+/RELEASE 8 MODULE		
Test Item	Frequency Stability Under Temperature & Voltage Variations		
Test Mode	Mode 3: PCS1900 GPRS Link		
Date of Test	2009/09/01	Test Site	AC-6

Frequency Stability under Temperature

Temperature Interval (°C)	Test Frequency (MHz)	Deviation (Hz)	Limit (Hz)
-30	1880.00	56	± 4700
-20	1880.00	54	± 4700
-10	1880.00	45	± 4700
0	1880.00	48	± 4700
10	1880.00	41	± 4700
20	1880.00	47	± 4700
30	1880.00	50	± 4700
40	1880.00	55	± 4700
50	1880.00	58	± 4700

Frequency Stability under Voltage

DC Voltage (V)	Test Frequency (MHz)	Deviation (Hz)	Limit (KHz)
3.795	1880.00	47	± 4700
3.300	1880.00	48	± 4700
2.805	1880.00	50	± 4700

Product	GSM/GPRS/EDGE/HSDPA/HSUPA/HSPA+/RELEASE 8 MODULE		
Test Item	Frequency Stability Under Temperature & Voltage Variations		
Test Mode	Mode 4: PCS1900 EDGE Link		
Date of Test	2009/09/01	Test Site	AC-6

Frequency Stability under Temperature

Temperature Interval (°C)	Test Frequency (MHz)	Deviation (Hz)	Limit (Hz)
-30	1880.00	59	± 4700
-20	1880.00	55	± 4700
-10	1880.00	50	± 4700
0	1880.00	54	± 4700
10	1880.00	51	± 4700
20	1880.00	58	± 4700
30	1880.00	62	± 4700
40	1880.00	68	± 4700
50	1880.00	69	± 4700

Frequency Stability under Voltage

DC Voltage (V)	Test Frequency (MHz)	Deviation (Hz)	Limit (KHz)
3.795	1880.00	55	± 4700
3.300	1880.00	54	± 4700
2.805	1880.00	58	± 4700

Product	GSM/GPRS/EDGE/HSDPA/HSUPA/HSPA+/RELEASE 8 MODULE		
Test Item	Frequency Stability Under Temperature & Voltage Variations		
Test Mode	Mode 5: WCDMA Band II Link		
Date of Test	2009/09/01	Test Site	AC-6

Frequency Stability under Temperature

Temperature Interval (°C)	Test Frequency (MHz)	Deviation (Hz)	Limit (Hz)
-30	1880.00	-41	± 4700
-20	1880.00	-34	± 4700
-10	1880.00	-31	± 4700
0	1880.00	-24	± 4700
10	1880.00	-27	± 4700
20	1880.00	-19	± 4700
30	1880.00	-22	± 4700
40	1880.00	-29	± 4700
50	1880.00	-37	± 4700

Frequency Stability under Voltage

DC Voltage (V)	Test Frequency (MHz)	Deviation (Hz)	Limit (KHz)
3.795	1880.00	-30	± 4700
3.300	1880.00	-26	± 4700
2.805	1880.00	-41	± 4700

Product	GSM/GPRS/EDGE/HSDPA/HSUPA/HSPA+/RELEASE 8 MODULE		
Test Item	Frequency Stability Under Temperature & Voltage Variations		
Test Mode	Mode 6: WCDMA Band V Link		
Date of Test	2009/09/01	Test Site	AC-6

Frequency Stability under Temperature

Temperature Interval (°C)	Test Frequency (MHz)	Deviation (Hz)	Limit (kHz)
-30	836.40	-43	± 2091
-20	836.40	-28	± 2091
-10	836.40	-36	± 2091
0	836.40	-32	± 2091
10	836.40	-25	± 2091
20	836.40	-19	± 2091
30	836.40	-33	± 2091
40	836.40	-24	± 2091
50	836.40	-37	± 2091

Frequency Stability under Voltage

DC Voltage (V)	Test Frequency (MHz)	Deviation (Hz)	Limit (KHz)
3.795	836.40	-39	± 2091
3.300	836.40	-34	± 2091
2.805	836.40	-42	± 2091

Product	GSM/GPRS/EDGE/HSDPA/HSUPA/HSPA+/RELEASE 8 MODULE		
Test Item	Frequency Stability Under Temperature & Voltage Variations		
Test Mode	Mode 7: HSDPA Band II Link		
Date of Test	2009/09/01	Test Site	AC-6

Frequency Stability under Temperature

Temperature Interval (°C)	Test Frequency (MHz)	Deviation (Hz)	Limit (Hz)
-30	1880.00	-47	± 4700
-20	1880.00	-36	± 4700
-10	1880.00	-27	± 4700
0	1880.00	-23	± 4700
10	1880.00	-21	± 4700
20	1880.00	-25	± 4700
30	1880.00	-19	± 4700
40	1880.00	-28	± 4700
50	1880.00	-35	± 4700

Frequency Stability under Voltage

DC Voltage (V)	Test Frequency (MHz)	Deviation (Hz)	Limit (KHz)
3.795	1880.00	-44	± 4700
3.300	1880.00	-22	± 4700
2.805	1880.00	-40	± 4700

Product	GSM/GPRS/EDGE/HSDPA/HSUPA/HSPA+/RELEASE 8 MODULE		
Test Item	Frequency Stability Under Temperature & Voltage Variations		
Test Mode	Mode 8: HSDPA Band V Link		
Date of Test	2009/09/01	Test Site	AC-6

Frequency Stability under Temperature

Temperature Interval (°C)	Test Frequency (MHz)	Deviation (Hz)	Limit (kHz)
-30	836.40	-45	± 2091
-20	836.40	-36	± 2091
-10	836.40	-25	± 2091
0	836.40	-26	± 2091
10	836.40	-29	± 2091
20	836.40	-18	± 2091
30	836.40	-16	± 2091
40	836.40	-28	± 2091
50	836.40	-35	± 2091

Frequency Stability under Voltage

DC Voltage (V)	Test Frequency (MHz)	Deviation (Hz)	Limit (KHz)
3.795	836.40	-41	± 2091
3.300	836.40	-27	± 2091
2.805	836.40	-44	± 2091

Product	GSM/GPRS/EDGE/HSDPA/HSUPA/HSPA+/RELEASE 8 MODULE		
Test Item	Frequency Stability Under Temperature & Voltage Variations		
Test Mode	Mode 09: HSUPA Band II Link		
Date of Test	2009/09/01	Test Site	AC-6

Frequency Stability under Temperature

Temperature Interval (°C)	Test Frequency (MHz)	Deviation (Hz)	Limit (Hz)
-30	836.52	-43	± 2091
-20	836.52	-34	± 2091
-10	836.52	-31	± 2091
0	836.52	-24	± 2091
10	836.52	-25	± 2091
20	836.52	-19	± 2091
30	836.52	-22	± 2091
40	836.52	-29	± 2091
50	836.52	-39	± 2091

Frequency Stability under Voltage

DC Voltage (V)	Test Frequency (MHz)	Deviation (Hz)	Limit (KHz)
3.795	836.52	-32	± 2091
3.300	836.52	-26	± 2091
2.805	836.52	-40	± 2091

Product	GSM/GPRS/EDGE/HSDPA/HSUPA/HSPA+/RELEASE 8 MODULE		
Test Item	Frequency Stability Under Temperature & Voltage Variations		
Test Mode	Mode 10: HSUPA Band V Link		
Date of Test	2009/09/01	Test Site	AC-6

Frequency Stability under Temperature

Temperature Interval (°C)	Test Frequency (MHz)	Deviation (Hz)	Limit (kHz)
-30	1880.00	-45	± 4700
-20	1880.00	-29	± 4700
-10	1880.00	-36	± 4700
0	1880.00	-32	± 4700
10	1880.00	-24	± 4700
20	1880.00	-11	± 4700
30	1880.00	-33	± 4700
40	1880.00	-26	± 4700
50	1880.00	-38	± 4700

Frequency Stability under Voltage

DC Voltage (V)	Test Frequency (MHz)	Deviation (Hz)	Limit (KHz)
3.795	1880.00	-34	± 2091
3.300	1880.00	-16	± 2091
2.805	1880.00	-32	± 2091

8. Receiver Spurious Emission for RSS 132/133

8.1. Test Equipment

Spurious Emission / AC-5

Instrument	Manufacturer	Type No.	Serial No	Cal. Date
Spectrum Analyzer	Agilent	N9010A	MY48030494	2009.04.23
Radio Communication Tester	R&S	CMU 200	106388	2010.10.21
Preamplifier	Quietek	AP-025C	CHM-0503006	2010.05.05
Preamplifier	Miteq	NSP1800-25	1364185	2010.05.05
Bilog Antenna	Teseq GmbH	CBL6112D	27612	2009.11.12
Broad-Band Horn Antenna	Schwarzbeck	BBHA9120D	499	2009.11.24
Temperature/Humidity Meter	Zhicheng	ZC1-2	AC5-TH	2010.01.14

8.2. Test Setup

Under 1GHz Test Setup:

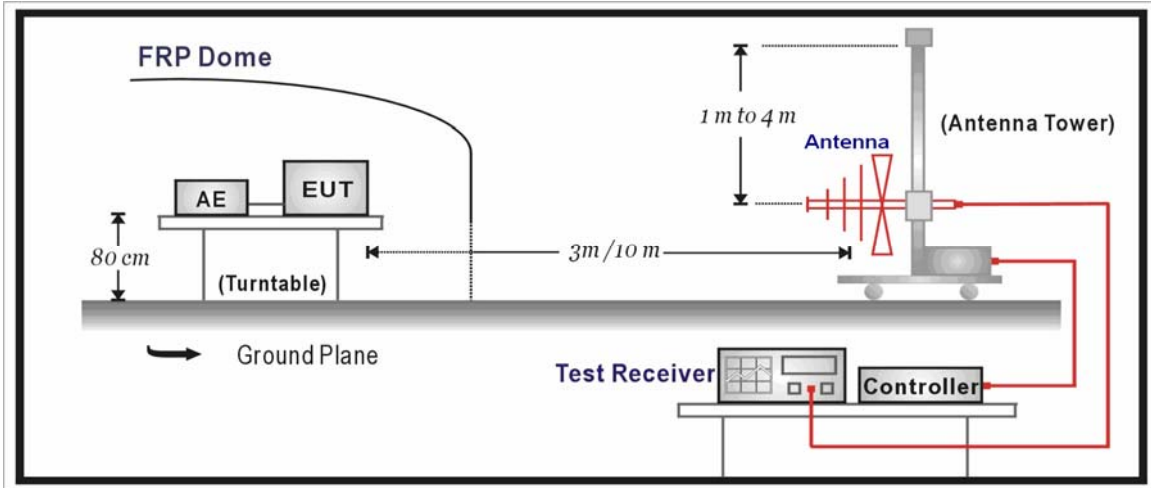

Above 1GHz Test Setup:

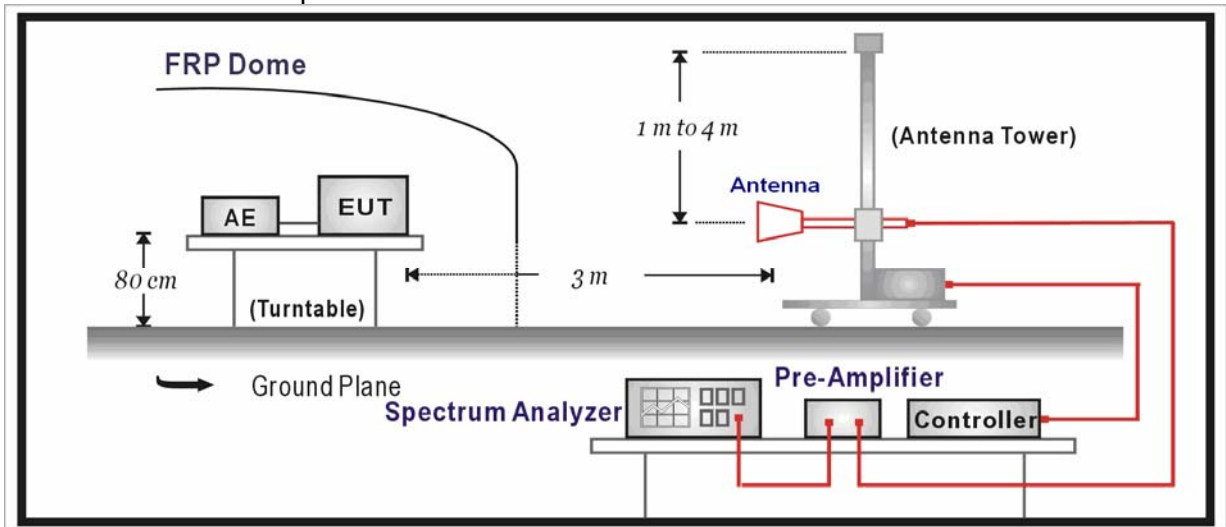

8.3. Limit

According to Standard RSS132/133 refer to RSS-Gen Issue 2.

Field Strength micro-volts/m at 3 meters		
Frequency (MHz)	Distance (m)	Level (dBuV/m)
30 - 88	3	40
88 - 216	3	43.5
216 - 960	3	46
Above 960	3	54

Note 1: The lower limit shall apply at the transition frequency.

Note 2: Distance refers to the distance in meters between the measuring instrument antenna and the closed point of any part of the device or system.

Note 3: E field strength (dBuV/m) = 20 log E field strength (uV/m)

8.4. Test Procedure

The EUT and its simulators are placed on a turn table which is 0.8 meter above ground. The turn table can rotate 360 degrees to determine the position of the maximum emission level. The EUT was positioned such that the distance from antenna to the EUT was 10 meters. The antenna can move up and down between 1 meter and 4 meters to find out the maximum emission level.

Both horizontal and vertical polarization of the antenna are set on measurement. In order to find the maximum emission, all of the interface cables must be manipulated on radiated measurement.

On any frequency or frequencies below or equal to 1000 MHz, the radiated limits shown are based on measuring equipment employing a quasi-peak detector function and above 1000 MHz, the radiated limits shown are based measuring equipment employing an average detector function.

When average radiated emission measurement are included emission measurement Above 1000 MHz, there also is a limit on the radio frequency emissions, as measured using instrumentation with a peak detector function, corresponding to 20 dB above the maximum permitted average limit.

For class A, the measurement distance between the EUT and antenna is 10 meters for under

1GHz and above 1GHz.

For class B, the measurement distance between the EUT and antenna is 10 meters for under 1GHz and 3 meters for above 1GHz.

The bandwidth below 1GHz setting on the field strength meter (R&S Test Receiver ESCI) is 120 kHz and above 1GHz is 1MHz.

Note: When measurement above 1GHz, the horn antenna will bend down a little (as horn antenna have the narrow beamwidth) in order to find the maximum emission of EUT

8.5. Uncertainty

The measurement uncertainty is defined as 3.2 dB for Radiated Power Measurement.

8.6. Test Result

No significant emissions measurable. Plots reported here represent the worse case emissions.

Engineer: Aileen	
Site: AC2	Time: 2010/08/30 - 11:12
Limit: RSS_GEN_Radiation_03M_QP	Margin: 0
Probe: CBL6112D_(30-2000MHz) - HORIZONTAL	Polarity: Horizontal
EUT:GSM/GPRS/EDGE/HSDPA/HSUPA/HSPA+/REL EASE 8 MODULE	Power: DC 3.3V
Note: Mode 1: GPRS 850 (Using Peak detector)	

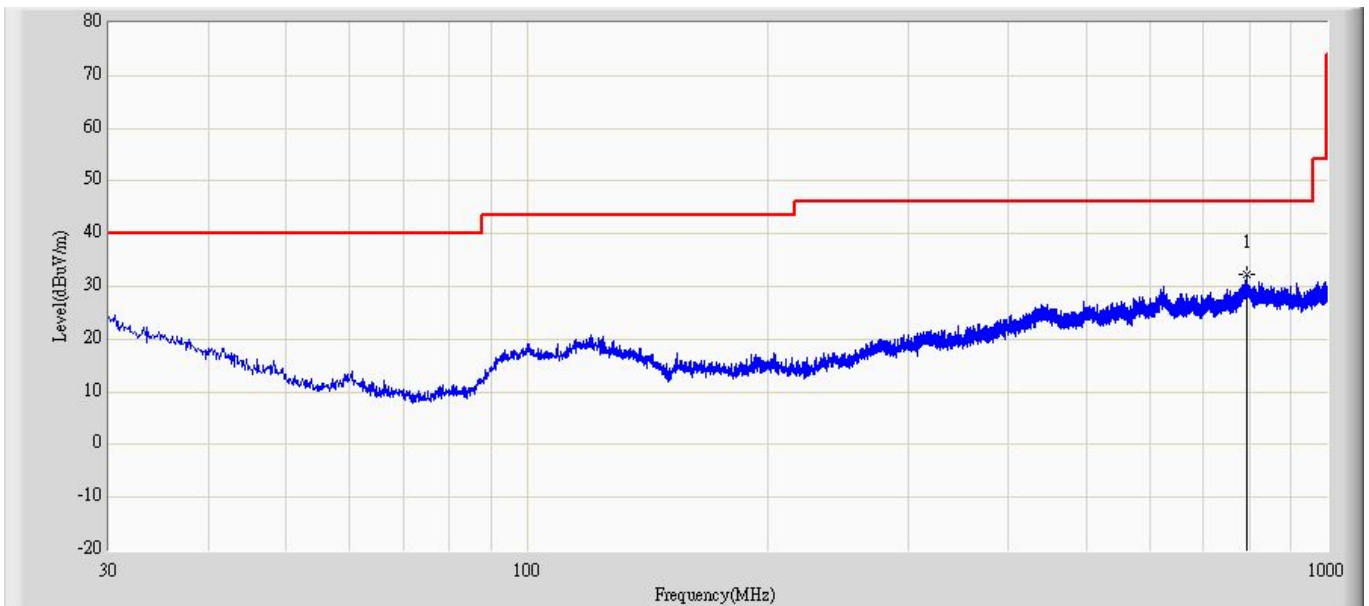

This plot is valid for low, mid & high channels (worst-case plot).

Engineer: Aileen	
Site: AC2	Time: 2010/08/30 - 11:14
Limit: RSS_GEN_Radiation_03M_QP	Margin: 0
Probe: CBL6112D_(30-2000MHz) - HORIZONTAL	Polarity: Vertical
EUT:GSM/GPRS/EDGE/HSDPA/HSUPA/HSPA+/REL EASE 8 MODULE	Power: DC 3.3V
Note: Mode 1: GPRS 850 (Using Peak detector)	

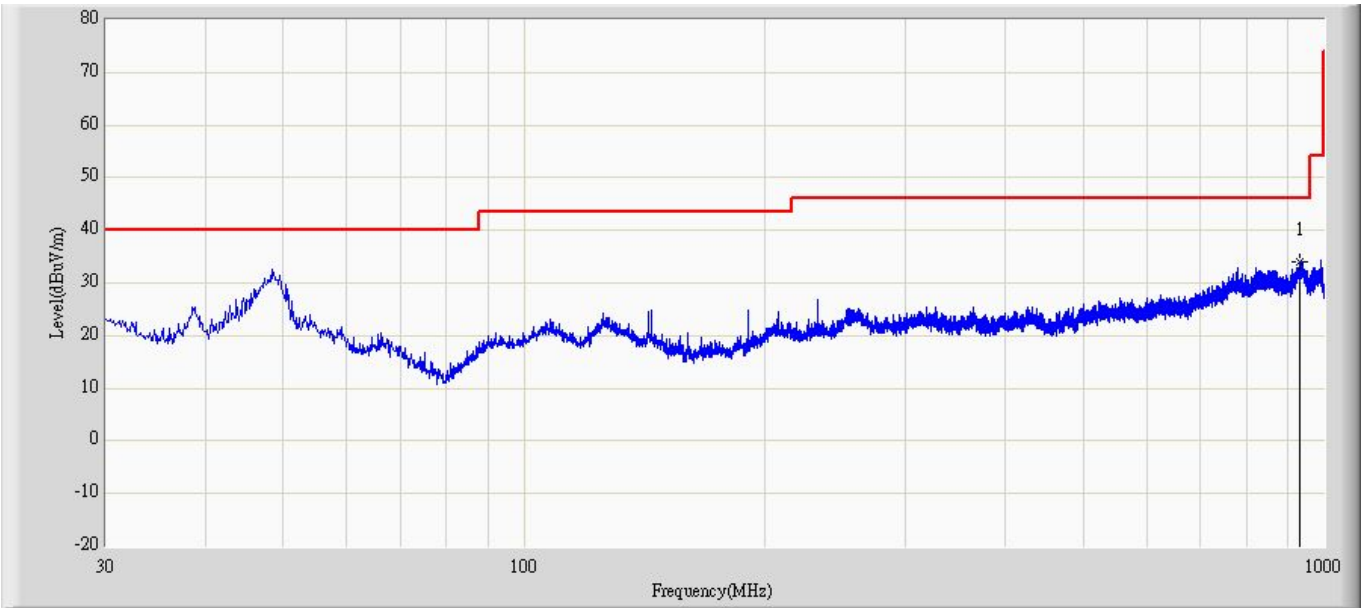

This plot is valid for low, mid & high channels (worst-case plot).

Engineer: Aileen	
Site: AC5	Time: 2010/08/30 - 10:51
Limit: RSS_GEN_Radiation_03M_PK	Margin: 0
Probe: BBHA9120D_499(1-18GHz)	Polarity: Horizontal
EUT:GSM/GPRS/EDGE/HSDPA/HSUPA/HSPA+/REL EASE 8 MODULE	Power: DC 3.3V
Note: Mode 1: GPRS 850 (Using Peak detector)	

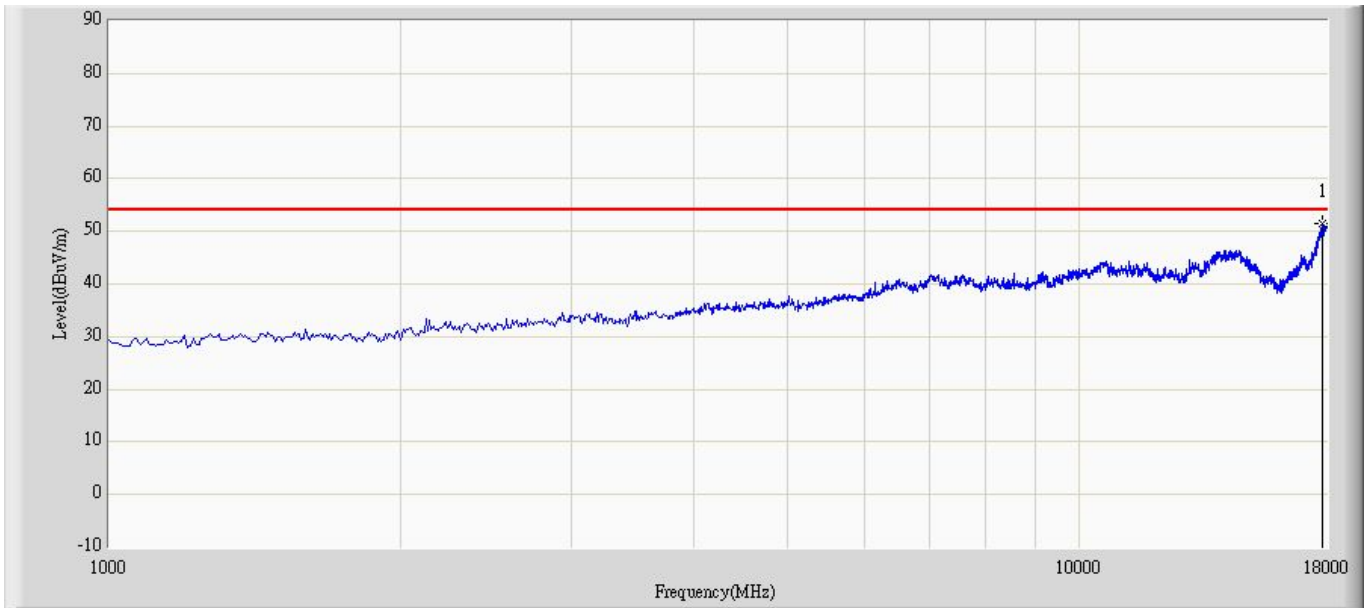

This plot is valid for low, mid & high channels (worst-case plot).

Engineer: Aileen	
Site: AC5	Time: 2010/08/30 - 10:55
Limit: RSS_GEN_Radiation_03M_PK	Margin: 0
Probe: BBHA9120D_499(1-18GHz)	Polarity: Vertical
EUT:GSM/GPRS/EDGE/HSDPA/HSUPA/HSPA+/REL EASE 8 MODULE	Power: DC 3.3V
Note: Mode 1: GPRS 850 (Using Peak detector)	

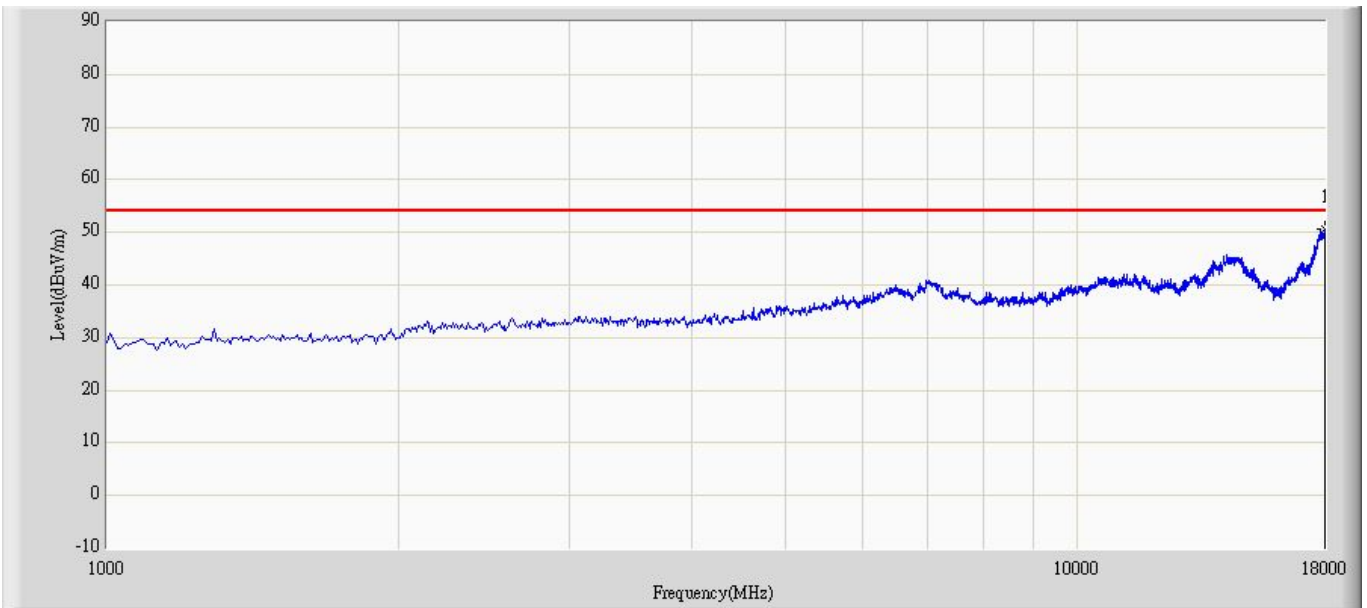

This plot is valid for low, mid & high channels (worst-case plot).

Engineer: Aileen	
Site: AC2	Time: 2010/08/30 - 11:17
Limit: RSS_GEN_Radiation_03M_QP	Margin: 0
Probe: CBL6112D_(30-2000MHz) - HORIZONTAL	Polarity: Horizontal
EUT:GSM/GPRS/EDGE/HSDPA/HSUPA/HSPA+/REL EASE 8 MODULE	Power: DC 3.3V
Note: Mode 2: GPRS 1900 (Using Peak detector)	

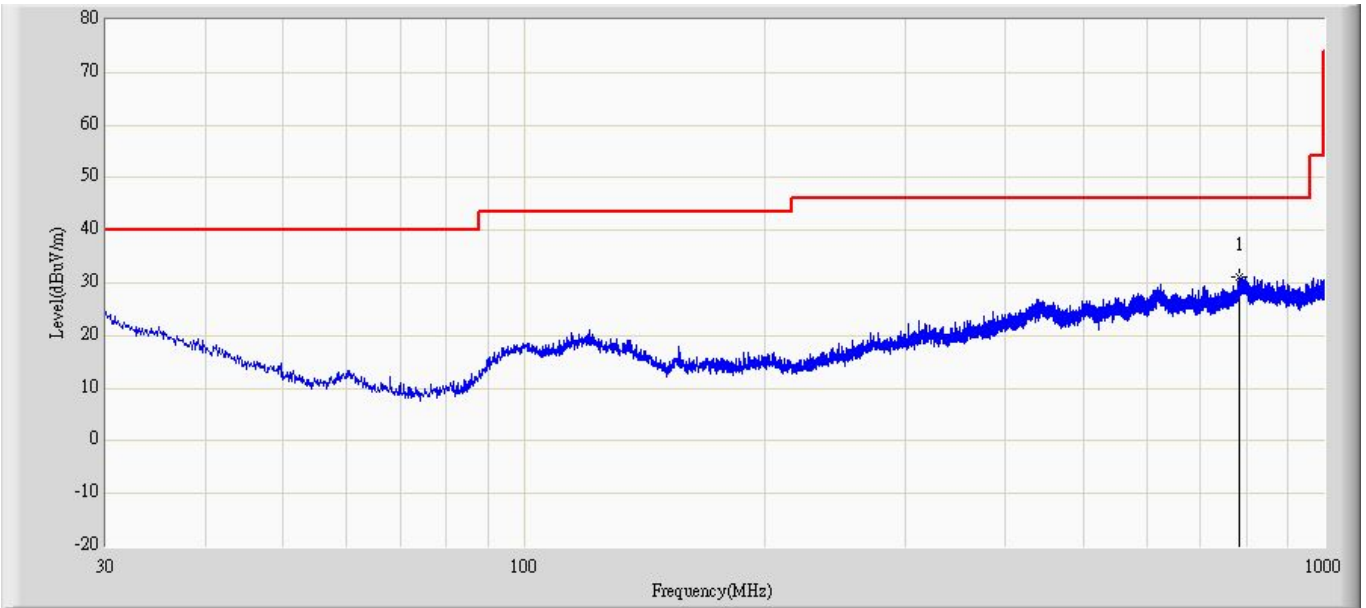

This plot is valid for low, mid & high channels (worst-case plot).

Engineer: Aileen	
Site: AC2	Time: 2010/08/30 - 11:16
Limit: RSS_GEN_Radiation_03M_QP	Margin: 0
Probe: CBL6112D_(30-2000MHz) - HORIZONTAL	Polarity: Vertical
EUT:GSM/GPRS/EDGE/HSDPA/HSUPA/HSPA+/REL EASE 8 MODULE	Power: DC 3.3V
Note: Mode 2: GPRS 1900 (Using Peak detector)	

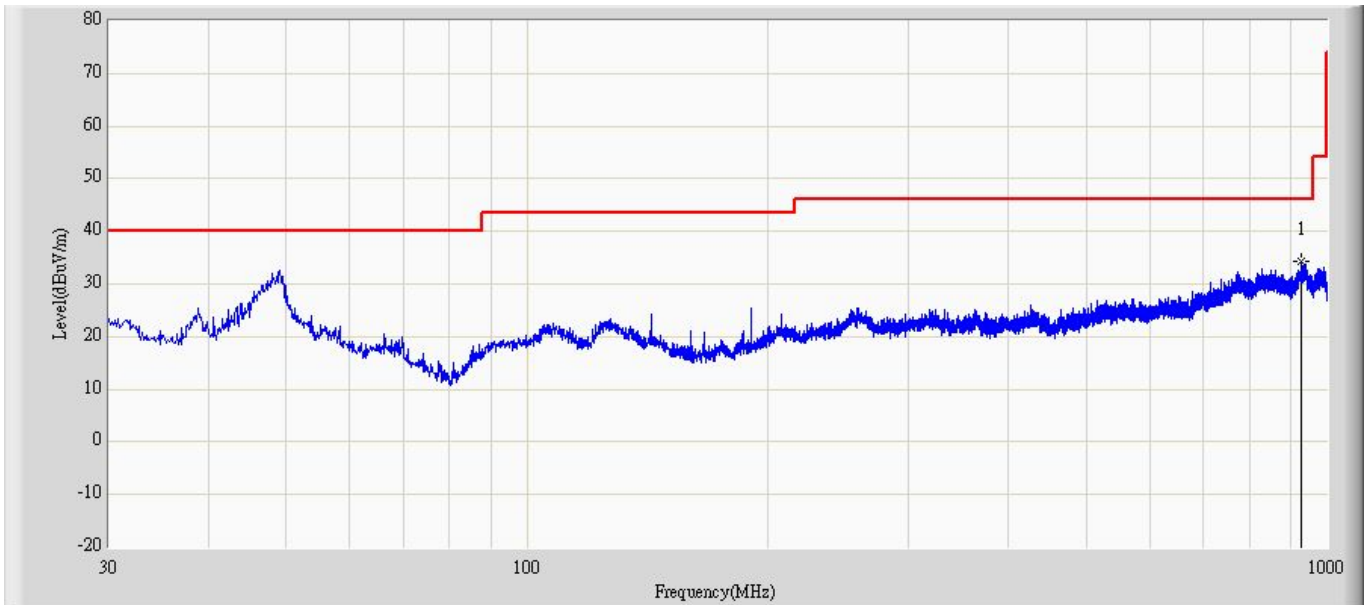

This plot is valid for low, mid & high channels (worst-case plot).

Engineer: Aileen	
Site: AC5	Time: 2010/08/30 - 10:56
Limit: RSS_GEN_Radiation_03M_PK	Margin: 0
Probe: BBHA9120D_499(1-18GHz)	Polarity: Horizontal
EUT:GSM/GPRS/EDGE/HSDPA/HSUPA/HSPA+/REL EASE 8 MODULE	Power: DC 3.3V
Note: Mode 2: GPRS 1900 (Using Peak detector)	

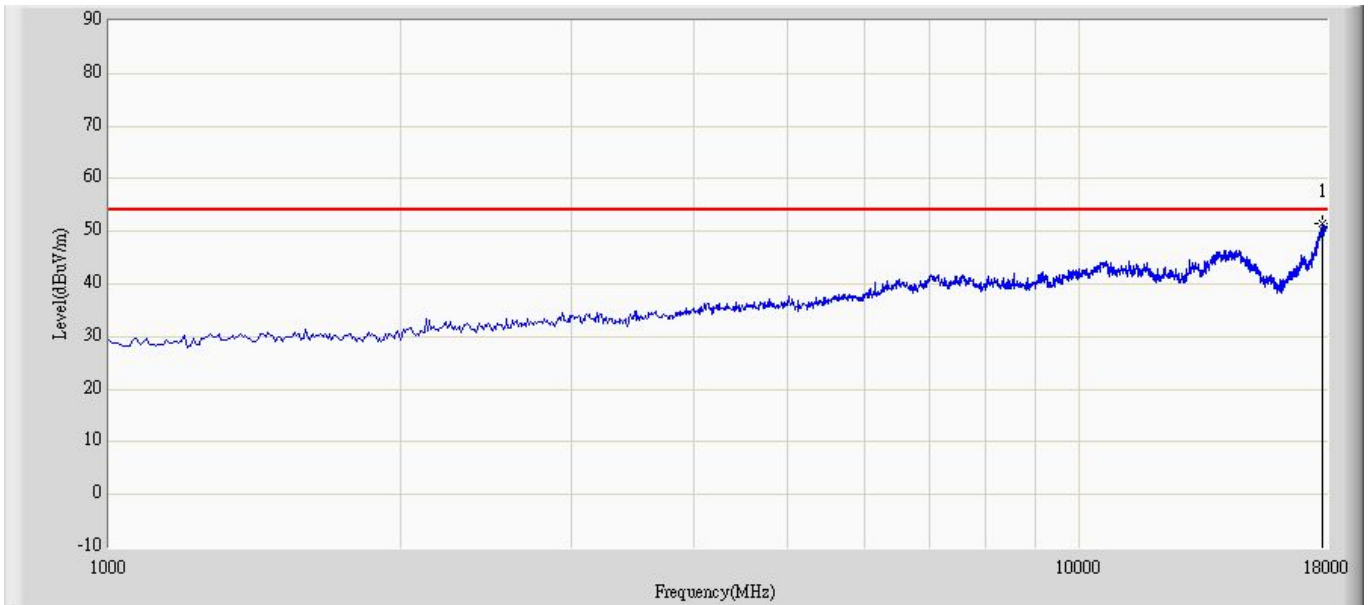

This plot is valid for low, mid & high channels (worst-case plot).

Engineer: Aileen	
Site: AC5	Time: 2010/08/30 - 10:56
Limit: RSS_GEN_Radiation_03M_PK	Margin: 0
Probe: BBHA9120D_499(1-18GHz)	Polarity: Vertical
EUT:GSM/GPRS/EDGE/HSDPA/HSUPA/HSPA+/REL EASE 8 MODULE	Power: DC 3.3V
Note: Mode 2: GPRS 1900 (Using Peak detector)	

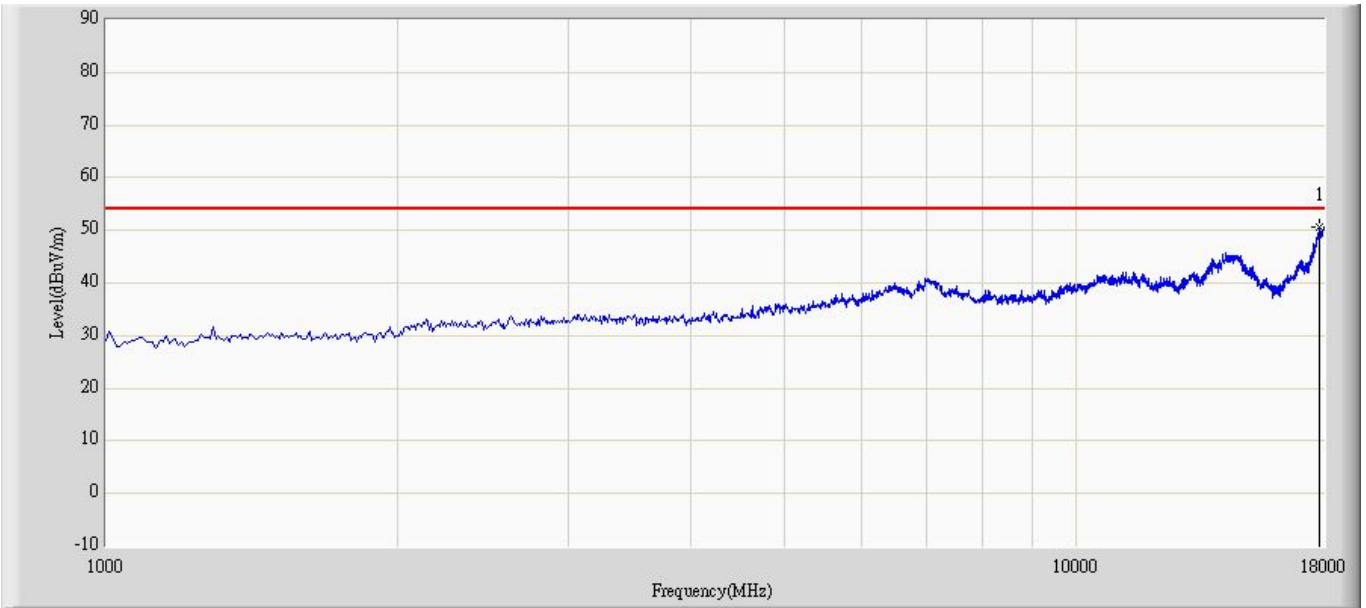

This plot is valid for low, mid & high channels (worst-case plot).

Engineer: Aileen	
Site: AC2	Time: 2010/08/30 - 11:19
Limit: RSS_GEN_Radiation_03M_QP	Margin: 0
Probe: CBL6112D_(30-2000MHz) - HORIZONTAL	Polarity: Horizontal
EUT:GSM/GPRS/EDGE/HSDPA/HSUPA/HSPA+/REL EASE 8 MODULE	Power: DC 3.3V
Note: Mode 3: WCDMA Band II (Using Peak detector)	

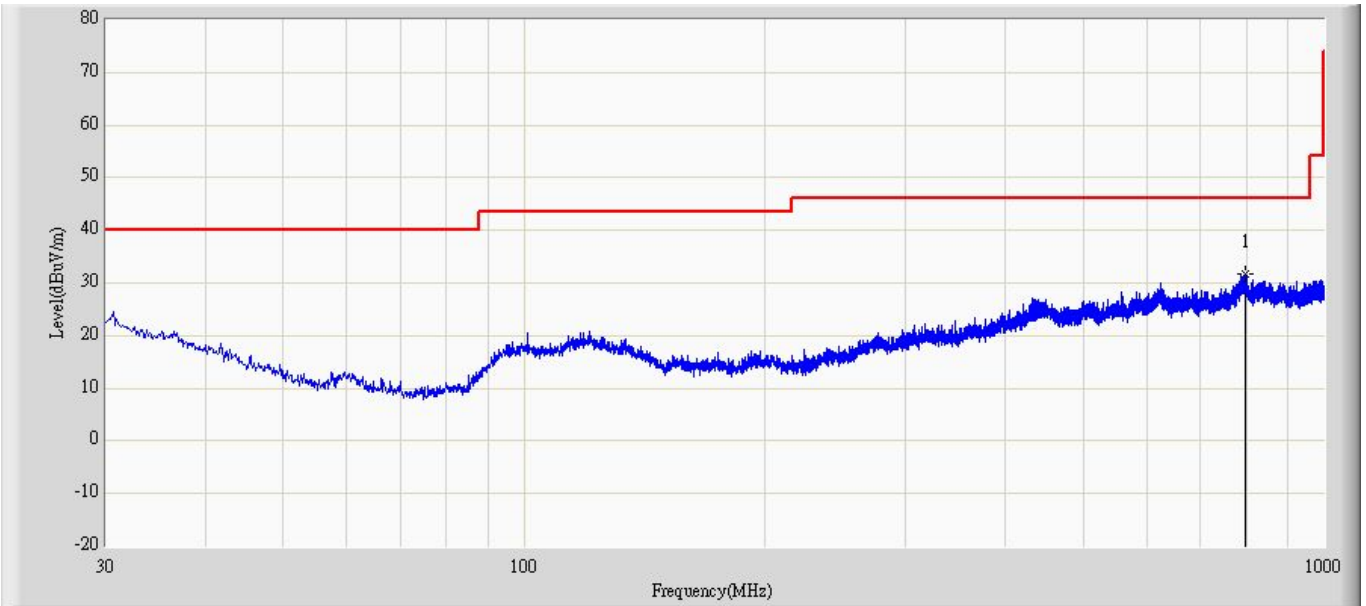

This plot is valid for low, mid & high channels (worst-case plot).

Engineer: Aileen	
Site: AC2	Time: 2010/08/30 - 11:20
Limit: RSS_GEN_Radiation_03M_QP	Margin: 0
Probe: CBL6112D_(30-2000MHz) - HORIZONTAL	Polarity: Vertical
EUT:GSM/GPRS/EDGE/HSDPA/HSUPA/HSPA+/REL EASE 8 MODULE	Power: DC 3.3V
Note: Mode 3: WCDMA Band II (Using Peak detector)	

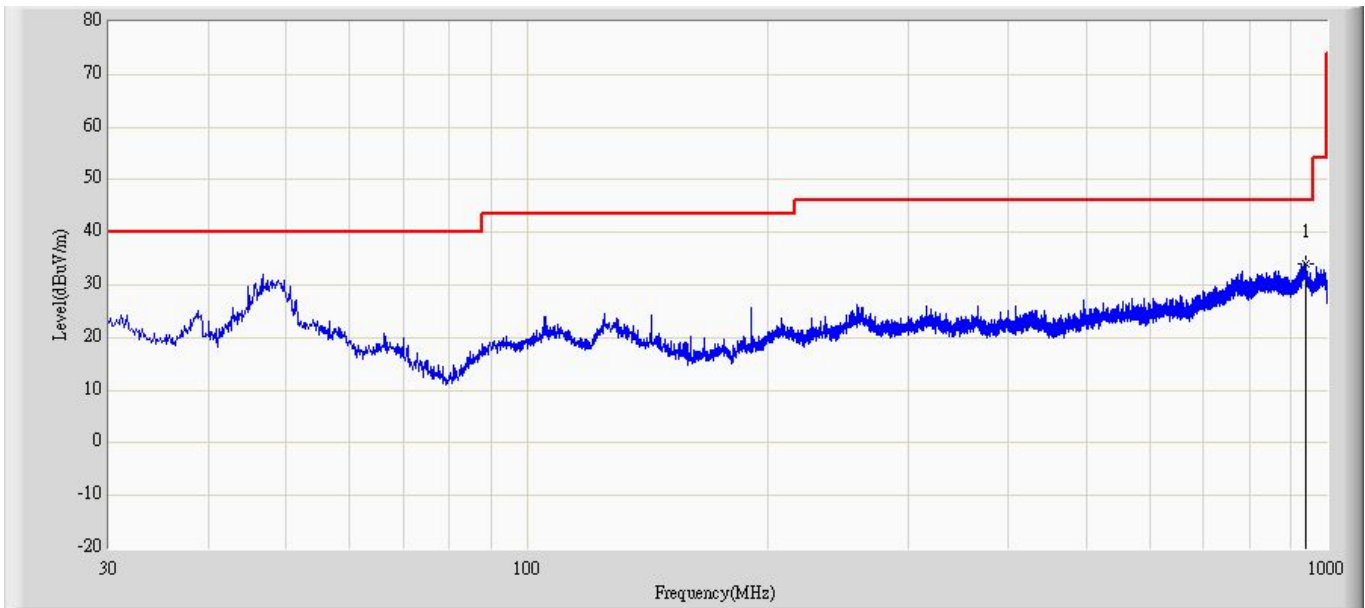

This plot is valid for low, mid & high channels (worst-case plot).

Engineer: Aileen	
Site: AC5	Time: 2010/08/30 - 10:56
Limit: RSS_GEN_Radiation_03M_PK	Margin: 0
Probe: BBHA9120D_499(1-18GHz)	Polarity: Horizontal
EUT:GSM/GPRS/EDGE/HSDPA/HSUPA/HSPA+/REL EASE 8 MODULE	Power: DC 3.3V
Note: Mode 3: WCDMA FDD II (Using Peak detector)	

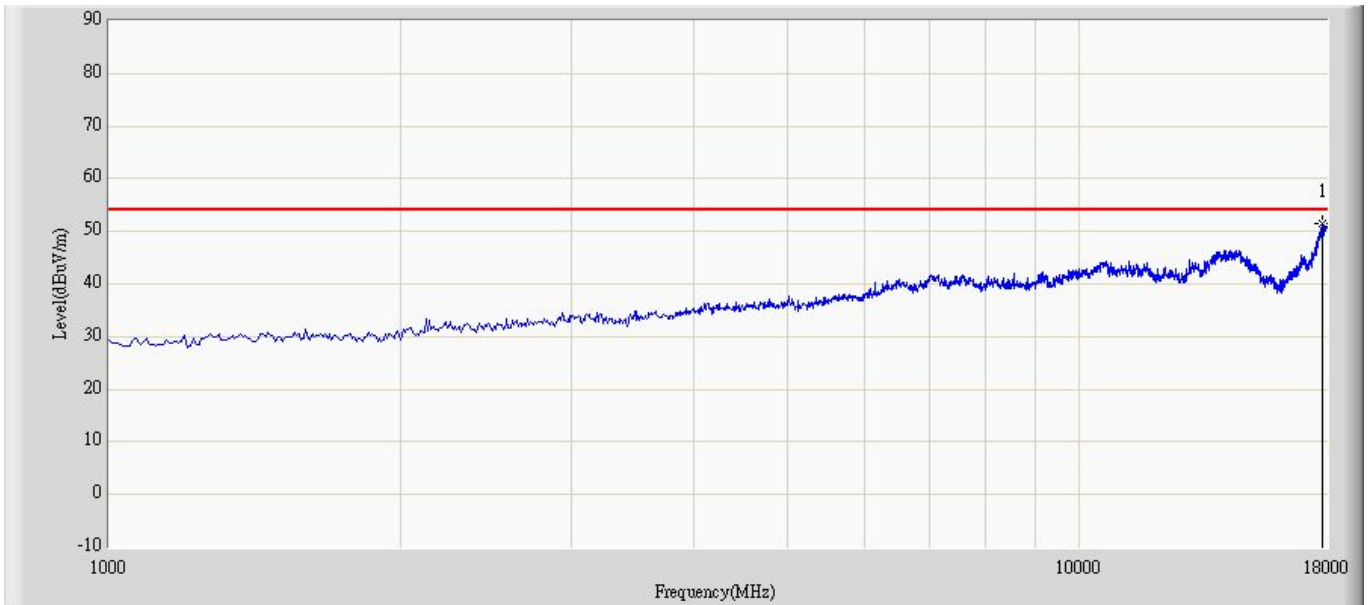

This plot is valid for low, mid & high channels (worst-case plot).

Profile: 108S040R		Page No.: 8	
Engineer: Aileen			
Site: AC5		Time: 2010/08/30 - 10:56	
Limit: RSS_GEN_Radiation_03M_PK		Margin: 0	
Probe: BBHA9120D_499(1-18GHz)		Polarity: Vertical	
EUT:GSM/GPRS/EDGE/HSDPA/HSUPA/HSPA+/REL EASE 8 MODULE		Power: DC 3.3V	
Note: Mode 3: WCDMA FDD II (Using Peak detector)			



This plot is valid for low, mid & high channels (worst-case plot).

Engineer: Aileen	
Site: AC2	Time: 2010/08/30 - 11:25
Limit: RSS_GEN_Radiation_03M_QP	Margin: 0
Probe: CBL6112D_(30-2000MHz) - HORIZONTAL	Polarity: Horizontal
EUT:GSM/GPRS/EDGE/HSDPA/HSUPA/HSPA+/REL EASE 8 MODULE	Power: DC 3.3V
Note: Mode 4: WCDMA Band V (Using Peak detector)	

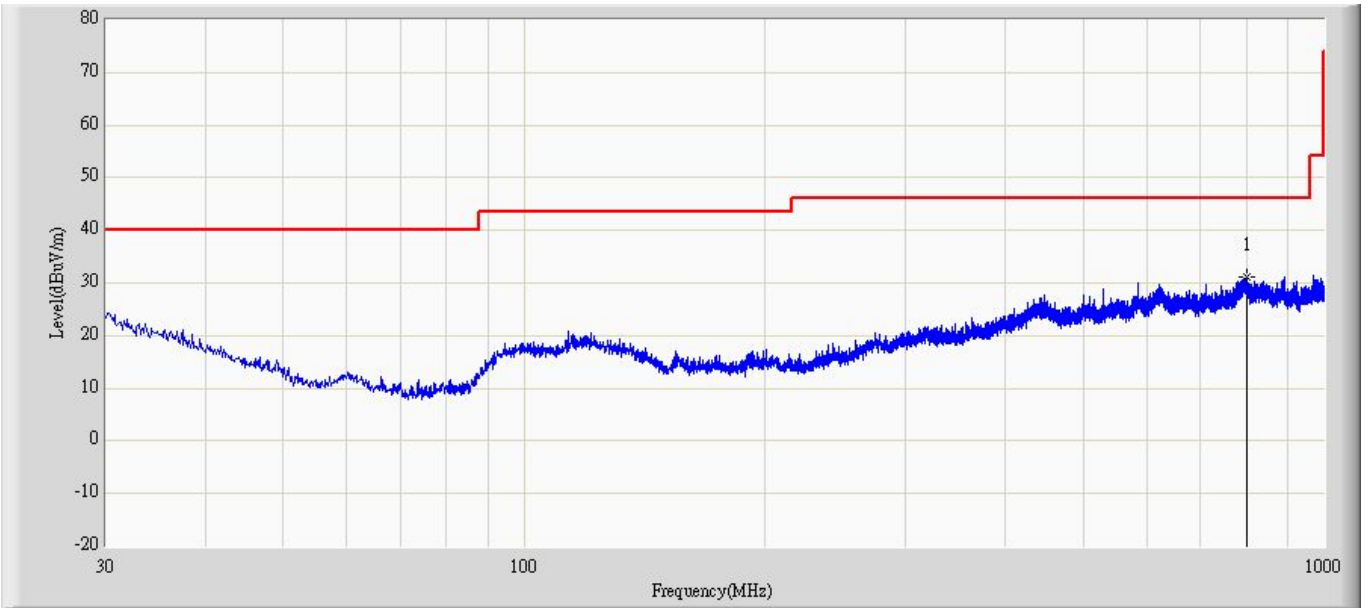

This plot is valid for low, mid & high channels (worst-case plot).

Engineer: Aileen	
Site: AC2	Time: 2010/08/30 - 11:21
Limit: RSS_GEN_Radiation_03M_QP	Margin: 0
Probe: CBL6112D_(30-2000MHz) - HORIZONTAL	Polarity: Vertical
EUT:GSM/GPRS/EDGE/HSDPA/HSUPA/HSPA+/REL EASE 8 MODULE	Power: DC 3.3V
Note: Mode 4: WCDMA Band V (Using Peak detector)	

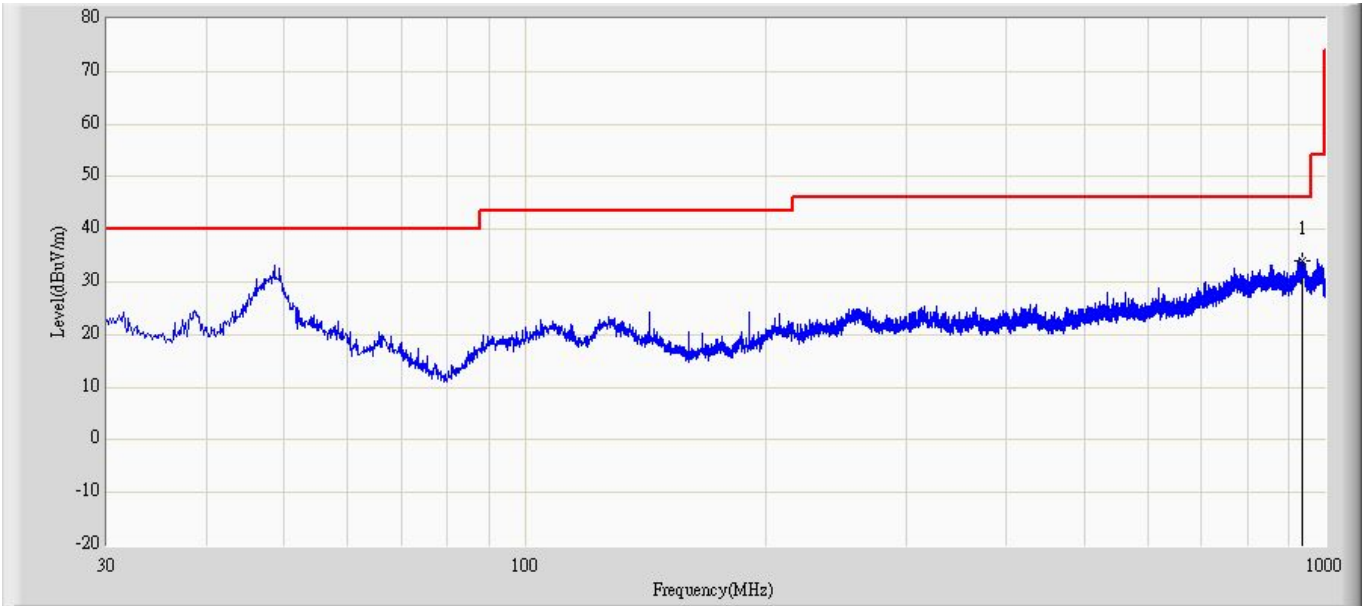

This plot is valid for low, mid & high channels (worst-case plot).

Engineer: Aileen	
Site: AC5	Time: 2010/08/30 - 10:57
Limit: RSS_GEN_Radiation_03M_PK	Margin: 0
Probe: BBHA9120D_499(1-18GHz)	Polarity: Horizontal
EUT:GSM/GPRS/EDGE/HSDPA/HSUPA/HSPA+/REL EASE 8 MODULE	Power: DC 3.3V
Note: Mode 4: WCDMA FDD V (Using Peak detector)	

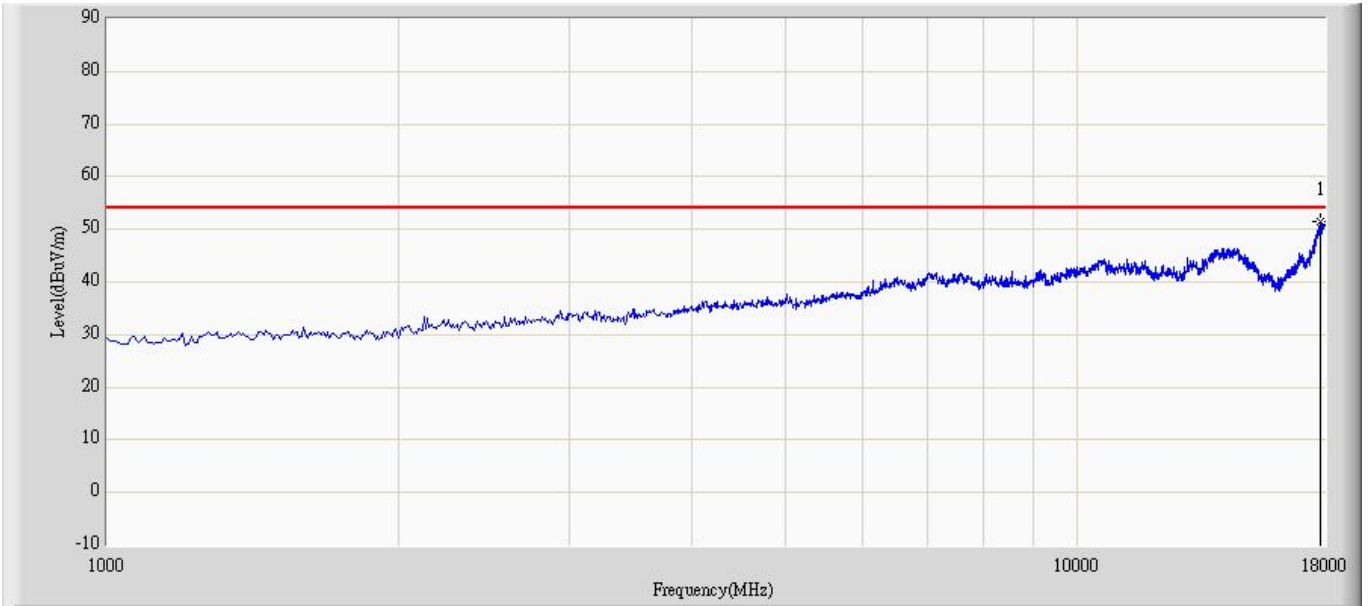

This plot is valid for low, mid & high channels (worst-case plot).

Engineer: Aileen	
Site: AC5	Time: 2010/08/30 - 10:57
Limit: RSS_GEN_Radiation_03M_PK	Margin: 0
Probe: BBHA9120D_499(1-18GHz)	Polarity: Vertical
EUT:GSM/GPRS/EDGE/HSDPA/HSUPA/HSPA+/REL EASE 8 MODULE	Power: DC 3.3V
Note: Mode 4: WCDMA FDD V (Using Peak detector)	

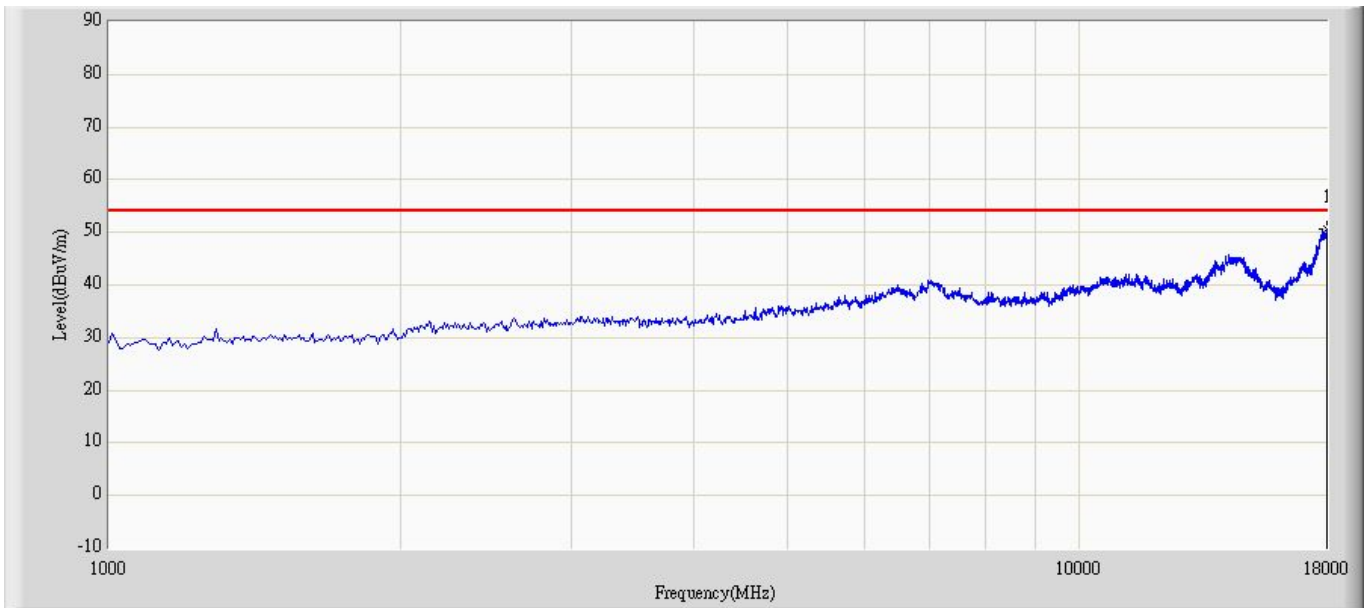

This plot is valid for low, mid & high channels (worst-case plot).

9. Appendix 1 – Test Setup Photograph

Description: Radiated Spurious Emission Test Setup for Below 1 GHz

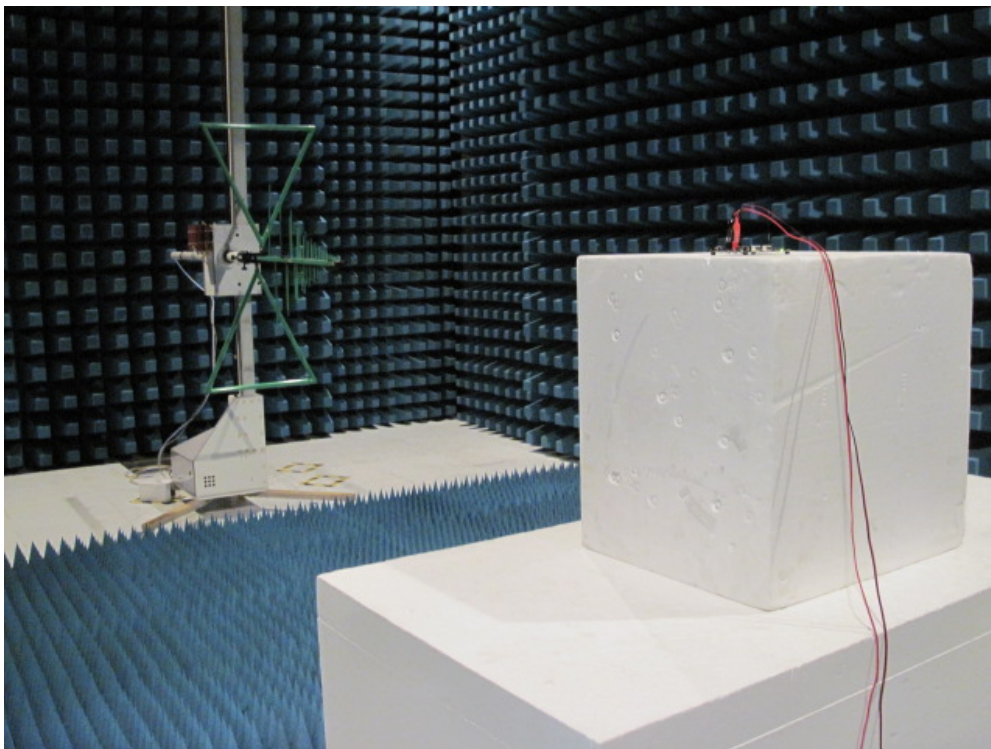

Description: Substitution Antenna Test Setup for Below 1 GHz



Description: Radiated Spurious Emission Test Setup for Above 1 GHz

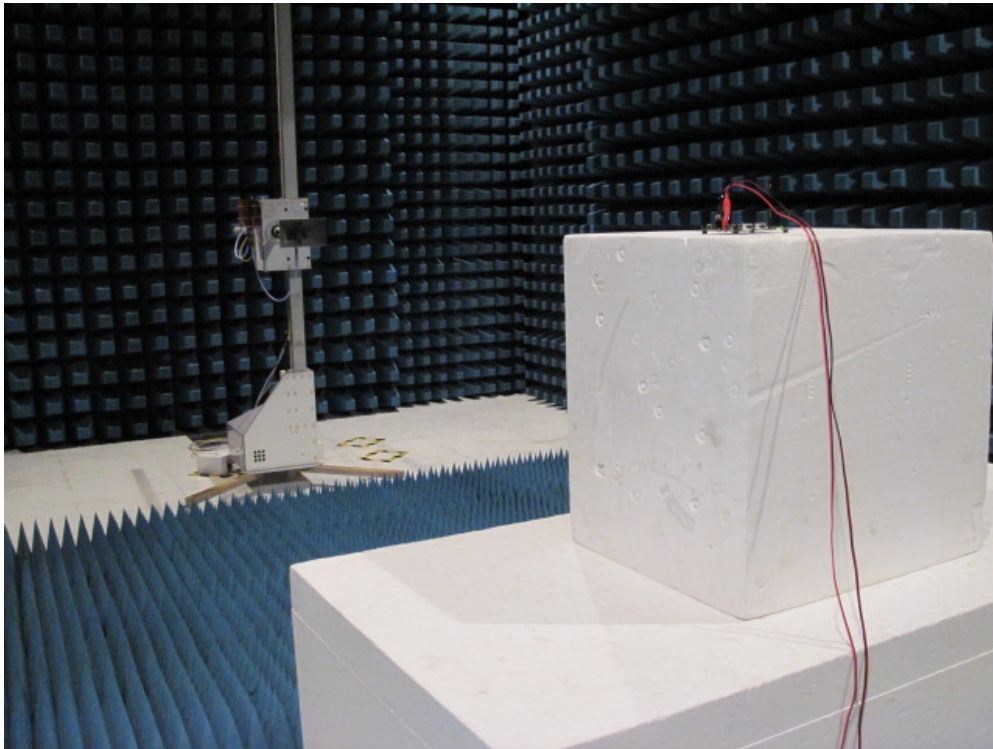

Description: Substitution Antenna Test Setup for Above 1 GHz

