



MC8792V Test Report

FCC Part 22, 24 / IC RSS 132, 133

FOR

FCC and IC Certifications

IC: 2417C-MC8792
FCC ID: N7NMC8792

Prepared by
SIERRA WIRELESS INC.
13811 WIRELESS WAY
RICHMOND, BC V6V 3A4
CANADA

© 2008 Sierra Wireless, Inc.

This document contains information which is proprietary and confidential to Sierra Wireless, Inc. Disclosure to persons other than the officers, employees, agents, or subcontractors of the Company or licensee of this document without the prior written permission of Sierra Wireless, Inc. is strictly prohibited.

SIERRA WIRELESS, INC.

FCC Part 22, 24 / RSS 132, 133	MC8792V	September 18, 2008	Page 2 of 62
--------------------------------	---------	--------------------	--------------

Table of Contents

- 1 Introduction and Purpose..... 3
- 2 Test Summary 3
- 3 Description of Equipment Under Test 4
- 4 RF Power Output 4
 - 4.1 Test Procedure 4
 - 4.2 Test Equipment..... 5
 - 4.3 Test Results GSM/EDGE (GMSK: MCS4; 8-PSK: MCS9) 5
 - 4.4 Test Results UMTS..... 5
 - 4.4.1 Test 1: RF Output Power Results for WCDMA R99..... 5
 - 4.4.2 Test 2: RF Output Power Results for HSDPA Rel6..... 6
 - 4.4.3 Test 3: RF Output Power Results for HSPA (HSDPA & HSUPA) Rel6..... 7
 - 4.5 Test Settings for UMTS Mode on CMU200 9
- 5 Occupied Bandwidth..... 13
 - 5.1 Test Procedure 13
 - 5.2 Test Results 13
 - 5.3 Test Plots..... 14
- 6 Out of Band Emissions at Antenna Terminals 21
 - 6.1 Test Procedure 21
 - 6.2 Test Equipment..... 22
 - 6.3 Test Results 22
 - 6.4 Test Plots..... 23
- 7 Block Edge Compliance..... 54
 - 7.1 Test Procedure 54
 - 7.2 Test Equipment..... 54
 - 7.3 Test Results 54
 - 7.4 Test Plots..... 55
- 8 Frequency Stability Versus Temperature..... 60
 - 8.1 Summary of Results..... 60
 - 8.2 Test Procedure 60
 - 8.3 Test Equipment..... 60
 - 8.4 Test Results 61
- 9 Frequency Stability Versus Voltage 61
 - 9.1 Summary of Results..... 61
 - 9.2 Test Procedure 61
 - 9.3 Test Equipment..... 62
 - 9.4 Test Results 62

SIERRA WIRELESS, INC.

FCC Part 22, 24 / RSS 132, 133	MC8792V	September 18, 2008	Page 3 of 62
--------------------------------	---------	--------------------	--------------

1 Introduction and Purpose

This document provides the 8792V USB modem test data for the FCC and Industry Canada certifications. The tests included in this report are limited to all conducted tests required. The radiated tests were performed at an external test facility.

2 Test Summary

FCC Rule	IC Standards	DESCRIPTION OF TEST	RESULT	PAGE
2.1046	RSS-132, 4.4 RSS-133, 6.4	RF Power Output	Complies	5
2.1049	RSS-Gen, 4.6	Occupied Bandwidth	Complies	13
2.1051, 22.901(d) 22.917, 24.238(a)	RSS-132, 4.5 RSS-133, 6.5	Out of Band Emissions at Antenna Terminals	Complies	22
2.1053	RSS-132, 4.5 RSS-133, 6.5	Field Strength of Spurious Radiation	Complies	See CCS Report
2.1055	RSS-132, 4.3 RSS-133, 6.3	Frequency Stability versus Temperature	Complies	60
2.1055	RSS-132, 4.3 RSS-133, 6.3	Frequency Stability versus Voltage	Complies	61

3 Description of Equipment Under Test

The 8792V USB modem (referred to as “EUT” hereafter) is a multi-band wireless modem operating on the GSM/GPRS/EDGE/UMTS network. In the US and Canada, only the Cellular and PCS bands are used for the GSM/GPRS/UMTS operation, so this test report only contains data for these two bands (850MHz and 1900MHz).

4 RF Power Output

FCC 2.1046

4.1 Test Procedure

The transmitter output was connected to a Rohde & Schwarz CMU200 Test Set and configured to operate at maximum power in a call. The power was measured using the spectrum analyzer at three equally spaced operating frequencies for each band. The RBW was set to 300 KHz for the GSM and EDGE measurements, and 5MHz for the WCDMA measurements. The spectrum analyzer was set to measure the RF output power with the cable and coupler losses accounted for.

Test Setup

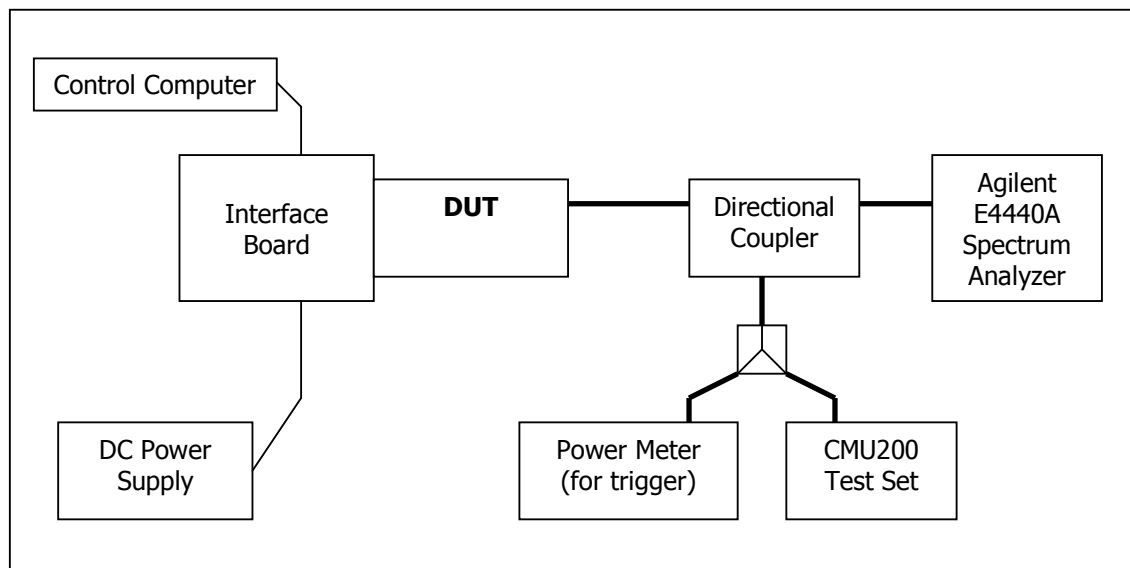

SIERRA WIRELESS, INC.

FCC Part 22, 24 / RSS 132, 133	MC8792V	September 18, 2008	Page 5 of 62
--------------------------------	---------	--------------------	--------------

4.2 Test Equipment

Instrument List

EQUIPMENT	MANUFACTURER	MODEL NO.	SERIAL NO.	CAL. DATE
Control Computer	TC	Generic PC	100488	N/A
Wireless Test Set	Rohde & Schwarz	CMU200	111682	November 18, 2008
Spectrum Analyzer	Agilent	PSA E4440A	US41421268	March 11, 2008
DC Power Supply	HP	E3631A	3530A	N/A
Interface Board	Shop built	Minnow	N/A	N/A
Directional Coupler	Mini-Circuits	ZA3PD-2	N/A	N/A

4.3 Test Results GSM/EDGE (GMSK: MCS4; 8-PSK: MCS9)

Frequency (MHz)	Channel	GMSK Mode		8-PSK Mode	
		RMS Power (dBm)	Peak Power (dBm)	RMS Power (dBm)	Peak Power (dBm)
824.2	128	31.9	32.1	27.2	30.4
836.6	190	31.9	32.1	27.2	30.4
848.8	251	31.9	32.0	27.1	30.3
1850.2	512	29.1	29.2	26.8	29.7
1880.0	661	28.9	29.1	26.5	29.4
1909.8	810	29.1	29.2	26.7	29.6

4.4 Test Results UMTS

4.4.1 Test 1: RF Output Power Results for WCDMA R99

The following tests were completed according to the test requirements outlined in section 5.2 of the 3GPP TS34.121-1 V7.5.0 specification. The EUT supports power Class 3, which has a nominal maximum output power of 24 dBm (+1.7/-3.7). RMC 12.2kps is used for this testing.

The test was performed according to section 5.2 of the 3GPP TS34.121-1 V7.5.

Frequency (MHz)	Channel	WCDMA R99	
		RMS Power (dBm)	Peak Power (dBm)
1852.4	9262	22.49	26.02
1880.0	9400	22.69	26.49
1907.6	9538	22.84	26.58

Note: The results above reflect max power with all up bits.

© 2008 Sierra Wireless, Inc.

The contents of this page are subject to the confidentiality information on page one.

SIERRA WIRELESS, INC.

FCC Part 22, 24 / RSS 132, 133	MC8792V	September 18, 2008	Page 6 of 62
--------------------------------	---------	--------------------	--------------

4.4.2 Test 2: RF Output Power Results for HSDPA Rel6

The EUT supports Category 8 FDD HS-DSCH physical layer. As stated in the 3GPP TS25.306 V7.3.0 Table 5.1a, the details of Category 8 are as follows:

- Maximum of 10 E-DSCH received codes
- Minimum 1 inter-TTI interval
- Maximum 14411bits in an E-DSCH transport block received within an E-DSCH TTI
- Total number of soft channel bits is 134400
- Support of QPSK and 16QAM

A detailed list of all settings used is included at the end of this report in section 6.0

The following Sub-Tests were completed according to the test requirements outlined in section 5.2A of the 3GPP TS34.121-1 V7.5.0 specification. All TX RMS and Peak power requirements for Power Class 3 were met according to table 5.2AA.5 and achieved through the outlined test procedure in section 5.2AA.4.2. All UE channels and power ratio's are set according to table C10.1.4 in the 3GPP TS34.121-1 V7.5.0 specification. A summary of these settings are illustrated below:

Subtest	Mode	Call Type	RMC (kbps)	HSDPA FRC	Power Class 3 Max Limit dBm	β_c/β_d	β_{hs}	CM (db)	MPR (db)
1	HSDPA	PS	12.2	H-Set 1 QPSK	24 (+1.7/-3.7 db)	2 /15	4/15	0.0	0.0
2	HSDPA	PS	12.2	H-Set 1 QPSK	24 (+1.7/-3.7 db)	12 /15	24/15	1.0	0.0
3	HSDPA	PS	12.2	H-Set 1 QPSK	23.5 (+2.2/-3.7 db)	15 /8	30/15	1.5	0.5
4	HSDPA	PS	12.2	H-Set 1 QPSK	23.5 (+2.2/-3.7 db)	15 /4	30/15	1.5	0.5

Note: The recommended HSDPA MPRs are implemented as per following sub-tests.

4.4.2.1 Sub-Test 1

$\beta_c=2/15$, $\beta_d=15/15$, $\beta_{hs}=4/15$. MPR=0dB translates the min. and max. power limits to 20.3dBm and 25.7dBm respectively.

Frequency (MHz)	Channel	Power (dBm)	Comments
		20.3dBm<Measured RMS (dBm)<25.7dBm	
1852.4	9262	22.39	Pass
1880.0	9400	22.47	Pass
1907.6	9538	22.23	Pass

4.4.2.2 Sub-Test 2

$\beta_c=12/15$, $\beta_d=15/15$, $\beta_{hs}=24/15$. MPR=0dB translates the min. and max. power limits to 20.3dBm and 25.7dBm respectively.

SIERRA WIRELESS, INC.

FCC Part 22, 24 / RSS 132, 133	MC8792V	September 18, 2008	Page 7 of 62
--------------------------------	---------	--------------------	--------------

Frequency (MHz)	Channel	Power (dBm)	Comments
		20.3dBm<Measured RMS (dBm)<25.7dBm	
1852.4	9262	22.52	Pass
1880.0	9400	22.63	Pass
1907.6	9538	22.82	Pass

4.4.2.3 Sub-Test 3

$\beta_c=15/15$, $\beta_d=15/8$, $\beta_{hs}=30/15$. MPR=0.5dB translates the min. and max. power limits to 19.8dBm and 25.7dBm respectively.

Frequency (MHz)	Channel	Power (dBm)	Comments
		19.8dBm<Measured RMS (dBm)<25.7dBm	
1852.4	9262	21.51	Pass
1880.0	9400	21.51	Pass
1907.6	9538	21.7	Pass

4.4.2.4 Sub-Test 4

$\beta_c=15/15$, $\beta_d=4/15$, $\beta_{hs}=30/15$. MPR=0.5dB translates the min. and max. power limits to 19.8dBm and 25.7dBm respectively.

Frequency (MHz)	Channel	Power (dBm)	Comments
		19.8dBm<Measured RMS (dBm)<25.7dBm	
1852.4	9262	20.82	Pass
1880.0	9400	20.69	Pass
1907.6	9538	20.67	Pass

4.4.3 Test 3: RF Output Power Results for HSPA (HSDPA & HSUPA) Rel6

The EUT supports Category 5 FDD E-DCH physical layer. As stated in the 3GPP TS25.306 V7.3.0 Table 5.1g, the details of Category 5 are as follows:

- Maximum of 2 E-DCH transmitted codes
- Minimum spreading factor of SF2
- Support for only 10 ms TTI E-DCH
- Maximum 20000 bits in an E-DCH transport block within a 10 ms E-DCH TTI
- Data rate of 2 Mbps
- Support of QPSK only

© 2008 Sierra Wireless, Inc.

The contents of this page are subject to the confidentiality information on page one.

SIERRA WIRELESS, INC.

FCC Part 22, 24 / RSS 132, 133	MC8792V	September 18, 2008	Page 8 of 62
--------------------------------	---------	--------------------	--------------

A detailed list of all settings used is included at the end of this report in section 6.0.

The following 5 Sub-Tests were completed according to the test requirements outlined in section 5.2B of the 3GPP TS34.121-1 V7.5.0 specification. All TX RMS and Peak power requirements were met according to table 5.2B.5 and achieved through the outlined test procedure in section 5.2B.4.2. All UE channels and power ratio's are set according to table C11.1.3 in the 3GPP TS34.121-1 V7.5.0 specification. A summary of these settings are illustrated below:

Subtest	Mode	Call Type	RMC (kbps)	HSDPA FRC	Power Class 3 Max Limit dBm	β_c/β_d	β_{hs}	β_{ec}	β_{ed}	CM (db)	MPR (db)
1	HSPA	PS	12.2	H-Set 1 QPSK	24 (+1.7/-5.2 db)	11 /15	22/15	209/225	1309/225	1.0	0.0
2	HSPA	PS	12.2	H-Set 1 QPSK	22 (+3.7/-5.2 db)	6 /15	12/15	12/15	94/75	3.0	2.0
3	HSPA	PS	12.2	H-Set 1 QPSK	23 (+2.7/-5.2 db)	15 /9	30/15	30/15	47/15	2.0	1.0
4	HSPA	PS	12.2	H-Set 1 QPSK	22 (+1.7/-5.2 db)	2/15	4/15	2/15	56/75	3.0	2.0
5	HSPA	PS	12.2	H-Set 1 QPSK	24 (+1.7/-5.2 db)	15/15	30/15	24/15	134/15	1.0	0.0

Note: The recommended HSUPA MPRs are implemented as per following sub-tests.

4.4.3.1 Sub-Test 1:

$\beta_c=11/15$, $\beta_d=15/15$, $\beta_{hs}=22/15$, $\beta_{ec}=209/225$, $\beta_{ed}=1039/225$, AG=20, 1xSF4, E-TFCI=75. MPR=0dB translates the min. and max. power limits to 18.8dBm and 25.7dBm respectively.

Frequency (MHz)	Channel	Power (dBm)	Comments
		18.8dBm<Measured RMS (dBm)<25.7dBm	
1852.4	9262	21.82	Pass
1880.0	9400	21.69	Pass
1907.6	9538	21.73	Pass

4.4.3.2 Sub-Test 2:

$\beta_c=6/15$, $\beta_d=15/15$, $\beta_{hs}=12/15$, $\beta_{ec}=12/15$, $\beta_{ed}=94/75$, AG=12, 1xSF4, E-TFCI=67. MPR=2dB translates the min. and max. power limits to 16.8dBm and 25.7dBm respectively.

Frequency (MHz)	Channel	Power (dBm)	Comments
		16.8dBm<Measured RMS (dBm)<25.7dBm	
1852.4	9262	20.16	Pass
1880.0	9400	20.14	Pass
1907.6	9538	20.3	Pass

© 2008 Sierra Wireless, Inc.

The contents of this page are subject to the confidentiality information on page one.

SIERRA WIRELESS, INC.

FCC Part 22, 24 / RSS 132, 133	MC8792V	September 18, 2008	Page 9 of 62
--------------------------------	---------	--------------------	--------------

4.4.3.3 Sub-Test 3:

$\beta_c=15/15$, $\beta_d=9/15$, $\beta_{hs}=30/15$, $\beta_{ec}=30/15$, $\beta_{ed}=47/15$, AG=15, 2xSF4. E-TFCI=92,
 Note: # of Reference E-TFCI=2. MPR=1dB translates the min. and max. power limits to 17.8dBm and 25.7dBm respectively.

Frequency (MHz)	Channel	Power (dBm)	Comments
		17.8dBm<Measured RMS (dBm)<25.7dBm	
1852.4	9262	21.6	Pass
1880.0	9400	21.57	Pass
1907.6	9538	21.86	Pass

4.4.3.4 Sub-Test 4:

$\beta_c=2/15$, $\beta_d=15/15$, $\beta_{hs}=4/15$, $\beta_{ec}=2/15$, $\beta_{ed}=56/75$, AG=17, 1xSF4, E-TFCI=71.
 MPR=2dB translates the min. and max. power limits to 16.8dBm and 25.7dBm respectively.

Frequency (MHz)	Channel	Power (dBm)	Comments
		16.8dBm<Measured RMS (dBm)<25.7dBm	
1852.4	9262	20.79	Pass
1880.0	9400	20.32	Pass
1907.6	9538	20.47	Pass

4.4.3.5 Sub-Test 5:

$\beta_c=15/15$, $\beta_d=15/15$, $\beta_{hs}=30/15$, $\beta_{ec}=24/15$, $\beta_{ed}=134/15$, AG=21, 1xSF4, E-TFCI=81.
 MPR=0dB translates the min. and max. power limits to 18.8dBm and 25.7dBm respectively.

Frequency (MHz)	Channel	Power (dBm)	Comments
		18.8dBm<Measured RMS (dBm)<25.7dBm	
1852.4	9262	21.11	Pass
1880.0	9400	21.16	Pass
1907.6	9538	21.36	Pass

4.5 Test Settings for UMTS Mode on CMU200

WCDMA R99 Mode Settings:

UE Power Control Settings

Maximum allowable UE-Power = 24.0 dBm

UL Target Power = 24.0 dBm

Node B Settings

© 2008 Sierra Wireless, Inc.

The contents of this page are subject to the confidentiality information on page one.

SIERRA WIRELESS, INC.

FCC Part 22, 24 / RSS 132, 133	MC8792V	September 18, 2008	Page 10 of 62
--------------------------------	---------	--------------------	---------------

Primary Scrambling Code = 9
Output Channel Power = -51.7 dBm
OCNS = Off
Total Output Power (Ior+Ioc) = -51.7 dBm

RMC Settings

Reference Channel Type: 12.2 kbps Downlink/Uplink
DL DTCH Transport Format: 12.2 kbps
DL Resources in Use: 100 %
UL CRC (Sym. Loop Mode 2): Off
Test Mode: Loop Mode 1
Channel Data Source DTCH: PRBS9

Voice Settings

Voice Source: Echo
Loopback Type: Off

Adaptive Multirate Settings

Active Code Set: Selection A
Codec Mode: 12.2 kbps

Signaling RAB Settings

SRB Cell DCH: 3.4 kbps

BS Down Link Physical Channels Settings

Ior = -51.7 dBm
P-CPICH = -3.3 dB
P-SCH = -8.3 dB
S-SCH = -8.3 dB
P-CCPCH = -5.3 dB
S-CCPCH = -5.3 dB
S-CCPCH Channel Code = 2
PICH = -8.3 dB
PICH Channel Code = 3
AICH = -8.3 dB
AICH Channel Code = 6
DPDCH = -10.3 dB
DPDCH Channel Code = 96
Power Offset (DPCCH/DPDCH) = 0.0 dB
DL DPCH Timing Offset = 0
Secondary Scrambling Code = 0
Secondary Scrambling Code (HSDPA) = 0
HSDPA Channels = On

TPC Settings

© 2008 Sierra Wireless, Inc.

The contents of this page are subject to the confidentiality information on page one.

SIERRA WIRELESS, INC.

FCC Part 22, 24 / RSS 132, 133	MC8792V	September 18, 2008	Page 11 of 62
--------------------------------	---------	--------------------	---------------

Algorithm = 2
TPC Step Size = 1dB
TPC Pattern Setup = Set 1 (All 1, after linked to get maximum power)

HSDPA Mode Settings:

Node B Settings

Primary Scrambling Code = 9
Output Channel Power = -86 dBm
OCNS = Off
Total Output Power (Ior+Ioc) = -86 dBm

Network Settings

Packet Switched Domain = ON

HSDPA Test Mode Settings

Radiobearer Setup = RMC 12.2 kbps + HSPDA
RMC Test Loop = Loop Mode 1 RLC TM

HSDPA HS-DSCH

CQI Feedback Cycle = 4ms
CQI Repetition Factor = 2
ACK/NACK Repetition Factor = 3
UE Category = 8
Channel Configuration Type = FRC
H-Set Selection = H-Set 1 QPSK
RV Coding Sequence {0,2,5,6}

HSDPA Gain Factors are set according to each specific sub-test in table C.10.1.4 of 3GPP TS 34.121.

HSPA Mode Settings:

UE Power Control Settings

Maximum allowable UE-Power = 24.0 dBm
UL Target Power: Set according to each specific sub-test in table 5.2B.5 of 3GPP TS 34.121 less 5db for starting point.

UE Packet Data Gain Factors

Bc and Bd: *
 $\Delta\text{ACK}, \Delta\text{NACK}, \Delta\text{CQI}=8$

HSUPA

E-DCH Physical Layer Category = 5
E-TFCI Table Index = 1
Minimum Set E-TFCI = 1*

© 2008 Sierra Wireless, Inc.

The contents of this page are subject to the confidentiality information on page one.

SIERRA WIRELESS, INC.

FCC Part 22, 24 / RSS 132, 133	MC8792V	September 18, 2008	Page 12 of 62
--------------------------------	---------	--------------------	---------------

Maximum Channelisation Code: 1xSF4 or 2xSF4*
Initial Service Grant: *

UE Gain Factors

ΔE -DPCCH: *
Number of Reference E-TFCIs: **
Reference E-TFCI's: **
E-TFCI Power offsets: **

Node B Settings

Primary Scrambling Code = 9
Output Channel Power = -86 dBm
OCNS = Off
Total Output Power ($I_{or} + I_{oc}$) = -86 dBm

Paket Switched

DCH Type: HSUPA Test Mode
Data Rate: HSDPA/HSUPA
HSDPA Test Mode Settings
Radiobearer Setup = RMC 12.2kbps + HSDPA
RMC Test Loop = Loop Mode 1 RLC TM

HSDPA HS-DSCH

CQI Feedback Cycle = 4ms
CQI Repetition Factor = 2
ACK/NACK Repetition Factor = 3
UE Category = 8
Channel Configuration Type = FRC
H-Set Selection = H-Set 1 QPSK
RV Coding Sequence {0,2,5,6}

HSUPA Test Mode Settings

Radiobearer Setup = SRB 3.4 + HSPA

HSUPA Settings

TTI mode: 10ms

E-AGCH

Pattern Length: 1 AG Value: *

Downlink Physical Channels

HSUPA Channels: On
E-AGCH: -6.0db
E-AGCH Chan. Code: 6
E-RGCH/E-HICH: -5.0db
E-RGCH Active: Off
E-RGCH/E-HICH Chan. Code: 6

© 2008 Sierra Wireless, Inc.

The contents of this page are subject to the confidentiality information on page one.

SIERRA WIRELESS, INC.

*Set according to each specific sub-test in table C.11.1.3 of 3GPP TS 34.121.

** Set according to each specific sub-test in table 5.2B.2/3 of 3GPP TS 34.121.

5 Occupied Bandwidth

FCC 2.1049

5.1 Test Procedure

The transmitter output was connected to a calibrated coaxial cable and coupler, the other end of which was connected to a spectrum analyzer. The occupied bandwidth (defined as the 99% Power Bandwidth) was measured with the spectrum analyzer at the 3 frequencies in each band. The -26dB bandwidth was also measured and recorded.

Test Setup

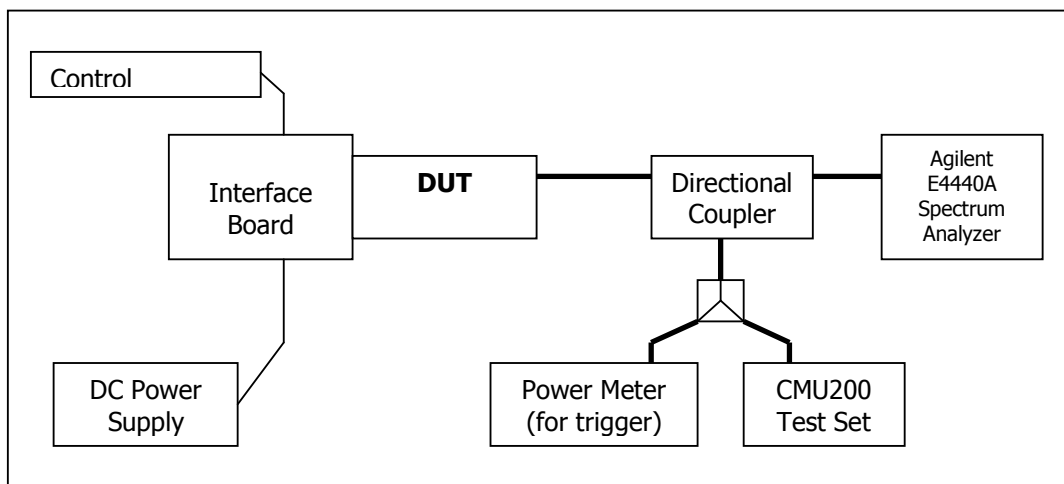

5.2 Test Results

The performance of the GSM 850 MHz Cellular band is shown in plots 5.3.1 to 5.3.6.

Performance of the GSM 1900 MHz PCS band is shown in plots 5.3.7 to 5.3.12.

Performance of the UMTS 1900 PCS band is shown in plots 5.3.13 to 5.3.15.

The following GSM test results are based on single slot, and use CS1 for GMSK and MCS9 for 8PSK mode. For WCDMA testing, RMC 12.2kps has been used.

Frequency (MHz)	Channel	99% Occupied Bandwidth (kHz)		-26dBc Occupied Bandwidth (kHz)	
		GMSK Mode	8-PSK Mode	GMSK Mode	8-PSK Mode
824.2	128	247.6	243.6	313.0	302.9
836.6	190	244.5	244.2	311.6	298.6
848.8	251	247.5	244.6	312.9	302.9

© 2008 Sierra Wireless, Inc.

The contents of this page are subject to the confidentiality information on page one.

SIERRA WIRELESS, INC.

1850.2	512	246.6	245.5	311.4	305.9
1880.0	661	245.8	245.0	311.5	305.7
1909.8	810	245.8	242.3	311.4	302.6
Frequency (MHz)	Channel	99% Occupied Bandwidth (MHz)		-26dBc Occupied Bandwidth (MHz)	
1852.4	9262	4.1773		4.6190	
1880.0	9400	4.1496		4.6040	
1907.6	9538	4.1577		4.5950	

5.3 Test Plots

5.3.1) GMSK Occupied Bandwidth, Cellular Low channel, 824.2 MHz, 99% bandwidth

Agilent 09:24:37 Mar 4, 2008

L

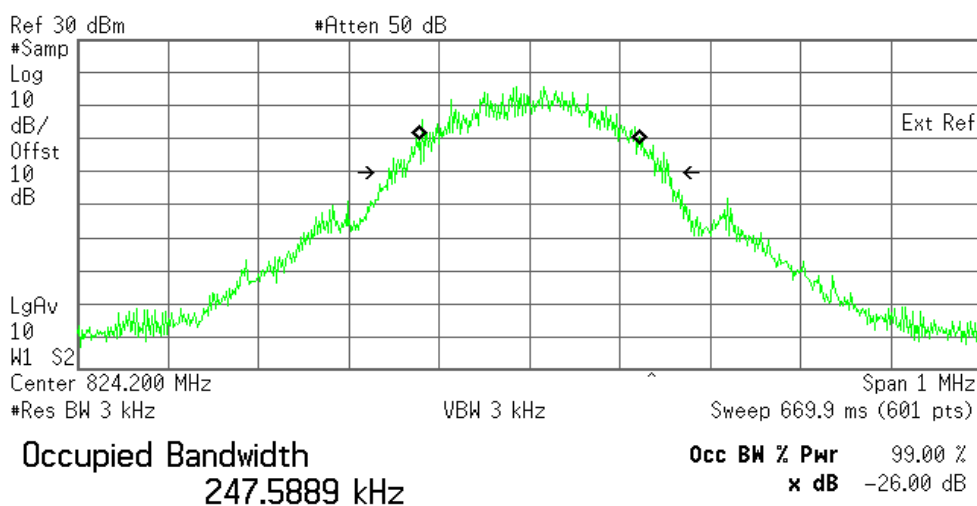

Transmit Freq Error 166.983 Hz
x dB Bandwidth 312.981 kHz*

5.3.2) GMSK Occupied Bandwidth, Middle channel, 836.6 MHz, 99% bandwidth

Agilent 09:28:24 Mar 4, 2008

L

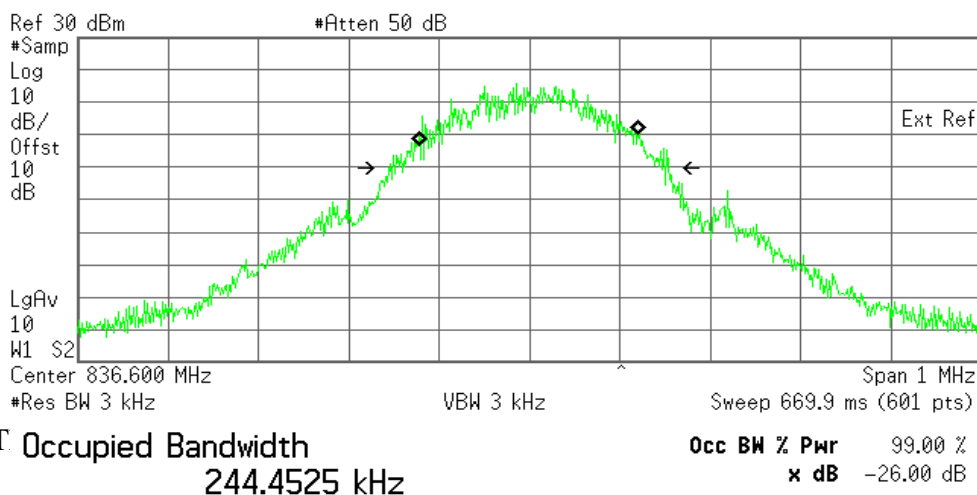

Transmit Freq Error -31.908 Hz
x dB Bandwidth 311.602 kHz*

SIERRA WIRELESS, INC.

5.3.3) GMSK Occupied Bandwidth, High channel, 848.8 MHz, 99% bandwidth

Agilent 09:31:42 Mar 4, 2008

L

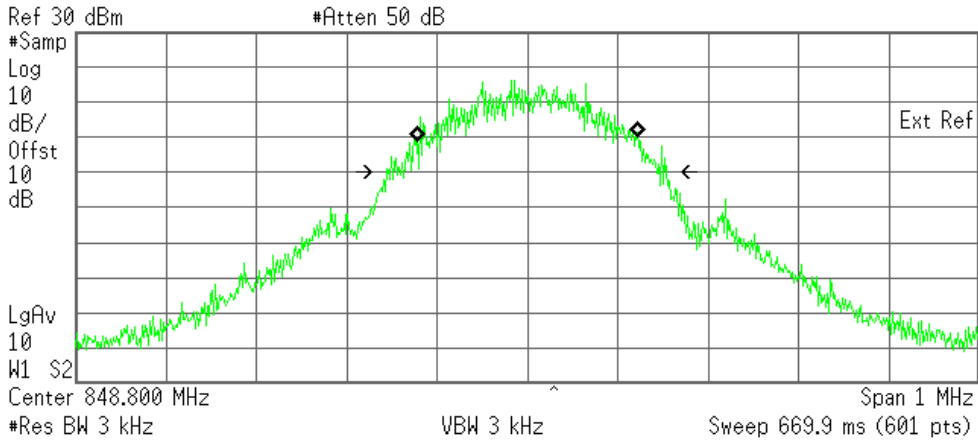

Occupied Bandwidth
247.5220 kHz

Occ BW % Pwr 99.00 %
x dB -26.00 dB

Transmit Freq Error 46.296 Hz
x dB Bandwidth 312.959 kHz*

5.3.4) 8-PSK Occupied Bandwidth, Cellular Low channel, 824.2 MHz, 99% bandwidth

Agilent 09:38:06 Mar 4, 2008

L

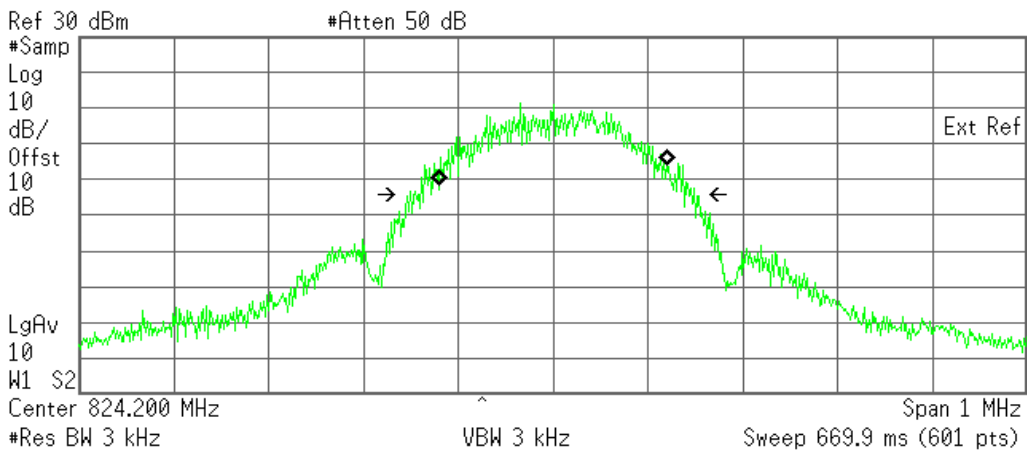

Occupied Bandwidth
243.5754 kHz

Occ BW % Pwr 99.00 %
x dB -26.00 dB

Transmit Freq Error 97.976 Hz
x dB Bandwidth 302.886 kHz*

© 2008 Sierra Wireless, Inc.

The contents of this page are subject to the confidentiality information on page one.

SIERRA WIRELESS, INC.

5.3.5) 8-PSK Occupied Bandwidth, Middle channel, 836.6 MHz, 99% bandwidth

* Agilent 09:41:01 Mar 4, 2008

L

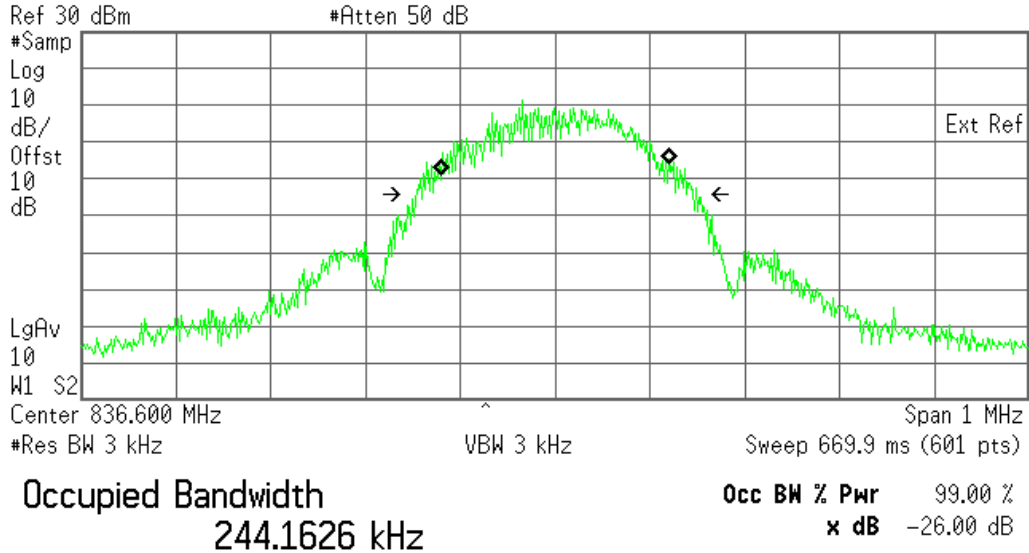

Transmit Freq Error 66.646 Hz

x dB Bandwidth 298.623 kHz*

5.3.6) 8-PSK Occupied Bandwidth, High channel, 848.8 MHz, 99% bandwidth

* Agilent 09:44:57 Mar 4, 2008

L

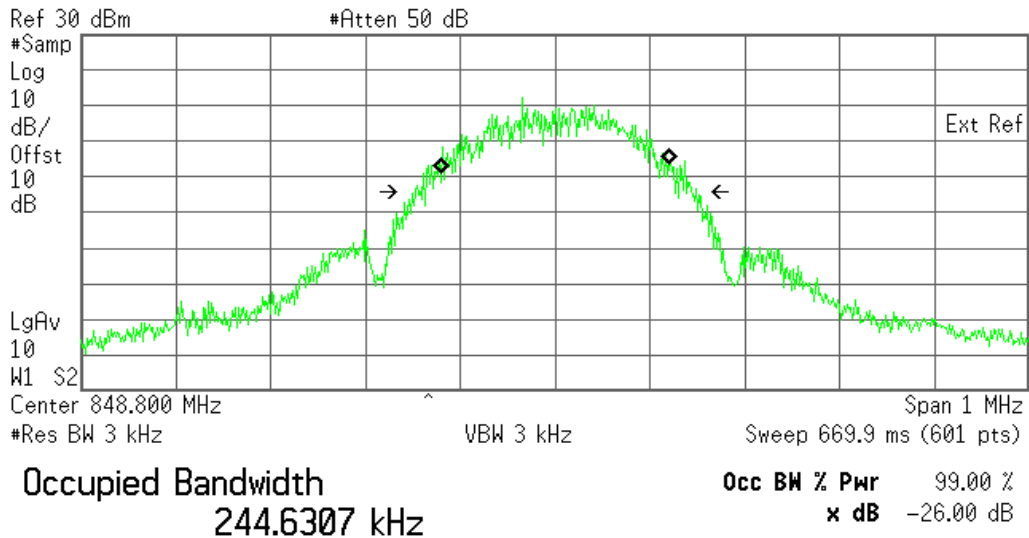

Transmit Freq Error -33.605 Hz

x dB Bandwidth 302.908 kHz*

© 2008 Sierra Wireless, Inc.

The contents of this page are subject to the confidentiality information on page one.

SIERRA WIRELESS, INC.

5.3.7) GMSK Occupied Bandwidth, PCS Low channel, 1850.2 MHz, 99% bandwidth

* Agilent 09:51:13 Mar 4, 2008

L

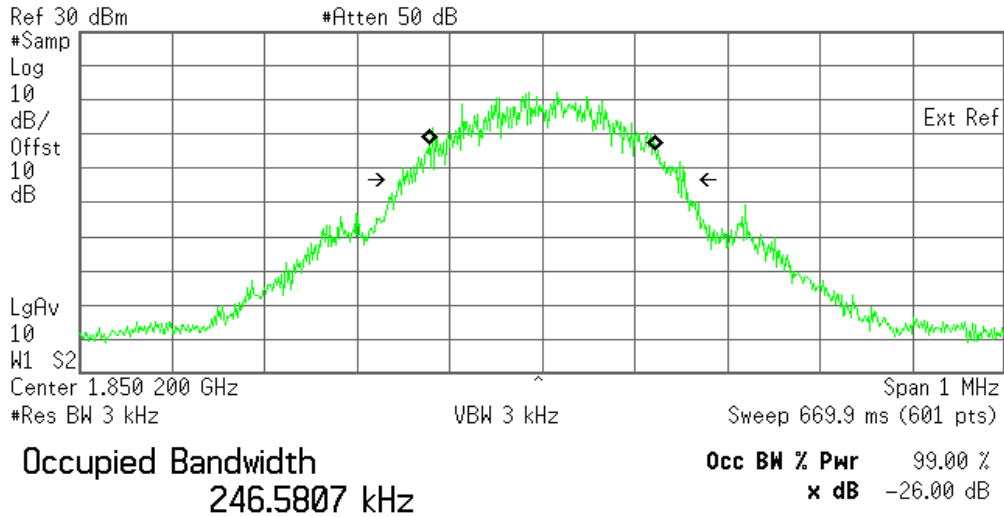

Transmit Freq Error -98.212 Hz
x dB Bandwidth 311.369 kHz*

5.3.8) GMSK Occupied Bandwidth, PCS Middle channel, 1880.0 MHz, 99% bandwidth

* Agilent 09:52:42 Mar 4, 2008

L

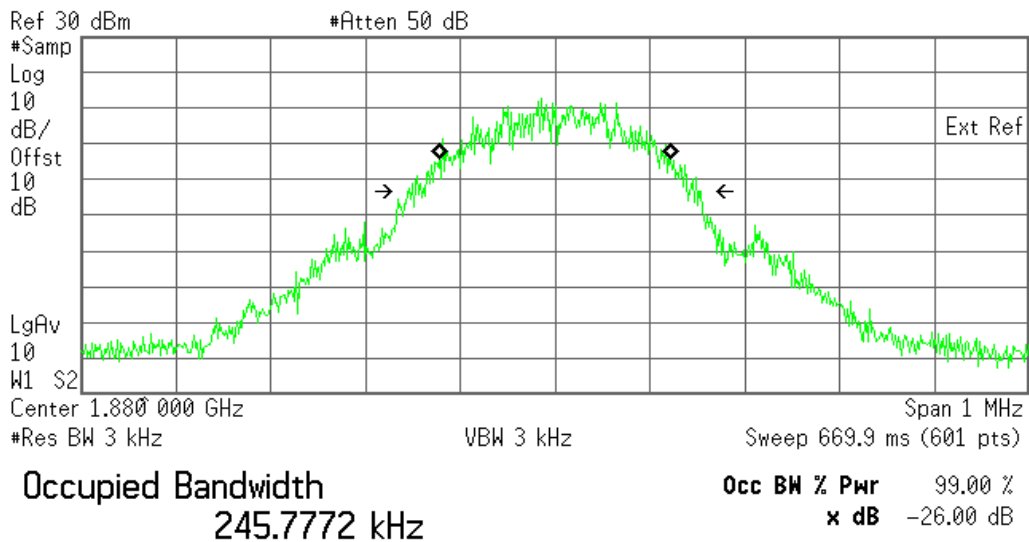

Transmit Freq Error -187.717 Hz
x dB Bandwidth 311.485 kHz*

© 2008 Sierra Wireless, Inc.

The contents of this page are subject to the confidentiality information on page one.

SIERRA WIRELESS, INC.

5.3.9) GMSK Occupied Bandwidth, PCS High channel, 1909.8 MHz, 99% bandwidth

Agilent 10:01:22 Mar 4, 2008

L

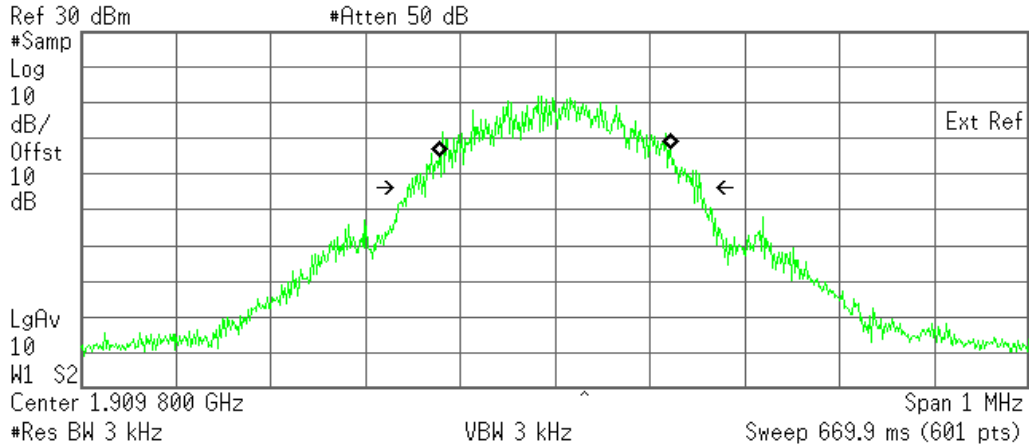

Occupied Bandwidth
245.8232 kHz

Occ BW % Pwr 99.00 %
x dB -26.00 dB

Transmit Freq Error -72.497 Hz
x dB Bandwidth 311.394 kHz*

5.3.10) 8-PSK Occupied Bandwidth, PCS Low channel, 1850.2 MHz, 99% bandwidth

Agilent 10:04:49 Mar 4, 2008

L

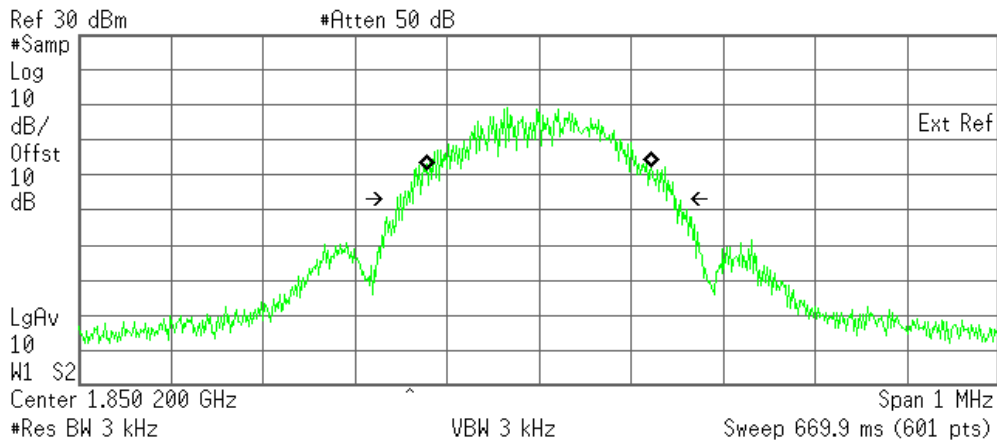

Occupied Bandwidth
245.4943 kHz

Occ BW % Pwr 99.00 %
x dB -26.00 dB

Transmit Freq Error 29.035 Hz
x dB Bandwidth 305.888 kHz*

© 2008 Sierra Wireless, Inc.

The contents of this page are subject to the confidentiality information on page one.

SIERRA WIRELESS, INC.

5.3.11) 8-PSK Occupied Bandwidth, PCS Middle channel, 1880.0 MHz, 99% bandwidth

* Agilent 10:09:09 Mar 4, 2008

L

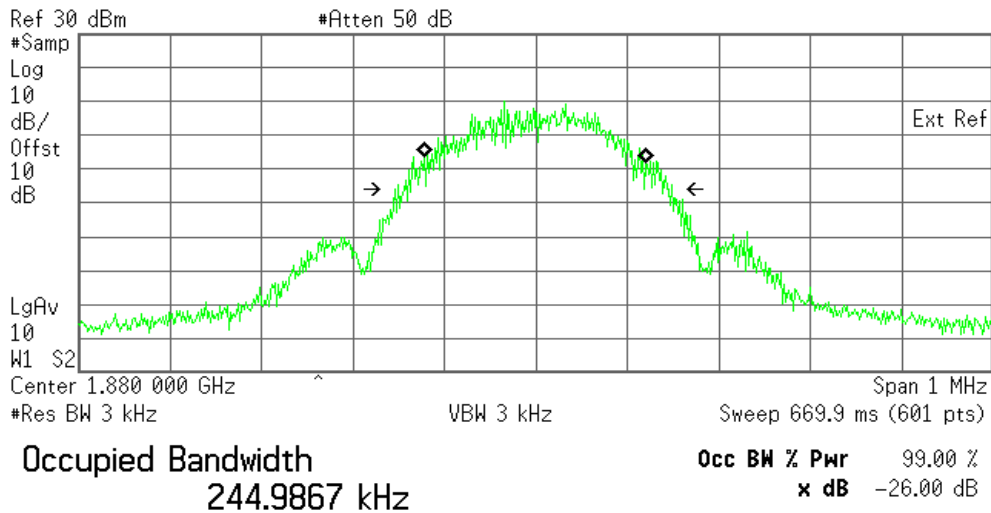

Transmit Freq Error -543.514 Hz
x dB Bandwidth 305.697 kHz*

5.3.12) 8-PSK Occupied Bandwidth, PCS High channel, 1909.8 MHz, 99% bandwidth

* Agilent 10:18:19 Mar 4, 2008

L

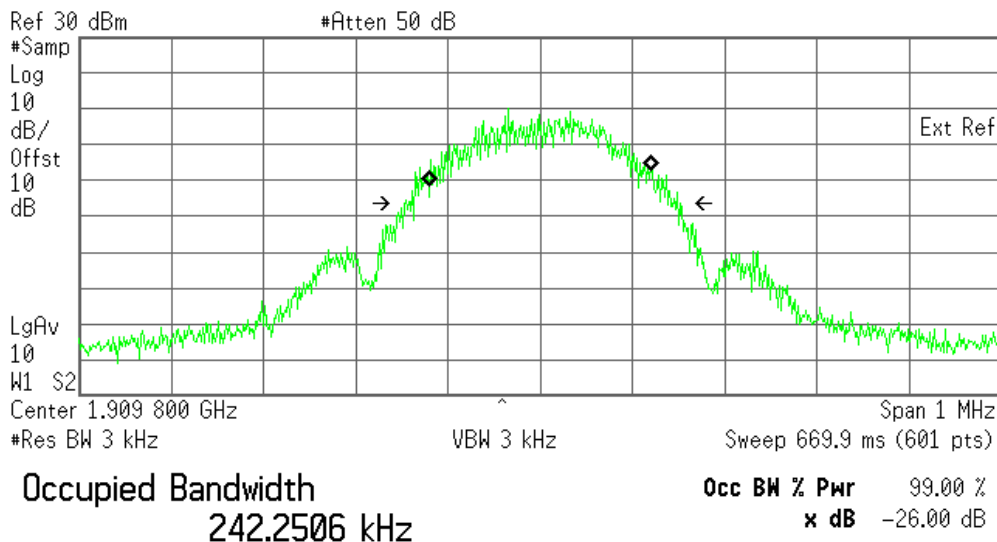

Transmit Freq Error -17.809 Hz
x dB Bandwidth 302.627 kHz*

© 2008 Sierra Wireless, Inc.

The contents of this page are subject to the confidentiality information on page one.

SIERRA WIRELESS, INC.

5.3.13) WCDMA Occupied Bandwidth, PCS Low channel, 1852.4 MHz, 99% bandwidth

Agilent 11:03:25 Mar 4, 2008

L

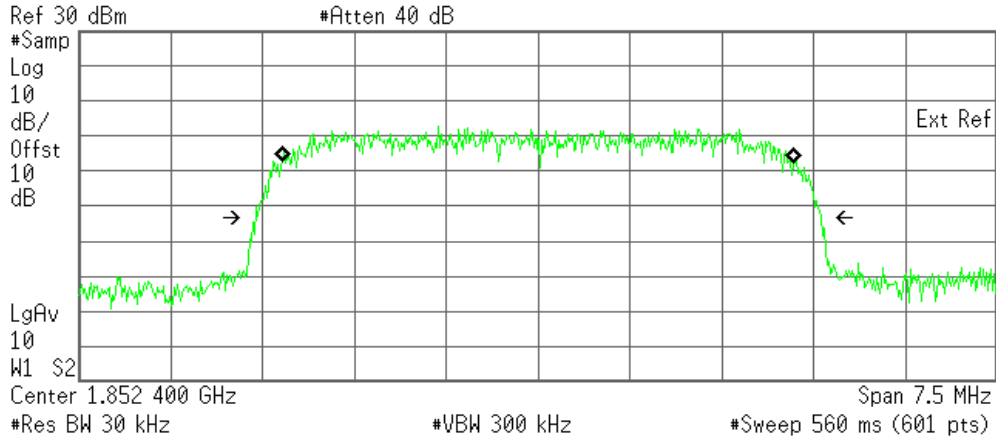

Occupied Bandwidth
4.1773 MHz

Occ BW % Pwr 99.00 %
x dB -26.00 dB

Transmit Freq Error -170.560 Hz
x dB Bandwidth 4.619 MHz*

5.3.14) WCDMA Occupied Bandwidth, PCS Middle channel, 1880 MHz, 99% bandwidth

Agilent 11:04:27 Mar 4, 2008

L

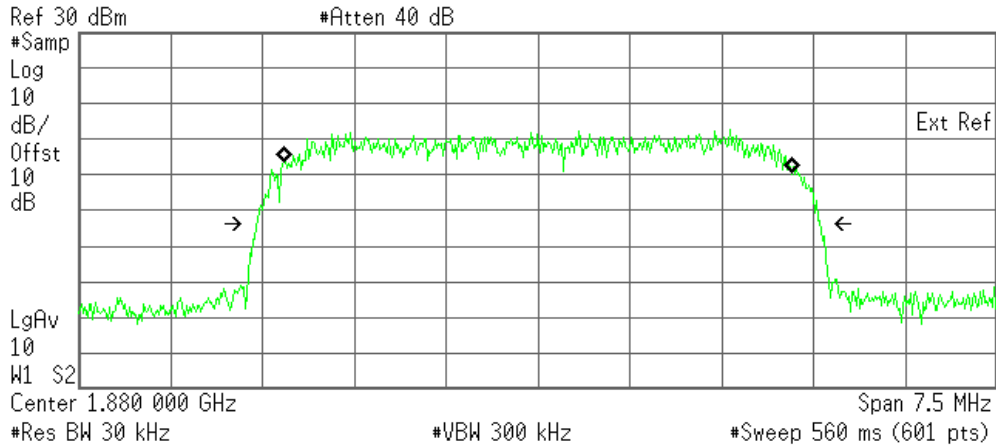

Occupied Bandwidth
4.1496 MHz

Occ BW % Pwr 99.00 %
x dB -26.00 dB

Transmit Freq Error -220.546 Hz
x dB Bandwidth 4.604 MHz*

© 2008 Sierra Wireless, Inc.

The contents of this page are subject to the confidentiality information on page one.

SIERRA WIRELESS, INC.

5.3.15) WCDMA Occupied Bandwidth, PCS High channel, 1907.6 MHz, 99% bandwidth

Agilent 11:16:09 Mar 4, 2008

L

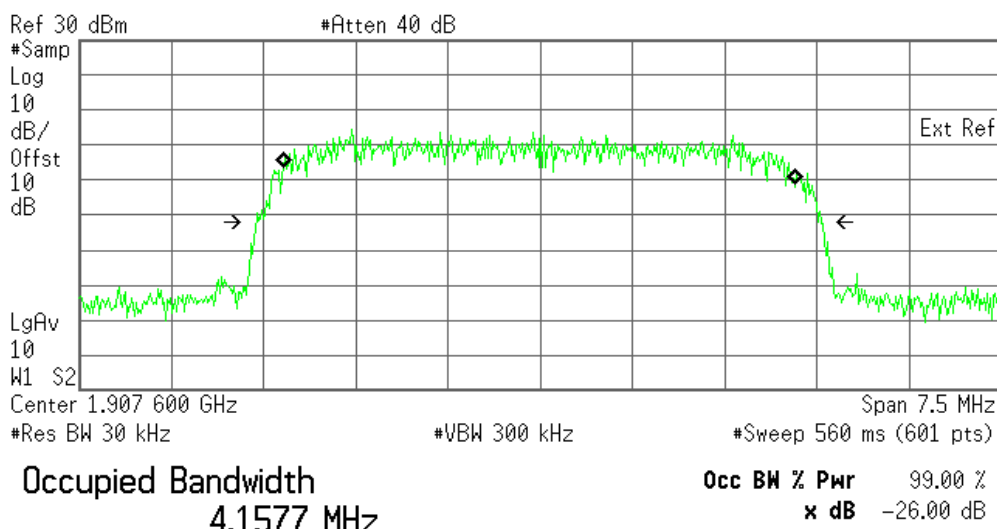

Transmit Freq Error -8.428 kHz
x dB Bandwidth 4.595 MHz*

6 Out of Band Emissions at Antenna Terminals

FCC 22.901(d), 22.917, 24.238(a)

Out of Band Emissions:

The mean power of emissions must be attenuated below the mean power of the unmodulated carrier (P) on any frequency outside the frequency band by at least $(43 + 10 \log P)$ dB, in this case, -13dBm.

6.1 Test Procedure

The RF output of the transmitter was connected to a spectrum analyzer through a calibrated coaxial cable. Sufficient scans were taken to show the out-of-band Emissions, if any, up to 10th harmonic. The EUT was scanned for spurious emissions from 1MHz to 20GHz with sufficient bandwidth and video resolution. Data plots are included. The measurement cable path loss at 20GHz (including an attenuator) was 10dB. Multiple sweeps were recorded in maximum hold mode using a peak detector to ensure that the worst-case emissions were caught.

© 2008 Sierra Wireless, Inc.

The contents of this page are subject to the confidentiality information on page one.

SIERRA WIRELESS, INC.

Test Setup

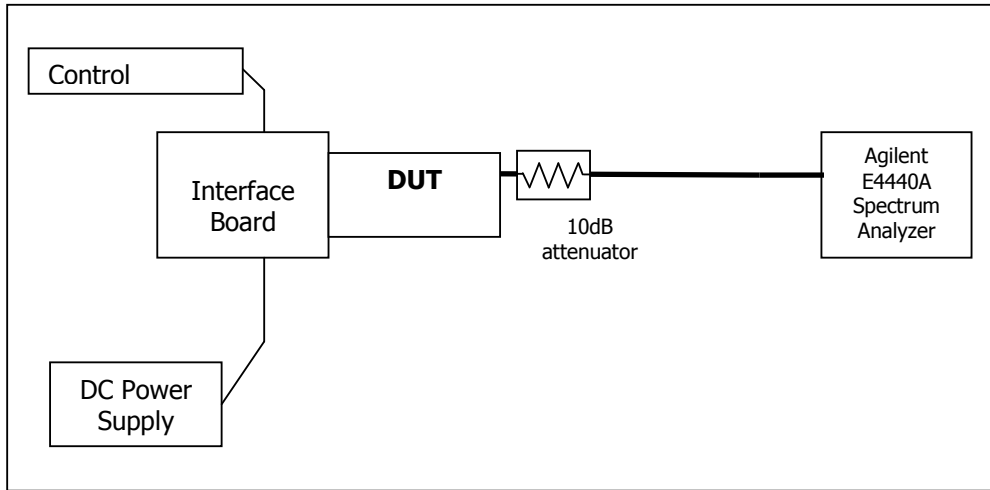

6.2 Test Equipment

EQUIPMENT	MANUFACTURER	MODEL NO.	SERIAL NO.	CAL. DATE
Control Computer	TC	Generic PC	100488	N/A
Wireless Test Set	Rohde & Schwarz	CMU200	111682	November 18, 2008
Spectrum Analyzer	Agilent	PSA E4440A	US41421268	March 11, 2008
DC Power Supply	HP	E3631A	3530A	N/A
Interface Board	Shop built	Minnow	N/A	N/A
Directional Coupler	Mini-Circuits	ZA3PD-2	N/A	N/A

6.3 Test Results

Refer to the following plots.

- **Cellular Band**

Plot Number	Description
6.4.1 – 6.4.3	GMSK Mode, Low channel, 824.20 MHz
6.4.4 – 6.4.6	GMSK Mode, Middle Channel, 836.6 MHz
6.4.7 – 6.4.9	GMSK Mode, High Channel, 848.8 MHz
6.4.10 – 6.4.12	8-PSK Mode, Low channel, 824.20 MHz
6.4.13 – 6.4.15	8-PSK Mode, Middle Channel, 836.6 MHz
6.4.16 – 6.4.18	8-PSK Mode, High Channel, 848.8 MHz

- **PCS Band**

Plot Number	Description
6.4.19 – 6.4.21	GMSK Mode, Low Channel, 1850.2 MHz
6.4.22 – 6.4.24	GMSK Mode, Middle Channel, 1880.0 MHz
6.4.25 – 6.4.27	GMSK Mode, High Channel, 1909.8 MHz
6.4.28 – 6.4.30	8-PSK, Mode, Low Channel, 1850.2 MHz
6.4.31 – 6.4.33	8-PSK Mode, Middle Channel, 1880.0 MHz
6.4.34 – 6.4.36	8-PSK Mode, High Channel, 1909.8 MHz

SIERRA WIRELESS, INC.

- **UMTS PCS Band**

Plot Number	Description
6.4.37 – 6.4.39	WCDMA Mode, Low Channel, 1852.4 MHz
6.4.40 – 6.4.42	WCDMA Mode, Middle Channel, 1880.0 MHz
6.4.43 – 6.4.45	WCDMA Mode, High Channel, 1907.6 MHz

These plots show that the conducted emission limits requirements are met.

6.4 Test Plots

Plot 6.4.1) Out of Band Emissions at Antenna Terminals

GMSK, Low channel, 824.200 MHz, 1 MHz to 1 GHz

Agilent 11:22:06 Mar 4, 2008

L

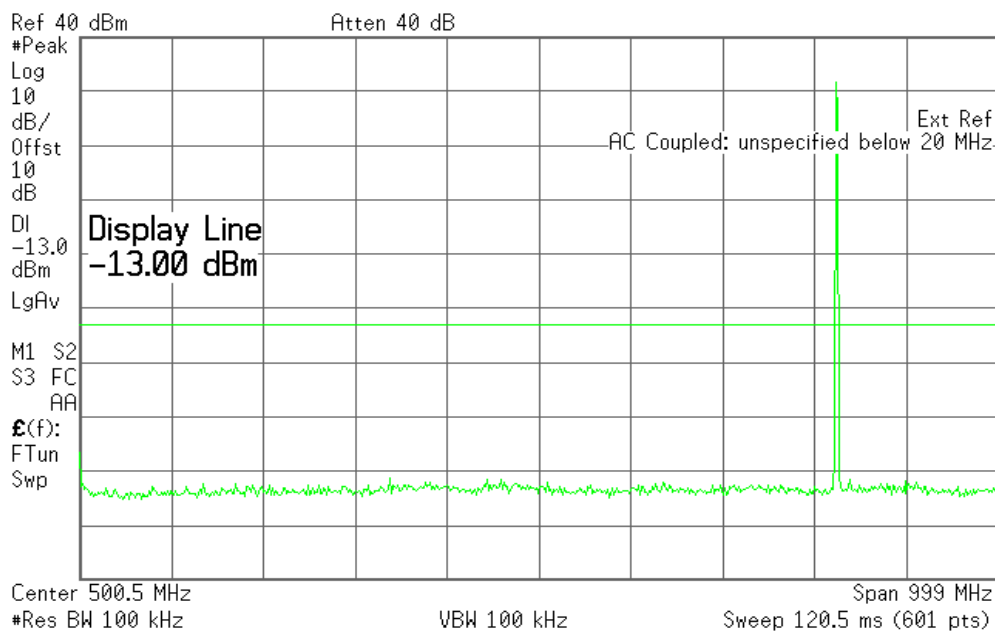

© 2008 Sierra Wireless, Inc.

The contents of this page are subject to the confidentiality information on page one.

SIERRA WIRELESS, INC.

Plot 6.4.2) Out of Band Emissions at Antenna Terminals

GMSK, Low channel, 824.200 MHz, TX signal +/- 20 MHz

Agilent 11:23:47 Mar 4, 2008

L

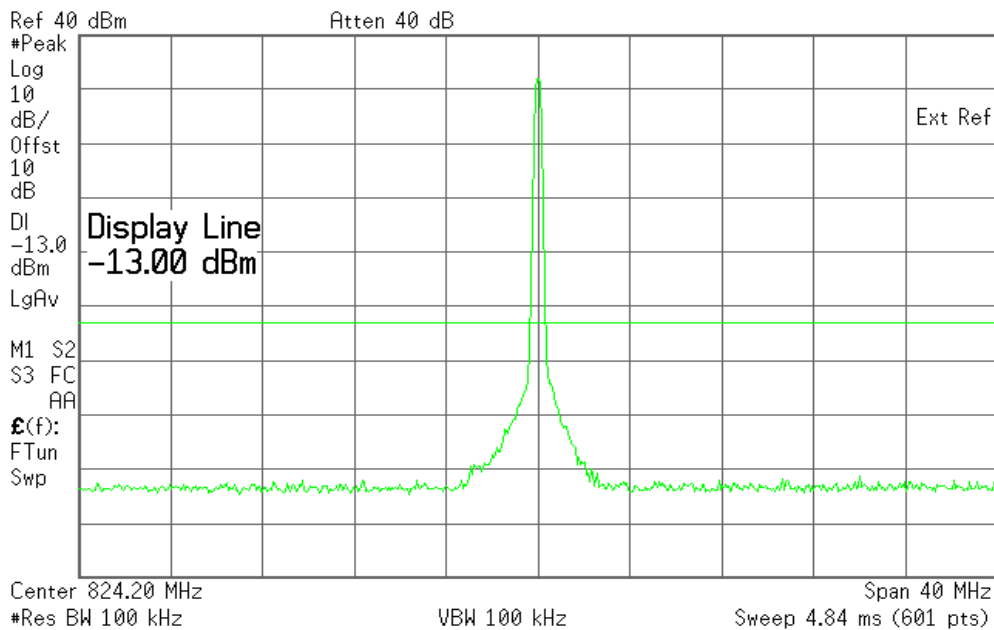

The strong emission shown in each case is the carrier signal.

Plot 6.4.3) Out of Band Emissions at Antenna Terminals

GMSK, Low channel, 824.200 MHz, 1 GHz to 20 GHz

Agilent 11:26:48 Mar 4, 2008

L

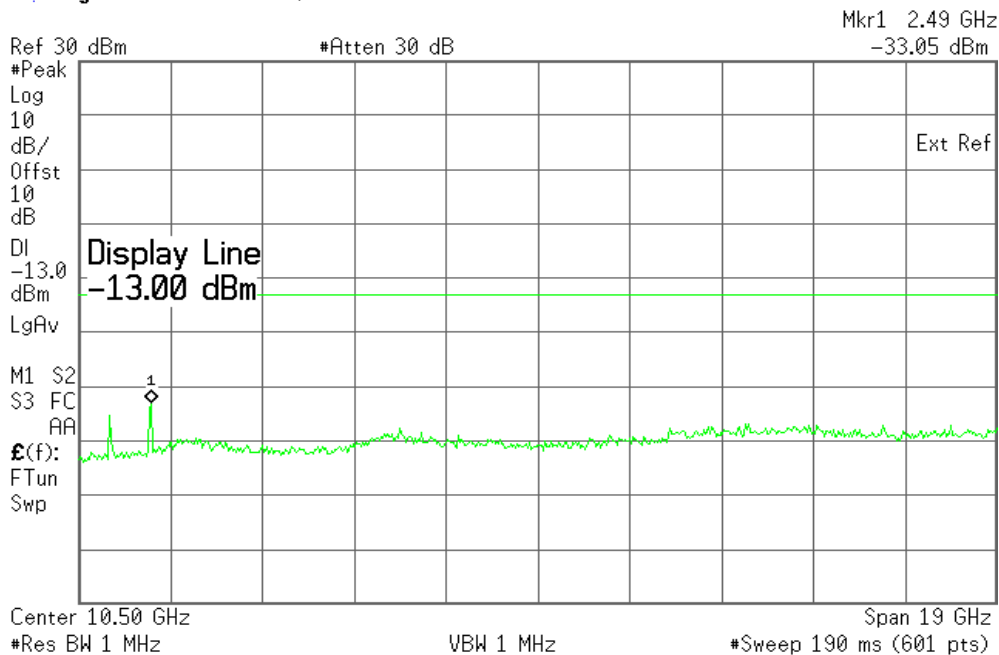

© 2008 Sierra Wireless, Inc.

The contents of this page are subject to the confidentiality information on page one.

SIERRA WIRELESS, INC.

Cellular Harmonics for Ch. 128 (824.2 MHz)	Level (dBm)
Second	-35.21 dBm
Third	-33.05 dBm
All others	< -35 dBm up to 20GHz

SIERRA WIRELESS, INC.

Plot 6.4.4) Out of Band Emissions at Antenna Terminals

GMSK, Mid Channel, 836.6 MHz, 1 MHz to 1 GHz

Agilent 11:29:40 Mar 4, 2008

L

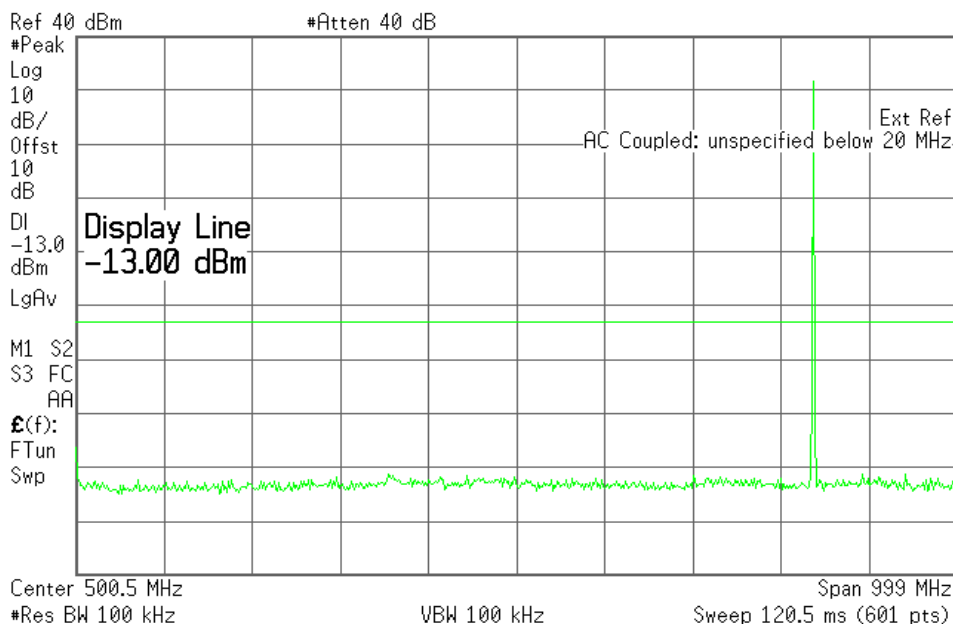

Plot 6.4.5) Out of Band Emissions at Antenna Terminals

GMSK, Mid Channel, 836.6 MHz, TX signal +/- 20 MHz

Agilent 11:31:28 Mar 4, 2008

L

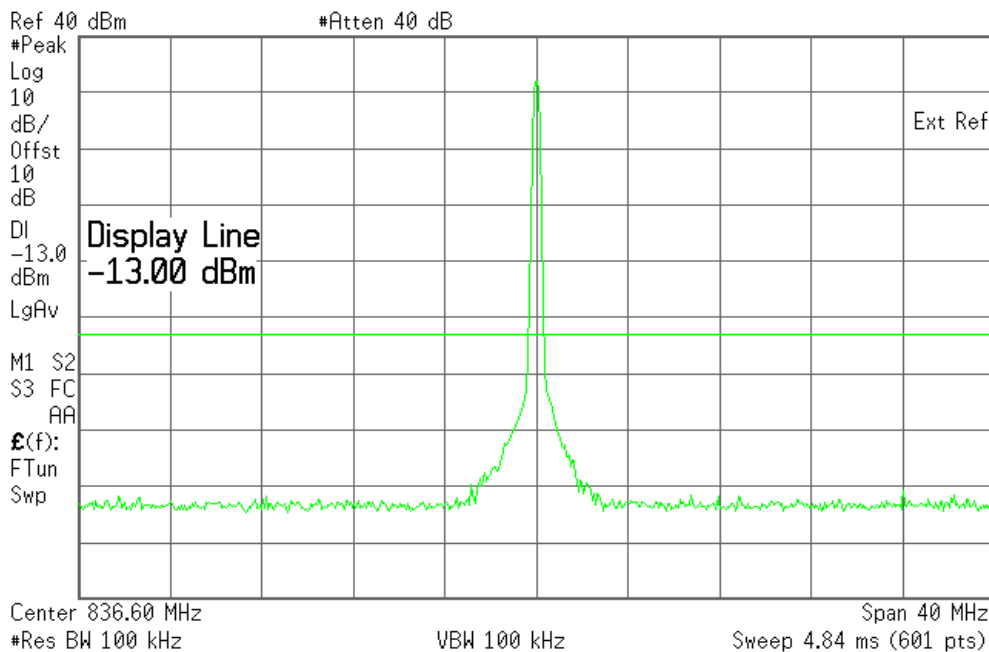

The strong emission shown in each case is the carrier signal.

© 2008 Sierra Wireless, Inc.

The contents of this page are subject to the confidentiality information on page one.

SIERRA WIRELESS, INC.

Plot 6.4.6) Out of Band Emissions at Antenna Terminals

GMSK, Mid Channel, 836.6 MHz, 1 GHz to 20 GHz

Agilent 11:34:10 Mar 4, 2008

L

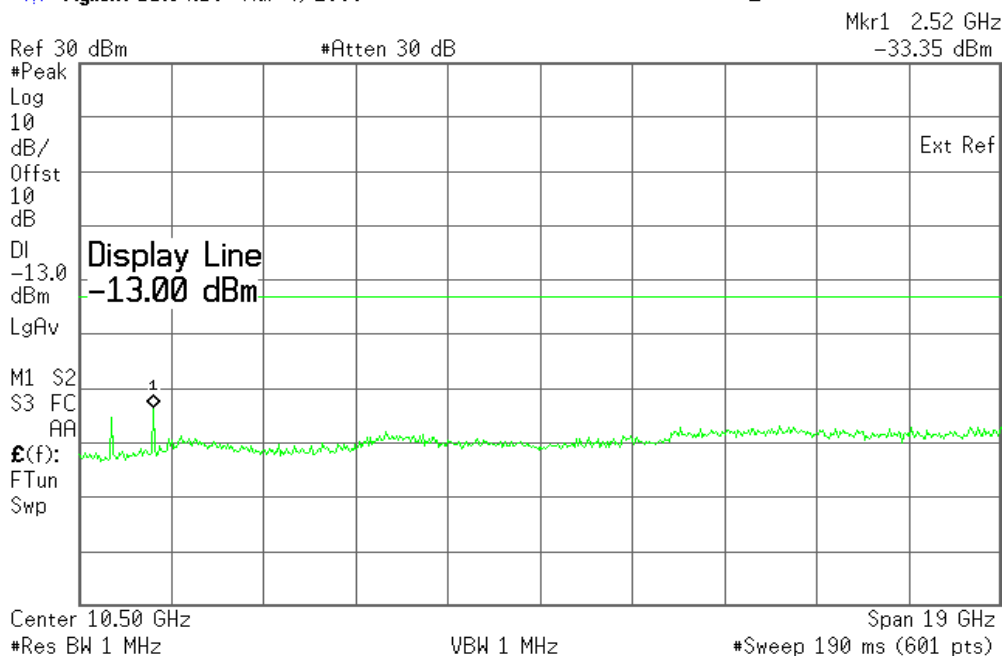

Cellular Harmonics for Ch. 190 (836.6 MHz)	Level (dBm)
Second	-34.96 dBm
Third	-33.35 dBm
All others	< -35 dBm up to 20GHz

SIERRA WIRELESS, INC.

Plot 6.4.7) Out of Band Emissions at Antenna Terminals

GMSK, High Channel, 848.8 MHz, 1 MHz to 1 GHz

Agilent 11:37:19 Mar 4, 2008

L

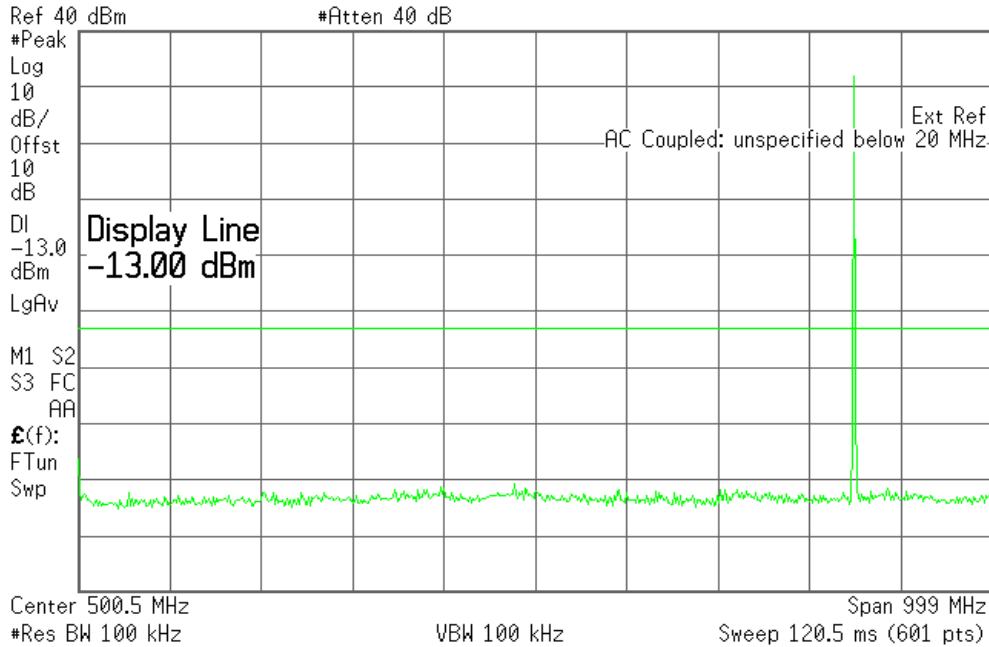

Plot 6.4.8) Out of Band Emissions at Antenna Terminals

GMSK, High Channel, 848.8 MHz, TX signal +/- 20 MHz

Agilent 11:40:42 Mar 4, 2008

L

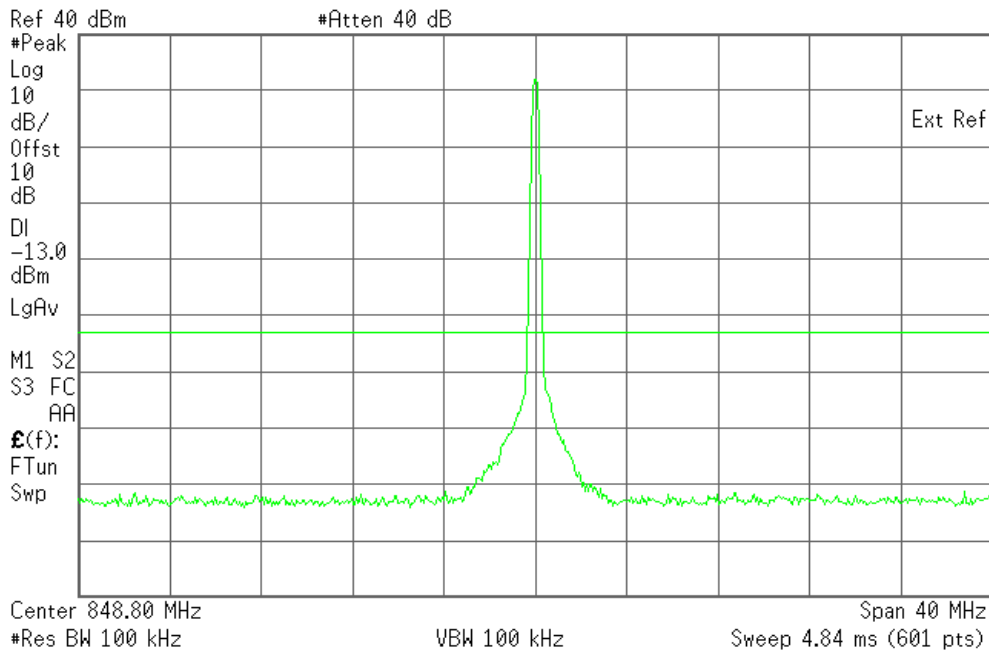

The strong emission shown in each case is the carrier signal.

© 2008 Sierra Wireless, Inc.

The contents of this page are subject to the confidentiality information on page one.

SIERRA WIRELESS, INC.

Plot 6.4.9) Out of Band Emissions at Antenna Terminals

GMSK, High Channel, 848.8 MHz, 1 GHz to 20 GHz

Agilent 11:42:56 Mar 4, 2008

L

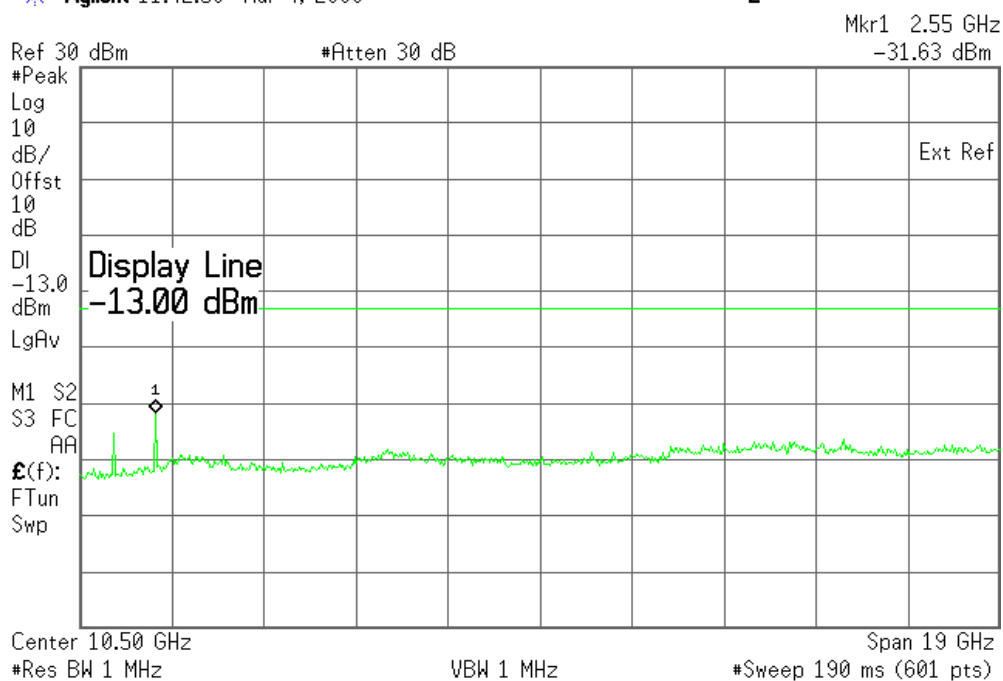

Cellular Harmonics for Ch. 251 (848.8 MHz)	Level (dBm)
Second	-35.37 dBm
Third	-31.63 dBm
All others	< -35 dBm up to 20GHz

SIERRA WIRELESS, INC.

Plot 6.4.10) Out of Band Emissions at Antenna Terminals

8-PSK, Low channel, 824.200 MHz, 1 MHz to 1 GHz

Agilent 11:45:38 Mar 4, 2008

L

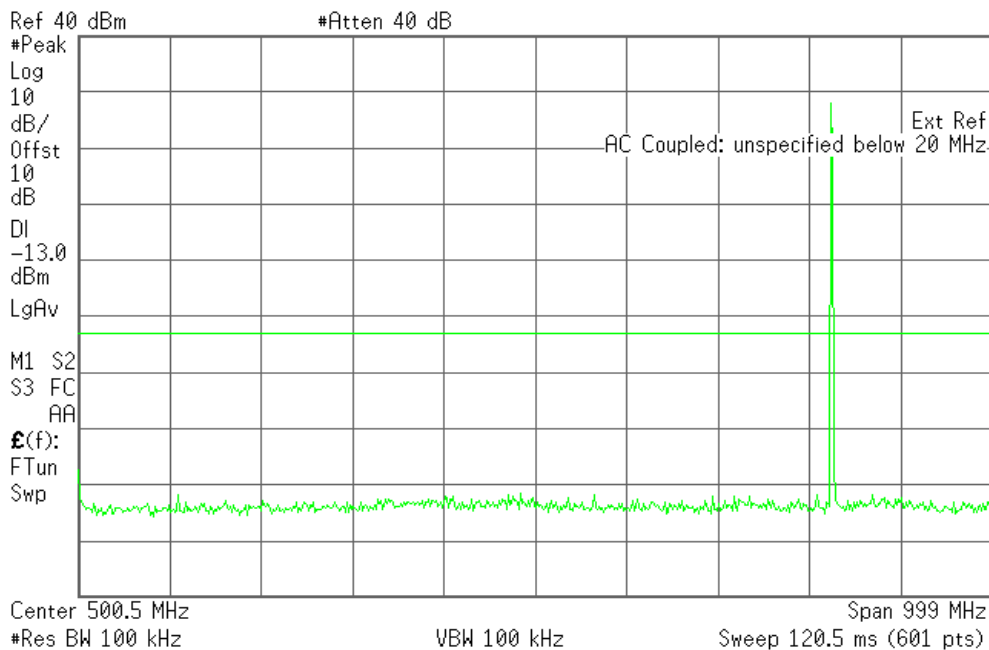

Plot 6.4.11) Out of Band Emissions at Antenna Terminals

8-PSK, Low channel, 824.200 MHz, TX signal +/- 20 MHz

Agilent 11:48:19 Mar 4, 2008

L

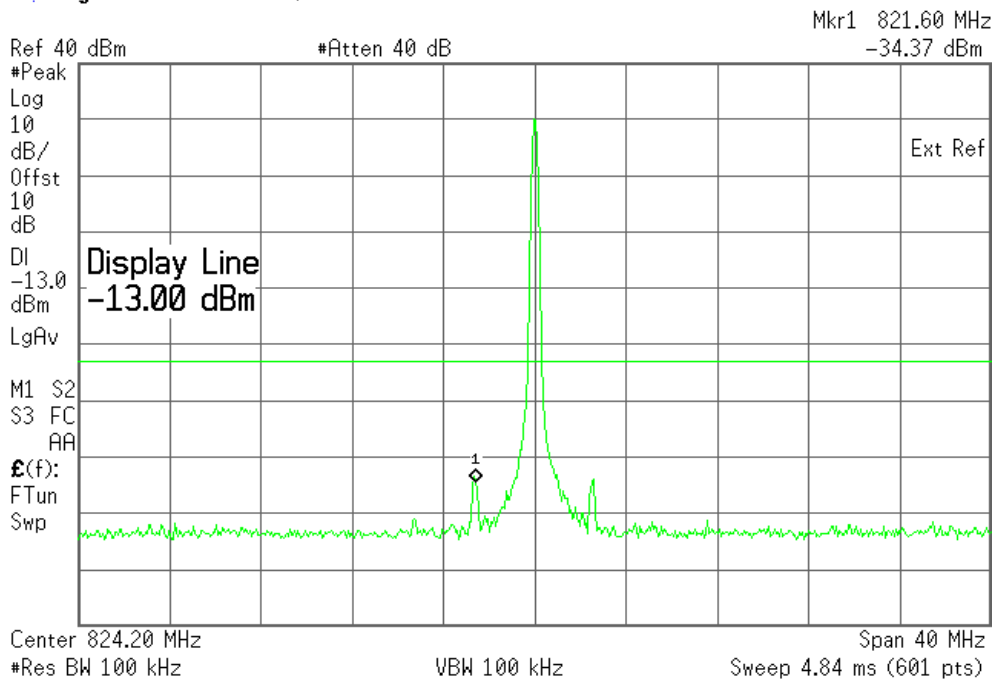

The strong emission shown in each case is the carrier signal.

© 2008 Sierra Wireless, Inc.

The contents of this page are subject to the confidentiality information on page one.

SIERRA WIRELESS, INC.

Plot 6.4.12) Out of Band Emissions at Antenna Terminals

8-PSK, Low channel, 824.200 MHz, 1 GHz to 20 GHz

Agilent 11:50:26 Mar 4, 2008

L

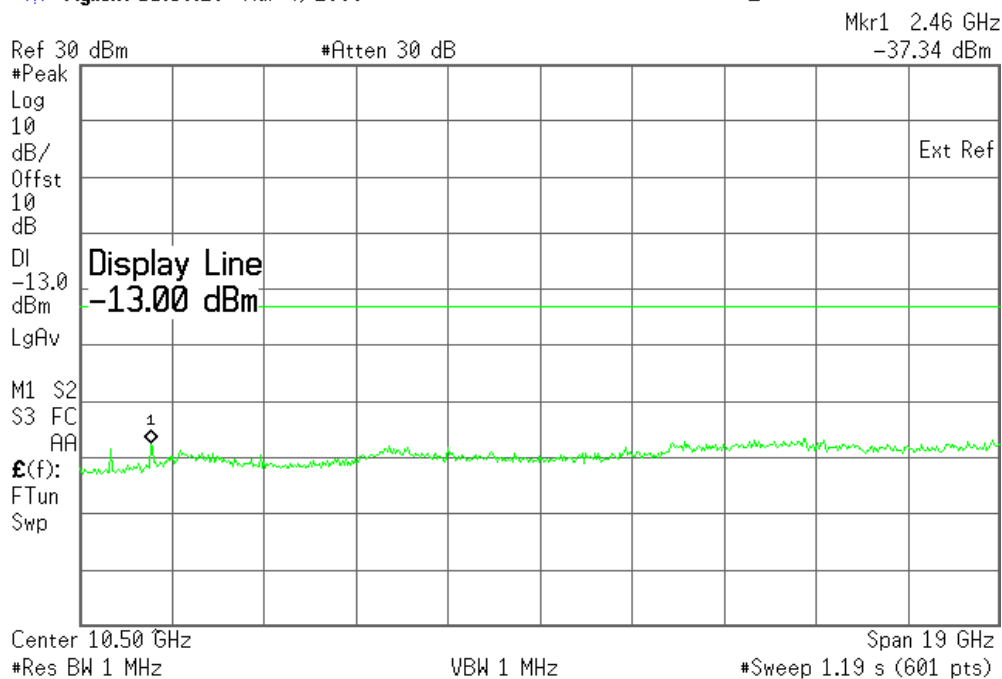

Cellular Harmonics for Ch. 128 (824.2 MHz)	Level (dBm)
Second	-38.74dBm
Third	-37.32 dBm
All others	< -35 dBm up to 20GHz

SIERRA WIRELESS, INC.

Plot 6.4.13) Out of Band Emissions at Antenna Terminals

8-PSK, Mid Channel, 836.6 MHz, 1 MHz to 1 GHz

* Agilent 11:53:39 Mar 4, 2008 L

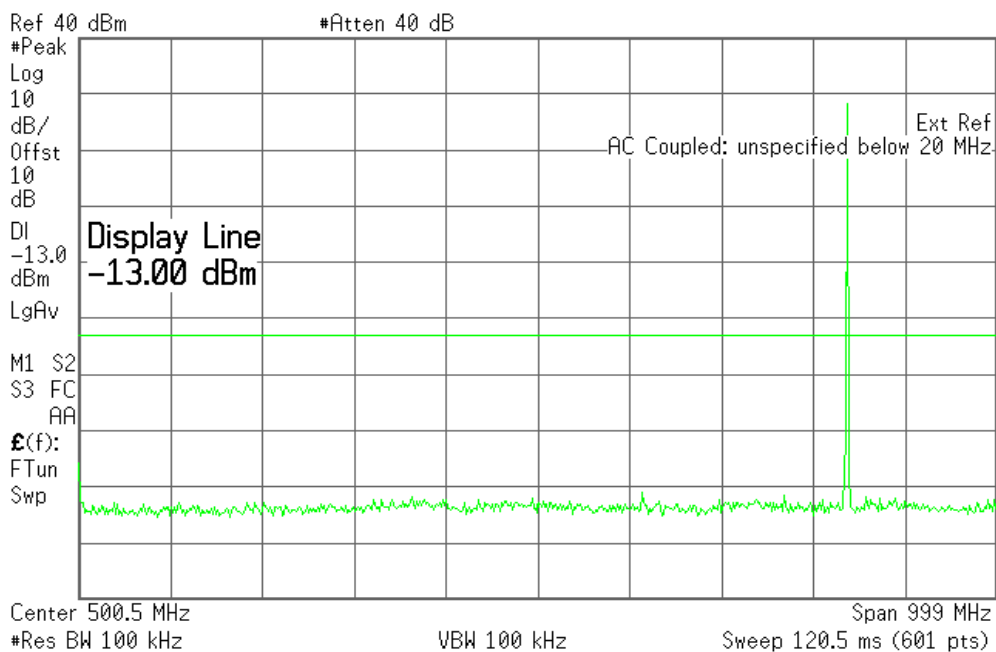

Plot 6.4.14) Out of Band Emissions at Antenna Terminals

8-PSK, Mid Channel, 836.6 MHz, TX signal +/- 20 MHz

* Agilent 11:55:05 Mar 4, 2008 L

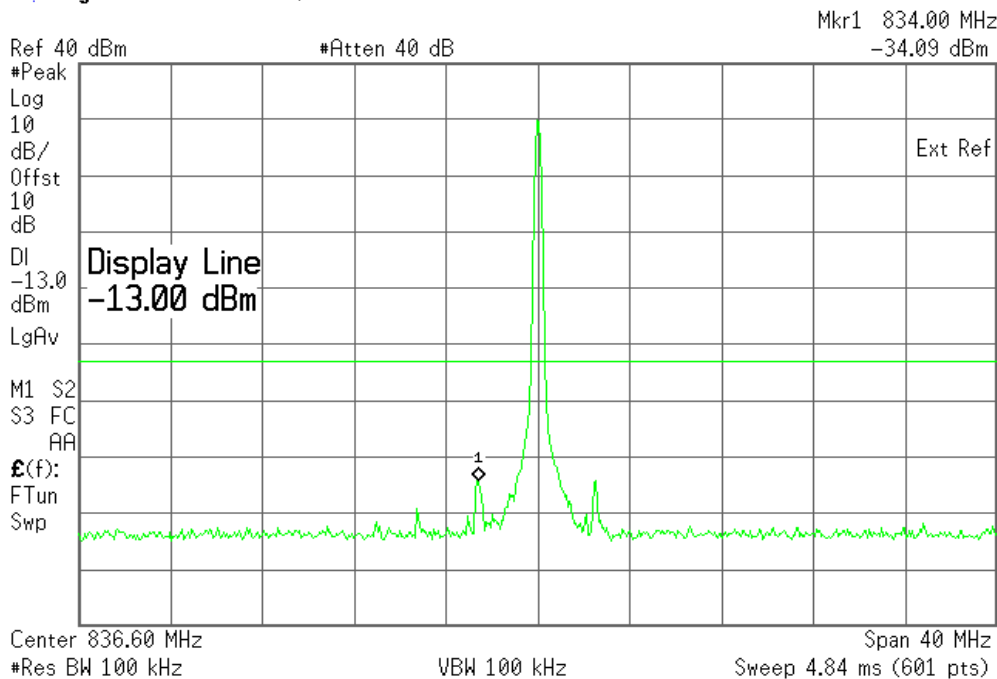

The strong emission shown in each case is the carrier signal.

© 2008 Sierra Wireless, Inc.

The contents of this page are subject to the confidentiality information on page one.

SIERRA WIRELESS, INC.

Plot 6.4.15) Out of Band Emissions at Antenna Terminals

8-PSK, Mid Channel, 836.6 MHz, 1 GHz to 20 GHz

Agilent 11:57:12 Mar 4, 2008

L

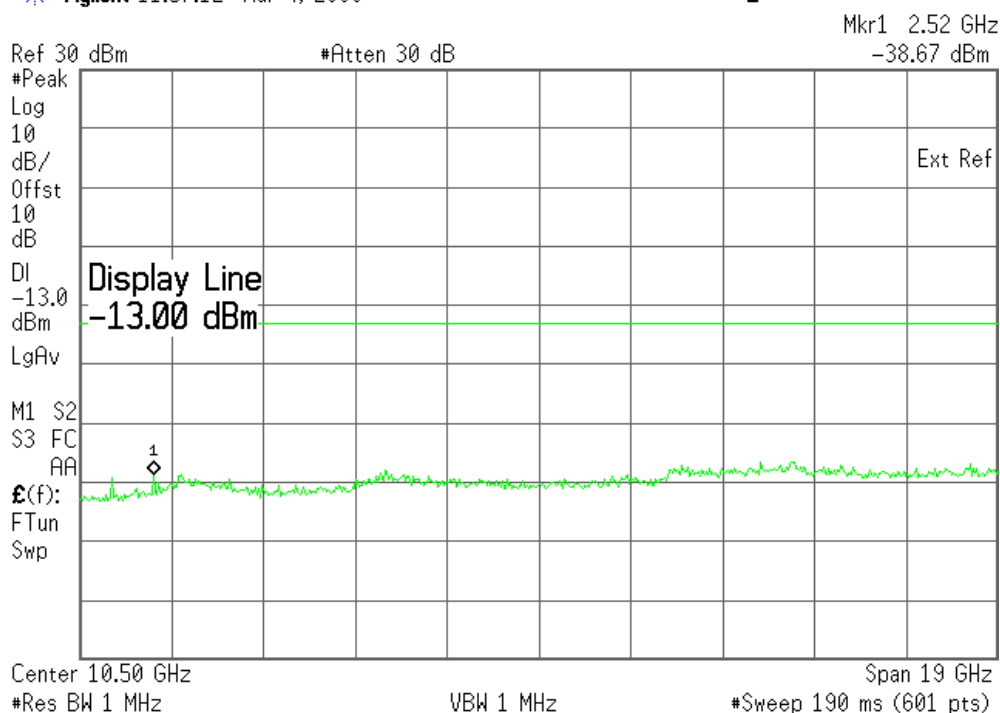

Cellular Harmonics for Ch. 190 (836.6 MHz)	Level (dBm)
Second	-38.93 dBm
Third	-38.67 dBm
All others	< -35 dBm up to 20GHz

SIERRA WIRELESS, INC.

Plot 6.4.16) Out of Band Emissions at Antenna Terminals

8-PSK, High Channel, 848.8 MHz, 1 MHz to 1 GHz

Agilent 12:00:00 Mar 4, 2008

L

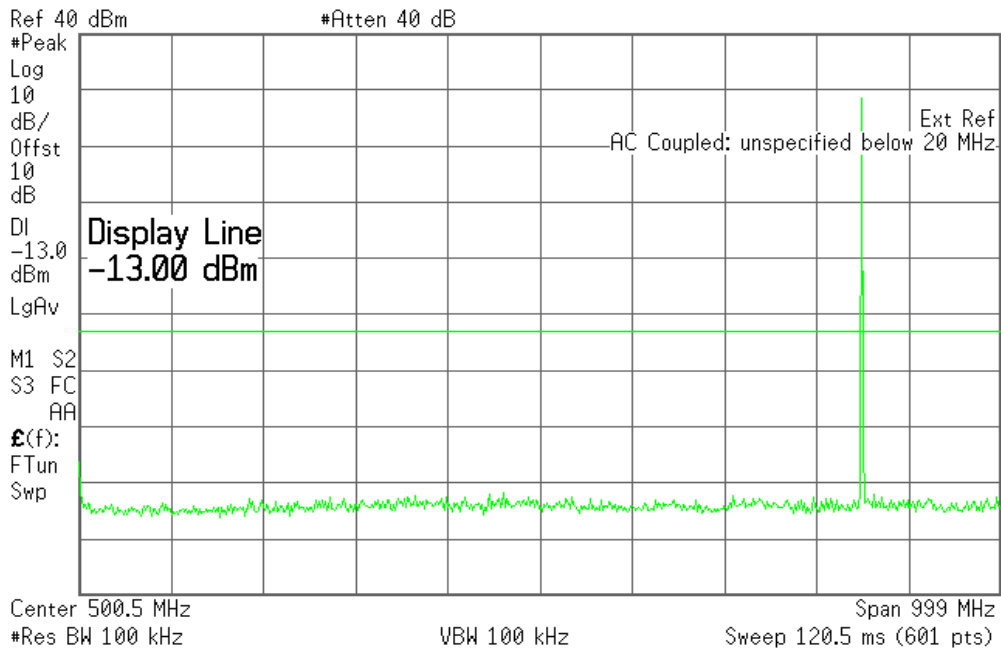

Plot 6.4.17) Out of Band Emissions at Antenna Terminals

8-PSK, High Channel, 848.8 MHz, TX signal +/- 20 MHz

Agilent 12:02:07 Mar 4, 2008

L

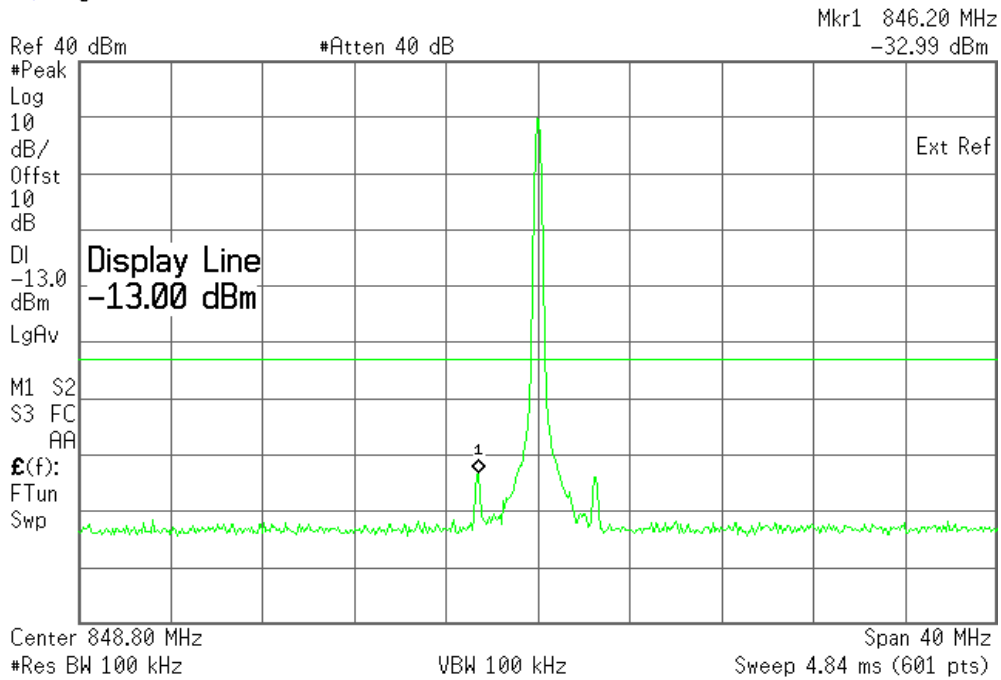

The strong emission shown in each case is the carrier signal.

© 2008 Sierra Wireless, Inc.

The contents of this page are subject to the confidentiality information on page one.

SIERRA WIRELESS, INC.

Plot 6.4.18) Out of Band Emissions at Antenna Terminals

8-PSK, High Channel, 848.8 MHz, 1 GHz to 20 GHz

Agilent 12:04:20 Mar 4, 2008

L

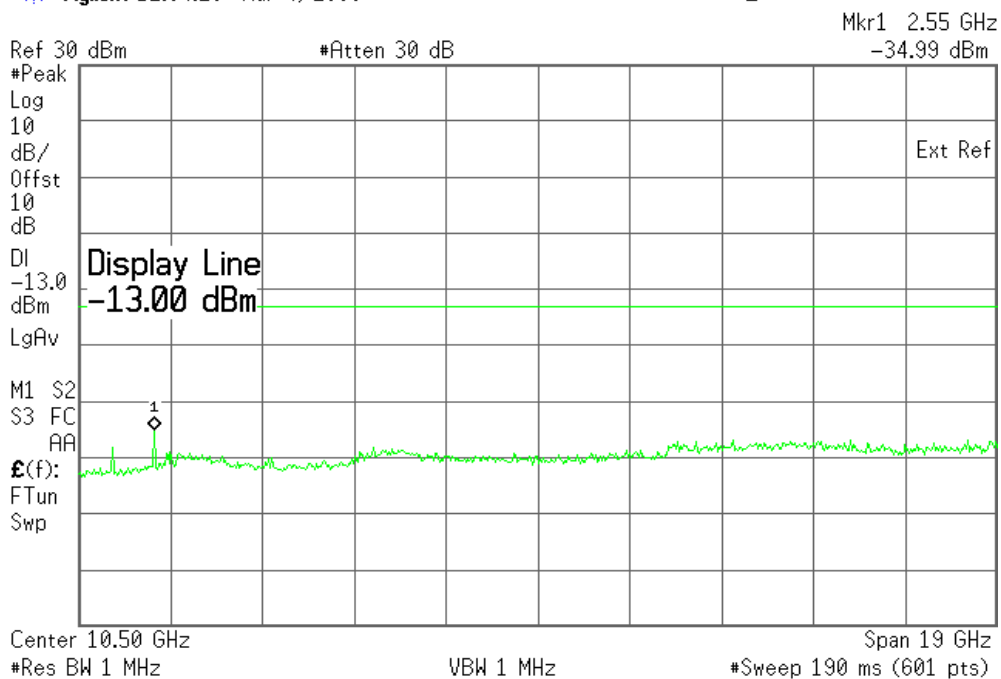

Cellular Harmonics for Ch. 251 (848.8 MHz)	Level (dBm)
Second	-38.63 dBm
Third	-34.99 dBm
All others	< -35 dBm up to 20GHz

SIERRA WIRELESS, INC.

Plot 6.4.19) Out of Band Emissions at Antenna Terminals

GMSK, Low channel, 1850.2 MHz, 1 MHz to 1 GHz

Agilent 13:11:00 Mar 4, 2008

L

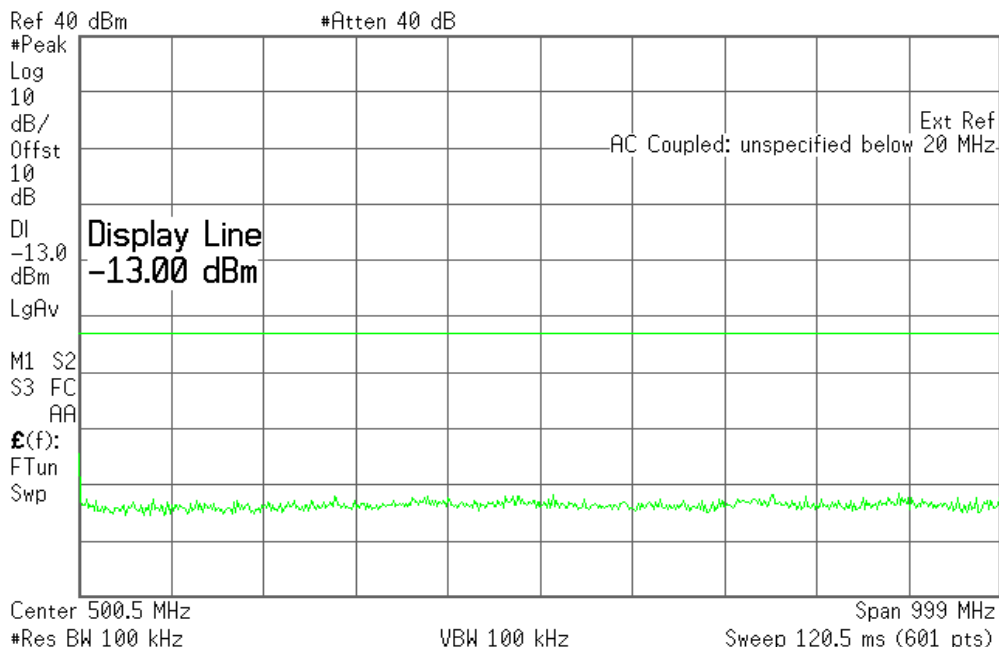

Plot 6.4.20) Out of Band Emissions at Antenna Terminals

GMSK, Low channel, 1850.2 MHz, TX signal +/- 20 MHz

Agilent 13:13:14 Mar 4, 2008

L

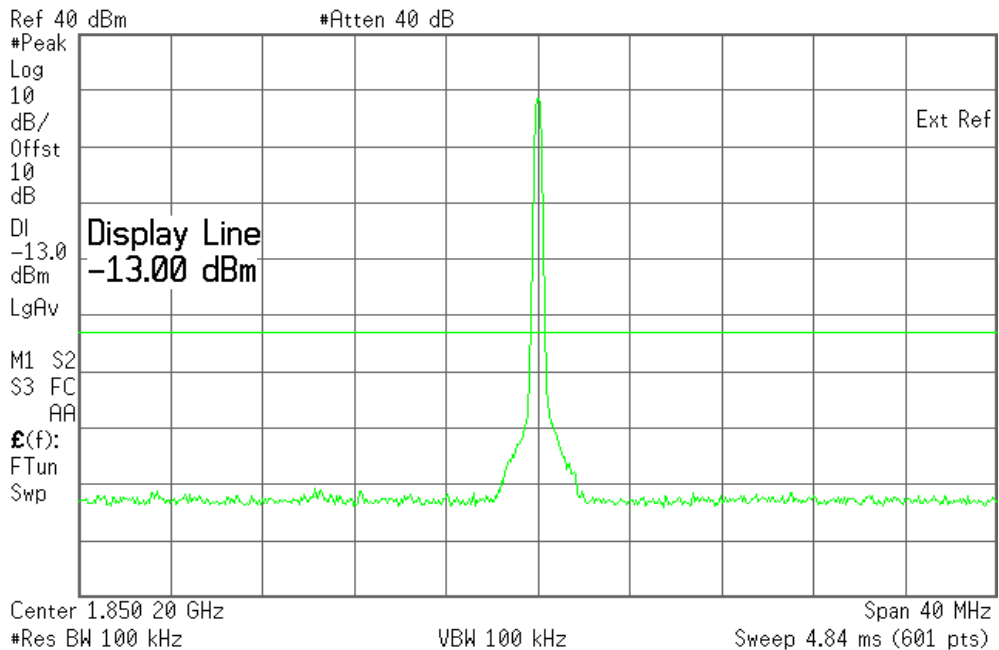

The strong emission shown is the carrier signal.

© 2008 Sierra Wireless, Inc.

The contents of this page are subject to the confidentiality information on page one.

SIERRA WIRELESS, INC.

Plot 6.4.21) Out of Band Emissions at Antenna Terminals

GMSK, Low channel, 1850.2 MHz, 1 GHz to 20 GHz

Agilent 13:15:20 Mar 4, 2008

L

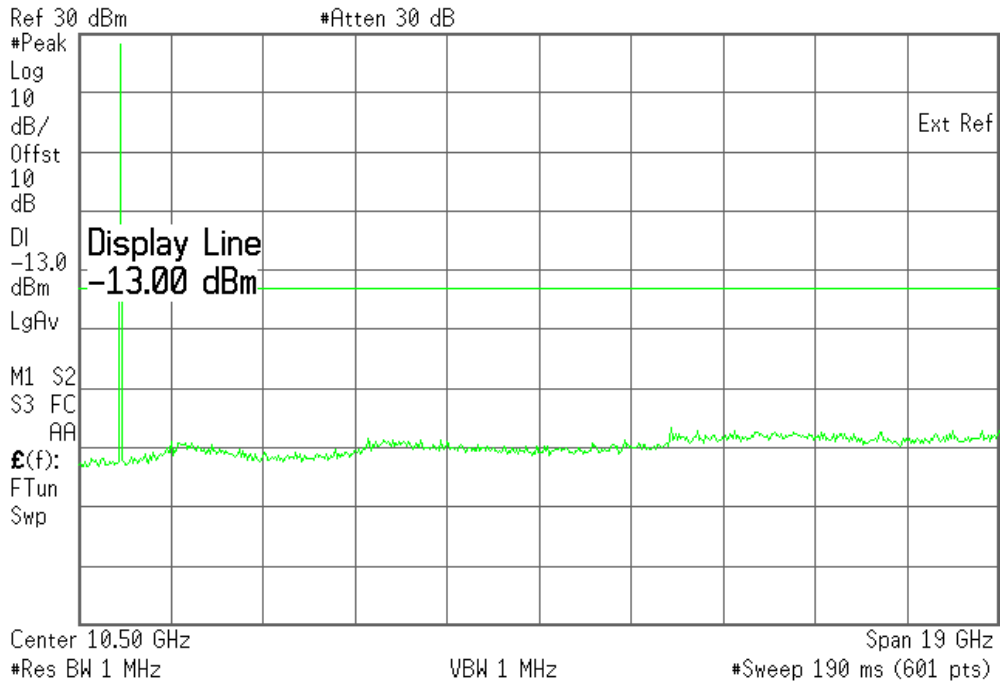

The strong emission shown is the carrier signal.

SIERRA WIRELESS, INC.

Plot 6.4.22) Out of Band Emissions at Antenna Terminals

GMSK, Middle channel, 1880.0 MHz, 1 MHz to 1 GHz

Agilent 13:18:06 Mar 4, 2008

L

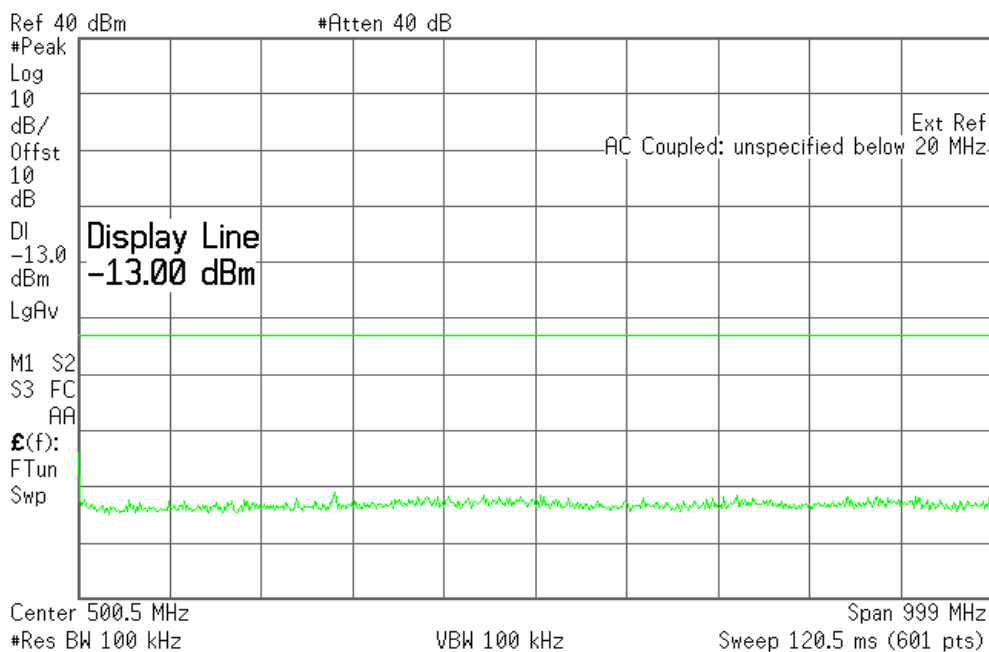

Plot 6.4.23) Out of Band Emissions at Antenna Terminals

GMSK, Middle channel, 1880.0 MHz, TX signal +/- 20 MHz

Agilent 13:20:10 Mar 4, 2008

L

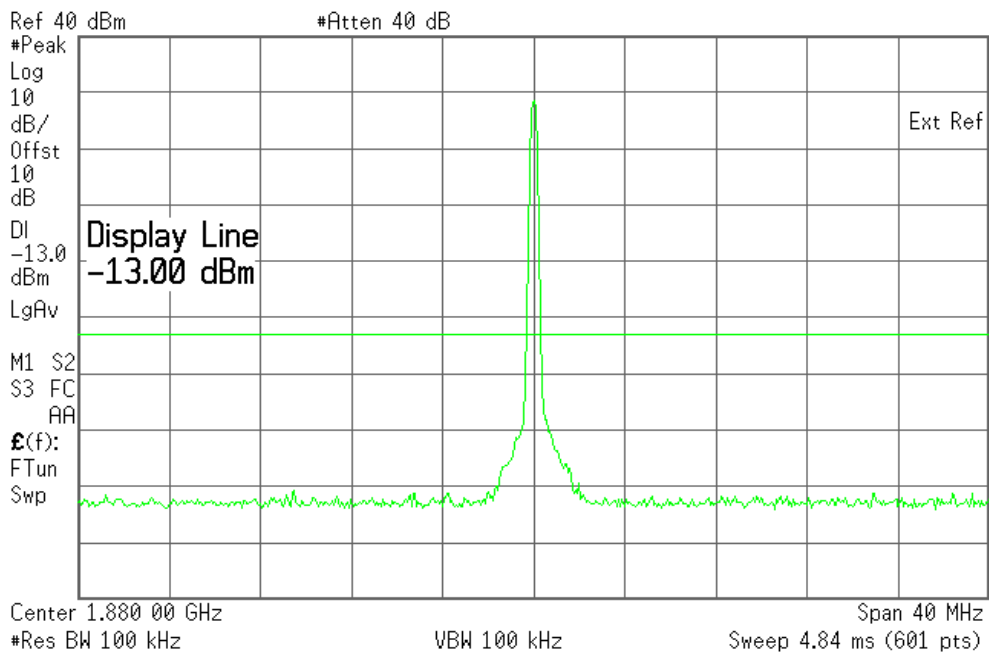

The strong emission shown is the carrier signal.

© 2008 Sierra Wireless, Inc.

The contents of this page are subject to the confidentiality information on page one.

SIERRA WIRELESS, INC.

Plot 6.4.24) Out of Band Emissions at Antenna Terminals
GMSK, Middle channel, 1880.0 MHz, 1 GHz to 20 GHz

Agilent 13:22:17 Mar 4, 2008

L

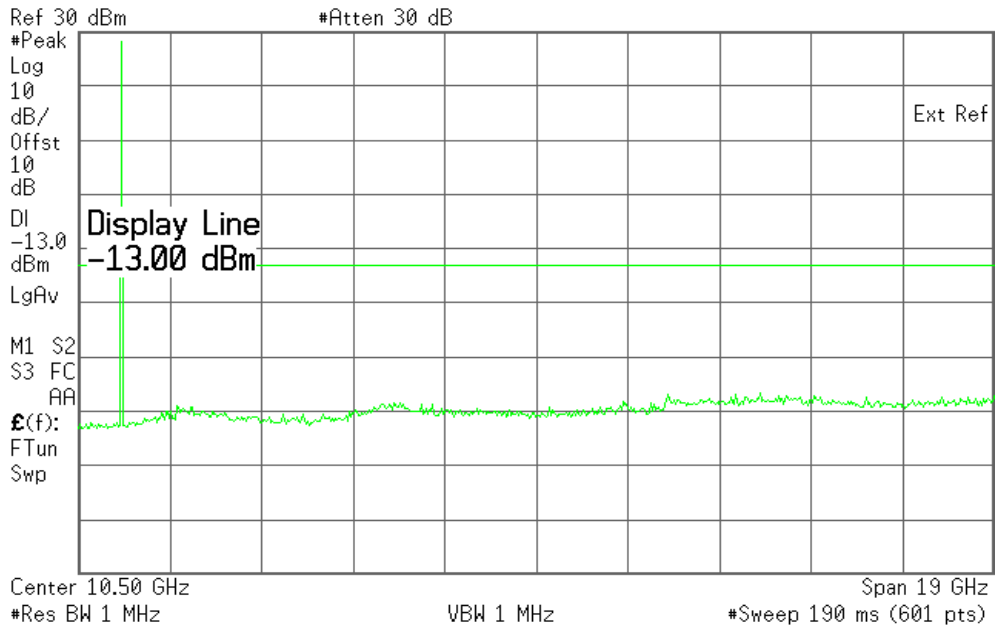

The strong emission shown is the carrier signal.

SIERRA WIRELESS, INC.

Plot 6.4.25) Out of Band Emissions at Antenna Terminals

GMSK, High channel, 1909.8 MHz, 1 MHz to 1 GHz

Agilent 13:25:04 Mar 4, 2008

L

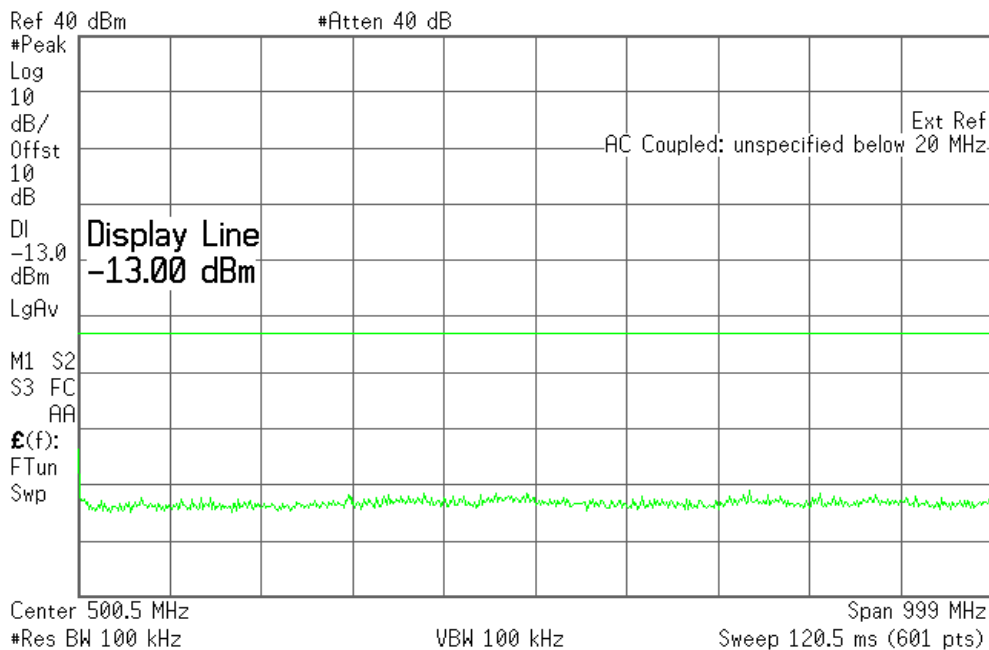

Plot 6.4.26) Out of Band Emissions at Antenna Terminals

GMSK, High channel, 1909.8 MHz, TX signal +/- 20 MHz

Agilent 13:27:22 Mar 4, 2008

L

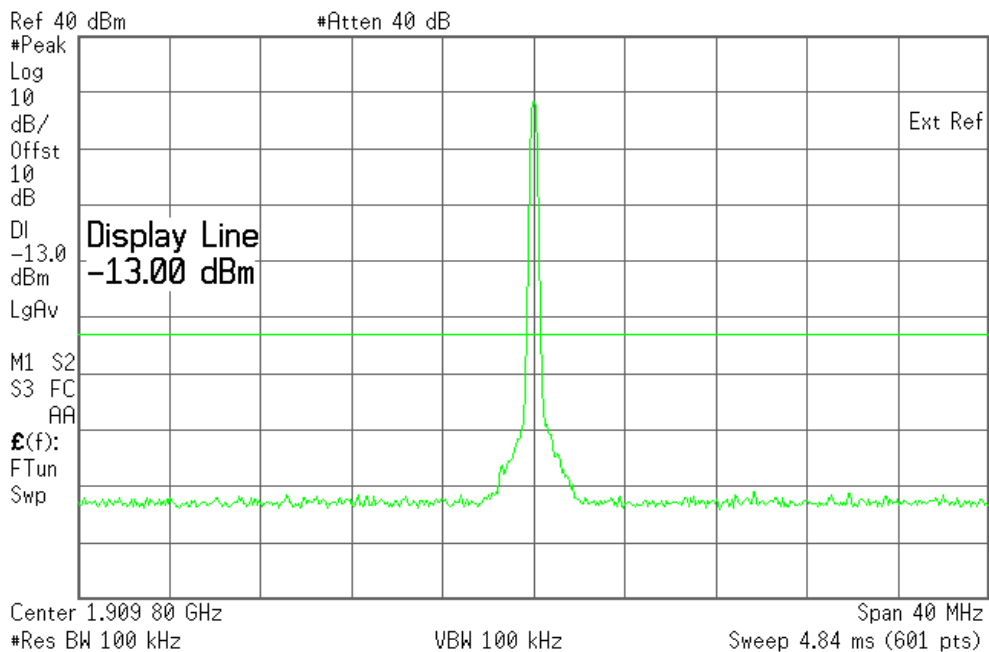

The strong emission shown is the carrier signal.

© 2008 Sierra Wireless, Inc.

The contents of this page are subject to the confidentiality information on page one.

SIERRA WIRELESS, INC.

Plot 6.4.27) Out of Band Emissions at Antenna Terminals

GMSK, High channel, 1909.8 MHz, 1 GHz to 20 GHz

Agilent 13:29:29 Mar 4, 2008

L

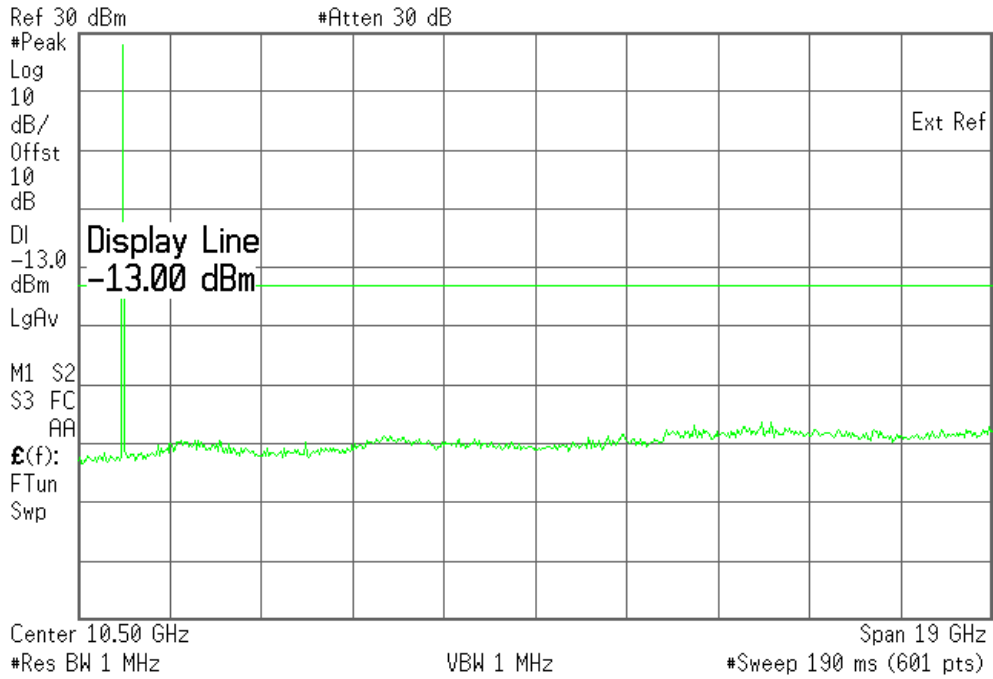

The strong emission shown is the carrier signal.

SIERRA WIRELESS, INC.

Plot 6.4.28) Out of Band Emissions at Antenna Terminals

8-PSK, Low channel, 1850.2 MHz, 1 MHz to 1 GHz

Agilent 13:32:48 Mar 4, 2008

L

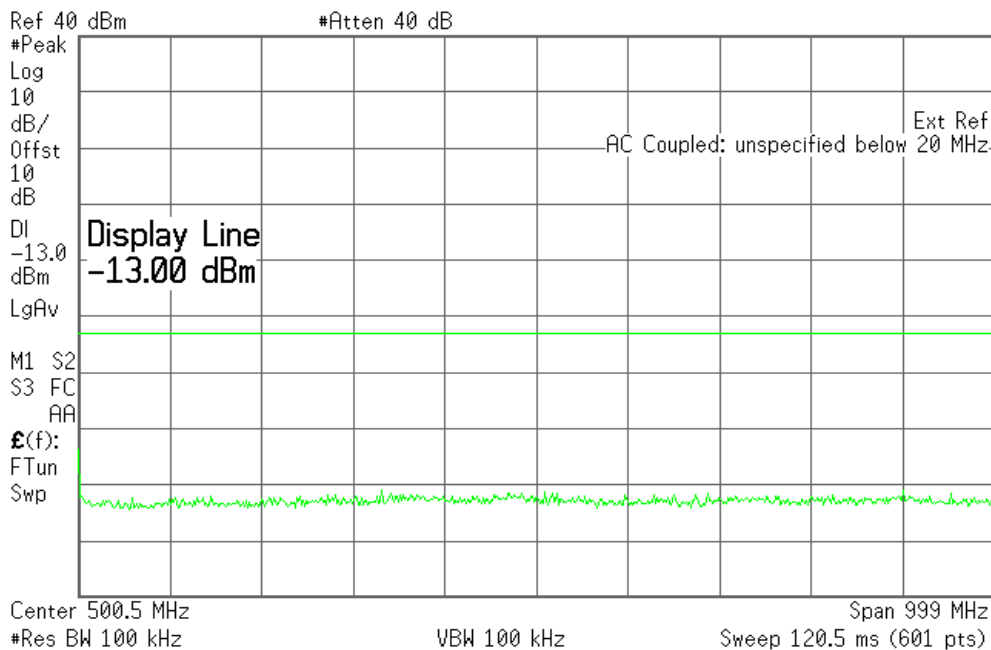

Plot 6.4.29) Out of Band Emissions at Antenna Terminals

8-PSK, Low channel, 1850.2 MHz, TX signal +/- 20 MHz

Agilent 13:34:35 Mar 4, 2008

L

Mkr1 1.852 73 GHz
-32.79 dBm

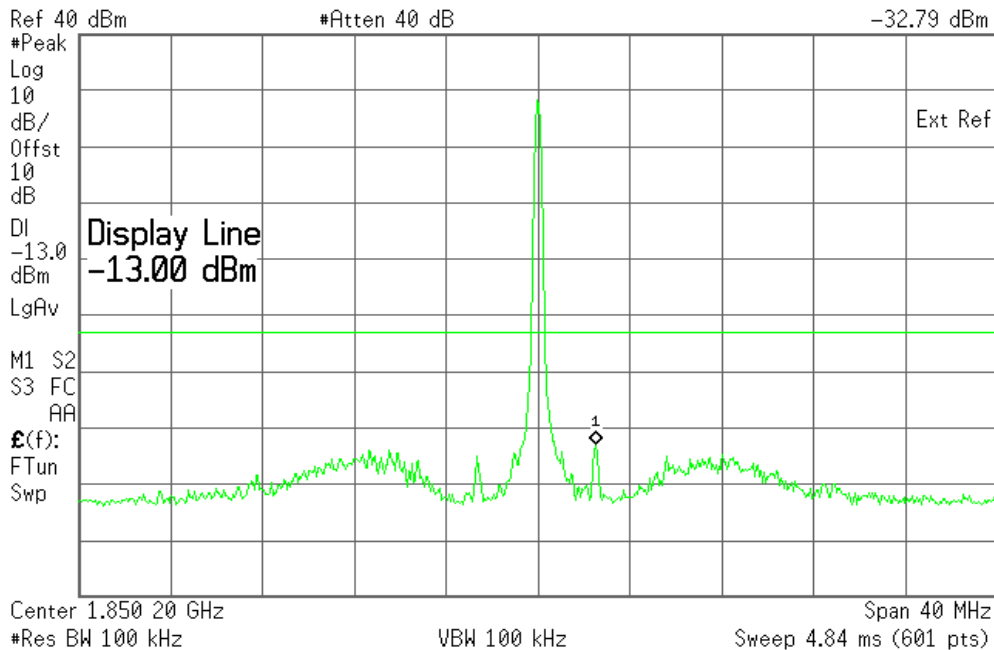

The strong emission shown is the carrier signal.

© 2008 Sierra Wireless, Inc.

The contents of this page are subject to the confidentiality information on page one.

SIERRA WIRELESS, INC.

Plot 6.4.30) Out of Band Emissions at Antenna Terminals

8-PSK, Low channel, 1850.2 MHz, 1 GHz to 20 GHz

Agilent 13:37:54 Mar 4, 2008

L

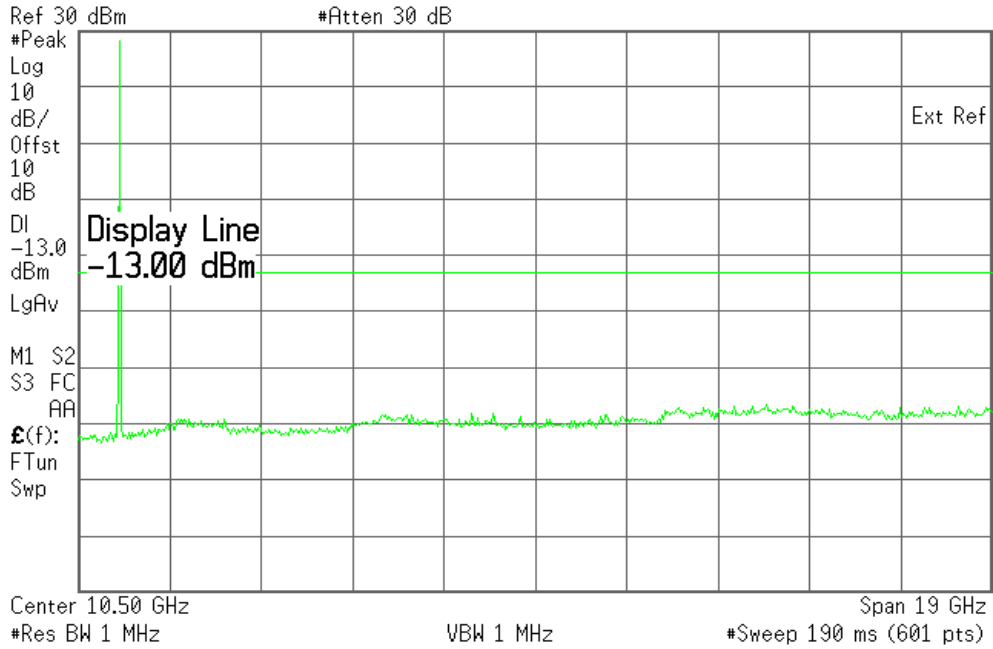

The strong emission shown is the carrier signal.

SIERRA WIRELESS, INC.

Plot 6.4.31) Out of Band Emissions at Antenna Terminals

8-PSK, Middle channel, 1880.0 MHz, 1 MHz to 1 GHz

Agilent 13:43:38 Mar 4, 2008

L

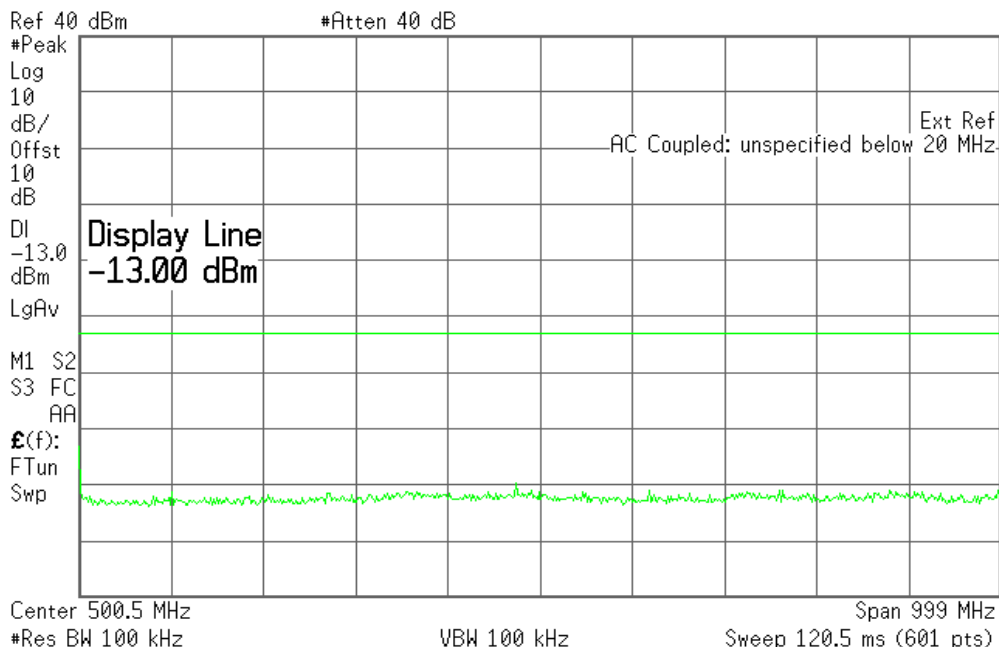

Plot 6.4.32) Out of Band Emissions at Antenna Terminals

8-PSK, Middle channel, 1880.0 MHz, TX signal +/- 20 MHz

Agilent 13:48:00 Mar 4, 2008

L

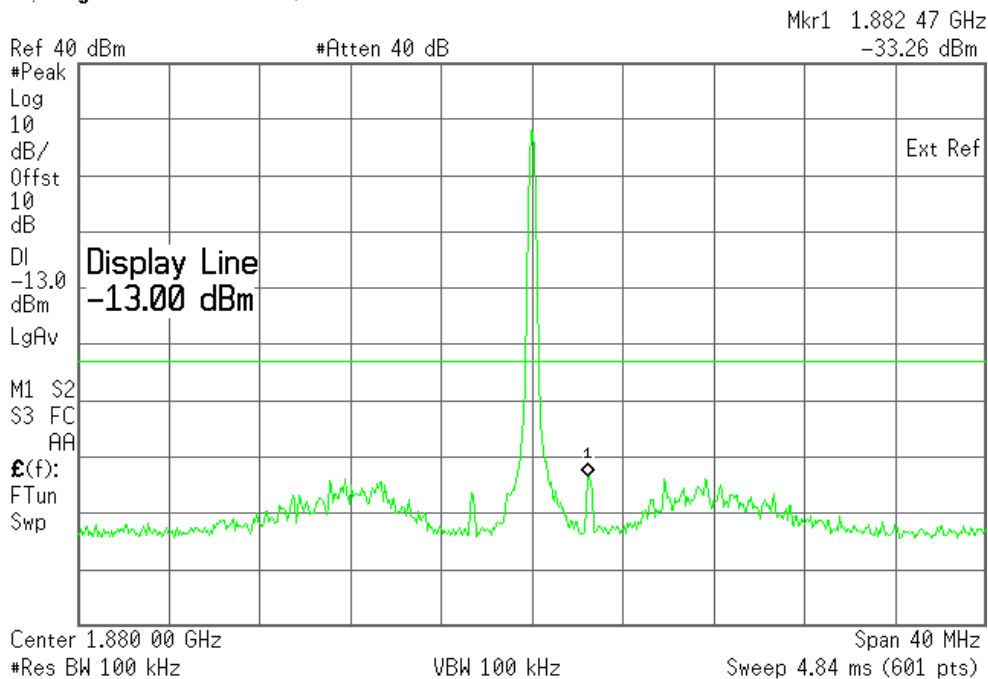

The strong emission shown is the carrier signal.

© 2008 Sierra Wireless, Inc.

The contents of this page are subject to the confidentiality information on page one.

SIERRA WIRELESS, INC.

Plot 6.4.33) Out of Band Emissions at Antenna Terminals

8-PSK, Middle channel, 1880.0 MHz, 1 GHz to 20 GHz

Agilent 13:50:12 Mar 4, 2008

L

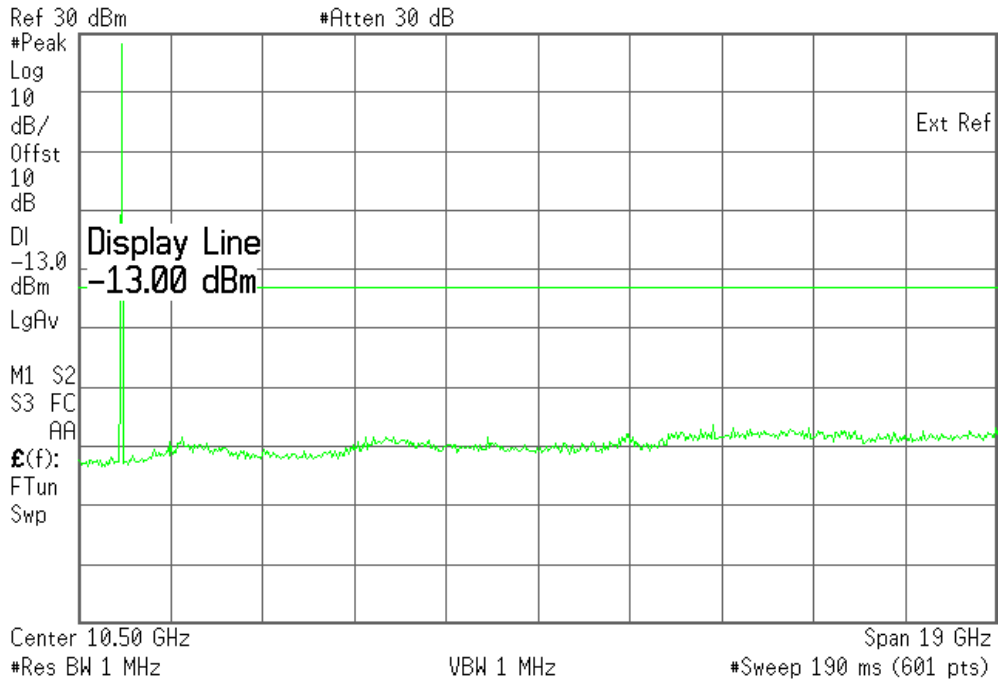

The strong emission shown is the carrier signal.

SIERRA WIRELESS, INC.

Plot 6.4.34) Out of Band Emissions at Antenna Terminals

8-PSK, High channel, 1909.8 MHz, 1 MHz to 1 GHz

* Agilent 13:53:11 Mar 4, 2008

L

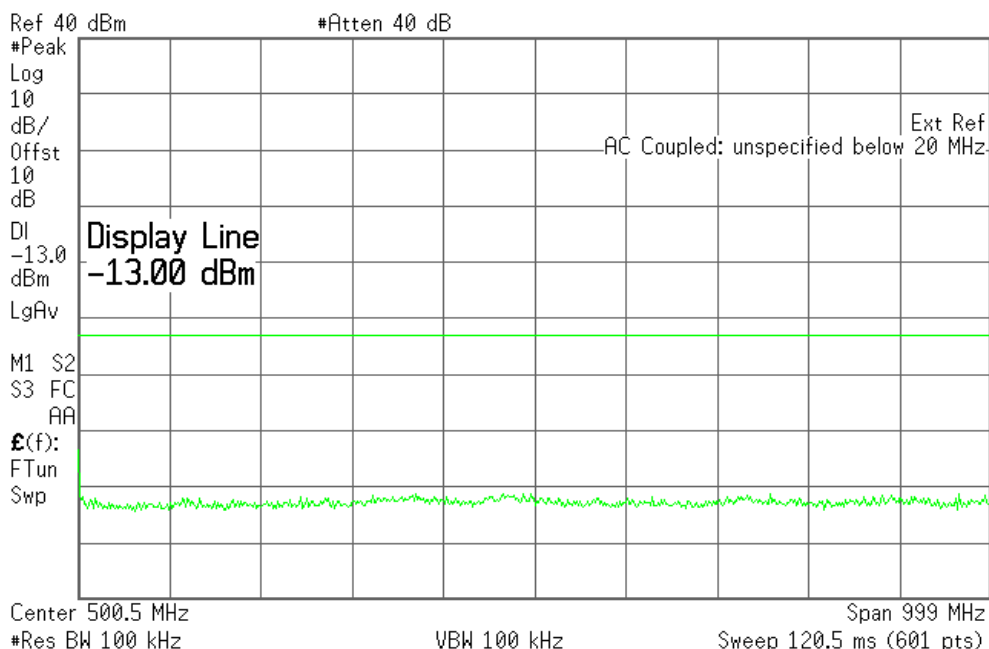

Plot 6.4.35) Out of Band Emissions at Antenna Terminals

8-PSK, High channel, 1909.8 MHz, TX signal +/- 20 MHz

* Agilent 13:56:07 Mar 4, 2008

L

Mkr1 1.918 13 GHz
-33.87 dBm

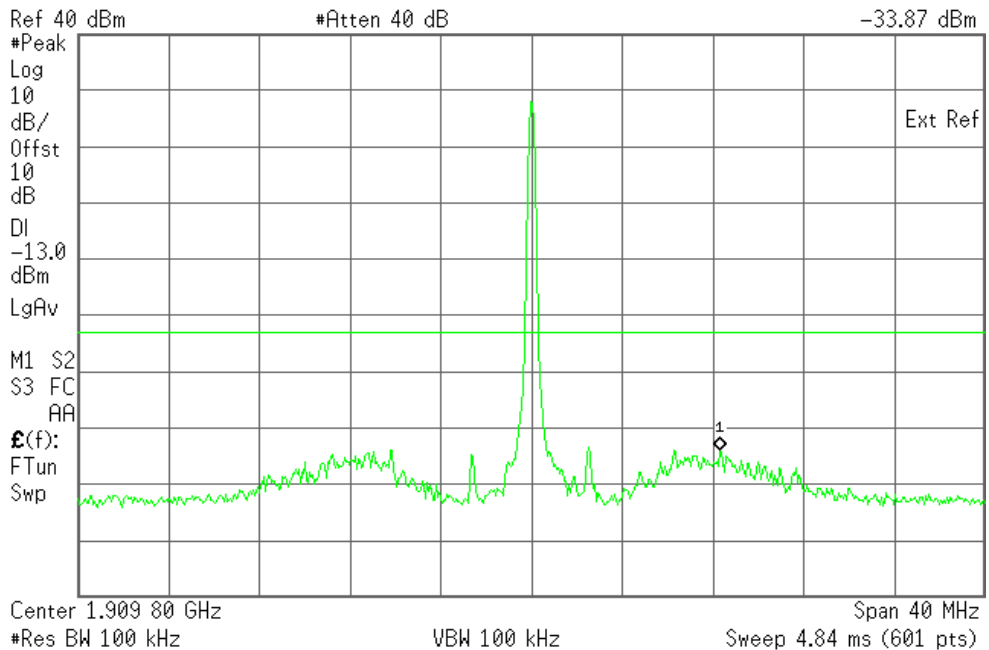

The strong emission shown is the carrier signal.

© 2008 Sierra Wireless, Inc.

The contents of this page are subject to the confidentiality information on page one.

SIERRA WIRELESS, INC.

Plot 6.4.36) Out of Band Emissions at Antenna Terminals
8-PSK, High channel, 1909.8 MHz, 1 GHz to 20 GHz

✱ Agilent 13:58:17 Mar 4, 2008

L

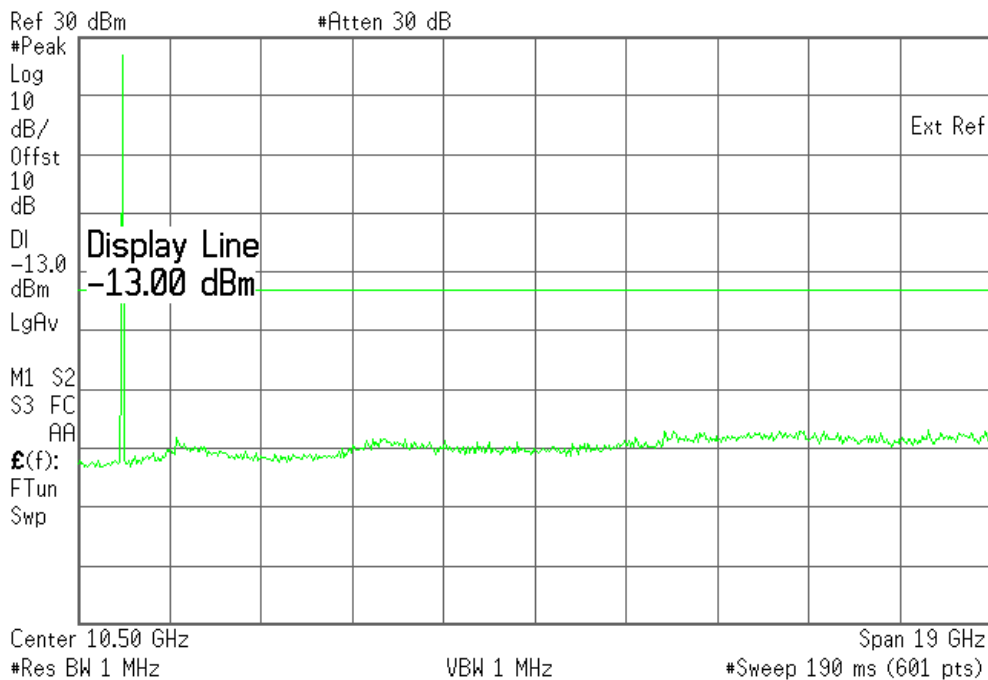

The strong emission shown is the carrier signal.

SIERRA WIRELESS, INC.

Plot 6.4.37) Out of Band Emissions at Antenna Terminals

WCDMA, Low channel, 1852.4 MHz, 1 MHz to 1 GHz

* Agilent 15:48:21 Mar 4, 2008

L

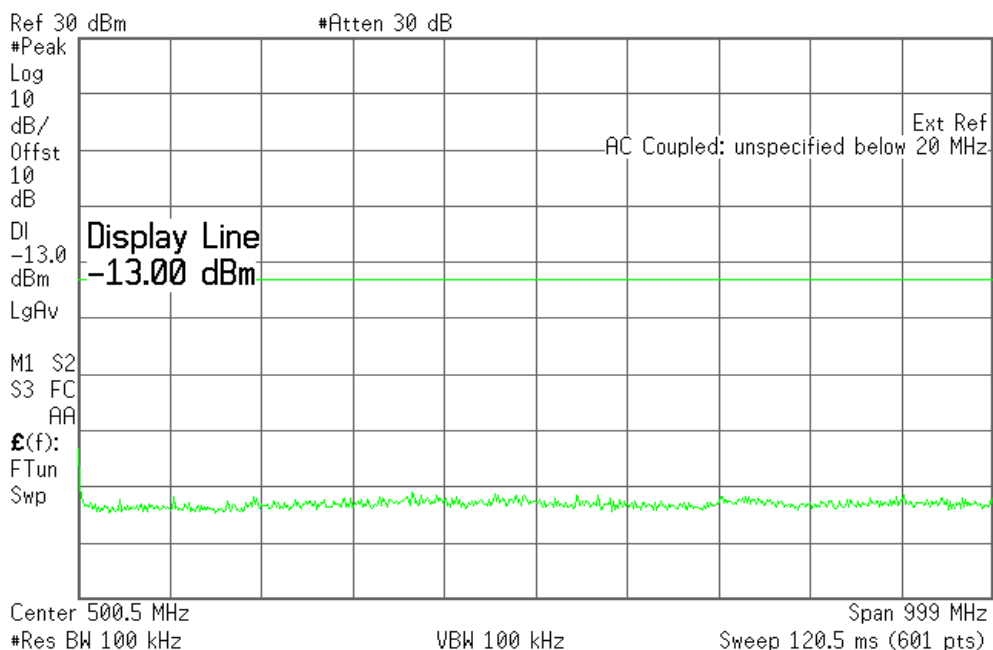

Plot 6.4.38) Out of Band Emissions at Antenna Terminals

WCDMA, Low channel, 1852.4 MHz, TX signal +/- 20 MHz

* Agilent 15:50:36 Mar 4, 2008

L

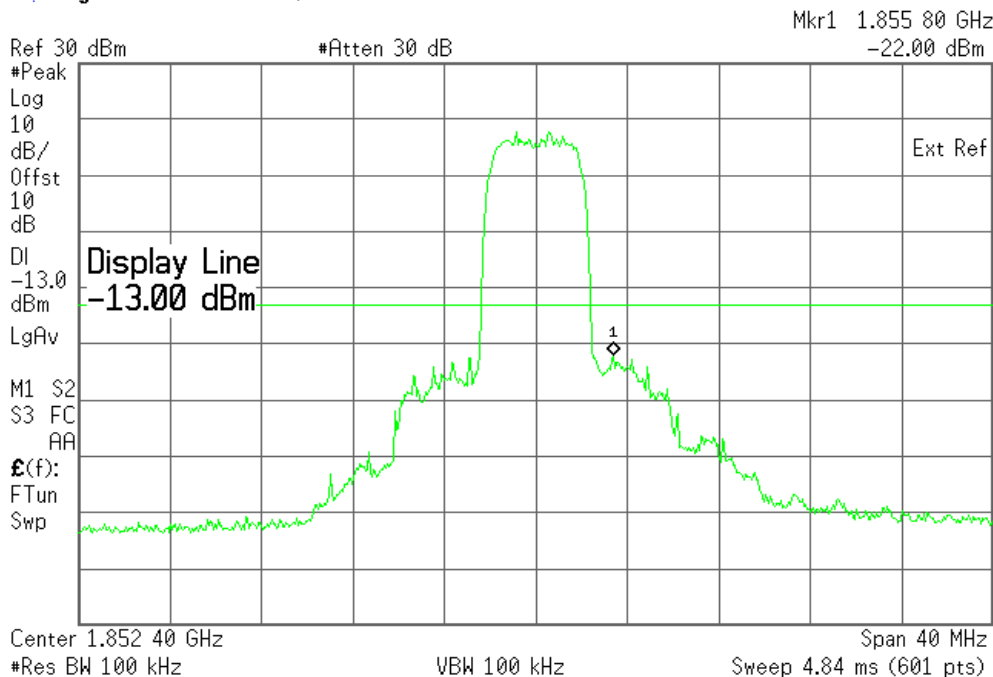

© 2008 Sierra Wireless, Inc.

The contents of this page are subject to the confidentiality information on page one.

SIERRA WIRELESS, INC.

Plot 6.4.39) Out of Band Emissions at Antenna Terminals

WCDMA, Low channel, 1852.4 MHz, 1 GHz to 20 GHz

Agilent 15:52:51 Mar 4, 2008

L

Mkr1 3.69 GHz
-37.71 dBm

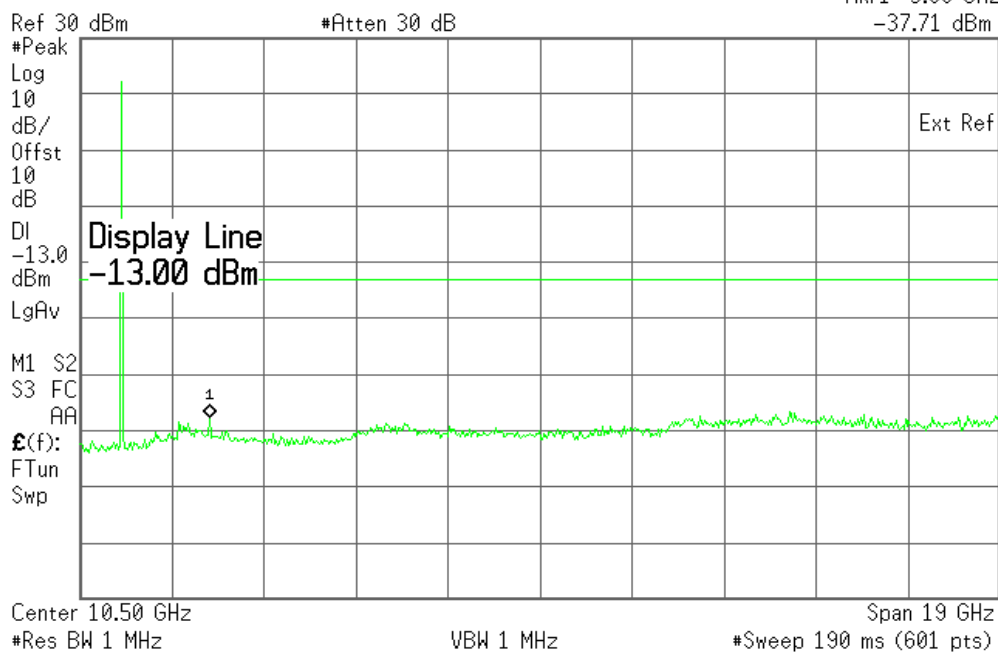

The strong emission shown is the carrier signal.

PCS Harmonics for Ch. 9262 (1852.4 MHz)	Level (dBm)
Second	- 37.71 dBm
Third	--
All others	< -35 dBm up to 20GHz

SIERRA WIRELESS, INC.

Plot 6.4.40) Out of Band Emissions at Antenna Terminals

WCDMA, Middle channel, 1880 MHz, 1 MHz to 1 GHz

* Agilent 16:02:40 Mar 4, 2008

L

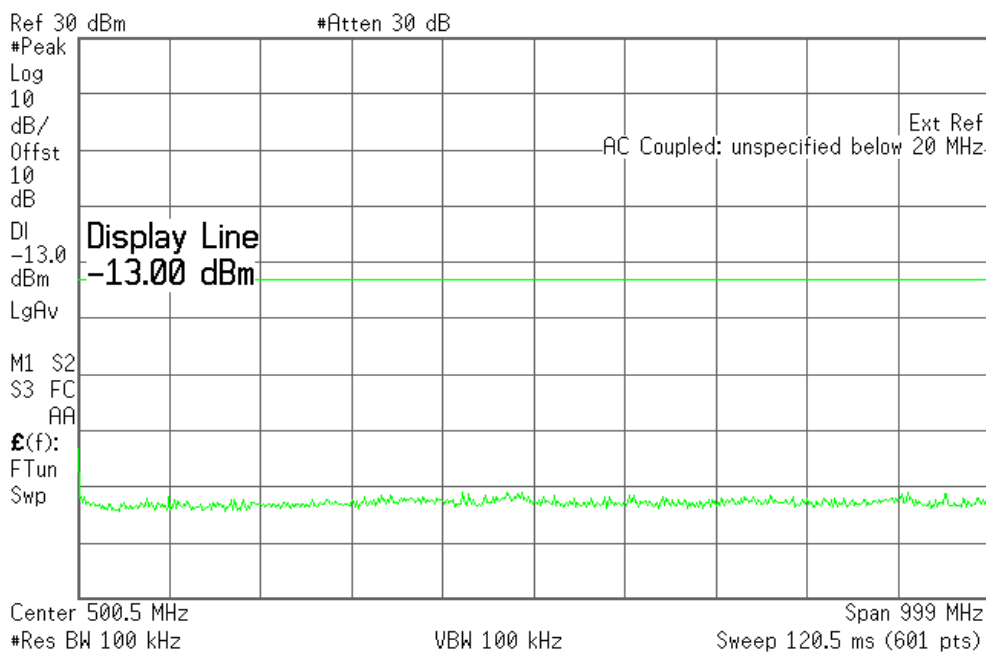

Plot 6.4.41) Out of Band Emissions at Antenna Terminals

WCDMA, Middle channel, 1880 MHz, TX signal +/- 20 MHz

* Agilent 16:07:21 Mar 4, 2008

L

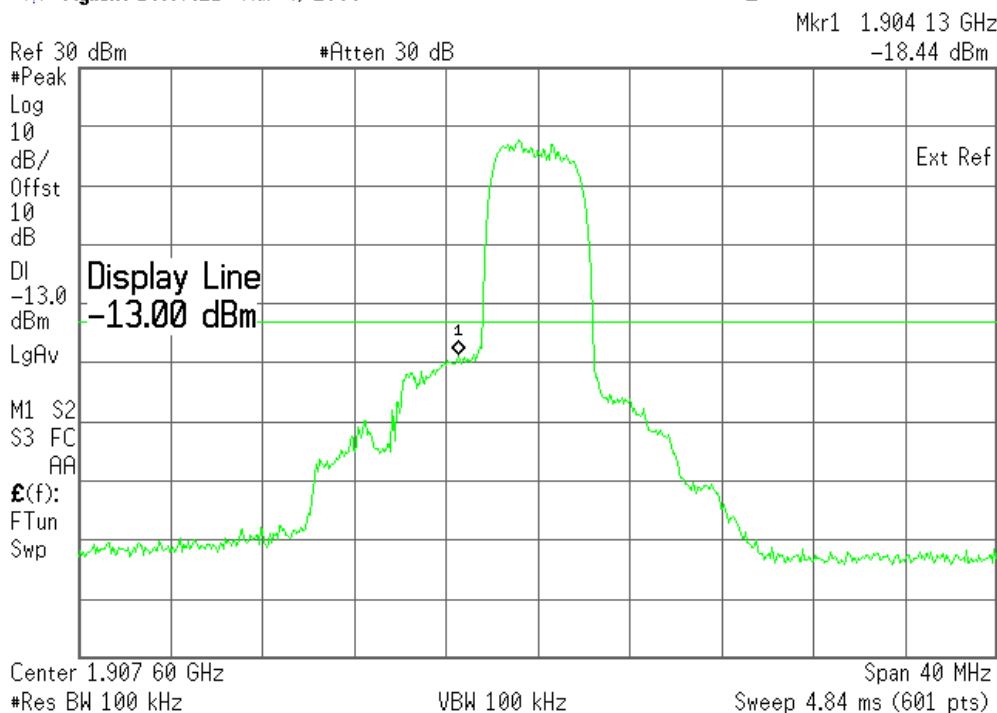

© 2008 Sierra Wireless, Inc.

The contents of this page are subject to the confidentiality information on page one.

SIERRA WIRELESS, INC.

Plot 6.4.42) Out of Band Emissions at Antenna Terminals

WCDMA, Middle channel, 1880 MHz, 1 GHz to 20 GHz

* Agilent 16:09:37 Mar 4, 2008

L

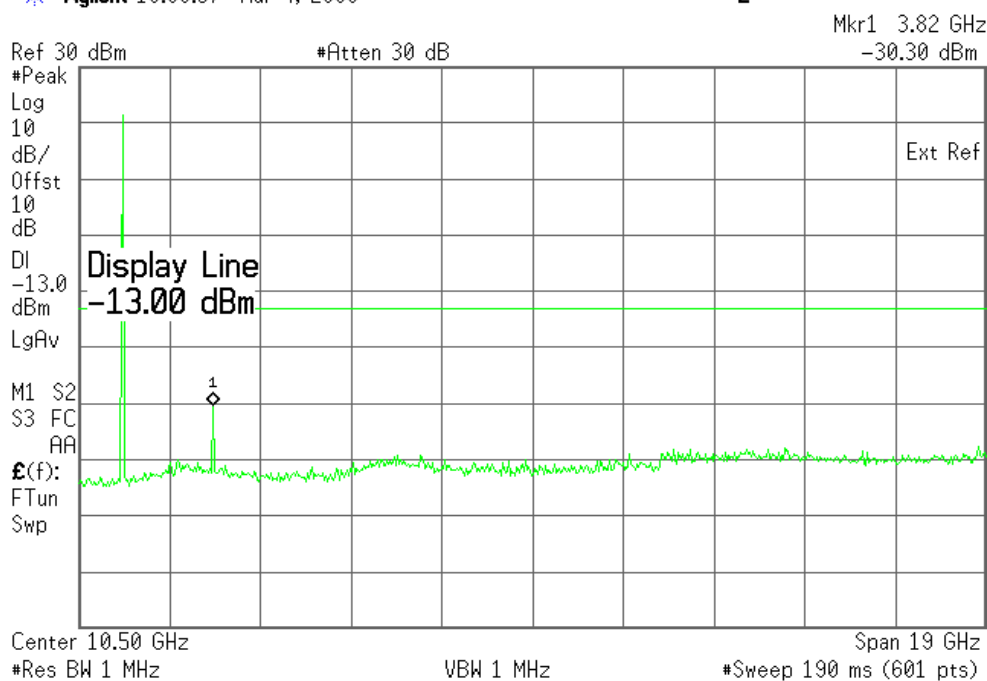

The strong emission shown is the carrier signal.

PCS Harmonics for Ch. 9400 (1880.0 MHz)	Level (dBm)
Second	- 30.30 dBm
Third	--
All others	< -35 dBm up to 20GHz

SIERRA WIRELESS, INC.

Plot 6.4.43) Out of Band Emissions at Antenna Terminals
WCDMA, High channel, 1907.6 MHz, 1 MHz to 1 GHz

Agilent 16:02:40 Mar 4, 2008

L

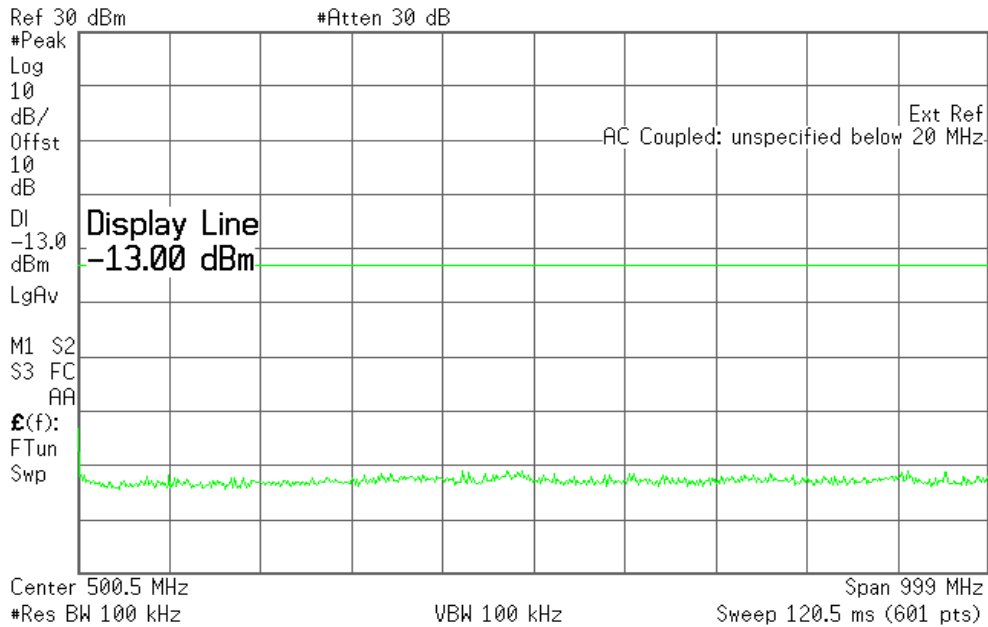

Plot 6.4.44) Out of Band Emissions at Antenna Terminals
WCDMA, High channel, 1907.6 MHz, TX signal +/- 20 MHz

Agilent 16:07:21 Mar 4, 2008

L

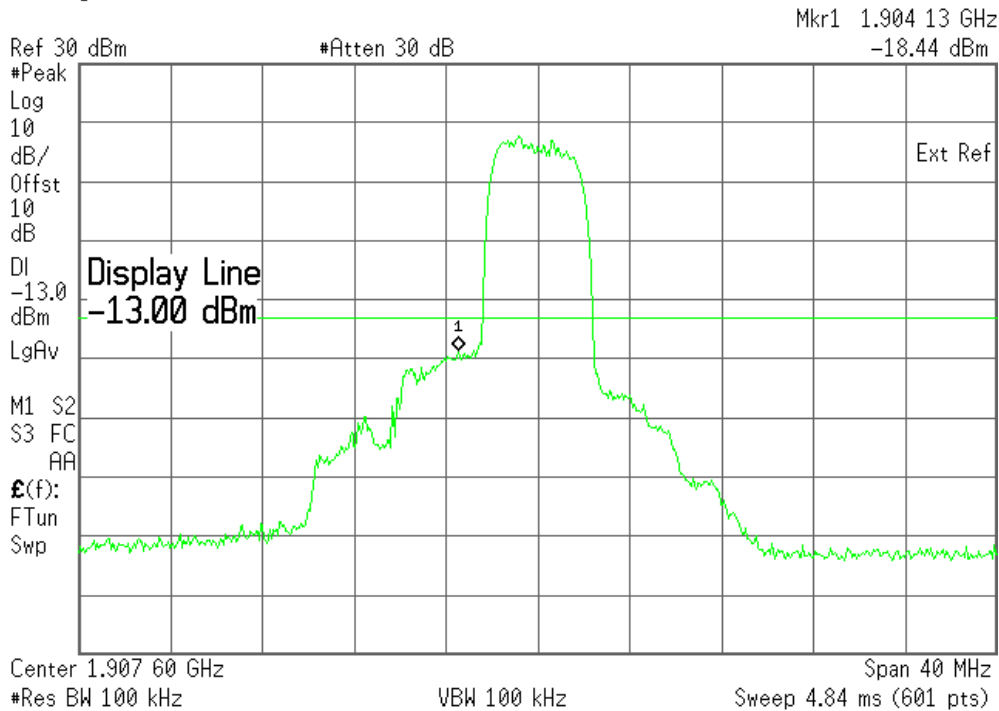

© 2008 Sierra Wireless, Inc.

The contents of this page are subject to the confidentiality information on page one.

SIERRA WIRELESS, INC.

Plot 6.4.45) Out of Band Emissions at Antenna Terminals

WCDMA, High channel, 1907.6 MHz, 1 GHz to 20 GHz

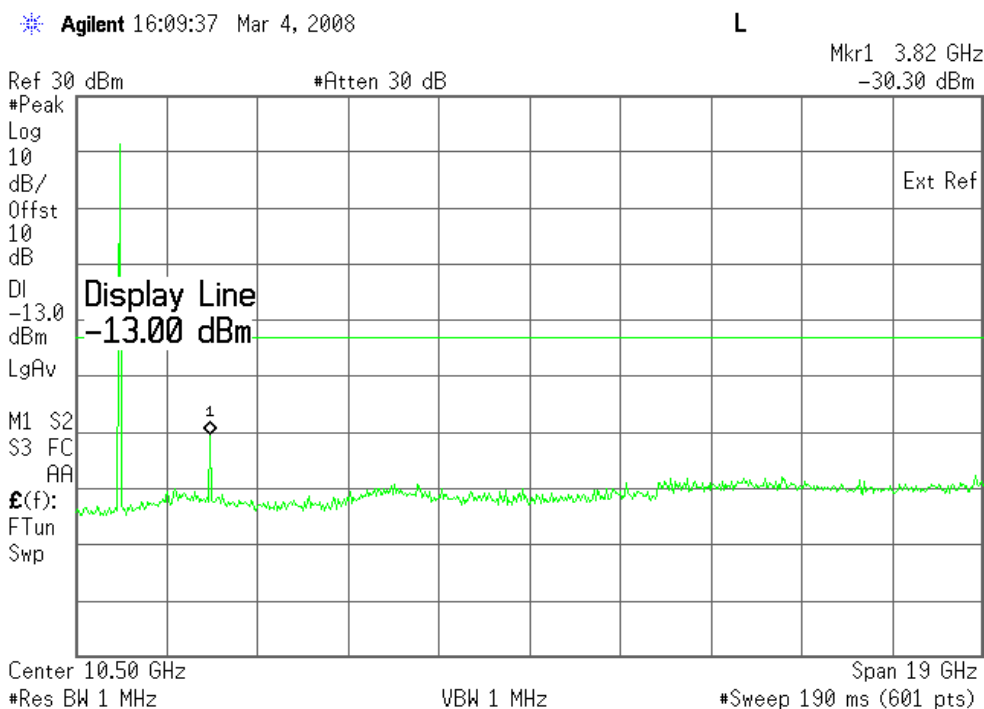

The strong emission shown is the carrier signal.

PCS Harmonics for Ch. 9538 (1907.6 MHz)	Level (dBm)
Second	- 30.30 dBm
Third	--
All others	< -35 dBm up to 20GHz

SIERRA WIRELESS, INC.

7 Block Edge Compliance

FCC Part 22H/24E

7.1 Test Procedure

The transmitter output was connected to a Rohde & Schwarz CMU200 Test Set and configured to operate at maximum power. The block edge emissions were measured at the required operating frequencies in each band on the Spectrum Analyzer.

Test Setup

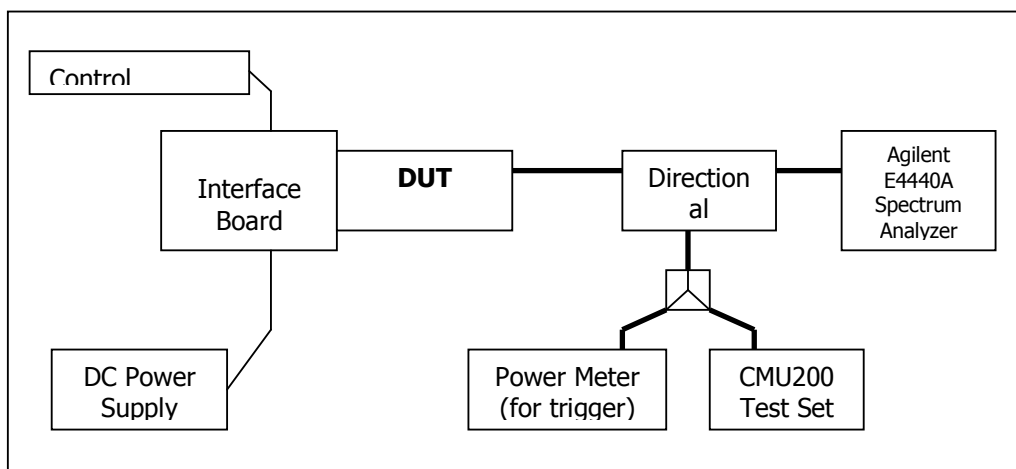

7.2 Test Equipment

Instrument List

EQUIPMENT	MANUFACTURER	MODEL NO.	SERIAL NO.	CAL. DATE
Control Computer	TC	Generic PC	100488	N/A
Wireless Test Set	Rohde & Schwarz	CMU200	111682	November 18, 2008
Spectrum Analyzer	Agilent	PSA E4440A	US41421268	March 11, 2008
DC Power Supply	HP	6632A	3530A	N/A
Interface Board	Shop built	Minnow	N/A	N/A
Directional Coupler	Mini-Circuits	ZA3PD-2	N/A	N/A

7.3 Test Results

Block Test	Frequency Boundaries (MHz)	Channels Tested	Corresponding Plots	Result
1	GMSK: Below 824 MHz, above 849 MHz	128, 251	7.4.1, 7.4.2	Complies
2	8PSK: Below 824 MHz, above 849 MHz	128, 251	7.4.3, 7.4.4	Complies
3	GMSK: Below 1850MHz, above 1910MHz	512, 810	7.4.5, 7.4.6	Complies
4	8PSK: Below 1850MHz, above 1910MHz	512, 810	7.4.7, 7.4.8	Complies
5	WCDMA: Below 1850MHz, above 1910MHz	9262, 9538	7.4.9, 7.4.10	Complies

© 2008 Sierra Wireless, Inc.

The contents of this page are subject to the confidentiality information on page one.

SIERRA WIRELESS, INC.

7.4 Test Plots

Plot 7.4.1) GSMK; Cellular low channel, below 824 MHz

Agilent 16:43:13 Mar 4, 2008

L

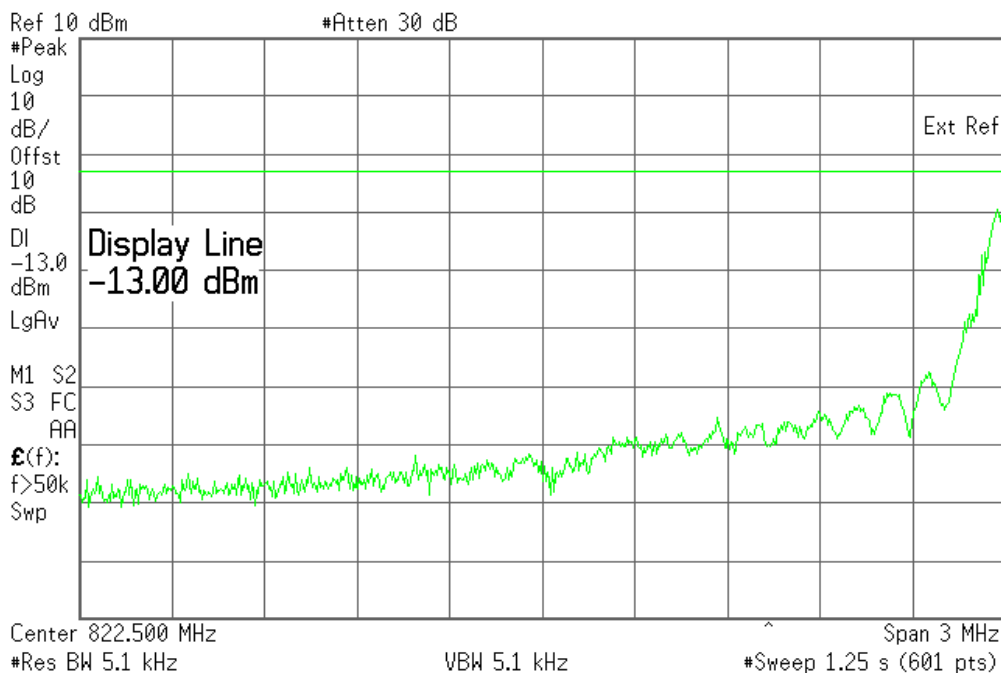

Plot 7.4.2) GSMK; Cellular high channel, above 849 MHz

Agilent 16:45:52 Mar 4, 2008

L

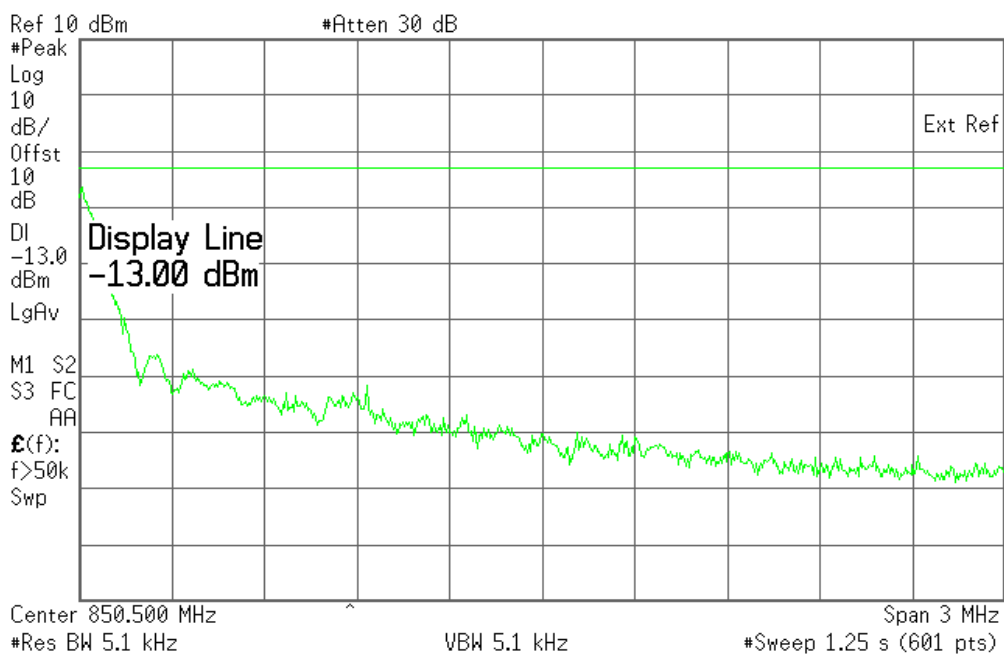

© 2008 Sierra Wireless, Inc.

The contents of this page are subject to the confidentiality information on page one.

SIERRA WIRELESS, INC.

Plot 7.4.3) 8-PSK; Cellular low channel, below 824 MHz

Agilent 16:47:38 Mar 4, 2008 L

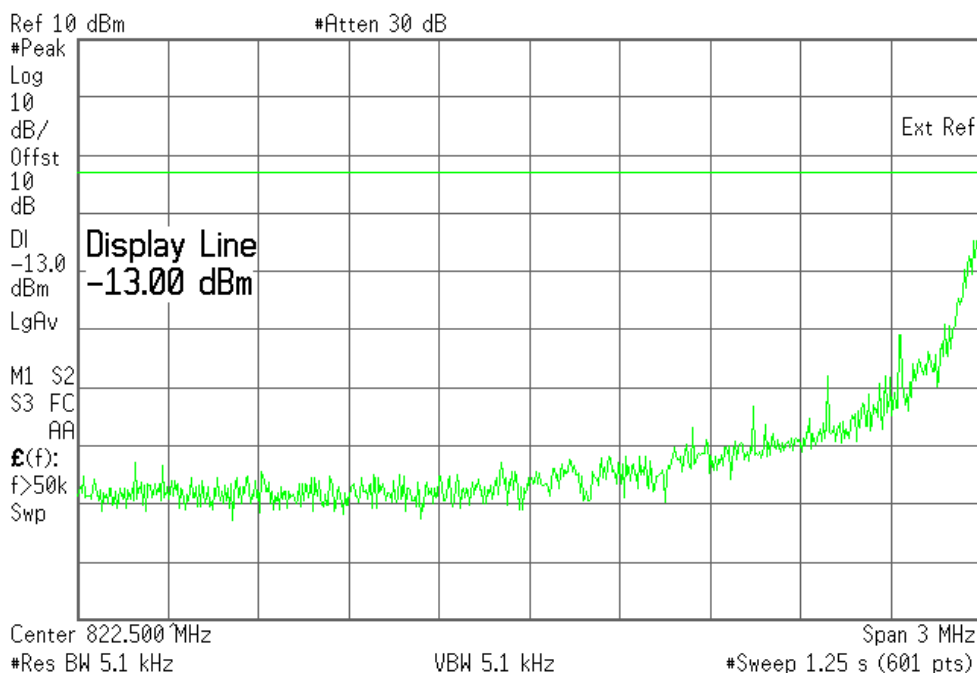

Plot 7.4.4) 8-PSK; Cellular high channel, above 849 MHz

Agilent 16:50:12 Mar 4, 2008 L

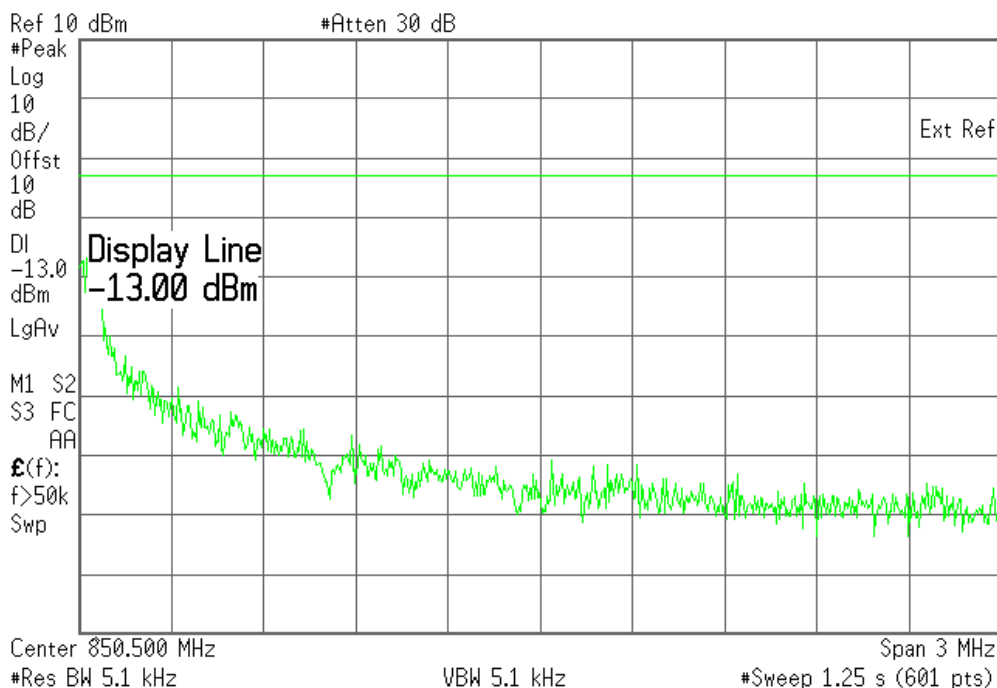

© 2008 Sierra Wireless, Inc.

The contents of this page are subject to the confidentiality information on page one.

SIERRA WIRELESS, INC.

Plot 7.4.5) GMSK; PCS low channel, below 1850 MHz

Agilent 16:52:31 Mar 4, 2008 L

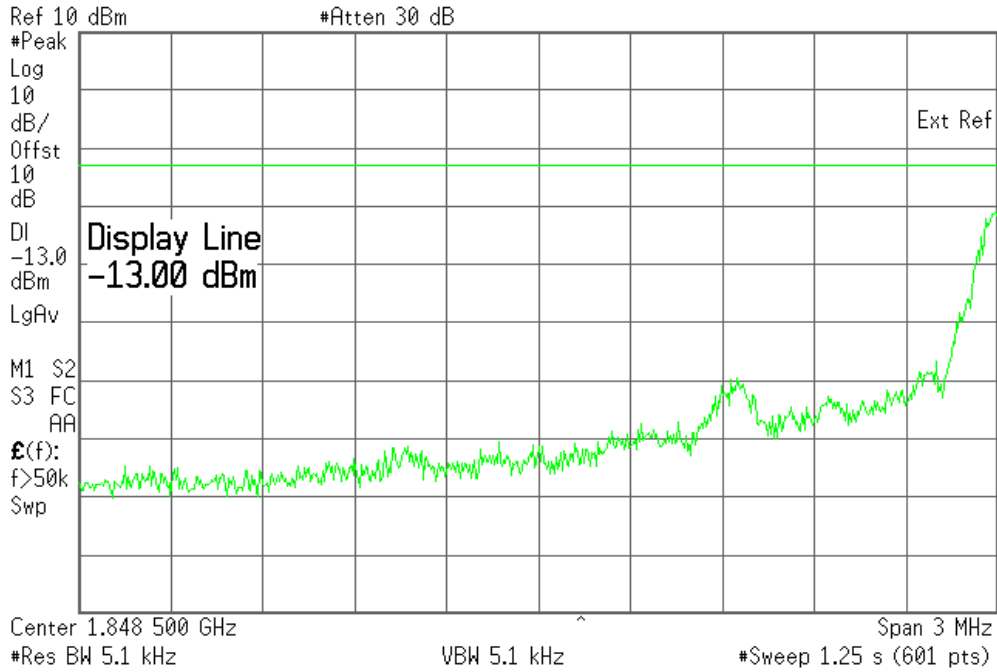

Plot 7.4.6) GMSK; PCS high channel, above 1910 MHz

Agilent 16:54:32 Mar 4, 2008 L

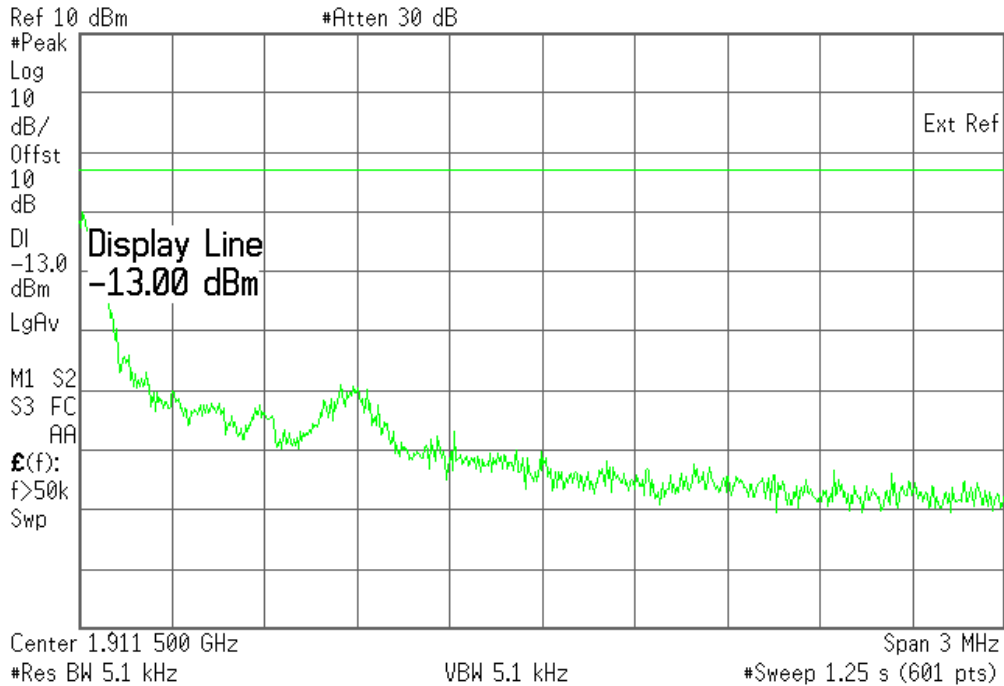

© 2008 Sierra Wireless, Inc.

The contents of this page are subject to the confidentiality information on page one.

SIERRA WIRELESS, INC.

Plot 7.4.7) 8-PSK; PCS low channel, below 1850 MHz

Agilent 16:56:24 Mar 4, 2008

L

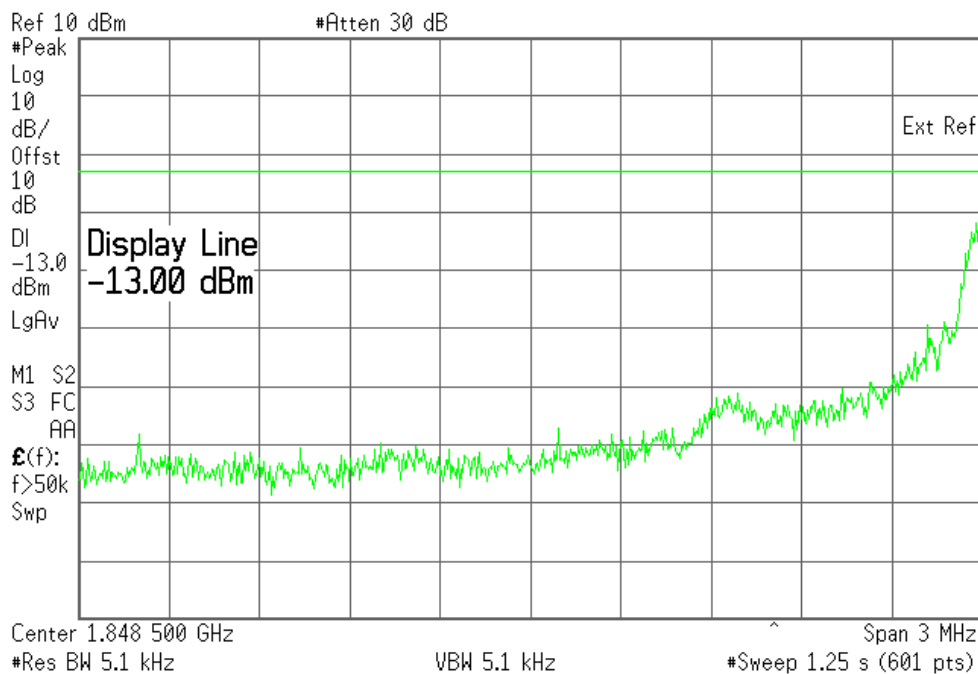

Plot 7.4.8) 8-PSK; PCS high channel, above 1910 MHz

Agilent 16:58:02 Mar 4, 2008

L

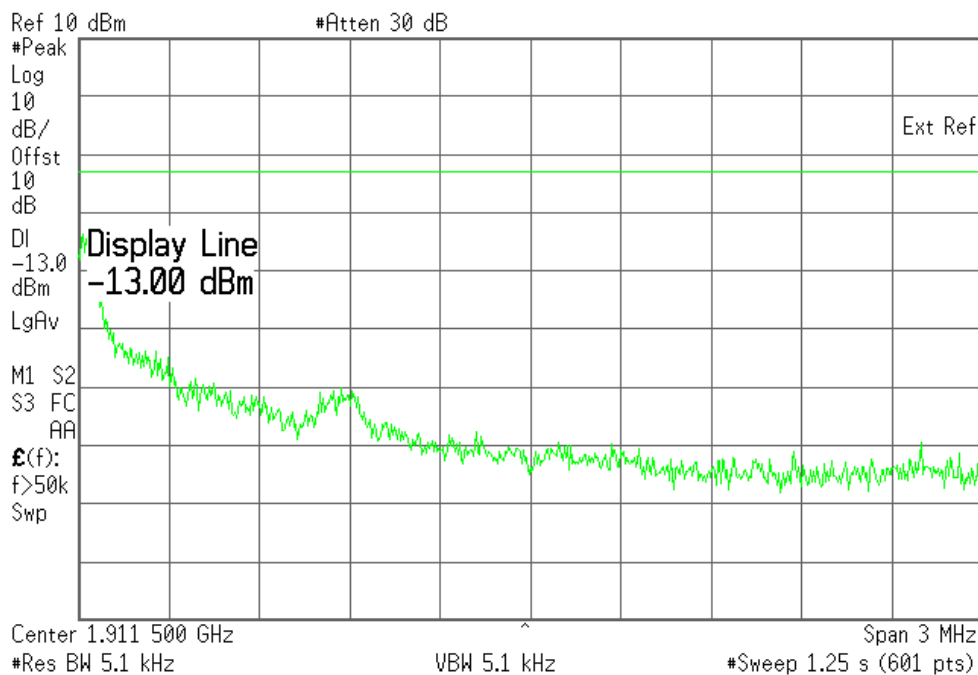

© 2008 Sierra Wireless, Inc.

The contents of this page are subject to the confidentiality information on page one.

SIERRA WIRELESS, INC.

Plot 7.4.9) WCDMA; PCS low channel, below 1850 MHz

Agilent 17:11:39 Mar 4, 2008

L

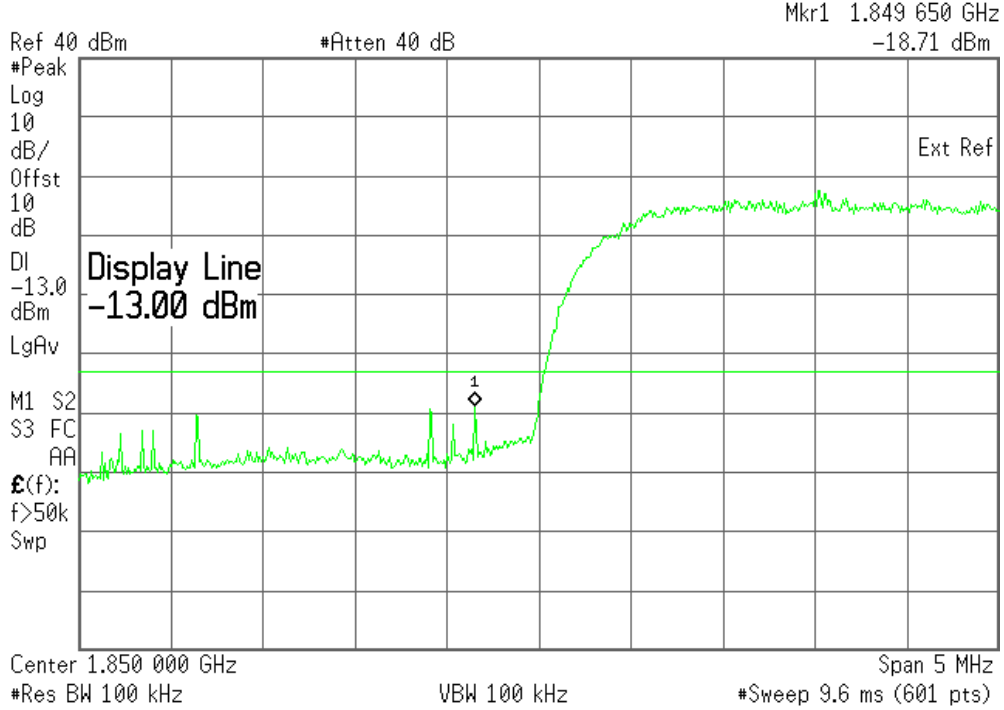

Plot 7.4.10) WCDMA; PCS high channel, above 1910 MHz

Agilent 17:14:08 Mar 4, 2008

L

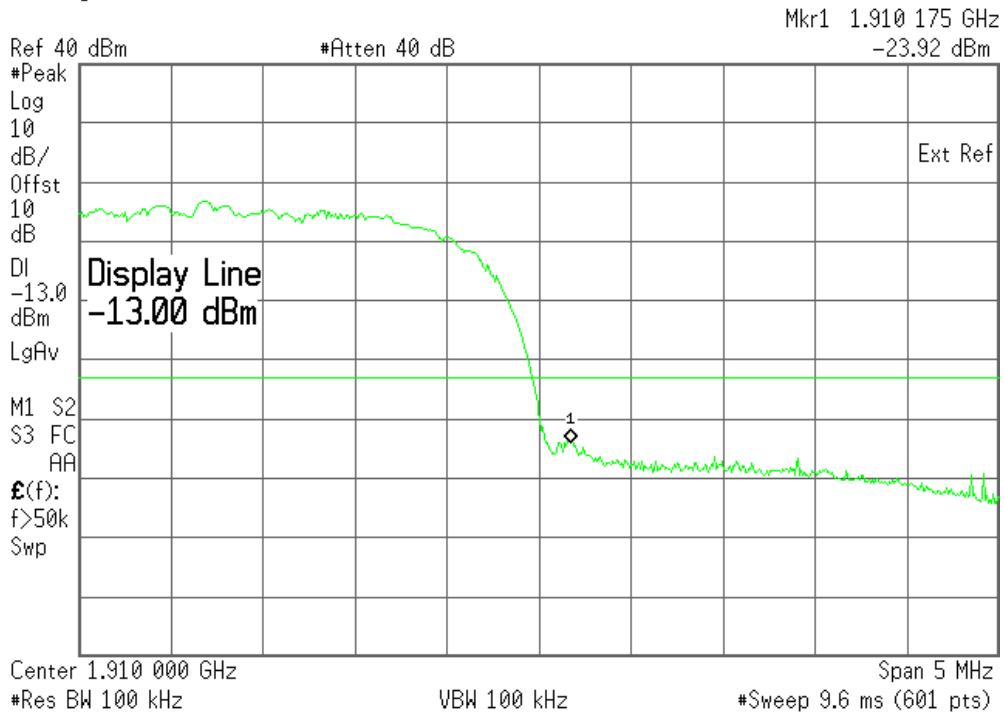

© 2008 Sierra Wireless, Inc.

The contents of this page are subject to the confidentiality information on page one.

SIERRA WIRELESS, INC.

8 Frequency Stability Versus Temperature

FCC 2.1055, FCC 22.355, FCC 24.235

8.1 Summary of Results

The EUT Frequency Stability versus temperature meets the requirements of less than 2.5ppm when temperature varies from -30°C to +50°C.

8.2 Test Procedure

The EUT was placed inside a temperature chamber. The temperature is set to -30°C and allowed to stabilize. After sufficient soak time, the transmitting frequency error is measured. The temperature is increased by 10 degrees, allowed to stabilize and soak, and then the measurement is repeated. This is repeated until +50°C is reached. Frequency metering included internal averaging of the CMU200 to stabilize the reading. Reference power supply voltage for these tests is 3.3 volts.

Test Setup

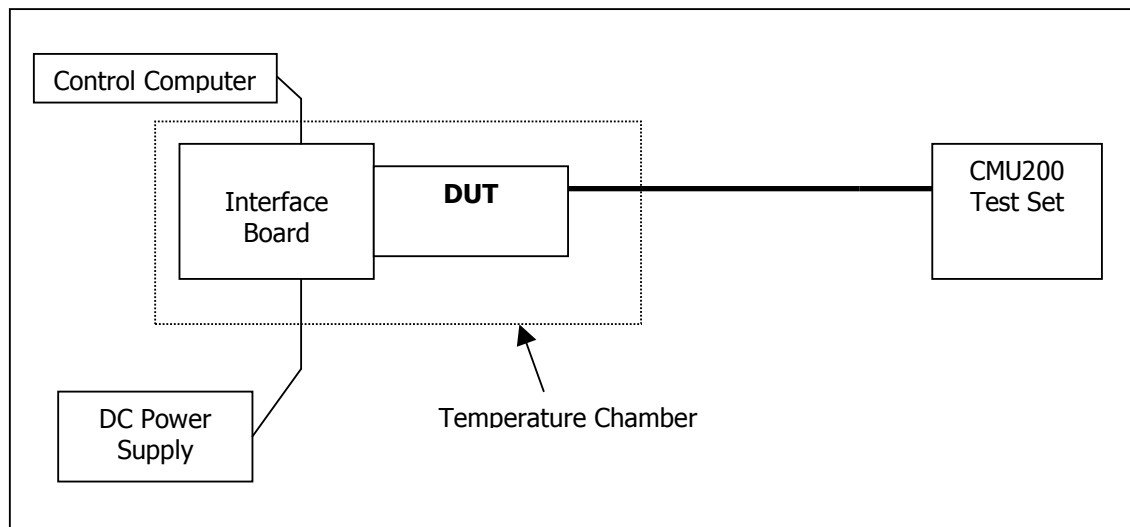

8.3 Test Equipment

EQUIPMENT	MANUFACTURER	MODEL NO.	SERIAL NO.	CAL. DATE
Control Computer	TC	Generic PC	100488	N/A
Wireless Test Set	Rohde & Schwarz	CMU200	111682	November 18, 2008
Spectrum Analyzer	Agilent	PSA E4440A	US41421268	March 11, 2008
DC Power Supply	HP	6632A	3530A	N/A
Interface Board	Shop built	Minnow	N/A	N/A
Directional Coupler	Mini-Circuits	ZA3PD-2	N/A	N/A

© 2008 Sierra Wireless, Inc.

The contents of this page are subject to the confidentiality information on page one.

SIERRA WIRELESS, INC.

8.4 Test Results

Frequency Error Over Temperature

Temp (°C)	Cellular Band: 824MHz to 848MHz		PCS Band: 1850MHz to 1910MHz	
	Offset (Hz)	Offset (ppm)	Offset (Hz)	Offset (ppm)
-30	-44	-0.0534	-56	-0.0305
-20	-46	-0.0559	-69	-0.0374
-10	-42	-0.0508	-73	-0.0396
0	-38	-0.0462	-70	-0.0379
10	-31	-0.0370	-66	-0.0358
20	-34	-0.0416	-53	-0.0288
30	-26	-0.0319	-57	-0.0306
40	-31	-0.0379	-64	-0.0347
50	-34	-0.0418	-58	-0.0312

9 Frequency Stability Versus Voltage

FCC 2.1055, FCC 22.355, FCC 24.235

9.1 Summary of Results

The EUT is specified to operate with a supply voltage of between 2.9 VDC and 3.6 VDC with a nominal voltage of 3.3 VDC. It meets the frequency stability limit of less than 0.1ppm when supply voltage varies within the specified limits. Operation is prohibited by firmware while the DC supply voltage is out of the specified range.

9.2 Test Procedure

The MC8792V was connected to a DC Power Supply and a UMTS test set (CMU 200) with frequency error measurement capability. The power supply output is adjusted to the test voltage as measured at the input terminals to the module while transmitting. A voltmeter was used to confirm the terminal voltage. The peak frequency error is recorded (worst case). The test voltages are 2.9 volts to 3.6 volts.

SIERRA WIRELESS, INC.

Test Setup

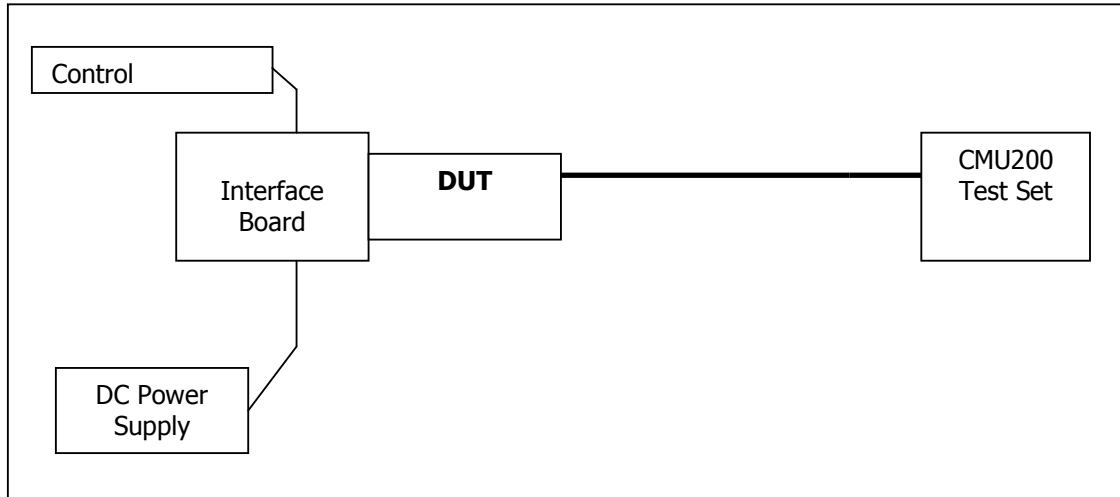

9.3 Test Equipment

EQUIPMENT	MANUFACTURER	MODEL NO.	SERIAL NO.	CAL. DATE
Control Computer	TC	Generic PC	100488	N/A
Wireless Test Set	Rohde & Schwarz	CMU200	111682	November 18, 2008
Spectrum Analyzer	Agilent	PSA E4440A	US41421268	March 11, 2008
DC Power Supply	HP	6632A	3530A	N/A
Interface Board	Shop built	Minnow	N/A	N/A
Directional Coupler	Mini-Circuits	ZA3PD-2	N/A	N/A

9.4 Test Results

Frequency Error Over Voltage

Voltage (V)	Cellular Band: 824MHz to 848MHz		PCS Band: 1850MHz to 1910MHz	
	Offset (Hz)	Offset (ppm)	Offset (Hz)	Offset (ppm)
2.9	-34	-0.0406	-39	-0.0207
3.3	-33	-0.0394	-55	-0.0293
3.6	-28	-0.0454	-45	-0.0239

© 2008 Sierra Wireless, Inc.

The contents of this page are subject to the confidentiality information on page one.