

SAR Test Report

of

Product Name & Model

AR5BXB6 802.11a/b/g PCI Express Module

Applied by:

Atheros Communications, Inc.
5480 Great America Parkway
Santa Clara, CA 95054
USA

Test Performed by:

International Standards Laboratory
No. 120, Lane 180, San Ho Tsuen, Hsin Ho Rd.
Lung-Tan Hsiang, Tao Yuan County 325
Taiwan, R.O.C.
Tel:(03)407-1718 Fax:(03)407-1738

Report Number: 06LR024SAR-F

Issue Date: 2006/10/13

HC LAB: NVLAP:200234-0;VCCI: R-341,C-354; NEMKO:ELA 113A;BSMI:SL2-IN-E-0037;SL2-RI-E-0037;CNLA:1178; IC:IC4067
LT LAB: NVLAP:200234-0;VCCI: R-1435,C-1440;NEMKO:ELA 113B; BSMI:SL2-IN-E-0013;CNLA:0997; IC:IC4164-1
ISL-T10-R31-1

Contents of Report

1. General.....	1
1.1 Certification of Accuracy of Test Data.....	1
2. Description of Equipment Under Test (EUT).....	2
2.1 Test Environment (Ambient conditions in the laboratory)	2
3. SAR Measurement System.....	3
3.1 ALSAS-10U System Description.....	3
3.1.1 Applications	3
3.1.2 Area Scans.....	3
3.1.3 Zoom Scan (Cube Scan Averaging).....	4
3.1.4 ALSAS-10U Interpolation and Extrapolation Uncertainty.....	4
3.2 Isotropic E-Field Probe	4
3.2.1 Isotropic E-Field Probe Specification.....	6
3.3 Boundary Detection Unit and Probe Mounting Device.....	6
3.4 Daq-Paq (Analog to Digital Electronics).....	7
3.5 Axis Articulated Robot	7
3.6 ALSAS Universal Workstation.....	8
3.7 Universal Device Positioner.....	8
3.8 Phantom Types.....	8
3.8.1 APREL Laboratories Universal Phantom.....	9
4. Tissue Simulating Liquid.....	10
4.1 The composition of the tissue simulating liquid	10
4.2 Tissue Calibration Result.....	11
4.3 Tissue Dielectric Parameters for Head and Body Phantoms	13
5. SAR Measurement Procedure	14
5.1 SAR System Validation.....	14
5.1.1 Validation Dipoles	14
5.1.2 Validation Result.....	14
5.2 SAR Measurement Procedure.....	16
6. SAR Exposure Limits	17
7. Test Equipment List.....	18
8. Measurement Uncertainty.....	19
9. Test Result Summary.....	20
9.1 EUT Test Position : Laptop	20
9.2 EUT Test Position: Tablet Mode	20
9.3 EUT Test Position: Notebook PC Mode.....	21
9.4 WLAN +Bluetooth SAR measurement Data.....	22
10. SAR System Validation Data.....	23
10.1 2450 MHz System Validation Data	23
10.2 5200 MHz System Validation Data	26
10.3 5800 MHz System Validation Data	29
11. WLAN + Bluetooth SAR measurement Data.....	32
11.1 802.11b mode.....	35
11.1.1 2437 MHz, EUT Position: Tablet,PL, Main Antenna	35
11.1.2 2437 MHz, EUT Position: Tablet,PP, Aux Antenna	36
11.1.3 2437 MHz, EUT Position: Tablet,SL, Main Antenna	37
11.1.4 2437 MHz, EUT Position: Tablet,SP, Main Antenna.....	38
11.1.5 2437 MHz, EUT Position: Laptop, Main Antenna	39

11.1.6	2437 MHz, EUT Position: Laptop,Aux Antenna	40
11.1.7	Z Axis 2437 MHz, EUT Position: Tablet,PP, Aux Antenna	41
11.2	802.11g mode.....	42
11.2.1	2437 MHz, EUT Position: Tablet,PL, Main Antenna	42
11.2.2	2437 MHz, EUT Position: Tablet,PP, Aux Antenna	43
11.2.3	2437 MHz, EUT Position: Tablet,SL, Main Antenna	44
11.2.4	2437 MHz, EUT Position: Tablet,SP, Aux Antenna	45
11.2.5	2437 MHz, EUT Position: Laptop, Main.....	46
11.2.6	2437 MHz, EUT Position: Laptop, Aux Antenna	47
11.2.7	Z Axis 2437 MHz, EUT Position: Tablet,PP, Aux Antenna	48
11.3	802.11a mode (5150MHz ~ 5350MHz).....	49
11.3.1	5260 MHz, EUT Position: Tablet,PL, Main Antenna	49
11.3.2	5260 MHz, EUT Position: Tablet,PP, Aux Antenna	50
11.3.3	5260 MHz, EUT Position: Tablet,SL, Main Antenna	51
11.3.4	5260 MHz, EUT Position: Tablet,SP, Aux Antenna	52
11.3.5	5260 MHz, EUT Position: Laptop, Main Antenna	53
11.3.6	5260 MHz, EUT Position: Laptop, Aux Antenna	54
11.3.7	Z Axis 5260 MHz, EUT Position: Laptop, Main Antenna	55
11.4	802.11a mode (5725MHz ~ 5850MHz) Antenna	56
11.4.1	5785 MHz, EUT Position: Tablet,PL, Main	56
11.4.2	5785 MHz, EUT Position: Tablet,PP, Aux Antenna	57
11.4.3	5785 MHz, EUT Position: Tablet,SL, Main Antenna	58
11.4.4	5785 MHz, EUT Position: Tablet,SP, Aux Antenna	59
11.4.5	5785 MHz, EUT Position: Laptop, Main Antenna	60
11.4.6	5785 MHz, EUT Position: Laptop, Aux Antenna	61
11.4.7	Z-Axis 5785MHz, EUT Position: Laptop, Main Antenna	62
12	Setup Photographs	63
13	EUT Photographs	66
14	Appendix: Probe and Validation Dipole calibration.....	77
14.1	Probe: Refer to Probe_Cal.Pdf attached.	77
14.2	Dipole: Refer to Dipole_Cal.pdf attached.	77

1. General

1.1 Certification of Accuracy of Test Data

Standards:	FCC OET65 Supplement C June 2001
Equipment Tested:	802.11a/b/g PCI module
Product Name & Model:	AR5BXB6 802.11a/b/g PCI Express Module
FCC ID	PPD-AR5BXB6
	Brand Name: Lenovo
	Model Name: 6363/ 6364/ 6365/ 6366/ 6367/ 6368
Built-In Tablet PC	Project Name: ThinkPad X60 Tablet Series
	Sierra, Wireless Karafuto (GSM, EGSM, UMTS) :
RF Module A	FCCID N7NMC8765
RF Module B	Sierra Wireless Akita (GSM, EGSM) : FCCID N7NMC8755
RF Module C	Sierra Wireless Tosa (EV-DO) : FCCID N7N- MC5720
RF Module D	Bluetooth, Foxconn Callisto, FCCID MCLJ07H081
Applied by:	Atheros Communications, Inc.
Sample received Date:	2006/08/24
Final test Date :	2006/08/25 ~ 2006/09/05
Test Site:	SAR test site
Test Result	WLAN:
Maximum SAR	802.11b: 0.203W/kg, 802.11g: 0.118W/kg
Measurement (1g)	802.11a: 0.185 W/kg
Temperature	22.2 ~ 22.8 °C
Humidity:	45% ~ 55%
Test Engineer:	Frank Hsu

All the tests in this report have been performed and recorded in accordance with the standards described above and performed by an independent test lab, International Standards Laboratory. The test results contained in this report accurately represent the measurements of the characteristics and the energy generated by sample equipment under test at the time of the test. The sample equipment tested as described in this report is in compliance with the limits of above standards.

Approve & Signature



Jammy Chen/Senior Director

Test results given in this report apply only to the specific sample(s) tested under stated test conditions. This report shall not be reproduced other than in full without the explicit written consent of ISL. This report totally contains 80 pages, including 1 cover page, 2 contents page, and 77 pages for the test description. This report must not be used to claim product endorsement by NVLAP, NIST, any agency of the federal government.

2. Description of Equipment Under Test (EUT)

Product Name & Model No.	AR5BxB6 802.11a/b/g PCI Express Module
TX Frequency	2412MHz ~ 2462MHz (802.11b & 802.11g) 5150 MHz ~ 5350 MHz (802.11a) 5725 MHz ~ 5850MHz (802.11a)
Number of Channel	802.11b: 11, 802.11g: 11 802.11a: 10 (5150MHz ~ 5350MHz) 802.11a: 7 (5725MHz ~ 5850MHz)
Type of Modulation	802.11b: DBPSK, DQPSK, CCK 802.11g and 802.11a: OFDM
Max. Output Power (Conducted)	802.11b: 20.1dBm, 802.11g: 22.7dBm 802.11a: 16.0dBm (5150MHz~5350MHz) 802.11a: 21.3dBm (5725MHz~5850MHz)
Built-In Tablet PC	Brand Name: Lenovo Model Name: 6363/ 6364/ 6365/ 6366/ 6367/ 6368 Project Name: ThinkPad X60 Tablet Series
RF Module A	Sierra, Wireless Karafuto (GSM, EGSM, UMTS) : FCCID N7NMC8765
RF Module B	Sierra Wireless Akita (GSM, EGSM) : FCCID N7NMC8755
RF Module C	Sierra Wireless Tosa (EV-DO) : FCCID N7N-MC5720
RF Module D	Bluetooth, Foxconn Callisto, FCCID MCLJ07H081
Transmit Antenna Peak Gain	Main Antenna of WLAN: 2.4GHz : 0.9dBi, 5GHz: 1.92dBi Aux Antenna WLAN: 2.4GHz: 1.52dBi, 5GHz: 2.78dBi, Main Antenna of WWAN (Karafuto and TOSA): 850MHz : 1.76dBi, 1900MHz: 1.30dBi Main Antenna of WWAN (Akita): 850MHz : 1.74dBi, 1900MHz: 1.78dBi
Antenna Type	Internal, Dual Band Printed IFA
Transfer Rate	802.11b: 1~11Mbps 802.11g: 6~108Mbps 802.11a: 6~108Mbps
Power Type	5V DC from Notebook PC
Device Category	Portable
RF Exposure Environment	Uncontrolled

Note: WLAN and WWAN can not transmit at the same time.

2.1 Test Environment (Ambient conditions in the laboratory)

Items	Required	Actual
Temperature (°C)	18 ~ 25	22.2 ~ 22.8 (8/25/2006 ~ 9/05/2006)
Humidity (%RH)	30 ~ 70	45 ~ 55 (8/25/2006 ~ 9/05/2006)

3. SAR Measurement System

3.1 ALSAS-10U System Description

ALSAS-10-U is fully compliant with the technical and scientific requirements of IEEE 1528, IEC 62209, CENELEC, ARIB, ACA, and the Federal Communications Commission. The system comprises of a six axes articulated robot which utilizes a dedicated controller.

ALSAS-10U uses the latest methodologies and FDTD modeling to provide a platform which is repeatable with minimum uncertainty.

3.1.1 Applications

Predefined measurement procedures compliant with the guidelines of CENELEC, IEEE, IEC, FCC, etc are utilized during the assessment for the device. Automatic detection for all SAR maxima are embedded within the core architecture for the system, ensuring that peak locations used for centering the zoom scan are within a 1mm resolution and a 0.05mm repeatable position. System operation range currently available up-to 6 GHz in simulated tissue.



3.1.2 Area Scans

Area scans are defined prior to the measurement process being executed with a user defined variable spacing between each measurement point (integral) allowing low uncertainty measurements to be conducted. Scans defined for FCC applications utilize a 10mm² step integral, with 1mm interpolation used to locate the peak SAR area used for zoom scan assessments.

Where the system identifies multiple SAR peaks (which are within 25% of peak value) the system will provide the user with the option of assessing each peak location individually for zoom scan averaging.

3.1.3 Zoom Scan (Cube Scan Averaging)

The averaging zoom scan volume utilized in the ALSAS-10U software is in the shape of a cube and the side dimension of a 1 g or 10 g mass is dependent on the density of the liquid representing the simulated tissue. A density of 1000 kg/m³ is used to represent the head and body tissue density and not the phantom liquid density, in order to be consistent with the definition of the liquid dielectric properties, i.e. the side length of the 1 g cube is 10mm, with the side length of the 10 g cube 21,5mm.

When the cube intersects with the surface of the phantom, it is oriented so that 3 vertices touch the surface of the shell or the center of a face is tangent to the surface. The face of the cube closest to the surface is modified in order to conform to the tangent surface.

The zoom scan integer steps can be user defined so as to reduce uncertainty, but normal practice for typical test applications (including FCC) utilize a physical step of 5x5x8 (8mmx8mmx5mm) providing a volume of 32mm in the X & Y axis, and 35mm in the Z axis.

3.1.4 ALSAS-10U Interpolation and Extrapolation Uncertainty

The overall uncertainty for the methodology and algorithms the used during the SAR calculation was evaluated using the data from IEEE 1528 based on the example f3 algorithm:

$$f_3(x, y, z) = A \frac{a^2}{\frac{a^2}{4} + x'^2 + y'^2} \cdot \left(e^{-\frac{2z}{a}} + \frac{a^2}{2(a + 2z)^2} \right)$$

3.2 Isotropic E-Field Probe

The isotropic E-Field probe has been fully calibrated and assessed for isotropicity, and boundary effect within a controlled environment. Depending on the frequency for which the probe is calibrated the method utilized for calibration will change. A number of methods is used for calibrating probes, and these are outlined in the table below:

Calibration Frequency	Air Calibration	Tissue Calibration
2450MHz	Waveguide	Temperature
5200MHz	Waveguide	Temperature
5800MHz	Waveguide	Temperature

The E-Field probe utilizes a triangular sensor arrangement as detailed in the diagram below:

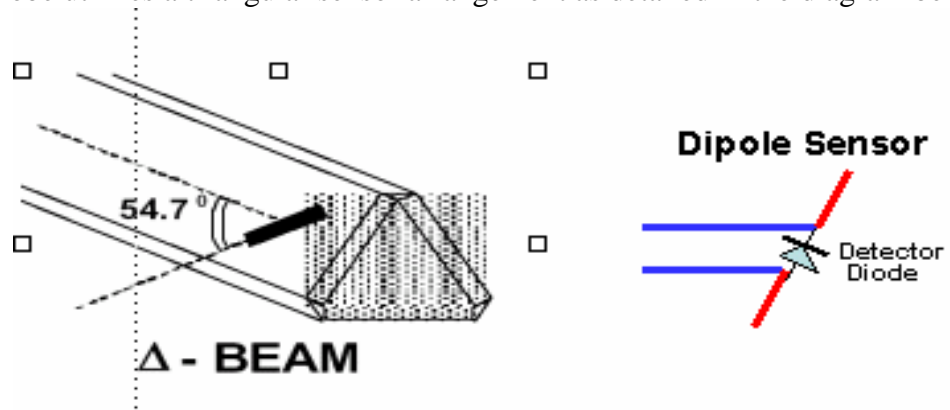

SAR is assessed with a calibrated probe which moves at a default height of 5mm from the center of the diode, which is mounted to the sensor, to the phantom surface (in the Z Axis). The 5mm offset height has been selected so as to minimize any resultant boundary effect due to the probe being in close proximity to the phantom surface.

The following algorithm is an example of the function used by the system for linearization of the output from the probe when measuring complex modulation schemes.

$$V_i = U_i + U_i^2 \cdot \frac{cf}{dcp_i}$$

3.2.1 Isotropic E-Field Probe Specification

Calibration in Air	Frequency Dependent Below 2GHz Calibration in air performed in a TEM Cell Above 2GHz Calibration in air performed in waveguide
Sensitivity	0.70 $\mu\text{V}/(\text{V}/\text{m})^2$ to 0.85 $\mu\text{V}/(\text{V}/\text{m})^2$
Dynamic Range	0.0005 W/kg to 100W/kg
Isotropic Response	Better than 0.2dB
Diode Compression point (DCP)	Calibration for Specific Frequency
Probe Tip Radius	< 5mm
Sensor Offset	1.56 (+/- 0.02mm)
Probe Length	290mm
Video Bandwidth	@ 500 Hz: 1dB @ 1.02 KHz: 3dB
Boundary Effect	Less than 2% for distance greater than 2.4mm
Spatial Resolution	Diameter less than 5mm Compliant with Standards

3.3 Boundary Detection Unit and Probe Mounting Device

ALSAS-10U incorporates a boundary detection unit with a sensitivity of 0.05mm for detecting all types of surfaces. The robust design allows for detection during probe tilt (probe normalize) exercises, and utilizes a second stage emergency stop. The signal electronics are fed directly into the robot controller for high accuracy surface detection in lateral and axial detection modes (X, Y, & Z).

The probe is mounted directly onto the Boundary Detection unit for accurate tooling and displacement calculations controlled by the robot kinematics. The probe is connect to an isolated probe interconnect where the output stage of the probe is fed directly into the amplifier stage of the Daq-Paq

3.4 Daq-Paq (Analog to Digital Electronics)

ALSAS-10U incorporates a fully calibrated Daq-Paq (analog to digital conversion system) which has a 4 channel input stage, sent via a 2 stage auto-set amplifier module. The input signal is amplified accordingly so as to offer a dynamic range from 5 μ V to 800mV. Integration of the fields measured is carried out at board level utilizing a Co-Processor which then sends the measured fields down into the main computational module in digitized form via an RS232 communications port. Probe linearity and duty cycle compensation is carried out within the main Daq-Paq module.

ADC	12 Bit
Amplifier Range	20mV to 200mV and 150mV to 800mV
Field Integration	Local Co-Processor utilizing proprietary integration algorithms
Number of Input Channels	4 in total 3 dedicated and 1 spare
Communication	Packet data via RS232

3.5 Axis Articulated Robot



ALSAS-10U utilizes a six axis articulated robot, which is controlled using a Pentium based real-time movement controller. The movement kinematics engine utilizes proprietary (Thermo CRS) interpolation and extrapolation algorithms, which allow full freedom of movement for each of the six joints within the working envelope. Utilization of joint 6 allows for full probe rotation with a tolerance better than 0.05mm around the central axis.

Robot/Controller Manufacturer	Thermo CRS
Number of Axis	Six independently controlled axis
Positioning Repeatability	0.05mm
Controller Type	Single phase Pentium based C500C
Robot Reach	710mm
Communication	RS232 and LAN compatible

3.6 ALSAS Universal Workstation

ALSAS Universal workstation allows for repeatability and fast adaptability. It allows users to do calibration, testing and measurements using different types of phantoms with one set up, which significantly speeds up the measurement process.

3.7 Universal Device Positioner

The universal device positioner allow complete freedom of movement of the EUT. Developed to hold a EUT in a free-space scenario any additional loading attributable to the material used in the construction of the positioner has been eliminated. Repeatability has been enhanced through the linear scales which form the design used to indicate positioning for any given test scenario in all major axes. A 15° tilt indicator is included for the of aid cheek to tilt movements for head SAR analysis. Overall uncertainty for measurements have been reduced due to the design of the Universal device positioner, which allows positioning of a device in as near to a free-space scenario as possible, and by providing the means for complete repeatability.



3.8 Phantom Types

The ALSAS-10U allows the integration of multiple phantom types. SAM Phantoms fully compliant with IEEE 1528, Universal Phantom, and Universal Flat.

APREL SAM Phantoms

The SAM phantoms developed using the IEEE SAM CAD file. They are fully compliant with the requirements for both IEEE 1528 and FCC Supplement C. Both the left and right SAM phantoms are interchangeable, transparent and include the IEEE 1528 grid with visible NF and MB lines.

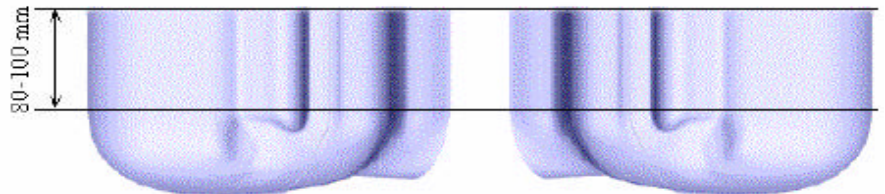

3.8.1 APREL Laboratories Universal Phantom

The Universal Phantom is used on the ALSAS-10U as a system validation phantom. The Universal Phantom has been fully validated both experimentally from 800MHz to 6GHz and numerically using XFDTD numerical software. The shell thickness is 2mm overall, with a 4mm spacer located at the NF/MB intersection providing an overall thickness of 6mm in line with the requirements of IEEE-1528. The design allows for fast and accurate measurements, of handsets, by allowing the conservative SAR to be evaluated at on frequency for both left and right head experiments in one measurement.

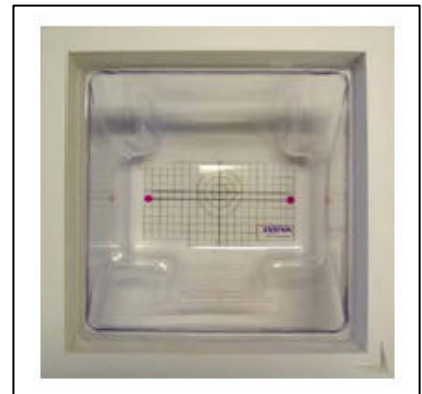

4. Tissue Simulating Liquid

4.1 The composition of the tissue simulating liquid

The SAR liquid is from Aprel Laboratories.

2450 MHz Head Tissue: Part No.: ALS-TS-2450-H,
 2450 MHz Body Tissue Part No. : ALS_TS-2450-B,
 5200 MHz Head Tissue: Part No.: ALS-TS-5200-H,
 5200 MHz Body Tissue Part No. : ALS_TS-5200-B,
 5800 MHz Head Tissue: Part No.: ALS-TS-5800-H,
 5800 MHz Body Tissue Part No. : ALS_TS-5800-B,

The ingredient is as follows:

INGREDIENT (% Weight)	2450MHz -Head	2450MHz -Body		
Water	46.7	73.2		
Salt	0.00	0.04		
Sugar	0.00	0.00		
HEC	0.00	0.00		
Preventol	0.00	0.00		
DGBE	53.3	26.7		
Triton X-100	0.00	0.00		

INGREDIENT (% Weight)	5200MHz Head	5200MHz Body	5800MHz -Head	5800MHz -Body
Water	66.30	76.23	66.30	76.23
Salt	0.00	0.00	0.00	0.00
Sugar	57.60	0.00	57.60	0.00
HEC	0.00	0.00	0.00	0.00
Preventol	0.00	0.00	0.00	0.00
DGBE	5.27	1.83	5.27	1.83
Triton X-100	28.42	21.94	28.42	21.94

Salt: 99+% Pure Sodium Chloride

Sugar: 98+% Pure Sucrose

Water: De-ionized, 16 MW+ resistivity

HEC: Hydroxyethyl Cellulose

DGBE: Diethylene Glycol Monobutyl Ether

Triton X-100 (ultra pure): Polyethylene glycol mono [4-(1,1, 3, 3-tetramethylbutyl)phenyl]ether

4.2 Tissue Calibration Result

The dielectric parameters of the liquids were verified prior to the SAR evaluation using Agilent Dielectric Probe Kit and Agilent E5071B Vector Network Analyzer. The Epsilon and Sigma of tissue was calibrated every day before SAR testing. Parts of calibrated data is listed below.

Head Tissue Simulant Measurement				
Frequency [MHz]	Description	Dielectric Parameters		Tissue Temp. [°C]
		ϵ_r	σ [s/m]	
2450MHz	Reference result ± 5% window	39.2 37.24 to 41.16	1.8 1.71 to 1.89	N/A
	26-Aug-2006	39.94	1.75	22.6

Body Tissue Simulant Measurement				
Frequency [MHz]	Description/ Calibration date	Dielectric Parameters		Tissue Temp. [°C]
		ϵ_r	σ [s/m]	
2450MHz	Reference result ± 5% window	52.7 50.065 to 55.335	1.95 1.8525 to 2.0475	N/A
	26-Aug-2006	51.68	1.98	22.6

Head Tissue Simulant Measurement				
Frequency [MHz]	Description	Dielectric Parameters		Tissue Temp. [°C]
		ϵ_r	σ [s/m]	
5200MHz	Reference result ± 5% window	36.0 34.2 to 37.8	4.7 4.465 to 4.935	N/A
	28-Aug-2006	37.33	4.91	22.2

Body Tissue Simulant Measurement				
Frequency [MHz]	Description/ Calibration date	Dielectric Parameters		Tissue Temp. [°C]
		ϵ_r	σ [s/m]	
5200MHz	Reference result ± 5% window	49.02 46.569 to 51.471	5.299 5.034 to 5.564	N/A
	28-Aug-2006	48.15	5.43	22.2

Head Tissue Simulant Measurement				
Frequency [MHz]	Description	Dielectric Parameters		Tissue Temp. [°C]
		ϵ_r	σ [s/m]	
5800MHz	Reference result ± 5% window	35.3 34.2 to 37.8	5.27 5.006 to 5.533	N/A
	29-Aug-2006	36.47	5.41	22.3

Body Tissue Simulant Measurement				
Frequency [MHz]	Description/ Calibration date	Dielectric Parameters		Tissue Temp. [°C]
		ϵ_r	σ [s/m]	
5800MHz	Reference result ± 5% window	48.2 45.79 to 50.61	6.0 5.7 to 6.3	N/A
	29-Aug-2006	47.13	6.18	22.3

4.3 Tissue Dielectric Parameters for Head and Body Phantoms

The head tissue dielectric parameters recommended by the IEEE SCC-34/SC-2 in P1528 have been incorporated in the following table. These head parameters are derived from planar layer models simulating the highest expected SAR for the dielectric properties and tissue thickness variations in a human head. Other head and body tissue parameters that have not been specified in P1528 are derived from the tissue dielectric parameters computed from the 4-Cole-Cole equations described in Reference [12] and extrapolated according to the head parameters specified in P1528.

Target Frequency (MHz)	Head		Body	
	ϵ_r	σ (S/m)	ϵ_r	σ (S/m)
150	52.3	0.76	61.9	0.80
300	45.3	0.87	58.2	0.92
450	43.5	0.87	56.7	0.94
835	41.5	0.90	55.2	0.97
900	41.5	0.97	55.0	1.05
915	41.5	0.98	55.0	1.06
1450	40.5	1.20	54.0	1.30
1610	40.3	1.29	53.8	1.40
1800 – 2000	40.0	1.40	53.3	1.52
2450	39.2	1.80	52.7	1.95
3000	38.5	2.40	52.0	2.73
5800	35.3	5.27	48.2	6.00

(ϵ_r = relative permittivity, σ = conductivity and $\rho = 1000 \text{ kg/m}^3$)

5. SAR Measurement Procedure

5.1 SAR System Validation

5.1.1 Validation Dipoles

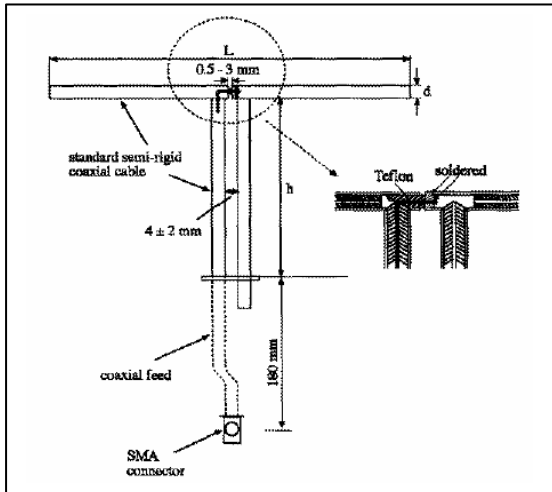

The dipoles used is based on the IEEE-1528 standard, and is complied with mechanical and electrical specifications in line with the requirements of both IEEE and FCC Supplement C. the table below provides details for the mechanical and electrical specifications for the dipoles.

Frequency	L (mm)	h (mm)	d (mm)
2450MHz	53.5	30.4	3.6
5200MHz	23.6	14.0	3.6
5800MHz	21.6	12.6	3.6

5.1.2 Validation Result

System Performance Check at 2450MHz				
Validation Kit: ASL-D-2450-S-2				
Frequency [MHz]	Description	SAR [w/kg] 1g	SAR [w/kg] 10g	Tissue Temp. [°C]
2450 MHz	Reference result ± 10% window	52.4 47.16 to 57.64	24 21.6 to 26.4	N/A
	08/26/2006	55.957	25.595	22.6

Note: All SAR values are 1W forward power.

System Performance Check at 5200MHz				
Validation Kit: ASL-D-5200-S-2				
Frequency [MHz]	Description	SAR [w/kg] 1g	SAR [w/kg] 10g	Tissue Temp. [°C]
5200 MHz	Reference result ± 10% window	62.9 56.61 to 69.19	17.9 16.11 to 19.69	N/A
	08/28/2006	61.924	18.832	22.2
Note: All SAR values are 1W forward power.				

System Performance Check at 5800MHz				
Validation Kit: ASL-D-5800-S-2				
Frequency [MHz]	Description	SAR [w/kg] 1g	SAR [w/kg] 10g	Tissue Temp. [°C]
5800 MHz	Reference result ± 10% window	58.3 52.47 to 64.13	18 16.2 to 19.8	N/A
	08/29/2006	57.717	18.255	22.3
Note: All SAR values are 1W forward power.				

5.2 SAR Measurement Procedure

The ALSAS-10U calculates SAR using the following equation,

$$SAR = \frac{\sigma |E|^2}{\rho}$$

s : represents the simulated tissue conductivity

?: represents the tissue density

The EUT is set to transmit at the required power in line with product specification, at each frequency relating to the LOW, MID, and HIGH channel settings.

Pre-scans are made on the device to establish the location for the transmitting antenna, using a large area scan in either air or tissue simulation fluid.

The EUT is placed against the Universal Phantom where the maximum area scan dimensions are larger than the physical size of the resonating antenna. When the scan size is not large enough to cover the peak SAR distribution, it is modified by either extending the area scan size in both the X and Y directions, or the device is shifted within the predefined area.

The area scan is then run to establish the peak SAR location (interpolated resolution set at 1mm²)which is then used to orient the center of the zoom scan. The zoom scan is then executed and the 1g and 10g averages are derived from the zoom scan volume (interpolated resolution set at 1mm³).

6. SAR Exposure Limits

SAR assessments have been made in line with the requirements of IEEE-1528, FCC Supplement C, and comply with ANSI/IEEE C95.1-1992 “Uncontrolled Environments” limits. These limits apply to a location which is deemed as “Uncontrolled Environment” which can be described as a situation where the general public may be exposed to an RF source with no prior knowledge or control over their exposure.

Limits for General Population/Uncontrolled Exposure (W/kg)

Type Exposure	Uncontrolled Environment Limit
Spatial Peak SAR (1g cube tissue for brain or body)	1.60 W/kg
Spatial Average SAR (whole body)	0.08 W/kg
Spatial Peak SAR (10g for hands, feet, ankles and wrist)	4.00 W/kg

7. Test Equipment List

Instrument	Manufacturer	Model No.	Serial No.	Last Calibration
Vector Network Analyzer	Agilent	E5071B	MY42402726	Jul. 2006
Dielectric Probe Kit	Agilent	85070E	MY44300124	N/A
Signal Generator	Anritsu	MG3692A	020311	Feb. 2006
Power Meter	Agilent	438A	3513U06187	Feb. 2006
Power Sensor	Agilent	84815A	3318A01828	Feb. 2006
Data Acquisition Package	Apriel	ALS-DAQ-PAQ-2	110-00203	Mar. 2006
Apriel Laboratories Probe	Apriel	ALS-E020	266	Mar. 2006
Apriel Reference Dipole 835MHz	Apriel	ALS-D-835-S-2	180-00553	Mar. 2005
Apriel Reference Dipole 1900MHz	Apriel	ALS-D-1900-S-2	210-00703	Mar. 2005
Apriel Reference Dipole 2450MHz	Apriel	ALS-D-2450-S-2	220-00753	Mar. 2005
Apriel Reference Dipole 5200MHz	Apriel	ALS-D-5200-S-2	230-00802	Mar. 2005
Apriel Reference Dipole 5800MHz	Apriel	ALS-D-5800-S-2	240-00852	Mar. 2005
Boundary Detection Sensor System	Apriel	ALS-PMDPS-2	120-00253	N/A
Universal Work Station	Apriel	ALS-UWS	100-00153	N/A
Device Holder 2.0	Apriel	ALS-H-E-SET-2	170-00503	N/A
Left Ear SAM Phantom	Apriel	ALS-P-SAM-L	130-00305	N/A
Right Ear SAM Phantom	Apriel	ALS-P-SAM-R	140-00355	N/A
Universal Phantom	Apriel	ALS-P-UP-1	150-00405	N/A
Apriel Dipole Spacer	Apriel	ALS-DS-U	250-00903	N/A
SAR Software	Apriel	ALSAS-10U Ver.2.2.0	B0D5F-112FE	N/A
CRS C500C Controller	Thermo	ALS-C500	RCF0440278	N/A
CRF F3 Robot	Thermo	ALS-F3	RAF0440252	N/A
Power Amplifier	Mini-Circuit	ZVE-8G	D030305	N/A
Vector Network Analyzer	Agilent	E5071B	MY42402726	Jul. 2006
Dielectric Probe Kit	Agilent	85070E	MY44300124	N/A
Signal Generator	Anritsu	MG3692A	020311	Feb. 2006
Power Meter	Agilent	438A	3513U06187	Feb. 2006
Power Sensor	Agilent	84815A	3318A01828	Feb. 2006

Note: All equipment upon which need to be calibrated are with calibration period of 1 year except Reference Dipole is to be calibrated every two years. .

8. Measurement Uncertainty

Source of Uncertainty	Tolerance Value	Probability Distribution	Divisor	c_1 (1g)	c_1 (10g)	Standard Uncertainty (1-g) %	Standard Uncertainty (10g) %
Measurement System							
Probe Calibration	3.5	normal	1	1	1	3.5	3.5
Axial Isotropy	3.7	rectangular	$\sqrt{3}$	$(1-cp)^{1/2}$	$(1-cp)^{1/2}$	1.5	1.5
Hemispherical Isotropy	10.9	rectangular	$\sqrt{3}$	vcp	vcp	4.4	4.4
Boundary Effect	1.0	rectangular	$\sqrt{3}$	1	1	0.6	0.6
Linearity	4.7	rectangular	$\sqrt{3}$	1	1	2.7	2.7
Detection Limit	1.0	rectangular	$\sqrt{3}$	1	1	0.6	0.6
Readout Electronics	1.0	normal	1	1	1	1.0	1.0
Response Time	0.8	rectangular	$\sqrt{3}$	1	1	0.5	0.5
Integration Time	1.7	rectangular	$\sqrt{3}$	1	1	1.0	1.0
RF Ambient Condition	3.0	rectangular	$\sqrt{3}$	1	1	1.7	1.7
Probe Positioner Mech.	0.4	rectangular	$\sqrt{3}$	1	1	0.2	0.2
Restriction							
Probe Positioning with respect to Phantom Shell	2.9	rectangular	$\sqrt{3}$	1	1	1.7	1.7
Extrapolation and Integration	3.7	rectangular	$\sqrt{3}$	1	1	2.1	2.1
Test Sample Positioning	4.0	normal	1	1	1	4.0	4.0
Device Holder Uncertainty	2.0	normal	1	1	1	2.0	2.0
Drift of Output Power	1.6	rectangular	$\sqrt{3}$	1	1	0.9	0.9
Phantom and Setup							
Phantom Uncertainty(shape & thickness tolerance)	3.4	rectangular	$\sqrt{3}$	1	1	2.0	2.0
Liquid Conductivity(target)	5.0	rectangular	$\sqrt{3}$	0.7	0.5	2.0	1.4
Liquid Conductivity(meas.)	4.6	normal	1	0.7	0.5	3.2	2.3
Liquid Permittivity(target)	5.0	rectangular	$\sqrt{3}$	0.6	0.5	1.7	1.4
Liquid Permittivity(meas.)	2.3	normal	1	0.6	0.5	1.4	1.1
Combined Uncertainty		RSS				9.9	9.5
Combined Uncertainty (coverage factor=2)		Normal(k=2)				19.8	18.9

9. Test Result Summary

9.1 EUT Test Position : Laptop

The EUT is put on the laptop of user. The TX Antennas WLAN_Main , WLAN_Aux and WWAN_Main are enable.

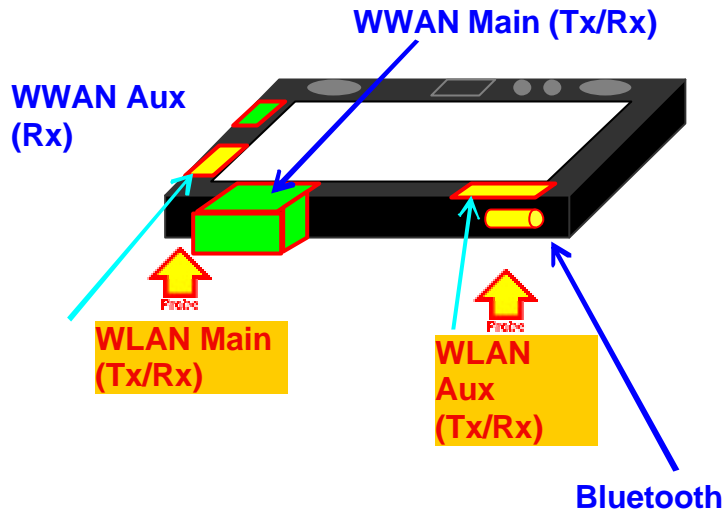

9.2 EUT Test Position: Tablet Mode

In order to meet SAR requirement, the TX antennas located in BODY SIDE will be disabled.

	Antenna	Notebook Mode	Primary Landscape (PL)	Primary Portrait (PP)	Secondary Landscape (SL)	Secondary Portrait (SP)	802.11 a/b/g	WWAN
WLAN	1 (Main)	Enable	Enable	Enable	Enable	Disable	Tx/Rx	NA
	2 (Aux)	Enable	Enable	Enable	Disable	Enable	Tx/Rx	NA
WWAN	Main	Enable	Enable	Enable	NA*1	Enable	NA	Tx/Rx
	Aux	Enable	Enable	Enable	NA*1	Enable	NA	Rx
Screen orientation vs. Body side								

Note:

- *1: System does not function for the Secondary Landscape, when WWAN is enabled
- WLAN and WWAN can not transmit at the same time.

9.3 EUT Test Position: Notebook PC Mode

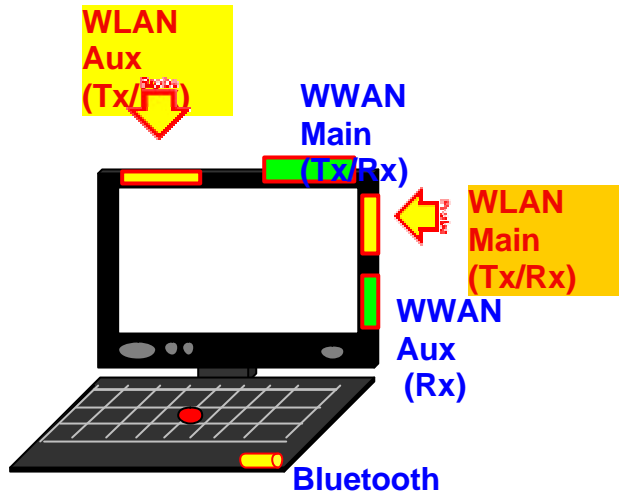

In Notebook PC mode, the distance between user to TX antennas (WLAN_Main , WLAN_Aux and WWAN_Main) is much larger than the distance of Laptop mode and Tablet mode. It is not necessary to verify the SAR Value of this Notebook PC mode.

The Conducted Power output of EUT

802.11b (dBm)								
Freq. (MHz)	Bit rate 1 mbps	Bit rate 2 mbps	Bit rate 5.5	Bit rate 11				
2412	19.7	19.5	19.4	19.5				
2437	20.1	20.0	19.9	19.9				
2462	19.8	19.6	19.5	19.5				
802.11g (dBm)								
Freq. (MHz)	Bit rate 6 mbps	Bit rate 9 mbps	Bit rate 12	Bit rate 18	Bit rate 24 mbps	Bit rate 36 mbps	Bit rate 54	Bit rate 108
2412	22.6	22.4	22.4	22.3	22.3	22.2	22.3	22.4
2437	22.7	22.6	22.3	22.5	22.4	22.5	22.6	22.5
2462	22.5	22.2	22.2	22.3	22.4	22.1	22.3	22.3
802.11a (5150MHz ~ 5350 MHz) (dBm)								
Freq. (MHz)	Bit rate 6 mbps	Bit rate 9 mbps	Bit rate 12	Bit rate 18	Bit rate 24 mbps	Bit rate 36 mbps	Bit rate 54	Bit rate 108
5180	15.9	15.6	15.4	15.2	15.4	15.4	15.6	15.7
5260	16.0	15.8	15.7	15.4	15.6	15.4	15.8	15.8
5320	15.3	15.0	15.1	15.2.	15.2	15.3	15.0	15.1
802.11a (5725MHz ~ 5850 MHz) (dBm)								
Freq. (MHz)	Bit rate 6 mbps	Bit rate 9 mbps	Bit rate 12	Bit rate 18	Bit rate 24 mbps	Bit rate 36 mbps	Bit rate 54	Bit rate 108
5745	20.8	20.6	20.5	20.6	20.8	20.7	20.7	20.8
5785	21.3	21.1	21.0	20.9	21.2	20.8	21.1	21.1
5805	20.7	20.6	20.4	20.4	20.6	20.3	20.6	20.6

Note: The frequency and bit rate with highest output power was used to test SAR.

9.4 WLAN +Bluetooth SAR measurement Data

SAR Measurement						
Ambient Temperature (°C) : 22.2~22.8				Relative Humidity (%) : 45 ~ 55		
EUT Position (See Note 1)	Transmitting Antenna (Bluetooth always on)	Frequency (MHz)		WLAN SAR 1g (W/Kg) (Note 2)	WWAN SAR 1g (W/Kg)	SUM SAR 1g (W/Kg) (Note 3)
		WLAN	WWAN (Note 1)			
802.11b mode						
Liquid Temperature (°C) : 22.6±1				Depth of Liquid (cm):>15		
Tablet, PL	WLAN: Main,	2437	-----	0.033	----	----
Tablet, PP	WLAN: Aux,	2437	-----	0.203	----	----
Tablet, SL	WLAN: Main	2437	-----	0.053	----	----
Tablet, SP	WLAN: Aux,	2437	-----	0.037	----	----
Laptop	WLAN: Main,	2437	-----	0.067	----	----
Laptop	WLAN: Aux,	2437	-----	0.033	----	----
802.11g mode						
Tablet, PL	WLAN: Main,	2437	-----	0.041	----	----
Tablet, PP	WLAN: Aux,	2437	-----	0.118	----	----
Tablet, SL	WLAN: Main	2437	-----	0.039	----	----
Tablet, SP	WLAN: Aux,	2437	-----	0.058	----	----
Laptop	WLAN: Main,	2437	-----	0.049	----	----
Laptop	WLAN: Aux,	2437	-----	0.023	----	----
802.11a mode (5150MHz ~ 5350MHz)						
Liquid Temperature (°C) : 22.2±1				Depth of Liquid (cm):>15		
Tablet, PL	WLAN: Main,	5260	-----	0.133	----	----
Tablet, PP	WLAN: Aux,	5260	-----	0.107	----	----
Tablet, SL	WLAN: Main	5260	-----	0.097	----	----
Tablet, SP	WLAN: Aux,	5260	-----	0.079	----	----
Laptop	WLAN: Main,	5260	-----	0.166	----	----
Laptop	WLAN: Aux,	5260	-----	0.081	----	----
802.11a mode (5725MHz ~ 5850MHz)						
Liquid Temperature (°C) : 22.3±1				Depth of Liquid (cm):>15		
Tablet, PL	WLAN: Main,	5785	-----	0.120	----	----
Tablet, PP	WLAN: Aux,	5785	-----	0.175	----	----
Tablet, SL	WLAN: Main	5785	-----	0.135	----	----
Tablet, SP	WLAN: Aux,	5785	-----	0.053	----	----
Laptop	WLAN: Main,	5785	-----	0.185	----	----
Laptop	WLAN: Aux,	5785	-----	0.171	----	----

- Note 1: WWAN did not transmit for the test listed in this table.
- Note 2: The 1g SAR measurement of WLAN + Bluetooth only.
- Note 3: SUM 1g SAR = WLAN+Bluetooth 1g SAR + WWAN 1g SAR.
- Note 4: WLAN and WWAN can not transmit at the same time. .

10. SAR System Validation Data

10.1 2450 MHz System Validation Data

Measurement Date : 26-Aug-2006

Product Data

Device Name : Dipole-2450
Serial No. : Validation
Type : Dipole
Model : Standard
Frequency : 2450.00 MHz
Max. Transmit Pwr : 1 W
Drift Time : 0 min(s)
Length : 51.5 mm
Width : 3.6 mm
Depth : 30.4 mm
Antenna Type : Internal
Orientation : Touch
Power Drift-Start : 70.028 W/kg
Power Drift-Finish: 67.707 W/kg
Power Drift (%) : -3.314
Picture :

Phantom Data

Name : APREL-Uni
Type : Uni-Phantom
Size (mm) : 280 x 280 x 200
Serial No. : System Default
Location : Center
Description : uni_1

Tissue Data

Type : HEAD
Serial No. : 2450HEAD
Frequency : 2450.00 MHz
Last Calib. Date : 26-Aug-2006
Temperature : 22.60 °C
Ambient Temp. : 22.90 °C
Humidity : 50.00 RH%
Epsilon : 39.94 F/m
Sigma : 1.75 S/m
Density : 1000.00 kg/cu. m

Probe Data

Name : E-field Probe
Model : ALS-E-020
Type : E-Field Triangle
Serial No. : 266
Last Calib. Date : 22-Jun-2006
Frequency : 2450.00 MHz
Duty Cycle Factor: 1
Conversion Factor: 4.9
Probe Sensitivity: 1.20 1.20 1.20 $\mu\text{V}/(\text{V}/\text{m})^2$
Compression Point: 95.00 mV
Offset : 1.56 mm

Measurement Data

Crest Factor : 1
Area Scan : 6x6x1 : Measurement x=10mm, y=10mm, z=4mm
Zoom Scan : 5x5x11 : Measurement x=8mm, y=8mm, z=3mm

Other Data

DUT Position : Touch
Separation : 0
Channel : Mid - 2450MHz

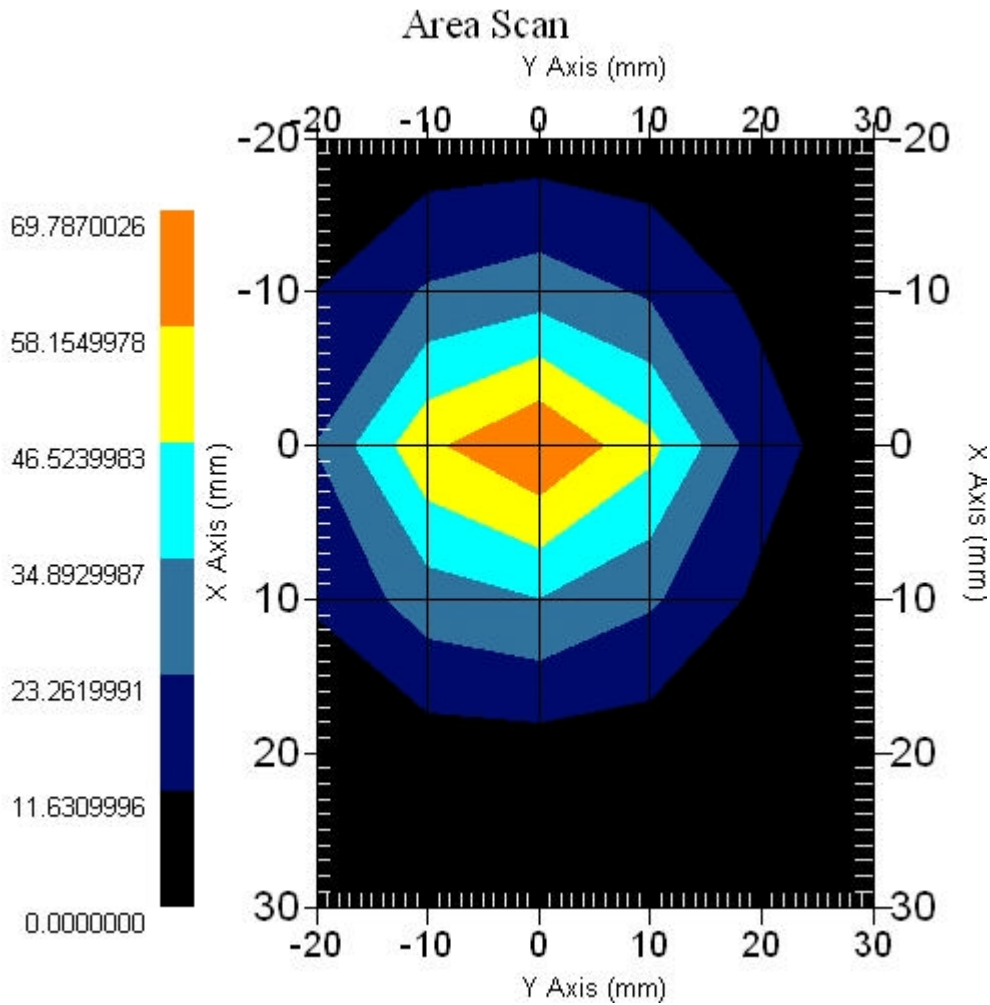

1 gram SAR value : 55.957 W/kg
10 gram SAR value : 25.595 W/kg
Area Scan Peak SAR : 69.787 W/kg
Zoom Scan Peak SAR : 115.101 W/kg

SAR-Z Axis
at Hotspot x:0.30 y:-2.30

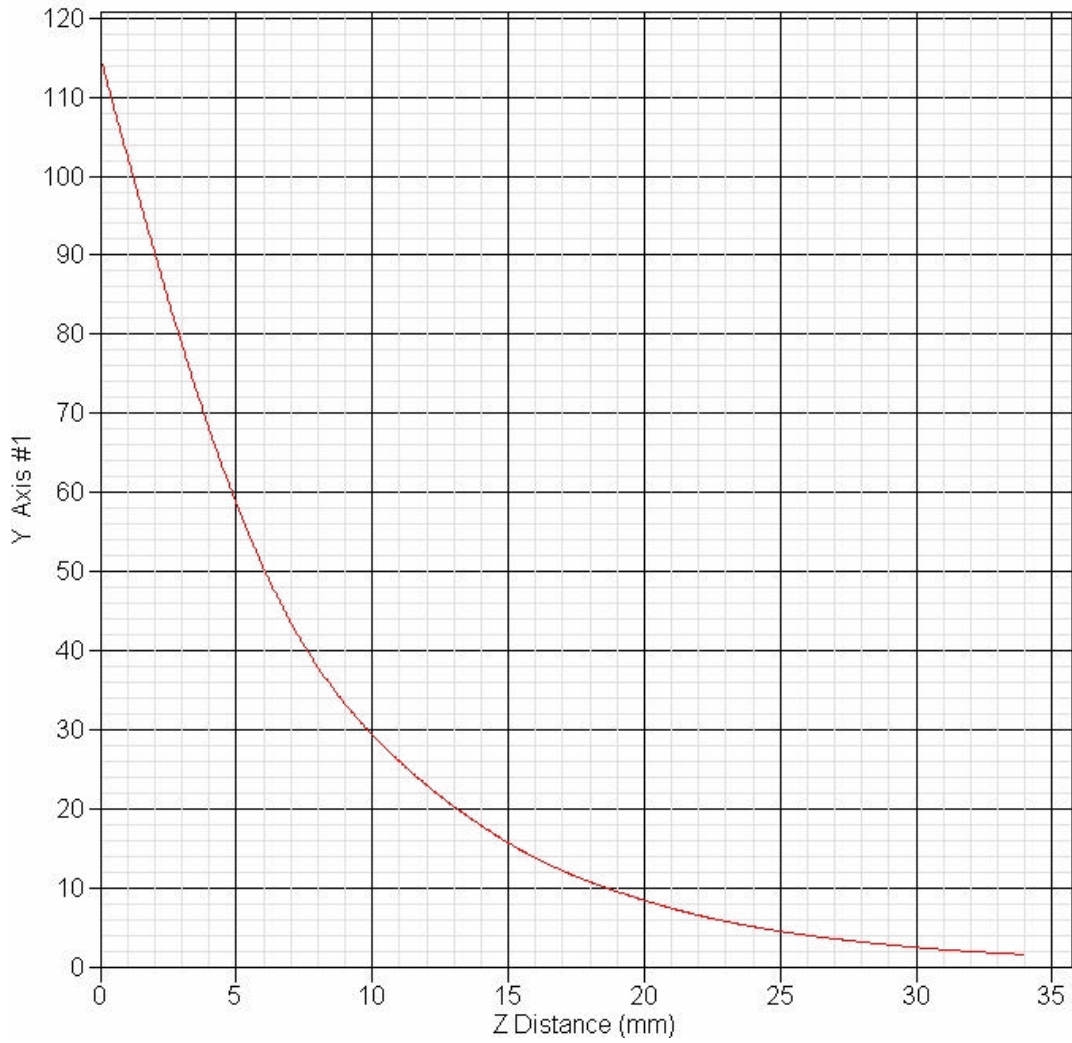

10.2 5200 MHz System Validation Data

Measurement Date : 28-Aug-2006

Product Data

Device Name : Dipole-5200
Serial No. : 230-00802
Type : Dipole
Model : ALS-D-5200-S-2
Frequency : 5200.00 MHz
Max. Transmit Pwr : 1 W
Drift Time : 0 min(s)
Length : 23.4 mm
Width : 3.6 mm
Depth : 15.4 mm
Antenna Type : Internal
Orientation : Touch
Power Drift-Start : 78.465 W/kg
Power Drift-Finish: 79.927 W/kg
Power Drift (%) : 1.863
Picture :

Phantom Data

Name : APREL-Uni
Type : Uni-Phantom
Size (mm) : 280 x 280 x 200
Serial No. : System Default
Location : Center
Description : uni_1

Tissue Data

Type : HEAD
Serial No. : 5200-H-AU-18
Frequency : 5200.00 MHz
Last Calib. Date : 28-Aug-2005
Temperature : 22.20 °C
Ambient Temp. : 22.60 °C
Humidity : 55.00 RH%
Epsilon : 37.33 F/m
Sigma : 4.91 S/m
Density : 1000.00 kg/cu. m

Probe Data

Name : E-field Probe
Model : ALS-E-020
Type : E-Field Triangle
Serial No. : 266
Last Calib. Date : 22-Jun-2006
Frequency : 5200.00 MHz
Duty Cycle Factor: 1
Conversion Factor: 3.82
Probe Sensitivity: 1.20 1.20 1.20 $\mu\text{V}/(\text{V}/\text{m})^2$
Compression Point: 95.00 mV
Offset : 1.56 mm

Measurement Data

Crest Factor : 1
Scan Type : Complete
Area Scan : 6x6x1 : Measurement x=10mm, y=10mm, z=4mm
Zoom Scan : 9x9x13 : Measurement x=4mm, y=4mm, z=2.5mm

Other Data

DUT Position : Touch
Separation : 0
Channel : Mid - 5200MHz

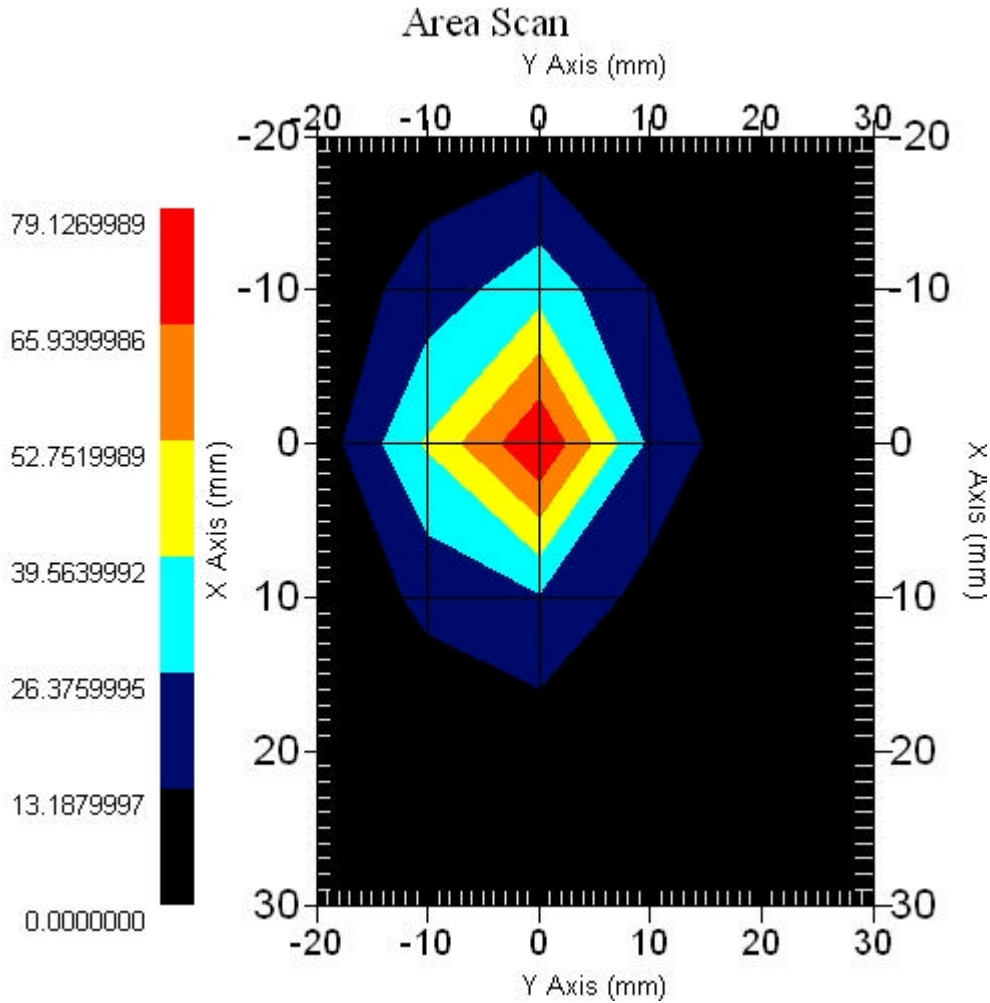

1 gram SAR value : 61.924 W/kg
10 gram SAR value : 18.832 W/kg
Area Scan Peak SAR : 79.127 W/kg
Zoom Scan Peak SAR : 187.154 W/kg

SAR-Z Axis
at Hotspot x:0.30 y:-2.20

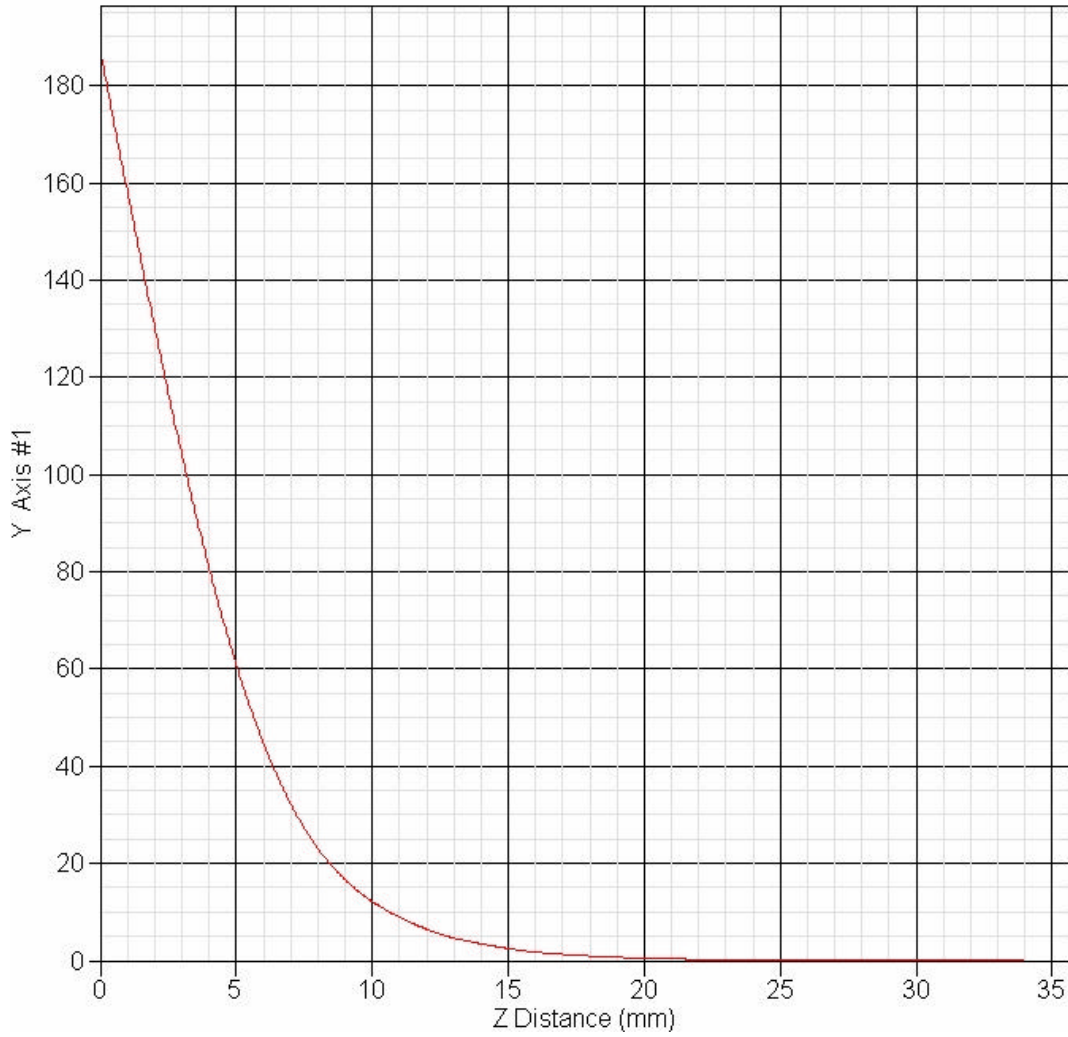

10.3 5800 MHz System Validation Data

Measurement Date : 29-Aug-2006

Product Data

Device Name : Dipole-5800
Serial No. : 240-00852
Type : Dipole
Model : ALS-D-5800-S-2
Frequency : 5800.00 MHz
Max. Transmit Pwr : 1 W
Drift Time : 0 min(s)
Length : 21.4 mm
Width : 3.6 mm
Depth : 89.8 mm
Antenna Type : Internal
Orientation : Touch
Power Drift-Start : 70.882 W/kg
Power Drift-Finish: 69.931 W/kg
Power Drift (%) : -1.341
Picture :

Phantom Data

Name : APREL-Uni
Type : Uni-Phantom
Size (mm) : 280 x 280 x 200
Serial No. : System Default
Location : Center
Description : uni_1

Tissue Data

Type : HEAD
Serial No. : 5800-H-AU-19
Frequency : 5800.00 MHz
Last Calib. Date : 29-Aug-2005
Temperature : 22.30 °C
Ambient Temp. : 22.80 °C
Humidity : 51.00 RH%
Epsilon : 36.47 F/m
Sigma : 5.41 S/m
Density : 1000.00 kg/cu. m

Probe Data

Name : E-field Probe
Model : ALS-E-020
Type : E-Field Triangle
Serial No. : 266
Last Calib. Date : 22-Jun-2006
Frequency : 5800.00 MHz
Duty Cycle Factor: 1
Conversion Factor: 3.72
Probe Sensitivity: 1.20 1.20 1.20 $\mu\text{V}/(\text{V}/\text{m})^2$
Compression Point: 95.00 mV
Offset : 1.56 mm

Measurement Data

Crest Factor : 1
Scan Type : Complete
Area Scan : 6x6x1 : Measurement x=10mm, y=10mm, z=4mm
Zoom Scan : 9x9x13 : Measurement x=4mm, y=4mm, z=2.5mm

Other Data

DUT Position : Touch
Separation : 0
Channel : Mid - 5800MHz

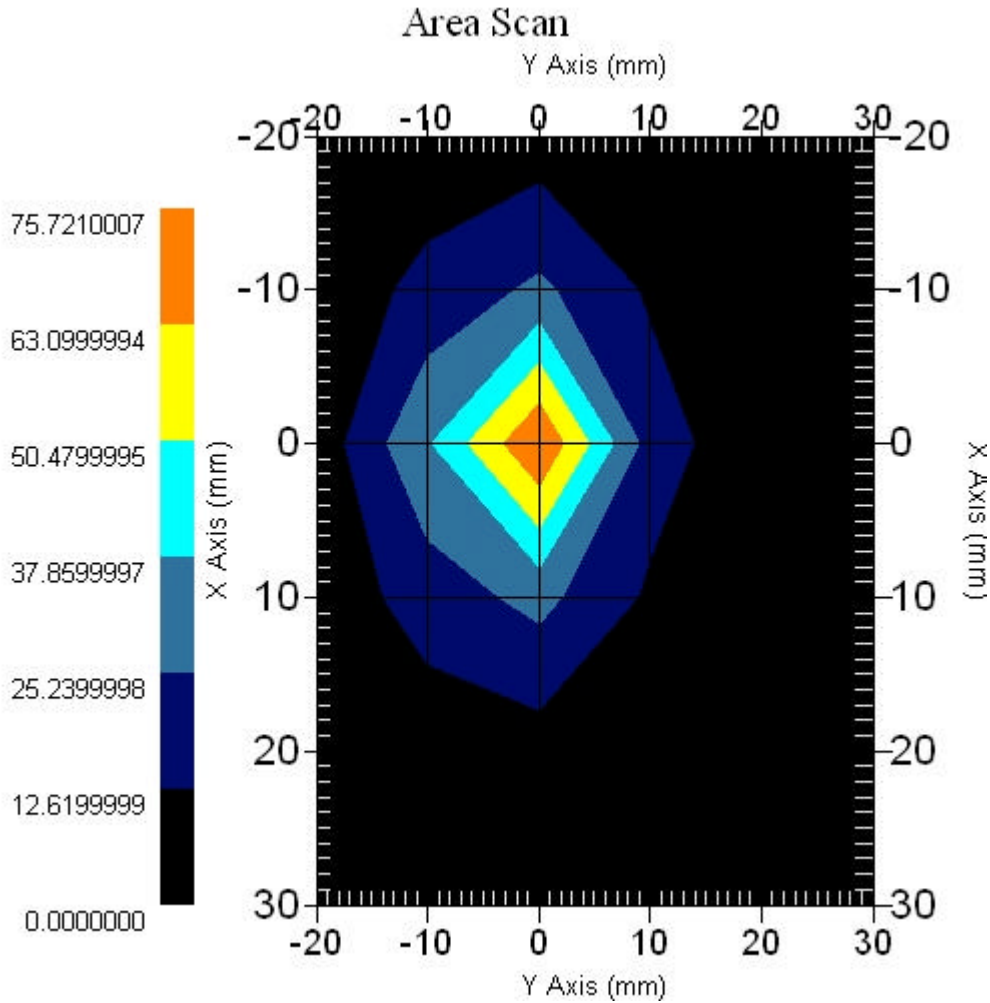

1 gram SAR value : 57.717 W/kg
10 gram SAR value : 18.255 W/kg
Area Scan Peak SAR : 75.721 W/kg
Zoom Scan Peak SAR : 182.148 W/kg

SAR-Z Axis
at Hotspot x:0.30 y:-2.30

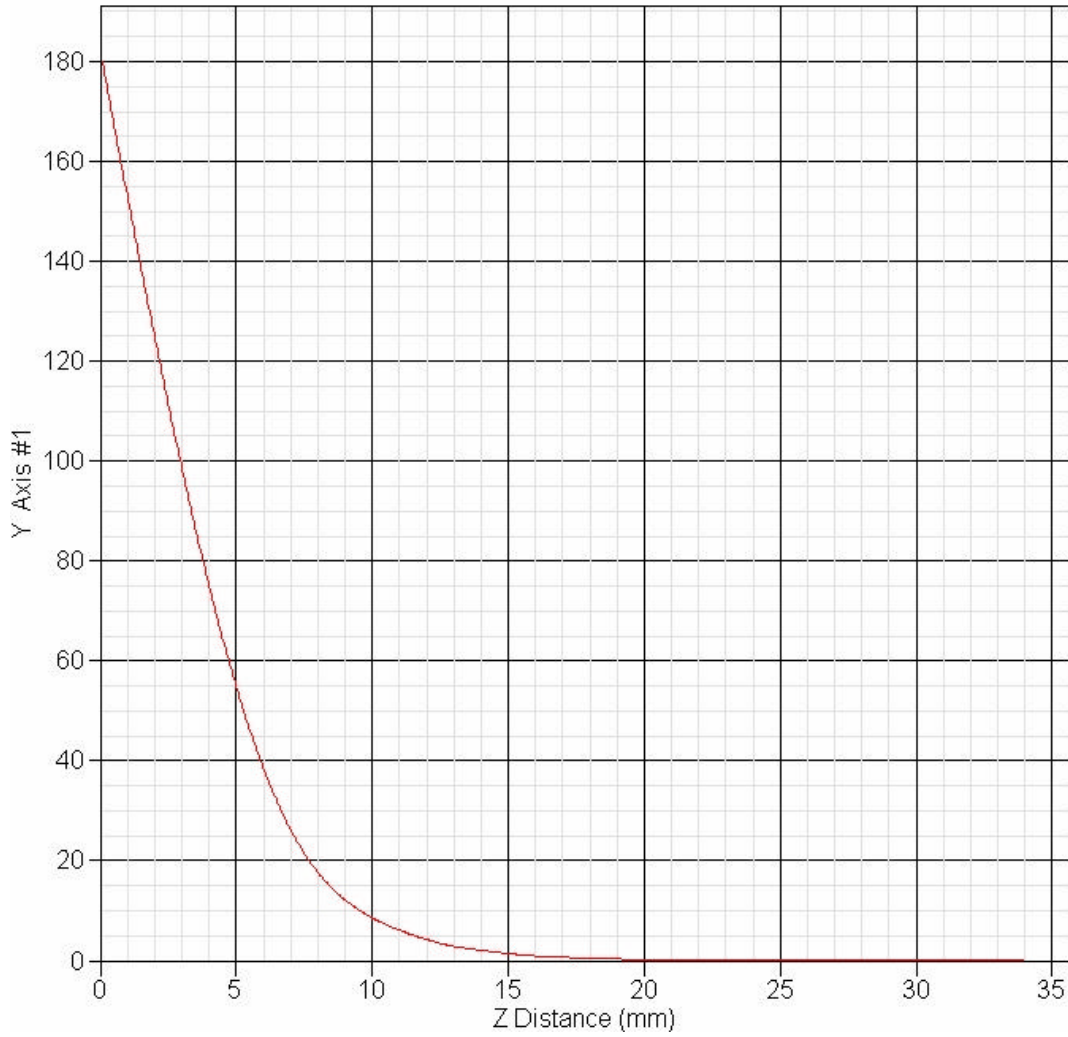

11. WLAN + Bluetooth SAR measurement Data 2450MHz Measurement

Measurement Date : 26-Aug-2006

Product Data

Device Name : Atheros
Serial No. :
Type : Other
Model : 1
Frequency : 2437.00 MHz
Max. Transmit Pwr : 0.102 W
Drift Time : 0 min(s)
Length : 274 mm
Width : 32 mm
Depth : 10 mm
Antenna Type : Internal
Orientation : Touch

Phantom Data

Name : APREL-Uni
Type : Uni-Phantom
Size (mm) : 280 x 280 x 200
Serial No. : System Default
Location : Center
Description : uni_1

Tissue Data

Type : BODY
Serial No. : 2450BODY
Frequency : 2450.00 MHz
Last Calib. Date : 26-Aug-2006
Temperature : 22.20 °C
Ambient Temp. : 22.50 °C
Humidity : 49.00 RH%
Epsilon : 51.68 F/m
Sigma : 1.98 S/m
Density : 1000.00 kg/cu. m

Probe Data

Name : E-field Probe
Model : ALS-E-020
Type : E-Field Triangle
Serial No. : 266
Last Calib. Date : 22-Jun-2006
Frequency : 2450.00 MHz
Duty Cycle Factor: 1
Conversion Factor: 5.02
Probe Sensitivity: 1.20 1.20 1.20 $\mu\text{V}/(\text{V}/\text{m})^2$
Compression Point: 95.00 mV
Offset : 2.44 mm

5200MHz Measurement

Measurement Date : 28-Aug-2006

Product Data

Device Name : Atheros
Serial No. :
Type : Other
Model : 1
Frequency : 5260.00 MHz
Max. Transmit Pwr : 0.040 W
Drift Time : 0 min(s)
Length : 274 mm
Width : 32 mm
Depth : 10 mm
Antenna Type : Internal
Orientation : Touch

Phantom Data

Name : APREL-Uni
Type : Uni-Phantom
Size (mm) : 280 x 280 x 200
Serial No. : System Default
Location : Center
Description : uni_1

Tissue Data

Type : BODY
Serial No. : 5200BODY
Frequency : 5200.00 MHz
Last Calib. Date : 28-Aug-2006
Temperature : 22.20 °C
Ambient Temp. : 22.50 °C
Humidity : 45.00 RH%
Epsilon : 48.15 F/m
Sigma : 5.43 S/m
Density : 1000.00 kg/cu. m

Probe Data

Name : E-field Probe
Model : ALS-E-020
Type : E-Field Triangle
Serial No. : 266
Last Calib. Date : 22-Jun-2006
Frequency : 2450.00 MHz
Duty Cycle Factor: 1
Conversion Factor: 4.4
Probe Sensitivity: 1.20 1.20 1.20 $\mu\text{V}/(\text{V}/\text{m})^2$
Compression Point: 95.00 mV
Offset : 2.44 mm



5800MHz Measurement

Measurement Date : 29-Aug-2006

Product Data

Device Name : Atheros
 Serial No. :
 Type : Other
 Model : 1
 Frequency : 5785.00 MHz
 Max. Transmit Pwr : 0.135 W
 Drift Time : 0 min(s)
 Length : 274 mm
 Width : 32 mm
 Depth : 10 mm
 Antenna Type : Internal
 Orientation : Touch

Phantom Data

Name : APREL-Uni
 Type : Uni-Phantom
 Size (mm) : 280 x 280 x 200
 Serial No. : System Default
 Location : Center
 Description : uni_1

Tissue Data

Type : BODY
 Serial No. : 5800BODY
 Frequency : 5800.00 MHz
 Last Calib. Date : 29-Aug-2006
 Temperature : 22.30 °C
 Ambient Temp. : 22.70 °C
 Humidity : 47.00 RH%
 Epsilon : 47.13 F/m
 Sigma : 6.18 S/m
 Density : 1000.00 kg/cu. m

Probe Data

Name : E-field Probe
 Model : ALS-E-020
 Type : E-Field Triangle
 Serial No. : 266
 Last Calib. Date : 22-Jun-2006
 Frequency : 2450.00 MHz
 Duty Cycle Factor: 1
 Conversion Factor: 4.2
 Probe Sensitivity: 1.20 1.20 1.20 $\mu\text{V}/(\text{V}/\text{m})^2$
 Compression Point: 95.00 mV
 Offset : 2.44 mm

11.1 802.11b mode

11.1.1 2437 MHz, EUT Position: Tablet,PL, Main Antenna

Measurement Data

Crest Factor : 1
Scan Type : Complete
Area Scan : 9x6x1 : Measurement x=10mm, y=10mm, z=4mm
Zoom Scan : 5x5x8 : Measurement x=8mm, y=8mm, z=4mm

Other Data

DUT Position : Touch
Separation : 0
Channel : Mid - 2437MHz

Power Drift-Start : 0.027 W/kg
Power Drift-Finish: 0.025 W/kg
Power Drift (%) : -4.166
Picture :

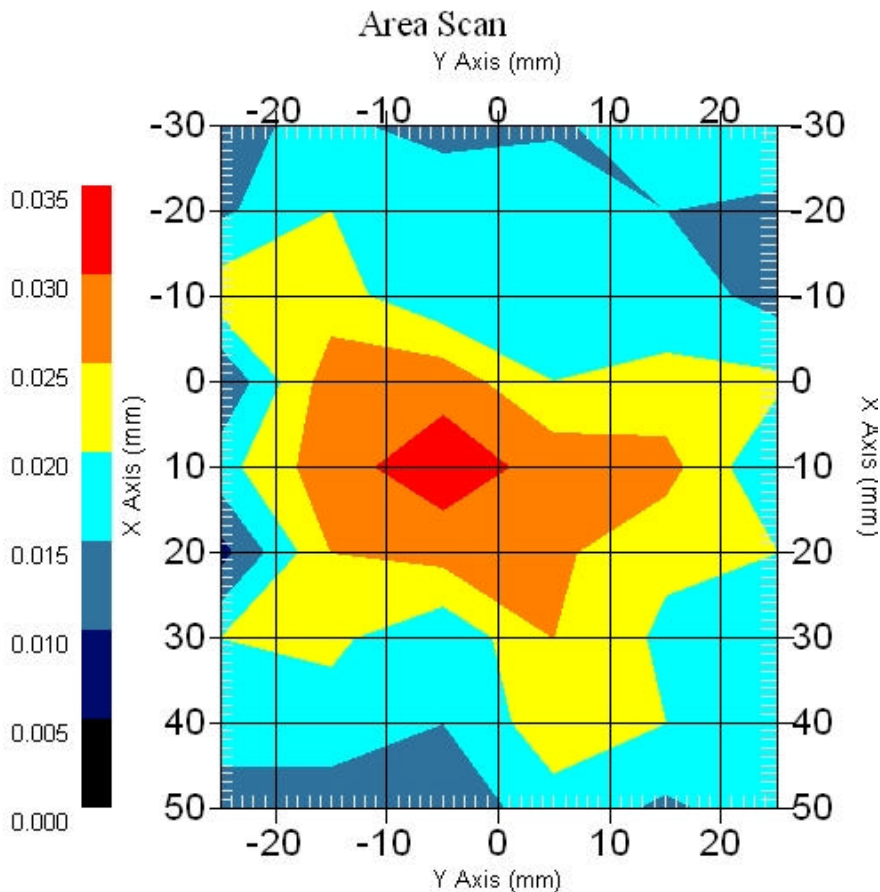

1 gram SAR value : 0.043 W/kg
10 gram SAR value : 0.033 W/kg
Area Scan Peak SAR : 0.033 W/kg
Zoom Scan Peak SAR : 0.064 W/kg

11.1.2 2437 MHz, EUT Position: Tablet,PP, Aux Antenna

Measurement Data

Crest Factor : 1
Scan Type : Complete
Area Scan : 9x6x1 : Measurement x=10mm, y=10mm, z=4mm
Zoom Scan : 5x5x8 : Measurement x=8mm, y=8mm, z=4mm

Other Data

DUT Position : Touch
Separation : 0
Channel : Mid - 2437MHz

Power Drift-Start : 0.123 W/kg
Power Drift-Finish: 0.123 W/kg
Power Drift (%) : 0.007
Picture :

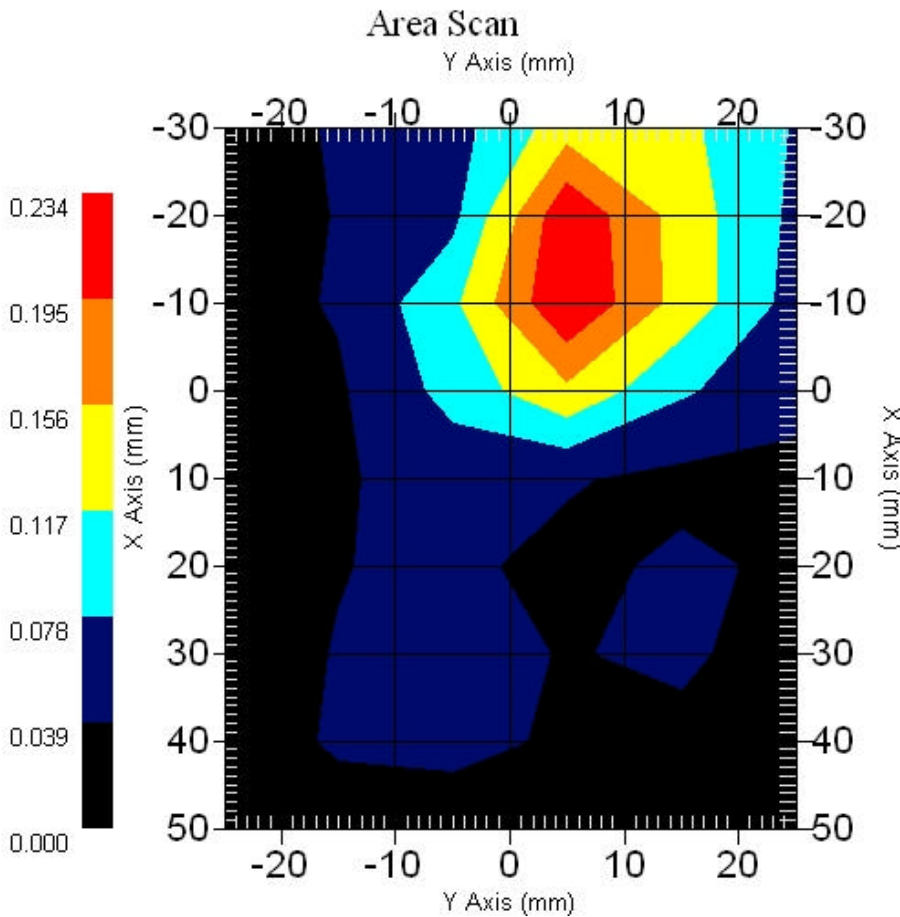

1 gram SAR value : 0.203 W/kg
10 gram SAR value : 0.102 W/kg
Area Scan Peak SAR : 0.233 W/kg
Zoom Scan Peak SAR : 0.410 W/kg

11.1.3 2437 MHz, EUT Position: Tablet,SL, Main Antenna

Measurement Data

Crest Factor : 1
Scan Type : Complete
Area Scan : 9x6x1 : Measurement x=10mm, y=10mm, z=4mm
Zoom Scan : 5x5x8 : Measurement x=8mm, y=8mm, z=4mm

Other Data

DUT Position : Touch
Separation : 0
Channel : Mid - 2437MHz

Power Drift-Start : 0.030 W/kg
Power Drift-Finish: 0.029 W/kg
Power Drift (%) : -3.333
Picture : (No picture)

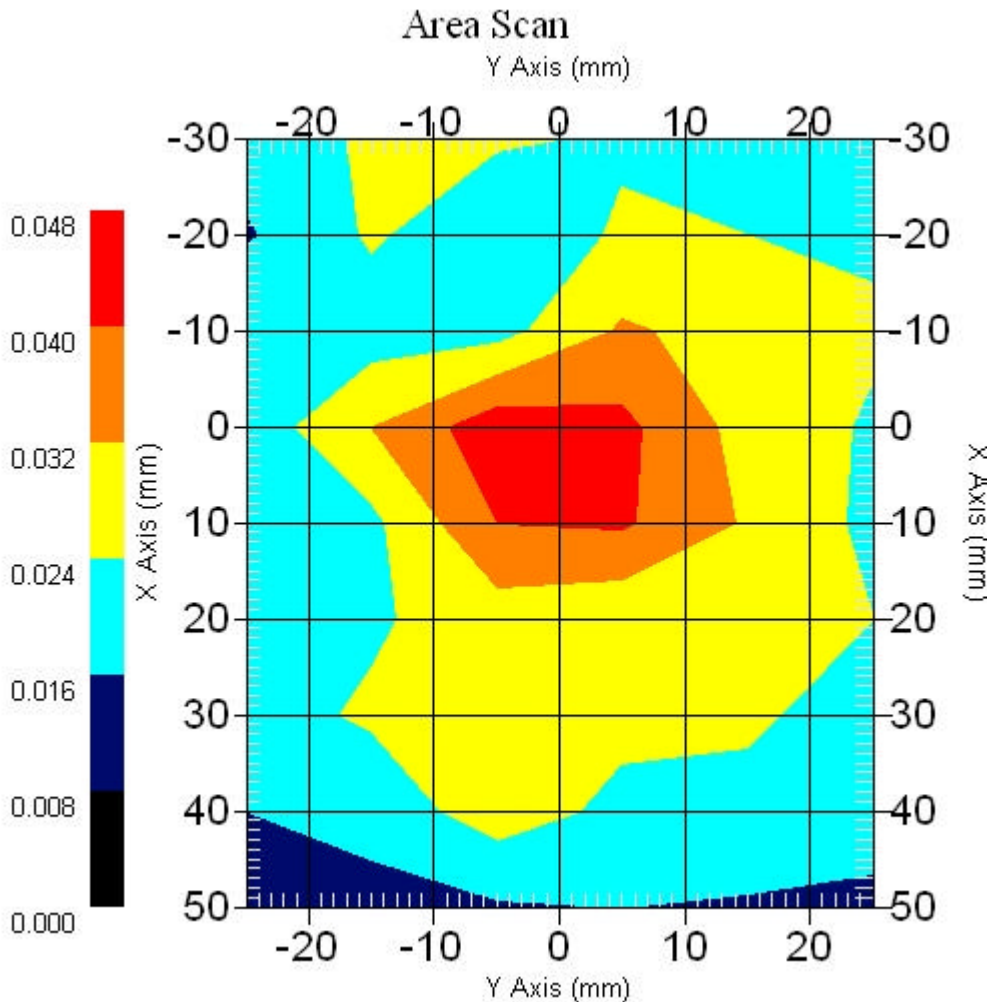

1 gram SAR value : 0.053 W/kg
10 gram SAR value : 0.041 W/kg
Area Scan Peak SAR : 0.046 W/kg
Zoom Scan Peak SAR : 0.076 W/kg

11.1.4 2437 MHz, EUT Position: Tablet,SP, Main Antenna

Measurement Data

Crest Factor : 1
Scan Type : Complete
Area Scan : 9x6x1 : Measurement x=10mm, y=10mm, z=4mm
Zoom Scan : 5x5x8 : Measurement x=8mm, y=8mm, z=4mm

Other Data

DUT Position : Touch
Separation : 0
Channel : Mid - 2437MHz

Power Drift-Start : 0.044 W/kg
Power Drift-Finish: 0.043 W/kg
Power Drift (%) : -0.011
Picture : (No picture)

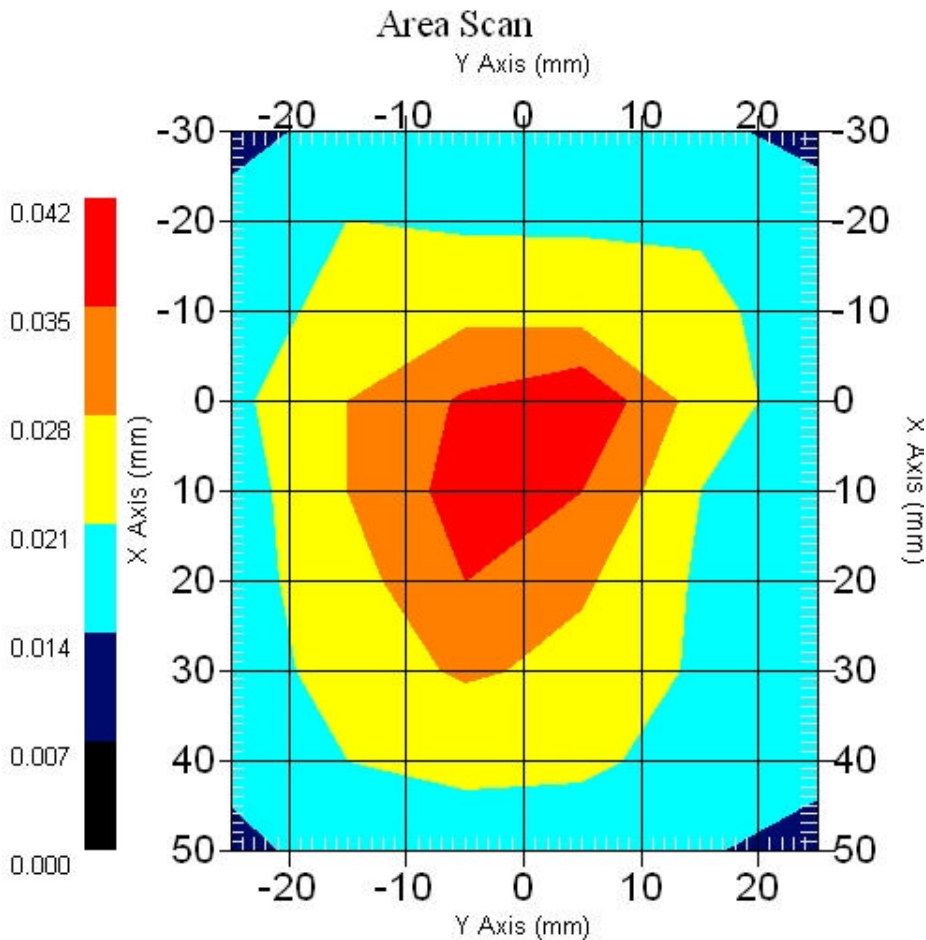

1 gram SAR value : 0.037 W/kg
10 gram SAR value : 0.024 W/kg
Area Scan Peak SAR : 0.041 W/kg
Zoom Scan Peak SAR : 0.079 W/kg

11.1.5 2437 MHz, EUT Position: Laptop, Main Antenna

Measurement Data

Crest Factor : 1
Scan Type : Complete
Area Scan : 6x8x1 : Measurement x=15mm, y=15mm, z=4mm
Zoom Scan : 5x5x8 : Measurement x=8mm, y=8mm, z=4mm

Other Data

DUT Position : Touch
Separation : 0
Channel : Mid - 2437MHz

Power Drift-Start : 0.044 W/kg
Power Drift-Finish: 0.045 W/kg
Power Drift (%) : 2.272
Picture :

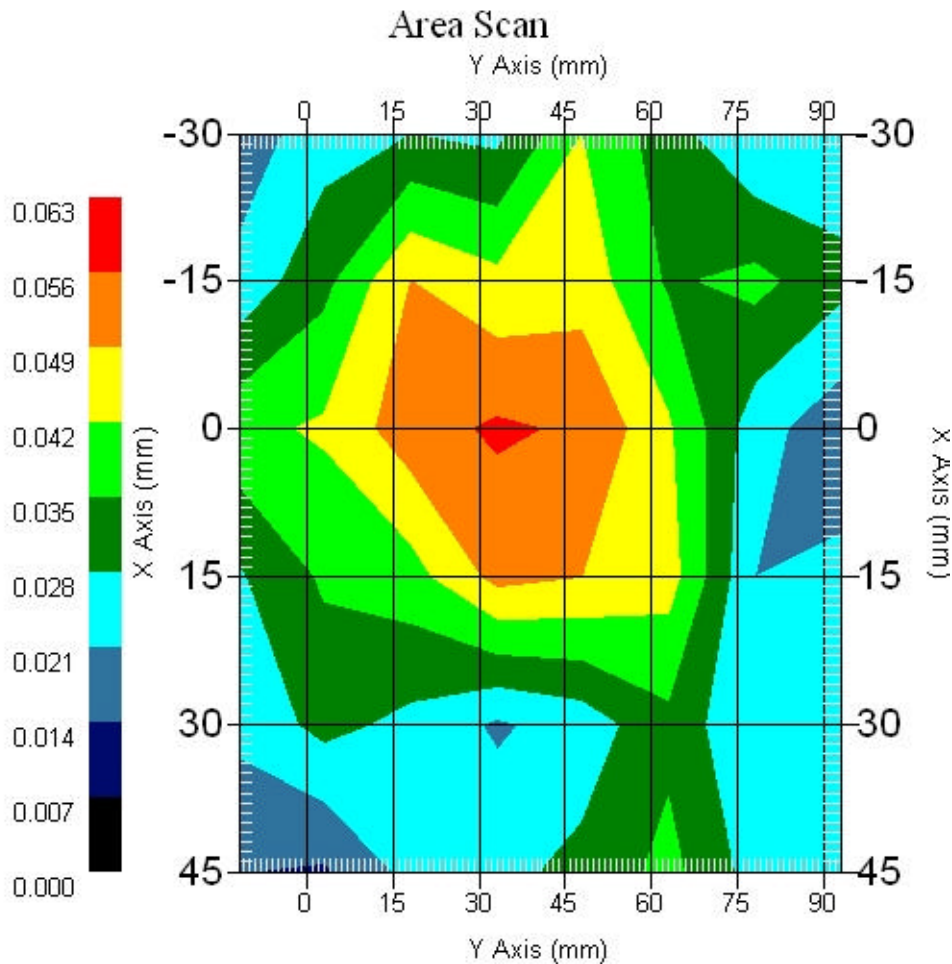

1 gram SAR value : 0.067 W/kg
10 gram SAR value : 0.044 W/kg
Area Scan Peak SAR : 0.057 W/kg
Zoom Scan Peak SAR : 0.110 W/kg

11.1.6 2437 MHz, EUT Position: Laptop,Aux Antenna

Measurement Data

Crest Factor : 1
Scan Type : Complete
Area Scan : 6x8x1 : Measurement x=15mm, y=15mm, z=4mm
Zoom Scan : 5x5x8 : Measurement x=8mm, y=8mm, z=4mm

Other Data

DUT Position : Touch
Separation : 0
Channel : Mid - 2437MHz

Power Drift-Start : 0.026 W/kg
Power Drift-Finish: 0.025 W/kg
Power Drift (%) : -3.846
Picture : (No picture)

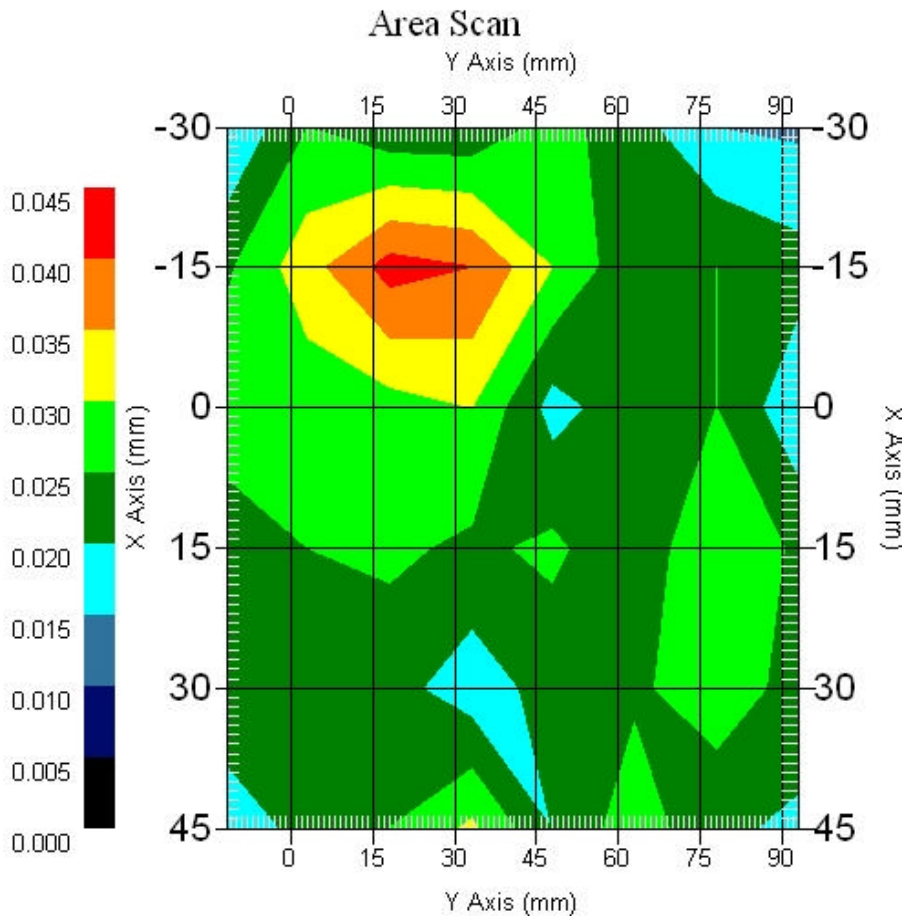

1 gram SAR value : 0.033 W/kg
10 gram SAR value : 0.024 W/kg
Area Scan Peak SAR : 0.042 W/kg
Zoom Scan Peak SAR : 0.078 W/kg

11.1.7 Z Axis 2437 MHz, EUT Position: Tablet,PP, Aux Antenna

SAR-Z Axis
at Hotspot x:-9.70 y:4.70

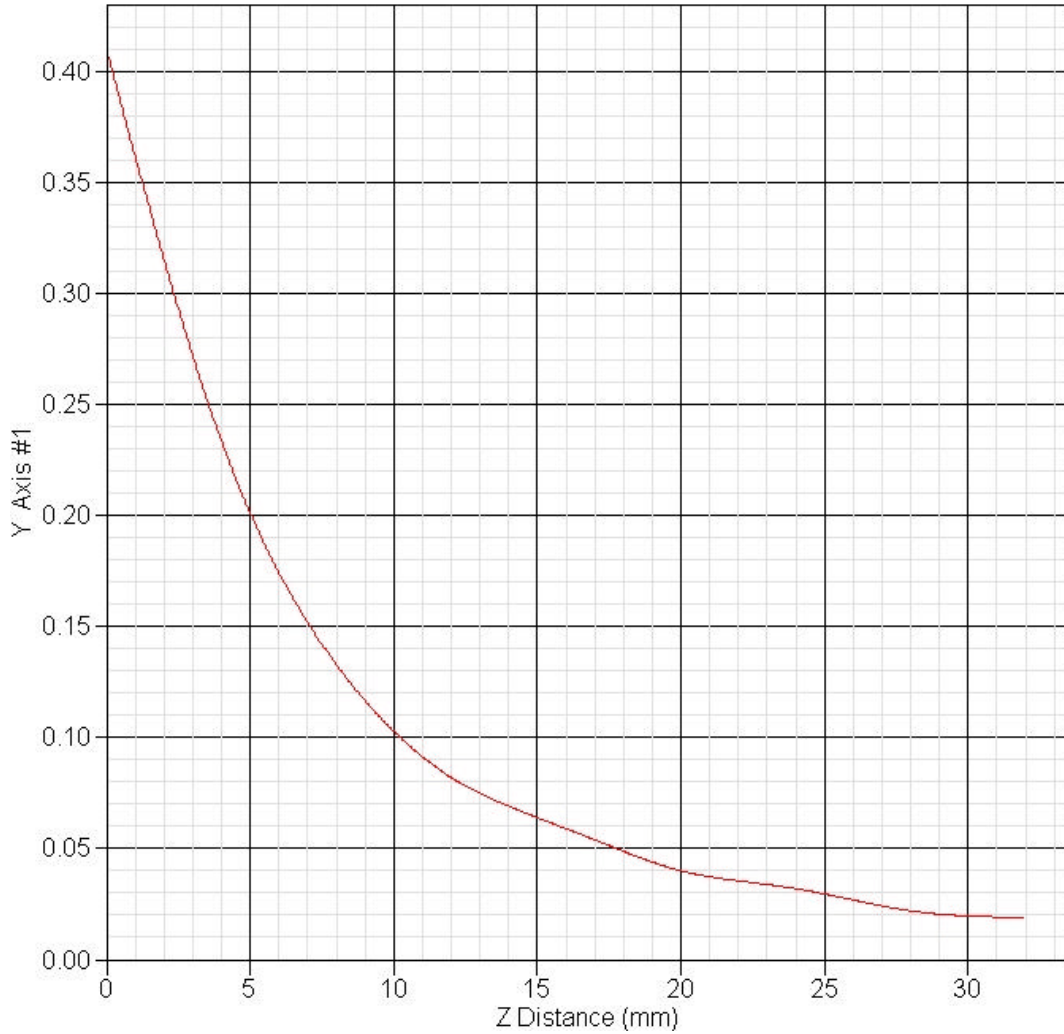

11.2 802.11g mode

11.2.1 2437 MHz, EUT Position: Tablet,PL, Main Antenna

Measurement Data

Crest Factor : 1
Scan Type : Complete
Area Scan : 9x6x1 : Measurement x=10mm, y=10mm, z=4mm
Zoom Scan : 5x5x8 : Measurement x=8mm, y=8mm, z=4mm

Other Data

DUT Position : Touch
Separation : 0
Channel : Mid - 2437MHz

Power Drift-Start : 0.029 W/kg
Power Drift-Finish: 0.030 W/kg
Power Drift (%) : 3.448
Picture : (No picture)

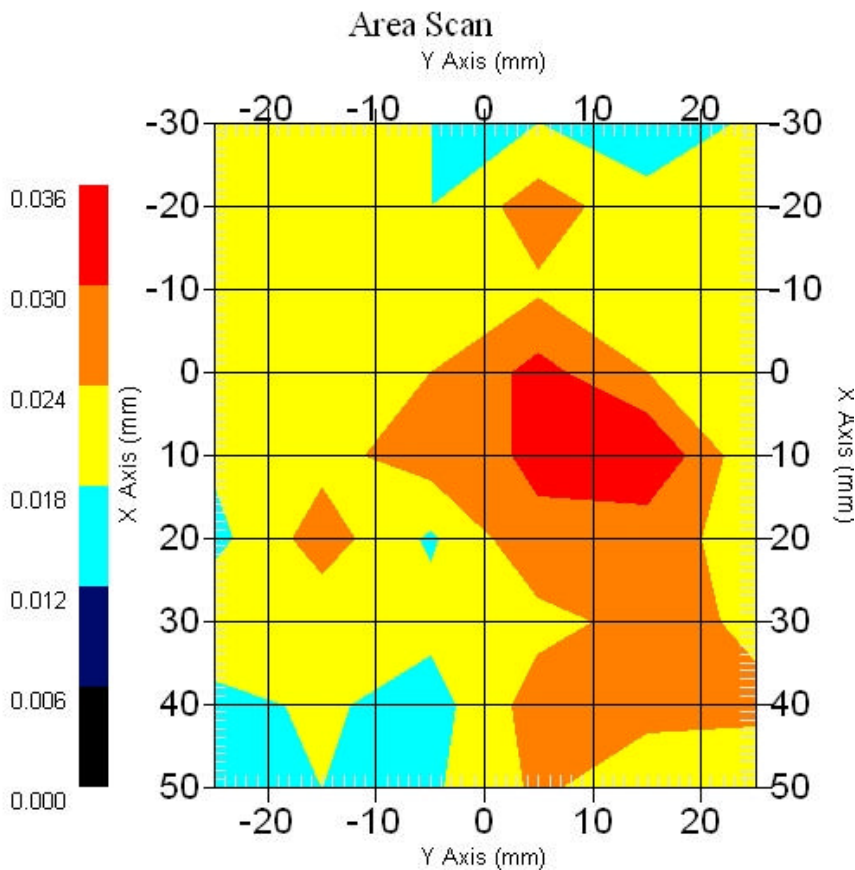

1 gram SAR value : 0.041 W/kg
10 gram SAR value : 0.032 W/kg
Area Scan Peak SAR : 0.036 W/kg
Zoom Scan Peak SAR : 0.078 W/kg