



## SAR EVALUATION REPORT

**Applicant Name:**  
 Sierra Wireless, Inc.  
 13811 Wireless Way  
 Richmond, BC V6V 3A4  
 Canada

**Date of Testing:**  
 05/15/12 - 05/21/12  
**Test Site/Location:**  
 PCTEST Lab, Columbia, MD, USA  
**Document Serial No.:**  
 OY1206280880.N7N

**FCC ID:** N7NMC8355 (Integrated in Panasonic CF-H2mk2)

**APPLICANT:** SIERRA WIRELESS, INC.

**DUT Type:** Module in Portable Tablet Computer  
**FCC Rule Part(s):** CFR §2.1093  
**Test Device Serial No.:** Pre-Production [S/N: 2DKSA00138]

Band & Mode	Tx Frequency	Conducted Power [dBm]	SAR
			1 gm Body (W/kg)
GPRS/EDGE 850	824.20 - 848.80 MHz	32.90	0.77
WCDMA/HSPA 850	826.40 - 846.60 MHz	24.37	0.37
Cell. CDMA/EVDO	824.70 - 848.31 MHz	24.56	0.39
AWS WCDMA/HSPA	1712.4 - 1752.5 MHz	24.37	0.22
GPRS/EDGE 1900	1850.20 - 1909.80 MHz	29.72	0.10
WCDMA/HSPA 1900	1852.4 - 1907.6 MHz	24.80	0.16
PCS CDMA/EVDO	1851.25 - 1908.75 MHz	24.96	0.13
<b>Simultaneous SAR per KDB 690783 D01:</b>			1.17

Note: Powers in the above table represent output powers for the SAR test configurations and may not represent the highest output powers for all configurations for each mode.

This model portable tablet computer also includes a transmitter using FCC ID: ACJ9TGWL12A.

This wireless portable device has been shown to be capable of compliance for localized specific absorption rate (SAR) for uncontrolled environment/general population exposure limits specified in ANSI/IEEE C95.1-1992 and has been tested in accordance with the measurement procedures specified in FCC/OET Bulletin 65 Supplement C (2001), IEEE 1528-2003 and in applicable Industry Canada Radio Standards Specifications (RSS); for Cellular, AWS, and PCS frequency bands only.

I attest to the accuracy of data. All measurements reported herein were performed by me or were made under my supervision and are correct to the best of my knowledge and belief. I assume full responsibility for the completeness of these measurements and vouch for the qualifications of all persons taking them. Test results reported herein relate only to the item(s) tested.

*PCTEST certifies that no party to this application has been subject to a denial of Federal benefits that includes FCC benefits pursuant to Section 5301 of the Anti-Drug Abuse Act of 1988, 21 U.S.C. 862.*

  
 Randy Ortanez  
 President



<b>FCC ID:</b> N7NMC8355 (Integrated in Panasonic CF-H2mk2)		<b>SAR EVALUATION REPORT</b>	<b>Reviewed by:</b> Quality Manager
<b>Document S/N:</b> OY1206280880.N7N	<b>Test Dates:</b> 05/15/12 - 05/21/12	<b>DUT Type:</b> Module in Portable Tablet Computer	Page 1 of 26

# T A B L E O F C O N T E N T S

---

1	DEVICE UNDER TEST .....	3
2	INTRODUCTION .....	5
3	SAR MEASUREMENT SETUP .....	6
4	DOSIMETRIC ASSESSMENT .....	7
5	TABLET SAR TESTING .....	8
6	FCC RF EXPOSURE LIMITS.....	9
7	FCC MEASUREMENT PROCEDURES.....	10
8	RF CONDUCTED POWERS.....	13
9	SYSTEM VERIFICATION.....	16
10	SAR DATA SUMMARY .....	18
11	FCC MULTI-TX AND ANTENNA SAR CONSIDERATIONS: WWAN + 2.4 GHZ.....	20
12	EQUIPMENT LIST.....	22
13	MEASUREMENT UNCERTAINTIES .....	23
14	CONCLUSION.....	24
15	REFERENCES .....	25

<b>FCC ID:</b> N7NMC8355 (Integrated in Panasonic CF-H2mk2)		<b>SAR EVALUATION REPORT</b>	<b>Reviewed by:</b> Quality Manager
<b>Document S/N:</b> 0Y1206280880.N7N	<b>Test Dates:</b> 05/15/12 - 05/21/12	<b>DUT Type:</b> Module in Portable Tablet Computer	Page 2 of 26

# 1 DEVICE UNDER TEST

## 1.1 Device Overview

Band & Mode	Tx Frequency
GPRS/EDGE 850	824.20 - 848.80 MHz
WCDMA/HSPA 850	826.40 - 846.60 MHz
Cell. CDMA/EVDO	824.70 - 848.31 MHz
AWS WCDMA/HSPA	1712.4 - 1752.5 MHz
GPRS/EDGE 1900	1850.20 - 1909.80 MHz
WCDMA/HSPA 1900	1852.4 - 1907.6 MHz
PCS CDMA/EVDO	1851.25 - 1908.75 MHz

## 1.2 DUT Antenna Locations

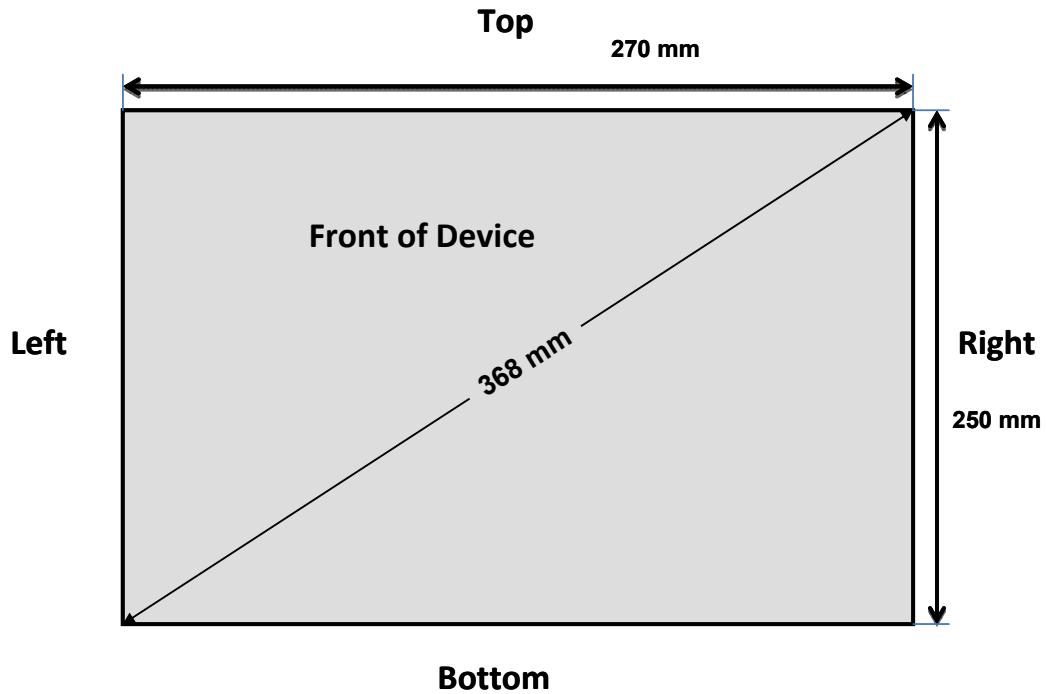

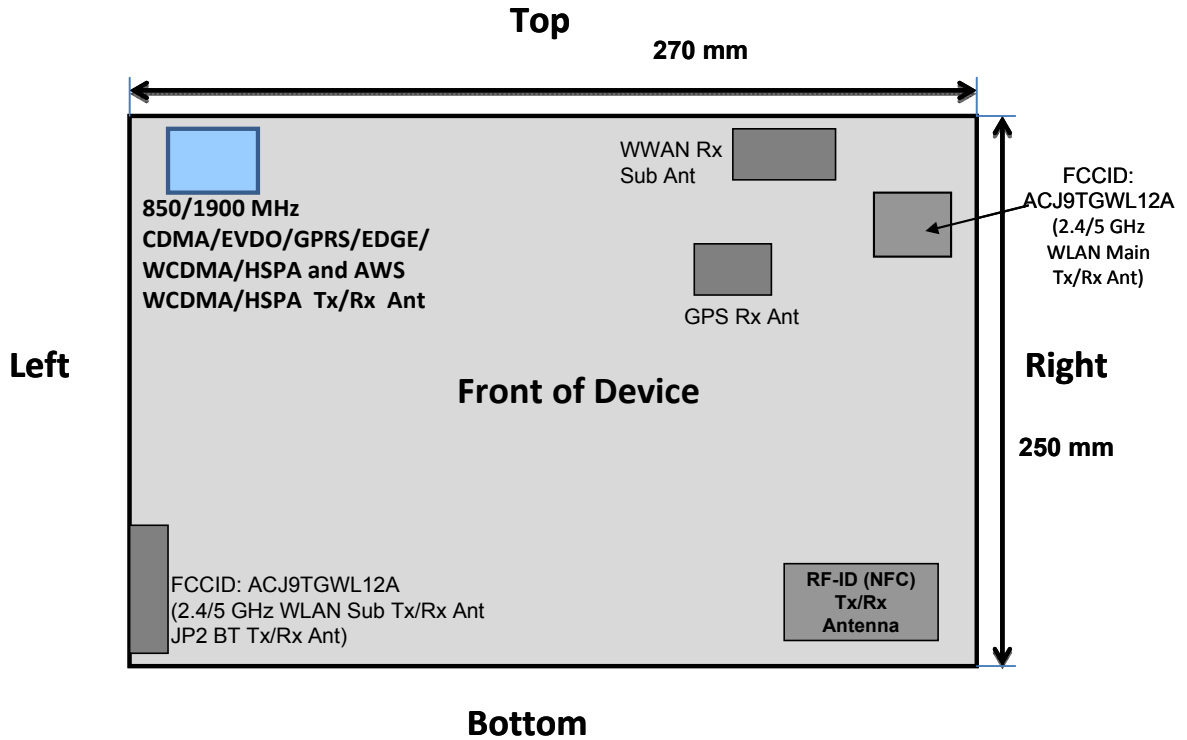

Figure 1-1  
DUT Dimensions

FCC ID: N7NMC8355 (Integrated in Panasonic CF-H2mk2)	 PCTEST ENGINEERING LABORATORY, INC.	SAR EVALUATION REPORT	Reviewed by: Quality Manager
Document S/N: 0Y1206280880.N7N	Test Dates: 05/15/12 - 05/21/12	DUT Type: Module in Portable Tablet Computer	Page 3 of 26



**Figure 1-2**  
**DUT Antenna Locations**

### 1.3 SAR Test Exclusions Applied

#### (A) Licensed Transmitter(s)

This device is only capable of QPSK HSUPA in the uplink, but is capable of HSPA+ in the downlink. Therefore, no additional SAR tests are required beyond that described for devices with HSUPA in KDB 941225 D01.

### 1.4 Power Reduction for SAR

There is no power reduction for any band/mode implemented in this device for SAR purposes.

### 1.5 FCC Guidance Applied

- FCC KDB 941225 (2G/3G)
- FCC KDB 447498 Section 4 (Tablet SAR Considerations)

<b>FCC ID:</b> N7NMC8355 (Integrated in Panasonic CF-H2mk2)	 <b>PCTEST</b> ENGINEERING LABORATORY, INC.	<b>SAR EVALUATION REPORT</b>	<b>Reviewed by:</b> Quality Manager
<b>Document S/N:</b> 0Y1206280880.N7N	<b>Test Dates:</b> 05/15/12 - 05/21/12	<b>DUT Type:</b> Module in Portable Tablet Computer	Page 4 of 26

## 2 INTRODUCTION

The FCC has adopted the guidelines for evaluating the environmental effects of radio frequency (RF) radiation in ET Docket 93-62 on Aug. 6, 1996 to protect the public and workers from the potential hazards of RF emissions due to FCC-regulated portable devices. [1]

The safety limits used for the environmental evaluation measurements are based on the criteria published by the American National Standards Institute (ANSI) for localized specific absorption rate (SAR) in IEEE/ANSI C95.1-1992 Standard for Safety Levels with Respect to Human Exposure to Radio Frequency Electromagnetic Fields, 3 kHz to 300 GHz [3] and Health Canada RF Exposure Guidelines Safety Code 6 [24]. The measurement procedure described in IEEE/ANSI C95.3-2002 Recommended Practice for the Measurement of Potentially Hazardous Electromagnetic Fields - RF and Microwave [4] is used for guidance in measuring the Specific Absorption Rate (SAR) due to the RF radiation exposure from the Equipment Under Test (EUT). These criteria for SAR evaluation are similar to those recommended by the International Committee for Non-Ionizing Radiation Protection (ICNIRP) in Biological Effects and Exposure Criteria for Radiofrequency Electromagnetic Fields," Report No. Vol 74. SAR is a measure of the rate of energy absorption due to exposure to an RF transmitting source. SAR values have been related to threshold levels for potential biological hazards.

### 2.1 SAR Definition

Specific Absorption Rate is defined as the time derivative (rate) of the incremental energy (dU) absorbed by (dissipated in) an incremental mass (dm) contained in a volume element (dV) of a given density ( $\rho$ ). It is also defined as the rate of RF energy absorption per unit mass at a point in an absorbing body (see Equation 2-1).

Equation 2-1  
SAR Mathematical Equation

$$SAR = \frac{d}{dt} \left( \frac{dU}{dm} \right) = \frac{d}{dt} \left( \frac{dU}{\rho dV} \right)$$

SAR is expressed in units of Watts per Kilogram (W/kg).

$$SAR = \frac{\sigma \cdot E^2}{\rho}$$

where:

- $\sigma$  = conductivity of the tissue-simulating material (S/m)
- $\rho$  = mass density of the tissue-simulating material (kg/m<sup>3</sup>)
- E = Total RMS electric field strength (V/m)

NOTE: The primary factors that control rate of energy absorption were found to be the wavelength of the incident field in relation to the dimensions and geometry of the irradiated organism, the orientation of the organism in relation to the polarity of field vectors, the presence of reflecting surfaces, and whether conductive contact is made by the organism with a ground plane.[6]

FCC ID: N7NMC8355 (Integrated in Panasonic CF-H2mk2)	 PCTEST ENGINEERING LABORATORY, INC.	SAR EVALUATION REPORT	Reviewed by: Quality Manager
Document S/N: 0Y1206280880.N7N	Test Dates: 05/15/12 - 05/21/12	DUT Type: Module in Portable Tablet Computer	Page 5 of 26

## 3 SAR MEASUREMENT SETUP

### 3.1 Automated SAR Measurement System

Measurements are performed using the DASY automated dosimetric SAR assessment system. The DASY is made by Schmid & Partner Engineering AG (SPEAG) in Zurich, Switzerland and consists of a high precision robotics system (Staubli), robot controller, desktop computer, near-field probe, probe alignment sensor, and the SAM phantom containing the head or body equivalent material. The robot is a six-axis industrial robot, performing precise movements to position the probe to the location (points) of maximum electromagnetic field (EMF). See [www.speag.com](http://www.speag.com) for more information about the specification of the SAR assessment system.



**Figure 3-1**  
SAR Measurement System



**Figure 3-2**  
Near-Field Probe

**Table 3-1**  
Composition of the Tissue Equivalent Matter

Frequency (MHz)	835	1750	1900
Tissue	Body	Body	Body
Ingredients (% by weight)			
Bactericide	0.1		
DGBE		31	29.44
HEC	1		
NaCl	0.94	0.2	0.39
Sucrose	44.9		
Water	53.06	68.8	70.17

<b>FCC ID:</b> N7NMC8355 (Integrated in Panasonic CF-H2mk2)	 <b>PCTEST</b> ENGINEERING LABORATORY, INC.	<b>SAR EVALUATION REPORT</b>	<b>Reviewed by:</b> Quality Manager
<b>Document S/N:</b> 0Y1206280880.N7N	<b>Test Dates:</b> 05/15/12 - 05/21/12	<b>DUT Type:</b> Module in Portable Tablet Computer	Page 6 of 26

## 4 DOSIMETRIC ASSESSMENT

### 4.1 Measurement Procedure

The evaluation was performed using the following procedure:

1. The SAR distribution at the exposed side of the head or body was measured at a distance no greater than 5.0 mm from the inner surface of the shell. The area covered the entire dimension of the device-head interface and the horizontal grid resolution was 15mm and 15mm for frequencies < 3 GHz in the x and y directions respectively. When applicable, for frequencies above 3 GHz, a 10 mm by 10 mm resolution was used.
2. The point SAR measurement was taken at the maximum SAR region determined from Step 1 to enable the monitoring of SAR fluctuations/drifts during the 1 gram cube evaluation. SAR at this fixed point was measured and used as a reference value.
3. Based on the area scan data, the peak area of the maximum absorption was determined by spline interpolation. Around this point, a volume of 32mm x 32mm x 30mm (fine resolution volume scan, zoom scan) was assessed by measuring at least 5 x 5 x 7 points. On this basis of this data set, the spatial peak SAR value was evaluated with the following procedure (see references or the DASy manual online for more details):
  - a. The data was extrapolated to the surface of the outer-shell of the phantom. The combined distance extrapolated was the combined distance from the center of the dipoles 2.7mm away from the tip of the probe housing plus the 1.2 mm distance between the surface and the lowest measuring point. The extrapolation was based on a least-squares algorithm. A polynomial of the fourth order was calculated through the points in the z-axis (normal to the phantom shell).
  - b. After the maximum interpolated values were calculated between the points in the cube, the SAR was averaged over the spatial volume (1g or 10g) using a 3D-Spline interpolation algorithm. The 3D-spline is composed of three one-dimensional splines with the “Not a knot” condition (in x, y, and z directions). The volume was then integrated with the trapezoidal algorithm. One thousand points (10 x 10 x 10) were obtained through interpolation, in order to calculate the averaged SAR.
  - c. All neighboring volumes were evaluated until no neighboring volume with a higher average value was found.
4. The SAR reference value, at the same location as step 2, was re-measured after the zoom scan was complete to calculate the SAR drift. If the drift deviated by more than 5%, the SAR test and drift measurements were repeated.

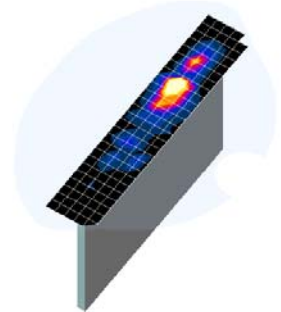

**Figure 4-1**  
**Sample SAR Area Scan**

<b>FCC ID:</b> N7NMC8355 (Integrated in Panasonic CF-H2mk2)		<b>SAR EVALUATION REPORT</b>	<b>Reviewed by:</b> Quality Manager
<b>Document S/N:</b> 0Y1206280880.N7N	<b>Test Dates:</b> 05/15/12 - 05/21/12	<b>DUT Type:</b> Module in Portable Tablet Computer	Page 7 of 26

## 5 TABLET SAR TESTING

### 5.1 SAR Testing for Tablet per KDB Publication 447498 Section 4

Lap-touching devices that have transmitting antennas located less than 20 cm from the body of the user require routine SAR evaluation. Such devices are considered portable, and are capable of being held to the body. Devices are to be setup according to KDB publication 447498 requirements and are configured with maximum output power during SAR assessment for a worst-case SAR evaluation.

Per KDB 447498 4) b) i), the bottom face (back of the device) is required to be tested touching the flat phantom.

Per KDB Publication 447498 4) b) ii) (2), SAR testing applies for the tablet edges with antennas located within 5 cm of each tablet edge closest to the user. According to KDB Publication 447498 4) b) ii) (2), for each antenna, SAR is only required for the edge with the most conservative exposure condition.

Since the diagonal dimension of the device is more than 20 cm (36.8 cm), this device is a tablet (not a mini-tablet).

<b>FCC ID:</b> N7NMC8355 (Integrated in Panasonic CF-H2mk2)		<b>SAR EVALUATION REPORT</b>	<b>Reviewed by:</b> Quality Manager
<b>Document S/N:</b> 0Y1206280880.N7N	<b>Test Dates:</b> 05/15/12 - 05/21/12	<b>DUT Type:</b> Module in Portable Tablet Computer	Page 8 of 26



## 6 FCC RF EXPOSURE LIMITS

### 6.1 Uncontrolled Environment

UNCONTROLLED ENVIRONMENTS are defined as locations where there is the exposure of individuals who have no knowledge or control of their exposure. The general population/uncontrolled exposure limits are applicable to situations in which the general public may be exposed or in which persons who are exposed as a consequence of their employment may not be made fully aware of the potential for exposure or cannot exercise control over their exposure. Members of the general public would come under this category when exposure is not employment-related; for example, in the case of a wireless transmitter that exposes persons in its vicinity.

### 6.2 Controlled Environment

CONTROLLED ENVIRONMENTS are defined as locations where there is exposure that may be incurred by persons who are aware of the potential for exposure, (i.e. as a result of employment or occupation). In general, occupational/controlled exposure limits are applicable to situations in which persons are exposed as a consequence of their employment, who have been made fully aware of the potential for exposure and can exercise control over their exposure. This exposure category is also applicable when the exposure is of a transient nature due to incidental passage through a location where the exposure levels may be higher than the general population/uncontrolled limits, but the exposed person is fully aware of the potential for exposure and can exercise control over his or her exposure by leaving the area or by some other appropriate means.

**Table 6-1**  
**SAR Human Exposure Specified in ANSI/IEEE C95.1-1992 and Health Canada Safety Code 6**

HUMAN EXPOSURE LIMITS		
	UNCONTROLLED ENVIRONMENT <i>General Population</i> (W/kg) or (mW/g)	CONTROLLED ENVIRONMENT <i>Occupational</i> (W/kg) or (mW/g)
SPATIAL PEAK SAR Brain	1.6	8.0
SPATIAL AVERAGE SAR Whole Body	0.08	0.4
SPATIAL PEAK SAR Hands, Feet, Ankles, Wrists	4.0	20

1. The Spatial Peak value of the SAR averaged over any 1 gram of tissue (defined as a tissue volume in the shape of a cube) and over the appropriate averaging time.
2. The Spatial Average value of the SAR averaged over the whole body.
3. The Spatial Peak value of the SAR averaged over any 10 grams of tissue (defined as a tissue volume in the shape of a cube) and over the appropriate averaging time.

FCC ID: N7NMC8355 (Integrated in Panasonic CF-H2mk2)	 PCTEST ENGINEERING LABORATORY, INC.	SAR EVALUATION REPORT	Reviewed by: Quality Manager
Document S/N: 0Y1206280880.N7N	Test Dates: 05/15/12 - 05/21/12	DUT Type: Module in Portable Tablet Computer	Page 9 of 26

## 7 FCC MEASUREMENT PROCEDURES

Power measurements were performed using a base station simulator under digital average power.

### 7.1 Procedures Used to Establish RF Signal for SAR

The following procedures are according to FCC KDB Publication 941225 D01 "SAR Measurement Procedures for 3G Devices" v02, October 2007.

The device was placed into a simulated call using a base station simulator in a RF shielded chamber. Establishing connections in this manner ensure a consistent means for testing SAR and are recommended for evaluating SAR [4]. Devices under test were evaluated prior to testing, with a fully charged battery and were configured to operate at maximum output power. In order to verify that the device was tested throughout the SAR test at maximum output power, the SAR measurement system measures a "point SAR" at an arbitrary reference point at the start and end of the 1 gram SAR evaluation, to assess for any power drifts during the evaluation. If the power drift deviated by more than 5%, the SAR test and drift measurements were repeated.

### 7.2 SAR Measurement Conditions for CDMA2000

The following procedures were performed according to FCC KDB Publication 941225 D01 "SAR Measurement Procedures for 3G Devices" v02, October 2007.

#### 7.2.1 Output Power Verification

See 3GPP2 C.S0011/TIA-98-E as recommended by "SAR Measurement Procedures for 3G Devices" v02, October 2007. Maximum output power is verified on the High, Middle and Low channels according to procedures in section 4.4.5.2 of 3GPP2 C.S0011/TIA-98-E. Tests were measured with power control bits in the "All Up" condition.

1. If the mobile station (MS) supports Reverse TCH RC 1 and Forward TCH RC 1, set up a call using Fundamental Channel Test Mode 1 (RC=1/1) with 9600 bps data rate only.
2. Under RC1, C.S0011 Table 4.4.5.2-1, Table 7-1 parameters were applied.
3. If the MS supports the RC 3 Reverse FCH, RC3 Reverse SCH<sub>0</sub> and demodulation of RC 3,4, or 5, set up a call using Supplemental Channel Test Mode 3 (RC 3/3) with 9600 bps Fundamental Channel and 9600 bps SCH0 data rate.
4. Under RC3, C.S0011 Table 4.4.5.2-2, Table 7-2 was applied.
5. FCHs were configured at full rate for maximum SAR with "All Up" power control bits.

**Table 7-1**  
Parameters for Max. Power for RC1

Parameter	Units	Value
$I_{or}$	dBm/1.23 MHz	-104
$\frac{Pilot E_c}{I_{or}}$	dB	-7
$\frac{Traffic E_c}{I_{or}}$	dB	-7.4

**Table 7-2**  
Parameters for Max. Power for RC3

Parameter	Units	Value
$I_{or}$	dBm/1.23 MHz	-86
$\frac{Pilot E_c}{I_{or}}$	dB	-7
$\frac{Traffic E_c}{I_{or}}$	dB	-7.4

#### 7.2.2 Body SAR Measurements for EVDO Data Devices

Body SAR is measured using Subtype 0/1 Physical Layer configurations for Rev. 0 per KDB Publication 941225 D01 procedures for "1x Ev-Do data Devices". SAR for Subtype 2 Physical layer configurations is not required for Rev. A when the maximum average output of each RF channels is less than that measured in Subtype 0/1 Physical layer configurations. Otherwise,

FCC ID: N7NMC8355 (Integrated in Panasonic CF-H2mk2)		SAR EVALUATION REPORT	Reviewed by: Quality Manager
Document S/N: 0Y1206280880.N7N	Test Dates: 05/15/12 - 05/21/12	DUT Type: Module in Portable Tablet Computer	Page 10 of 26

SAR is measured on the maximum output channel for Rev. A using the exposure configuration that results in the highest SAR for the RF channels in Rev. 0. The AT is tested with a Reverse Data Channel rate of 153.6 kbps in Subtype 0/1 Physical Layer configurations; and a Reverse Data Channel payload size of 4096 bits and Termination Target of 16 slots in Subtype 2 Physical Layer configurations. Both FTAP and FETAP are configured with a Forward Traffic Channel data rate corresponding to the 2-slot version of 307.2 kbps with the ACK Channel transmitting in all slots. AT power control should be in "All Bits Up" conditions for TAP/ETAP

SAR is not required for 1x RTT for Ev-Do devices that also support 1x RTT voice and/or data operations, when the maximum average output of each channel is less than 1/4 dB higher than that measured in Subtype 0/1 Physical Layer configurations for Rev. 0. Otherwise, CDMA "Body-SAR Measurement" procedures for "CDMA 2000 1x Handsets" were applied.

### 7.3 SAR Measurement Conditions for WCDMA

#### 7.3.1 Output Power Verification

Maximum output power is measured on the High, Middle and Low channels for each applicable transmission band according to the general descriptions in section 5.2 of 3GPP TS 34.121, using the appropriate RMC or AMR with TPC (transmit power control) set to all "1s".

Maximum output power is verified on the High, Middle and Low channels according to the general descriptions in section 5.2 of 3GPP TS 34.121 (release 5), using the appropriate RMC with TPC (transmit power control) set to all "1s". Results for all applicable physical channel configurations (DPCCH, DPDCHn and spreading codes, HS-DPCCH) are tabulated in the test report. All configurations that are not supported by the DUT or cannot be measured due to technical or equipment limitations is identified.

#### 7.3.2 Body SAR Measurements

SAR for body exposure configurations is measured using the 12.2 kbps RMC with the TPC bits all "1s".

#### 7.3.3 Procedures Used to Establish RF Signal for SAR HSDPA Data Devices

The following procedures are applicable to HSDPA data devices operating under 3GPP Release 5. Body exposure conditions are typically applicable to these devices, including handsets and data modems operating in various electronic devices. HSDPA operates in conjunction with WCDMA and requires an active DPCCH. The default test configuration is to measure SAR in WCDMA without HSDPA, with an established radio link between the DUT and a communication test set with 12.2 kbps RMC mode configured in Test Loop Mode 1; and tested with HSDPA with FRC and a 12.2 kbps RMC using the highest SAR configuration in WCDMA. SAR is selectively confirmed for other physical channel configurations according to output power, exposure conditions and device operating capabilities. Maximum output power is verified according to 3GPP TS 23.121 (Release 5) and SAR must be measured according to these maximum output conditions.

#### 7.3.4 SAR Measurement Conditions for HSUPA Data Devices

SAR for body exposure configurations are measured according to the 'Body SAR Measurements' procedures in the 'WCDMA Handsets' section of the KDB 941225 D01 FCC 3G document. In addition, Body SAR is also measured for HSPA when the maximum average output of each RF

FCC ID: N7NMC8355 (Integrated in Panasonic CF-H2mk2)		SAR EVALUATION REPORT	Reviewed by: Quality Manager
Document S/N: 0Y1206280880.N7N	Test Dates: 05/15/12 - 05/21/12	DUT Type: Module in Portable Tablet Computer	Page 11 of 26

channel with HSPA active is at least ¼ dB higher of that measured without HSPA in 12.2 kbps RMC mode or the maximum SAR for 12.2 kbps RMC is above 75% of the SAR limit. Body SAR for HSPA is measured with E-DCH Sub-test 5, using H-Set 1 and QPSK for FRC and a 12.2 kbps RMC configured in Test Loop Mode 1 with power control algorithm 2, according to the highest body SAR configuration in 12.2 kbps RMC without HSPA. When VOIP is applicable for head exposure, SAR is not required when the maximum output of each RF channel with HSPA is less than ¼ dB higher than that measured using 12.2 kbps RMC; otherwise, the same HSPA configuration used for body measurements should be used to test for head exposure.

Due to inner loop power control requirements in HSPA, a commercial communication test set should be used for the output power and SAR tests. The 12.2 kbps RMC, FRC H-set 1 and EDCH configurations for HSPA should be configured according to the  $\beta$  values indicated below as well as other applicable procedures described in the 'WCDMA Handset' and 'Release 5 HSDPA Data Devices' sections of the FCC 3G document.

Sub-test	$\beta_c$	$\beta_d$	$\beta_d$ (SF)	$\beta_c/\beta_d$	$\beta_{hs}^{(1)}$	$\beta_{ec}$	$\beta_{ed}$	$\beta_{ed}$ (SF)	$\beta_{ed}$ (codes)	CM <sup>(2)</sup> (dB)	MPR (dB)	AG <sup>(4)</sup> Index	E-TFCI
1	11/15 <sup>(3)</sup>	15/15 <sup>(3)</sup>	64	11/15 <sup>(3)</sup>	22/15	209/225	1039/225	4	1	1.0	0.0	20	75
2	6/15	15/15	64	6/15	12/15	12/15	94/75	4	1	3.0	2.0	12	67
3	15/15	9/15	64	15/9	30/15	30/15	$\beta_{d1}: 47/15$ $\beta_{ed}: 47/15$	4	2	2.0	1.0	15	92
4	2/15	15/15	64	2/15	4/15	2/15	56/75	4	1	3.0	2.0	17	71
5	15/15 <sup>(4)</sup>	15/15 <sup>(4)</sup>	64	15/15 <sup>(4)</sup>	30/15	24/15	134/15	4	1	1.0	0.0	21	81

Note 1:  $\Delta_{ACK}, \Delta_{NACK}$  and  $\Delta_{CQI} = 8 \Leftrightarrow A_{15} = \beta_{15}/\beta_c = 30/15 \Leftrightarrow \beta_{15} = 30/15 * \beta_c$ .

Note 2: CM = 1 for  $\beta_c/\beta_d = 12/15, \beta_{15}/\beta_c = 24/15$ . For all other combinations of DPDCH, DPCCH, HS-DPCCH, E-DPDCH and E-DPCCH the MPR is based on the relative CM difference.

Note 3: For subtest 1 the  $\beta_c/\beta_d$  ratio of 11/15 for the TFC during the measurement period (TF1, TF0) is achieved by setting the signaled gain factors for the reference TFC (TF1, TF1) to  $\beta_c = 10/15$  and  $\beta_d = 15/15$ .

Note 4: For subtest 5 the  $\beta_c/\beta_d$  ratio of 15/15 for the TFC during the measurement period (TF1, TF0) is achieved by setting the signaled gain factors for the reference TFC (TF1, TF1) to  $\beta_c = 14/15$  and  $\beta_d = 15/15$ .

Note 5: Testing UE using E-DPDCH Physical Layer category 1 Sub-test 3 is not required according to TS 25.306 Table 5.1g.

Note 6:  $\beta_{ed}$  can not be set directly; it is set by Absolute Grant Value.

FCC ID: N7NMC8355 (Integrated in Panasonic CF-H2mk2)	 PCTEST ENGINEERING LABORATORY, INC.	SAR EVALUATION REPORT	Reviewed by: Quality Manager
Document S/N: 0Y1206280880.N7N	Test Dates: 05/15/12 - 05/21/12	DUT Type: Module in Portable Tablet Computer	Page 12 of 26

## 8 RF CONDUCTED POWERS

### 8.1 CDMA Conducted Powers

Band	Channel	Frequency	TDSO SO32 [dBm]	TDSO SO32 [dBm]	1x EvDO Rev. 0 [dBm]	1x EvDO Rev. A [dBm]
	F-RC	MHz	FCH+SCH	FCH	(RTAP)	(RETAP)
Cellular	1013	824.7	24.61	24.62	24.77	24.69
	384	836.52	24.42	24.47	24.56	24.42
	777	848.31	24.48	24.55	24.64	24.54
PCS	25	1851.25	24.56	24.69	24.80	24.71
	600	1880	24.75	24.78	24.96	24.82
	1175	1908.75	24.64	24.75	24.79	24.74

Per KDB Publication 941225 D01:

1. Body SAR was evaluated with EVDO Rev 0. SAR was not required for 1x RTT, because the maximum average output of each channel is less than 1/4 dB higher than that measured in Subtype 0/1 Physical Layer configurations for Rev. 0. SAR for Subtype 2 Physical layer configurations was not required for Rev. A because the maximum average output of each RF channel is less than that measured in Subtype 0/1 Physical layer configurations.



**Figure 8-1**  
**Power Measurement Setup**

<b>FCC ID:</b> N7NMC8355 (Integrated in Panasonic CF-H2mk2)		<b>SAR EVALUATION REPORT</b>	<b>Reviewed by:</b> Quality Manager
<b>Document S/N:</b> 0Y1206280880.N7N	<b>Test Dates:</b> 05/15/12 - 05/21/12	<b>DUT Type:</b> Module in Portable Tablet Computer	Page 13 of 26

## 8.2 GSM Conducted Powers

		Maximum Burst-Averaged Output Power			
		GPRS/EDGE Data (GMSK)		EDGE Data (8-PSK)	
Band	Channel	GPRS [dBm] 1 Tx Slot	GPRS [dBm] 2 Tx Slot	EDGE [dBm] 1 Tx Slot	EDGE [dBm] 2 Tx Slot
Cellular	128	32.92	<b>32.78</b>	26.94	26.77
	190	32.98	<b>32.90</b>	26.87	26.62
	251	33.07	<b>32.75</b>	26.73	26.53
PCS	512	29.98	<b>29.93</b>	25.90	25.80
	661	29.80	<b>29.72</b>	25.88	25.72
	810	29.83	<b>29.74</b>	25.82	25.78

		Calculated Maximum Frame-Averaged Output Power			
		GPRS/EDGE Data (GMSK)		EDGE Data (8-PSK)	
Band	Channel	GPRS [dBm] 1 Tx Slot	GPRS [dBm] 2 Tx Slot	EDGE [dBm] 1 Tx Slot	EDGE [dBm] 2 Tx Slot
Cellular	128	23.89	<b>26.76</b>	17.91	20.75
	190	23.95	<b>26.88</b>	17.84	20.60
	251	24.04	<b>26.73</b>	17.70	20.51
PCS	512	20.95	<b>23.91</b>	16.87	19.78
	661	20.77	<b>23.70</b>	16.85	19.70
	810	20.80	<b>23.72</b>	16.79	19.76

Note: Both burst-averaged and calculated frame-averaged powers are included. Frame-averaged power was calculated from the measured burst-averaged power by converting the slot powers into linear units and calculating the energy over 8 timeslots.

The bolded GPRS modes were selected according to the highest frame-averaged output power table according to KDB 941225 D03.

CS1 coding scheme was used in GPRS output power measurements and SAR Testing, as a condition where GMSK modulation was ensured. It was investigated that CS1 - CS4 settings do not have any impact on the output levels in the GPRS modes.

MCS7 coding scheme was used to measure the output powers for EDGE since it was investigated that choosing MCS7 coding scheme will ensure 8-PSK modulation. It was investigated that MCS settings producing 8PSK Modulation do not impact on the output powers in EDGE mode.

**GSM Class:** C (Data only)  
**GPRS Multislot class:** 10 (max 2 Tx Uplink slots)  
**EDGE Multislot class:** 10 (max 2Tx Uplink slots)  
**DTM Multislot Class:** N/A



**Figure 8-2**  
**Power Measurement Setup**

FCC ID: N7NMC8355 (Integrated in Panasonic CF-H2mk2)	 <b>PCTEST</b> ENGINEERING LABORATORY, INC.	<b>SAR EVALUATION REPORT</b>	<b>Reviewed by:</b> Quality Manager
<b>Document S/N:</b> 0Y1206280880.N7N	<b>Test Dates:</b> 05/15/12 - 05/21/12	<b>DUT Type:</b> Module in Portable Tablet Computer	Page 14 of 26

### 8.3 HSPA Conducted Powers

3GPP Release Version	Mode	3GPP 34.121 Subtest	Cellular Band [dBm]			AWS Band [dBm]			PCS Band [dBm]			MPR [dB]
			4132	4183	4233	1312	1412	1862	9262	9400	9538	
99	WCDMA	12.2 kbps RMC	24.40	24.37	24.30	24.53	24.37	24.46	24.55	24.80	24.50	-
6	HSDPA	Subtest 1	23.87	23.90	23.83	24.30	23.87	24.32	24.39	24.40	24.02	0
6		Subtest 2	24.00	23.91	23.69	24.16	24.24	24.05	24.15	24.57	24.21	0
6		Subtest 3	23.40	23.47	23.33	23.80	23.40	23.77	23.60	23.70	23.40	0.5
6		Subtest 4	23.43	23.38	23.17	23.71	23.33	23.76	23.72	23.85	23.60	0.5
6	HSUPA	Subtest 1	23.31	23.92	23.37	23.43	23.30	23.53	23.70	23.85	23.40	0
6		Subtest 2	22.55	22.40	22.11	22.10	22.72	22.50	22.55	22.78	22.42	2
6		Subtest 3	22.38	22.40	22.28	22.42	22.50	22.38	22.66	23.00	22.62	1
6		Subtest 4	22.40	22.30	22.47	22.56	22.78	22.89	23.15	23.01	22.84	2
6		Subtest 5	23.75	23.61	23.36	23.80	23.52	23.69	23.46	23.84	23.67	0

WCDMA SAR was tested under RMC 12.2 kbps with HSPA Inactive per KDB Publication 941225 D01. HSPA SAR was not required since the average output power of the HSPA subtests was not more than 0.25 dB higher than the RMC level and SAR was less than 1.2 W/kg.



**Figure 8-3**  
**Power Measurement Setup**

<b>FCC ID:</b> N7NMC8355 (Integrated in Panasonic CF-H2mk2)		<b>SAR EVALUATION REPORT</b>	<b>Reviewed by:</b> Quality Manager
<b>Document S/N:</b> 0Y1206280880.N7N	<b>Test Dates:</b> 05/15/12 - 05/21/12	<b>DUT Type:</b> Module in Portable Tablet Computer	Page 15 of 26

## 9 SYSTEM VERIFICATION

### 9.1 Tissue Verification

**Table 9-1  
Measured Tissue Properties**

Calibrated for Tests Performed on:	Tissue Type	Tissue Temp During Calibration (C°)	Measured Frequency (MHz)	Measured Conductivity, $\sigma$ (S/m)	Measured Dielectric Constant, $\epsilon$	TARGET Conductivity, $\sigma$ (S/m)	TARGET Dielectric Constant, $\epsilon$	% dev $\sigma$	% dev $\epsilon$
05/15/2012	835B	22.2	820	0.969	53.43	0.969	55.284	0.00%	-3.35%
			835	0.975	53.12	0.970	55.200	0.52%	-3.77%
			850	0.988	53.21	0.988	55.154	0.00%	-3.52%
05/21/2012	835B	22.8	820	0.955	53.19	0.969	55.284	-1.44%	-3.79%
			835	0.972	52.99	0.970	55.200	0.21%	-4.00%
			850	0.986	52.95	0.988	55.154	-0.20%	-4.00%
05/21/2012	1750B	22.6	1710	1.465	52.85	1.460	53.540	0.34%	-1.29%
			1750	1.508	52.56	1.490	53.430	1.21%	-1.63%
			1790	1.564	52.20	1.510	53.330	3.58%	-2.12%
05/15/2012	1900B	23.0	1850	1.475	51.89	1.520	53.300	-2.96%	-2.65%
			1880	1.511	51.79	1.520	53.300	-0.59%	-2.83%
			1910	1.538	51.77	1.520	53.300	1.18%	-2.87%
05/16/2012	1900B	22.5	1850	1.466	51.09	1.520	53.300	-3.55%	-4.15%
			1880	1.502	50.96	1.520	53.300	-1.18%	-4.39%
			1910	1.534	50.88	1.520	53.300	0.92%	-4.54%

The above measured tissue parameters were used in the DASY software to perform interpolation via the DASY software to determine actual dielectric parameters at the test frequencies (per IEEE 1528 6.6.1.2). The SAR test plots may slightly differ from the table above since the DASY software rounds to three significant digits.

### 9.2 Measurement Procedure for Tissue verification

- 1) The network analyzer and probe system was configured and calibrated.
- 2) The probe was immersed in the sample which was placed in a nonmetallic container. Trapped air bubbles beneath the flange were minimized by placing the probe at a slight angle.
- 3) The complex admittance with respect to the probe aperture was measured
- 4) The complex relative permittivity  $\epsilon$  can be calculated from the below equation (Pournaropoulos and Misra):

$$Y = \frac{j2\omega\epsilon_r\epsilon_0}{[\ln(b/a)]^2} \int_a^b \int_a^b \int_0^\pi \cos\phi' \frac{\exp[-j\omega r(\mu_0\epsilon_r\epsilon_0)^{1/2}]}{r} d\phi' d\rho' d\rho$$

where Y is the admittance of the probe in contact with the sample, the primed and unprimed coordinates refer to source and observation points, respectively,  $r^2 = \rho^2 + \rho'^2 - 2\rho\rho' \cos\phi'$ ,  $\omega$  is the angular frequency, and  $j = \sqrt{-1}$ .

FCC ID: N7NMC8355 (Integrated in Panasonic CF-H2mk2)	 PCTEST ENGINEERING LABORATORY, INC.	<b>SAR EVALUATION REPORT</b>	Reviewed by: Quality Manager
Document S/N: 0Y1206280880.N7N	Test Dates: 05/15/12 - 05/21/12	DUT Type: Module in Portable Tablet Computer	Page 16 of 26



### 9.3 Test System Verification

Prior to assessment, the system is verified to  $\pm 10\%$  of the manufacturer SAR measurement on the reference dipole at the time of calibration.

**Table 9-2  
System Verification Results**

System Verification TARGET & MEASURED												
Tissue Frequency (MHz)	Tissue Type	Date:	Amb. Temp (°C)	Liquid Temp (°C)	Input Power (W)	Dipole SN	Probe SN	Measured SAR <sub>1g</sub> (W/kg)	1 W Target SAR <sub>1g</sub> (W/kg)	1 W Normalized SAR <sub>1g</sub> (W/kg)	Deviation (%)	
835	Body	05/15/2012	23.1	21.8	0.100	4d026	3258	0.982	9.660	9.820	1.66%	
835	Body	05/21/2012	23.9	22.4	0.250	4d047	3561	2.47	9.410	9.880	4.99%	
1750	Body	05/21/2012	24.5	22.6	0.100	1051	3022	3.72	37.600	37.200	-1.06%	
1900	Body	05/15/2012	24.2	22.7	0.100	5d080	3209	4.17	40.900	41.700	1.96%	
1900	Body	05/16/2012	24.3	23.2	0.100	5d149	3561	4.18	39.300	41.800	6.36%	

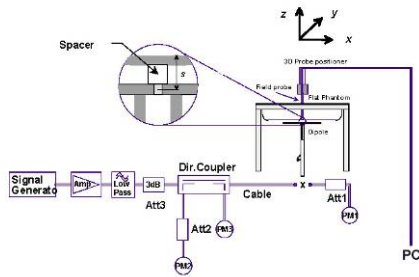

**Figure 9-1  
System Verification Setup Diagram**



**Figure 9-2  
System Verification Setup Photo**

FCC ID: N7NMC8355 (Integrated in Panasonic CF-H2mk2)	 PCTEST ENGINEERING LABORATORY, INC.	SAR EVALUATION REPORT	Reviewed by: Quality Manager
Document S/N: 0Y1206280880.N7N	Test Dates: 05/15/12 - 05/21/12	DUT Type: Module in Portable Tablet Computer	Page 17 of 26

# 10 SAR DATA SUMMARY

## 10.1 Standalone Body SAR Data

**Table 10-1  
Licensed Transmitter Body SAR Data**

MEASUREMENT RESULTS										
FREQUENCY		Mode	Service	Conducted Power [dBm]	Power Drift [dB]	Spacing	Device Serial Number	# of GPRS Slots	Side	SAR (1g)
MHz	Ch.									(W/kg)
836.60	190	GSM 850	GPRS	32.90	-0.03	0.0 cm	2DKSA00138	2	back	0.202
836.60	190	GSM 850	GPRS	32.90	-0.06	0.0 cm	2DKSA00138	2	top	0.163
836.60	190	GSM 850	GPRS	32.90	-0.02	0.0 cm	2DKSA00138	2	left	0.774
836.60	4183	WCDMA 850	RMC	24.37	0.01	0.0 cm	2DKSA00138	N/A	back	0.098
836.60	4183	WCDMA 850	RMC	24.37	0.02	0.0 cm	2DKSA00138	N/A	top	0.079
836.60	4183	WCDMA 850	RMC	24.37	-0.03	0.0 cm	2DKSA00138	N/A	left	0.373
836.52	384	Cell. CDMA	EVDO Rev. 0	24.56	0.06	0.0 cm	2DKSA00138	N/A	back	0.071
836.52	384	Cell. CDMA	EVDO Rev. 0	24.56	0.15	0.0 cm	2DKSA00138	N/A	top	0.079
836.52	384	Cell. CDMA	EVDO Rev. 0	24.56	-0.16	0.0 cm	2DKSA00138	N/A	left	0.392
1730.40	1412	AWS WCDMA	RMC	24.37	-0.17	0.0 cm	2DKSA00138	N/A	back	0.132
1730.40	1412	AWS WCDMA	RMC	24.37	0.03	0.0 cm	2DKSA00138	N/A	top	0.124
1730.40	1412	AWS WCDMA	RMC	24.37	0.09	0.0 cm	2DKSA00138	N/A	left	0.223
1880.00	661	GSM 1900	GPRS	29.72	0.02	0.0 cm	2DKSA00138	2	back	0.104
1880.00	661	GSM 1900	GPRS	29.72	-0.07	0.0 cm	2DKSA00138	2	top	0.099
1880.00	661	GSM 1900	GPRS	29.72	-0.19	0.0 cm	2DKSA00138	2	left	0.062
1880.00	9400	WCDMA 1900	RMC	24.80	0.01	0.0 cm	2DKSA00138	N/A	back	0.147
1880.00	9400	WCDMA 1900	RMC	24.80	0.01	0.0 cm	2DKSA00138	N/A	top	0.157
1880.00	9400	WCDMA 1900	RMC	24.80	0.13	0.0 cm	2DKSA00138	N/A	left	0.088
1880.00	600	PCS CDMA	EVDO Rev. 0	24.96	-0.02	0.0 cm	2DKSA00138	N/A	back	0.133
1880.00	600	PCS CDMA	EVDO Rev. 0	24.96	0.06	0.0 cm	2DKSA00138	N/A	top	0.117
1880.00	600	PCS CDMA	EVDO Rev. 0	24.96	-0.12	0.0 cm	2DKSA00138	N/A	left	0.131
<b>ANSI / IEEE C95.1 1992 - SAFETY LIMIT</b>						<b>Body</b>				
<b>Spatial Peak</b>						<b>1.6 W/kg (mW/g)</b>				
<b>Uncontrolled Exposure/General Population</b>						<b>averaged over 1 gram</b>				

<b>FCC ID:</b> N7NMC8355 (Integrated in Panasonic CF-H2mk2)		<b>SAR EVALUATION REPORT</b>	<b>Reviewed by:</b> Quality Manager
<b>Document S/N:</b> 0Y1206280880.N7N	<b>Test Dates:</b> 05/15/12 - 05/21/12	<b>DUT Type:</b> Module in Portable Tablet Computer	Page 18 of 26

## 10.2 SAR Test Notes

### General Notes:

1. The test data reported are the worst-case SAR value with the position set in a typical configuration. Test procedures used were according to FCC KDB 447498 Section 4.
2. Batteries are fully charged for all readings.
3. Tissue parameters and temperatures are listed on the SAR plots.
4. Liquid tissue depth was at least 15.0 cm. To confirm the proper SAR liquid depth, the z-axis plots from the system verifications were included since the system verifications were performed using the same liquid, probe and DAE as the SAR tests in the same time period.
5. Per KDB 447498, if the SAR measured at the middle channel for each test configuration is at least 3.0 dB lower than the SAR limit, testing at the high and low channels is optional for such test configuration(s).
6. The manufacturer has confirmed that the device(s) tested have the same physical, mechanical and thermal characteristics and are within operational tolerances expected for production units.
7. Per KDB Publication 447498 4) b) i) the back side is required to be tested touching the flat phantom for large sized tablet devices.
8. Per KDB 447498 4) b) ii) (2), SAR testing applies for the tablet edges with antennas located within 5 cm of each tablet edge closest to the user. According to KDB 447498 4) b) ii) (2), for each antenna, SAR is required for the edge with the most conservative exposure condition.

### GPRS/EDGE Test Notes:

1. Justification for reduced test configurations per KDB Publication 941225 D03: The source-based time-averaged output power was evaluated for all multi-slot operations. The worst-case configuration was evaluated for SAR.

### CDMA Notes:

1. Body SAR is measured using Subtype 0/1 Physical Layer configurations for Rev. 0 according to KDB 941225 D01 procedures for data devices. If the average output power of Subtype 2 for Rev. A is less than the Rev. 0 power levels, then Rev. A SAR is not required. Otherwise, SAR is measured on the maximum output channel for Rev. A using the exposure configuration that results in the highest SAR for that RF channel in Rev. 0. SAR is not required for 1x RTT for EvDo hotspot devices when the maximum average output of each channel is less than 1/4 dB higher than that measured in Subtype 0/1 Physical Layer configurations for Rev. 0.

### WCDMA Notes:

1. WCDMA mode in Body SAR was tested under RMC 12.2 kbps with HSPA Inactive per KDB Publication 941225 D01. HSPA SAR was not required since the average output power of the HSPA subtests was not more than 0.25 dB higher than the RMC level and SAR was less than 1.2 W/kg.
2. AWS WCDMA SAR was measured with a probe calibrated at 1750 MHz and is valid for measuring SAR from  $\pm 50$  MHz. The 1750MHz specific liquid was verified with specific probe calibration factors as required per FCC KDB Publication 450824 D01.

<b>FCC ID:</b> N7NMC8355 (Integrated in Panasonic CF-H2mk2)		<b>SAR EVALUATION REPORT</b>	<b>Reviewed by:</b> Quality Manager
<b>Document S/N:</b> 0Y1206280880.N7N	<b>Test Dates:</b> 05/15/12 - 05/21/12	<b>DUT Type:</b> Module in Portable Tablet Computer	Page 19 of 26

# 11 FCC MULTI-TX AND ANTENNA SAR CONSIDERATIONS: WWAN + 2.4 GHZ

This device uses a separate module for the WLAN/Bluetooth transmitter. Please refer to the WLAN and Bluetooth Report for WLAN SAR Data filed under FCC ID: ACJ9TGWL12A. It has been confirmed that the installation of this module provides more than 12mm from the antenna to the user; therefore, the maximum SAR value from the original certification [0.399 W/kg] is used for simultaneous transmission purposes.

The separation distance between the WWAN antenna and the WLAN/Bluetooth main antenna is 215 mm. The separation distance between the WWAN antenna and the WLAN/Bluetooth sub antenna is 143 mm.

The maximum peak RF conducted power for Bluetooth is 4mW. Per KDB Publication 447498 Bluetooth SAR testing is not required based on the maximum conducted power, the Bluetooth to WWAN and Bluetooth to WLAN antenna separation distances and the body SAR of the WWAN and WLAN antennas.

Simult Tx	Configuration	GPRS 850 SAR (W/kg)	WLAN SAR (W/kg)	$\Sigma$ SAR (W/kg)
Body SAR	Back	0.202	0.399	0.601
	Front	-	0.399	0.399
	Top	0.163	0.399	0.562
	Bottom	-	0.399	0.399
	Right	-	0.399	0.399
	Left	0.774	0.399	<b>1.173</b>
Simult Tx	Configuration	WCDMA 850 SAR (W/kg)	WLAN SAR (W/kg)	$\Sigma$ SAR (W/kg)
Body SAR	Back	0.098	0.399	0.497
	Front	-	0.399	0.399
	Top	0.079	0.399	0.478
	Bottom	-	0.399	0.399
	Right	-	0.399	0.399
	Left	0.373	0.399	<b>0.772</b>
Simult Tx	Configuration	Cell. EVDO SAR (W/kg)	WLAN SAR (W/kg)	$\Sigma$ SAR (W/kg)
Body SAR	Back	0.071	0.399	0.470
	Front	-	0.399	0.399
	Top	0.079	0.399	0.478
	Bottom	-	0.399	0.399
	Right	-	0.399	0.399
	Left	0.392	0.399	<b>0.791</b>

FCC ID: N7NMC8355 (Integrated in Panasonic CF-H2mk2)	 <b>PCTEST</b> ENGINEERING LABORATORY, INC.	<b>SAR EVALUATION REPORT</b>	<b>Reviewed by:</b> Quality Manager
<b>Document S/N:</b> 0Y1206280880.N7N	<b>Test Dates:</b> 05/15/12 - 05/21/12	<b>DUT Type:</b> Module in Portable Tablet Computer	Page 20 of 26

Simult Tx	Configuration	AWS WCDMA SAR (W/kg)	WLAN SAR (W/kg)	$\Sigma$ SAR (W/kg)
Body SAR	Back	0.132	0.399	0.531
	Front	-	0.399	0.399
	Top	0.124	0.399	0.523
	Bottom	-	0.399	0.399
	Right	-	0.399	0.399
	Left	0.223	0.399	<b>0.622</b>
Simult Tx	Configuration	GPRS 1900 SAR (W/kg)	WLAN SAR (W/kg)	$\Sigma$ SAR (W/kg)
Body SAR	Back	0.104	0.399	<b>0.503</b>
	Front	-	0.399	0.399
	Top	0.099	0.399	0.498
	Bottom	-	0.399	0.399
	Right	-	0.399	0.399
	Left	0.062	0.399	0.461
Simult Tx	Configuration	WCDMA 1900 SAR (W/kg)	WLAN SAR (W/kg)	$\Sigma$ SAR (W/kg)
Body SAR	Back	0.147	0.399	0.546
	Front	-	0.399	0.399
	Top	0.157	0.399	<b>0.556</b>
	Bottom	-	0.399	0.399
	Right	-	0.399	0.399
	Left	0.088	0.399	0.487
Simult Tx	Configuration	PCS EVDO SAR (W/kg)	WLAN SAR (W/kg)	$\Sigma$ SAR (W/kg)
Body SAR	Back	0.133	0.399	<b>0.532</b>
	Front	-	0.399	0.399
	Top	0.117	0.399	0.516
	Bottom	-	0.399	0.399
	Right	-	0.399	0.399
	Left	0.131	0.399	0.530

FCC ID: N7NMC8355 (Integrated in Panasonic CF-H2mk2)	 <b>PCTEST</b> ENGINEERING LABORATORY, INC.	<b>SAR EVALUATION REPORT</b>	<b>Reviewed by:</b> Quality Manager
<b>Document S/N:</b> 0Y1206280880.N7N	<b>Test Dates:</b> 05/15/12 - 05/21/12	<b>DUT Type:</b> Module in Portable Tablet Computer	Page 21 of 26

## 12 EQUIPMENT LIST

Manufacturer	Model	Description	Cal Date	Cal Interval	Cal Due	Serial Number
Agilent	8648D	(9kHz-4GHz) Signal Generator	10/10/2011	Annual	10/10/2012	3613A00315
Agilent	E5515C	Wireless Communications Test Set	2/9/2012	Annual	2/9/2013	GB43460554
Agilent	E5515C	Wireless Communications Test Set	2/12/2012	Annual	2/12/2013	GB45360985
Agilent	E5515C	Wireless Communications Test Set	2/14/2012	Annual	2/14/2013	GB43304447
Agilent	E5515C	Wireless Communications Test Set	2/14/2012	Annual	2/14/2013	GB43163447
Agilent	85070E	Dielectric Probe Kit	3/8/2012	Annual	3/8/2013	MY44300633
Agilent	8648D	Signal Generator	4/3/2012	Annual	4/3/2013	3629U00687
Agilent	8753E	(30kHz-6GHz) Network Analyzer	4/3/2012	Annual	4/3/2013	US37390350
Agilent	8753E	(30kHz-6GHz) Network Analyzer	4/4/2012	Annual	4/4/2013	JP38020182
Agilent	E5515C	Wireless Communications Tester	4/4/2012	Annual	4/4/2013	US41140256
Agilent	E8257D	(250kHz-20GHz) Signal Generator	4/5/2012	Annual	4/5/2013	MY45470194
Agilent	8594A	(9kHz-2.9GHz) Spectrum Analyzer	N/A		N/A	3051A00187
Amplifier Research	5S1G4	5W, 800MHz-4.2GHz	CBT	N/A	CBT	21910
Anritsu	ML2438A	Power Meter	10/13/2011	Annual	10/13/2012	1070030
Anritsu	MA2411B	Pulse Sensor	10/13/2011	Annual	10/13/2012	1027293
Anritsu	ML2495A	Power Meter	10/13/2011	Annual	10/13/2012	1039008
Anritsu	MT8820C	Radio Communication Tester	11/11/2011	Annual	11/11/2012	6200901190
Anritsu	MA2481A	Power Sensor	2/14/2012	Annual	2/14/2013	5318
Anritsu	MA2481A	Power Sensor	2/14/2012	Annual	2/14/2013	5442
Anritsu	ML2438A	Power Meter	2/14/2012	Annual	2/14/2013	1190013
COMTECH	AR85729-5/5759B	Solid State Amplifier	CBT	N/A	CBT	M3W1A00-1002
Control Company	61220-416	Long-Stem Thermometer	2/15/2011	Biennial	2/15/2013	111331322
Control Company	61220-416	Long-Stem Thermometer	2/15/2011	Biennial	2/15/2013	111331323
Control Company	61220-416	Long-Stem Thermometer	2/15/2011	Biennial	2/15/2013	111331332
Gigatronics	80701A	(0.05-18GHz) Power Sensor	10/12/2011	Annual	10/12/2012	1833460
Gigatronics	8651A	Universal Power Meter	10/12/2011	Annual	10/12/2012	8650319
Intelligent Weigh	PD-3000	Electronic Balance	3/27/2012	Annual	3/27/2013	11081534
MCL	BW-N6W5+	6dB Attenuator	CBT	N/A	CBT	1139
MiniCircuits	VLF-6000+	Low Pass Filter	CBT	N/A	CBT	N/A
MiniCircuits	VLF-6000+	Low Pass Filter	CBT	N/A	CBT	N/A
MiniCircuits	SLP-2400+	Low Pass Filter	CBT	N/A	CBT	R8979500903
Mini-Circuits	BW-N20W5+	DC to 18 GHz Precision Fixed 20 dB Attenuator	CBT	N/A	CBT	N/A
Mini-Circuits	NLP-2950+	Low Pass Filter DC to 2700 MHz	CBT	N/A	CBT	N/A
Mini-Circuits	NLP-1200+	Low Pass Filter DC to 1000 MHz	CBT	N/A	CBT	N/A
Narda	4014C-6	4 - 8 GHz SMA 6 dB Directional Coupler	CBT	N/A	CBT	N/A
Narda	4772-3	Attenuator (3dB)	CBT	N/A	CBT	9406
Narda	BW-S3W2	Attenuator (3dB)	CBT	N/A	CBT	120
Pasternack	PE2208-6	Bidirectional Coupler	6/3/2011	Annual	6/3/2012	N/A
Pasternack	PE2209-10	Bidirectional Coupler	6/3/2011	Annual	6/3/2012	N/A
Rohde & Schwarz	CMU200	Base Station Simulator	6/1/2011	Annual	6/1/2012	833855/0010
Rohde & Schwarz	SMIQ03B	Signal Generator	4/5/2012	Annual	4/5/2013	DE27259
Rohde & Schwarz	NRVD	Dual Channel Power Meter	4/8/2011	Biennial	4/8/2013	101695
Seekonk	NC-100	Torque Wrench (8" lb)	11/29/2011	Triennial	11/29/2014	21053
Seekonk	NC-100	Torque Wrench (8" lb)	3/5/2012	Triennial	3/5/2015	N/A
Seekonk	NC-100	Torque Wrench (8" lb)	3/5/2012	Triennial	3/5/2015	N/A
SPEAG	D1900V2	1900 MHz SAR Dipole	7/22/2011	Annual	7/22/2012	5d080
SPEAG	EX3DV4	SAR Probe	7/27/2011	Annual	7/27/2012	3561
SPEAG	D835V2	835 MHz SAR Dipole	8/15/2011	Annual	8/15/2012	4d026
SPEAG	ES3DV2	SAR Probe	8/25/2011	Annual	8/25/2012	3022
Speag	DAK-3.5	Dielectric Assessment Kit	12/1/2011	Annual	12/1/2012	1031
SPEAG	DAE4	Dasy Data Acquisition Electronics	1/18/2012	Annual	1/18/2013	1272
SPEAG	D835V2	835 MHz SAR Dipole	1/25/2012	Annual	1/25/2013	4d047
SPEAG	DAE4	Dasy Data Acquisition Electronics	2/15/2012	Annual	2/15/2013	1323
SPEAG	ES3DV3	SAR Probe	2/21/2012	Annual	2/21/2013	3258
SPEAG	D1900V2	1900 MHz SAR Dipole	2/22/2012	Annual	2/22/2013	5d149
SPEAG	ES3DV3	SAR Probe	3/16/2012	Annual	3/16/2013	3209
SPEAG	DAE4	Dasy Data Acquisition Electronics	4/12/2012	Annual	4/12/2013	1333
SPEAG	DAE4	Dasy Data Acquisition Electronics	4/19/2012	Annual	4/19/2013	665
SPEAG	D1750V2	1750 MHz SAR Dipole	4/24/2012	Annual	4/24/2013	1051
Tektronix	RSA-6114A	Real Time Spectrum Analyzer	4/5/2012	Annual	4/5/2013	B010177
VWR	36934-158	Wall-Mounted Thermometer	5/26/2010	Biennial	5/26/2012	101718589
VWR	36934-158	Wall-Mounted Thermometer	1/21/2011	Biennial	1/21/2013	111286445
VWR	36934-158	Wall-Mounted Thermometer	1/21/2011	Biennial	1/21/2013	111286460

Note: CBT (Calibrated Before Testing). Prior to testing, the measurement paths containing a cable, attenuator, amplifier, coupler or filter were connected to a calibrated source (i.e. a signal generator) to determine the losses of the measurement path. The power meter offset was then adjusted to compensate for the measurement system losses. This level offset is stored within the power meter before measurements are made. This calibration verification procedure applies to the system verification and output power measurements. The calibrated reading is then taken directly from the power meter after compensation of the losses for all final power measurements.

FCC ID: N7NMC8355 (Integrated in Panasonic CF-H2mk2)	 <b>PCTEST</b> ENGINEERING LABORATORY, INC.	<b>SAR EVALUATION REPORT</b>	Reviewed by: Quality Manager
Document S/N: 0Y1206280880.N7N	Test Dates: 05/15/12 - 05/21/12	DUT Type: Module in Portable Tablet Computer	Page 22 of 26

# 13 MEASUREMENT UNCERTAINTIES

Applicable for frequencies less than 3000 MHz.

a	b	c	d	e= f(d,k)	f	g	h = c x f/e	i = c x g/e	k	
Uncertainty Component	IEEE 1528 Sec.	Tol. (± %)	Prob. Dist.	Div.	c <sub>i</sub> 1gm	c <sub>i</sub> 10 gms	1gm u <sub>i</sub> (± %)	10gms u <sub>i</sub> (± %)	v <sub>i</sub>	
<b>Measurement System</b>										
Probe Calibration	E.2.1	6.0	N	1	1.0	1.0	6.0	6.0	∞	
Axial Isotropy	E.2.2	0.25	N	1	0.7	0.7	0.2	0.2	∞	
Hemishperical Isotropy	E.2.2	1.3	N	1	1.0	1.0	1.3	1.3	∞	
Boundary Effect	E.2.3	0.4	N	1	1.0	1.0	0.4	0.4	∞	
Linearity	E.2.4	0.3	N	1	1.0	1.0	0.3	0.3	∞	
System Detection Limits	E.2.5	5.1	N	1	1.0	1.0	5.1	5.1	∞	
Readout Electronics	E.2.6	1.0	N	1	1.0	1.0	1.0	1.0	∞	
Response Time	E.2.7	0.8	R	1.73	1.0	1.0	0.5	0.5	∞	
Integration Time	E.2.8	2.6	R	1.73	1.0	1.0	1.5	1.5	∞	
RF Ambient Conditions	E.6.1	3.0	R	1.73	1.0	1.0	1.7	1.7	∞	
Probe Positioner Mechanical Tolerance	E.6.2	0.4	R	1.73	1.0	1.0	0.2	0.2	∞	
Probe Positioning w/ respect to Phantom	E.6.3	2.9	R	1.73	1.0	1.0	1.7	1.7	∞	
Extrapolation, Interpolation & Integration algorithms for Max. SAR Evaluation	E.5	1.0	R	1.73	1.0	1.0	0.6	0.6	∞	
<b>Test Sample Related</b>										
Test Sample Positioning	E.4.2	6.0	N	1	1.0	1.0	6.0	6.0	287	
Device Holder Uncertainty	E.4.1	3.32	R	1.73	1.0	1.0	1.9	1.9	∞	
Output Power Variation - SAR drift measurement	6.6.2	5.0	R	1.73	1.0	1.0	2.9	2.9	∞	
<b>Phantom &amp; Tissue Parameters</b>										
Phantom Uncertainty (Shape & Thickness tolerances)	E.3.1	4.0	R	1.73	1.0	1.0	2.3	2.3	∞	
Liquid Conductivity - deviation from target values	E.3.2	5.0	R	1.73	0.64	0.43	1.8	1.2	∞	
Liquid Conductivity - measurement uncertainty	E.3.3	3.8	N	1	0.64	0.43	2.4	1.6	6	
Liquid Permittivity - deviation from target values	E.3.2	5.0	R	1.73	0.60	0.49	1.7	1.4	∞	
Liquid Permittivity - measurement uncertainty	E.3.3	4.5	N	1	0.60	0.49	2.7	2.2	6	
<b>Combined Standard Uncertainty (k=1)</b>							RSS	12.1	11.7	299
<b>Expanded Uncertainty</b> (95% CONFIDENCE LEVEL)							k=2	24.2	23.5	

The above measurement uncertainties are according to IEEE Std. 1528-2003

FCC ID: N7NMC8355 (Integrated in Panasonic CF-H2mk2)	 <b>PCTEST</b> ENGINEERING LABORATORY, INC.	<b>SAR EVALUATION REPORT</b>	Reviewed by: Quality Manager
Document S/N: 0Y1206280880.N7N	Test Dates: 05/15/12 - 05/21/12	DUT Type: Module in Portable Tablet Computer	Page 23 of 26

## 14 CONCLUSION

### 14.1 Measurement Conclusion

The SAR evaluation indicates that the EUT WWAN transmitter complies with the RF radiation exposure limits of the FCC and Industry Canada, with respect to all parameters subject to this test. These measurements were taken to simulate the RF effects of RF exposure under worst-case conditions. Precise laboratory measures were taken to assure repeatability of the tests. The results and statements relate only to the item(s) tested.

Please note that the absorption and distribution of electromagnetic energy in the body are very complex phenomena that depend on the mass, shape, and size of the body, the orientation of the body with respect to the field vectors, and the electrical properties of both the body and the environment. Other variables that may play a substantial role in possible biological effects are those that characterize the environment (e.g. ambient temperature, air velocity, relative humidity, and body insulation) and those that characterize the individual (e.g. age, gender, activity level, debilitation, or disease). Because various factors may interact with one another to vary the specific biological outcome of an exposure to electromagnetic fields, any protection guide should consider maximal amplification of biological effects as a result of field-body interactions, environmental conditions, and physiological variables. [3]

<b>FCC ID:</b> N7NMC8355 (Integrated in Panasonic CF-H2mk2)		<b>SAR EVALUATION REPORT</b>	<b>Reviewed by:</b> Quality Manager
<b>Document S/N:</b> 0Y1206280880.N7N	<b>Test Dates:</b> 05/15/12 - 05/21/12	<b>DUT Type:</b> Module in Portable Tablet Computer	Page 24 of 26



## 15 REFERENCES

- [1] Federal Communications Commission, ET Docket 93-62, Guidelines for Evaluating the Environmental Effects of Radiofrequency Radiation, Aug. 1996.
- [2] ANSI/IEEE C95.1-2005, American National Standard safety levels with respect to human exposure to radio frequency electromagnetic fields, 3kHz to 300GHz, New York: IEEE, 2006.
- [3] ANSI/IEEE C95.1-1992, American National Standard safety levels with respect to human exposure to radio frequency electromagnetic fields, 3kHz to 300GHz, New York: IEEE, Sept. 1992.
- [4] ANSI/IEEE C95.3-2002, IEEE Recommended Practice for the Measurement of Potentially Hazardous Electromagnetic Fields - RF and Microwave, New York: IEEE, December 2002.
- [5] Federal Communications Commission, OET Bulletin 65 (Edition 97-01), Supplement C (Edition 01-01), Evaluating Compliance with FCC Guidelines for Human Exposure to Radiofrequency Electromagnetic Fields, June 2001.
- [6] IEEE Standards Coordinating Committee 34 – IEEE Std. 1528-2003, Recommended Practice for Determining the Peak Spatial-Average Specific Absorption Rate (SAR) in the Human Body Due to Wireless Communications Devices.
- [7] NCRP, National Council on Radiation Protection and Measurements, Biological Effects and Exposure Criteria for RadioFrequency Electromagnetic Fields, NCRP Report No. 86, 1986. Reprinted Feb. 1995.
- [8] T. Schmid, O. Egger, N. Kuster, Automated E-field scanning system for dosimetric assessments, IEEE Transaction on Microwave Theory and Techniques, vol. 44, Jan. 1996, pp. 105-113.
- [9] K. Pokovic, T. Schmid, N. Kuster, Robust setup for precise calibration of E-field probes in tissue simulating liquids at mobile communications frequencies, ICECOM97, Oct. 1997, pp. 120-124.
- [10] K. Pokovic, T. Schmid, and N. Kuster, E-field Probe with improved isotropy in brain simulating liquids, Proceedings of the ELMAR, Zadar, Croatia, June 23-25, 1996, pp. 172-175.
- [11] Schmid & Partner Engineering AG, Application Note: Data Storage and Evaluation, June 1998, p2.
- [12] V. Hombach, K. Meier, M. Burkhardt, E. Kuhn, N. Kuster, The Dependence of EM Energy Absorption upon Human Head Modeling at 900 MHz, IEEE Transaction on Microwave Theory and Techniques, vol. 44 no. 10, Oct. 1996, pp. 1865-1873.
- [13] N. Kuster and Q. Balzano, Energy absorption mechanism by biological bodies in the near field of dipole antennas above 300MHz, IEEE Transaction on Vehicular Technology, vol. 41, no. 1, Feb. 1992, pp. 17-23.
- [14] G. Hartsgrove, A. Kraszewski, A. Surowiec, Simulated Biological Materials for Electromagnetic Radiation Absorption Studies, University of Ottawa, Bioelectromagnetics, Canada: 1987, pp. 29-36.
- [15] Q. Balzano, O. Garay, T. Manning Jr., Electromagnetic Energy Exposure of Simulated Users of Portable Cellular Telephones, IEEE Transactions on Vehicular Technology, vol. 44, no.3, Aug. 1995.
- [16] W. Gander, Computermathematick, Birkhaeuser, Basel, 1992.
- [17] W.H. Press, S.A. Teukolsky, W.T. Vetterling, and B.P. Flannery, Numerical Recipes in C, The Art of Scientific Computing, Second edition, Cambridge University Press, 1992.

<b>FCC ID:</b> N7NMC8355 (Integrated in Panasonic CF-H2mk2)		<b>SAR EVALUATION REPORT</b>	<b>Reviewed by:</b> Quality Manager
<b>Document S/N:</b> 0Y1206280880.N7N	<b>Test Dates:</b> 05/15/12 - 05/21/12	<b>DUT Type:</b> Module in Portable Tablet Computer	Page 25 of 26

- [18] Federal Communications Commission, OET Bulletin 65, Evaluating Compliance with FCC Guidelines for Human Exposure to Radiofrequency Electromagnetic Fields. Supplement C, Dec. 1997.
- [19] N. Kuster, R. Kastle, T. Schmid, Dosimetric evaluation of mobile communications equipment with known precision, IEEE Transaction on Communications, vol. E80-B, no. 5, May 1997, pp. 645-652.
- [20] CENELEC CLC/SC111B, European Prestandard (prENV 50166-2), Human Exposure to Electromagnetic Fields High-frequency: 10kHz-300GHz, Jan. 1995.
- [21] Prof. Dr. Niels Kuster, ETH, Eidgenössische Technische Hochschule Zürich, Dosimetric Evaluation of the Cellular Phone.
- [22] IEC 62209-1, Human exposure to radio frequency fields from hand-held and body-mounted wireless communication devices - Human models, instrumentation, and procedures - Part 1: Procedure to determine the specific absorption rate (SAR) for hand-held devices used in close proximity to the ear (frequency range of 300 MHz to 3 GHz), Feb. 2005.
- [23] Industry Canada RSS-102 Radio Frequency Exposure Compliance of Radiocommunication Apparatus (All Frequency Bands) Issue 4, March 2010.
- [24] Health Canada Safety Code 6 Limits of Human Exposure to Radio Frequency Electromagnetic Fields in the Frequency Range from 3 kHz – 300 GHz, 2009
- [25] FCC Public Notice DA-02-1438. Office of Engineering and Technology Announces a Transition Period for the Phantom Requirements of Supplement C to OET Bulletin 65, June 19, 2002
- [26] FCC SAR Measurement Procedures for 3G Devices KDB Publication 941225
- [27] SAR Measurement procedures for IEEE 802.11a/b/g KDB Publication 248227
- [28] FCC SAR Considerations for Handsets with Multiple Transmitters and Antennas, KDB Publication 648474
- [29] FCC Application Note for SAR Probe Calibration and System Verification Consideration for Measurements at 150 MHz – 3 GHz, KDB Publication 450824
- [30] FCC SAR Evaluation Considerations for Laptop Computers with Antennas Built-in on Display Screens, KDB Publication 616217
- [31] FCC SAR Measurement Requirements for 3 – 6 GHz, KDB Publication 865664
- [32] FCC Mobile Portable RF Exposure Procedure, KDB Publication 447498
- [33] FCC SAR Procedures for Dongle Transmitters, KDB Publication 447498
- [34] Anexo à Resolução No. 533, de 10 de Setembro de 2009.
- [35] FCC SAR Test Considerations for LTE Handsets and Data Modems, KDB Publication 941225.
- [36] IEC 62209-2, Human exposure to radio frequency fields from hand-held and body-mounted wireless communication devices - Human models, instrumentation, and procedures - Part 2: Procedure to determine the specific absorption rate (SAR) for wireless communication devices used in close proximity to the human body (frequency range of 30 MHz to 6 GHz), Mar. 2010.
- [37] FCC Hot Spot SAR v01, KDB Publication 941225 D06.

<b>FCC ID:</b> N7NMC8355 (Integrated in Panasonic CF-H2mk2)		<b>SAR EVALUATION REPORT</b>	<b>Reviewed by:</b> Quality Manager
<b>Document S/N:</b> 0Y1206280880.N7N	<b>Test Dates:</b> 05/15/12 - 05/21/12	<b>DUT Type:</b> Module in Portable Tablet Computer	Page 26 of 26

## APPENDIX A: SAR TEST DATA

# PCTEST ENGINEERING LABORATORY, INC.

**DUT: N7NMC8355; Type: Module in Portable Tablet Computer; Serial: 2DKSA00138**

Communication System: GSM GPRS; 2 Tx slots; Frequency: 836.6 MHz; Duty Cycle: 1:4.15

Medium: 835 Body; Medium parameters used (interpolated):

$f = 836.6 \text{ MHz}$ ;  $\sigma = 0.976 \text{ mho/m}$ ;  $\epsilon_r = 53.13$ ;  $\rho = 1000 \text{ kg/m}^3$

Phantom section: Flat Section; Space: 0.0 cm

Test Date: 05-15-2012; Ambient Temp: 23.1°C; Tissue Temp: 21.8°C

Probe: ES3DV3 - SN3258; ConvF(6.06, 6.06, 6.06); Calibrated: 2/21/2012

Sensor-Surface: 4mm (Mechanical Surface Detection)

Electronics: DAE4 Sn1272; Calibrated: 1/18/2012

Phantom: SAM Main; Type: SAM 4.0; Serial: TP-1406

Measurement SW: DASY4, V4.7 Build 80; SEMCAD X Version 14.6.4 (4989)

**Mode: GPRS 850, Body SAR, Back side, Mid.ch, 2 Tx Slots**

**Area Scan (10x18x1):** Measurement grid: dx=15mm, dy=15mm

**Zoom Scan (5x5x7)/Cube 0:** Measurement grid: dx=8mm, dy=8mm, dz=5mm

Reference Value = 14.725 V/m; Power Drift = -0.03 dB

Peak SAR (extrapolated) = 0.2660 W/kg

**SAR(1 g) = 0.202 mW/g; SAR(10 g) = 0.147 mW/g**

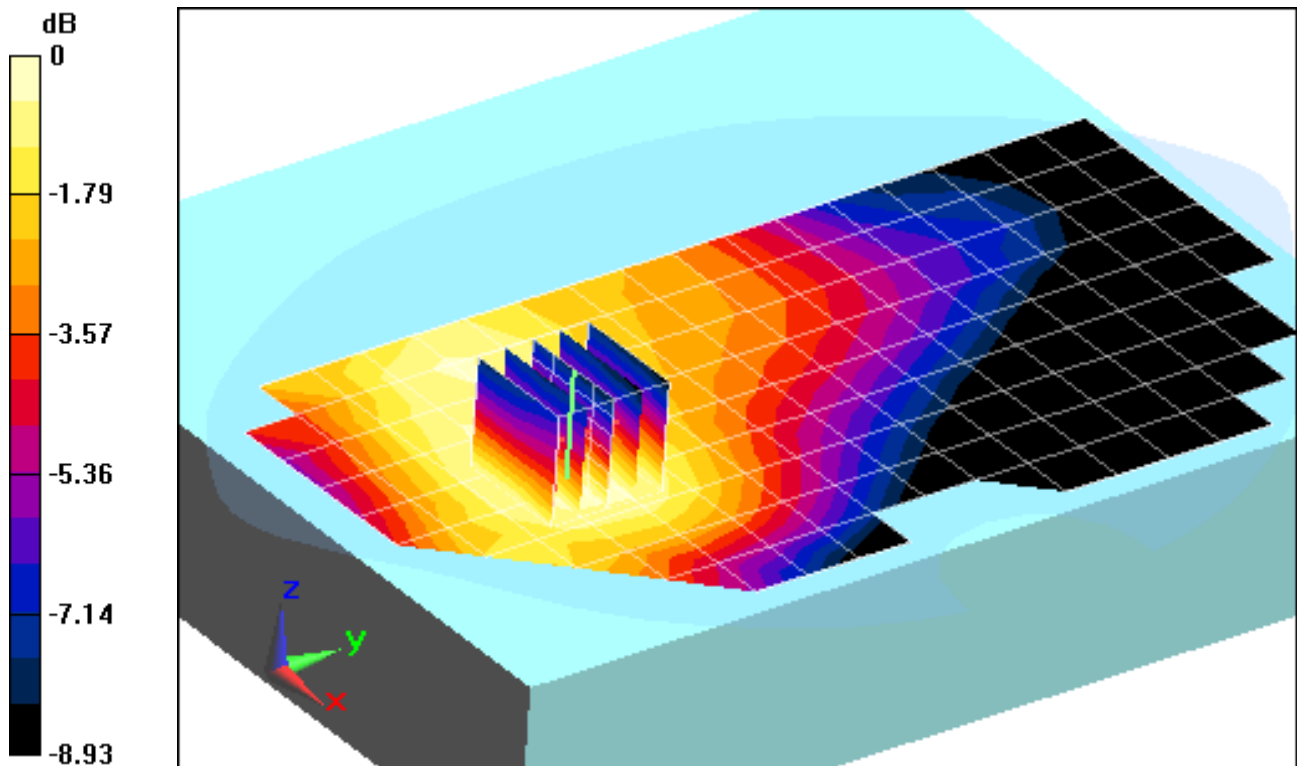

0 dB = 0.210mW/g = -13.56 dB mW/g



# PCTEST ENGINEERING LABORATORY, INC.

**DUT: N7NMC8355; Type: Module in Portable Tablet Computer; Serial: 2DKSA00138**

Communication System: GSM GPRS; 2 Tx slots; Frequency: 836.6 MHz; Duty Cycle: 1:4.15

Medium: 835 Body; Medium parameters used (interpolated):

$f = 836.6 \text{ MHz}$ ;  $\sigma = 0.976 \text{ mho/m}$ ;  $\epsilon_r = 53.13$ ;  $\rho = 1000 \text{ kg/m}^3$

Phantom section: Flat Section; Space: 0.0 cm

Test Date: 05-15-2012; Ambient Temp: 23.1°C; Tissue Temp: 21.8°C

Probe: ES3DV3 - SN3258; ConvF(6.06, 6.06, 6.06); Calibrated: 2/21/2012

Sensor-Surface: 4mm (Mechanical Surface Detection)

Electronics: DAE4 Sn1272; Calibrated: 1/18/2012

Phantom: SAM Main; Type: SAM 4.0; Serial: TP-1406

Measurement SW: DASY4, V4.7 Build 80;SEMCAD X Version 14.6.4 (4989)

**Mode: GPRS 850, Body SAR, Left Edge, Mid.ch, 2 Tx Slots**

**Area Scan (7x19x1):** Measurement grid: dx=15mm, dy=15mm

**Zoom Scan (5x5x7)/Cube 0:** Measurement grid: dx=8mm, dy=8mm, dz=5mm

Reference Value = 28.816 V/m; Power Drift = -0.02 dB

Peak SAR (extrapolated) = 1.1500 W/kg

**SAR(1 g) = 0.774 mW/g; SAR(10 g) = 0.504 mW/g**

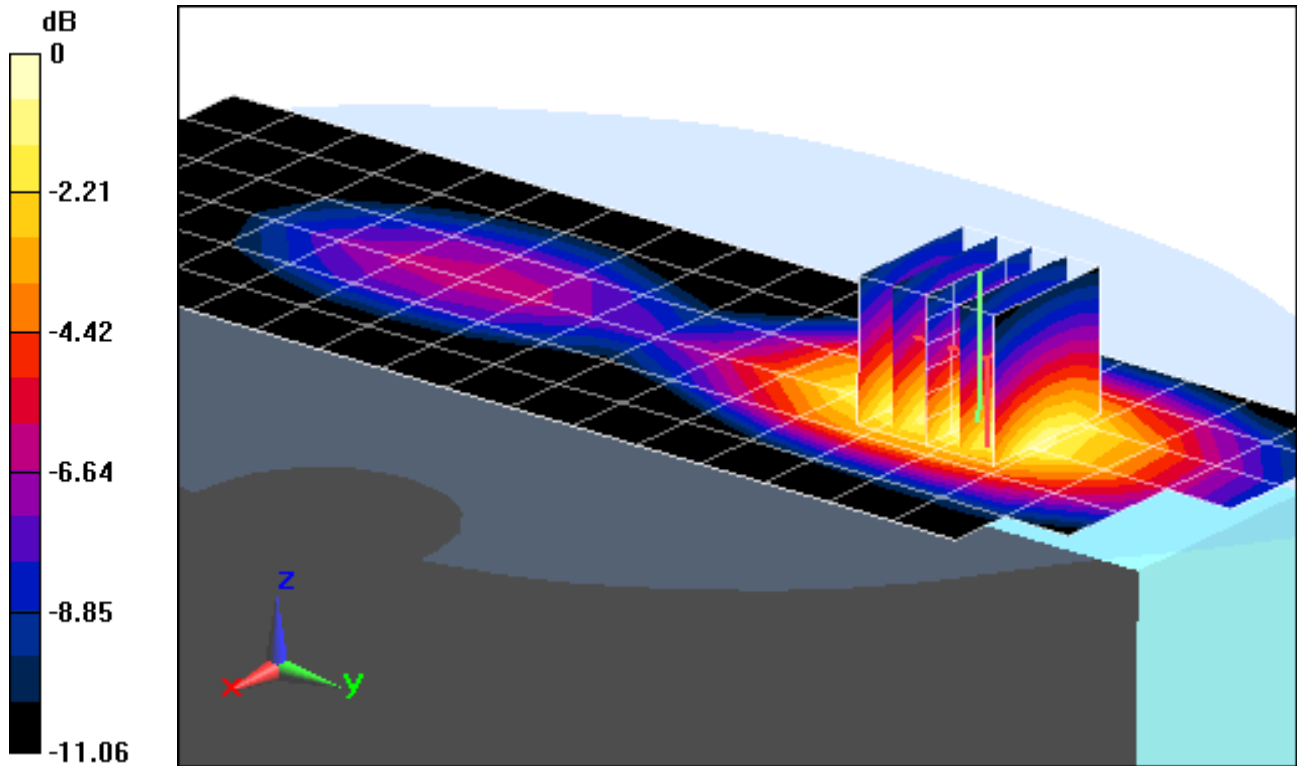

0 dB = 0.830mW/g = -1.62 dB mW/g

# PCTEST ENGINEERING LABORATORY, INC.

**DUT: N7NMC8355; Type: Module in Portable Tablet Computer; Serial: 2DKSA00138**

Communication System: WCDMA; Frequency: 836.6 MHz; Duty Cycle: 1:1

Medium: 835 Body; Medium parameters used (interpolated):

$f = 836.6 \text{ MHz}$ ;  $\sigma = 0.976 \text{ mho/m}$ ;  $\epsilon_r = 53.13$ ;  $\rho = 1000 \text{ kg/m}^3$

Phantom section: Flat Section; Space: 0.0 cm

Test Date: 05-15-2012; Ambient Temp: 23.1°C; Tissue Temp: 21.8°C

Probe: ES3DV3 - SN3258; ConvF(6.06, 6.06, 6.06); Calibrated: 2/21/2012

Sensor-Surface: 4mm (Mechanical Surface Detection)

Electronics: DAE4 Sn1272; Calibrated: 1/18/2012

Phantom: SAM Main; Type: SAM 4.0; Serial: TP-1406

Measurement SW: DASY4, V4.7 Build 80;SEMCAD X Version 14.6.4 (4989)

**Mode: WCDMA 850, Body SAR, Back side, Mid.ch**

**Area Scan (10x18x1):** Measurement grid: dx=15mm, dy=15mm

**Zoom Scan (5x5x7)/Cube 0:** Measurement grid: dx=8mm, dy=8mm, dz=5mm

Reference Value = 10.340 V/m; Power Drift = 0.01 dB

Peak SAR (extrapolated) = 0.1310 W/kg

**SAR(1 g) = 0.098 mW/g; SAR(10 g) = 0.071 mW/g**

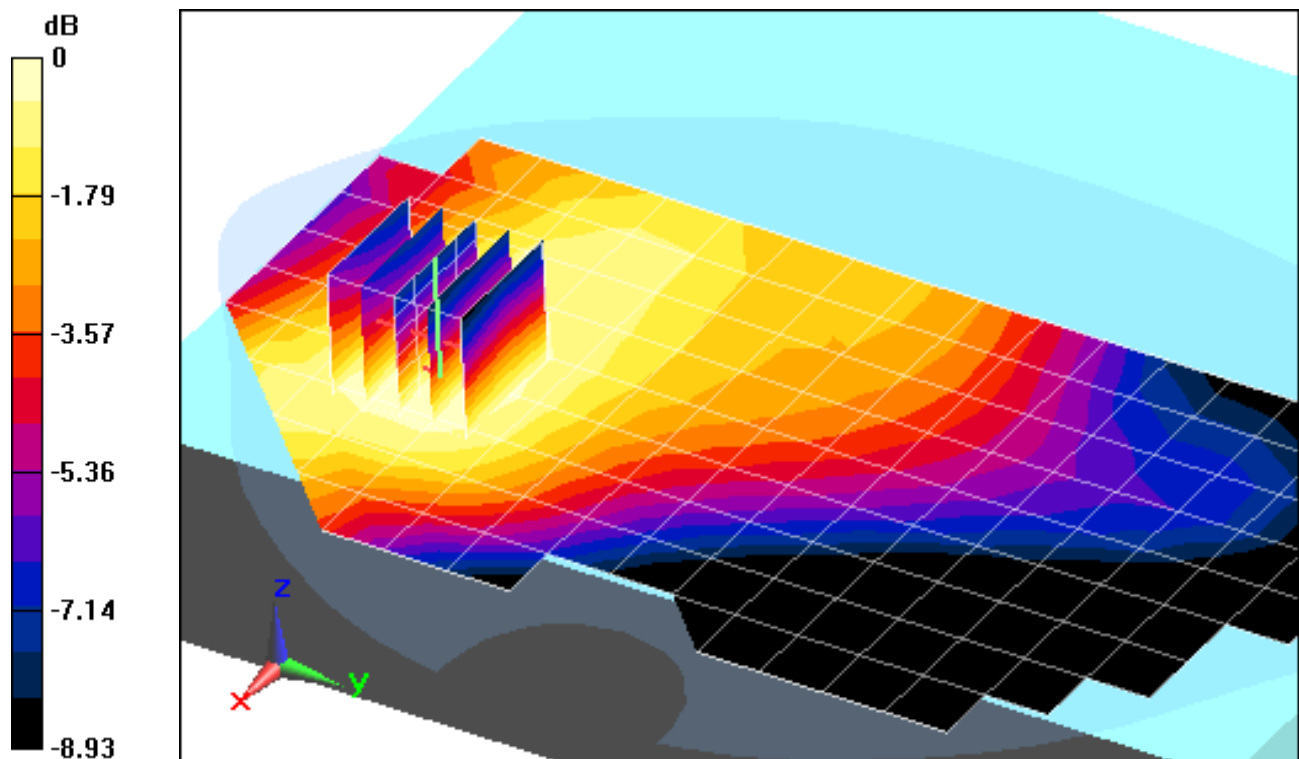

0 dB = 0.100mW/g = -20.00 dB mW/g

# PCTEST ENGINEERING LABORATORY, INC.

**DUT: N7NMC8355; Type: Module in Portable Tablet Computer; Serial: 2DKSA00138**

Communication System: WCDMA; Frequency: 836.6 MHz; Duty Cycle: 1:1

Medium: 835 Body; Medium parameters used (interpolated):

$f = 836.6 \text{ MHz}$ ;  $\sigma = 0.976 \text{ mho/m}$ ;  $\epsilon_r = 53.13$ ;  $\rho = 1000 \text{ kg/m}^3$

Phantom section: Flat Section; Space: 0.0 cm

Test Date: 05-15-2012; Ambient Temp: 23.1°C; Tissue Temp: 21.8°C

Probe: ES3DV3 - SN3258; ConvF(6.06, 6.06, 6.06); Calibrated: 2/21/2012

Sensor-Surface: 4mm (Mechanical Surface Detection)

Electronics: DAE4 Sn1272; Calibrated: 1/18/2012

Phantom: SAM Main; Type: SAM 4.0; Serial: TP-1406

Measurement SW: DASY4, V4.7 Build 80; SEMCAD X Version 14.6.4 (4989)

**Mode: WCDMA 850, Body SAR, Top Edge, Mid.ch**

**Area Scan (7x19x1):** Measurement grid: dx=15mm, dy=15mm

**Zoom Scan (5x5x7)/Cube 0:** Measurement grid: dx=8mm, dy=8mm, dz=5mm

Reference Value = 9.165 V/m; Power Drift = 0.02 dB

Peak SAR (extrapolated) = 0.1110 W/kg

**SAR(1 g) = 0.079 mW/g; SAR(10 g) = 0.055 mW/g**

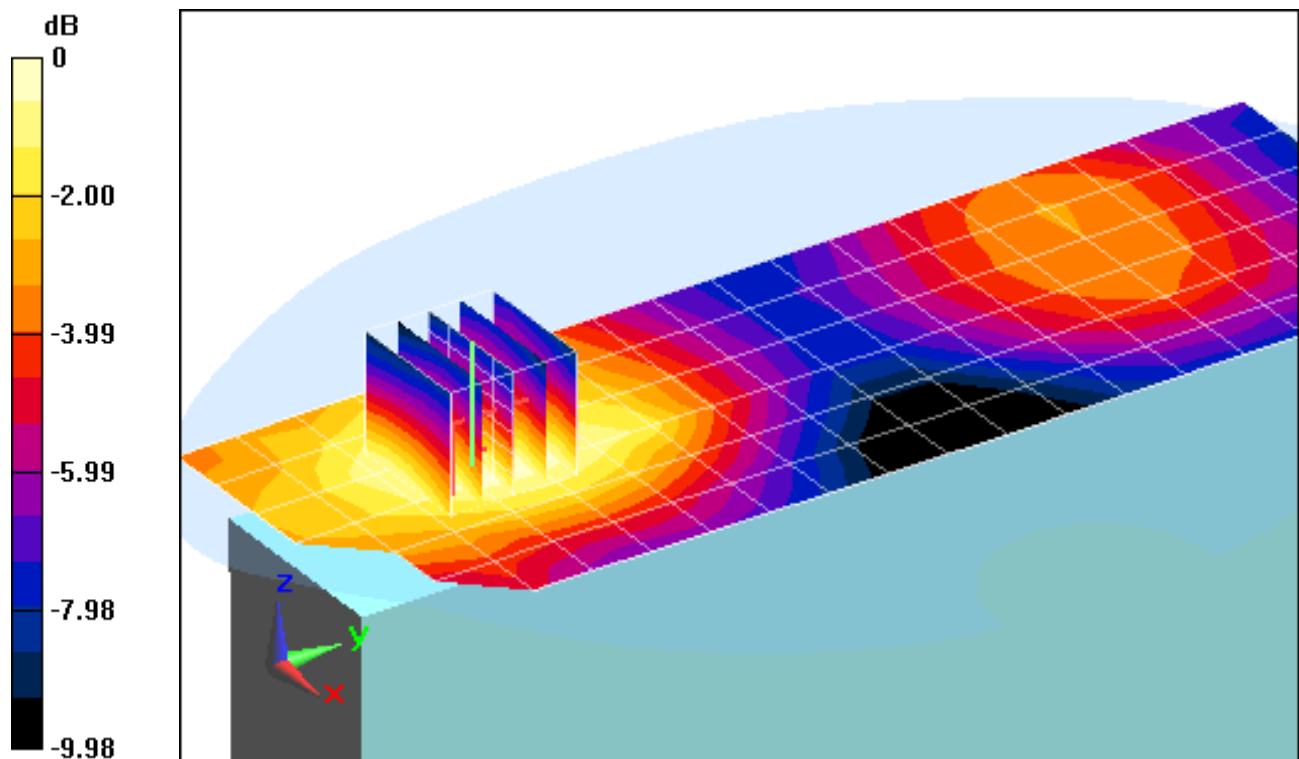

0 dB = 0.080mW/g = -21.94 dB mW/g



# PCTEST ENGINEERING LABORATORY, INC.

**DUT: N7NMC8355; Type: Module in Portable Tablet Computer; Serial: 2DKSA00138**

Communication System: WCDMA; Frequency: 836.6 MHz; Duty Cycle: 1:1

Medium: 835 Body; Medium parameters used (interpolated):

$f = 836.6 \text{ MHz}$ ;  $\sigma = 0.976 \text{ mho/m}$ ;  $\epsilon_r = 53.13$ ;  $\rho = 1000 \text{ kg/m}^3$

Phantom section: Flat Section; Space: 0.0 cm

Test Date: 05-15-2012; Ambient Temp: 23.1°C; Tissue Temp: 21.8°C

Probe: ES3DV3 - SN3258; ConvF(6.06, 6.06, 6.06); Calibrated: 2/21/2012

Sensor-Surface: 4mm (Mechanical Surface Detection)

Electronics: DAE4 Sn1272; Calibrated: 1/18/2012

Phantom: SAM Main; Type: SAM 4.0; Serial: TP-1406

Measurement SW: DASY4, V4.7 Build 80;SEMCAD X Version 14.6.4 (4989)

**Mode: WCDMA 850, Body SAR, Left Edge, Mid.ch**

**Area Scan (7x19x1):** Measurement grid: dx=15mm, dy=15mm

**Zoom Scan (5x5x7)/Cube 0:** Measurement grid: dx=8mm, dy=8mm, dz=5mm

Reference Value = 19.219 V/m; Power Drift = -0.03 dB

Peak SAR (extrapolated) = 0.5530 W/kg

**SAR(1 g) = 0.373 mW/g; SAR(10 g) = 0.245 mW/g**

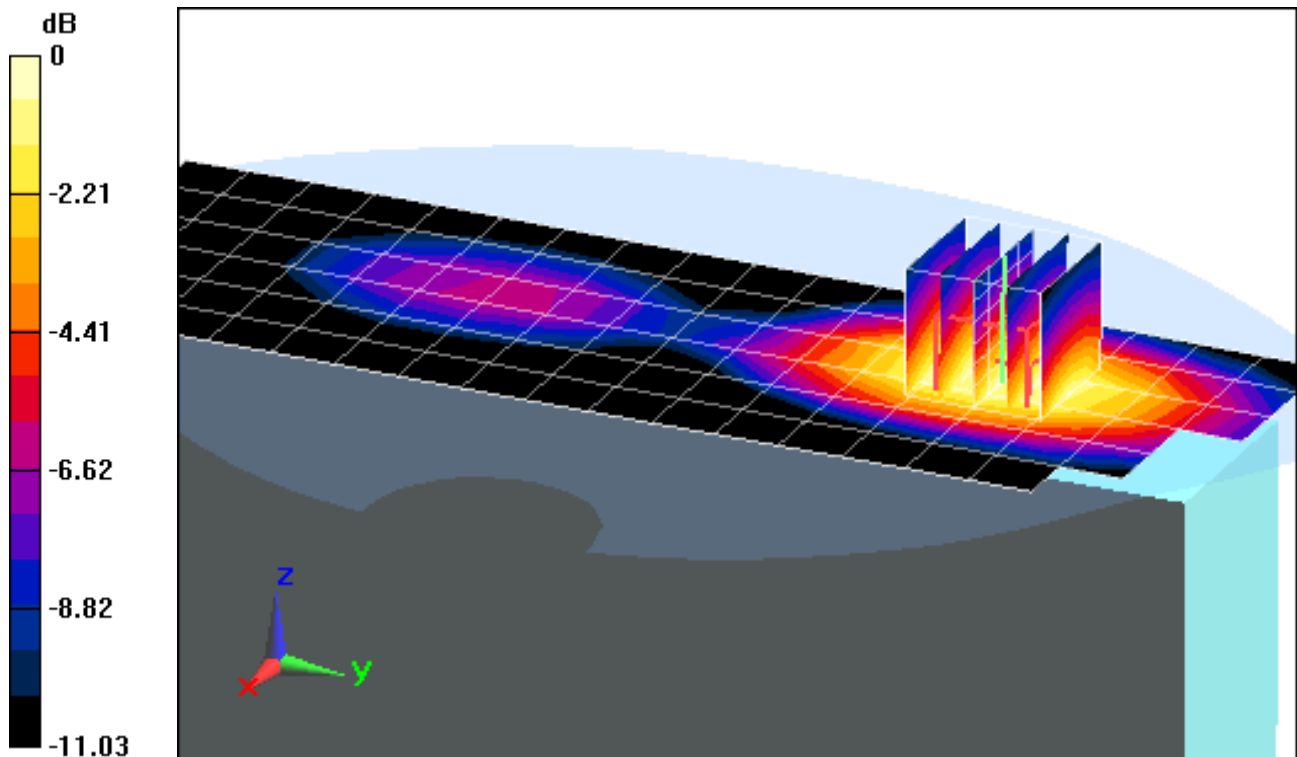

0 dB = 0.400mW/g = -7.96 dB mW/g

# PCTEST ENGINEERING LABORATORY, INC.

**DUT: N7NMC8355; Type: Module in Portable Tablet Computer; Serial: 2DKSA00138**

Communication System: CDMA; Frequency: 836.52 MHz; Duty Cycle: 1:1

Medium: 835 Body; Medium parameters used (interpolated):

$f = 836.52$  MHz;  $\sigma = 0.973$  mho/m;  $\epsilon_r = 52.986$ ;  $\rho = 1000$  kg/m<sup>3</sup>

Phantom section: Flat Section; Space: 0.0 cm

Test Date: 05-21-2012; Ambient Temp: 23.9°C; Tissue Temp: 22.4°C

Probe: EX3DV4 - SN3561; ConvF(8.25, 8.25, 8.25); Calibrated: 7/27/2011;

Sensor-Surface: 4mm (Mechanical Surface Detection)

Electronics: DAE4 Sn1333; Calibrated: 4/12/2012

Phantom: SAM 5.0 front; Type: QD000P40CD; Serial: TP:-1648

Measurement SW: DASY52, Version 52.8 (0);SEMCAD X Version 14.6.4 (4989)

**Mode: Cellular EVDO, Body SAR, Back side, Mid.ch**

**Area Scan (9x21x1):** Measurement grid: dx=15mm, dy=15mm

**Zoom Scan (5x5x7)/Cube 0:** Measurement grid: dx=8mm, dy=8mm, dz=5mm

Reference Value = 7.356 V/m; Power Drift = 0.06 dB

Peak SAR (extrapolated) = 0.102 mW/g

**SAR(1 g) = 0.071 mW/g; SAR(10 g) = 0.051 mW/g**

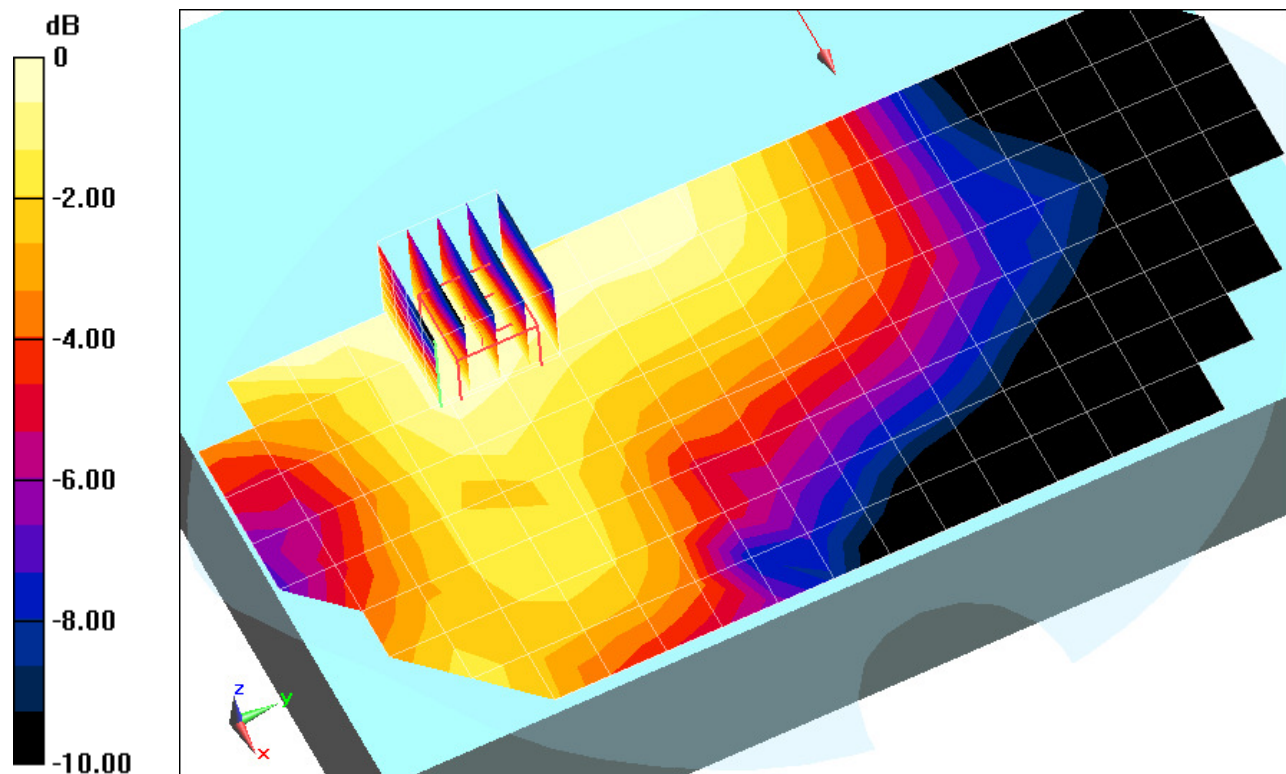

0 dB = 0.0780 mW/g = -22.16 dB mW/g

# PCTEST ENGINEERING LABORATORY, INC.

**DUT: N7NMC8355; Type: Module in Portable Tablet Computer; Serial: 2DKSA00138**

Communication System: CDMA; Frequency: 836.52 MHz; Duty Cycle: 1:1

Medium: 835 Body; Medium parameters used (interpolated):

$f = 836.52 \text{ MHz}$ ;  $\sigma = 0.973 \text{ mho/m}$ ;  $\epsilon_r = 52.986$ ;  $\rho = 1000 \text{ kg/m}^3$

Phantom section: Flat Section; Space: 0.0 cm

Test Date: 05-21-2012; Ambient Temp: 23.9°C; Tissue Temp: 22.4°C

Probe: EX3DV4 - SN3561; ConvF(8.25, 8.25, 8.25); Calibrated: 7/27/2011

Sensor-Surface: 4mm (Mechanical Surface Detection)

Electronics: DAE4 Sn1333; Calibrated: 4/12/2012

Phantom: SAM 5.0 front; Type: QD000P40CD; Serial: TP:-1648

Measurement SW: DASY52, Version 52.8 (0);SEMCAD X Version 14.6.4 (4989)

**Mode: Cellular EVDO, Body SAR, Top Edge, Mid.ch**

**Area Scan (9x21x1):** Measurement grid: dx=15mm, dy=15mm

**Zoom Scan (5x5x7)/Cube 0:** Measurement grid: dx=8mm, dy=8mm, dz=5mm

Reference Value = 9.145 V/m; Power Drift = 0.15 dB

Peak SAR (extrapolated) = 0.1100 W/kg

**SAR(1 g) = 0.079 mW/g; SAR(10 g) = 0.053 mW/g**

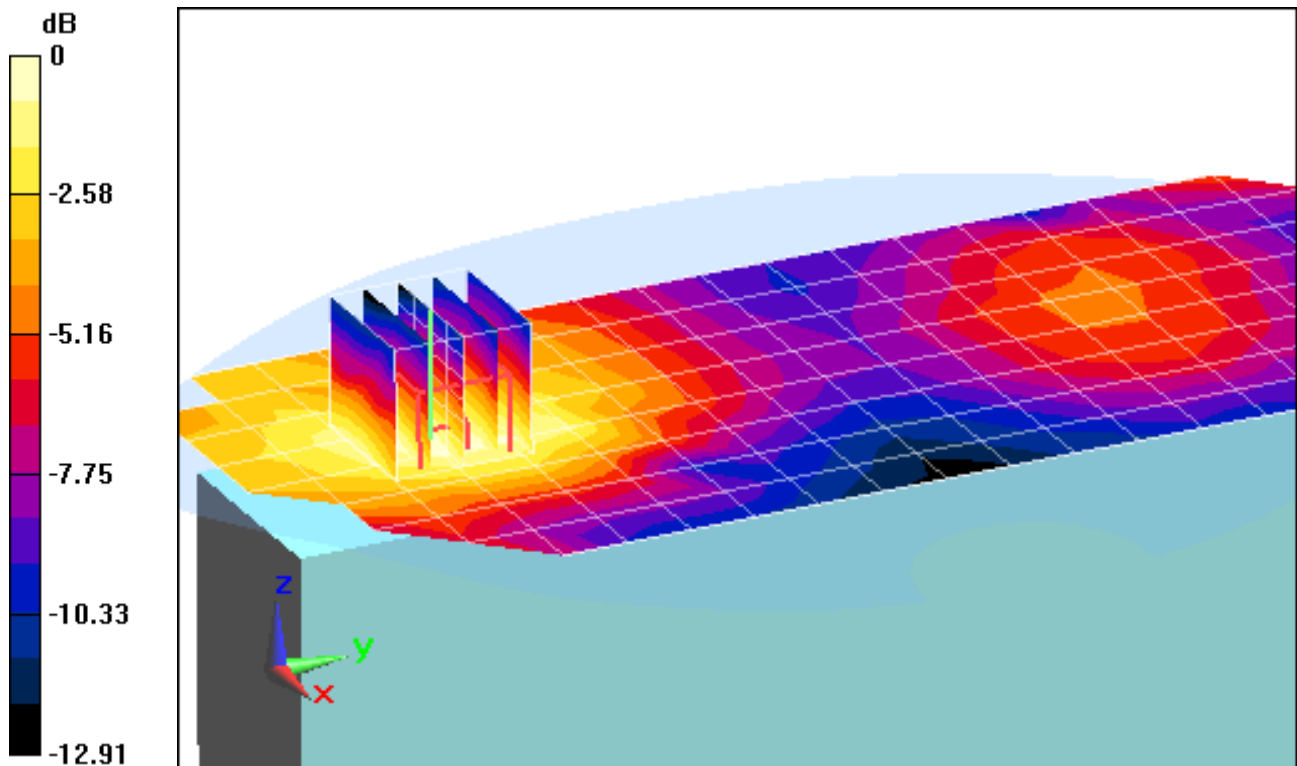

# PCTEST ENGINEERING LABORATORY, INC.

**DUT: N7NMC8355; Type: Module in Portable Tablet Computer; Serial: 2DKSA00138**

Communication System: CDMA; Frequency: 836.52 MHz; Duty Cycle: 1:1

Medium: 835 Body; Medium parameters used (interpolated):

$f = 836.52 \text{ MHz}$ ;  $\sigma = 0.973 \text{ mho/m}$ ;  $\epsilon_r = 52.986$ ;  $\rho = 1000 \text{ kg/m}^3$

Phantom section: Flat Section; Space: 0.0 cm

Test Date: 05-21-2012; Ambient Temp: 23.9°C; Tissue Temp: 22.4°C

Probe: EX3DV4 - SN3561; ConvF(8.25, 8.25, 8.25); Calibrated: 7/27/2011

Sensor-Surface: 4mm (Mechanical Surface Detection)

Electronics: DAE4 Sn1333; Calibrated: 4/12/2012

Phantom: SAM 5.0 front; Type: QD000P40CD; Serial: TP:-1648

Measurement SW: DASY52, Version 52.8 (0);SEMCAD X Version 14.6.4 (4989)

**Mode: Cellular EVDO, Body SAR, Left Edge, Mid.ch**

**Area Scan (9x21x1):** Measurement grid: dx=15mm, dy=15mm

**Zoom Scan (5x5x7)/Cube 0:** Measurement grid: dx=8mm, dy=8mm, dz=5mm

Reference Value = 21.065 V/m; Power Drift = -0.16 dB

Peak SAR (extrapolated) = 0.6120 W/kg

**SAR(1 g) = 0.392 mW/g; SAR(10 g) = 0.250 mW/g**

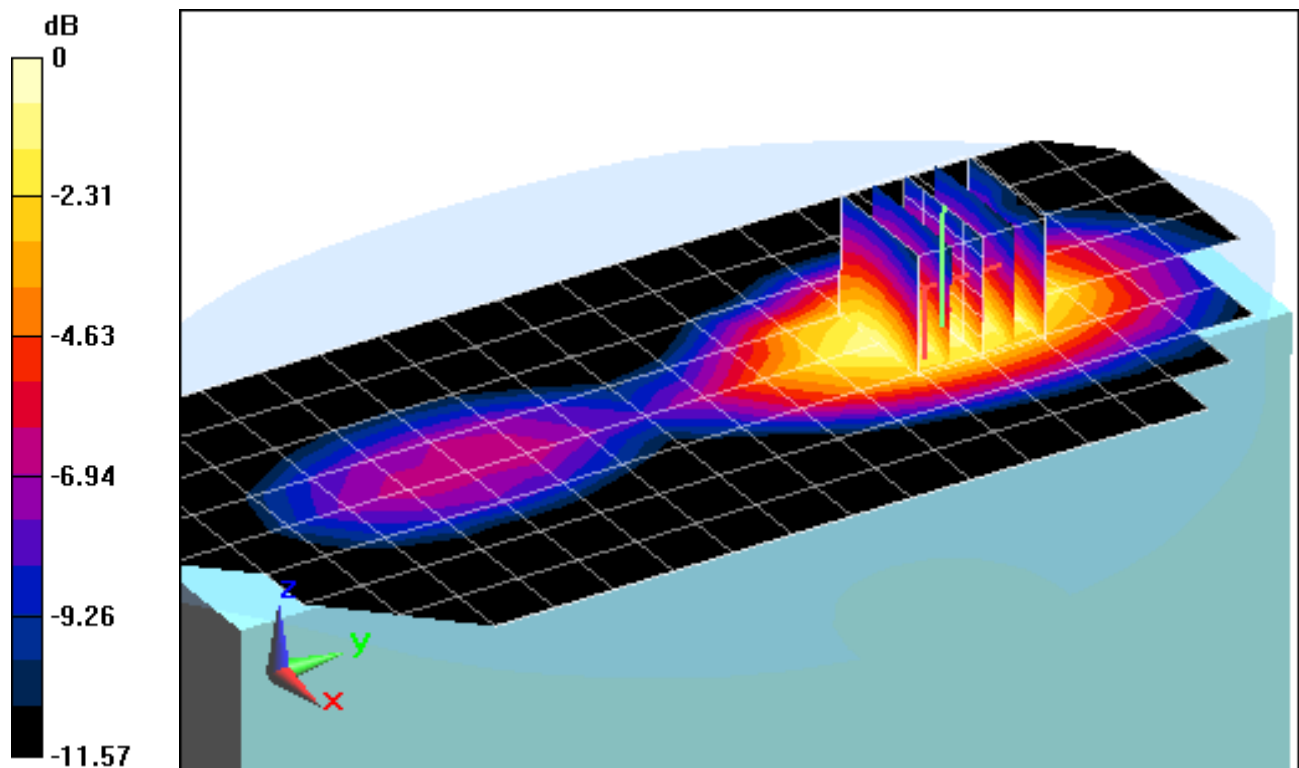

0 dB = 0.420mW/g = -7.54 dB mW/g

# PCTEST ENGINEERING LABORATORY, INC.

**DUT: N7NMC8355; Type: Module in Portable Tablet Computer; Serial: 2DKSA00138**

Communication System: WCDMA; Frequency: 1730.4 MHz; Duty Cycle: 1:1

Medium: 1750 Body; Medium parameters used (interpolated):

$f = 1730.4 \text{ MHz}$ ;  $\sigma = 1.487 \text{ mho/m}$ ;  $\epsilon_r = 52.702$ ;  $\rho = 1000 \text{ kg/m}^3$

Phantom section: Flat Section; Space: 0.0 cm

Test Date: 05-21-2012; Ambient Temp: 24.5°C; Tissue Temp: 22.6°C

Probe: ES3DV2 - SN3022; ConvF(4.64, 4.64, 4.64); Calibrated: 8/25/2011

Sensor-Surface: 4mm (Mechanical Surface Detection)

Electronics: DAE4 Sn665; Calibrated: 4/19/2012

Phantom: SAM Sub Dasy B; Type: SAM 5.0; Serial: TP-1626

Measurement SW: DASY4, Version 4.7 (80);SEMCAD X Version 14.6.4 (4989)

**Mode: AWS WCDMA, Body SAR, Back side, Mid.ch**

**Area Scan (10x18x1):** Measurement grid: dx=15mm, dy=15mm

**Zoom Scan (5x5x7)/Cube 0:** Measurement grid: dx=8mm, dy=8mm, dz=5mm

Reference Value = 10.114 V/m; Power Drift = -0.17 dB

Peak SAR (extrapolated) = 0.1960 W/kg

**SAR(1 g) = 0.132 mW/g; SAR(10 g) = 0.086 mW/g**

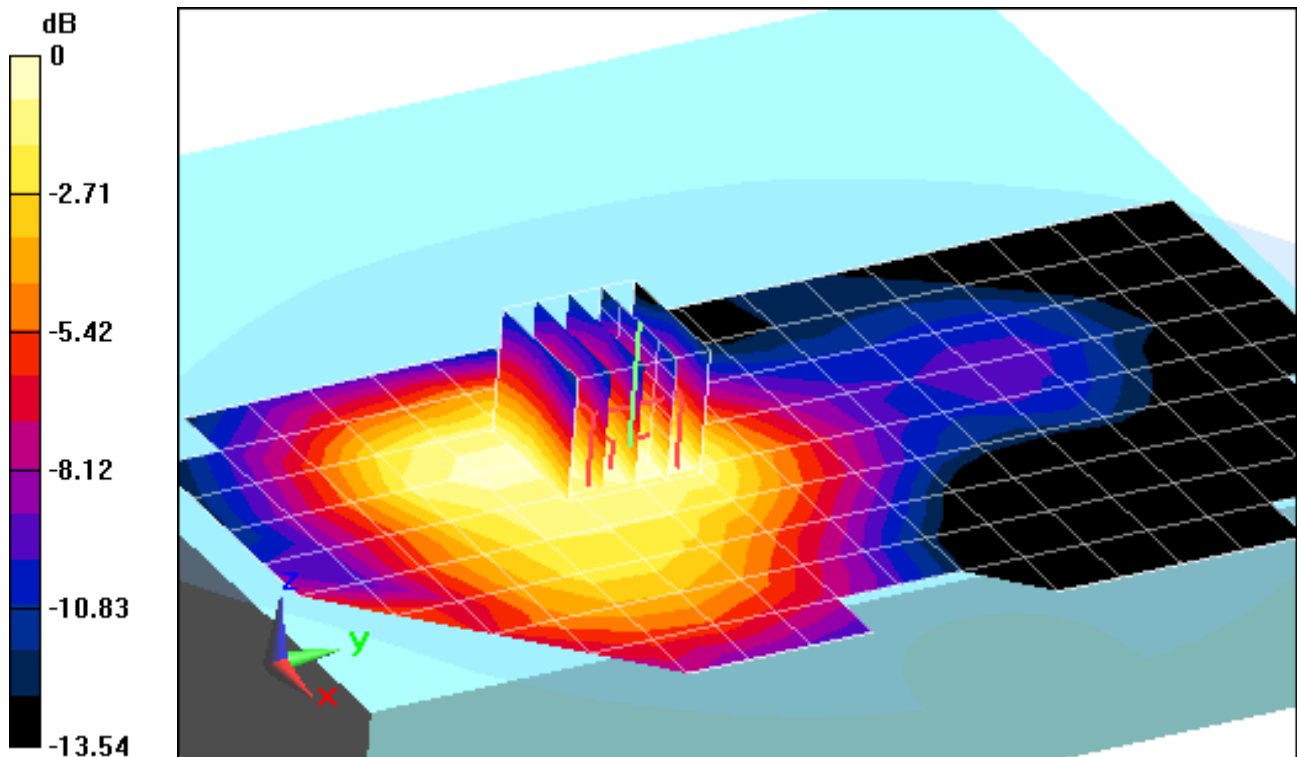

0 dB = 0.140mW/g = -17.08 dB mW/g

# PCTEST ENGINEERING LABORATORY, INC.

**DUT: N7NMC8355; Type: Module in Portable Tablet Computer; Serial: 2DKSA00138**

Communication System: WCDMA; Frequency: 1730.4 MHz; Duty Cycle: 1:1

Medium: 1750 Body; Medium parameters used (interpolated):

$f = 1730.4 \text{ MHz}$ ;  $\sigma = 1.487 \text{ mho/m}$ ;  $\epsilon_r = 52.702$ ;  $\rho = 1000 \text{ kg/m}^3$

Phantom section: Flat Section; Space: 0.0 cm

Test Date: 05-21-2012; Ambient Temp: 24.5°C; Tissue Temp: 22.6°C

Probe: ES3DV2 - SN3022; ConvF(4.64, 4.64, 4.64); Calibrated: 8/25/2011

Sensor-Surface: 4mm (Mechanical Surface Detection)

Electronics: DAE4 Sn665; Calibrated: 4/19/2012

Phantom: SAM Sub Dasy B; Type: SAM 5.0; Serial: TP-1626

Measurement SW: DASY4, Version 4.7 (80);SEMCAD X Version 14.6.4 (4989)

**Mode: AWS WCDMA, Body SAR, Top Edge, Mid.ch**

**Area Scan (10x18x1):** Measurement grid: dx=15mm, dy=15mm

**Zoom Scan (5x5x7)/Cube 0:** Measurement grid: dx=8mm, dy=8mm, dz=5mm

Reference Value = 9.561 V/m; Power Drift = 0.03 dB

Peak SAR (extrapolated) = 0.1880 W/kg

**SAR(1 g) = 0.124 mW/g; SAR(10 g) = 0.082 mW/g**

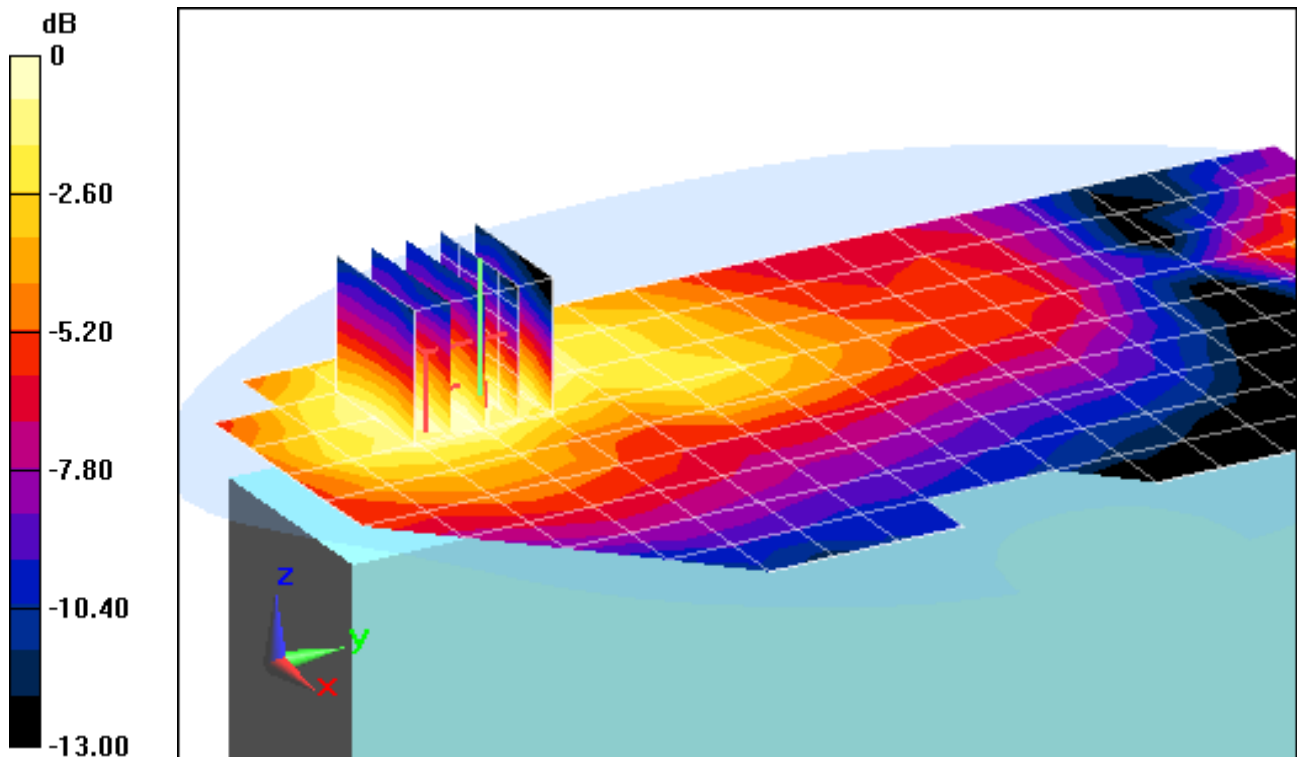

0 dB = 0.130mW/g = -17.72 dB mW/g



# PCTEST ENGINEERING LABORATORY, INC.

**DUT: N7NMC8355; Type: Module in Portable Tablet Computer; Serial: 2DKSA00138**

Communication System: WCDMA; Frequency: 1730.4 MHz; Duty Cycle: 1:1

Medium: 1750 Body; Medium parameters used (interpolated):

$f = 1730.4 \text{ MHz}$ ;  $\sigma = 1.487 \text{ mho/m}$ ;  $\epsilon_r = 52.702$ ;  $\rho = 1000 \text{ kg/m}^3$

Phantom section: Flat Section; Space: 0.0 cm

Test Date: 05-21-2012; Ambient Temp: 24.5°C; Tissue Temp: 22.6°C

Probe: ES3DV2 - SN3022; ConvF(4.64, 4.64, 4.64); Calibrated: 8/25/2011

Sensor-Surface: 4mm (Mechanical Surface Detection)

Electronics: DAE4 Sn665; Calibrated: 4/19/2012

Phantom: SAM Sub Dasy B; Type: SAM 5.0; Serial: TP-1626

Measurement SW: DASY4, Version 4.7 (80);SEMCAD X Version 14.6.4 (4989)

**Mode: AWS WCDMA, Body SAR, Left Edge, Mid.ch**

**Area Scan (10x18x1):** Measurement grid: dx=15mm, dy=15mm

**Zoom Scan (5x5x7)/Cube 0:** Measurement grid: dx=8mm, dy=8mm, dz=5mm

Reference Value = 12.521 V/m; Power Drift = 0.09 dB

Peak SAR (extrapolated) = 0.3410 W/kg

**SAR(1 g) = 0.223 mW/g; SAR(10 g) = 0.131 mW/g**

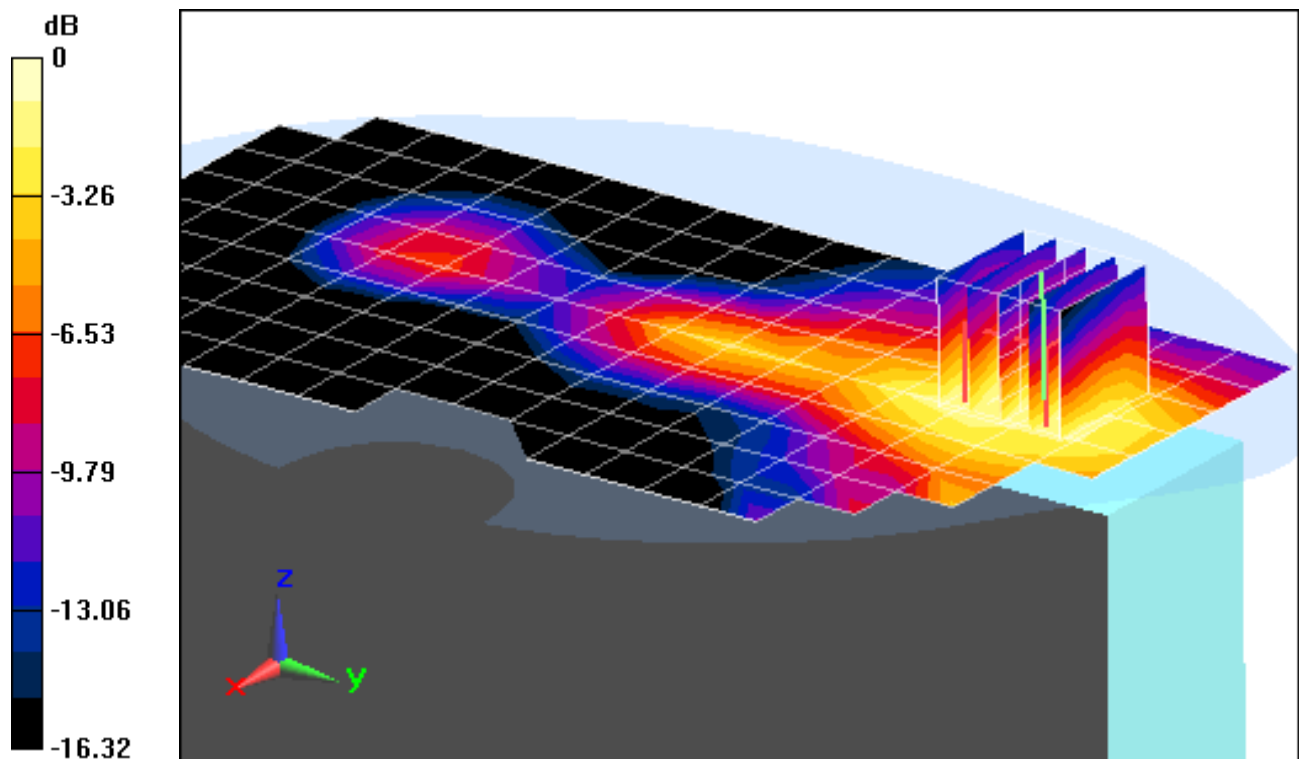

0 dB = 0.240mW/g = -12.40 dB mW/g

# PCTEST ENGINEERING LABORATORY, INC.

**DUT: N7NMC8355; Type: Module in Portable Tablet Computer; Serial: 2DKSA00138**

Communication System: GSM GPRS; 2 Tx slots; Frequency: 1880 MHz; Duty Cycle: 1:4.15

Medium: 1900 Body; Medium parameters used:

$f = 1880 \text{ MHz}$ ;  $\sigma = 1.511 \text{ mho/m}$ ;  $\epsilon_r = 51.79$ ;  $\rho = 1000 \text{ kg/m}^3$

Phantom section: Flat Section; Space: 0.0 cm

Test Date: 05-15-2012; Ambient Temp: 24.2 °C; Tissue Temp: 22.7 °C

Probe: ES3DV3 - SN3209; ConvF(4.63, 4.63, 4.63); Calibrated: 3/16/2012

Sensor-Surface: 4mm (Mechanical Surface Detection)

Electronics: DAE4 Sn1323; Calibrated: 2/15/2012

Phantom: SAM Sub; Type: SAM 4.0; Serial: TP-1357

Measurement SW: DASY4, Version 4.7 (80);SEMCAD X Version 14.6.4 (4989)

**Mode: GPRS 1900, Body SAR, Back side, Mid.ch, 2 Tx Slots**

**Area Scan (10x18x1):** Measurement grid: dx=15mm, dy=15mm

**Zoom Scan (5x5x7)/Cube 0:** Measurement grid: dx=8mm, dy=8mm, dz=5mm

Reference Value = 8.692 V/m; Power Drift = 0.02 dB

Peak SAR (extrapolated) = 0.1600 W/kg

**SAR(1 g) = 0.104 mW/g; SAR(10 g) = 0.067 mW/g**

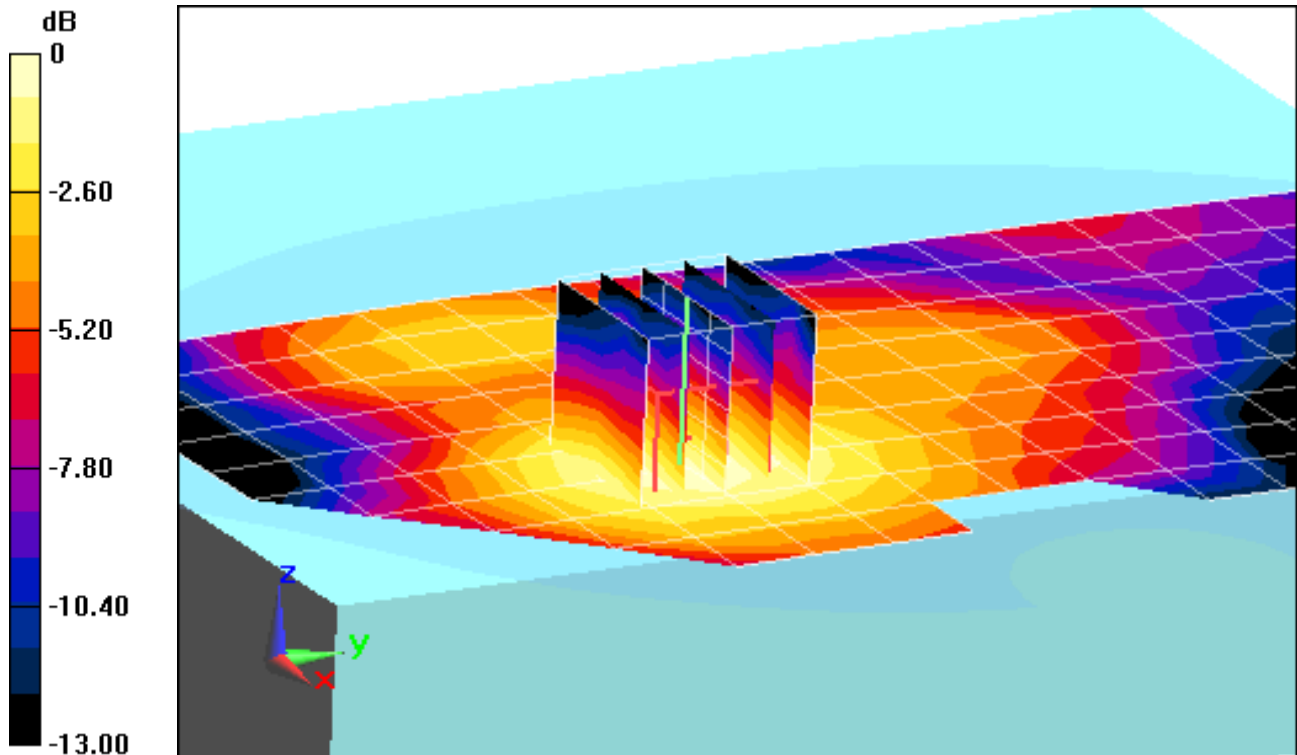

0 dB = 0.110mW/g = -19.17 dB mW/g



# PCTEST ENGINEERING LABORATORY, INC.

**DUT: N7NMC8355; Type: Module in Portable Tablet Computer; Serial: 2DKSA00138**

Communication System: GSM GPRS; 2 Tx slots; Frequency: 1880 MHz; Duty Cycle: 1:4.15

Medium: 1900 Body; Medium parameters used:

$f = 1880 \text{ MHz}$ ;  $\sigma = 1.511 \text{ mho/m}$ ;  $\epsilon_r = 51.79$ ;  $\rho = 1000 \text{ kg/m}^3$

Phantom section: Flat Section; Space: 0.0 cm

Test Date: 05-15-2012; Ambient Temp: 24.2 °C; Tissue Temp: 22.7 °C

Probe: ES3DV3 - SN3209; ConvF(4.63, 4.63, 4.63); Calibrated: 3/16/2012

Sensor-Surface: 4mm (Mechanical Surface Detection)

Electronics: DAE4 Sn1323; Calibrated: 2/15/2012

Phantom: SAM Sub; Type: SAM 4.0; Serial: TP-1357

Measurement SW: DASY4, Version 4.7 (80);SEMCAD X Version 14.6.4 (4989)

**Mode: GPRS 1900, Body SAR, Top Edge, Mid.ch, 2 Tx Slots**

**Area Scan (7x19x1):** Measurement grid: dx=15mm, dy=15mm

**Zoom Scan (5x5x7)/Cube 0:** Measurement grid: dx=8mm, dy=8mm, dz=5mm

Reference Value = 7.827 V/m; Power Drift = -0.07 dB

Peak SAR (extrapolated) = 0.1520 W/kg

**SAR(1 g) = 0.099 mW/g; SAR(10 g) = 0.063 mW/g**

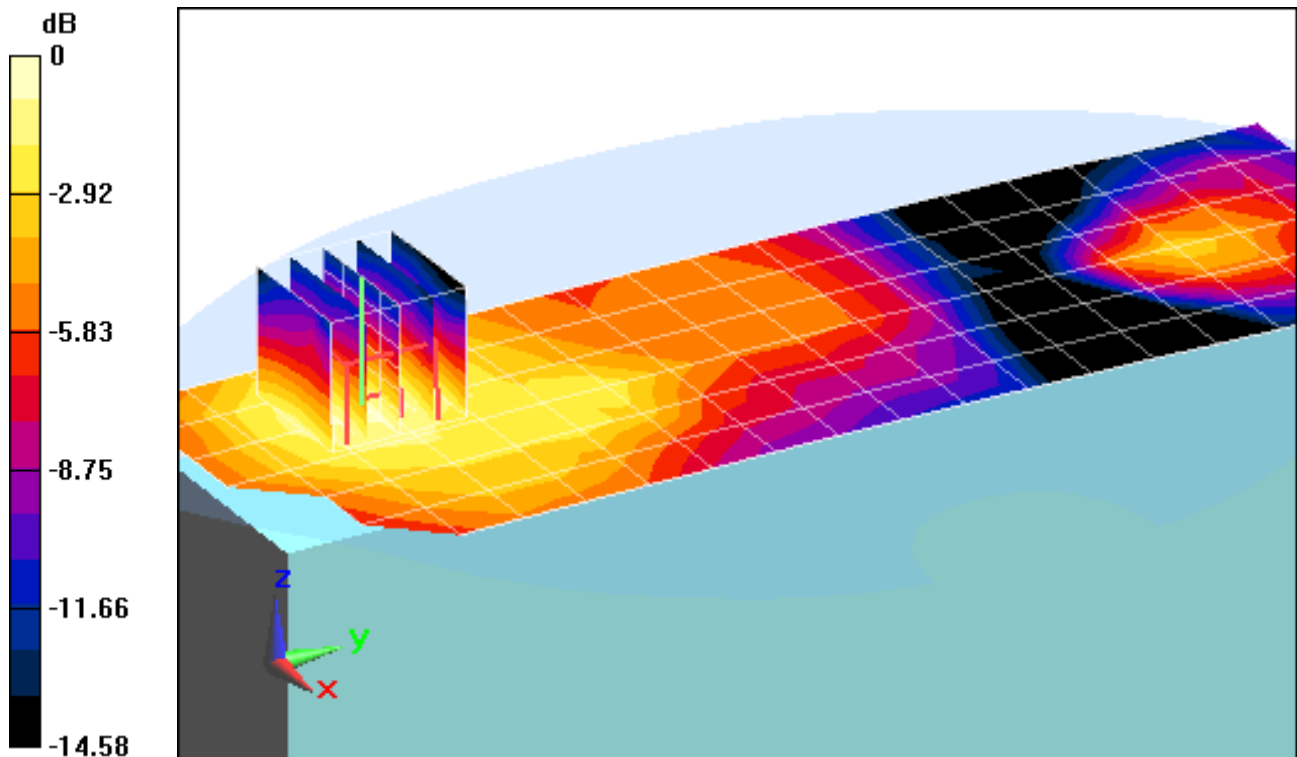

0 dB = 0.110mW/g = -19.17 dB mW/g

# PCTEST ENGINEERING LABORATORY, INC.

**DUT: N7NMC8355; Type: Module in Portable Tablet Computer; Serial: 2DKSA00138**

Communication System: GSM GPRS; 2 Tx slots; Frequency: 1880 MHz; Duty Cycle: 1:4.15

Medium: 1900 Body; Medium parameters used:

$f = 1880 \text{ MHz}$ ;  $\sigma = 1.511 \text{ mho/m}$ ;  $\epsilon_r = 51.79$ ;  $\rho = 1000 \text{ kg/m}^3$

Phantom section: Flat Section; Space: 0.0 cm

Test Date: 05-15-2012; Ambient Temp: 24.2 °C; Tissue Temp: 22.7 °C

Probe: ES3DV3 - SN3209; ConvF(4.63, 4.63, 4.63); Calibrated: 3/16/2012

Sensor-Surface: 4mm (Mechanical Surface Detection)

Electronics: DAE4 Sn1323; Calibrated: 2/15/2012

Phantom: SAM Sub; Type: SAM 4.0; Serial: TP-1357

Measurement SW: DASY4, Version 4.7 (80);SEMCAD X Version 14.6.4 (4989)

**Mode: GPRS 1900, Body SAR, Left Edge, Mid.ch, 2 Tx Slots**

**Area Scan (7x19x1):** Measurement grid: dx=15mm, dy=15mm

**Zoom Scan (5x5x7)/Cube 0:** Measurement grid: dx=8mm, dy=8mm, dz=5mm

Reference Value = 6.349 V/m; Power Drift = -0.19 dB

Peak SAR (extrapolated) = 0.0970 W/kg

**SAR(1 g) = 0.062 mW/g; SAR(10 g) = 0.036 mW/g**

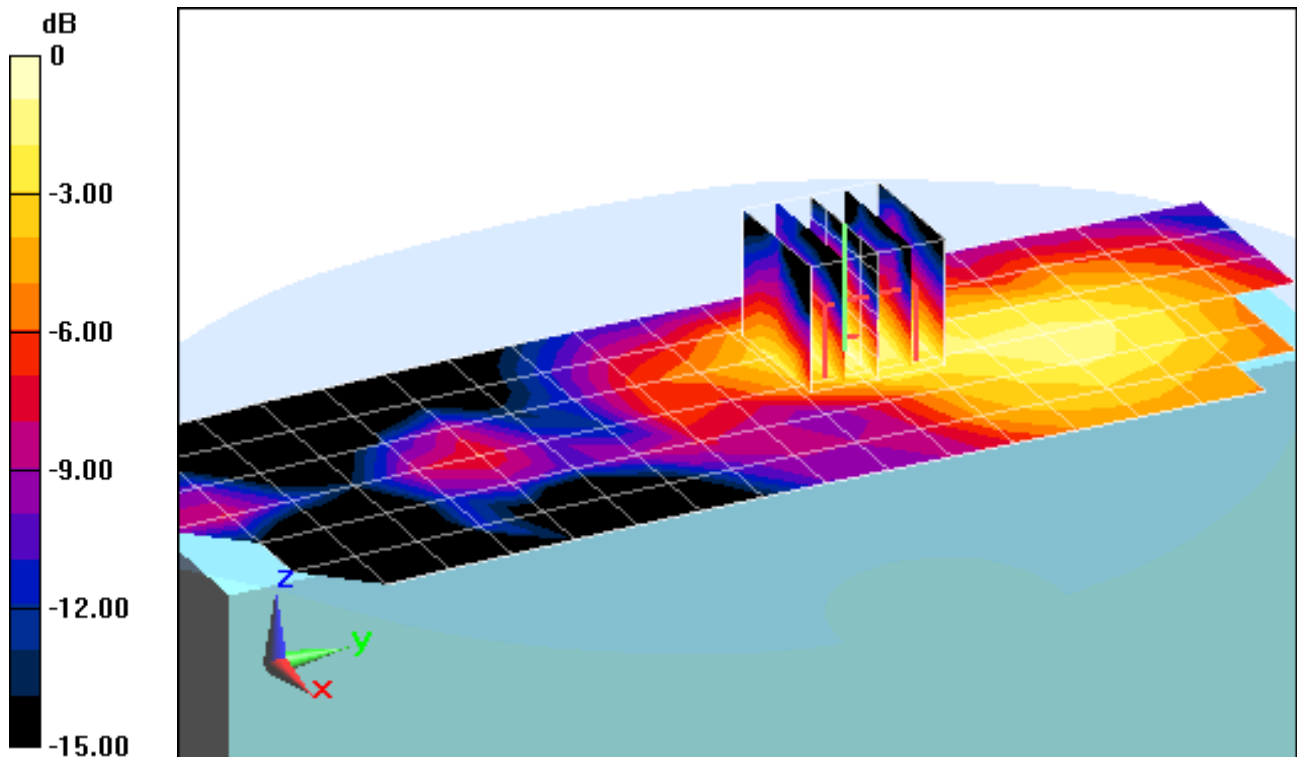

0 dB = 0.070mW/g = -23.10 dB mW/g

# PCTEST ENGINEERING LABORATORY, INC.

**DUT: N7NMC8355; Type: Module in Portable Tablet Computer; Serial: 2DKSA00138**

Communication System: WCDMA; Frequency: 1880 MHz; Duty Cycle: 1:1

Medium: 1900 Body; Medium parameters used:

$f = 1880 \text{ MHz}$ ;  $\sigma = 1.511 \text{ mho/m}$ ;  $\epsilon_r = 51.79$ ;  $\rho = 1000 \text{ kg/m}^3$

Phantom section: Flat Section; Space: 0.0 cm

Test Date: 05-15-2012; Ambient Temp: 24.2 °C; Tissue Temp: 22.7 °C

Probe: ES3DV3 - SN3209; ConvF(4.63, 4.63, 4.63); Calibrated: 3/16/2012

Sensor-Surface: 4mm (Mechanical Surface Detection)

Electronics: DAE4 Sn1323; Calibrated: 2/15/2012

Phantom: SAM Sub; Type: SAM 4.0; Serial: TP-1357

Measurement SW: DASY4, Version 4.7 (80);SEMCAD X Version 14.6.4 (4989)

**Mode: WCDMA 1900, Body SAR, Back side, Mid.ch**

**Area Scan (10x18x1):** Measurement grid: dx=15mm, dy=15mm

**Zoom Scan (5x5x7)/Cube 0:** Measurement grid: dx=8mm, dy=8mm, dz=5mm

Reference Value = 10.493 V/m; Power Drift = 0.0067 dB

Peak SAR (extrapolated) = 0.2230 W/kg

**SAR(1 g) = 0.147 mW/g; SAR(10 g) = 0.096 mW/g**

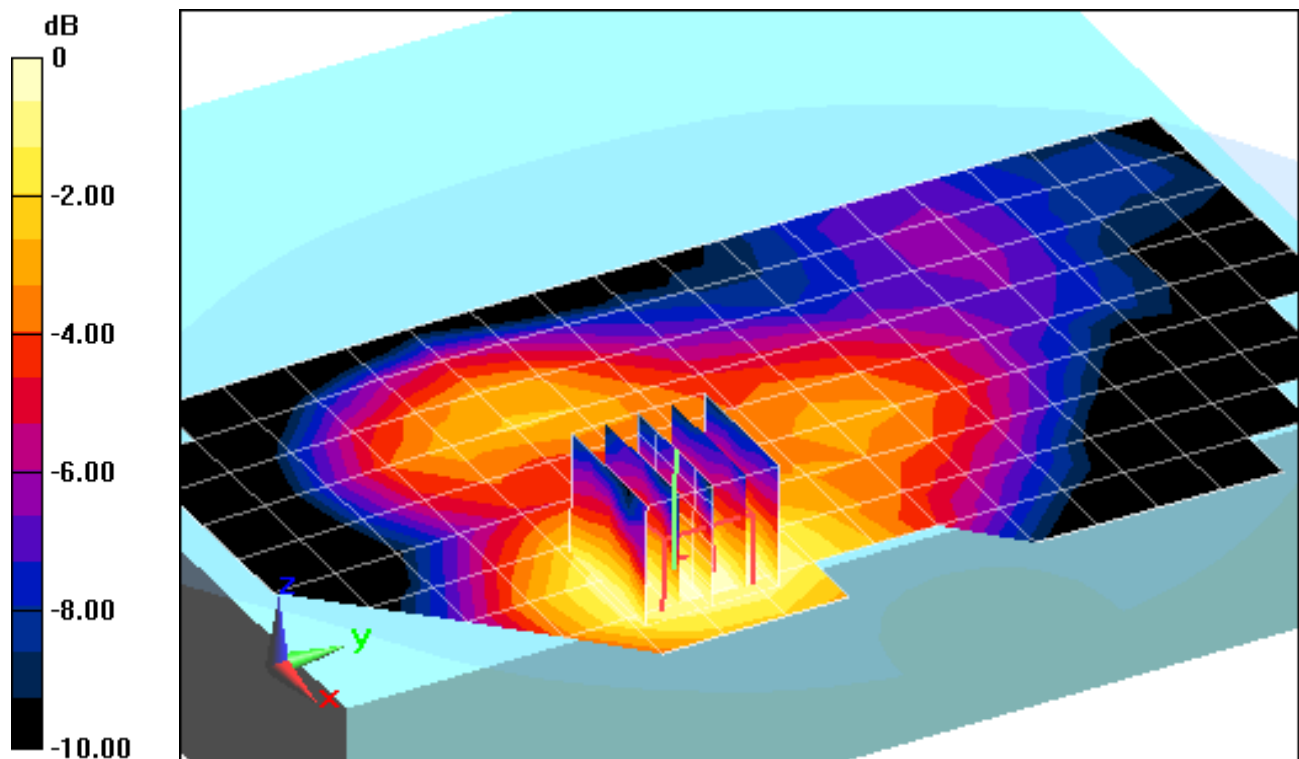

0 dB = 0.160mW/g = -15.92 dB mW/g

# PCTEST ENGINEERING LABORATORY, INC.

**DUT: N7NMC8355; Type: Module in Portable Tablet Computer; Serial: 2DKSA00138**

Communication System: WCDMA; Frequency: 1880 MHz; Duty Cycle: 1:1

Medium: 1900 Body; Medium parameters used:

$f = 1880 \text{ MHz}$ ;  $\sigma = 1.511 \text{ mho/m}$ ;  $\epsilon_r = 51.79$ ;  $\rho = 1000 \text{ kg/m}^3$

Phantom section: Flat Section; Space: 0.0 cm

Test Date: 05-15-2012; Ambient Temp: 24.2 °C; Tissue Temp: 22.7 °C

Probe: ES3DV3 - SN3209; ConvF(4.63, 4.63, 4.63); Calibrated: 3/16/2012

Sensor-Surface: 4mm (Mechanical Surface Detection)

Electronics: DAE4 Sn1323; Calibrated: 2/15/2012

Phantom: SAM Sub; Type: SAM 4.0; Serial: TP-1357

Measurement SW: DASY4, Version 4.7 (80);SEMCAD X Version 14.6.4 (4989)

**Mode: WCDMA 1900, Body SAR, Top Edge, Mid.ch**

**Area Scan (7x19x1):** Measurement grid: dx=15mm, dy=15mm

**Zoom Scan (5x5x7)/Cube 0:** Measurement grid: dx=8mm, dy=8mm, dz=5mm

Reference Value = 10.329 V/m; Power Drift = 0.0055 dB

Peak SAR (extrapolated) = 0.2400 W/kg

**SAR(1 g) = 0.157 mW/g; SAR(10 g) = 0.100 mW/g**

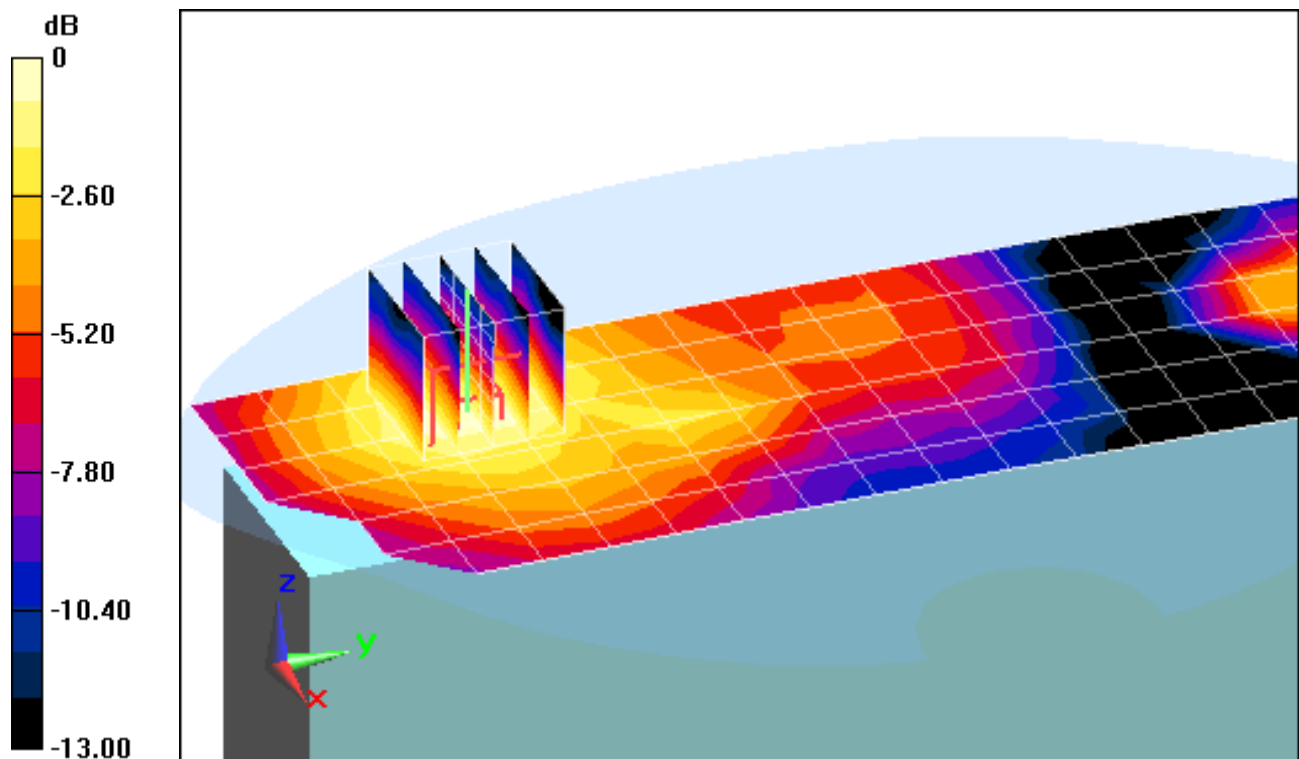

0 dB = 0.170mW/g = -15.39 dB mW/g

# PCTEST ENGINEERING LABORATORY, INC.

**DUT: N7NMC8355; Type: Module in Portable Tablet Computer; Serial: 2DKSA00138**

Communication System: WCDMA; Frequency: 1880 MHz; Duty Cycle: 1:1

Medium: 1900 Body; Medium parameters used:

$f = 1880 \text{ MHz}$ ;  $\sigma = 1.511 \text{ mho/m}$ ;  $\epsilon_r = 51.79$ ;  $\rho = 1000 \text{ kg/m}^3$

Phantom section: Flat Section; Space: 0.0 cm

Test Date: 05-15-2012; Ambient Temp: 24.2 °C; Tissue Temp: 22.7 °C

Probe: ES3DV3 - SN3209; ConvF(4.63, 4.63, 4.63); Calibrated: 3/16/2012

Sensor-Surface: 4mm (Mechanical Surface Detection)

Electronics: DAE4 Sn1323; Calibrated: 2/15/2012

Phantom: SAM Sub; Type: SAM 4.0; Serial: TP-1357

Measurement SW: DASY4, Version 4.7 (80);SEMCAD X Version 14.6.4 (4989)

**Mode: WCDMA 1900, Body SAR, Left Edge, Mid.ch**

**Area Scan (7x19x1):** Measurement grid: dx=15mm, dy=15mm

**Zoom Scan (5x5x7)/Cube 0:** Measurement grid: dx=8mm, dy=8mm, dz=5mm

Reference Value = 8.020 V/m; Power Drift = 0.13 dB

Peak SAR (extrapolated) = 0.1350 W/kg

**SAR(1 g) = 0.088 mW/g; SAR(10 g) = 0.055 mW/g**

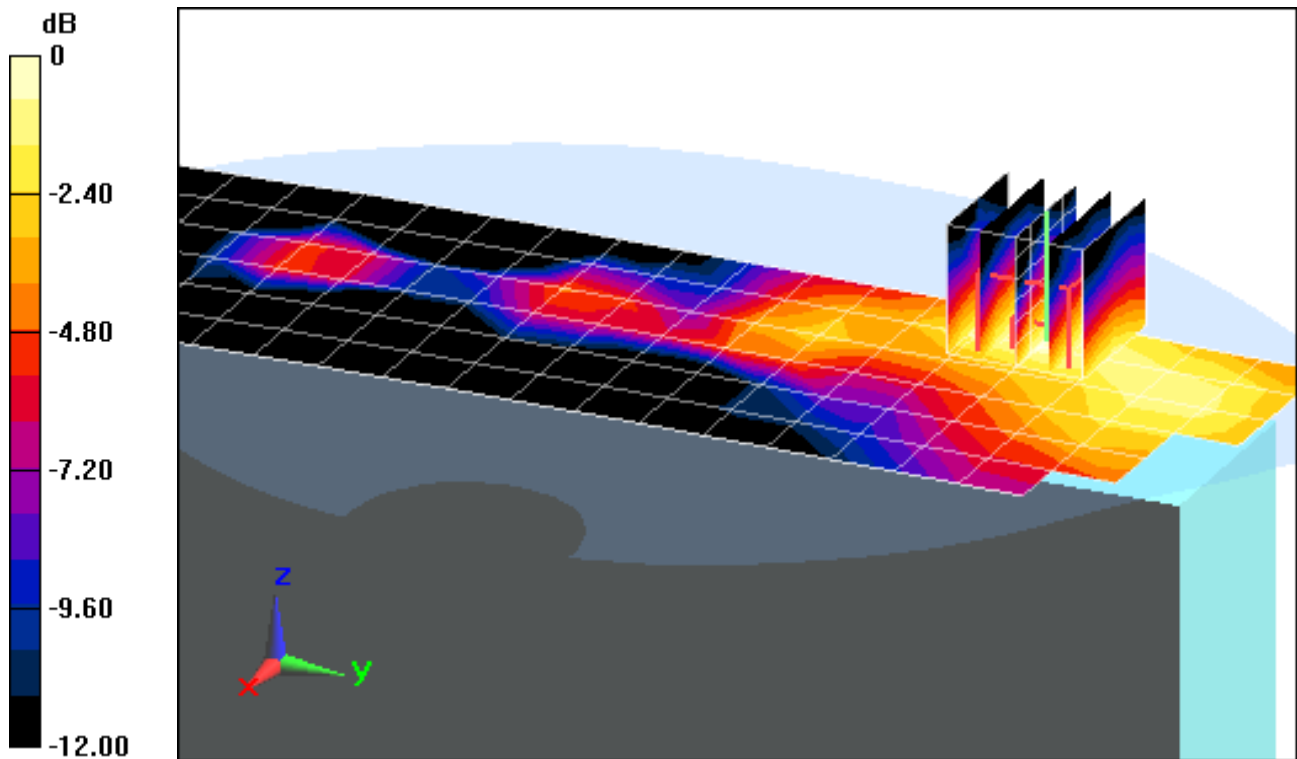

0 dB = 0.100mW/g = -20.00 dB mW/g

# PCTEST ENGINEERING LABORATORY, INC.

**DUT: N7NMC8355; Type: Module in Portable Tablet Computer; Serial: 2DKSA00138**

Communication System: CDMA; Frequency: 1880 MHz; Duty Cycle: 1:1

Medium: 1900 Body; Medium parameters used:

$f = 1880 \text{ MHz}$ ;  $\sigma = 1.502 \text{ mho/m}$ ;  $\epsilon_r = 50.96$ ;  $\rho = 1000 \text{ kg/m}^3$

Phantom section: Flat Section; Space: 0.0 cm

Test Date: 05-16-2012; Ambient Temp: 24.3°C; Tissue Temp: 23.2°C

Probe: EX3DV4 - SN3561; ConvF(6.58, 6.58, 6.58); Calibrated: 7/27/2011

Sensor-Surface: 4mm (Mechanical Surface Detection)

Electronics: DAE4 Sn1333; Calibrated: 4/12/2012

Phantom: SAM 5.0 front; Type: QD000P40CD; Serial: TP:-1648

Measurement SW: DASY52, Version 52.8 (0);SEMCAD X Version 14.6.4 (4989)

**Mode: PCS EVDO, Body SAR, Back side, Mid.ch**

**Area Scan (9x21x1):** Measurement grid: dx=15mm, dy=15mm

**Zoom Scan (5x5x7)/Cube 0:** Measurement grid: dx=8mm, dy=8mm, dz=5mm

Reference Value = 9.708 V/m; Power Drift = -0.02 dB

Peak SAR (extrapolated) = 0.2230 W/kg

**SAR(1 g) = 0.133 mW/g; SAR(10 g) = 0.081 mW/g**

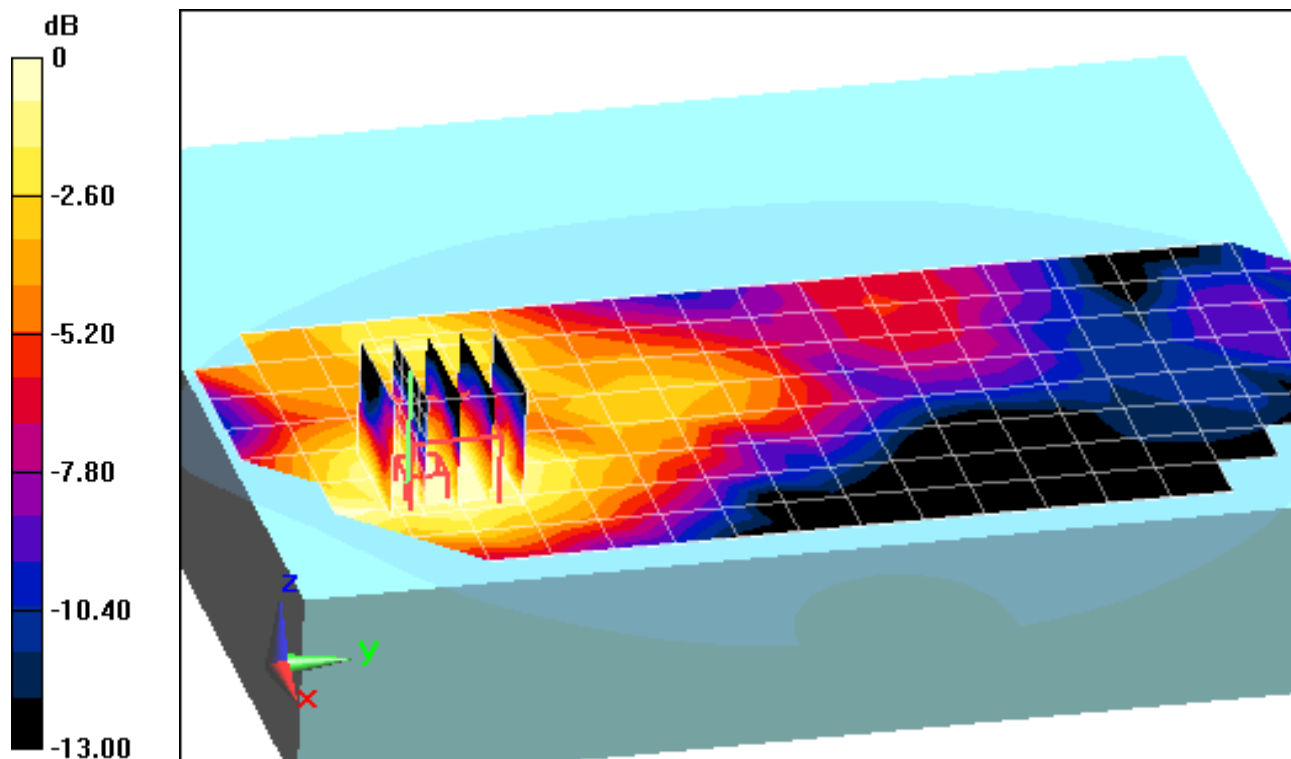

0 dB = 0.140mW/g = -17.08 dB mW/g

# PCTEST ENGINEERING LABORATORY, INC.

**DUT: N7NMC8355; Type: Module in Portable Tablet Computer; Serial: 2DKSA00138**

Communication System: CDMA; Frequency: 1880 MHz; Duty Cycle: 1:1

Medium: 1900 Body; Medium parameters used:

$f = 1880 \text{ MHz}$ ;  $\sigma = 1.502 \text{ mho/m}$ ;  $\epsilon_r = 50.96$ ;  $\rho = 1000 \text{ kg/m}^3$

Phantom section: Flat Section; Space: 0.0 cm

Test Date: 05-16-2012; Ambient Temp: 24.3°C; Tissue Temp: 23.2°C

Probe: EX3DV4 - SN3561; ConvF(6.58, 6.58, 6.58); Calibrated: 7/27/2011

Sensor-Surface: 4mm (Mechanical Surface Detection)

Electronics: DAE4 Sn1333; Calibrated: 4/12/2012

Phantom: SAM 5.0 front; Type: QD000P40CD; Serial: TP:-1648

Measurement SW: DASY52, Version 52.8 (0);SEMCAD X Version 14.6.4 (4989)

**Mode: PCS EVDO, Body SAR, Top Edge, Mid.ch**

**Area Scan (9x21x1):** Measurement grid: dx=15mm, dy=15mm

**Zoom Scan (5x5x7)/Cube 0:** Measurement grid: dx=8mm, dy=8mm, dz=5mm

Reference Value = 8.934 V/m; Power Drift = 0.06 dB

Peak SAR (extrapolated) = 0.2590 W/kg

**SAR(1 g) = 0.117 mW/g; SAR(10 g) = 0.073 mW/g**

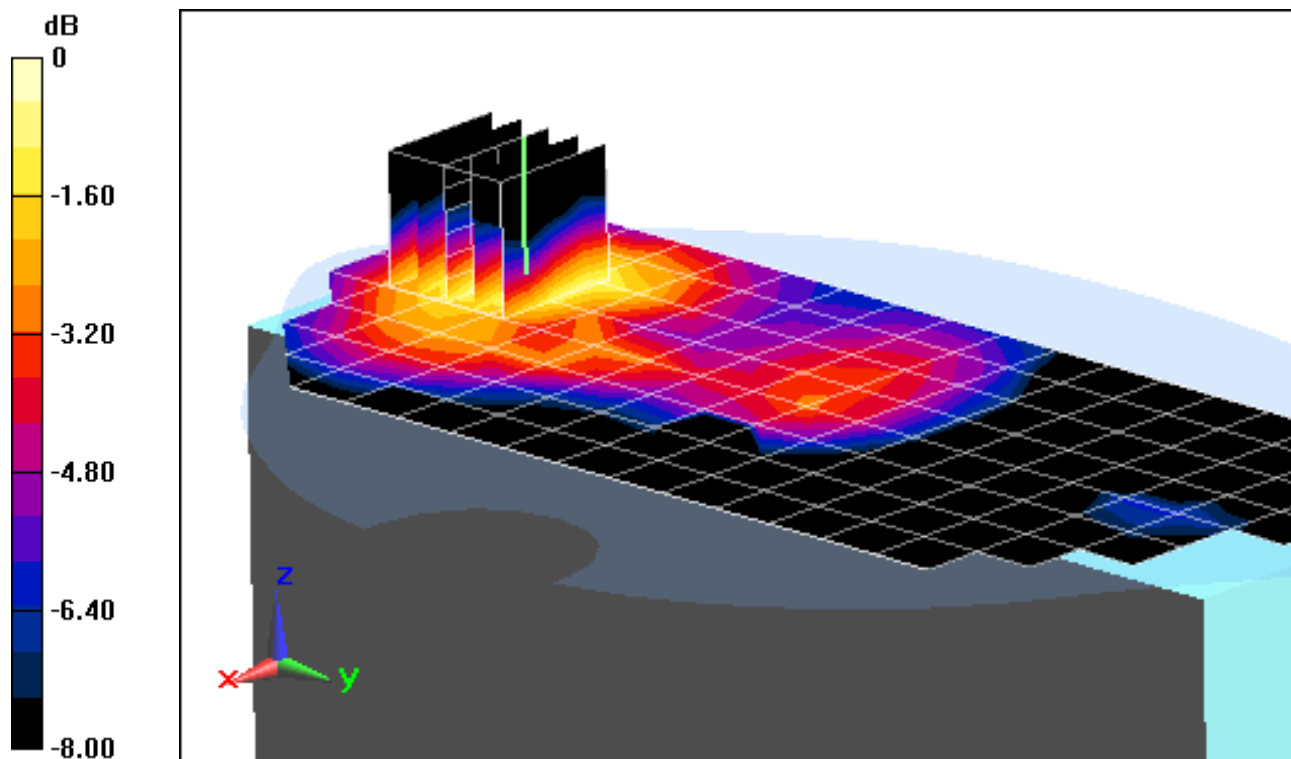

0 dB = 0.130mW/g = -17.72 dB mW/g



# PCTEST ENGINEERING LABORATORY, INC.

**DUT: N7NMC8355; Type: Module in Portable Tablet Computer; Serial: 2DKSA00138**

Communication System: CDMA; Frequency: 1880 MHz; Duty Cycle: 1:1

Medium: 1900 Body; Medium parameters used:

$f = 1880 \text{ MHz}$ ;  $\sigma = 1.502 \text{ mho/m}$ ;  $\epsilon_r = 50.96$ ;  $\rho = 1000 \text{ kg/m}^3$

Phantom section: Flat Section; Space: 0.0 cm

Test Date: 05-16-2012; Ambient Temp: 24.3°C; Tissue Temp: 23.2°C

Probe: EX3DV4 - SN3561; ConvF(6.58, 6.58, 6.58); Calibrated: 7/27/2011

Sensor-Surface: 4mm (Mechanical Surface Detection)

Electronics: DAE4 Sn1333; Calibrated: 4/12/2012

Phantom: SAM 5.0 front; Type: QD000P40CD; Serial: TP:-1648

Measurement SW: DASY52, Version 52.8 (0);SEMCAD X Version 14.6.4 (4989)

**Mode: PCS EVDO, Body SAR, Left Edge, Mid.ch**

**Area Scan (9x21x1):** Measurement grid: dx=15mm, dy=15mm

**Zoom Scan (5x5x7)/Cube 0:** Measurement grid: dx=8mm, dy=8mm, dz=5mm

Reference Value = 9.553 V/m; Power Drift = -0.12 dB

Peak SAR (extrapolated) = 0.2320 W/kg

**SAR(1 g) = 0.131 mW/g; SAR(10 g) = 0.073 mW/g**

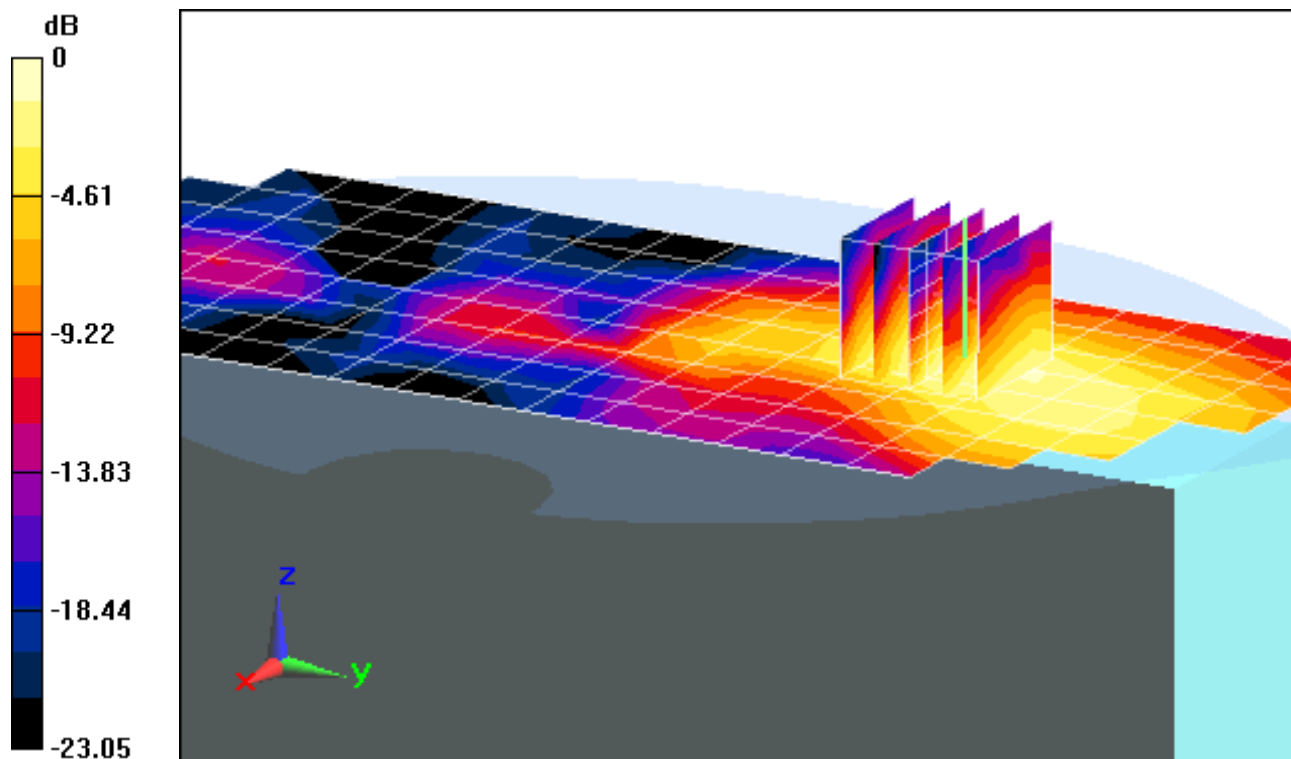

0 dB = 0.140mW/g = -17.08 dB mW/g



## APPENDIX B: SYSTEM VERIFICATION

# PCTEST ENGINEERING LABORATORY, INC.

**DUT: Dipole 835 MHz; Type: D835V2; Serial: 4d026**

Communication System: CW; Frequency: 835 MHz; Duty Cycle: 1:1

Medium: 835 Body; Medium parameters used:

$f = 835 \text{ MHz}$ ;  $\sigma = 0.975 \text{ mho/m}$ ;  $\epsilon_r = 53.12$ ;  $\rho = 1000 \text{ kg/m}^3$

Phantom section: Flat Section; Space: 1.5 cm

Test Date: 05-15-2012; Ambient Temp: 23.1°C; Tissue Temp: 21.8°C

Probe: ES3DV3 - SN3258; ConvF(6.06, 6.06, 6.06); Calibrated: 2/21/2012

Sensor-Surface: 4mm (Mechanical Surface Detection)

Electronics: DAE4 Sn1272; Calibrated: 1/18/2012

Phantom: SAM Main; Type: SAM 4.0; Serial: TP-1406

Measurement SW: DASY4, V4.7 Build 80; SEMCAD X Version 14.6.4 (4989)

## 835MHz System Verification

**Area Scan (7x13x1):** Measurement grid: dx=15mm, dy=15mm

**Zoom Scan (5x5x7)/Cube 0:** Measurement grid: dx=8mm, dy=8mm, dz=5mm

Input Power = 20.0 dBm (100 mW)

**SAR(1 g) = 0.982 mW/g; SAR(10 g) = 0.646 mW/g**

Deviation = 1.66%

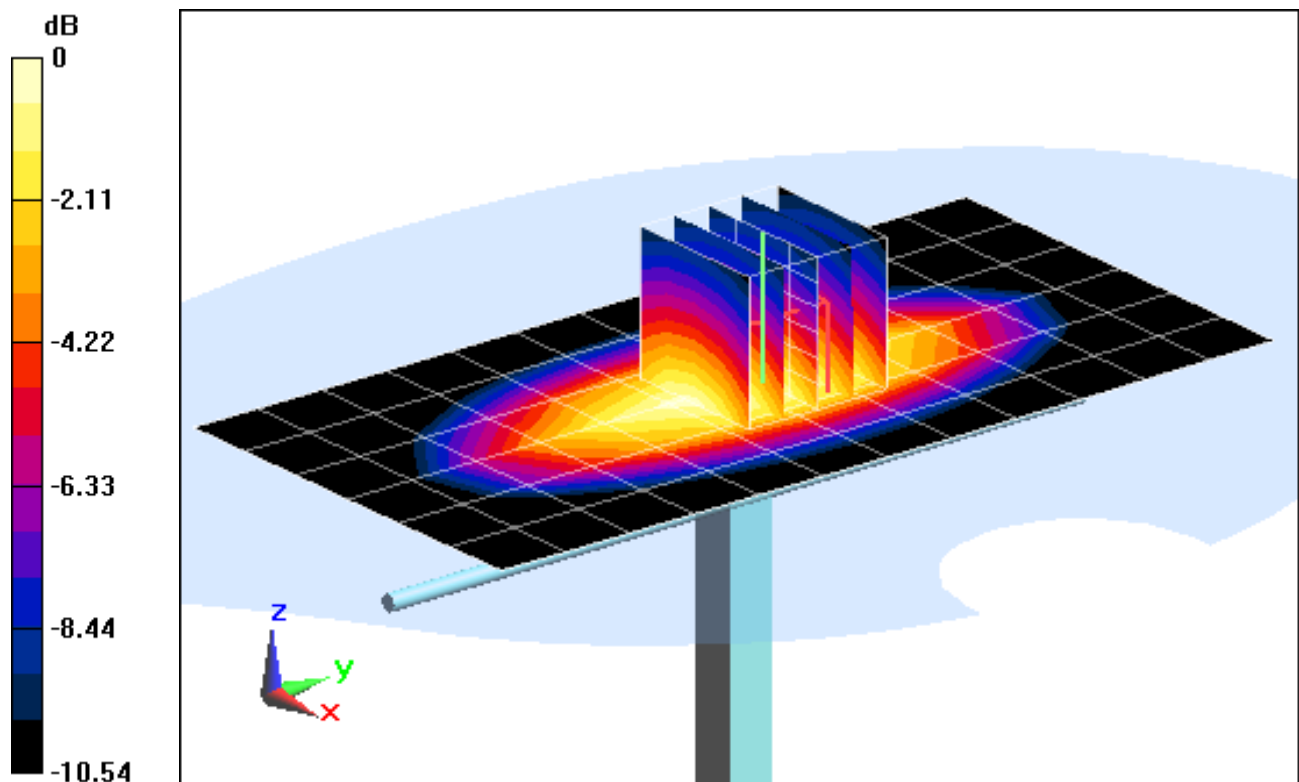

0 dB = 1.060mW/g = 0.51 dB mW/g

# PCTEST ENGINEERING LABORATORY, INC.

**DUT: Dipole 835 MHz; Type: D835V2; Serial: 4d026**

Communication System: CW; Frequency: 835 MHz; Duty Cycle: 1:1

Medium: 835 Body; Medium parameters used:

$f = 835 \text{ MHz}$ ;  $\sigma = 0.975 \text{ mho/m}$ ;  $\epsilon_r = 53.12$ ;  $\rho = 1000 \text{ kg/m}^3$

Phantom section: Flat Section; Space: 1.5 cm

Test Date: 05-15-2012; Ambient Temp: 23.1°C; Tissue Temp: 21.8°C

Probe: ES3DV3 - SN3258; ConvF(6.06, 6.06, 6.06); Calibrated: 2/21/2012

Sensor-Surface: 4mm (Mechanical Surface Detection)

Electronics: DAE4 Sn1272; Calibrated: 1/18/2012

Phantom: SAM Main; Type: SAM 4.0; Serial: TP-1406

Measurement SW: DASY4, V4.7 Build 80; SEMCAD X Version 14.6.4 (4989)

## 835MHz System Verification

**Area Scan (7x13x1):** Measurement grid: dx=15mm, dy=15mm

**Zoom Scan (5x5x7)/Cube 0:** Measurement grid: dx=8mm, dy=8mm, dz=5mm

Input Power = 20.0 dBm (100 mW)

**SAR(1 g) = 0.982 mW/g; SAR(10 g) = 0.646 mW/g**

Deviation = 1.66%

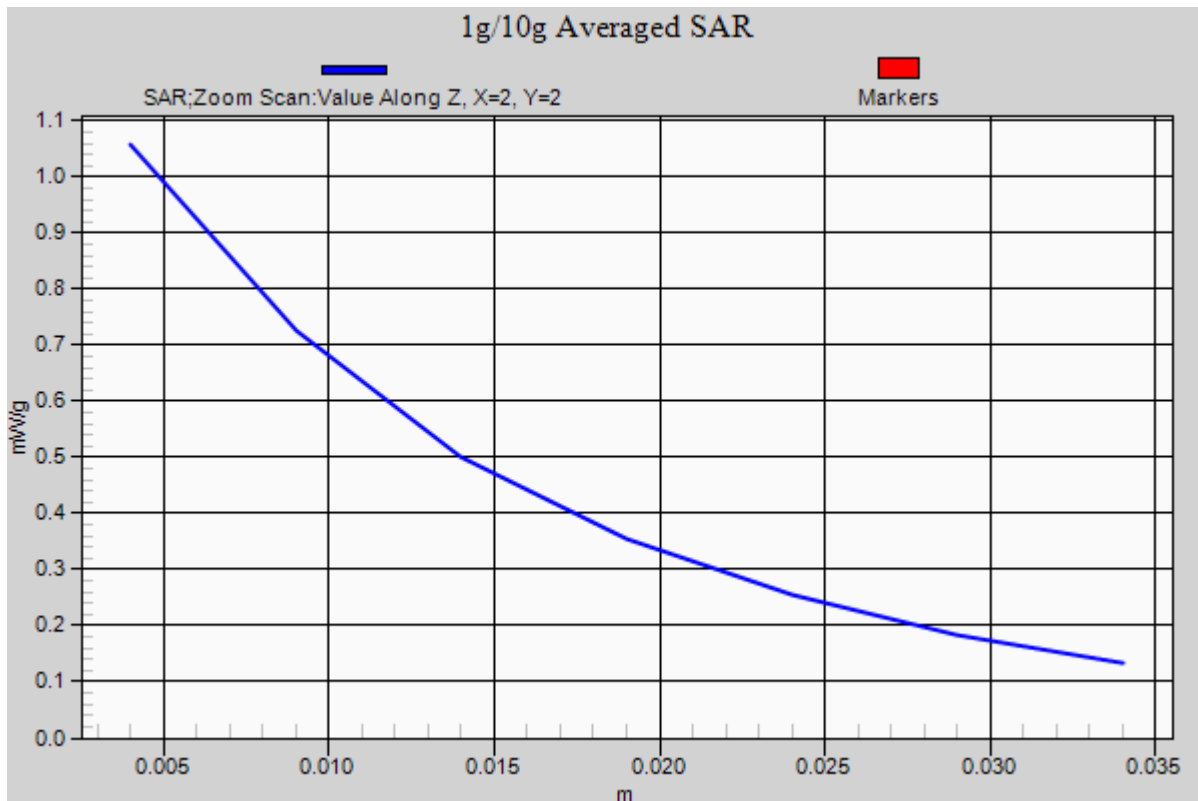

# PCTEST ENGINEERING LABORATORY, INC.

**DUT: SAR Dipole 835 MHz; Type: D835V2; Serial: 4d047**

Communication System: CW; Frequency: 835 MHz; Duty Cycle: 1:1  
Medium: 835 Body Medium parameters used:

$f = 835 \text{ MHz}$ ;  $\sigma = 0.972 \text{ mho/m}$ ;  $\epsilon_r = 52.99$ ;  $\rho = 1000 \text{ kg/m}^3$

Phantom section: Flat Section; Space: 1.5 cm

Test Date: 05-21-2012; Ambient Temp: 23.9°C; Tissue Temp: 22.4°C

Probe: EX3DV4 - SN3561; ConvF(8.25, 8.25, 8.25); Calibrated: 7/27/2011

Sensor-Surface: 4mm (Mechanical Surface Detection)

Electronics: DAE4 Sn1333; Calibrated: 4/12/2012

Phantom: SAM 5.0 front; Type: QD000P40CD; Serial: TP:-1648

Measurement SW: DASY52, Version 52.8 (0); SEMCAD X Version 14.6.4 (4989)

## 835 MHz System Verification

**Area Scan (7x14x1):** Measurement grid: dx=15mm, dy=15mm

**Zoom Scan (5x5x7)/Cube 0:** Measurement grid: dx=8mm, dy=8mm, dz=5mm

Input Power = 24.0 dBm (250 mW)

**SAR(1 g) = 2.47 mW/g; SAR(10 g) = 1.63 mW/g**

Deviation = 4.99 %

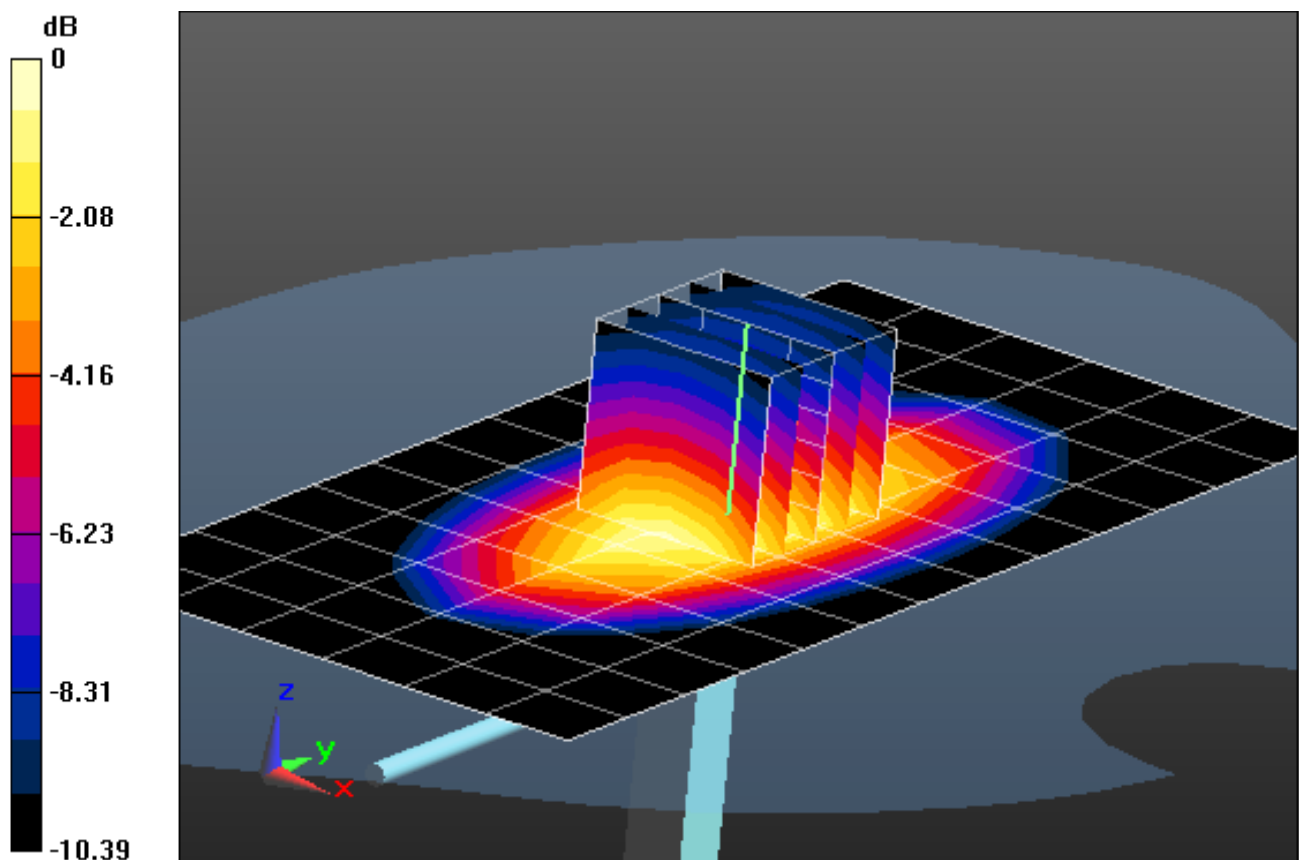

0 dB = 2.670mW/g = 8.53 dB mW/g

# PCTEST ENGINEERING LABORATORY, INC.

**DUT: SAR Dipole 835 MHz; Type: D835V2; Serial: 4d047**

Communication System: CW; Frequency: 835 MHz; Duty Cycle: 1:1

Medium: 835 Body Medium parameters used:

$f = 835 \text{ MHz}$ ;  $\sigma = 0.972 \text{ mho/m}$ ;  $\epsilon_r = 52.99$ ;  $\rho = 1000 \text{ kg/m}^3$

Phantom section: Flat Section; Space: 1.5 cm

Test Date: 05-21-2012; Ambient Temp: 23.9°C; Tissue Temp: 22.4°C

Probe: EX3DV4 - SN3561; ConvF(8.25, 8.25, 8.25); Calibrated: 7/27/2011

Sensor-Surface: 4mm (Mechanical Surface Detection)

Electronics: DAE4 Sn1333; Calibrated: 4/12/2012

Phantom: SAM 5.0 front; Type: QD000P40CD; Serial: TP:-1648

Measurement SW: DASY52, Version 52.8 (0); SEMCAD X Version 14.6.4 (4989)

## 835 MHz System Verification

**Area Scan (7x14x1):** Measurement grid: dx=15mm, dy=15mm

**Zoom Scan (5x5x7)/Cube 0:** Measurement grid: dx=8mm, dy=8mm, dz=5mm

Input Power = 24.0 dBm (250 mW)

**SAR(1 g) = 2.47 mW/g; SAR(10 g) = 1.63 mW/g**

Deviation = 4.99 %

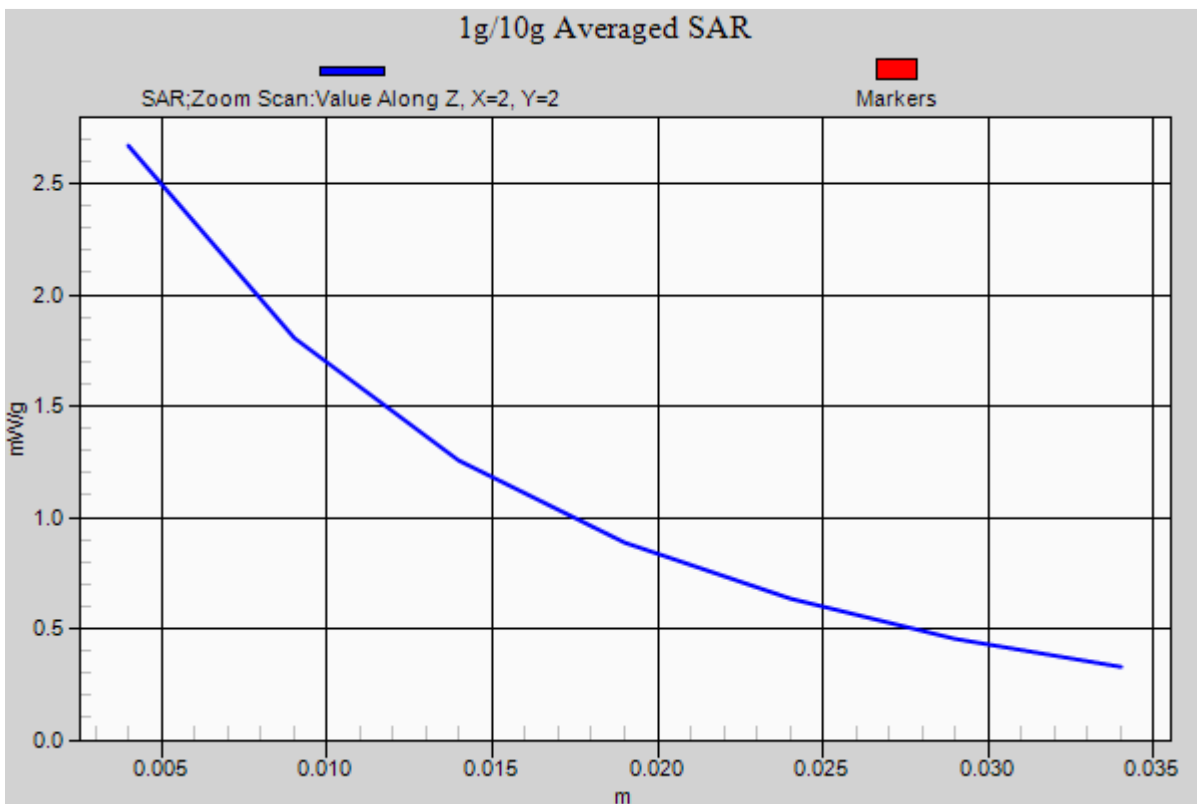

# PCTEST ENGINEERING LABORATORY, INC.

**DUT: Dipole 1750 MHz; Type: D1750V2; Serial: 1051**

Communication System: CW; Frequency: 1750 MHz; Duty Cycle: 1:1

Medium: 1750 Body; Medium parameters used:

$f = 1750 \text{ MHz}$ ;  $\sigma = 1.508 \text{ mho/m}$ ;  $\epsilon_r = 52.56$ ;  $\rho = 1000 \text{ kg/m}^3$

Phantom section: Flat Section; Space: 1.0 cm

Test Date: 05-21-2012; Ambient Temp: 24.5°C; Tissue Temp: 22.6°C

Probe: ES3DV2 - SN3022; ConvF(4.64, 4.64, 4.64); Calibrated: 8/25/2011

Sensor-Surface: 4mm (Mechanical Surface Detection)

Electronics: DAE4 Sn665; Calibrated: 4/19/2012

Phantom: SAM Sub Dasy B; Type: SAM 5.0; Serial: TP-1626

Measurement SW: DASY4, Version 4.7 (80);SEMCAD X Version 14.6.4 (4989)

## 1750 MHz System Verification

**Area Scan (6x6x1):** Measurement grid: dx=15mm, dy=15mm

**Zoom Scan (5x5x7)/Cube 0:** Measurement grid: dx=8mm, dy=8mm, dz=5mm

Input Power = 20.0 dBm (100 mW)

**SAR(1 g) = 3.72 mW/g; SAR(10 g) = 1.95 mW/g**

Deviation = -1.06%

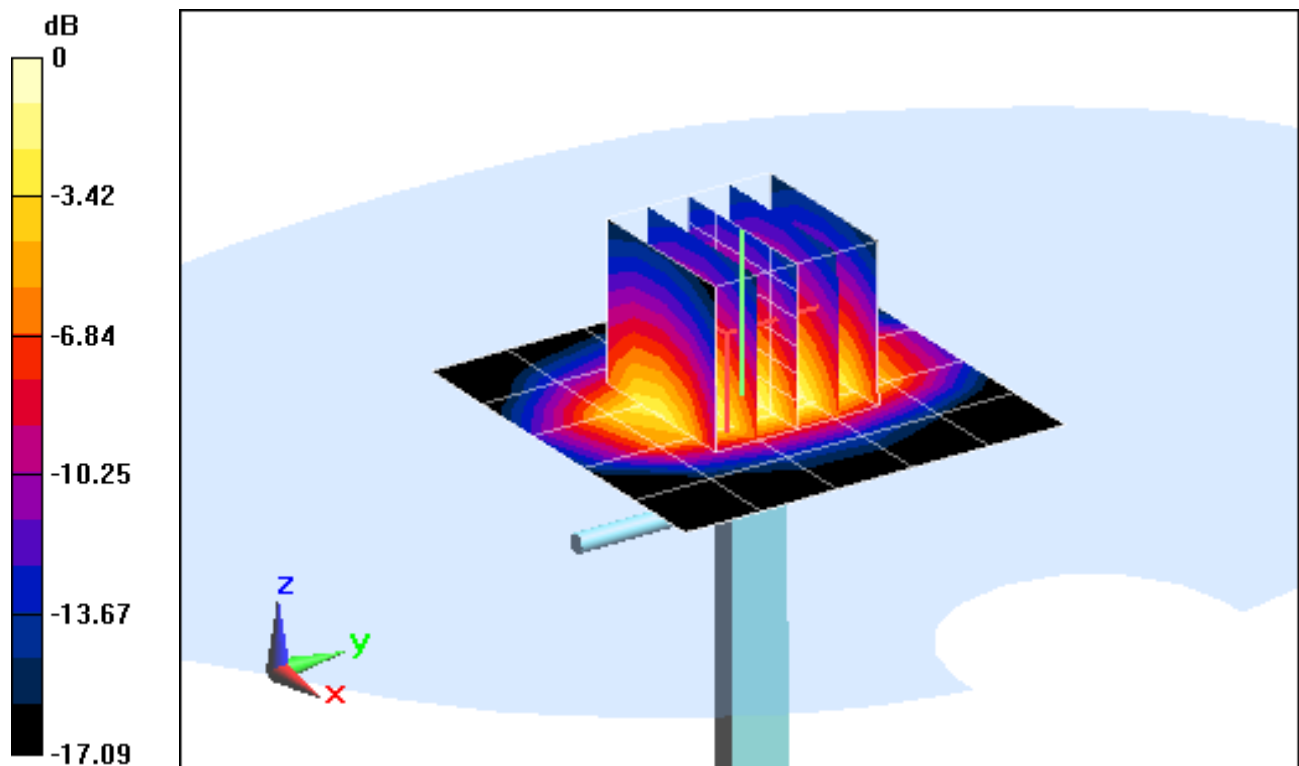

0 dB = 4.110mW/g = 12.28 dB mW/g

# PCTEST ENGINEERING LABORATORY, INC.

**DUT: Dipole 1750 MHz; Type: D1750V2; Serial: 1051**

Communication System: CW; Frequency: 1750 MHz; Duty Cycle: 1:1

Medium: 1750 Body; Medium parameters used:

$f = 1750 \text{ MHz}$ ;  $\sigma = 1.508 \text{ mho/m}$ ;  $\epsilon_r = 52.56$ ;  $\rho = 1000 \text{ kg/m}^3$

Phantom section: Flat Section; Space: 1.0 cm

Test Date: 05-21-2012; Ambient Temp: 24.5°C; Tissue Temp: 22.6°C

Probe: ES3DV2 - SN3022; ConvF(4.64, 4.64, 4.64); Calibrated: 8/25/2011

Sensor-Surface: 4mm (Mechanical Surface Detection)

Electronics: DAE4 Sn665; Calibrated: 4/19/2012

Phantom: SAM Sub Dasy B; Type: SAM 5.0; Serial: TP-1626

Measurement SW: DASY4, Version 4.7 (80);SEMCAD X Version 14.6.4 (4989)

## 1750 MHz System Verification

**Area Scan (6x6x1):** Measurement grid: dx=15mm, dy=15mm

**Zoom Scan (5x5x7)/Cube 0:** Measurement grid: dx=8mm, dy=8mm, dz=5mm

Input Power = 20.0 dBm (100 mW)

**SAR(1 g) = 3.72 mW/g; SAR(10 g) = 1.95 mW/g**

Deviation = -1.06%

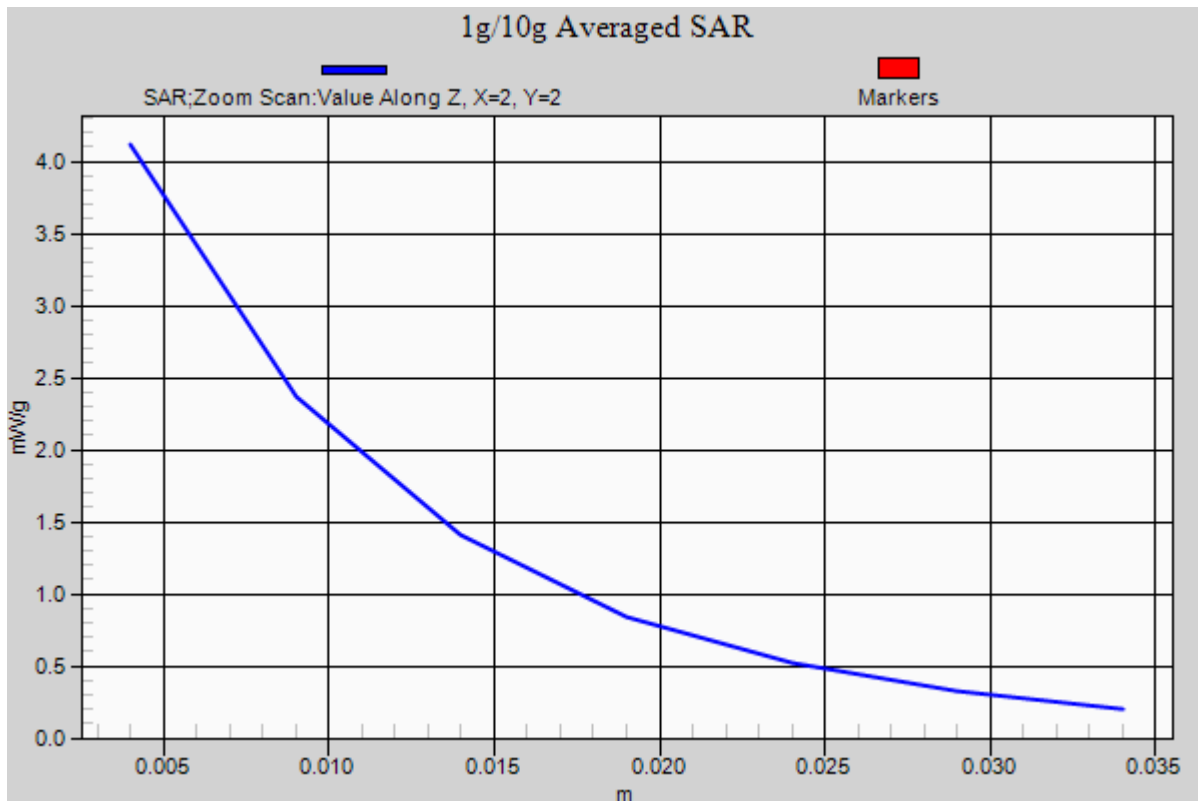

# PCTEST ENGINEERING LABORATORY, INC.

**DUT: SAR Dipole 1900 MHz; Type: D1900V2; Serial: 5d080**

Communication System: CW; Frequency: 1900 MHz; Duty Cycle: 1:1

Medium: 1900 Body; Medium parameters used (interpolated):

$f = 1900 \text{ MHz}$ ;  $\sigma = 1.529 \text{ mho/m}$ ;  $\epsilon_r = 51.777$ ;  $\rho = 1000 \text{ kg/m}^3$

Phantom section: Flat Section; Space: 1.0 cm

Test Date: 05-15-2012; Ambient Temp: 24.2 °C; Tissue Temp: 22.7 °C

Probe: ES3DV3 - SN3209; ConvF(4.63, 4.63, 4.63); Calibrated: 3/16/2012

Sensor-Surface: 4mm (Mechanical Surface Detection)

Electronics: DAE4 Sn1323; Calibrated: 2/15/2012

Phantom: SAM Sub; Type: SAM 4.0; Serial: TP-1357

Measurement SW: DASY4, Version 4.7 (80);SEMCAD X Version 14.6.4 (4989)

## 1900MHz System Verification

**Area Scan (5x7x1):** Measurement grid: dx=15mm, dy=15mm

**Zoom Scan (5x5x7)/Cube 0:** Measurement grid: dx=8mm, dy=8mm, dz=5mm

Input Power = 20.0 dBm (100 mW)

**SAR(1 g) = 4.17 mW/g; SAR(10 g) = 2.16 mW/g**

Deviation = 1.96%

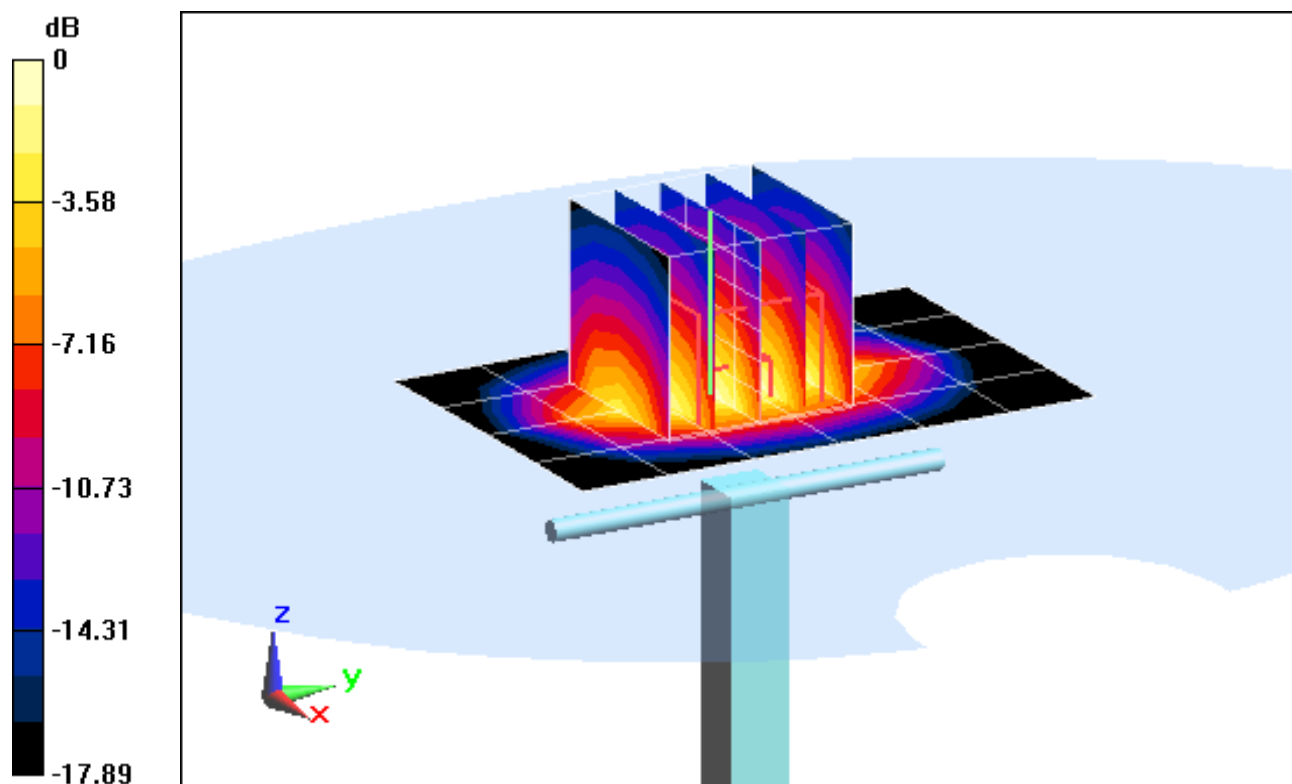

0 dB = 4.660mW/g = 13.37 dB mW/g



# PCTEST ENGINEERING LABORATORY, INC.

**DUT: SAR Dipole 1900 MHz; Type: D1900V2; Serial: 5d080**

Communication System: CW; Frequency: 1900 MHz; Duty Cycle: 1:1

Medium: 1900 Body; Medium parameters used (interpolated):

$f = 1900 \text{ MHz}$ ;  $\sigma = 1.529 \text{ mho/m}$ ;  $\epsilon_r = 51.777$ ;  $\rho = 1000 \text{ kg/m}^3$

Phantom section: Flat Section; Space: 1.0 cm

Test Date: 05-15-2012; Ambient Temp: 24.2 °C; Tissue Temp: 22.7 °C

Probe: ES3DV3 - SN3209; ConvF(4.63, 4.63, 4.63); Calibrated: 3/16/2012

Sensor-Surface: 4mm (Mechanical Surface Detection)

Electronics: DAE4 Sn1323; Calibrated: 2/15/2012

Phantom: SAM Sub; Type: SAM 4.0; Serial: TP-1357

Measurement SW: DASY4, Version 4.7 (80);SEMCAD X Version 14.6.4 (4989)

## 1900MHz System Verification

**Area Scan (5x7x1):** Measurement grid: dx=15mm, dy=15mm

**Zoom Scan (5x5x7)/Cube 0:** Measurement grid: dx=8mm, dy=8mm, dz=5mm

Input Power = 20.0 dBm (100 mW)

**SAR(1 g) = 4.17 mW/g; SAR(10 g) = 2.16 mW/g**

Deviation = 1.96%

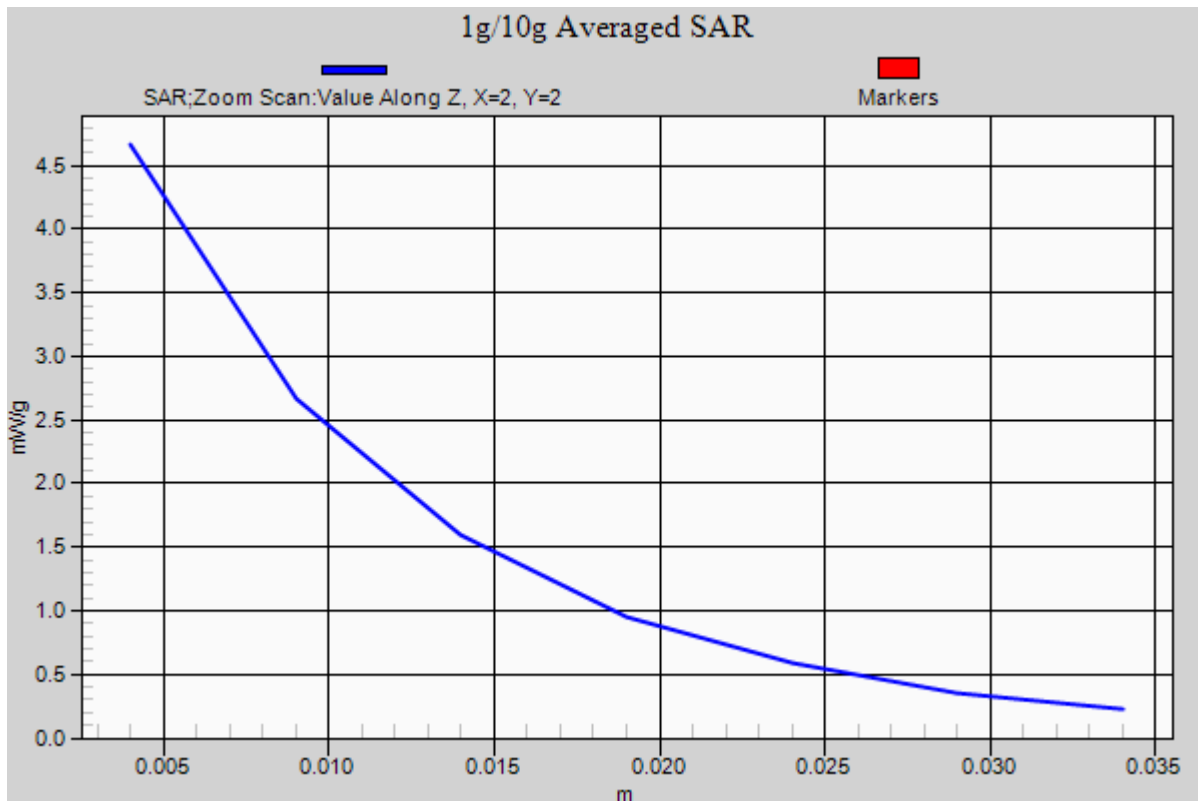

# PCTEST ENGINEERING LABORATORY, INC.

**DUT: SAR Dipole 1900 MHz; Type: D1900V2; Serial: 5d149**

Communication System: CW; Frequency: 1900 MHz; Duty Cycle: 1:1

Medium: 1900 Body; Medium parameters used (interpolated):

$f = 1900 \text{ MHz}$ ;  $\sigma = 1.523 \text{ mho/m}$ ;  $\epsilon_r = 50.907$ ;  $\rho = 1000 \text{ kg/m}^3$

Phantom section: Flat Section; Space: 1.0 cm

Test Date: 05-16-2012; Ambient Temp: 24.3°C; Tissue Temp: 23.2°C

Probe: EX3DV4 - SN3561; ConvF(6.58, 6.58, 6.58); Calibrated: 7/27/2011

Sensor-Surface: 4mm (Mechanical Surface Detection)

Electronics: DAE4 Sn1333; Calibrated: 4/12/2012

Phantom: SAM 5.0 front; Type: SAM v5.0; Serial: TP:-1648

Measurement SW: DASY52, Version 52.8 (0);SEMCAD X Version 14.6.4 (4989)

## 1900 MHz System Verification

**Area Scan (7x9x1):** Measurement grid: dx=15mm, dy=15mm

**Zoom Scan (5x5x7)/Cube 0:** Measurement grid: dx=8mm, dy=8mm, dz=5mm

Input Power = 20.0 dB (100 mW)

**SAR(1 g) = 4.18 mW/g; SAR(10 g) = 2.21 mW/g**

Deviation = 6.36%

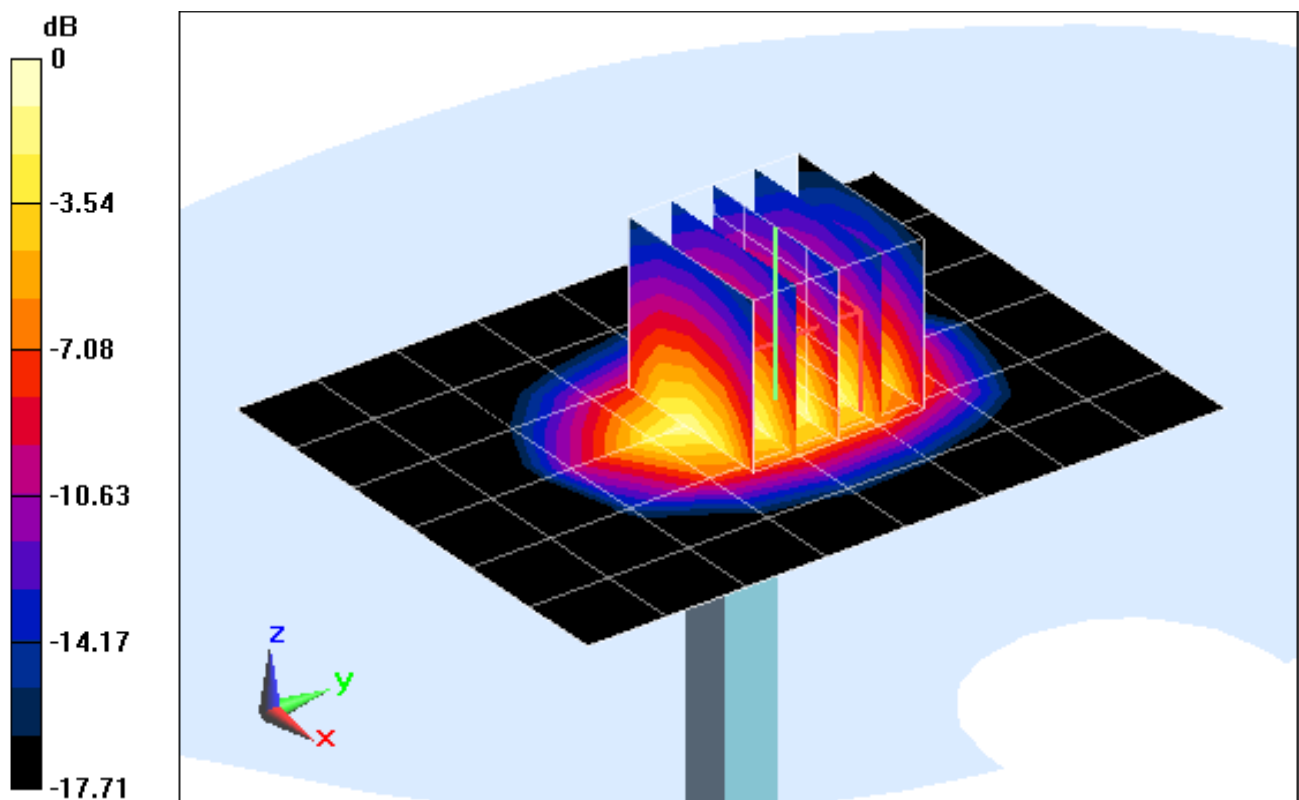

0 dB = 4.650mW/g = 13.35 dB mW/g

# PCTEST ENGINEERING LABORATORY, INC.

**DUT: SAR Dipole 1900 MHz; Type: D1900V2; Serial: 5d149**

Communication System: CW; Frequency: 1900 MHz; Duty Cycle: 1:1

Medium: 1900 Body; Medium parameters used (interpolated):

$f = 1900 \text{ MHz}$ ;  $\sigma = 1.523 \text{ mho/m}$ ;  $\epsilon_r = 50.907$ ;  $\rho = 1000 \text{ kg/m}^3$

Phantom section: Flat Section; Space: 1.0 cm

Test Date: 05-16-2012; Ambient Temp: 24.3°C; Tissue Temp: 23.2°C

Probe: EX3DV4 - SN3561; ConvF(6.58, 6.58, 6.58); Calibrated: 7/27/2011

Sensor-Surface: 4mm (Mechanical Surface Detection)

Electronics: DAE4 Sn1333; Calibrated: 4/12/2012

Phantom: SAM 5.0 front; Type: SAM v5.0; Serial: TP:-1648

Measurement SW: DASY52, Version 52.8 (0);SEMCAD X Version 14.6.4 (4989)

## 1900 MHz System Verification

**Area Scan (7x9x1):** Measurement grid: dx=15mm, dy=15mm

**Zoom Scan (5x5x7)/Cube 0:** Measurement grid: dx=8mm, dy=8mm, dz=5mm

Input Power = 20.0 dB (100 mW)

**SAR(1 g) = 4.18 mW/g; SAR(10 g) = 2.21 mW/g**

Deviation = 6.36%

