

FCC Part22H&24E Test Report

Product Name : Wireless Module
Model No. : MC7304
FCC ID : N7NMC7304
IC : 2417C-MC7304

Applicant : SIERRA WIRELESS Inc.

Address : 13811 Wireless Way, Richmond, BC, Canada V6V 3A4

Date of Receipt : Nov. 14, 2014
Test Date : Nov. 14, 2014~ Nov. 24, 2014
Issued Date : Dec. 17, 2014
Report No. : 14B0364R-HP-US-P07V01
Report Version : V 1.1



The test results relate only to the samples tested.

The test results shown in the test report are traceable to the national/international standard through the calibration of the equipment and evaluated measurement uncertainty herein.

This report must not be used to claim product endorsement by TAF or any agency of the government.

The test report shall not be reproduced without the written approval of QuieTek Corporation.

Test Report Certification

Issued Date : Dec. 17, 2014

Report No. : 14B0364R-HP-US-P07V01



Product Name : Wireless Module
Applicant : SIERRA WIRELESS TECHNOLOGY (SZ) LTD.
Address : 2/F JIU-ZOU ELECTRONIC BUILDING, SOUTHERN NO.12
ROAD, HI-TECH PARK. NANSHAN, SHENZHEN,
UANGDONG, CHINA, 518057
Manufacturer : Sierra Wireless Inc.
Address : 13811 Wireless Way Richmond, British Columbia, Canada,
V6V 3A4.
Model No. : MC7304
FCC ID : N7NMC7304
IC : 2417C-MC7304
EUT Voltage : DC3.0/3.3/3.6V
Brand Name : AirPrime
Applicable Standard : FCC CFR Title 47 Part 2, TIA/EIA 603-C
FCC Part22 Subpart H, FCC Part24 Subpart E
Industry Canada RSS-132, Issue 3
Industry Canada RSS-133, Issue 6
Test Result : Complied
Performed Location : Suzhou EMC Laboratory
No.99 Hongye Rd., Suzhou Industrial Park Loufeng Hi-Tech
Development Zone., Suzhou, China
TEL: +86-512-6251-5088 / FAX: +86-512-6251-5098
FCC Registration Number: 800392; IC Lab Code: 4075B

Documented By

: Alice Ni

Reviewed By

: Dream Cao

Approved By

: Jeff Chen

Laboratory Information

We, **Quietek Corporation**, are an independent EMC and safety consultancy that was established the whole facility in our laboratories. The test facility has been accredited/accepted(audited or listed) by the following related bodies in compliance with ISO 17025, EN 45001 and specified testing scope:

Taiwan R.O.C.	:	BSMI, NCC, TAF
Germany	:	TUV Rheinland
Norway	:	Nemko, DNV
USA	:	FCC
Japan	:	VCCI

The related certificate for our laboratories about the test site and management system can be downloaded from Quietek Corporation's Web Site :<http://www.quietek.com/tw/ctg/cts/accreditations.htm>

The address and introduction of Quietek Corporation's laboratories can be founded in our Web site :
<http://www.quietek.com/>

If you have any comments, Please don't hesitate to contact us. Our contact information is as below:

HsinChu Testing Laboratory :

No.75-2, 3rd Lin, Wangye Keng, Yonghxing Tsuen, Qionglin Shiang, Hsinchu County 307, Taiwan, R.O.C.
TEL:+886-3-592-8858 / FAX:+886-3-592-8859 E-Mail : service@quietek.com

LinKou Testing Laboratory :

No.5-22, Ruishukeng, Linkou Dist., New Taipei City 24451, Taiwan, R.O.C.
TEL : 886-2-8601-3788 / FAX : 886-2-8601-3789 E-Mail : service@quietek.com

Suzhou Testing Laboratory :

No.99 Hongye Rd., Suzhou Industrial Park Loufeng Hi-Tech Development Zone., SuZhou, China
TEL : +86-512-6251-5088 / FAX : 86-512-6251-5098 E-Mail : service@quietek.com

TABLE OF CONTENTS

Description	Page
1. General Information.....	6
1.1. EUT Description	6
1.2. Mode of Operation.....	7
1.3. Tested System Details	8
1.4. Configuration of Tested System.....	9
1.5. EUT Exercise Software.....	10
2. Technical Test	11
2.1. Summary of Test Result.....	11
2.2. Test Environment.....	13
3. Peak Output Power	14
3.1. Test Equipment.....	14
3.2. Test Setup.....	15
3.3. Limit.....	15
3.4. Test Procedure	15
3.5. Uncertainty	17
3.6. Test Result.....	18
4. Modulation Characteristic	23
4.1. Test Equipment.....	23
4.2. Test Setup.....	23
4.3. Limit.....	23
4.4. Uncertainty	23
4.5. Test Result.....	23
5. Occupied Bandwidth.....	24
5.1. Test Equipment.....	24
5.2. Test Setup.....	24
5.3. Limit.....	25
5.4. Test Procedure	25
5.5. Uncertainty	25
5.6. Test Result.....	26
6. Spurious Emission At Antenna Terminals (+/- 1MHz).....	38
6.1. Test Equipment.....	38
6.2. Test Setup.....	38
6.3. Limit.....	39
6.4. Test Procedure	39
6.5. Uncertainty	39
6.6. Test Result.....	40

7. Spurious Emission	46
7.1. Test Equipment.....	46
7.2. Test Setup.....	47
7.3. Limit	47
7.4. Test Procedure	48
7.5. Uncertainty	49
7.6. Test Result.....	50
8. Frequency Stability Under Temperature & Voltage Variations.....	74
8.1. Test Equipment.....	74
8.2. Test Setup.....	74
8.3. Limit.....	75
8.4. Test Procedure	75
8.5. Uncertainty	75
8.6. Test Result.....	76

1. General Information

1.1. EUT Description

Product Name	Wireless Module
Model No.	MC7304
Brand Name	AirPrime
EUT Voltage	DC3.0/3.3/3.6V
2G	
Support Band	GSM850/PCS1900
GPRS Class	Class 12
Uplink	GSM 850: 824~849MHz PCS 1900: 1850~1910MHz
Downlink	GSM 850: 869~894MHz PCS 1900: 1930~1990MHz
Release Version	R99
Type of modulation	GMSK for GPRS; 8PSK for EDGE
Antenna Type	Dipole
Antenna Gain	GSM 850: 1.2dBi PCS1900: 1.3dBi
3G	
Support Band	WCDMA Band II/WCDMA Band V
Uplink	WCDMA Band II: 1850~1910MHz WCDMA Band V: 824~849MHz
Downlink	WCDMA Band II: 1930~1990MHz WCDMA Band V: 869~894MHz
Release Version	Rel-7
Type of modulation	QPSK, 16QAM for Downlink QPSK for Uplink
Antenna Type	Dipole
Antenna Gain	WCDMA Band II: 1.1dBi WCDMA Band V: 1.2dBi

1.2. Mode of Operation

QuieTek has verified the construction and function in typical operation. All the test modes were carried out with the EUT in normal operation, which was shown in this test report and defined as:

Test Mode
Mode 1: GSM 850 Link
Mode 2: GSM 1900 Link
Mode 3: EDGE 850 Link
Mode 4: EDGE 1900 Link
Mode 5: WCDMA Band II Link
Mode 6: WCDMA Band V Link

Note:

1. Regards to the frequency band operation: the lowest, middle and highest frequency of channel were selected to perform the test, then shown on this report.
2. For the ERP/EIRP and radiated emission test, every axis (X, Y, Z) was verified, and show the worst result on this report.
3. The maximum power levels are GSM or GPRS multi-slot class 12 mode for GMSK link, EDGE multi-slot class 12 mode for 8PSK link, RMC 12.2Kbps Mode for WCDMA band V & II, only these modes were used for all tests.

1.3. Tested System Details

The types for all equipments, plus descriptions of all cables used in the tested system (including inserted cards) are:

	Product	Manufacturer	Model No.	Serial No.	Power Cord
1	Radio Communication Tester	R&S	CMU 200	106388	N/A

1.4. Configuration of Tested System

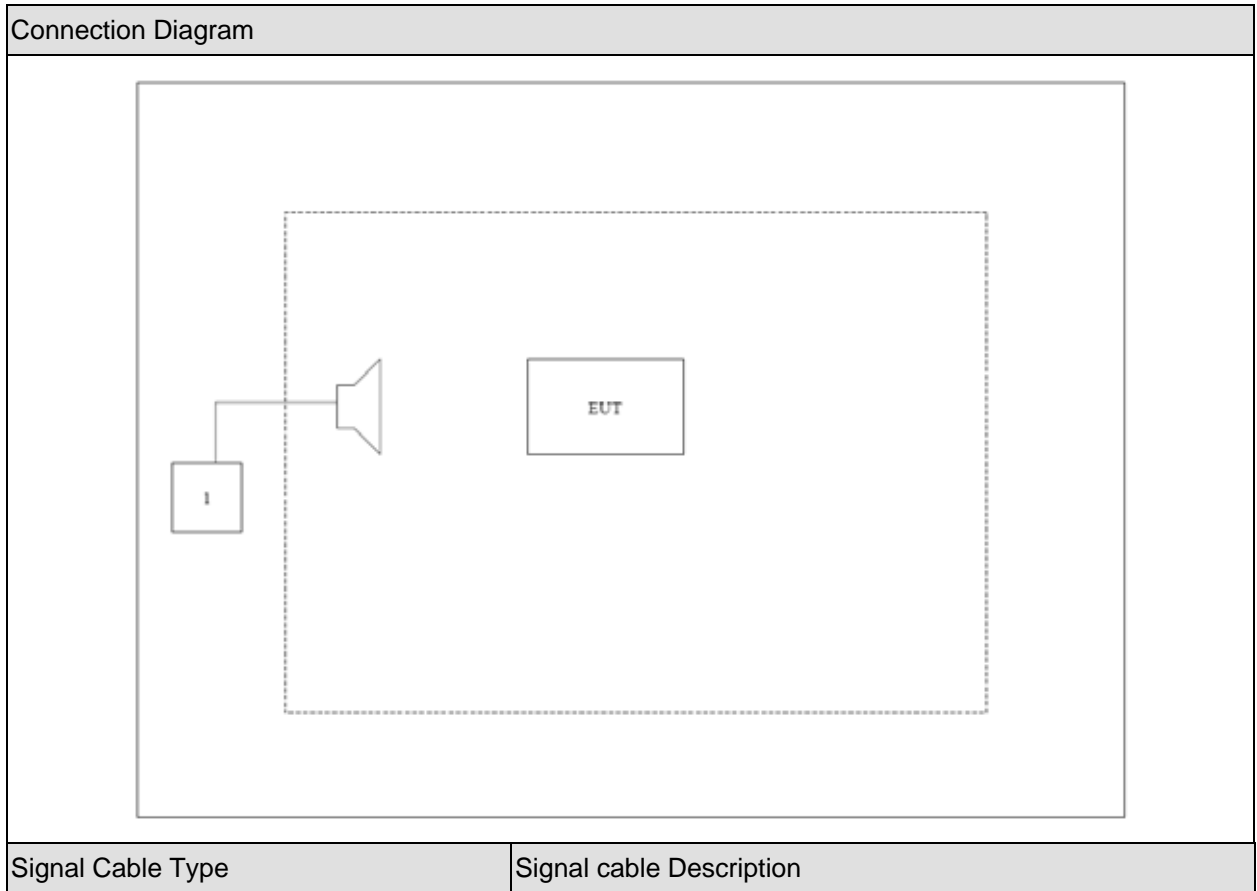

1.5. EUT Exercise Software

1	Setup the EUT and simulators as shown on above.
2	Turn on the power of all equipment.
3	EUT Communicate with CMU200, then select channel to test.

2. Technical Test

2.1. Summary of Test Result

- No deviations from the test standards
- Deviations from the test standards as below description:

For GSM 850/WCDMA Band V

Performed Item	Section in CFR 47	Section in RSS GEN or RSS-132	Test Performed	Deviation
Peak Output Power	FCC Part 22.913(a)(2) and Part 2.1046	RSS 132 Clause 5.4	Yes	No
Modulation Characteristic	FCC Part 2.1047(d)	RSS 132 Clause 5.2	Yes	No
Occupied Bandwidth	FCC Part 2.1049	RSS GEN Clause 6.6	Yes	No
Spurious Emission At Antenna Terminals (+/- 1MHz)	FCC Part 22.917(a) and Part 2.1049	RSS 132 Clause 5.5	Yes	No
Spurious Emission	FCC Part 22.917(b) and Part 2.1051, 2.1053 Industry Canada RSS-133, Issue 3 Clause 5.5&5.6	RSS 132 Clause 5.5&5.6	Yes	No
Frequency Stability Under Temperature & Voltage Variations	FCC Part 22.355 and 2.1055 Industry Canada RSS-133, Issue 3 Clause 5.3	RSS 132 Clause 5.3	Yes	No

For PCS1900, and WCDMA Band II

Performed Item	Section in CFR 47	Section in RSS GEN or RSS-133	Test Performed	Deviation
Peak Output Power	FCC Part 24.232(b) and Part 2.1046	RSS 133 Clause 6.4	Yes	No
Modulation Characteristic	FCC Part 2.1047(d)	RSS 133 Clause 6.2	Yes	No
Occupied Bandwidth	FCC Part 24.238(b) and Part 2.1049	RSS GEN Clause 6.6	Yes	No
Spurious Emission At Antenna Terminals (+/- 1MHz)	FCC Part 24.238(a) and Part 2.1049	RSS 133 Clause 6.5	Yes	No
Spurious Emission	FCC Part 24.238(b) and Part 2.1051, 2.1053	RSS 133 Clause 6.5&6.6	Yes	No
Frequency Stability Under Temperature & Voltage Variations	FCC Part 24.235 and 2.1055	RSS 133 Clause 6.3	Yes	No

2.2. Test Environment

Items	Required (IEC 68-1)	Actual
Temperature (°C)	15-35	23
Humidity (%RH)	25-75	52
Barometric pressure (mbar)	860-1060	950-1000

3. Peak Output Power

3.1. Test Equipment

Spurious Emission / AC-5

Instrument	Manufacturer	Type No.	Serial No	Cali. Due Date
PSA Series Spectrum Analyzer	Agilent	E4440A	MY49420184	2015.03.28
Radio Communication Tester	R&S	CMU 200	117088	2015.03.28
Dual Directional Coupler	Agilent	778D	20160	2015.03.28
10dB Coaxial Coupler	Agilent	87300C	MY44300299	2015.03.28
PSG Analog Signal Generator	Agilent	E8257D	MY44321116	2015.03.28
Preamplifier	QuieTek	AP-025C	CHM-0503006	2015.04.11
Preamplifier	Miteq	NSP1800-25	1364185	2015.05.03
Bilog Antenna	Teseq GmbH	CBL6112D	27612	2015.10.15
Half Wave Tuned Dipole Antenna	COM-POWER	AD-100	40137	2016.02.26
Broad-Band Horn Antenna	Schwarzbeck	BBHA9120D	737	2016.02.26
Broad-Band Horn Antenna	Schwarzbeck	BBHA9120D	499	2015.06.08
DRG Horn	ETS-Lindgren	3117	00123988	2015.01.07
Temperature/Humidity Meter	Zhicheng	ZC1-2	AC5-TH	2015.01.08

3.2. Test Setup

Conducted Power Measurement:

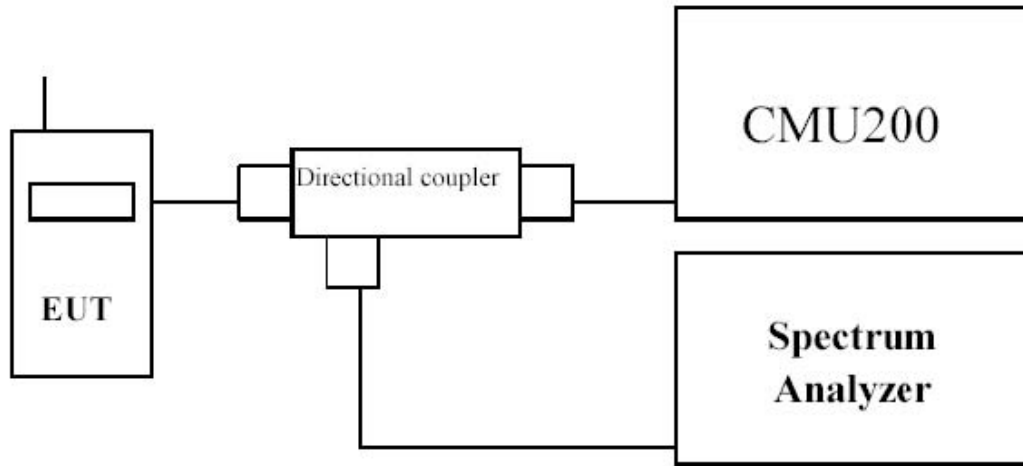

Radiated Power Measurement:

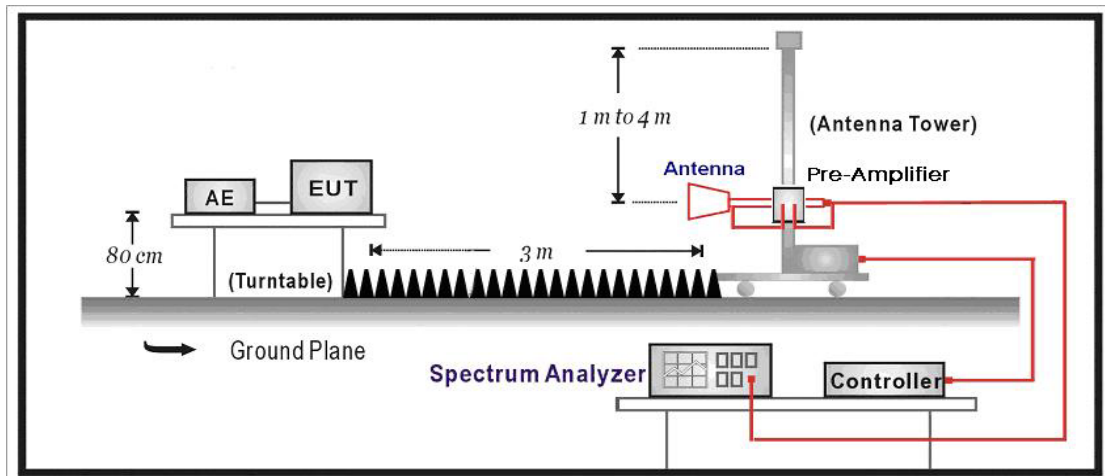

3.3. Limit

For FCC Part 22.913(a)(2):

The ERP of mobile transmitters and auxiliary test transmitters must not exceed 7 Watts.

For FCC Part 24.232(b):

The EIRP of mobile transmitters and auxiliary test transmitters must not exceed 2 Watts.

3.4. Test Procedure

Conducted Power Measurement:

- a) Place the EUT on a bench and set it in transmitting mode.
- b) Connect a low loss RF cable from the antenna port to a spectrum analyzer and CMU200 by a Directional Couple.

- c) EUT Communicate with CMU200, then selects a channel for testing.
- d) Add a correction factor to the display of spectrum, and then test.

Radiated Power Measurement:

- e) The EUT shall be placed at the specified height on a support, and in the position closest to normal use as declared by provider.
- f) The test antenna shall be oriented initially for vertical polarization and shall be chosen to correspond to the frequency of the transmitter
- g) The output of the test antenna shall be connected to the measuring receiver.
- h) The transmitter shall be switched on and the measuring receiver shall be tuned to the frequency of the transmitter under test.
- i) The test antenna shall be raised and lowered through the specified range of height until a maximum signal level is detected by the measuring receiver.
- j) The transmitter shall then be rotated through 360° in the horizontal plane, until the maximum signal level is detected by the measuring receiver.
- k) The test antenna shall be raised and lowered again through the specified range of height until a maximum signal level is detected by the measuring receiver.
- l) The maximum signal level detected by the measuring receiver shall be noted.
- m) The transmitter shall be replaced by a substitution antenna.
- n) The substitution antenna shall be orientated for vertical polarization and the length of the substitution antenna shall be adjusted to correspond to the frequency of the transmitter.
- o) The substitution antenna shall be connected to a calibrated signal generator.
- p) If necessary, the input attenuator setting of the measuring receiver shall be adjusted in order to increase the sensitivity of the measuring receiver.
- q) The test antenna shall be raised and lowered through the specified range of height to ensure that the maximum signal is received.
- r) The input signal to the substitution antenna shall be adjusted to the level that produces a level detected by the measuring receiver, that is equal to the level noted while the transmitter radiated power was measured, corrected for the change of input attenuator setting of the measuring receiver.
- s) The measurement shall be repeated with the test antenna and the substitution antenna orientated for horizontal polarization.
- t) The measure of the effective radiated power is the larger of the two levels recorded at the input to the substitution antenna, corrected for gain of the substitution antenna if necessary.
- u) Test site anechoic chamber refer to ANSI C63.4: 2009.

3.5. Uncertainty

The measurement uncertainty is defined as for Conducted Power Measurement ± 1.2 dB, for Radiated Power Measurement ± 3.2 dB

3.6. Test Result

Conducted Power Measurement

GSM850

Test Mode	Channel No.	Frequency (MHz)	Modulation	Conducted Power (dBm)
GSM850	128	824.2	GMSK	32.54
	189	836.4	GMSK	32.53
	251	848.8	GMSK	32.51
GSM1900	512	1850.2	GMSK	29.92
	661	1880.0	GMSK	29.89
	810	1909.8	GMSK	29.88
GPRS850	128	824.2	GMSK	32.45
	189	836.4	GMSK	32.44
	251	848.8	GMSK	32.43
GPRS1900	512	1850.2	GMSK	29.87
	661	1880.0	GMSK	29.69
	810	1909.8	GMSK	29.37
EDGE850	128	824.2	8PSK	27.15
	189	836.4	8PSK	27.09
	251	848.8	8PSK	27.06
EDGE1900	512	1850.2	8PSK	26.83
	661	1880.0	8PSK	26.61
	810	1909.8	8PSK	26.37

Note: The maximum PAR for GPRS1900 is 7.5dB less than 13 dB, and the maximum PAR for EDGE1900 is 7.6dB less than 13 dB.

WCDMA/HSDPA/HSUPA/HSPA+

Mode	3GPP Subtest	Band II (1900MHz) Channel			MPR
		Conducted Power (dBm)			
		9262	9400	9538	
WCDMA R99	1	23.87	23.80	23.33	N/A
Rel5 HSDPA	1	23.46	23.11	22.64	0
	2	23.39	23.04	22.55	0
	3	22.94	22.63	22.12	0.5
	4	22.86	22.59	22.08	0.5
Rel6 HSUPA	1	22.71	22.64	21.99	0.0
	2	20.70	20.65	19.97	2.0
	3	21.69	21.63	20.98	1.0
	4	20.72	20.66	19.96	2.0
	5	22.70	22.62	21.98	0.0
Rel7 HSPA+	1	21.89	21.58	21.04	N/A

Note: The maximum PAR for WCDMA Band II is 8.7dB less than 13 dB.

Mode	3GPP Subtest	Band V (850MHz) Channel			MPR
		Conducted Power (dBm)			
		4132	4182	4233	
WCDMA R99	1	23.61	23.38	23.17	N/A
Rel5 HSDPA	1	22.93	22.83	22.69	0
	2	22.87	22.81	22.57	0
	3	22.42	22.32	22.16	0.5
	4	22.40	22.29	22.18	0.5
Rel6 HSUPA	1	22.34	22.10	22.06	0.0
	2	20.38	20.05	20.09	2.0
	3	21.36	21.14	21.08	1.0
	4	20.33	20.06	20.10	2.0
	5	22.37	22.12	22.11	0.0
Rel7 HSPA+	1	22.03	21.94	21.78	N/A

Note: All conducted measurements are based on a RMS detector.

Radiated Measurement

GSM850

Frequency (MHz)	SA Reading (dBm)	Ant. Pol. (H/V)	SG Reading (dBm)	Cable Loss (dB)	Gain (dBd)	ERP (dBm)	Limit (dBm)	Margin (dB)
Low Channel 128 (824.20MHz)								
824.20	1.56	H	35.32	1.76	-0.02	33.54	38.50	-4.96
824.20	-12.01	V	22.49	1.76	-0.02	20.71	38.50	-17.79
Middle Channel 189 (836.40MHz)								
836.40	1.00	H	34.89	1.75	0.10	33.24	38.50	-5.26
836.40	-12.78	V	21.99	1.75	0.10	20.34	38.50	-18.16
High Channel 251 (848.80MHz)								
848.80	0.83	H	34.84	1.78	0.13	33.19	38.50	-5.31
848.80	-12.86	V	21.75	1.78	0.13	20.10	38.50	-18.4

GSM1900

Frequency (MHz)	SA Reading (dBm)	Ant .Pol. (H/V)	SG Reading (dBm)	Cable Loss (dB)	Gain (dBi)	EIRP (dBm)	Limit (dBm)	Margin (dB)
Low Channel 512 (1850.20MHz)								
1850.20	24.64	H	23.05	2.68	10.40	30.77	33.00	-2.23
1850.20	14.48	V	12.89	2.68	10.40	20.61	33.00	-12.39
Middle Channel 661 (1880.00MHz)								
1880.00	24.28	H	22.78	2.68	10.43	30.53	33.00	-2.47
1880.00	13.47	V	11.63	2.68	10.43	19.38	33.00	-13.62
High Channel 810 (1909.80MHz)								
1909.80	24.00	H	22.65	2.70	10.44	30.39	33.00	-2.61
1909.80	13.21	V	11.41	2.70	10.44	19.15	33.00	-13.85

EDGE 850

Frequency (MHz)	SA Reading (dBm)	Ant. Pol. (H/V)	SG Reading (dBm)	Cable Loss (dB)	Gain (dBd)	ERP (dBm)	Limit (dBm)	Margin (dB)
Low Channel 128 (824.20MHz)								
824.20	-4.04	H	30.30	1.76	-0.02	28.52	38.50	-9.98
824.20	-17.78	V	16.96	1.76	-0.02	15.18	38.50	-23.32
Middle Channel 189 (836.40MHz)								
836.40	-4.76	H	29.13	1.75	0.10	27.48	38.50	-11.02
836.40	-18.66	V	16.10	1.75	0.10	14.45	38.50	-24.05
High Channel 251 (848.80MHz)								
848.80	-4.52	H	29.50	1.78	0.13	27.85	38.50	-10.65
848.80	-17.80	V	16.81	1.78	0.13	15.16	38.50	-23.34

EDGE1900

Frequency (MHz)	SA Reading (dBm)	Ant .Pol. (H/V)	SG Reading (dBm)	Cable Loss (dB)	Gain (dBi)	EIRP (dBm)	Limit (dBm)	Margin (dB)
Low Channel 512 (1850.20MHz)								
1850.20	20.46	H	19.06	2.68	10.40	26.78	33.00	-6.22
1850.20	10.36	V	8.77	2.68	10.40	16.49	33.00	-16.51
Middle Channel 661 (1880.00MHz)								
1880.00	19.92	H	18.49	2.68	10.43	26.24	33.00	-6.76
1880.00	10.26	V	8.64	2.68	10.43	16.39	33.00	-16.61
High Channel 810 (1909.80MHz)								
1909.80	19.80	H	18.45	2.70	10.44	26.19	33.00	-6.81
1909.80	11.11	V	9.31	2.70	10.44	17.05	33.00	-15.95

WCDMA Band II

Frequency (MHz)	SA Reading (dBm)	Ant. Pol. (H/V)	SG Reading (dBm)	Cable Loss (dB)	Gain (dBi)	ERIP (dBm)	Limit (dBm)	Margin (dB)
Low Channel 9262 (1852.40MHz)								
1852.40	-6.71	H	18.79	3.55	10.40	25.64	33.00	-7.36
1852.40	-19.82	V	6.29	3.55	10.40	13.14	33.00	-19.86
Middle Channel 9400 (1880.00MHz)								
1880.00	-7.43	H	17.81	3.53	10.43	24.71	33.00	-8.29
1880.00	-19.99	V	6.30	3.53	10.43	13.20	33.00	-19.8
High Channel 9538 (1907.60MHz)								
1907.60	-7.93	H	17.47	3.56	10.44	24.35	33.00	-8.65
1907.60	-20.37	V	5.73	3.56	10.44	12.61	33.00	-20.39

WCDMA Band V

Frequency (MHz)	SA Reading (dBm)	Ant .Pol. (H/V)	SG Reading (dBm)	Cable Loss (dB)	Gain (dBd)	ERP (dBm)	Limit (dBm)	Margin (dB)
Low Channel 4132 (826.40MHz)								
826.40	18.86	H	27.75	2.56	-0.02	25.17	38.50	-13.33
826.40	9.57	V	18.27	2.56	-0.02	15.69	38.50	-22.81
Middle Channel 4182 (836.40MHz)								
836.40	18.81	H	27.55	2.59	0.10	25.06	38.50	-13.44
836.40	9.17	V	17.58	2.59	0.10	15.09	38.50	-23.41
High Channel 4233 (846.60MHz)								
846.60	18.63	H	27.38	2.54	0.13	24.97	38.50	-13.53
846.60	8.87	V	17.16	2.54	0.13	14.75	38.50	-23.75

4. Modulation Characteristic

4.1. Test Equipment

Modulation Characteristic / AC-6

Instrument	Manufacturer	Type No.	Serial No	Cal. Date
PSA Series Spectrum Analyzer	Agilent	E4440A	MY49420184	2015.03.28
Radio Communication Tester	R&S	CMU 200	117088	2015.03.28
Dual Directional Coupler	Agilent	778D	20160	2015.03.28
10dB Coaxial Coupler	Agilent	87300C	MY44300299	2015.03.28
Temperature/Humidity Meter	Zhicheng	ZC1-2	AC6-TH	2015.01.08

4.2. Test Setup

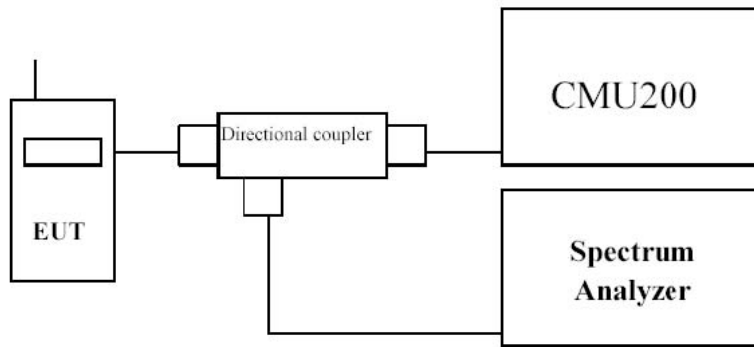

4.3. Limit

N/A

4.4. Uncertainty

The measurement uncertainty is defined as 0.1%

4.5. Test Result

The modulation of GSM/WCDMA was verified and confirmed compliance with requirement.

5. Occupied Bandwidth

5.1. Test Equipment

Occupied Bandwidth / AC-6

Instrument	Manufacturer	Type No.	Serial No	Cali. Due Date
PSA Series Spectrum Analyzer	Agilent	E4440A	MY49420184	2015.03.28
Radio Communication Tester	R&S	CMU 200	117088	2015.03.28
Dual Directional Coupler	Agilent	778D	20160	2015.03.28
10dB Coaxial Coupler	Agilent	87300C	MY44300299	2015.03.28
Temperature/Humidity Meter	Zhicheng	ZC1-2	AC6-TH	2015.01.08

5.2. Test Setup

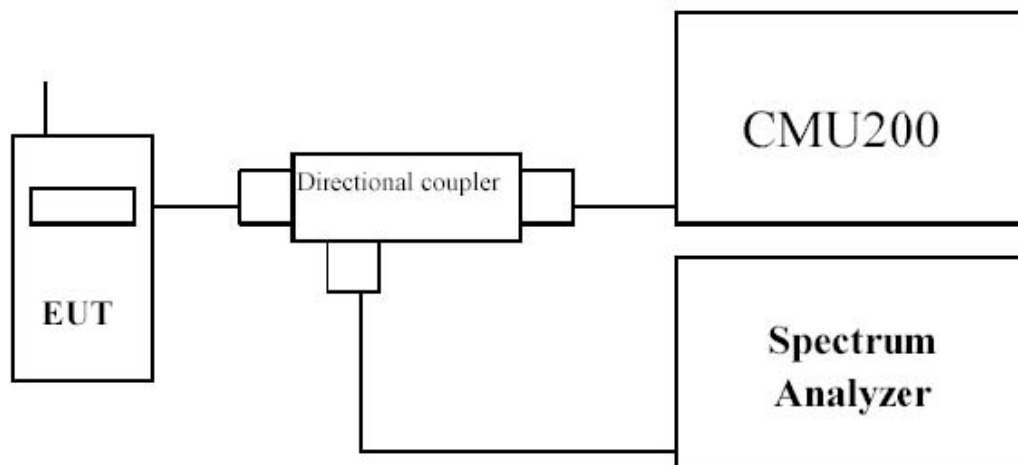

5.3. Limit

N/A

5.4. Test Procedure

Using Occupied Bandwidth measurement function of spectrum analyzer, and setting as follows:

For GSM/EDGE 850/1900 test --- RBW = 3 kHz and VBW = 10 kHz

For WCDMA II/V test --- RBW = 50 kHz and VBW = 200 kHz

5.5. Uncertainty

The measurement uncertainty is defined as ± 10 Hz

5.6. Test Result

Product	Wireless Module		
Test Item	Occupied Bandwidth		
Test Mode	Mode 1: GSM 850 Link		
Date of Test	2014/11/24	Test Site	AC6

Channel No.	Frequency (MHz)	-26dB Occupied Bandwidth (kHz)	99% Occupied Bandwidth (kHz)
128	824.20	313.922	242.696
189	836.40	308.360	246.651
251	848.80	311.286	240.016

Figure Channel 128 (824.20MHz)

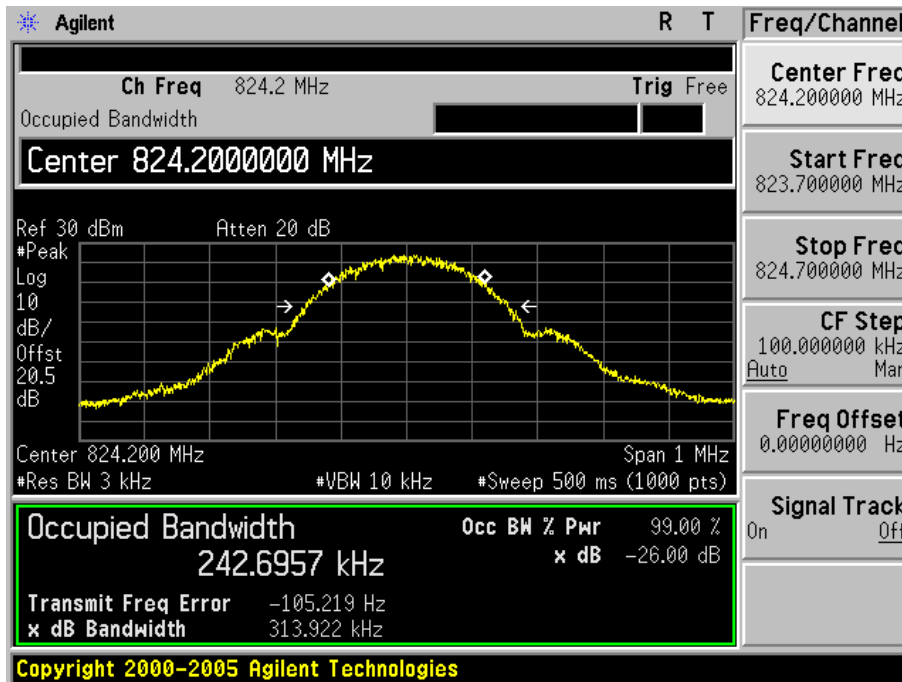

Figure Channel 189 (836.40MHz)

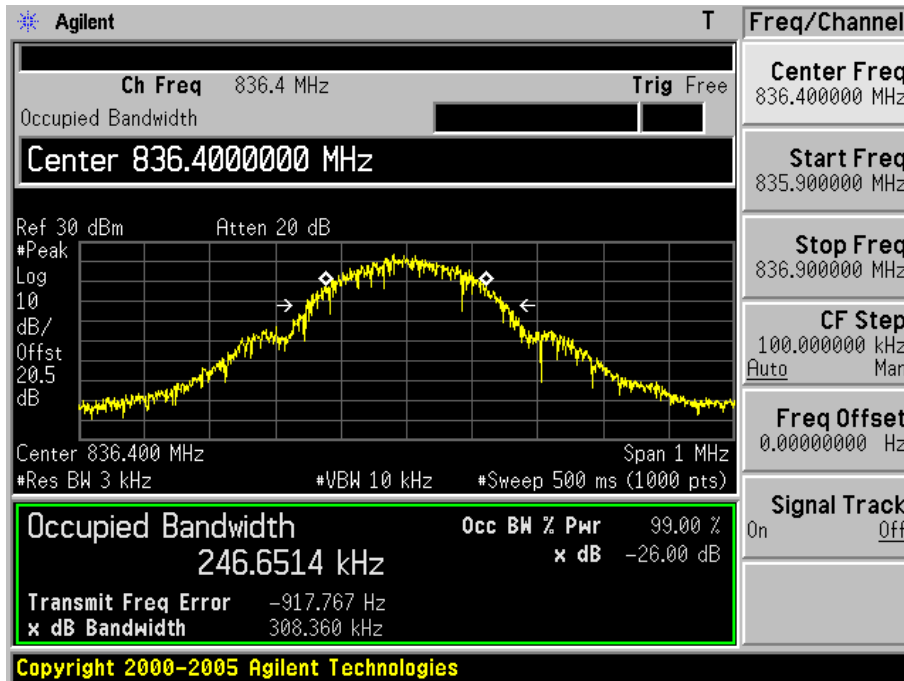
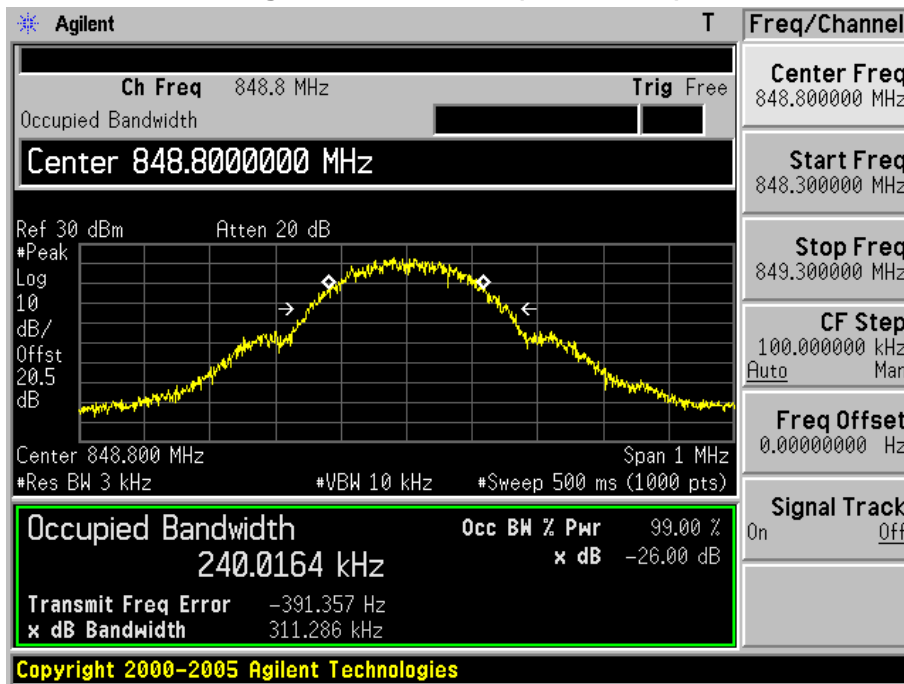

Figure Channel 251 (848.80MHz)



Product	Wireless Module		
Test Item	Occupied Bandwidth		
Test Mode	Mode 2: GSM 1900 Link		
Date of Test	2014/11/24	Test Site	AC6

Channel No.	Frequency (MHz)	-26dB Occupied Bandwidth (kHz)	99% Occupied Bandwidth (kHz)
512	1850.20	318.056	243.711
661	1880.00	311.846	246.250
810	1909.80	313.748	242.650

Figure Channel 512 (1850.20MHz)

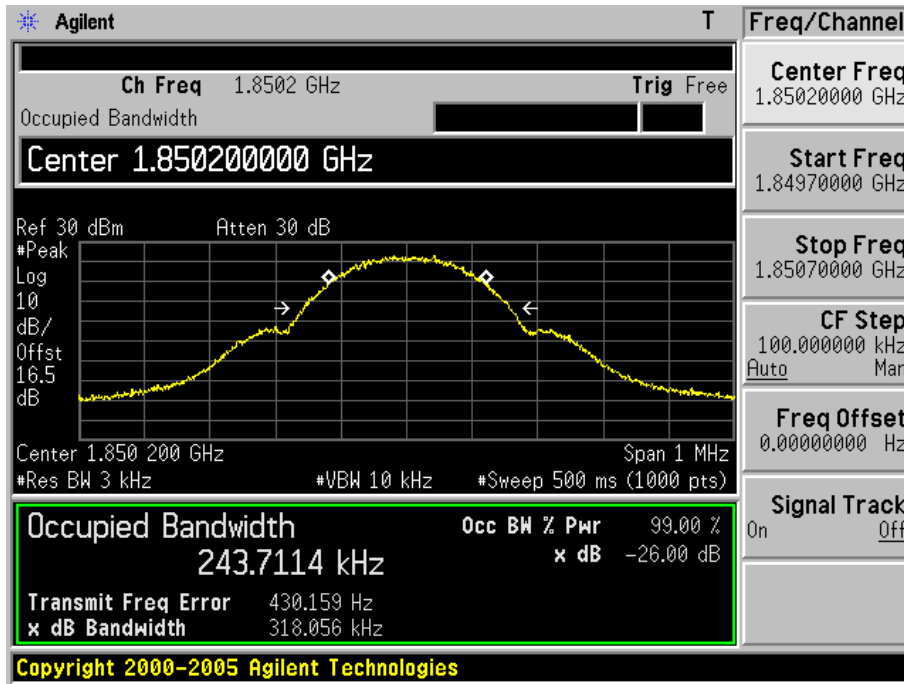

Figure Channel 661 (1880.00MHz)

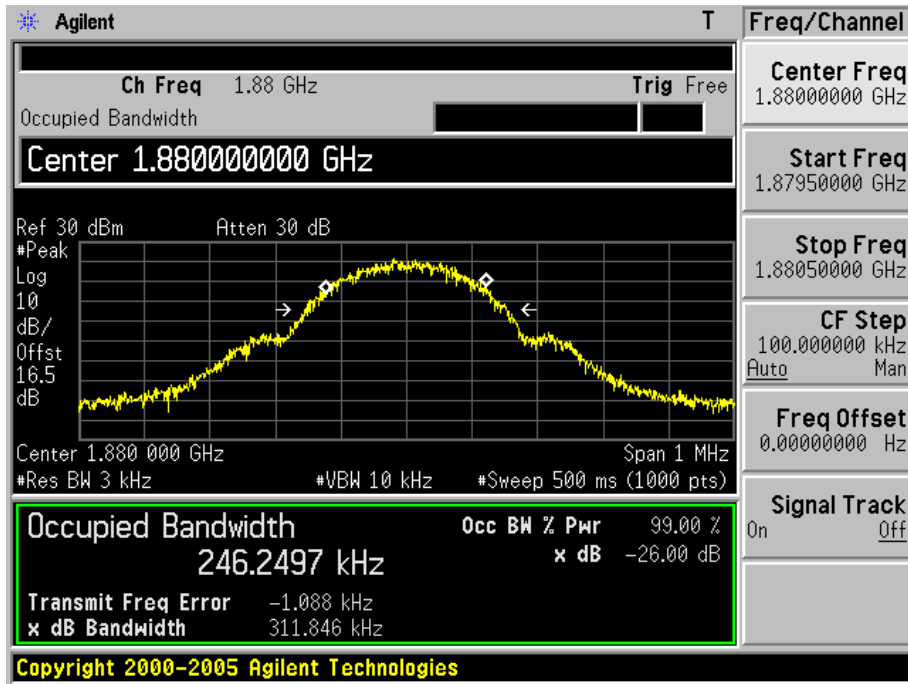
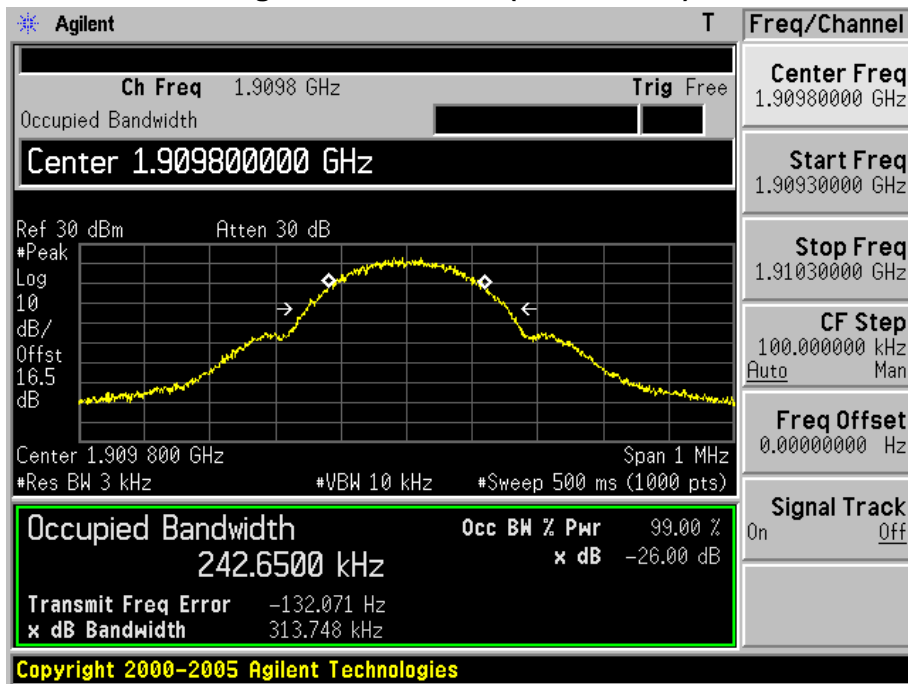

Figure Channel 810 (1909.80MHz)



Product	Wireless Module		
Test Item	Occupied Bandwidth		
Test Mode	Mode 3: EDGE 850 Link		
Date of Test	2014/11/24	Test Site	AC6

Channel No.	Frequency (MHz)	-26dB Occupied Bandwidth (kHz)	99% Occupied Bandwidth (kHz)
128	824.20	315.887	241.641
189	836.40	301.654	236.070
251	848.80	315.835	237.093

Figure Channel 128 (824.20MHz)

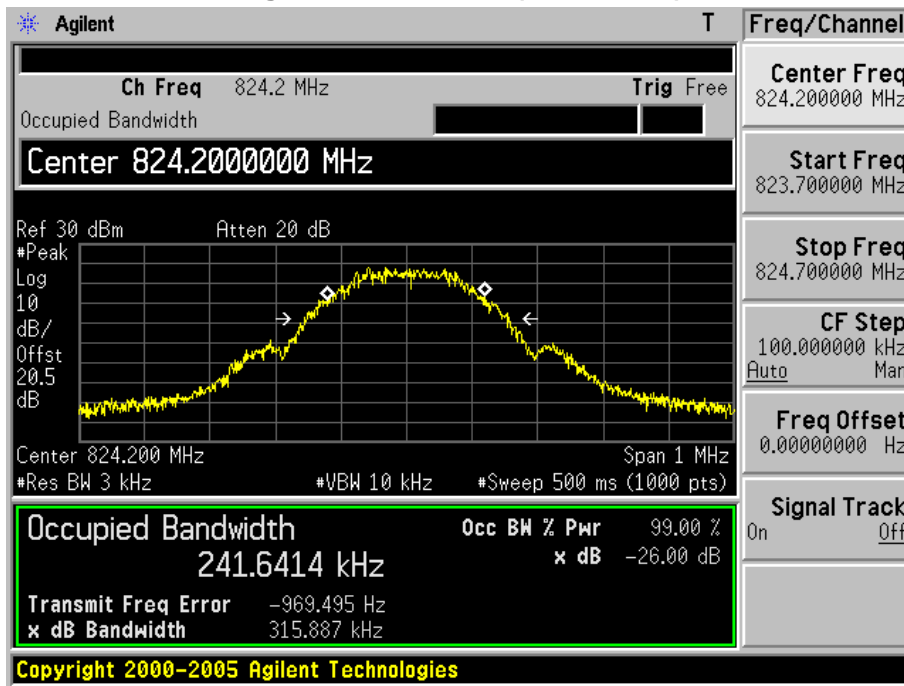

Figure Channel 189 (836.40MHz)

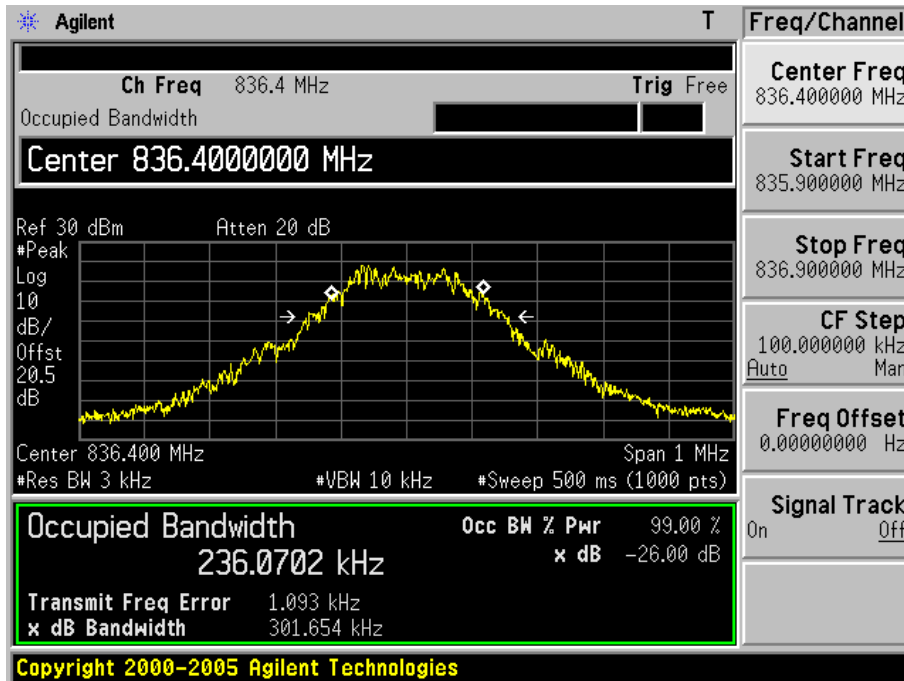
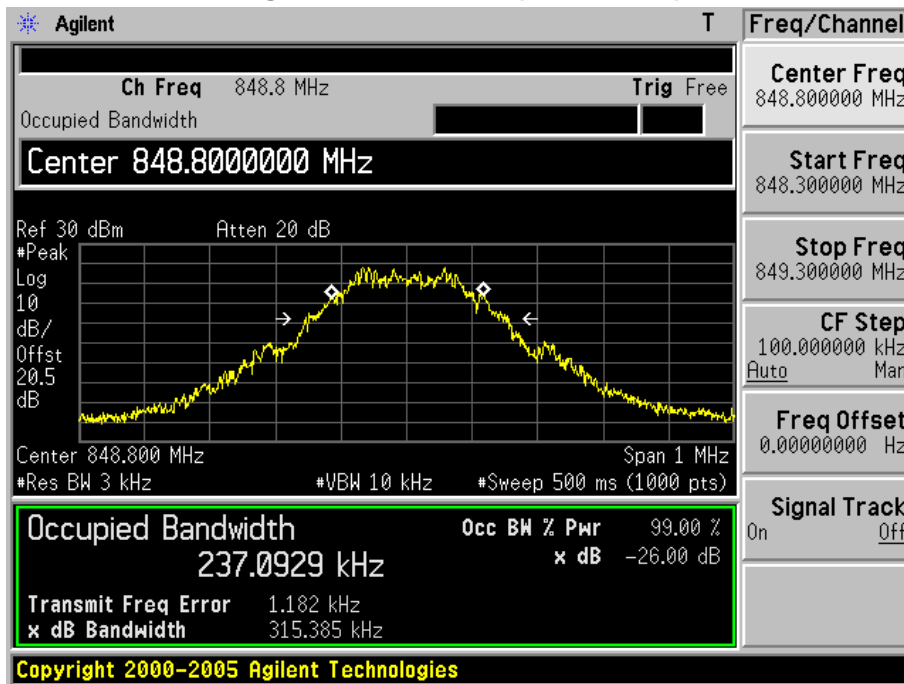

Figure Channel 251 (848.80MHz)



Product	Wireless Module		
Test Item	Occupied Bandwidth		
Test Mode	Mode 4: EDGE 1900 Link		
Date of Test	2014/11/24	Test Site	AC6

Channel No.	Frequency (MHz)	-26dB Occupied Bandwidth (kHz)	99% Occupied Bandwidth (kHz)
512	1850.20	315.657	251.470
661	1880.00	302.253	247.791
810	1909.80	304.967	247.043

Figure Channel 512 (1850.20MHz)

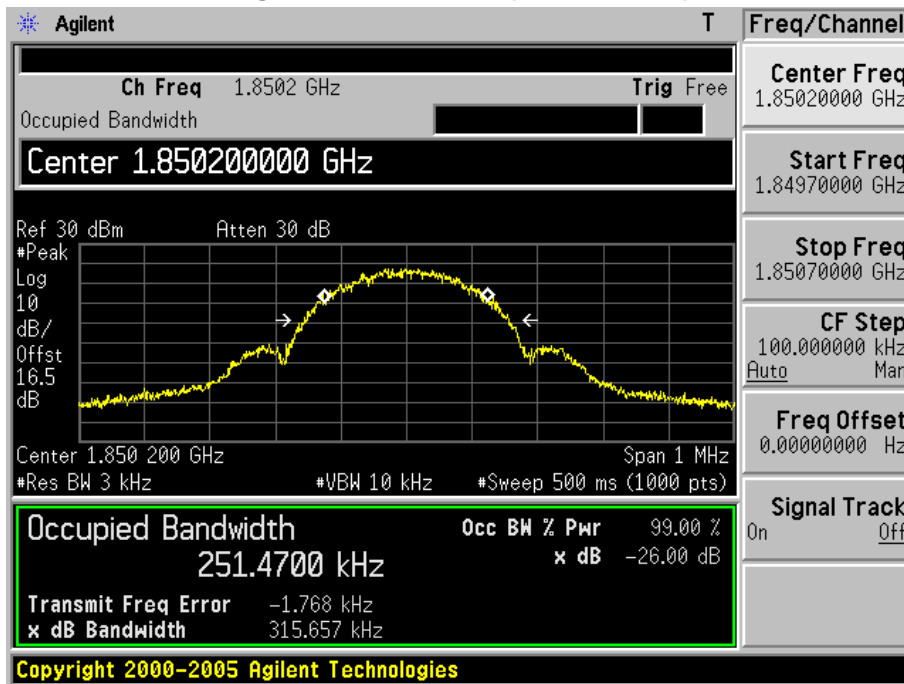

Figure Channel 661 (1880.00MHz)

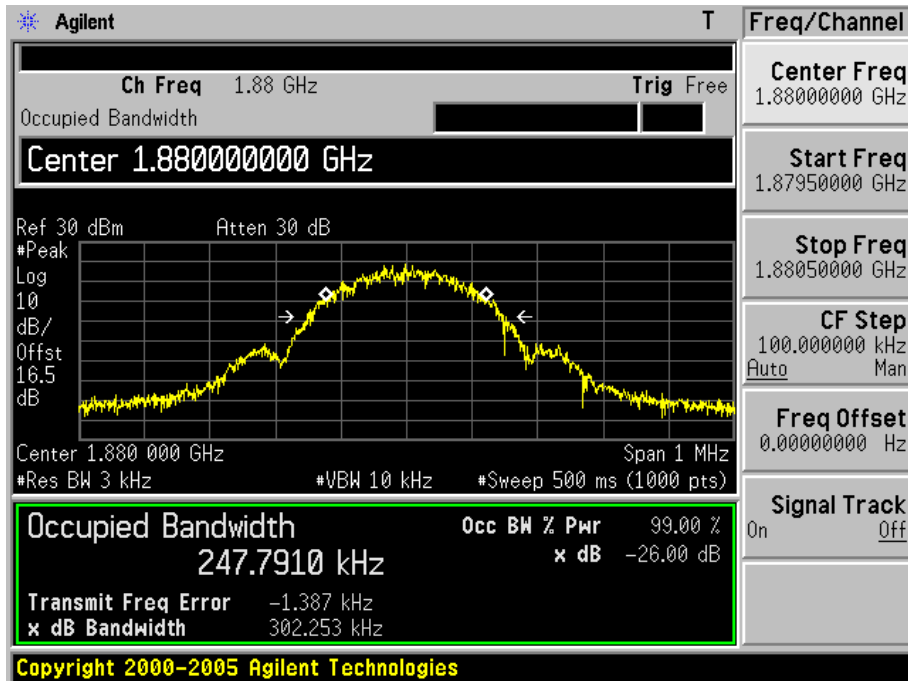
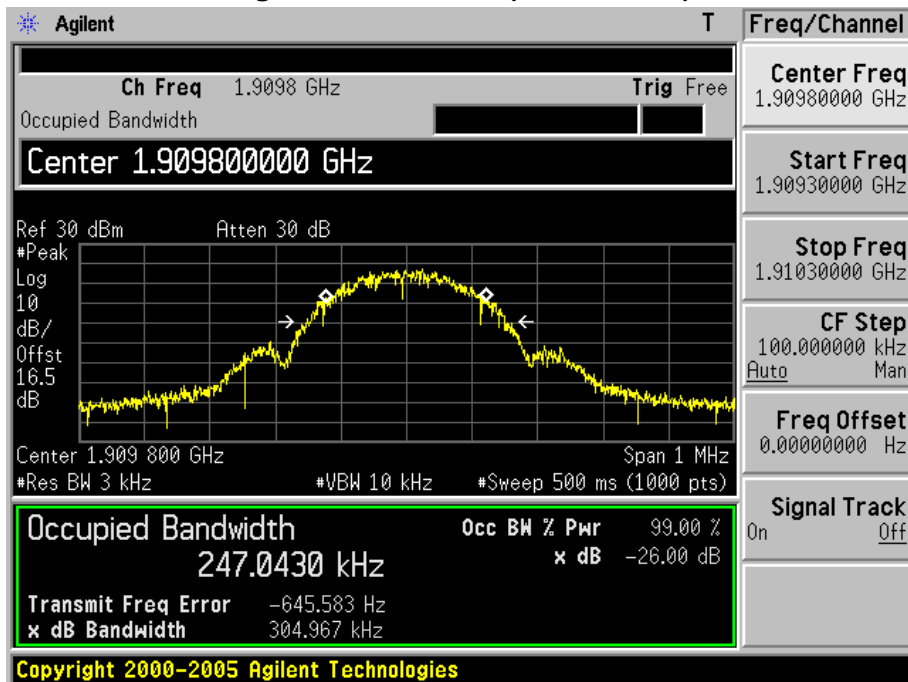

Figure Channel 810 (1909.80MHz)



Product	Wireless Module		
Test Item	Occupied Bandwidth		
Test Mode	Mode 5: WCDMA Band II Link		
Date of Test	2014/11/24	Test Site	AC6

Channel No.	Frequency (MHz)	-26dB Occupied Bandwidth (kHz)	99% Occupied Bandwidth (kHz)
9262	1852.4	4646.0	4167.3
9400	1880.0	4623.0	4163.2
9538	1907.6	4622.0	4168.5

Figure Channel 9262 (1852.40MHz)

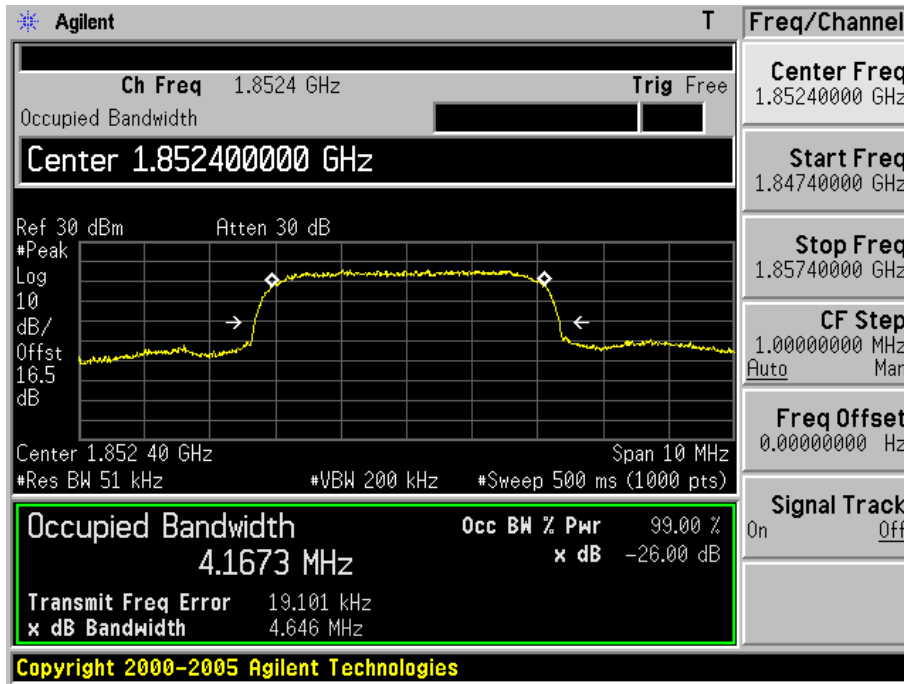

Figure Channel 9400 (1880.0MHz)

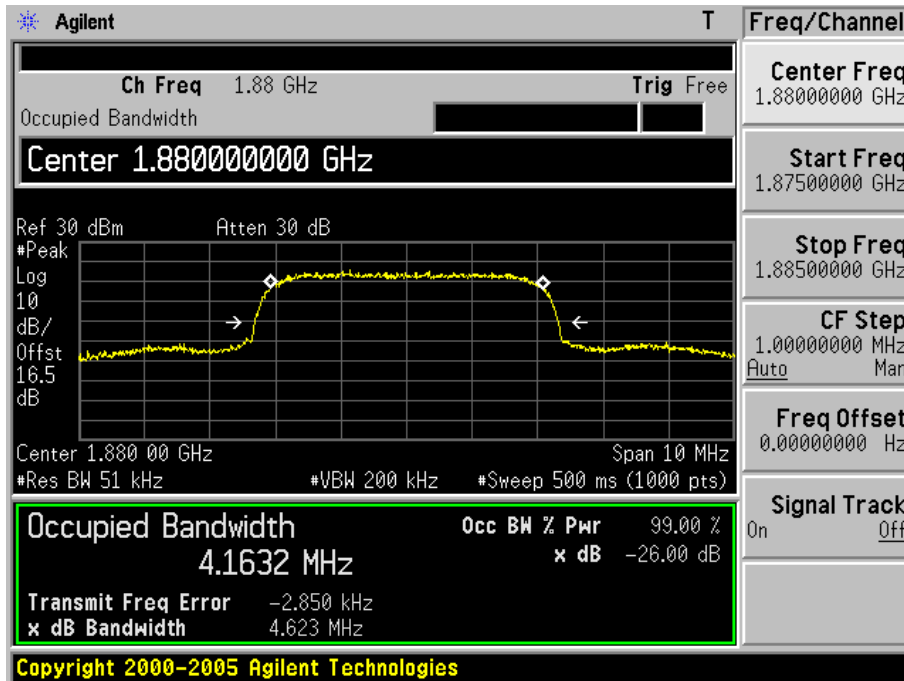
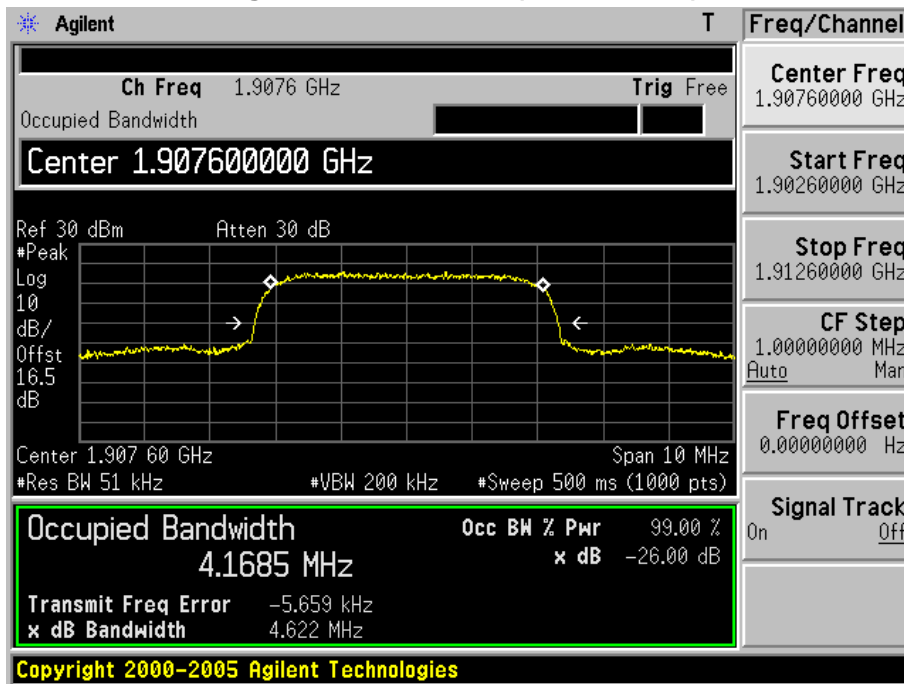

Figure Channel 9538 (1907.60MHz)



Product	Wireless Module		
Test Item	Occupied Bandwidth		
Test Mode	Mode 6: WCDMA Band V Link		
Date of Test	2014/11/24	Test Site	AC6

Channel No.	Frequency (MHz)	-26dB Occupied Bandwidth (kHz)	99% Occupied Bandwidth (kHz)
4132	826.4	4632.0	4149.6
4182	836.4	4614.0	4149.8
4233	846.6	4624.0	4145.2

Figure Channel 4132 (826.40MHz)

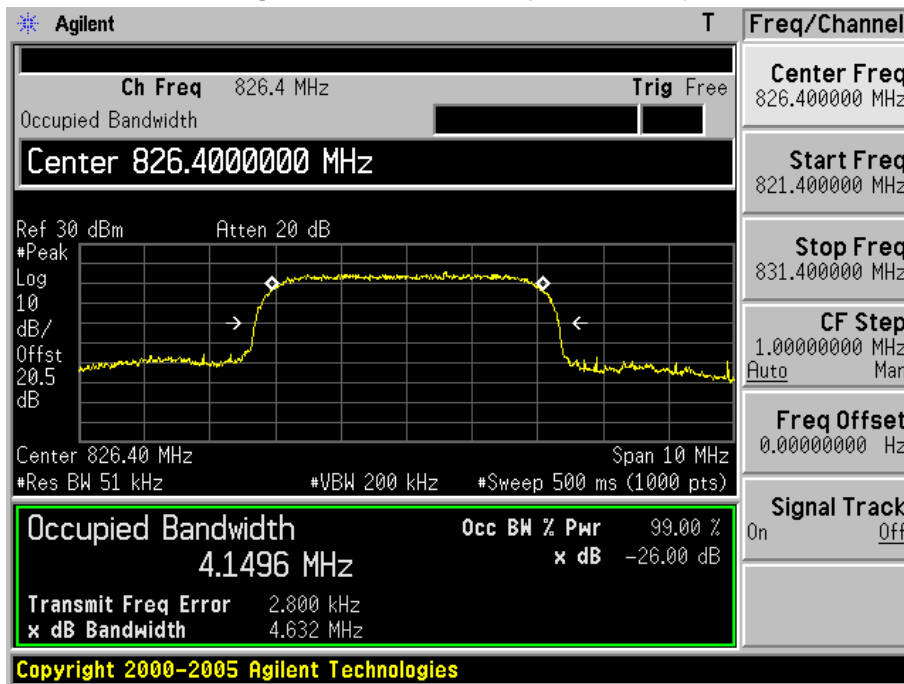

Figure Channel 4182 (836.40MHz)

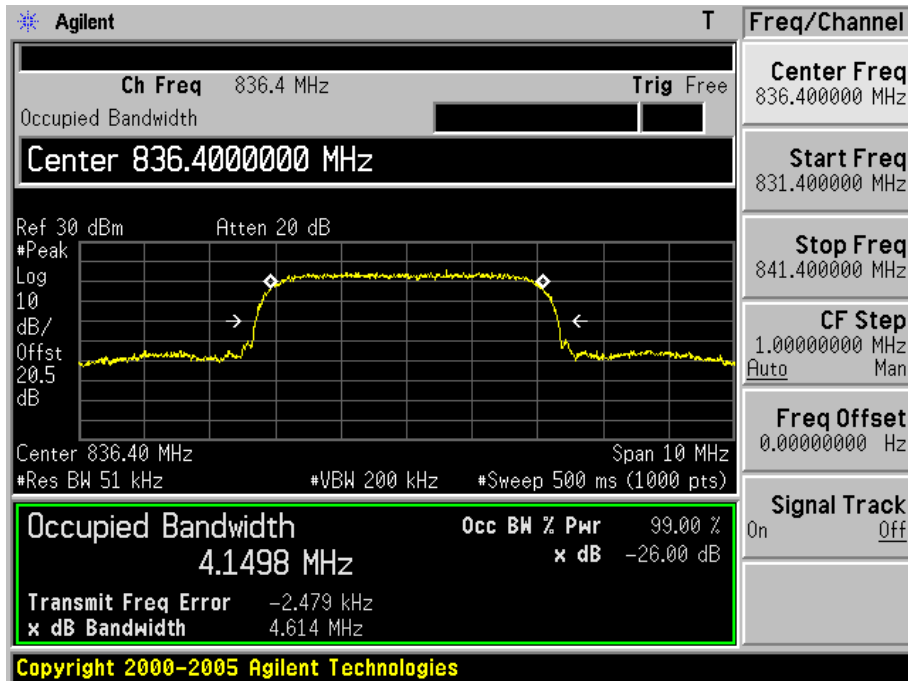
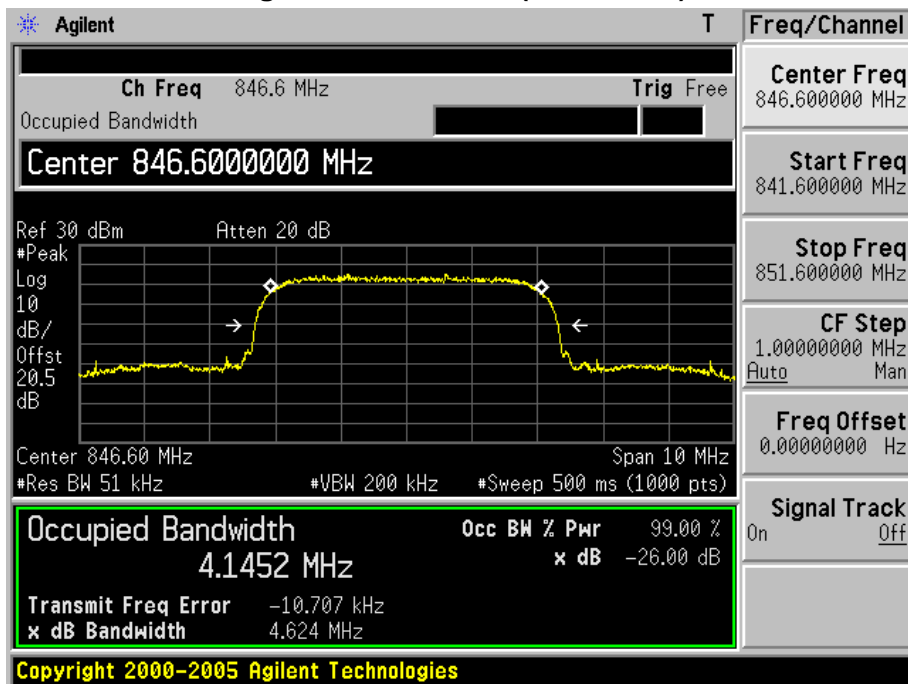

Figure Channel 4233(846.60MHz)



6. Spurious Emission At Antenna Terminals (+/- 1MHz)

6.1. Test Equipment

Spurious Emission At Antenna Terminals (+/- 1MHz) / AC-6

Instrument	Manufacturer	Type No.	Serial No	Cali. Due Date
PSA Series Spectrum Analyzer	Agilent	E4440A	MY49420184	2015.03.28
Radio Communication Tester	R&S	CMU 200	117088	2015.03.28
Dual Directional Coupler	Agilent	778D	20160	2015.03.28
10dB Coaxial Coupler	Agilent	87300C	MY44300299	2015.03.28
Temperature/Humidity Meter	Zhicheng	ZC1-2	AC6-TH	2015.01.08

6.2. Test Setup

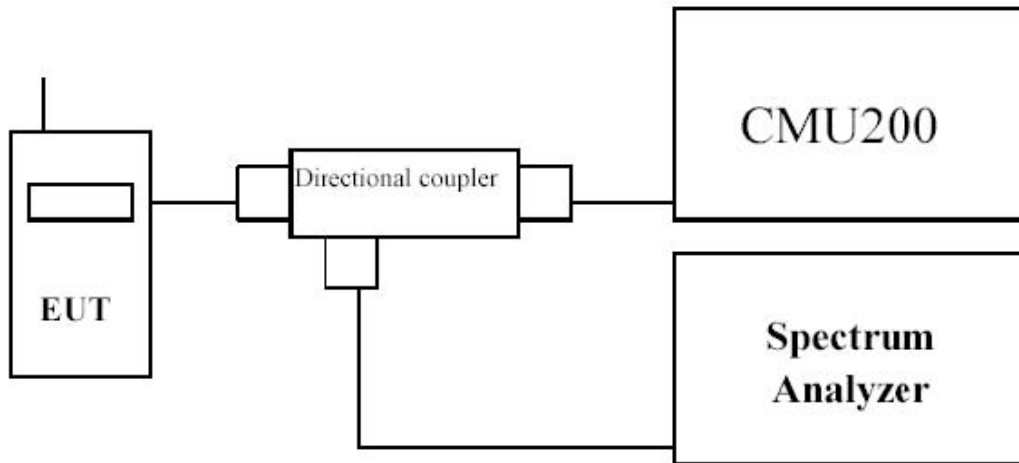

6.3. Limit

The power of any emission outside of the authorized operating frequency ranges must be attenuated below the transmitting power (P) by a factor of at least $43 + 10\log(P)$ dB.

6.4. Test Procedure

In the 1MHz bands immediately outside and adjacent to the frequency block a resolution bandwidth of at least one percent of the emission bandwidth of the fundamental emission of the transmitter may be employed to measure the out of band Emissions.

6.5. Uncertainty

The measurement uncertainty is defined as ± 1.2 dB.

6.6. Test Result

Product	Wireless Module		
Test Item	Spurious Emission At Antenna Terminals (+/- 1MHz)		
Test Mode	Mode 1: GSM 850 Link		
Date of Test	2014/11/23	Test Site	AC6

Figure Channel 128 (824.20MHz)

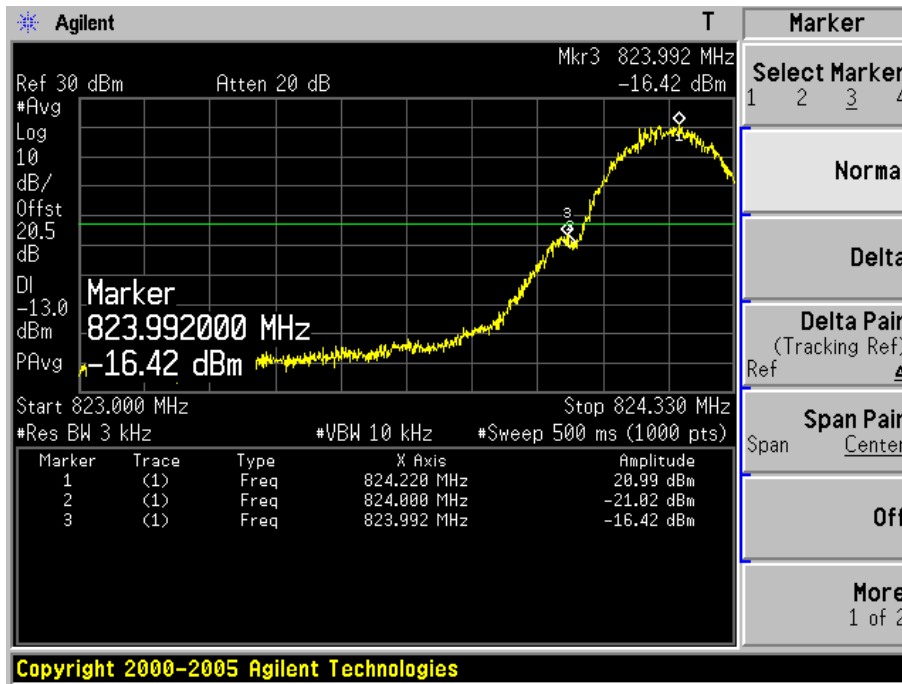
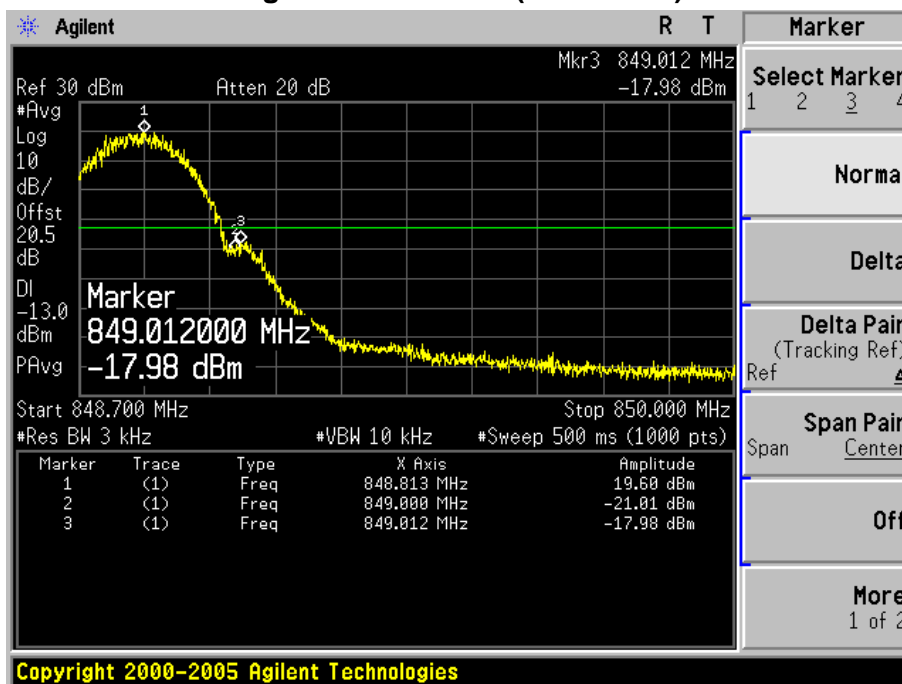

Figure Channel 251 (848.80MHz)



Product	Wireless Module		
Test Item	Spurious Emission At Antenna Terminals (+/- 1MHz)		
Test Mode	Mode 2: GSM1900 Link		
Date of Test	2014/11/23	Test Site	AC6

Figure Channel 512 (1850.20MHz)

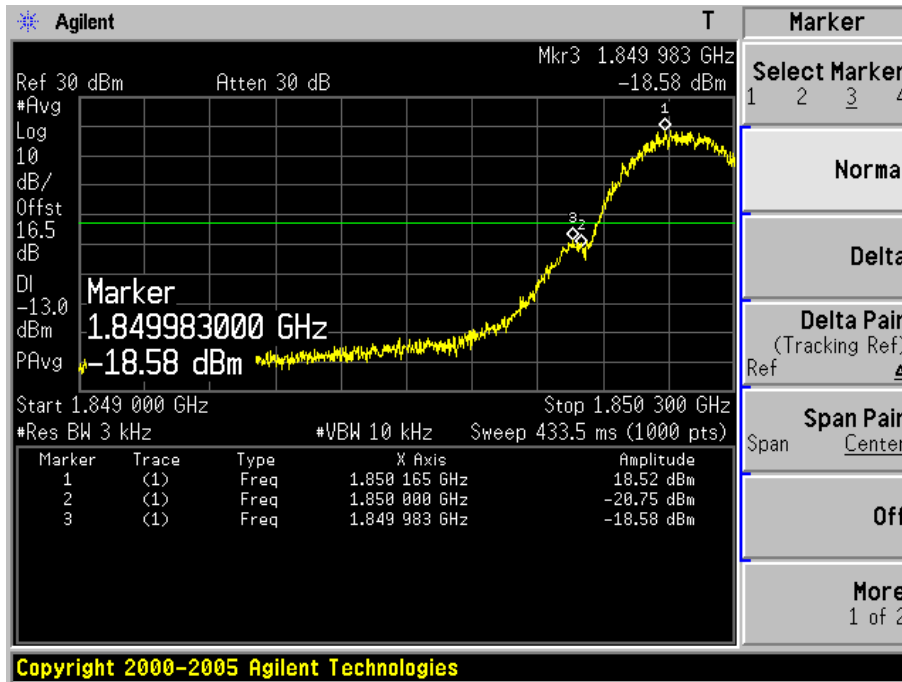
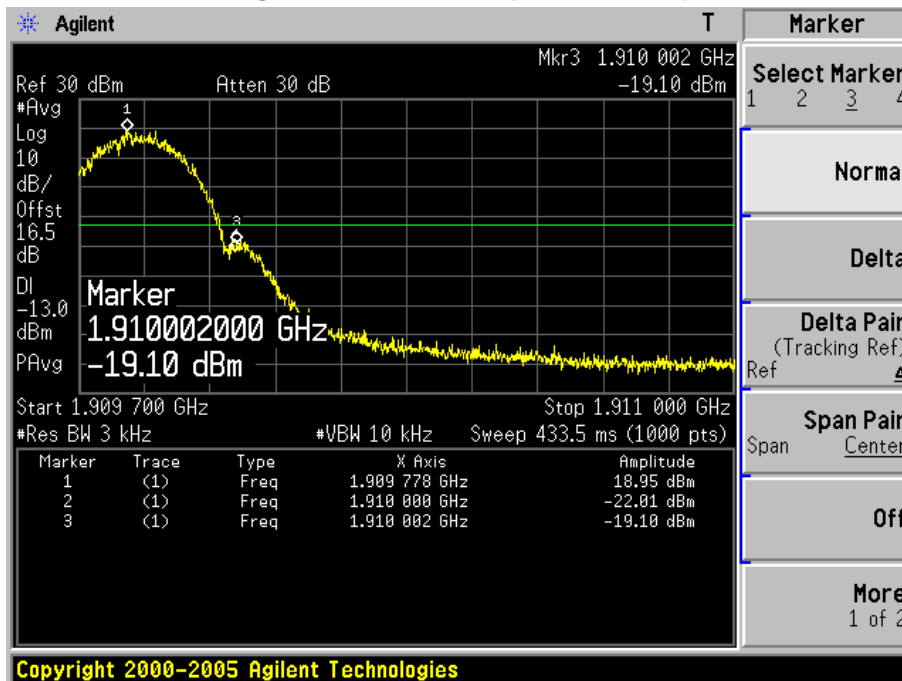

Figure Channel 810 (1909.80MHz)



Product	Wireless Module		
Test Item	Spurious Emission At Antenna Terminals (+/- 1MHz)		
Test Mode	Mode 3: EDGE 850 Link		
Date of Test	2014/11/23	Test Site	AC6

Figure Channel 128 (824.20MHz)

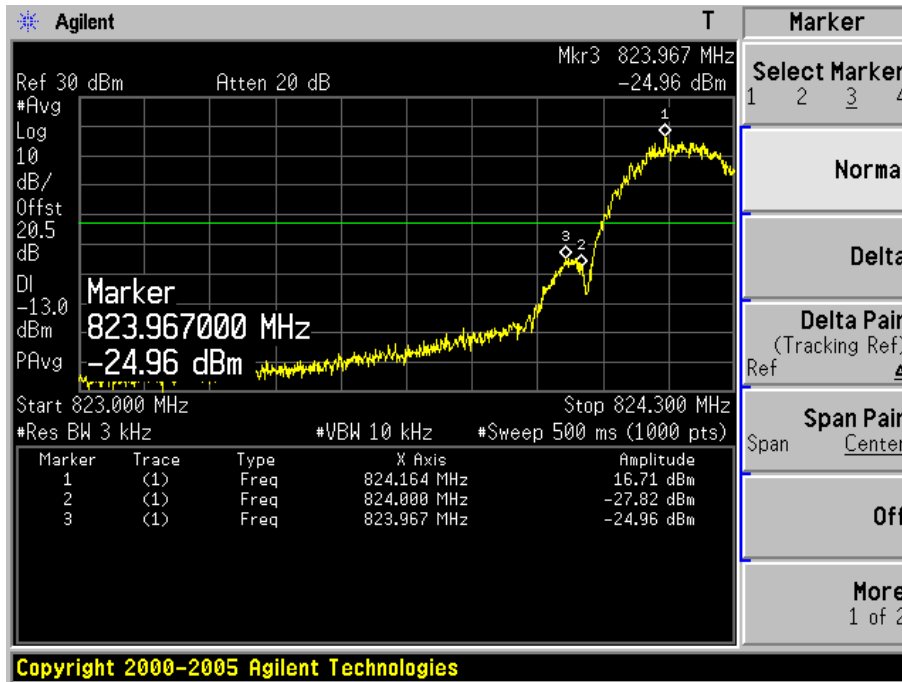
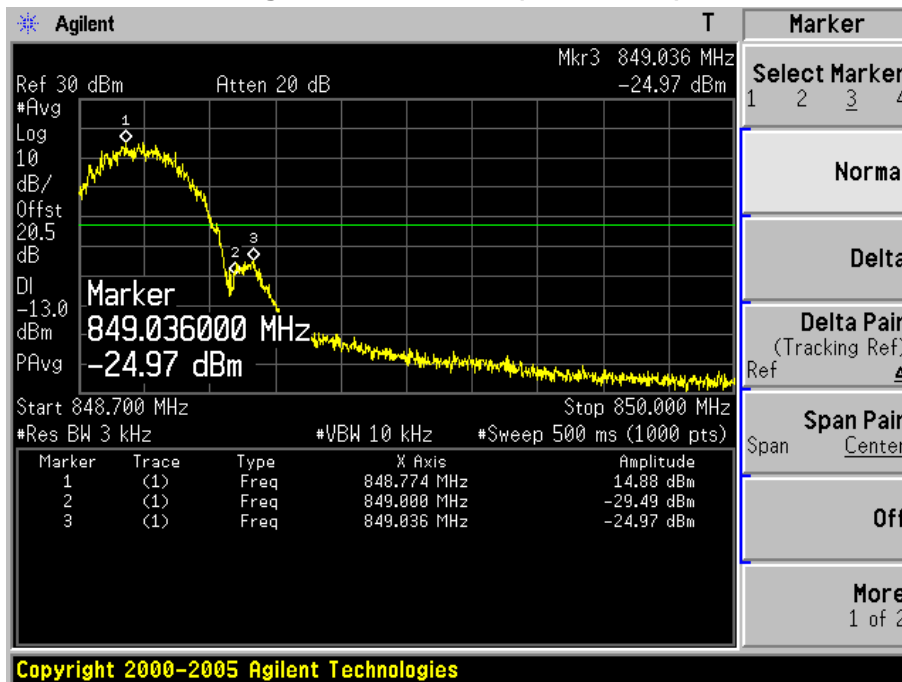

Figure Channel 251 (848.80MHz)



Product	Wireless Module		
Test Item	Spurious Emission At Antenna Terminals (+/- 1MHz)		
Test Mode	Mode 4: EDGE1900 Link		
Date of Test	2014/11/23	Test Site	AC6

Figure Channel 512 (1850.20MHz)

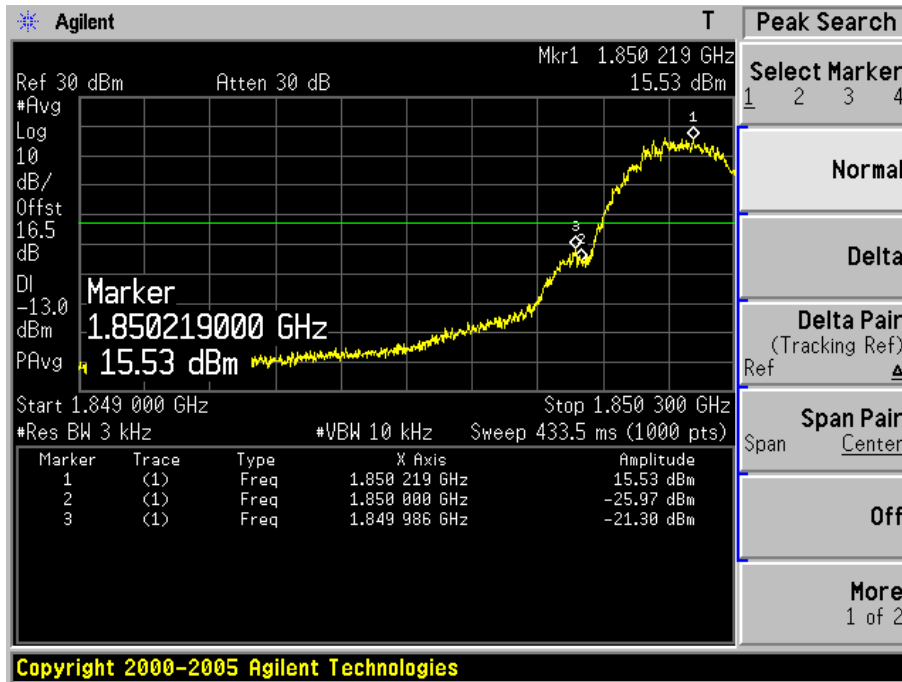
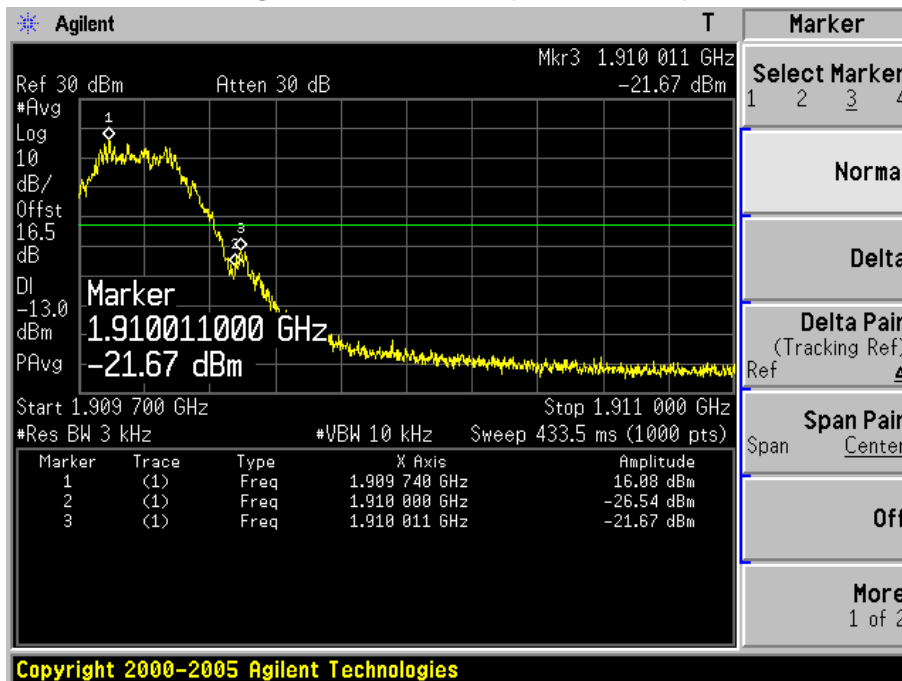

Figure Channel 810 (1909.80MHz)



Product	Wireless Module		
Test Item	Spurious Emission At Antenna Terminals (+/- 1MHz)		
Test Mode	Mode 5: WCDMA Band II Link		
Date of Test	2014/11/23	Test Site	AC6

Figure Channel 9262 (1852.40MHz)

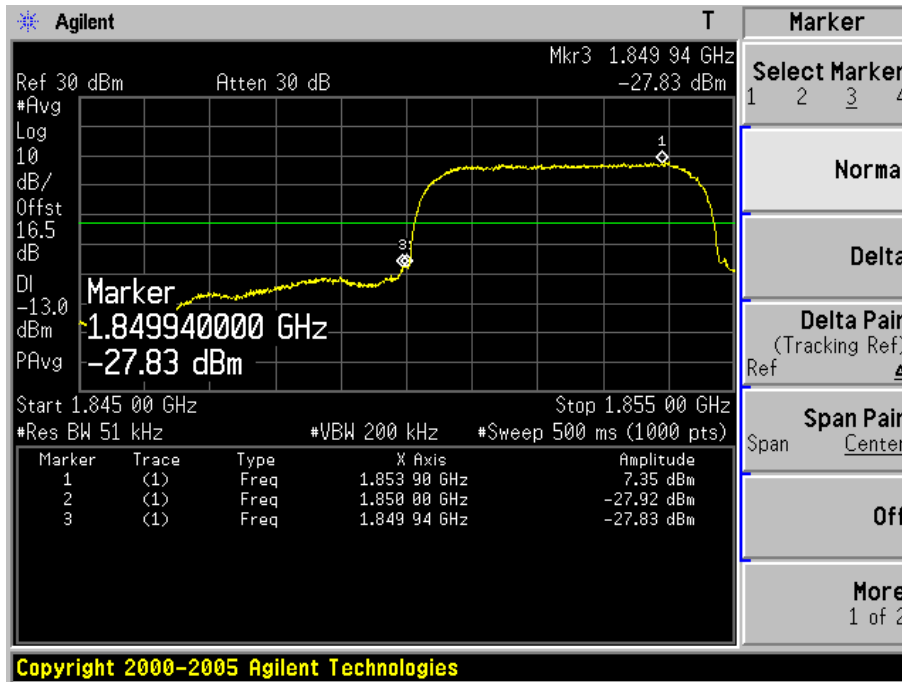
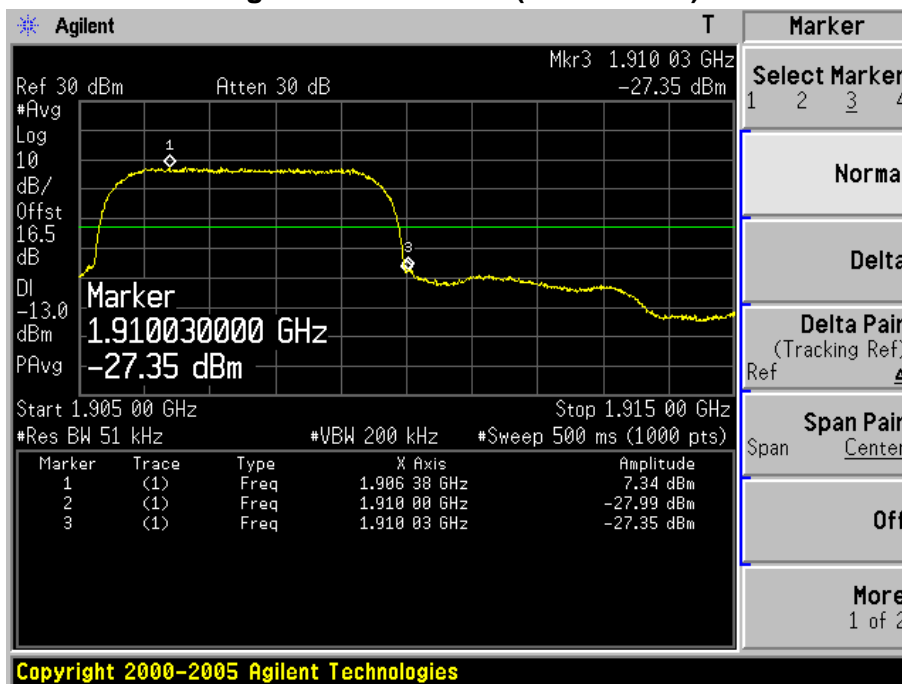

Figure Channel 9538 (1907.60MHz)



Product	Wireless Module		
Test Item	Spurious Emission At Antenna Terminals (+/- 1MHz)		
Test Mode	Mode 6: WCDMA Band V Link		
Date of Test	2014/11/23	Test Site	AC6

Figure Channel 4132 (826.40MHz)

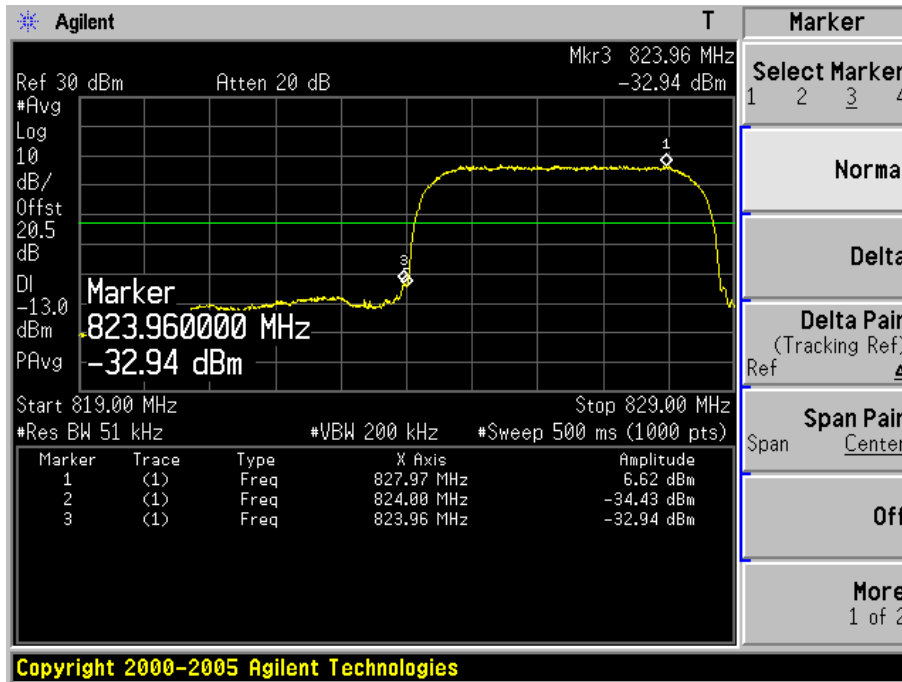
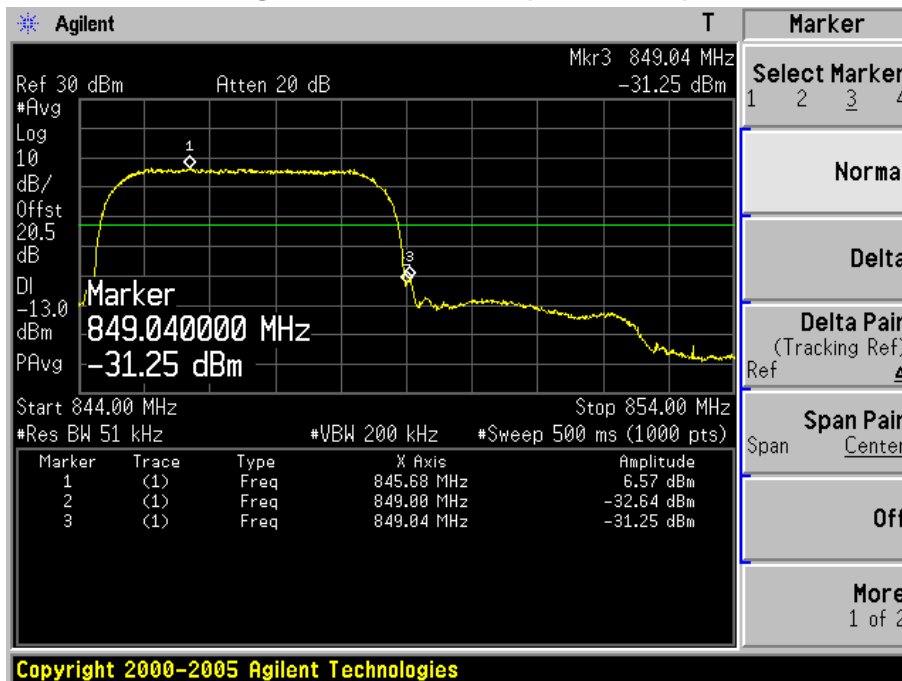

Figure Channel 4233 (846.60MHz)



7. Spurious Emission

7.1. Test Equipment

Spurious Emission / AC-5

Instrument	Manufacturer	Type No.	Serial No	Cali. Due Date
PSA Series Spectrum Analyzer	Agilent	E4440A	MY49420184	2015.03.28
Radio Communication Tester	R&S	CMU 200	117088	2015.03.28
Dual Directional Coupler	Agilent	778D	20160	2015.03.28
10dB Coaxial Coupler	Agilent	87300C	MY44300299	2015.03.28
PSG Analog Signal Generator	Agilent	E8257D	MY44321116	2015.03.28
Preamplifier	QuieTek	AP-025C	CHM-0503006	2015.04.11
Preamplifier	Miteq	NSP1800-25	1364185	2015.05.03
Bilog Antenna	Teseq GmbH	CBL6112D	27612	2015.10.15
Half Wave Tuned Dipole Antenna	COM-POWER	AD-100	40137	2016.02.26
Broad-Band Horn Antenna	Schwarzbeck	BBHA9120D	737	2016.02.26
Broad-Band Horn Antenna	Schwarzbeck	BBHA9120D	499	2015.06.08
Temperature/Humidity Meter	Zhicheng	ZC1-2	AC5-TH	2015.01.08

7.2. Test Setup

Radiated Spurious Measurement: below 1GHz

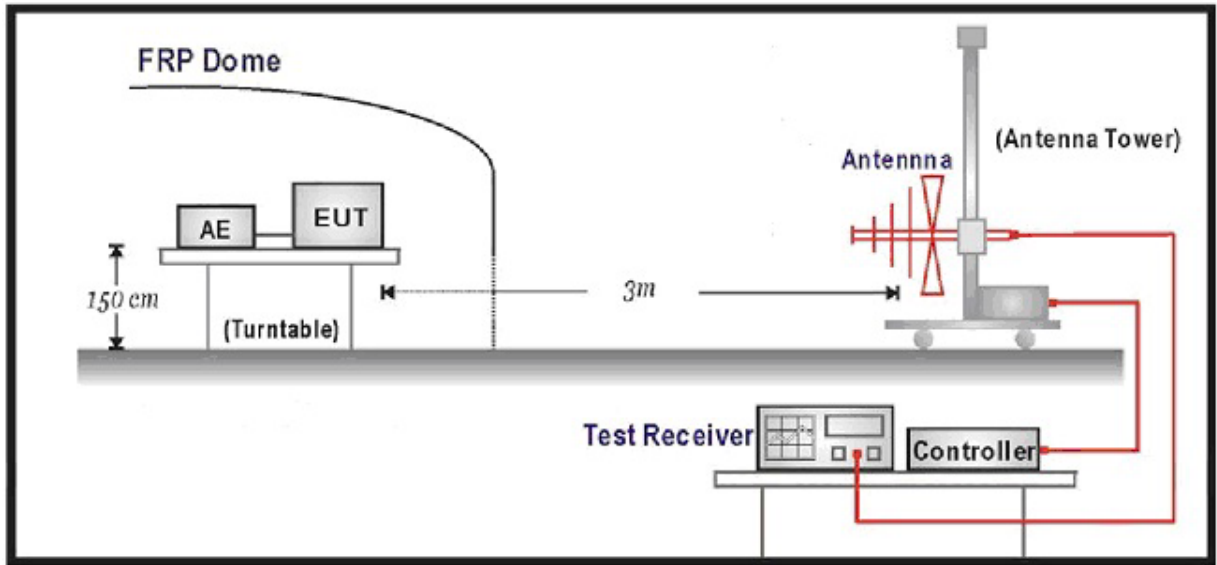

Radiated Spurious Measurement: above 1GHz

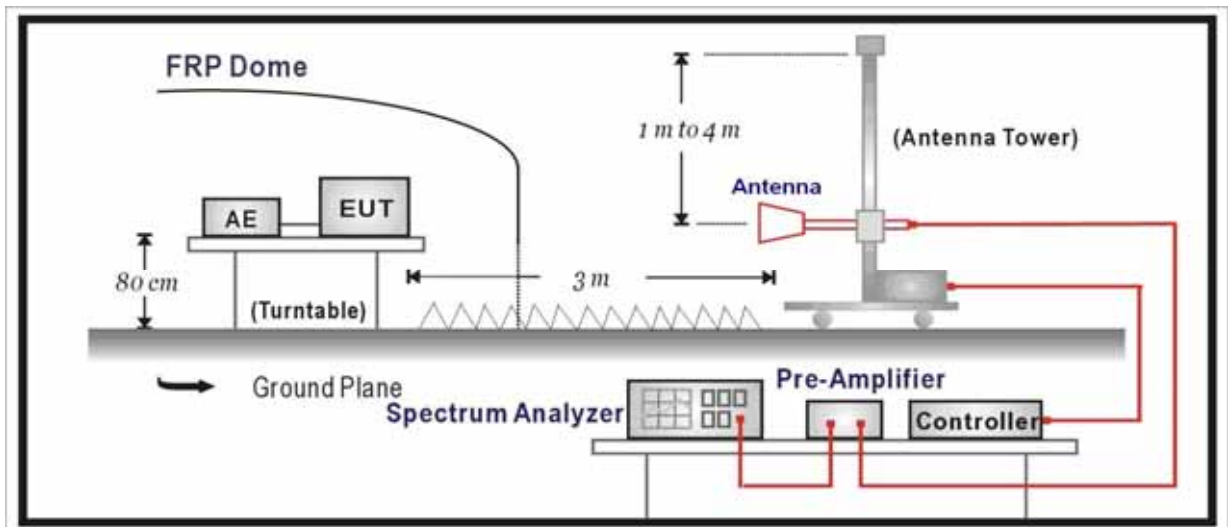

7.3. Limit

The power of any emission outside of the authorized operating frequency ranges must be attenuated below the transmitting power (P) by a factor of at least $43 + 10\log(P)$ dB.

7.4. Test Procedure

Conducted Spurious Measurement:

- a) Place the EUT on a bench and set it in transmitting mode.
- b) Connect a low loss RF cable from the antenna port to a spectrum analyzer and CMU200 by a Directional Couple.
- c) EUT Communicate with CMU200, then select a channel for testing.
- d) Add a correction factor to the display of spectrum, and then test.
- e) The resolution bandwidth of the spectrum analyzer was set at 1 MHz, sufficient scans were taken to show the out of band Emission if any up to 10th harmonic.

Radiated Spurious Measurement:

- a) The EUT shall be placed at the specified height on a support, and in the position closest to normal use as declared by provider.
- b) The test antenna shall be oriented initially for vertical polarization and shall be chosen to correspond to the frequency of the transmitter
- c) The output of the test antenna shall be connected to the measuring receiver.
- d) The transmitter shall be switched on and the measuring receiver shall be tuned to the frequency of the transmitter under test.
- e) The test antenna shall be raised and lowered through the specified range of height until a maximum signal level is detected by the measuring receiver.
- f) The transmitter shall then be rotated through 360° in the horizontal plane, until the maximum signal level is detected by the measuring receiver.
- g) The test antenna shall be raised and lowered again through the specified range of height until a maximum signal level is detected by the measuring receiver.
- v) The maximum signal level detected by the measuring receiver shall be noted.
- h) The transmitter shall be replaced by a substitution antenna.
- i) The substitution antenna shall be orientated for vertical polarization and the length of the substitution antenna shall be adjusted to correspond to the frequency of the transmitter.
- j) The substitution antenna shall be connected to a calibrated signal generator.
- k) If necessary, the input attenuator setting of the measuring receiver shall be adjusted in order to increase the sensitivity of the measuring receiver.
- l) The test antenna shall be raised and lowered through the specified range of height to ensure that the maximum signal is received.
- m) The input signal to the substitution antenna shall be adjusted to the level that produces a level detected by the measuring receiver, that is equal to the level noted while the transmitter radiated power was measured, corrected for the change of input attenuator setting of the measuring receiver.

- n) The measurement shall be repeated with the test antenna and the substitution antenna orientated for horizontal polarization.
- o) The measure of the effective radiated power is the larger of the two levels recorded at the input to the substitution antenna, corrected for gain of the substitution antenna if necessary.
- p) The frequency range was checked up to 10th harmonic.
- q) Test site anechoic chamber refer to ANSI C63.4: 2009

7.5. Uncertainty

The measurement uncertainty is defined as 3.2 dB for Radiated Power Measurement.

7.6. Test Result

Product	Wireless Module		
Test Item	Conducted Spurious Emission		
Test Mode	Mode 1: GSM 850 Link		
Date of Test	2014/11/22	Test Site	TR8

Low Channel 128(824.20MHz)

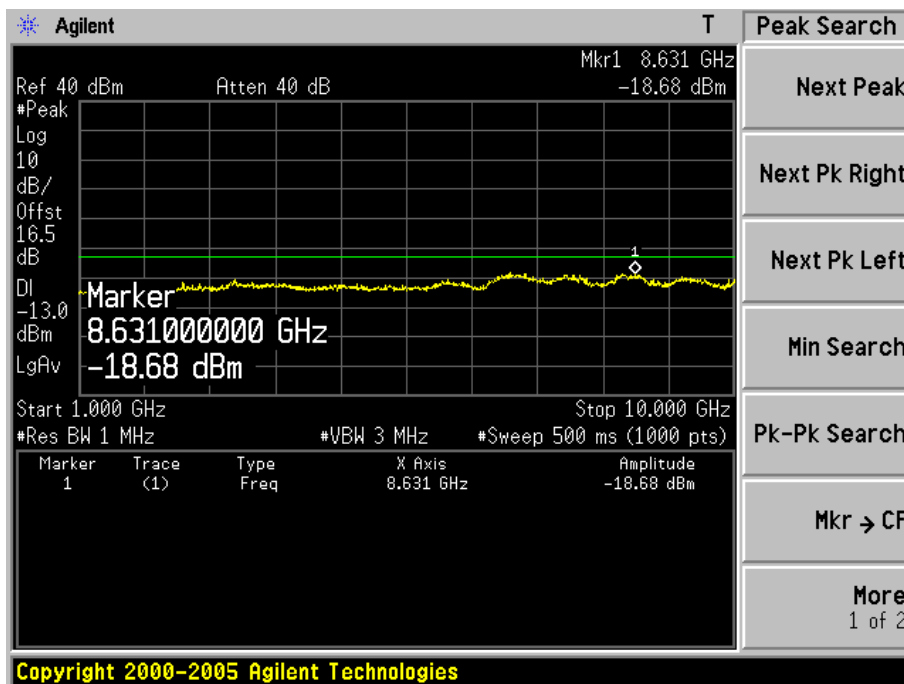
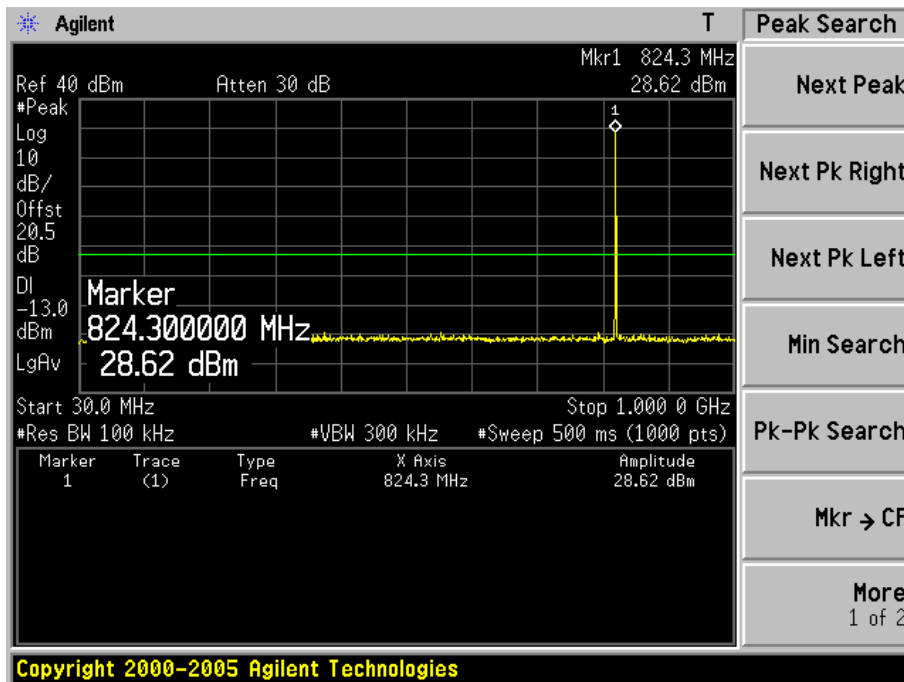

Mid Channel 189(836.40MHz)

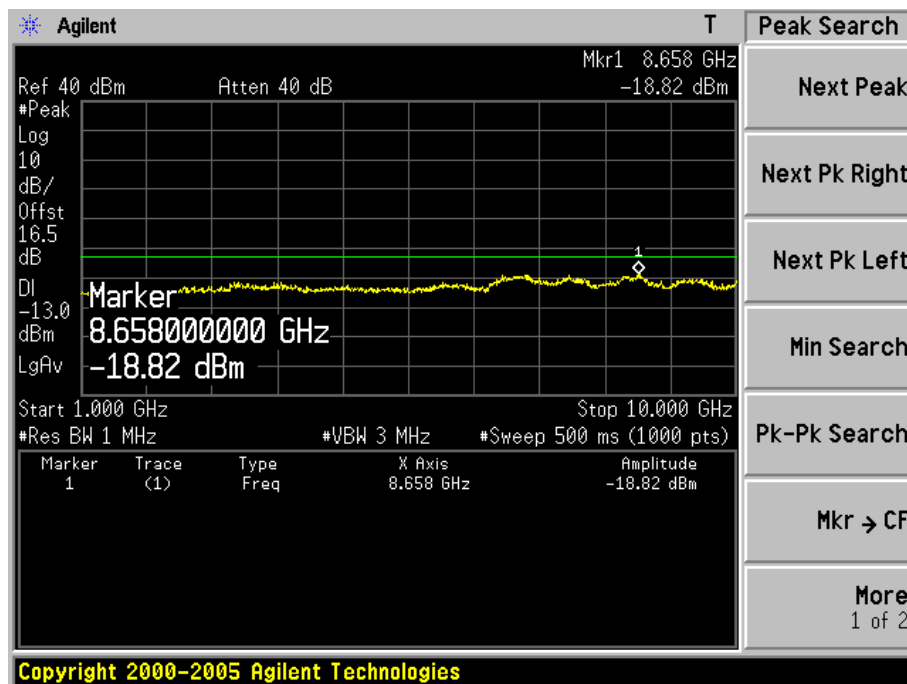
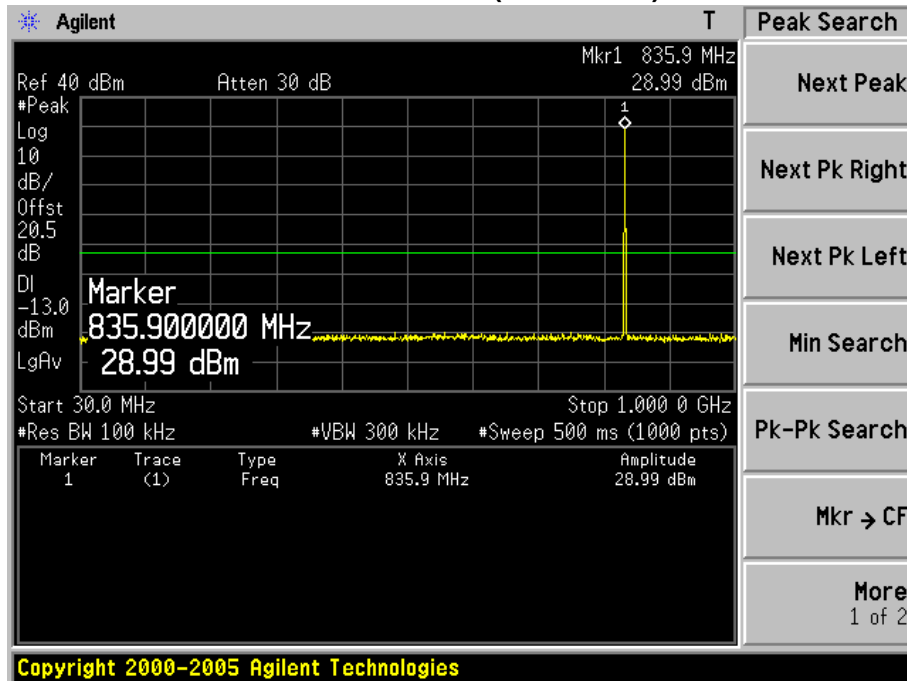

High Channel 251(848.80MHz)

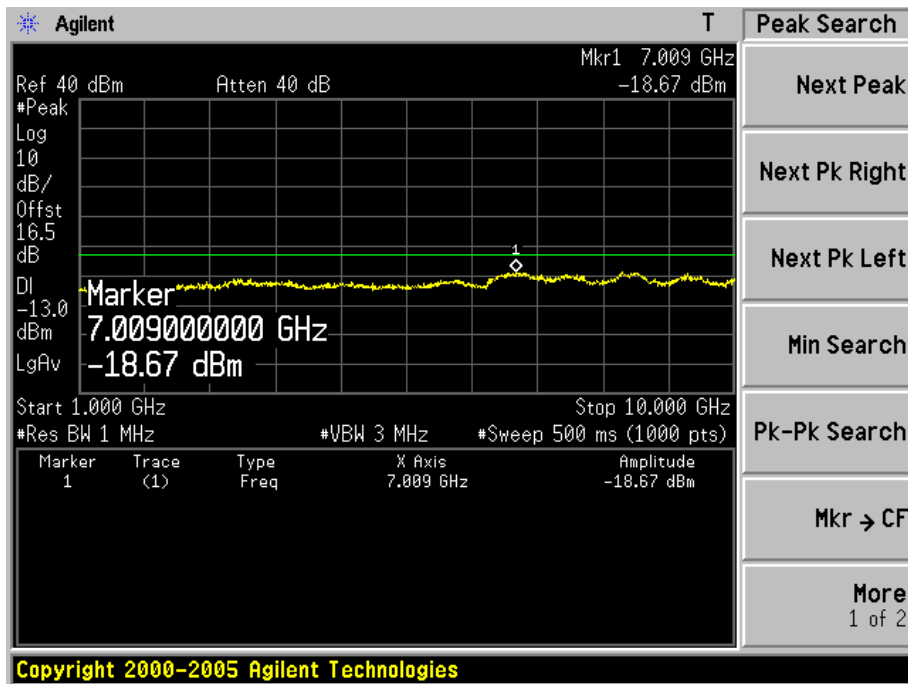
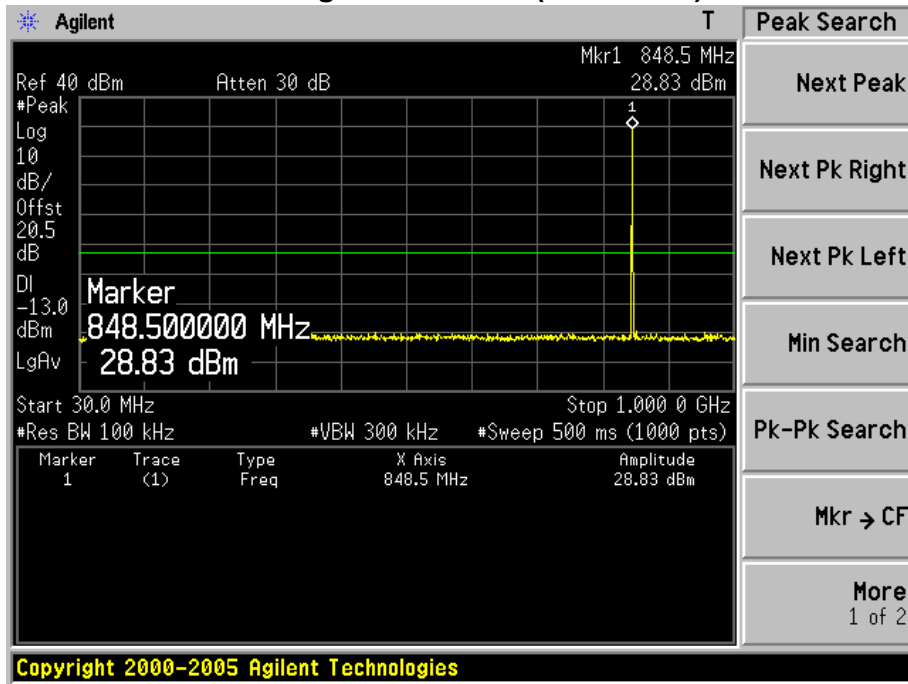

Product	Wireless Module		
Test Item	Conducted Spurious Emission		
Test Mode	Mode 2: GSM1900 Link		
Date of Test	2014/11/22	Test Site	TR8

Low Channel 512(1850.20MHz)

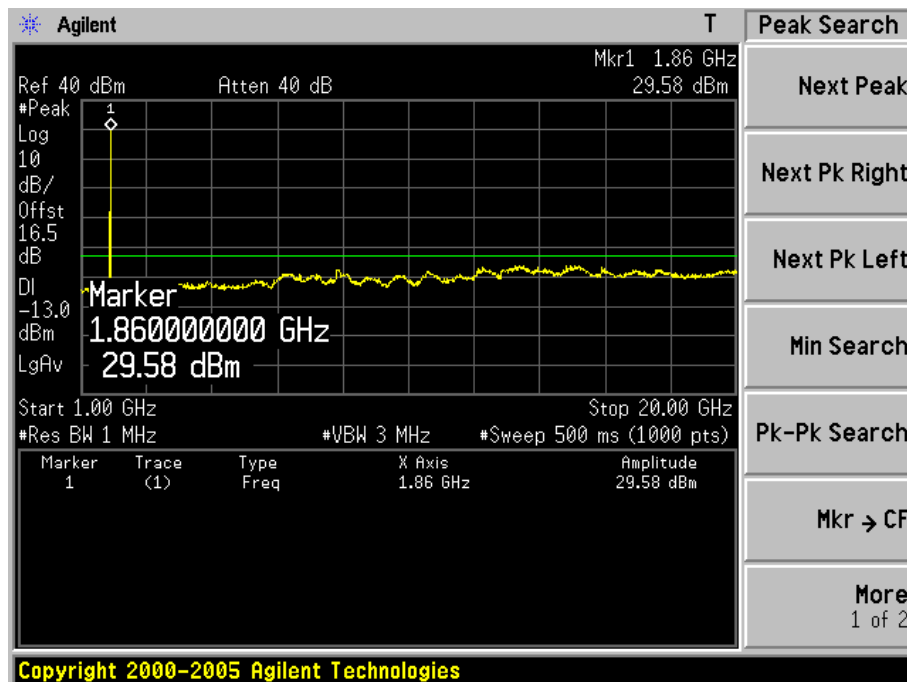
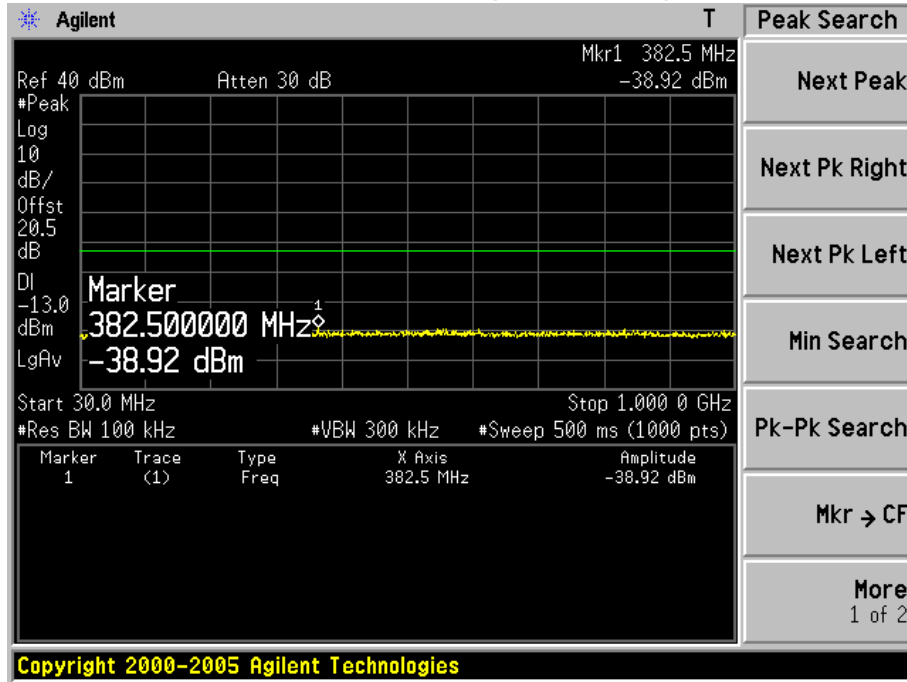

Mid Channel 661(1880.00MHz)

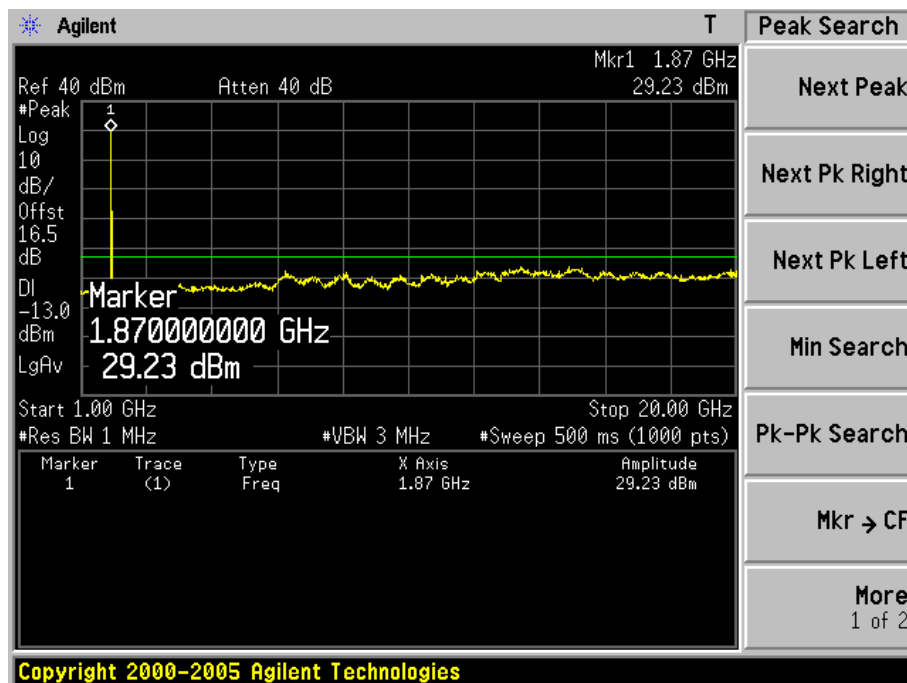
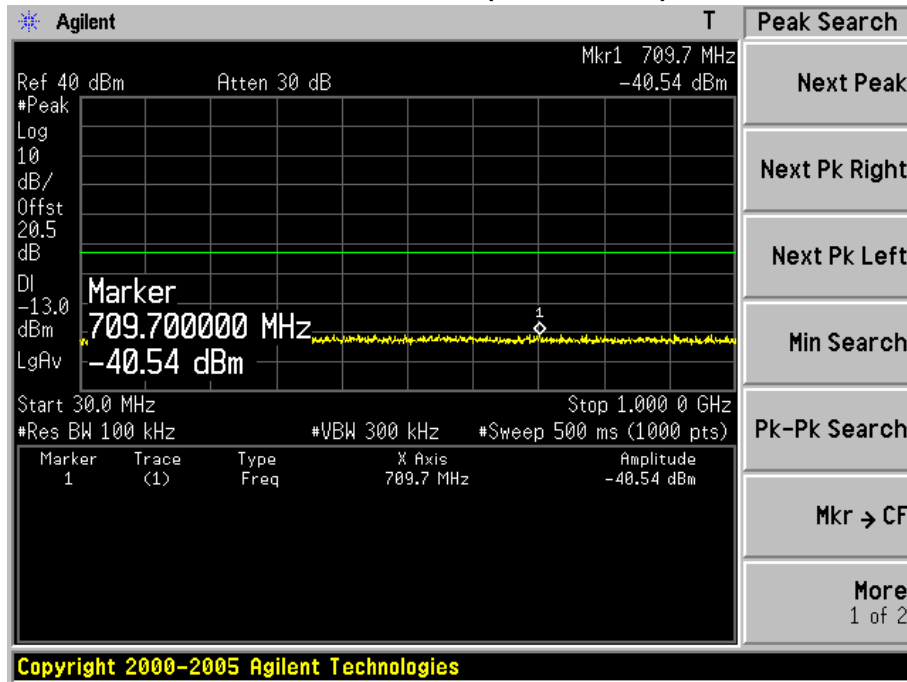

High Channel 810(1909.80MHz)

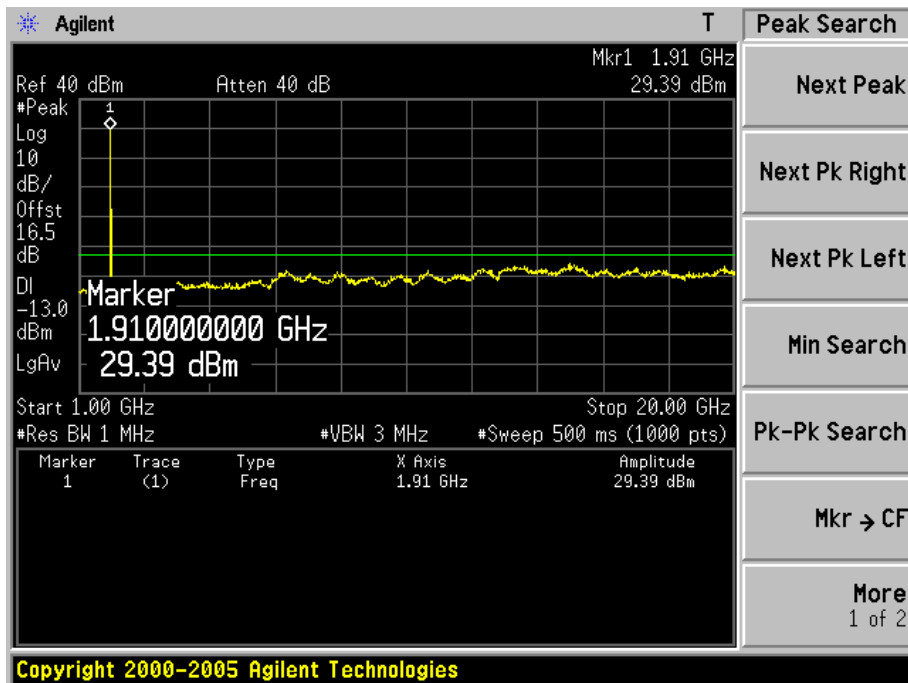
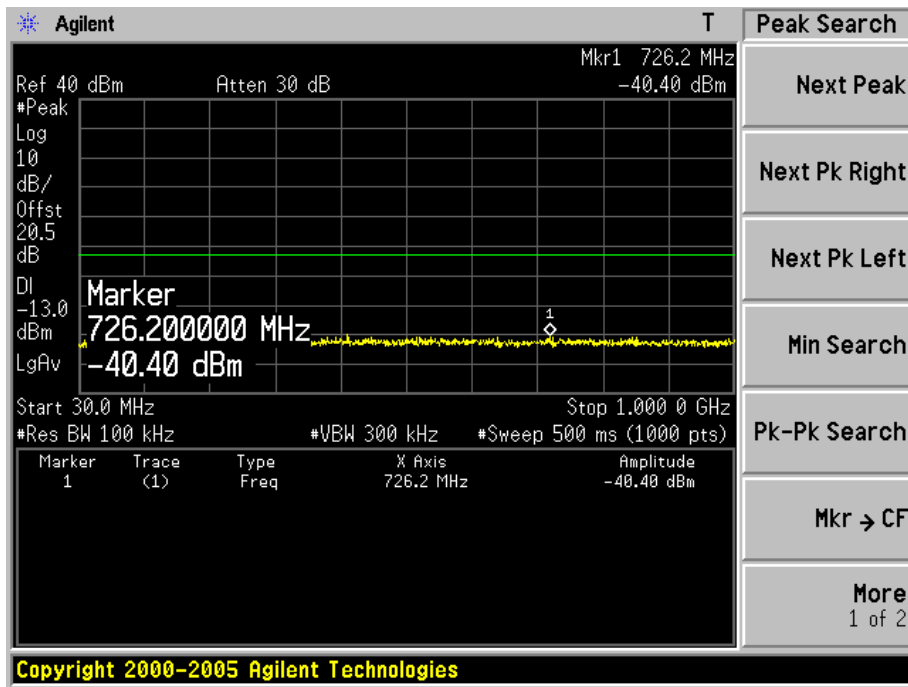

Product	Wireless Module		
Test Item	Conducted Spurious Emission		
Test Mode	Mode 3: EDGE 850 Link		
Date of Test	2014/11/22	Test Site	TR8

Low Channel 128(824.20MHz)

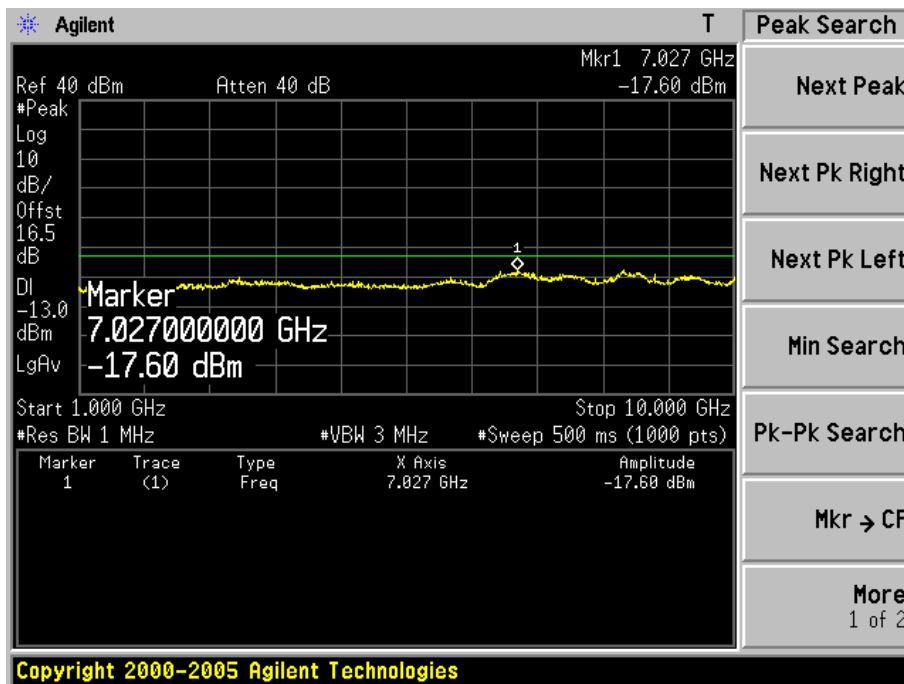
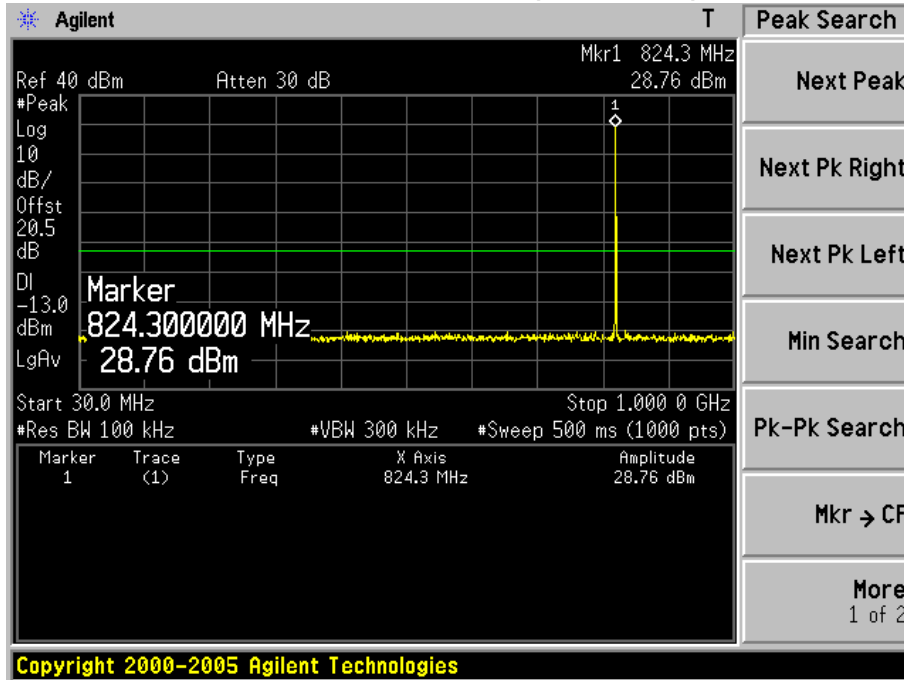

Mid Channel 189(836.40MHz)

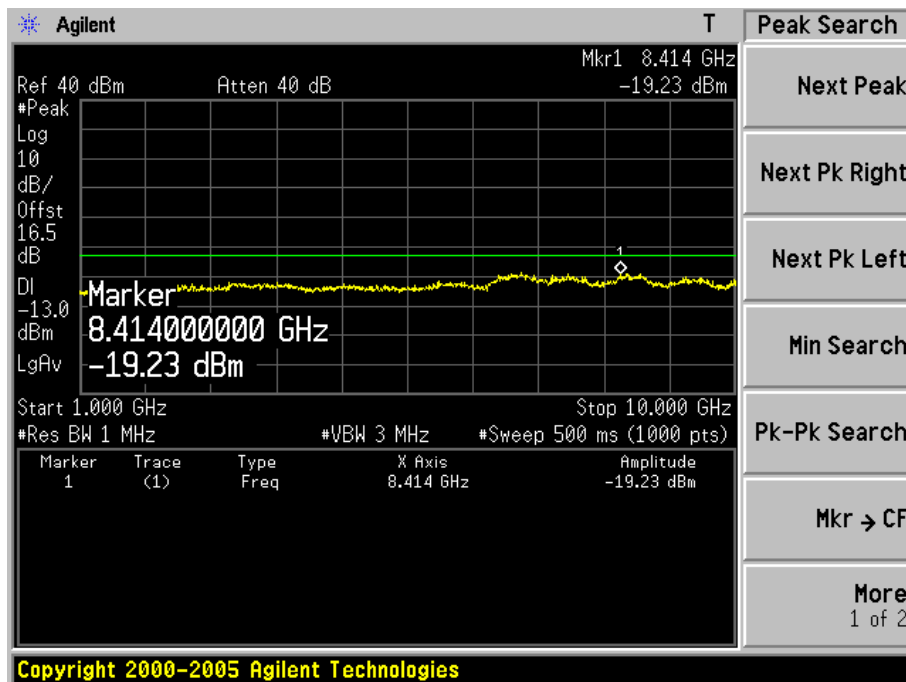
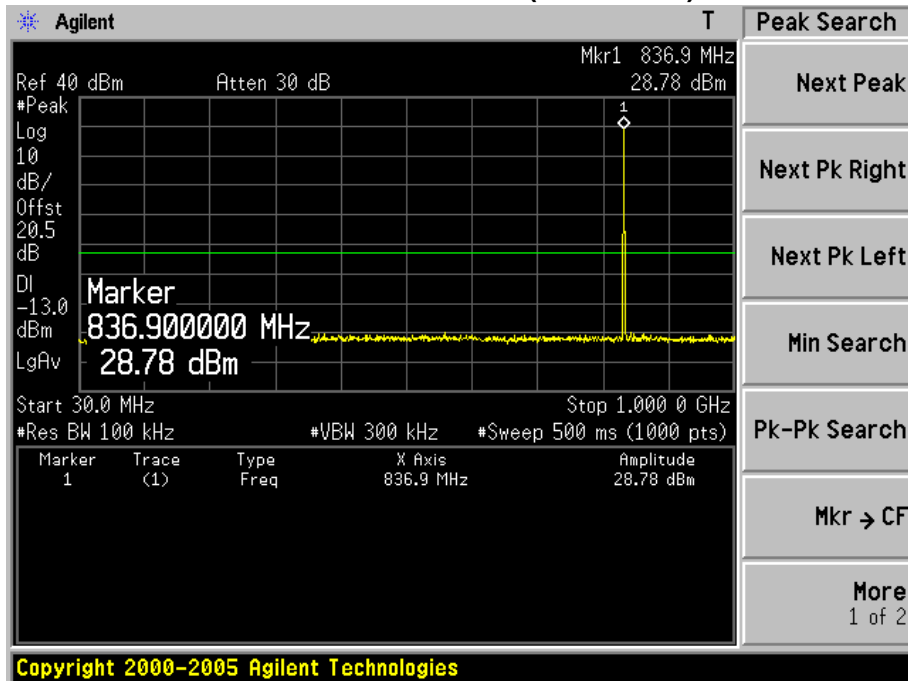

High Channel 251(848.80MHz)

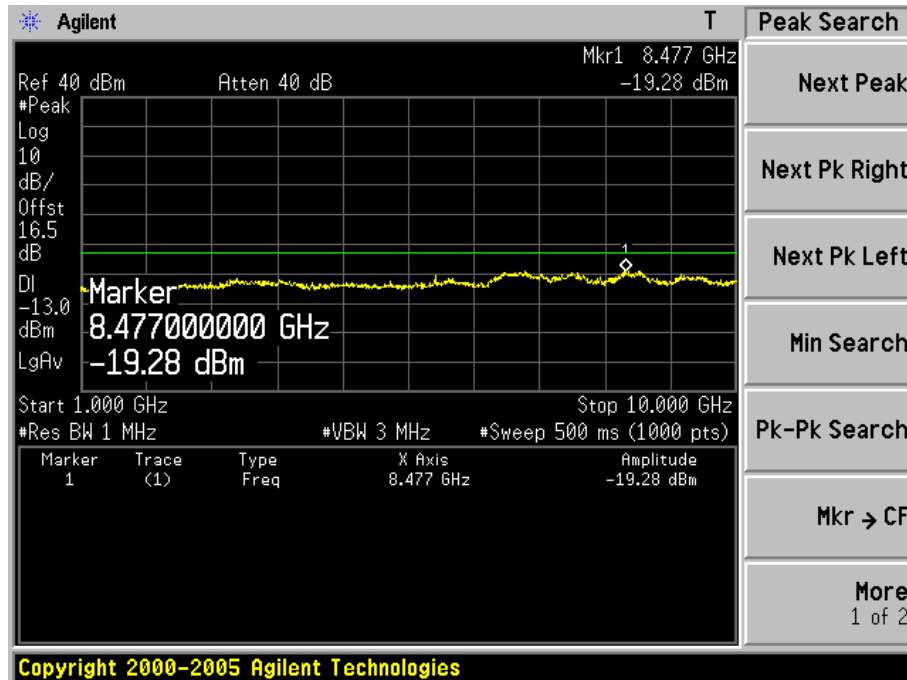
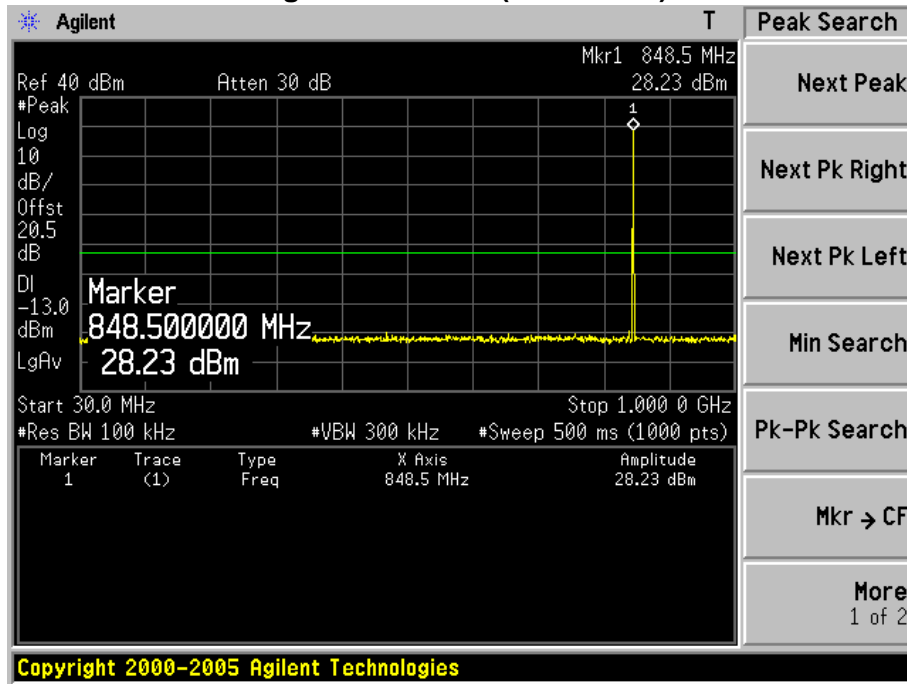

Product	Wireless Module		
Test Item	Conducted Spurious Emission		
Test Mode	Mode 4: EDGE1900 Link		
Date of Test	2014/11/22	Test Site	TR8

Low Channel 512(1850.20MHz)

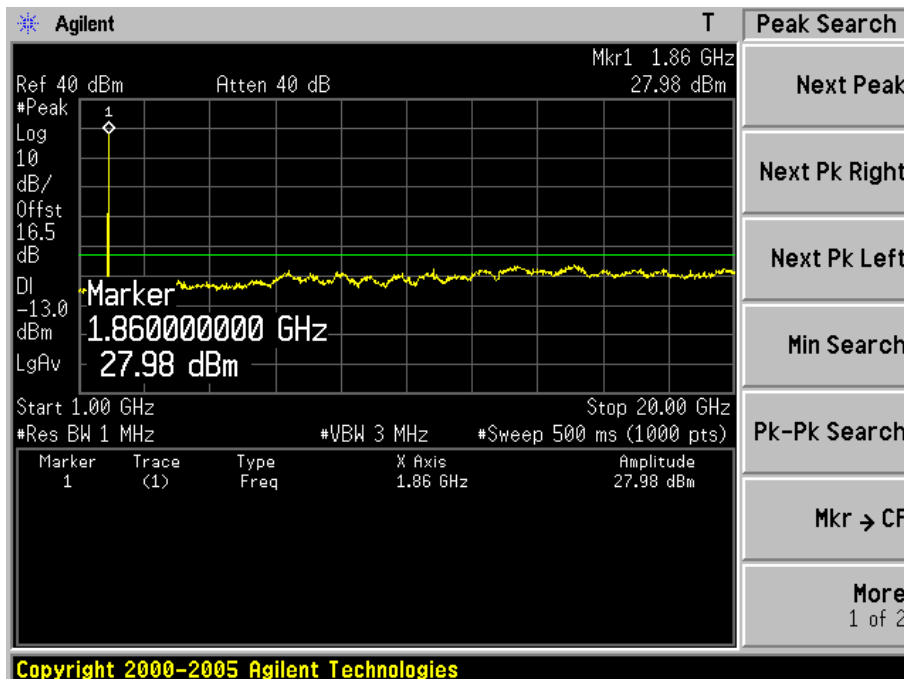
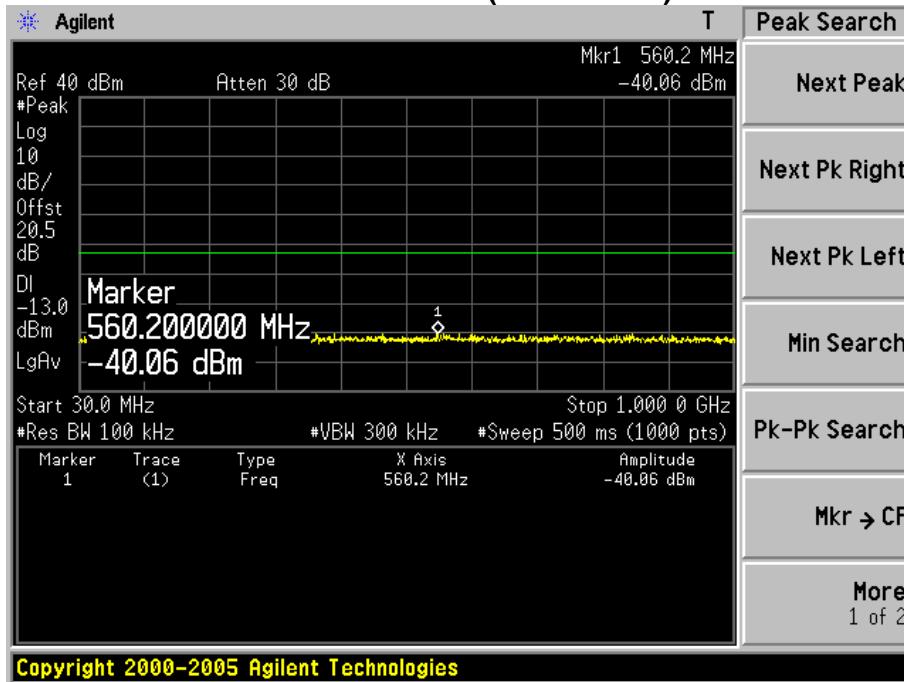

Mid Channel 661(1880.00MHz)

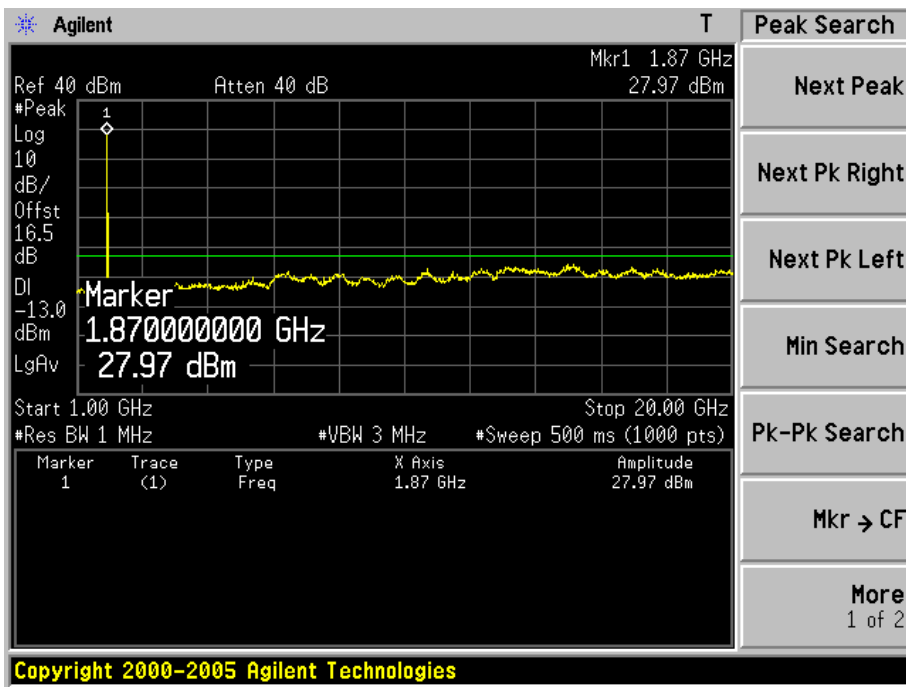
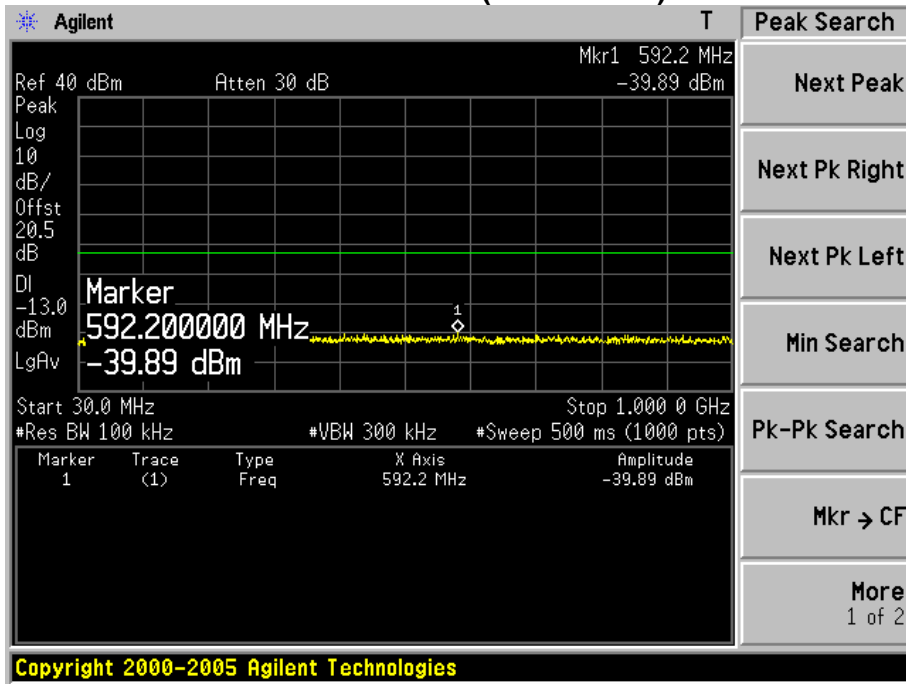

High Channel 810(1909.80MHz)

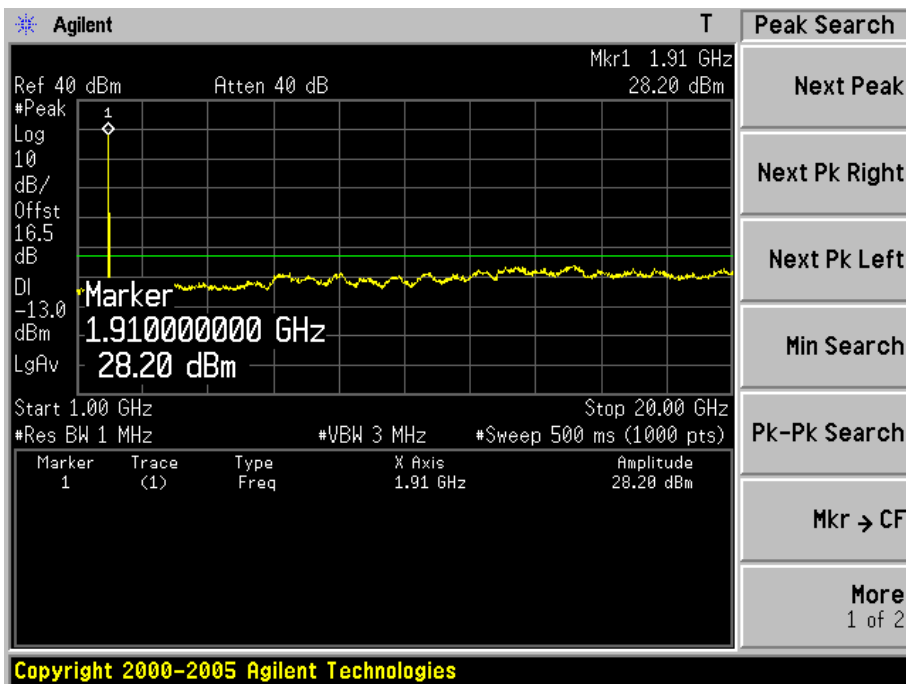
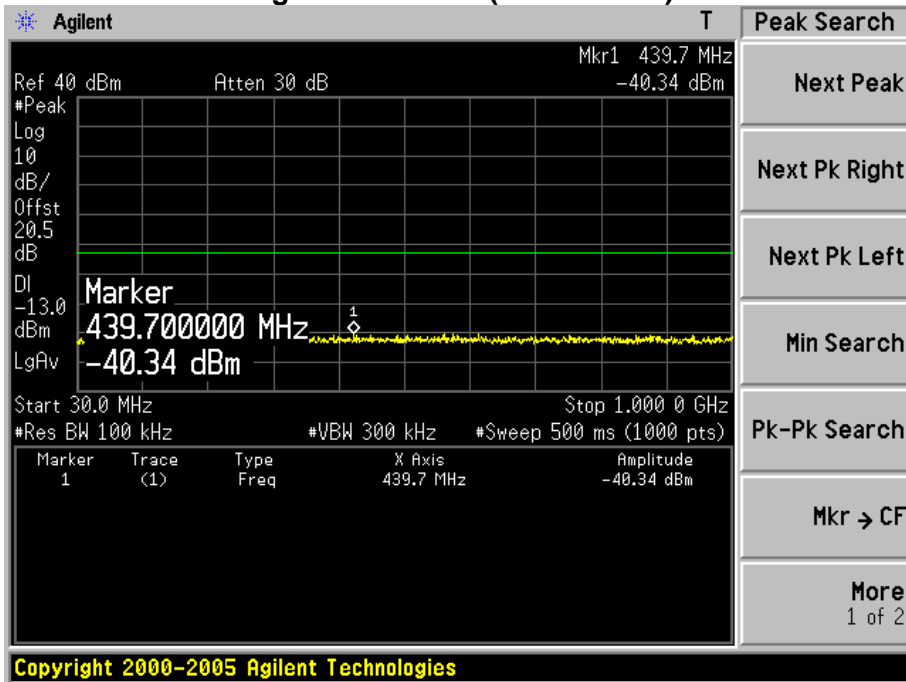

Product	Wireless Module		
Test Item	Conducted Spurious Emission		
Test Mode	Mode 5: WCDMA Band II Link		
Date of Test	2014/11/22	Test Site	TR8

Low Channel 9262(1852.40MHz)

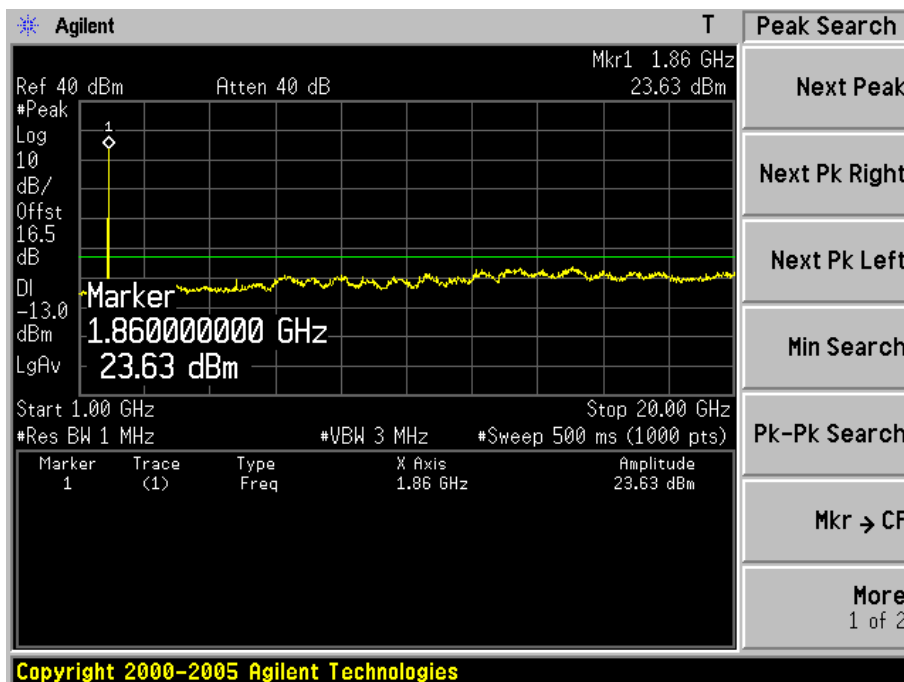
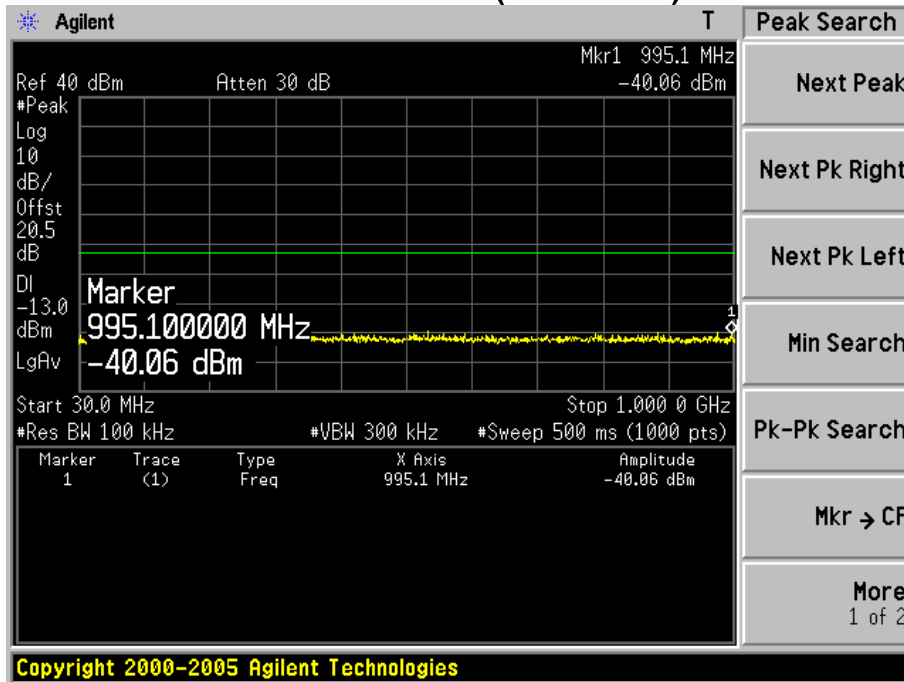

Mid Channel 9400(1880.00MHz)

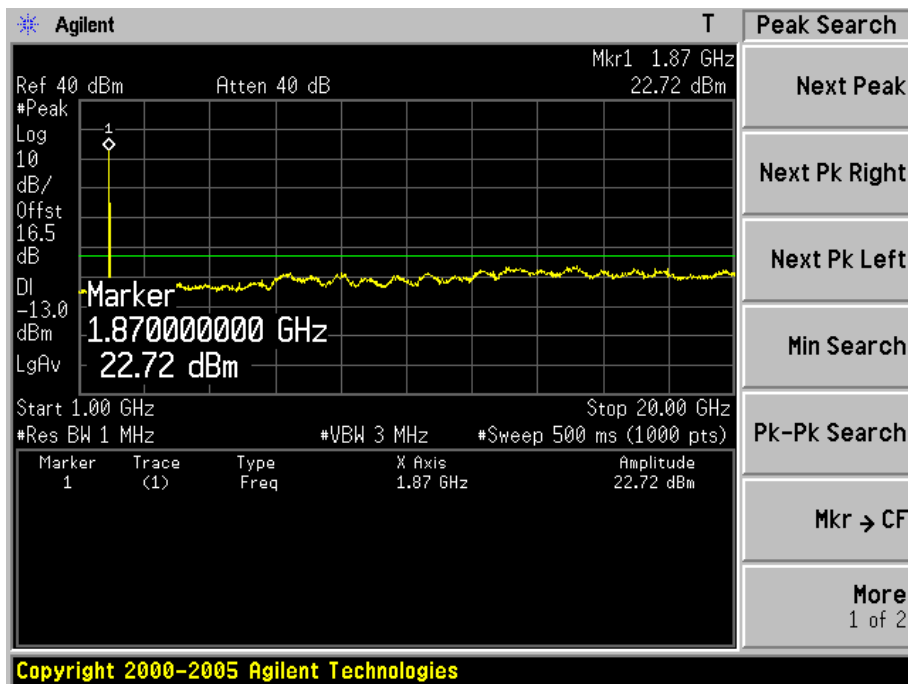
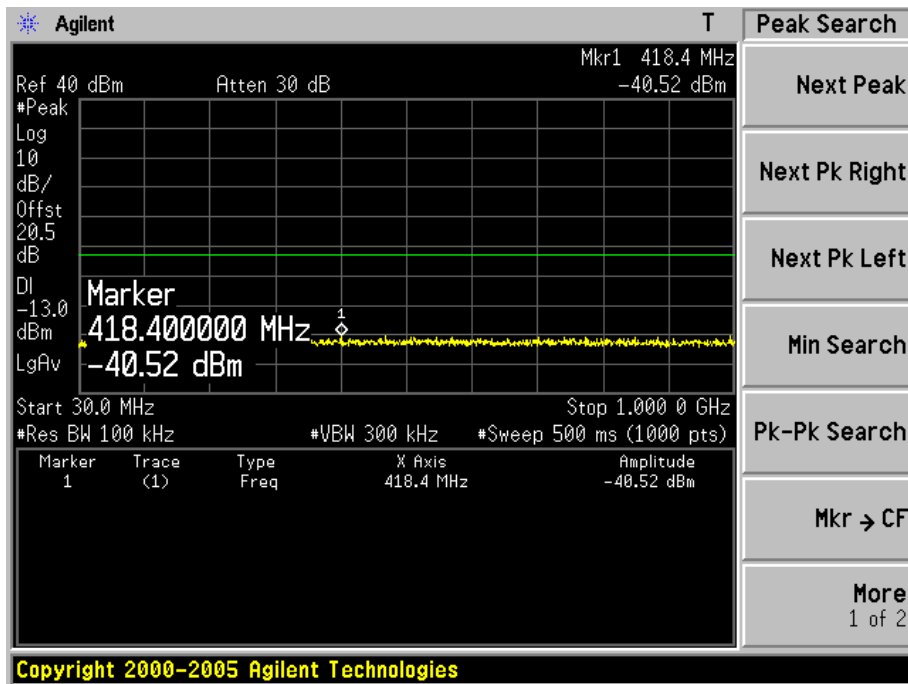

High Channel 9538(1907.60MHz)

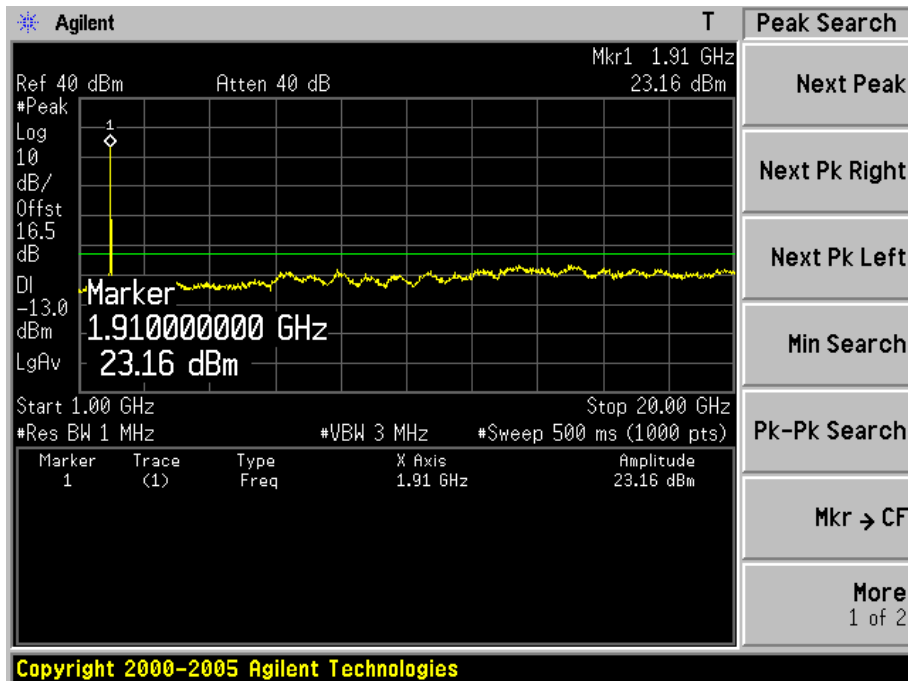
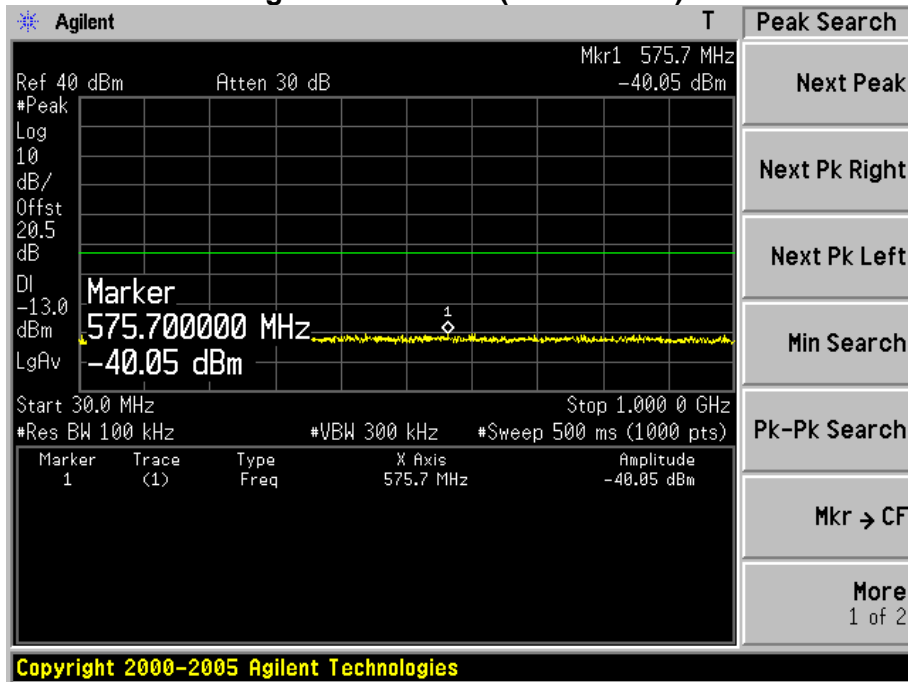

Product	Wireless Module		
Test Item	Conducted Spurious Emission		
Test Mode	Mode 6: WCDMA Band V Link		
Date of Test	2014/11/22	Test Site	TR8

Low Channel 4132(826.40MHz)

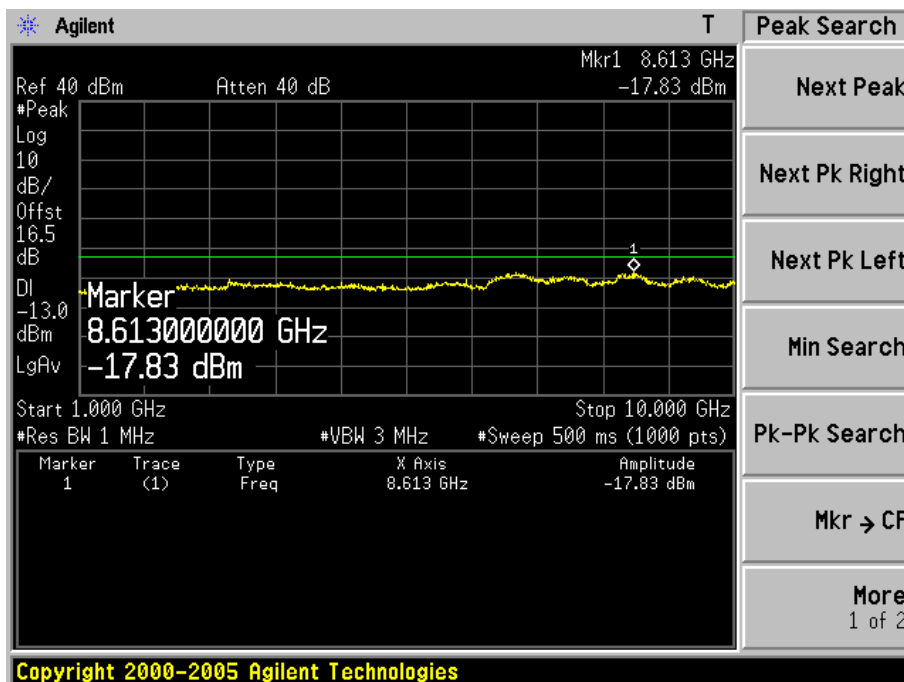
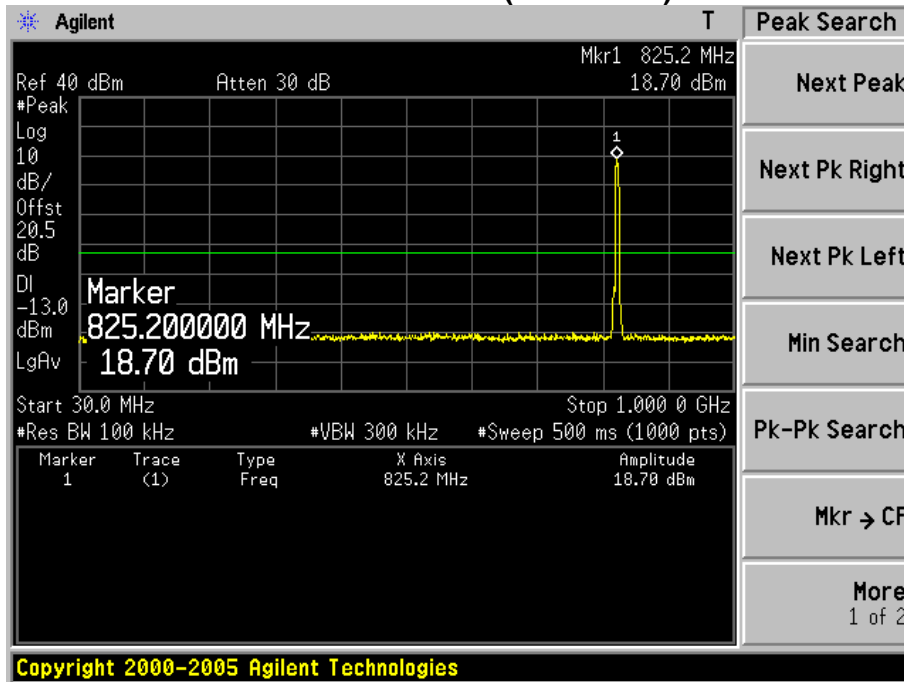

Mid Channel 4182(836.40MHz)

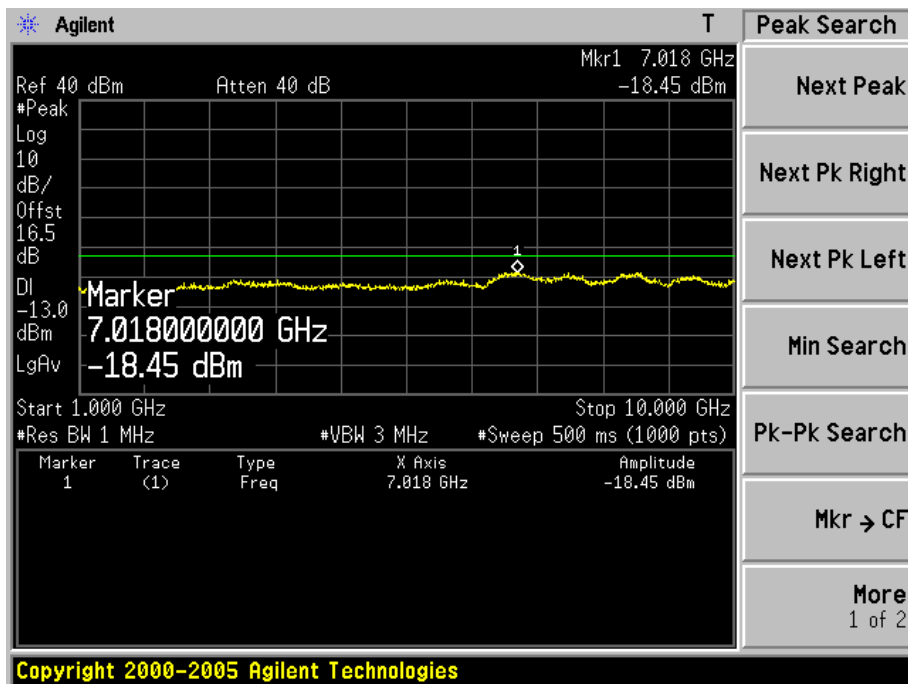
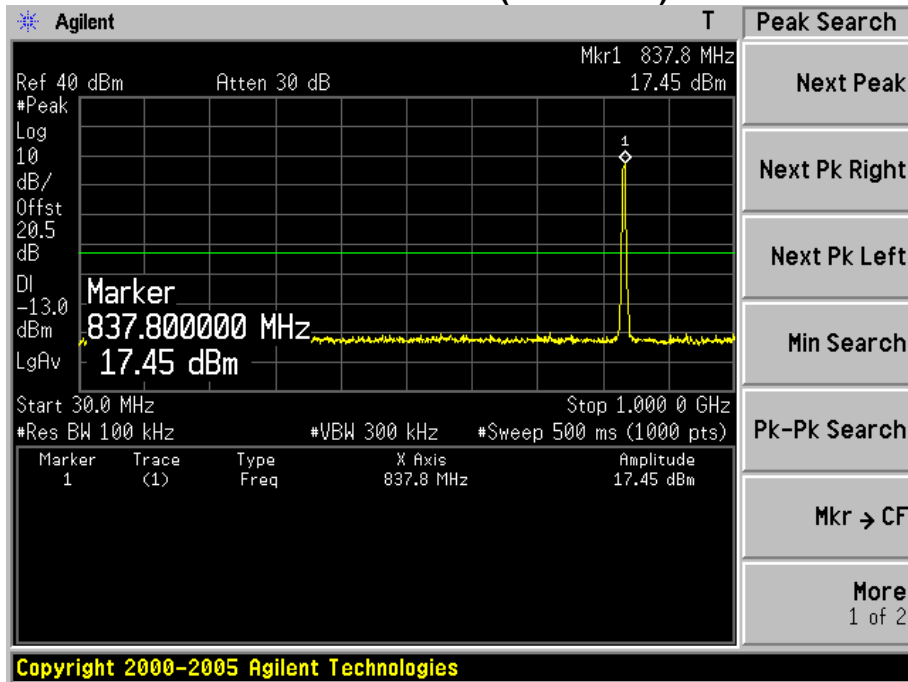

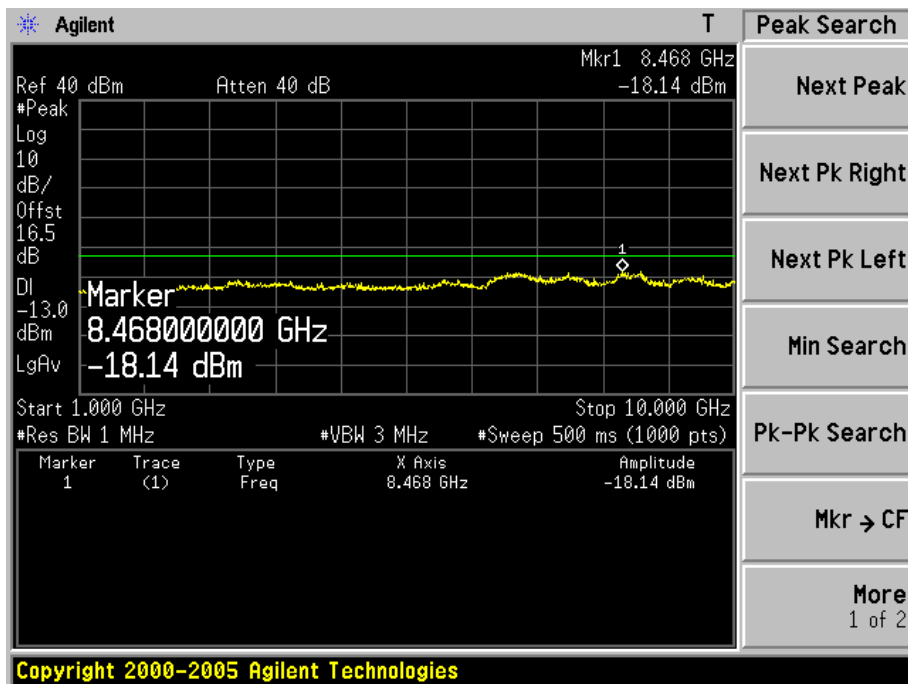
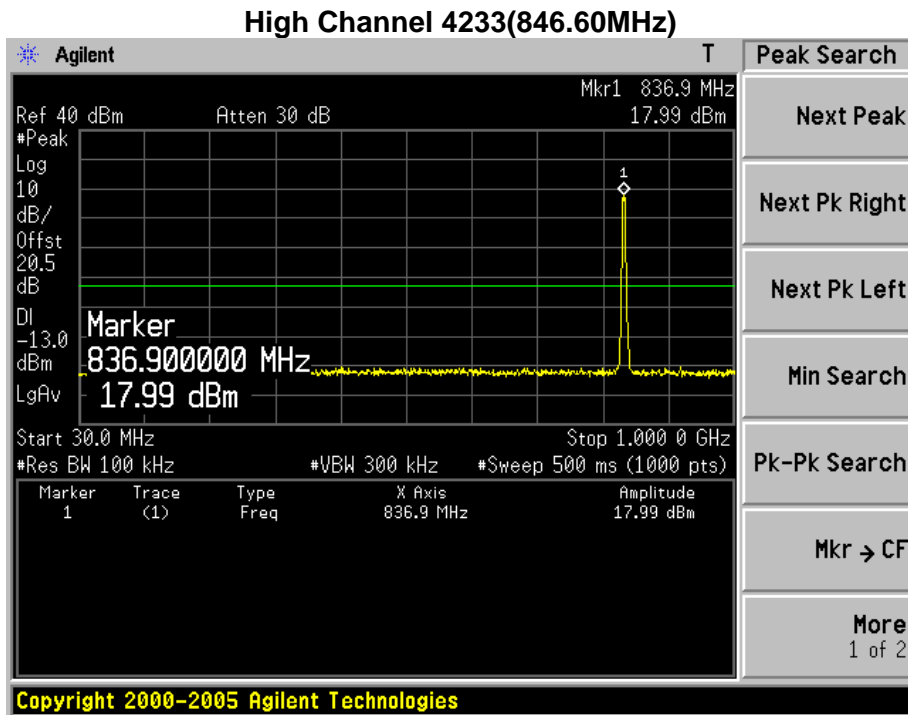

Product	Wireless Module		
Test Item	Radiated Spurious Emission		
Test Mode	Mode 1: GSM 850 Link		
Date of Test	2014/11/21	Test Site	AC-5

Frequency (MHz)	SA Reading (dBm)	Ant.Pol. (H/V)	SG Reading (dBm)	Cable Loss (dB)	Gain (dBi)	EIRP (dBm)	Limit (dBm)	Margin (dB)
Low Channel 128 (824.20MHz)								
1646.00	-56.24	V	-58.80	2.50	9.75	-51.55	-13.00	-38.55
2470.50	-61.97	V	-61.06	3.12	10.48	-53.70	-13.00	-40.70
1646.00	-49.49	H	-52.13	2.50	9.75	-44.88	-13.00	-31.88
2470.50	-62.68	H	-61.48	3.12	10.48	-54.12	-13.00	-41.12
Middle Channel 189 (836.40MHz)								
1671.50	-56.15	V	-58.45	2.52	9.95	-51.02	-13.00	-38.02
2513.00	-63.07	V	-60.39	3.18	10.62	-52.95	-13.00	-39.95
1671.50	-48.53	H	-50.93	2.52	9.95	-43.50	-13.00	-30.50
2513.00	-58.17	H	-57.18	3.18	10.62	-49.74	-13.00	-36.74
High Channel 251 (848.80MHz)								
1697.00	-56.45	V	-58.84	2.54	10.06	-51.32	-13.00	-38.32
2547.00	-61.12	V	-59.57	3.14	10.68	-52.03	-13.00	-39.03
1697.00	-52.58	H	-54.58	2.54	10.06	-47.06	-13.00	-34.06
2547.00	-56.83	H	-55.03	3.14	10.68	-47.49	-13.00	-34.49

Product	Wireless Module		
Test Item	Radiated Spurious Emission		
Test Mode	Mode 2: GSM 1900 Link		
Date of Test	2014/11/21	Test Site	AC-5

Frequency (MHz)	SA Reading (dBm)	Ant.Pol. (H/V)	SG Reading (dBm)	Cable Loss (dB)	Gain (dBi)	EIRP (dBm)	Limit (dBm)	Margin (dB)
Low Channel 512 (1850.20MHz)								
3700.00	-60.52	V	-57.09	3.84	12.69	-48.24	-13.00	-35.24
5550.00	-64.66	V	-56.15	4.82	13.15	-47.82	-13.00	-34.82
3700.00	-61.43	H	-58.07	3.84	12.69	-49.22	-13.00	-36.22
5550.00	-63.01	H	-52.69	4.82	13.15	-44.36	-13.00	-31.36
Middle Channel 661 (1880.00MHz)								
3760.00	-57.95	V	-54.74	3.73	12.72	-45.75	-13.00	-32.75
5640.00	-64.94	V	-54.07	4.93	13.14	-45.86	-13.00	-32.86
3760.00	-57.91	H	-54.63	3.73	12.72	-45.64	-13.00	-32.64
5640.00	-64.43	H	-56.02	4.93	13.14	-47.81	-13.00	-34.81
High Channel 810 (1909.80MHz)								
3818.00	-58.73	V	-55.01	4.02	12.73	-46.30	-13.00	-33.30
5727.00	-65.48	V	-56.48	4.87	13.11	-48.24	-13.00	-35.24
3818.00	-58.50	H	-54.63	4.02	12.73	-45.92	-13.00	-32.92
5727.00	-64.71	H	-53.36	4.87	13.11	-45.12	-13.00	-32.12

Product	Wireless Module		
Test Item	Radiated Spurious Emission		
Test Mode	Mode 3: EDGE S850 Link		
Date of Test	2014/11/21	Test Site	AC5

Frequency (MHz)	SA Reading (dBm)	Ant.Pol. (H/V)	SG Reading (dBm)	Cable Loss (dB)	Gain (dBi)	EIRP (dBm)	Limit (dBm)	Margin (dB)
Low Channel 128 (824.20MHz)								
1646.00	-56.79	V	-58.91	2.50	9.75	-51.66	-13.00	-38.66
2470.50	-63.23	V	-60.42	3.12	10.48	-53.06	-13.00	-40.06
1646.00	-56.60	H	-59.24	2.50	9.75	-51.99	-13.00	-38.99
2470.50	-62.71	H	-59.99	3.12	10.48	-52.63	-13.00	-39.63
Middle Channel 189 (836.40MHz)								
1671.50	-56.64	V	-58.94	2.52	9.95	-51.51	-13.00	-38.51
2513.00	-62.69	V	-60.38	3.18	10.62	-52.94	-13.00	-39.94
1671.50	-58.11	H	-60.51	2.52	9.95	-53.08	-13.00	-40.08
2513.00	-62.70	H	-60.06	3.18	10.62	-52.62	-13.00	-39.62
High Channel 251 (848.80MHz)								
1697.00	-56.97	V	-59.36	2.54	10.06	-51.84	-13.00	-38.84
2547.00	-63.10	V	-60.83	3.14	10.68	-53.29	-13.00	-40.29
1697.00	-59.47	H	-61.47	2.54	10.06	-53.95	-13.00	-40.95
2547.00	-63.01	H	-59.98	3.14	10.68	-52.44	-13.00	-39.44

Product	Wireless Module		
Test Item	Radiated Spurious Emission		
Test Mode	Mode 4: EDGE 1900 Link		
Date of Test	2014/11/21	Test Site	AC5

Frequency (MHz)	SA Reading (dBm)	Ant.Pol. (H/V)	SG Reading (dBm)	Cable Loss (dB)	Gain (dBi)	EIRP (dBm)	Limit (dBm)	Margin (dB)
Low Channel 512 (1850.20MHz)								
3700.00	-64.90	V	-57.21	3.84	12.69	-48.36	-13.00	-35.36
5550.00	-65.18	V	-51.11	4.82	13.15	-42.78	-13.00	-29.78
3700.00	-62.42	H	-59.39	3.84	12.69	-50.54	-13.00	-37.54
5550.00	-64.17	H	-55.93	4.82	13.15	-47.60	-13.00	-34.60
Middle Channel 661 (1880.00MHz)								
3760.00	-62.07	V	-58.87	3.73	12.72	-49.88	-13.00	-36.88
5640.00	-64.61	V	-53.73	4.93	13.14	-45.52	-13.00	-32.52
3760.00	-64.02	H	-60.38	3.73	12.72	-51.39	-13.00	-38.39
5640.00	-65.10	H	-54.46	4.93	13.14	-46.25	-13.00	-33.25
High Channel 810 (1909.80MHz)								
3818.00	-64.50	V	-60.06	4.02	12.73	-51.35	-13.00	-38.35
5727.00	-64.94	V	-52.38	4.87	13.11	-44.14	-13.00	-31.14
3818.00	-60.40	H	-56.52	4.02	12.73	-47.81	-13.00	-34.81
5727.00	-64.82	H	-54.94	4.87	13.11	-46.70	-13.00	-33.70

Product	Wireless Module		
Test Item	Radiated Spurious Emission		
Test Mode	Mode5: WCDMA Band II Link		
Date of Test	2014/11/21	Test Site	AC5

Frequency (MHz)	SA Reading (dBm)	Ant.Pol. (H/V)	SG Reading (dBm)	Cable Loss (dB)	Gain (dBi)	EIRP (dBm)	Limit (dBm)	Margin (dB)
Low Channel 9262 (1852.40MHz)								
3704.80	-53.88	V	-49.48	4.78	12.69	-41.57	-13.00	-28.57
5557.20	-48.69	V	-40.18	4.82	13.15	-31.85	-13.00	-18.85
3704.80	-53.35	H	-49.04	4.78	12.69	-41.13	-13.00	-28.13
5557.20	-47.60	H	-39.72	4.82	13.15	-31.39	-13.00	-18.39
Middle Channel 9400 (1880.00MHz)								
3760.00	-54.01	V	-49.49	5.03	12.72	-41.80	-13.00	-28.80
5640.00	-57.14	V	-48.18	5.93	13.14	-40.97	-13.00	-27.97
3760.00	-50.40	H	-45.80	5.03	12.72	-38.11	-13.00	-25.11
5640.00	-55.30	H	-46.70	5.93	13.14	-39.49	-13.00	-26.49
High Channel 9538 (1907.60MHz)								
3815.20	-53.16	V	-48.42	5.03	12.73	-40.72	-13.00	-27.72
5722.80	-57.63	V	-49.01	4.87	13.11	-40.77	-13.00	-27.77
3815.20	-54.43	H	-49.52	5.03	12.73	-41.82	-13.00	-28.82
5722.80	-61.61	H	-53.40	4.87	13.11	-45.16	-13.00	-32.16

Product	Wireless Module		
Test Item	Radiated Spurious Emission		
Test Mode	Mode 6: WCDMA Band V Traffic		
Date of Test	2014/11/21	Test Site	AC5

Frequency (MHz)	SA Reading (dBm)	Ant.Pol. (H/V)	SG Reading (dBm)	Cable Loss (dB)	Gain (dBi)	EIRP (dBm)	Limit (dBm)	Margin (dB)
Low Channel 4132 (826.40MHz)								
1654.50	-56.81	V	-58.56	3.28	9.75	-52.09	-13.00	-39.09
2479.20	-62.09	V	-58.58	4.10	10.48	-52.20	-13.00	-39.20
1654.50	-52.47	H	-54.20	3.28	9.75	-47.73	-13.00	-34.73
2479.00	-59.93	H	-57.56	4.10	10.48	-51.18	-13.00	-38.18
Middle Channel 4182 (836.40MHz)								
1671.50	-52.32	V	-54.19	3.32	9.95	-47.56	-13.00	-34.56
2513.00	-58.73	V	-56.62	4.31	10.62	-50.31	-13.00	-37.31
1671.50	-46.78	H	-48.43	3.32	9.95	-41.80	-13.00	-28.80
2513.00	-59.76	H	-57.67	4.31	10.62	-51.36	-13.00	-38.36
High Channel 4233 (846.60MHz)								
1697.00	-52.45	V	-54.38	3.35	10.06	-47.67	-13.00	-34.67
2539.80	-58.52	V	-56.63	3.91	10.33	-50.21	-13.00	-37.21
1697.00	-49.84	H	-50.84	4.19	10.68	-44.35	-13.00	-31.35
2538.50	-60.54	H	-57.77	4.33	10.79	-51.31	-13.00	-38.31

8. Frequency Stability Under Temperature & Voltage Variations

8.1. Test Equipment

Frequency Stability Under Temperature & Voltage Variations / AC-6

Instrument	Manufacturer	Type No.	Serial No	Cali. Due Date
PSA Series Spectrum Analyzer	Agilent	E4440A	MY49420184	2015.03.28
Radio Communication Tester	R&S	CMU 200	117088	2015.03.28
Dual Directional Coupler	Agilent	778D	20160	2015.03.28
10dB Coaxial Coupler	Agilent	87300C	MY44300299	2015.03.28
DC Power Supply	IDRC	CD-035-020PR	977272	2015.03.28
Temperature & Humidity Chamber	Gaoyu	TH-1P-B	WIT-05121302	2015.01.07
Temperature/Humidity Meter	Zhicheng	ZC1-2	AC6-TH	2015.01.08

8.2. Test Setup

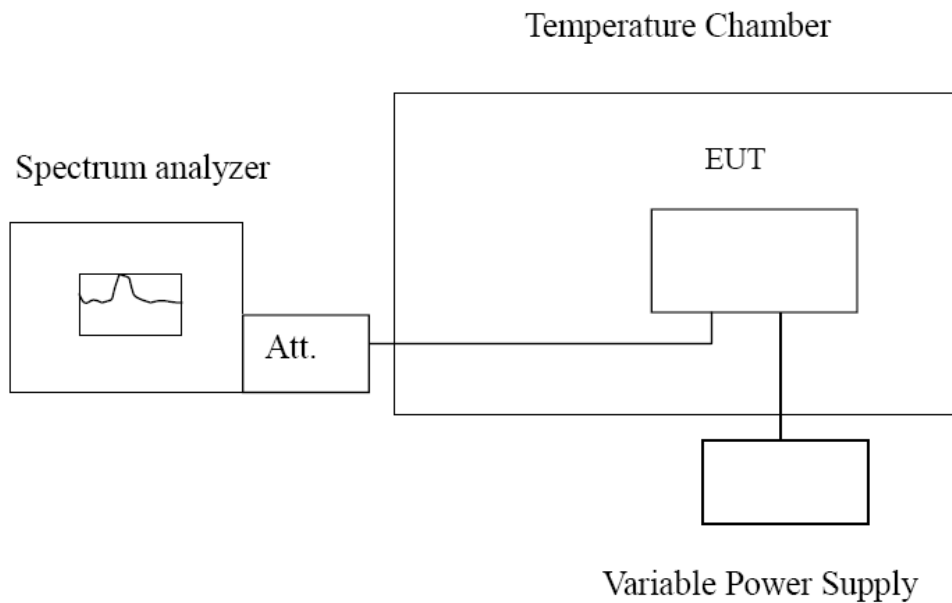

8.3. Limit

The frequency stability shall be sufficient to ensure that the fundamental emission stays within the authorized frequency block.

Limit	$< \pm 2.5 \text{ ppm}$
-------	-------------------------

8.4. Test Procedure

Frequency Stability Under Temperature Variations:

The equipment under test was connected to an external AC or DC power supply and input rated voltage. RF output was connected to a frequency counter or spectrum analyzer via feed through attenuators. The EUT was placed inside the temperature chamber. Set the spectrum analyzer RBW low enough to obtain the desired frequency resolution and measure EUT 20°C operating frequency as reference frequency. Turn EUT off and set the chamber temperature to -30°C. After the temperature stabilized for approximately 30 minutes recorded the frequency. Repeat step measure with 10°C increased per stage until the highest temperature of +50°C reached.

Frequency Stability Under Voltage Variations:

Set chamber temperature to 20°C. Use a variable AC power supply / DC power source to power the EUT and set the voltage to rated voltage. Set the spectrum analyzer RBW low enough to obtain the desired frequency resolution and recorded the frequency.

Reduce the input voltage to specify extreme voltage variation ($\pm 15\%$) and endpoint, record the maximum frequency change.

8.5. Uncertainty

The measurement uncertainty is defined as $\pm 10 \text{ Hz}$.

8.6. Test Result

Product	Wireless Module		
Test Item	Frequency Stability Under Temperature & Voltage Variations		
Test Mode	Mode 1: GSM 850 Link		
Date of Test	2014/11/20	Test Site	AC6

Frequency Stability under Temperature

Temperature Interval (°C)	Test Frequency (MHz)	Deviation (Hz)	Limit (Hz)
-30	836.40	54	± 2091
-20	836.40	-24	± 2091
-10	836.40	36	± 2091
0	836.40	25	± 2091
10	836.40	41	± 2091
20	836.40	-33	± 2091
30	836.40	-25	± 2091
40	836.40	47	± 2091
50	836.40	-69	± 2091

Frequency Stability under Voltage

DC Voltage (V)	Test Frequency (MHz)	Deviation (Hz)	Limit (Hz)
3.2	836.40	-25	± 2091
3.3	836.40	44	± 2091
3.6	836.40	-29	± 2091

Product	Wireless Module		
Test Item	Frequency Stability Under Temperature & Voltage Variations		
Test Mode	Mode 2: GSM1900 Link		
Date of Test	2014/11/20	Test Site	AC6

Frequency Stability under Temperature

Temperature Interval (°C)	Test Frequency (MHz)	Deviation (Hz)	Limit (Hz)
-30	1880.00	-54	± 4700
-20	1880.00	49	± 4700
-10	1880.00	24	± 4700
0	1880.00	28	± 4700
10	1880.00	36	± 4700
20	1880.00	-49	± 4700
30	1880.00	52	± 4700
40	1880.00	-33	± 4700
50	1880.00	42	± 4700

Frequency Stability under Voltage

DC Voltage (V)	Test Frequency (MHz)	Deviation (Hz)	Limit (Hz)
3.2	1880.00	55	± 4700
3.3	1880.00	-42	± 4700
3.6	1880.00	-58	± 4700

Product	Wireless Module		
Test Item	Frequency Stability Under Temperature & Voltage Variations		
Test Mode	Mode 3: EDGE 850 Link		
Date of Test	2014/11/20	Test Site	TR7

Frequency Stability under Temperature

Temperature Interval (°C)	Test Frequency (MHz)	Deviation (Hz)	Limit (Hz)
-30	836.40	-50	± 2091
-20	836.40	22	± 2091
-10	836.40	26	± 2091
0	836.40	55	± 2091
10	836.40	-41	± 2091
20	836.40	-25	± 2091
30	836.40	-9	± 2091
40	836.40	-23	± 2091
50	836.40	-44	± 2091

Frequency Stability under Voltage

DC Voltage (V)	Test Frequency (MHz)	Deviation (Hz)	Limit (Hz)
3.2	836.40	21	± 2091
3.3	836.40	-28	± 2091
3.6	836.40	35	± 2091

Product	Wireless Module		
Test Item	Frequency Stability Under Temperature & Voltage Variations		
Test Mode	Mode 4: EDGE1900 Link		
Date of Test	2014/11/20	Test Site	TR7

Frequency Stability under Temperature

Temperature Interval (°C)	Test Frequency (MHz)	Deviation (Hz)	Limit (Hz)
-30	1880.00	-21	± 4700
-20	1880.00	-30	± 4700
-10	1880.00	35	± 4700
0	1880.00	42	± 4700
10	1880.00	-55	± 4700
20	1880.00	-20	± 4700
30	1880.00	67	± 4700
40	1880.00	22	± 4700
50	1880.00	-39	± 4700

Frequency Stability under Voltage

DC Voltage (V)	Test Frequency (MHz)	Deviation (Hz)	Limit (Hz)
3.2	1880.00	-42	± 4700
3.3	1880.00	35	± 4700
3.6	1880.00	-46	± 4700

Product	Wireless Module		
Test Item	Frequency Stability Under Temperature & Voltage Variations		
Test Mode	Mode 5: WCDMA Band II Link		
Date of Test	2014/11/20	Test Site	TR7

Frequency Stability under Temperature

Temperature Interval (°C)	Test Frequency (MHz)	Deviation (Hz)	Limit (Hz)
-30	1880.00	18	± 4700
-20	1880.00	22	± 4700
-10	1880.00	17	± 4700
0	1880.00	26	± 4700
10	1880.00	20	± 4700
20	1880.00	27	± 4700
30	1880.00	-12	± 4700
40	1880.00	-20	± 4700
50	1880.00	-15	± 4700

Frequency Stability under Voltage

DC Voltage (V)	Test Frequency (MHz)	Deviation (Hz)	Limit (Hz)
3.2	1880.00	11	± 4700
3.3	1880.00	-20	± 4700
3.6	1880.00	-13	± 4700

Product	Wireless Module		
Test Item	Frequency Stability Under Temperature & Voltage Variations		
Test Mode	Mode 6: WCDMA Band V Link		
Date of Test	2014/11/20	Test Site	TR7

Frequency Stability under Temperature

Temperature Interval (°C)	Test Frequency (MHz)	Deviation (Hz)	Limit (Hz)
-30	836.40	10	± 2091
-20	836.40	-20	± 2091
-10	836.40	10	± 2091
0	836.40	-9	± 2091
10	836.40	14	± 2091
20	836.40	27	± 2091
30	836.40	39	± 2091
40	836.40	42	± 2091
50	836.40	-21	± 2091

Frequency Stability under Voltage

DC Voltage (V)	Test Frequency (MHz)	Deviation (Hz)	Limit (Hz)
3.2	836.40	-24	± 2091
3.3	836.40	36	± 2091
3.6	836.40	-21	± 2091

————— The End —————