



**FCC 47 CFR PART 22 SUBPART H AND PART 24 SUBPART E
&
INDUSTRY CANADA RSS-132 & RSS-133**

TEST REPORT

For

Module

Trade Name: AirPrime

Model: HL8549, HL8549-G

Issued to

**Sierra Wireless Inc.
13811 Wireless Way
Richmond, BC, V6V 3A4
Canada**

Issued by

**Compliance Certification Services Inc.
No.11, Wugong 6th Rd., Wugu Dist.,
New Taipei City 24891, Taiwan. (R.O.C.)
<http://www.ccsrf.com>
service@ccsrf.com
Issued Date: December 15, 2014**



Note: This report shall not be reproduced except in full, without the written approval of Compliance Certification Services Inc. This document may be altered or revised by Compliance Certification Services Inc. personnel only, and shall be noted in the revision section of the document.



Revision History

Rev.	Issue Date	Revisions	Effect Page	Revised By
00	December 15, 2014	Initial Issue	ALL	Doris Chu



TABLE OF CONTENTS

1. TEST RESULT CERTIFICATION.....	4
2. EUT DESCRIPTION	5
3. TEST METHODOLOGY	7
3.1 EUT CONFIGURATION	7
3.2 EUT EXERCISE	7
3.3 GENERAL TEST PROCEDURES	7
3.4 DESCRIPTION OF TEST MODES	8
4. INSTRUMENT CALIBRATION.....	9
4.1 MEASURING INSTRUMENT CALIBRATION	9
4.2 MEASUREMENT EQUIPMENT USED	9
4.3 MEASUREMENT UNCERTAINTY	10
5. FACILITIES AND ACCREDITATIONS	11
5.1 FACILITIES	11
5.2 EQUIPMENT	11
5.3 LABORATORY ACCREDITATIONS AND LISTING	11
5.4 TABLE OF ACCREDITATIONS AND LISTINGS	12
6. SETUP OF EQUIPMENT UNDER TEST	13
6.1 SETUP CONFIGURATION OF EUT	13
6.2 SUPPORT EQUIPMENT.....	13
7. FCC PART 22 & 24 REQUIREMENTS & INDUSTRY CANADA RSS-132 & RSS-133 ...	14
7.1 99% BANDWIDTH	14
7.2 PEAK POWER.....	41
7.3 AVERAGE POWER.....	44
7.4 ERP & EIRP MEASUREMENT	47
7.5 OUT OF BAND EMISSION AT ANTENNA TERMINALS	53
7.6 FIELD STRENGTH OF SPURIOUS RADIATION MEASUREMENT	94
7.7 FREQUENCY STABILITY V.S. TEMPERATURE MEASUREMENT	168
7.8 FREQUENCY STABILITY V.S. VOLTAGE MEASUREMENT	175
APPENDIX II PHOTOGRAPHS OF TEST SETUP	182
APPENDIX 1 - PHOTOGRAPHS OF EUT	



1. TEST RESULT CERTIFICATION

Applicant: **Sierra Wireless Inc.**
13811 Wireless Way
Richmond, BC, V6V 3A4
Canada

Manufacturer: **Sierra Wireless Inc.**
13811 Wireless Way
Richmond, BC, V6V 3A4
Canada

Equipment under Test: Module

Trade Name: AirPrime

Model Number: HL8549, HL8549-G

Date of Test: December 10 2014

APPLICABLE STANDARDS	
STANDARD	TEST RESULT
FCC 47 CFR PART 22 SUBPART H AND PART 24 SUBPART E & IC RSS-132 Issue 3: January, 2013 and IC RSS-133 Issue 6: January, 2013	No non-compliance noted

We hereby certify that:

The above equipment was tested by Compliance Certification Services Inc. The test data, data evaluation, test procedures, and equipment configurations shown in this report were made in accordance with the procedures given in TIA/EIA-603-C and the energy emitted by the sample EUT tested as described in this report is in compliance with radiated emission limits of FCC Rule FCC PART 22 Subpart H, PART 24 Subpart E, IC RSS-132 Issue 3 and IC RSS-133 Issue 6.

The test results of this report relate only to the tested sample identified in this report.

Approved by:

Reviewed by:

Miller Lee
Section Manager
Compliance Certification Services Inc.

Angel Cheng
Section Manager
Compliance Certification Services Inc.



2. EUT DESCRIPTION

Product	Module	
Trade Name	AirPrime	
Model Number	HL8549, HL8549-G	
Model Discrepancy	Model Number	Difference
	HL8549	does not support GPS Function
	HL8549-G	supports GPS Function
Received Date	December 5, 2014	
Power Supply	Power form host device	
Frequency Range	GSM / GPRS / EDGE: 850: 824.2 ~ 848.8 MHz GSM / GPRS / EDGE: 1900: 1850.2 ~ 1909.8 MHz WCDMA / HSDPA / HSUPA Band II: 1852.4 ~ 1907.6 MHz WCDMA / HSDPA / HSUPA Band V: 826.4 ~ 846.6MHz	
Cellular Phone Protocol	GSM: GMSK GPRS: GMSK EDGE: 8PSK WCDMA: Quadrature Phase Shift Keying (QPSK) with Root-raised cosine pulse shaping filters (roll off = 0.22)	
Antenna Gain	GSM / GPRS / EDGE 850MHz: 1dBi GSM / GPRS / EDGE: 1900MHz: 2dBi WCDMA Band II: 2dBi WCDMA Band V: 1dBi	
Antenna Type	Dipole Antenna	

Remark: The sample selected for test was engineering sample that approximated to production product and was provided by manufacturer.



Mode	ERP Power (dBm)	Type of Emission
GSM 850MHz	27.29	240GXW
GPRS 850MHz	25.23	245GXW
EDGE 850MHz	25.24	243G7W
WCDMA Band V	21.37	4M06F9W
WCDMA HSDPA Band V	21.51	4M05F9W
WCDMA HSUPA Band V	21.37	4M06F9W

Mode	ERP Power (dBm)	Type of Emission
GSM 1900MHz	29.57	248GXW
GPRS 1900MHz	28.68	247GXW
EDGE 1900MHz	28.64	245G7W
WCDMA Band II	25.38	4M06F9W
WCDMA HSDPA Band II	25.83	4M06F9W
WCDMA HSUPA Band II	26.03	4M06F9W



3. TEST METHODOLOGY

Both conducted and radiated testing were performed according to the procedures document on chapter 13 of ANSI C63.4: 2009, TIA/EIA-603-C: 2004 and FCC CFR 47, Part 2 and Part 22 Subpart H & Part 24 Subpart E.

The tests documented in this report were performed in accordance with IC RSS-132, SPSR503, RSS-133, SPSR510 and ANSI C63.4 and TIA/EIA-603-C.

3.1 EUT CONFIGURATION

The EUT configuration for testing is installed on RF field strength measurement to meet the Commissions requirement and operating in a manner that intends to maximize its emission characteristics in a continuous normal application.

3.2 EUT EXERCISE

The EUT was operated in the engineering mode to fix the TX frequency that was for the purpose of the measurements.

3.3 GENERAL TEST PROCEDURES

Conducted Emissions

The EUT is placed on the turntable, which is 0.8 m above ground plane. According to the requirements in Section 13.1.4.1 of ANSI C63.4: 2009. Conducted emissions from the EUT measured in the frequency range between 0.15 MHz and 30MHz using CISPR Quasi-peak and average detector modes.

Radiated Emissions

The EUT is placed on a turn table, which is 0.8 m above ground plane. The turntable shall rotate 360 degrees to determine the position of maximum emission level. EUT is set 3m away from the receiving antenna, which varied from 1m to 4m to find out the highest emission. And also, each emission was to be maximized by changing the polarization of receiving antenna both horizontal and vertical. In order to find out the maximum emissions, exploratory radiated emission measurements were made according to the requirements in Section 13.1.4.1 of ANSI C63.4: 2009.



3.4 DESCRIPTION OF TEST MODES

The EUT (model: HL8549-G) had been tested under operating condition.

EUT staying in continuous transmitting mode was programmed.

After verification, all tests carried out are with the worst-case test modes as shown below except radiated spurious emission below 1GHz which worst case was in normal link mode.

GSM / GPRS / EDGE 850MHz:

Channel Low (CH128), Channel Mid (CH190) and Channel High (CH251) were chosen for full testing.

GSM / GPRS / EDGE 1900MHz:

Channel Low (CH512), Channel Mid (CH661) and Channel High (CH810) were chosen for full testing.

WCDMA Band II:

Channel Low (CH9262), Channel Mid (CH9400) and Channel High (CH9538) were chosen for full testing.

WCDMA Band V:

Channel Low (CH4132), Channel Mid (CH4182) and Channel High (CH4233) were chosen for full testing.

WCDMA / HSDPA Band II:

Channel Low (CH9262), Channel Mid (CH9400) and Channel High (CH9538) were chosen for full testing.

WCDMA / HSDPA Band V:

Channel Low (CH4132), Channel Mid (CH4182) and Channel High (CH4233) were chosen for full testing.

WCDMA / HSUPA Band II:

Channel Low (CH9262), Channel Mid (CH9400) and Channel High (CH9538) were chosen for full testing.

WCDMA / HSDPA Band V:

Channel Low (CH4132), Channel Mid (CH4182) and Channel High (CH4233) were chosen for full testing.



4. INSTRUMENT CALIBRATION

4.1 MEASURING INSTRUMENT CALIBRATION

The measuring equipment, which was utilized in performing the tests documented herein, has been calibrated in accordance with the manufacturer's recommendations for utilizing calibration equipment, which is traceable to recognized national standards.

4.2 MEASUREMENT EQUIPMENT USED

Equipment Used for Emissions Measurement

Remark: Each piece of equipment is scheduled for calibration once a year and Loop Antenna is scheduled for calibration once three years.

Conducted Emissions Test Site				
Name of Equipment	Manufacturer	Model	Serial Number	Calibration Due
Spectrum Analyzer	Agilent	E4446A	MY43360131	03/19/2015
Power Meter	Anritsu	ML2495A	1012009	06/03/2015
Power Sensor	Anritsu	MA2411A	0917072	06/03/2015

3M Semi Anechoic Chamber				
Name of Equipment	Manufacturer	Model	Serial Number	Calibration Due
Spectrum Analyzer	Agilent	E4446A	US42510268	11/04/2015
EMI Test Receiver	R&S	ESCI	100064	02/16/2015
Pre-Amplifier	Mini-Circuits	ZFL-1000LN	SF350700823	01/11/2015
Bilog Antenna	Sunol Sciences	JB3	A030105	02/16/2015
Bilog Antenna	Sunol Sciences	JB3	A030205	09/30/2015
Horn Antenna	EMCO	3117	00055165	02/16/2015
Horn Antenna	EMCO	3117	00055167	01/27/2015
Horn Antenna	EMCO	3116	26370	01/06/2015
Loop Antenna	EMCO	6502	8905/2356	06/11/2015
Turn Table	CCS	CC-T-1F	N/A	N.C.R
Antenna Tower	CCS	CC-A-1F	N/A	N.C.R
Controller	CCS	CC-C-1F	N/A	N.C.R
Site NSA	CCS	N/A	N/A	12/21/2014
Test S/W	EZ-EMC (CCS-3A1RE)			



4.3 MEASUREMENT UNCERTAINTY

PARAMETER	UNCERTAINTY
3M Semi Anechoic Chamber / 30M~200M	+/- 4.0138
3M Semi Anechoic Chamber / 200M~1000M	+/- 3.9483
3M Semi Anechoic Chamber / 1G~8G	+/- 2.5975
3M Semi Anechoic Chamber / 8G~18G	+/- 2.6112
3M Semi Anechoic Chamber / 18G~26G	+/- 2.7389
3M Semi Anechoic Chamber / 26G~40G	+/- 2.9683

Remark: This uncertainty represents an expanded uncertainty expressed at approximately the 95% confidence level using a coverage factor of $k=2$.



5. FACILITIES AND ACCREDITATIONS

5.1 FACILITIES

All measurement facilities used to collect the measurement data are located at

No.199, Chunghsen Road, Hsintien City, Taipei Hsien, Taiwan, R.O.C.
Tel: 886-2-2217-0894 / Fax: 886-2-2217-1029

No.11, Wugong 6th Rd., Wugu Dist., New Taipei City 24891, Taiwan. (R.O.C.)
Tel: 886-2-2299-9720 / Fax: 886-2-2298-4045

No.81-1, Lane 210, Bade 2nd Rd., Lujhu Township, Taoyuan County 33841, TAIWAN,
R.O.C.
Tel: 886-3-324-0332 / Fax: 886-3-324-5235

The sites are constructed in conformance with the requirements of ANSI C63.7, ANSI C63.4: 2009 and CISPR Publication 22.

5.2 EQUIPMENT

Radiated emissions are measured with one or more of the following types of linearly polarized antennas: tuned dipole, biconical, log periodic, bi-log, and/or ridged waveguide, horn. Spectrum analyzers with pre-selectors and quasi-peak detectors are used to perform radiated measurements.

Conducted emissions are measured with Line Impedance Stabilization Networks and EMI Test Receivers.

Calibrated wideband preamplifiers, coaxial cables, and coaxial attenuators are also used for making measurements.



All receiving equipment conforms to CISPR Publication 16-1, "Radio Interference Measuring Apparatus and Measurement Methods."

5.3 LABORATORY ACCREDITATIONS AND LISTING

The test facilities used to perform radiated and conducted emissions tests are accredited by American Association for Laboratory Accreditation Program for the specific scope accreditation under Lab Code: 0824-01 to perform Electromagnetic Interference tests according to FCC Part 15 and CISPR 22 requirements. In addition, the test facilities are listed with Industry Canada, Certification and Engineering Bureau, IC 2324G-1 for 3M Semi Anechoic Chamber A, 2324G-2 for 3M Semi Anechoic Chamber B.



5.4 TABLE OF ACCREDITATIONS AND LISTINGS

Country	Agency	Scope of Accreditation	Logo
USA	FCC	3M Semi Anechoic Chamber (FCC MRA: TW1039) to perform FCC Part 15 measurements	 FCC MRA: TW1039
Taiwan	TAF	LP0002, RTTE01, FCC Method-47 CFR Part 15 Subpart C, D, E, RSS-210, RSS-310 IDA TS SRD, AS/NZS 4268, AS/NZS 4771, TS 12.1 & 12.2, ETSI EN 300 440-1, ETSI EN 300 440-2, ETSI EN 300 328, ETSI EN 300 220-1, ETSI EN 300 220-2, ETSI EN 301 893, ETSI EN 301 489-1/3/7/17 FCC OET Bulletin 65 + Supplement C, EN 50360, EN 50361, EN 50371, RSS 102, EN 50383, EN 50385, EN 50392, IEC 62209, CNS 14958-1, CNS 14959 FCC Method -47 CFR Part 15 Subpart B IEC / EN 61000-3-2, IEC / EN 61000-3-3, IEC / EN 61000-4-2/3/4/5/6/8/11	
Canada	Industry Canada	3M Semi Anechoic Chamber (IC 2324G-1 / IC 2324G-2) to perform	 IC 2324G-1 IC 2324G-2

** No part of this report may be used to claim or imply product endorsement by A2LA or any agency of the US Government.*



6. SETUP OF EQUIPMENT UNDER TEST

6.1 SETUP CONFIGURATION OF EUT

See test photographs attached in Appendix II for the actual connections between EUT and support equipment.

6.2 SUPPORT EQUIPMENT

No.	Device Type	Brand	Model	Series No.	FCC ID	Data Cable	Power Cord
	N/A						

Remark:

1. All the equipment/cables were placed in the worst-case configuration to maximize the emission during the test.
2. Grounding was established in accordance with the manufacturer's requirements and conditions for the intended use.



7. FCC PART 22 & 24 REQUIREMENTS & INDUSTRY CANADA RSS-132 & RSS-133

7.199% BANDWIDTH

LIMIT

None; for reporting purposes only.

Test Configuration

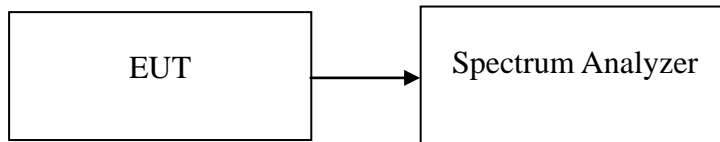

TEST PROCEDURE

The transmitter output is connected to the spectrum analyzer. The RBW is set to 1% to 3% of the 99 % bandwidth. The VBW is set to 3 times the RBW. The sweep time is coupled.

TEST RESULTS

No non-compliance noted.



Test Data

Test Mode	CH	Frequency (MHz)	99% Bandwidth (kHz)
GSM 850 (Class 12)	128	824.200	*240.1221
	190	836.400	239.0974
	251	848.800	239.3524
GPRS 850 (Class 12)	128	824.200	*245.7353
	190	836.400	240.1513
	251	848.800	244.8783
EDGE 850 (Class 12)	128	824.200	*243.9368
	190	836.570	242.2592
	251	848.800	243.0219
GSM 1900 (Class 12)	512	1850.210	245.9988
	661	1880.000	242.8548
	810	1909.823	*248.9209
GPRS 1900 (Class 12)	512	1850.210	245.3575
	661	1880.000	*247.0079
	810	1909.823	246.6571
EDGE 1900 (Class 12)	512	1850.173	241.5077
	661	1880.000	*245.9471
	810	1909.800	244.5472



Test Mode	CH	Frequency (MHz)	99% Bandwidth (MHz)
WCDMA (Band II)	9262	1852.40	4.0527
	9400	1880.00	4.0622
	9538	1907.60	*4.0629
WCDMA (Band V)	4132	826.40	4.0526
	4182	836.40	4.0600
	4233	846.60	*4.0621
WCDMA / HSDPA (BAND II)	9262	1852.40	4.0559
	9400	1880.00	4.0585
	9538	1907.60	*4.0638
WCDMA / HSDPA (BAND V)	4132	826.40	*4.0549
	4182	836.40	4.0541
	4233	846.60	4.0521
WCDMA / HSUPA (BAND II)	9262	1852.40	4.0552
	9400	1880.00	4.0550
	9538	1907.60	*4.0663
WCDMA / HSUPA (BAND V)	4132	826.40	4.0291
	4182	836.40	*4.0641
	4233	846.60	4.0499



Test Plot

GSM 850 (CH Low)

Agilent

R T

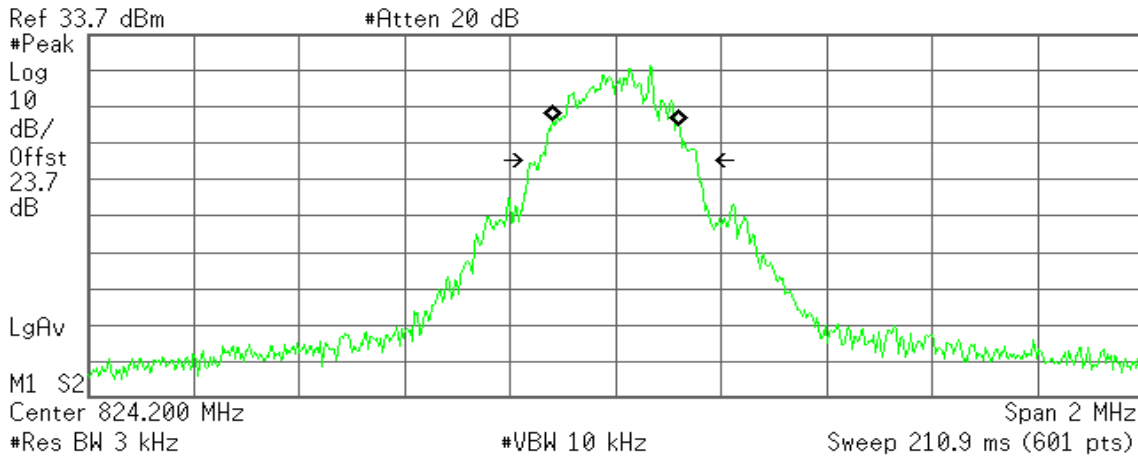

Occupied Bandwidth
240.1221 kHz

Occ BW % Pwr 99.00 %
x dB -26.00 dB

Transmit Freq Error -664.291 Hz
x dB Bandwidth 299.738 kHz

GSM 850 (CH Mid)

Agilent

R T

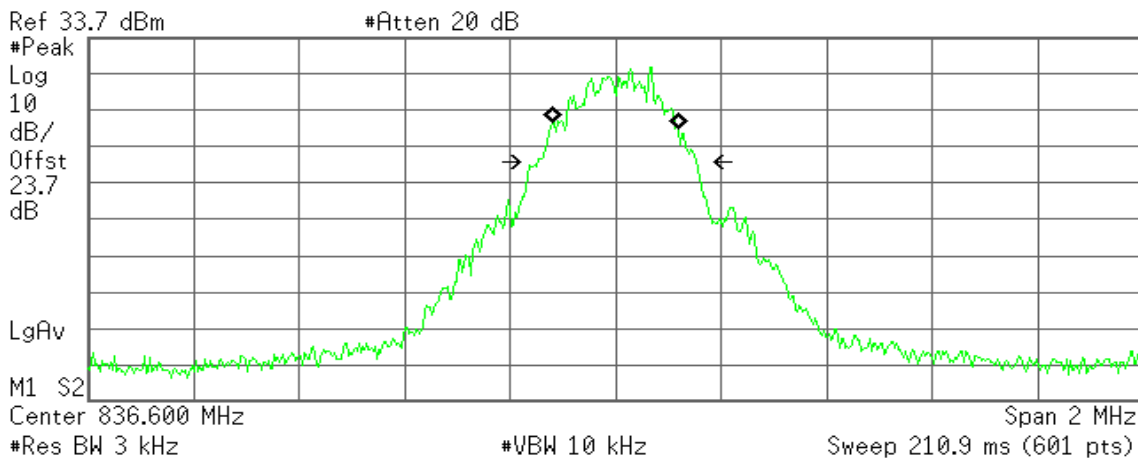

Occupied Bandwidth
239.0974 kHz

Occ BW % Pwr 99.00 %
x dB -26.00 dB

Transmit Freq Error -746.449 Hz
x dB Bandwidth 301.665 kHz



GSM 850 (CH High)

Agilent

R T

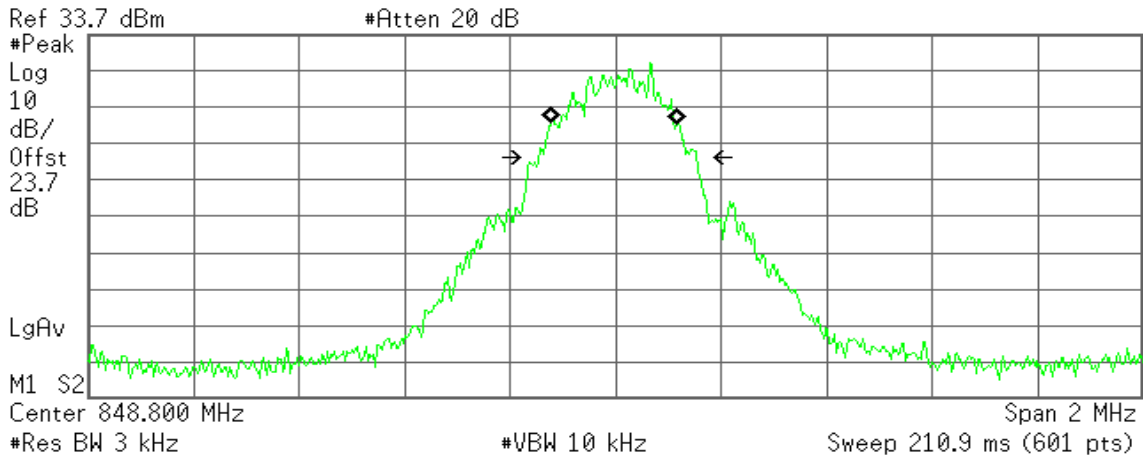

Occupied Bandwidth
239.3524 kHz

Occ BW % Pwr 99.00 %
x dB -26.00 dB

Transmit Freq Error -2.131 kHz
x dB Bandwidth 300.985 kHz



GPRS 850 (CH Low)

Agilent

R T

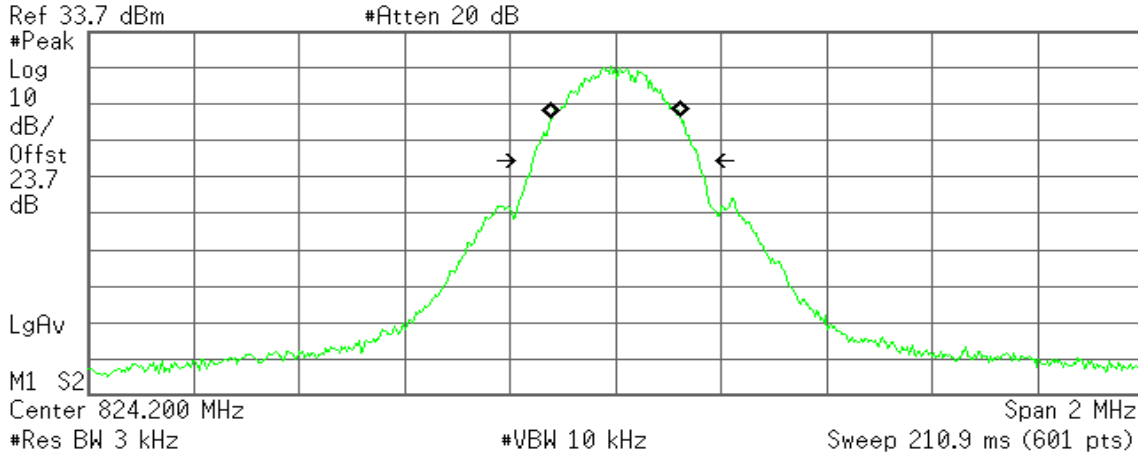

Occupied Bandwidth
245.7353 kHz

Occ BW % Pwr 99.00 %
x dB -26.00 dB

Transmit Freq Error 1.009 kHz
x dB Bandwidth 316.122 kHz

GPRS 850 (CH Mid)

Agilent

R T

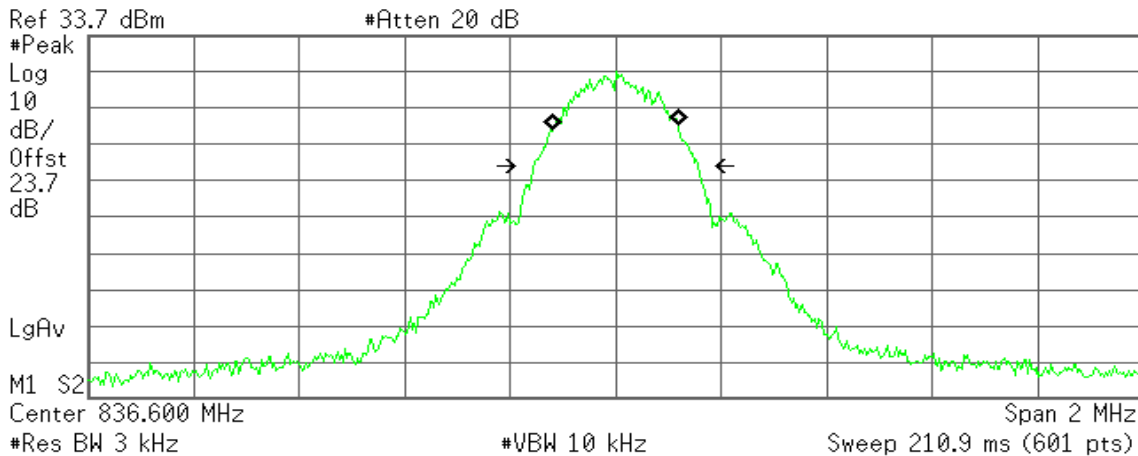

Occupied Bandwidth
240.1513 kHz

Occ BW % Pwr 99.00 %
x dB -26.00 dB

Transmit Freq Error -620.538 Hz
x dB Bandwidth 312.137 kHz



GPRS 850(CH High)

Agilent

R T

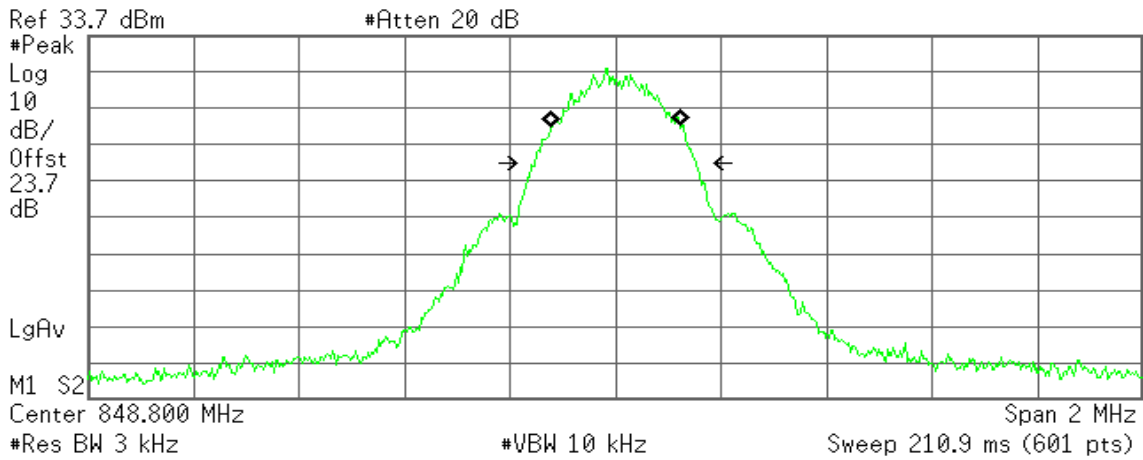

Occupied Bandwidth
244.8783 kHz

Occ BW % Pwr 99.00 %
x dB -26.00 dB

Transmit Freq Error -289.491 Hz
x dB Bandwidth 305.565 kHz



GSM 1900 (CH Low)

Agilent

R T

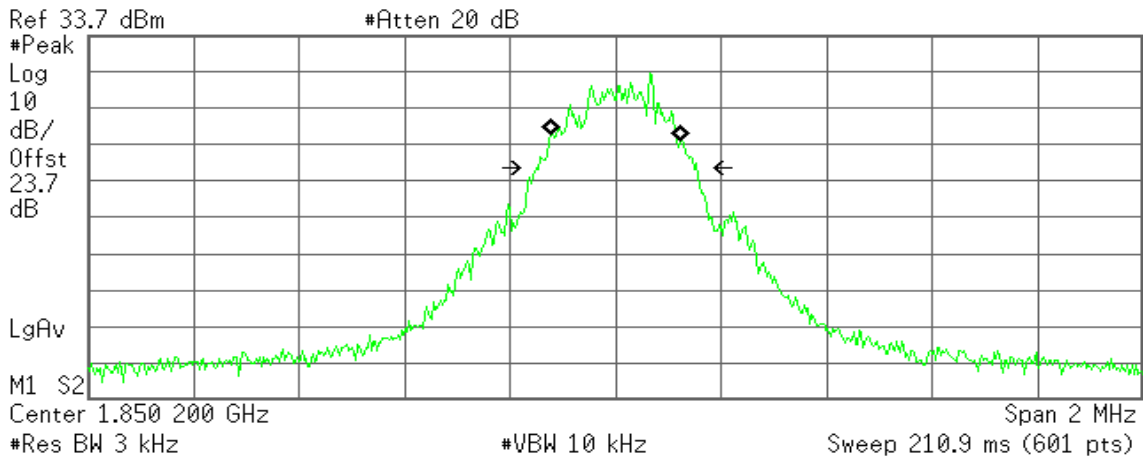

Occupied Bandwidth
245.9988 kHz

Occ BW % Pwr 99.00 %
x dB -26.00 dB

Transmit Freq Error 574.462 Hz
x dB Bandwidth 301.499 kHz

GSM 1900 (CH Mid)

Agilent

R T

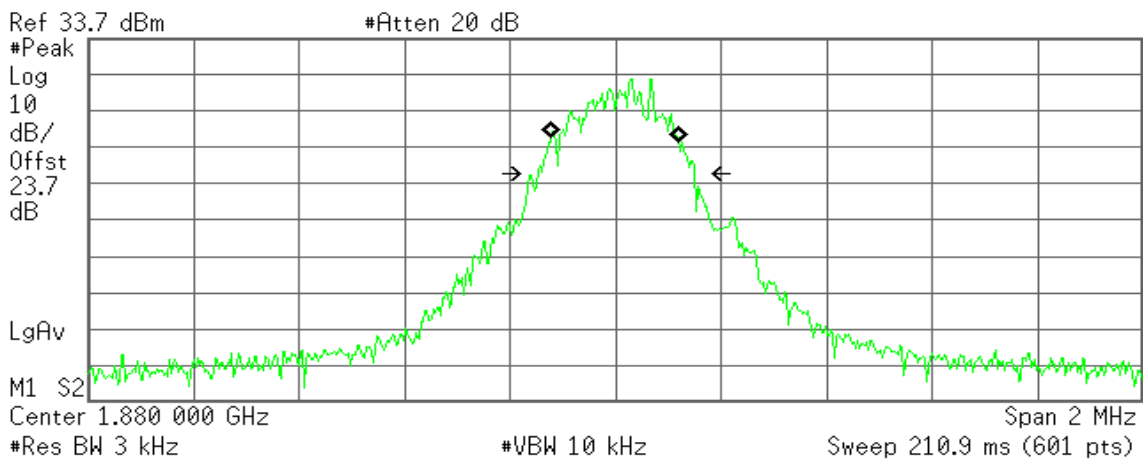

Occupied Bandwidth
242.8548 kHz

Occ BW % Pwr 99.00 %
x dB -26.00 dB

Transmit Freq Error -247.363 Hz
x dB Bandwidth 299.383 kHz



GSM 1900 (CH High)

Agilent

R T

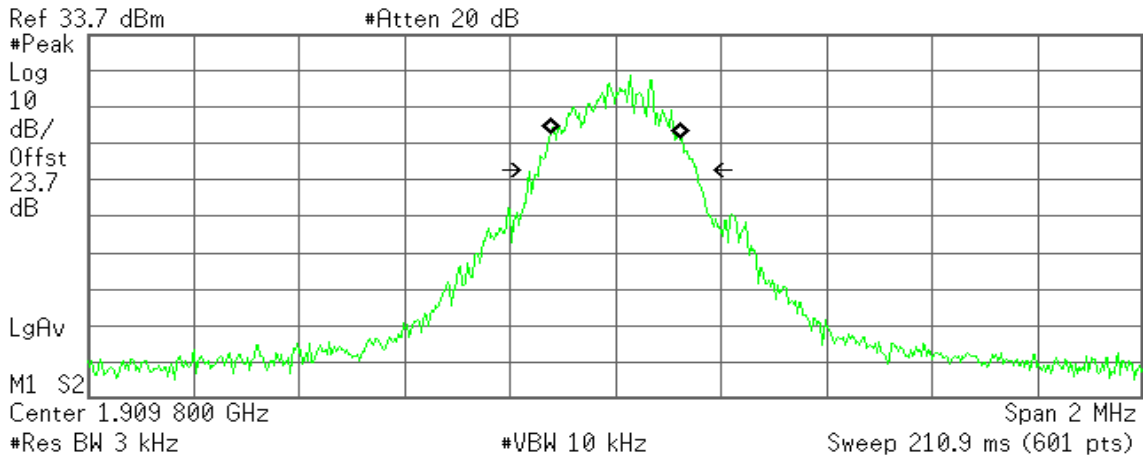

Occupied Bandwidth
248.9209 kHz

Occ BW % Pwr 99.00 %
x dB -26.00 dB

Transmit Freq Error 382.491 Hz
x dB Bandwidth 300.389 kHz



GPRS 1900 (CH Low)

Agilent

R T

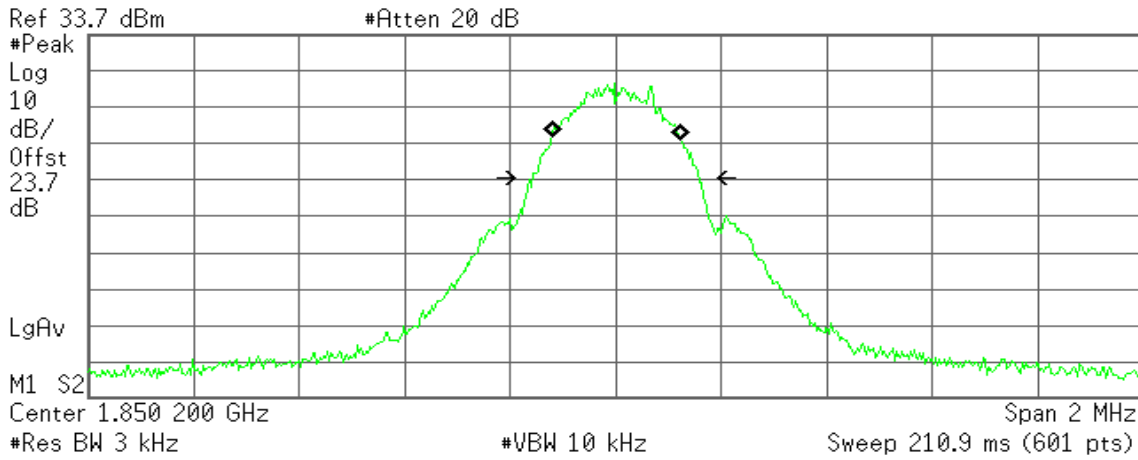

Occupied Bandwidth
245.3575 kHz

Occ BW % Pwr 99.00 %
x dB -26.00 dB

Transmit Freq Error 1.428 kHz
x dB Bandwidth 317.278 kHz

GPRS 1900 (CH Mid)

Agilent

R T

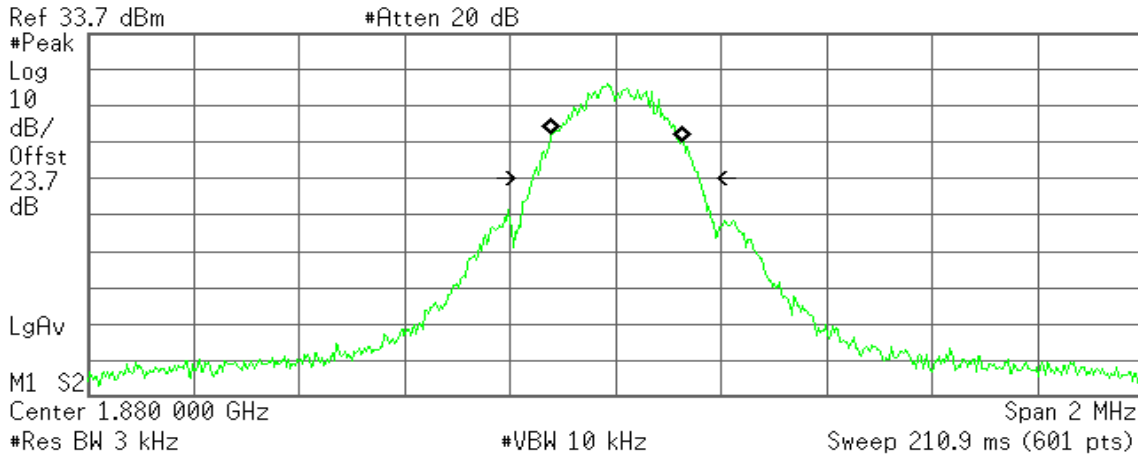

Occupied Bandwidth
247.0079 kHz

Occ BW % Pwr 99.00 %
x dB -26.00 dB

Transmit Freq Error 1.747 kHz
x dB Bandwidth 316.327 kHz



GPRS 1900 (CH High)

Agilent

R T

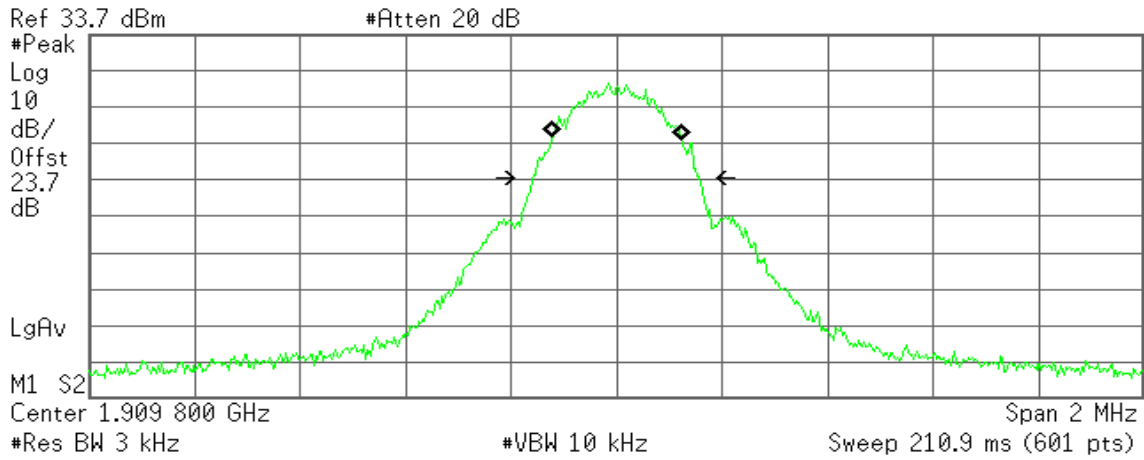

Occupied Bandwidth
246.6571 kHz

Occ BW % Pwr 99.00 %
x dB -26.00 dB

Transmit Freq Error 1.183 kHz
x dB Bandwidth 317.969 kHz



EDGE 850 (CH Low)

Agilent

R T

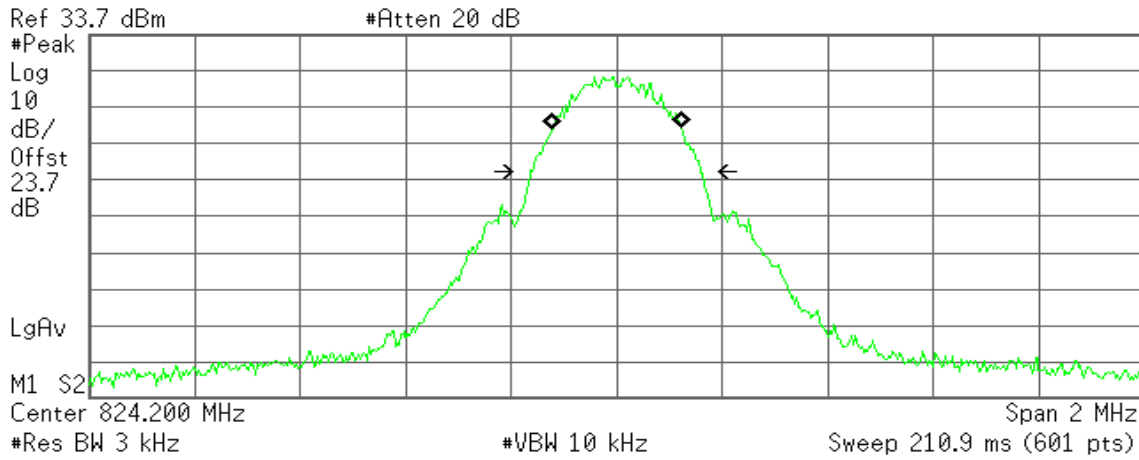

Occupied Bandwidth
243.9368 kHz

Occ BW % Pwr 99.00 %
x dB -26.00 dB

Transmit Freq Error 203.773 Hz
x dB Bandwidth 323.300 kHz

EDGE 850 (CH Mid)

Agilent

R T

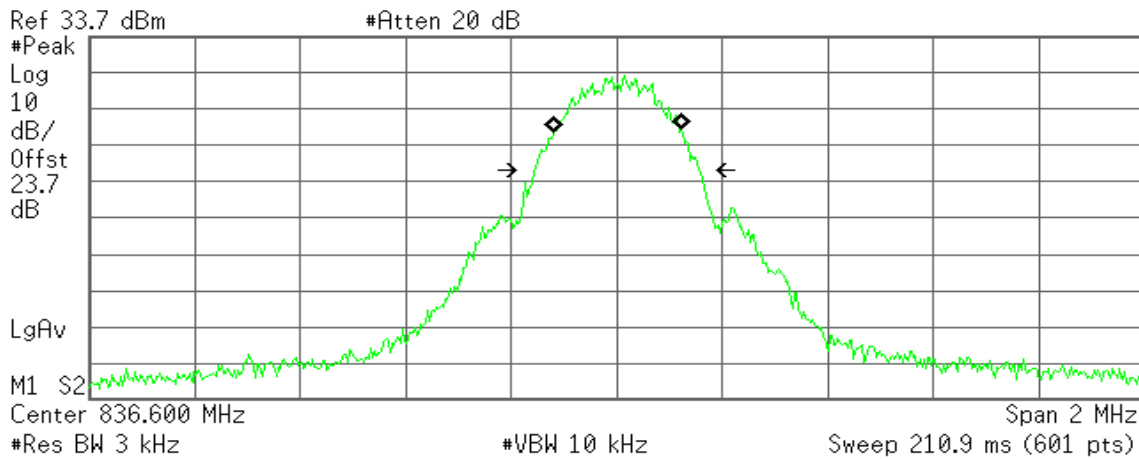

Occupied Bandwidth
242.2592 kHz

Occ BW % Pwr 99.00 %
x dB -26.00 dB

Transmit Freq Error 1.143 kHz
x dB Bandwidth 312.141 kHz



EDGE 850 (CH High)

Agilent

R T

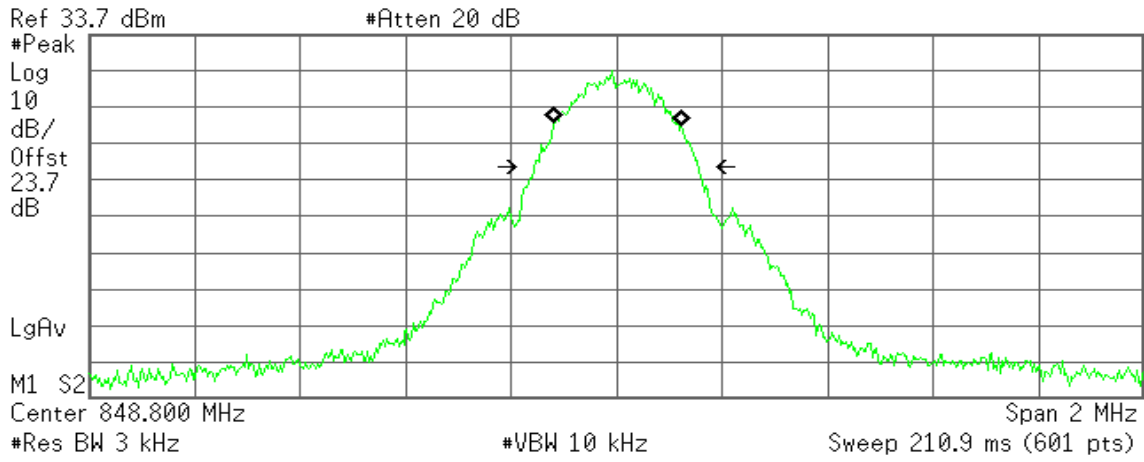

Occupied Bandwidth
243.0219 kHz

Occ BW % Pwr 99.00 %
x dB -26.00 dB

Transmit Freq Error 1.811 kHz
x dB Bandwidth 311.336 kHz



EDGE 1900 (CH Low)

Agilent

R T

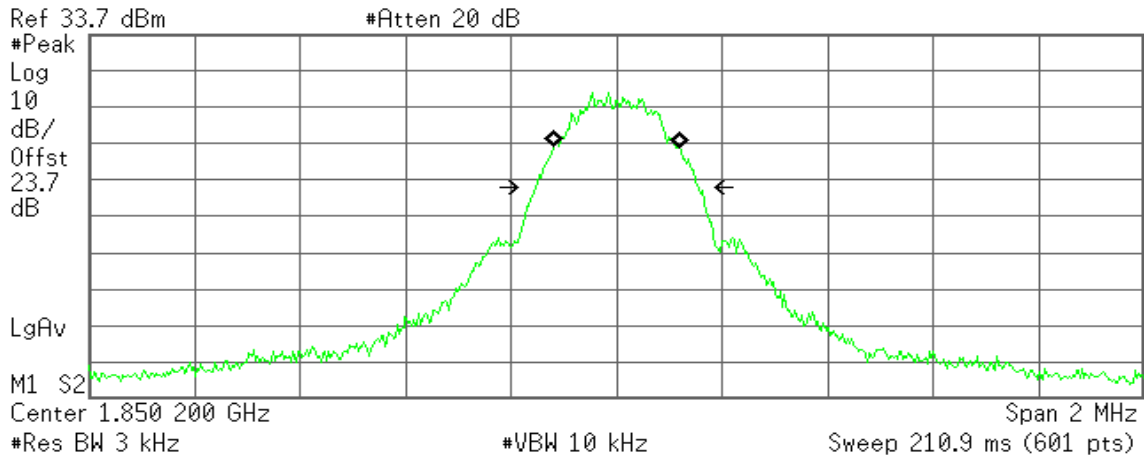

Occupied Bandwidth
241.5077 kHz

Occ BW % Pwr 99.00 %
x dB -26.00 dB

Transmit Freq Error 518.958 Hz
x dB Bandwidth 309.321 kHz

EDGE 1900 (CH Mid)

Agilent

R T

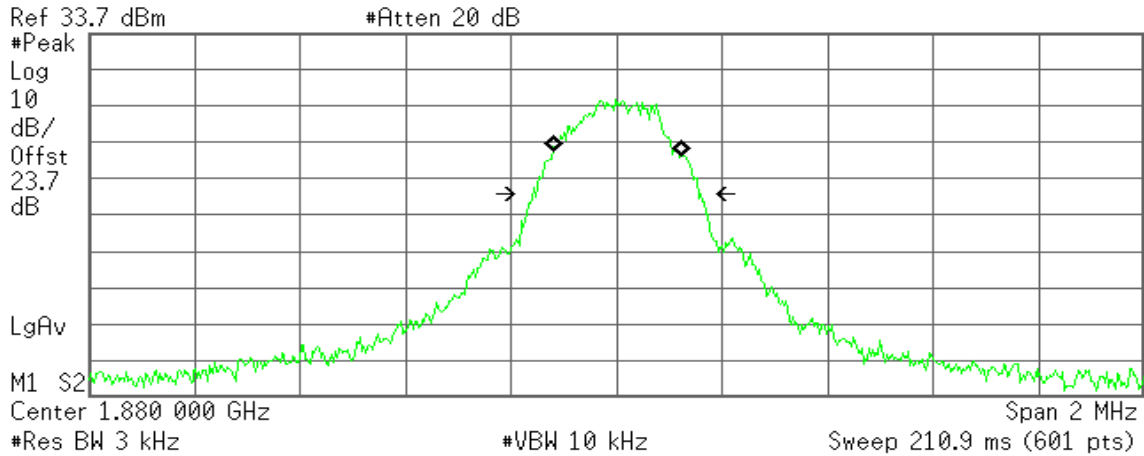

Occupied Bandwidth
245.9471 kHz

Occ BW % Pwr 99.00 %
x dB -26.00 dB

Transmit Freq Error 1.901 kHz
x dB Bandwidth 315.212 kHz



EDGE 1900 (CH High)

Agilent

R T

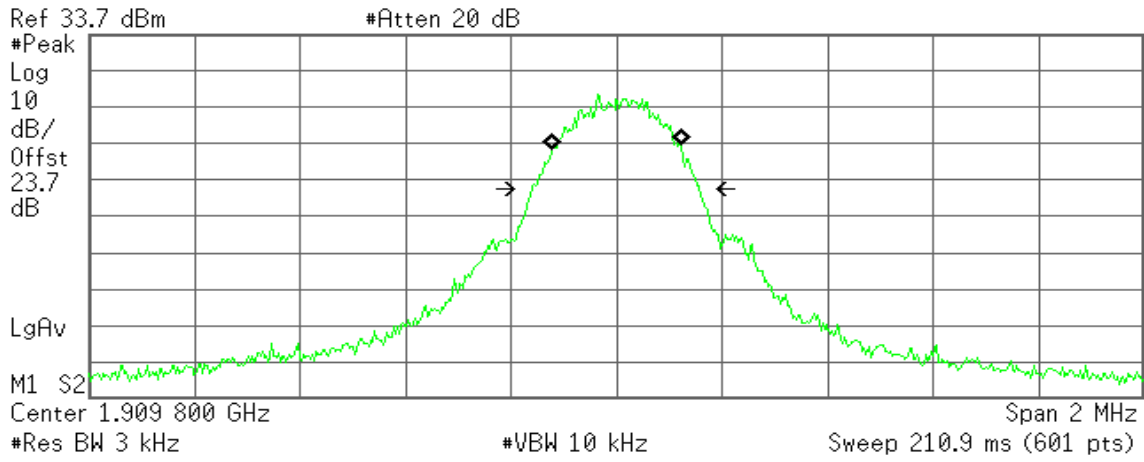

Occupied Bandwidth
244.5472 kHz

Occ BW % Pwr 99.00 %
x dB -26.00 dB

Transmit Freq Error 381.224 Hz
x dB Bandwidth 319.088 kHz



WCDMA Band II (CH Low)

Agilent

R T

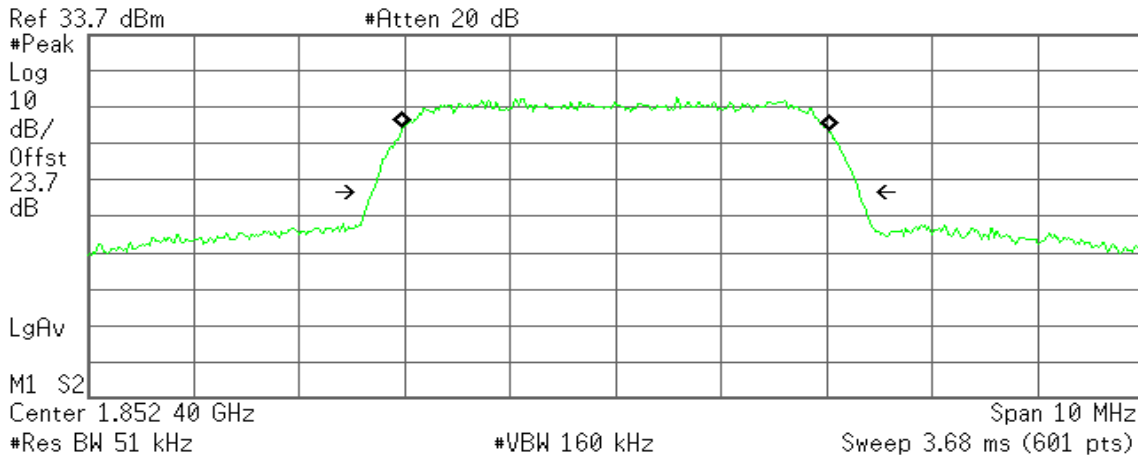

Occupied Bandwidth
4.0527 MHz

Occ BW % Pwr 99.00 %
x dB -26.00 dB

Transmit Freq Error -884.084 Hz
x dB Bandwidth 4.631 MHz

WCDMA Band II (CH Mid)

Agilent

R T

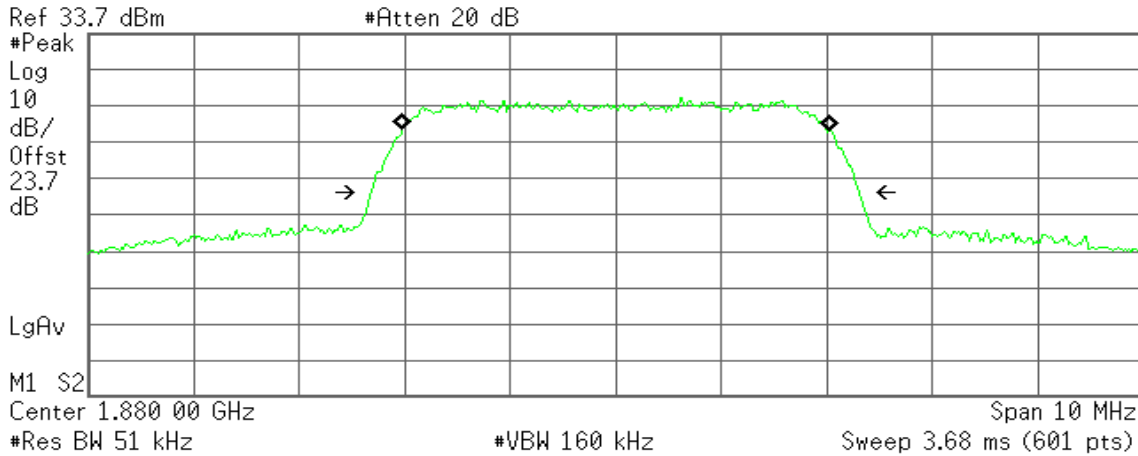

Occupied Bandwidth
4.0622 MHz

Occ BW % Pwr 99.00 %
x dB -26.00 dB

Transmit Freq Error 2.716 kHz
x dB Bandwidth 4.634 MHz



WCDMA Band II (CH High)

Agilent

R T

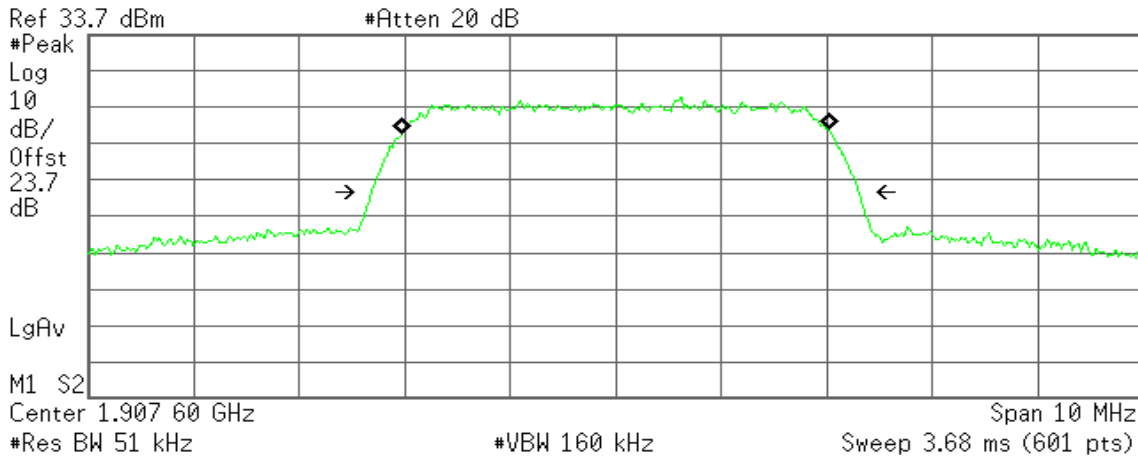

Occupied Bandwidth
4.0629 MHz

Occ BW % Pwr 99.00 %
x dB -26.00 dB

Transmit Freq Error -1.165 kHz
x dB Bandwidth 4.637 MHz



WCDMA Band V (CH Low)

Agilent

R T

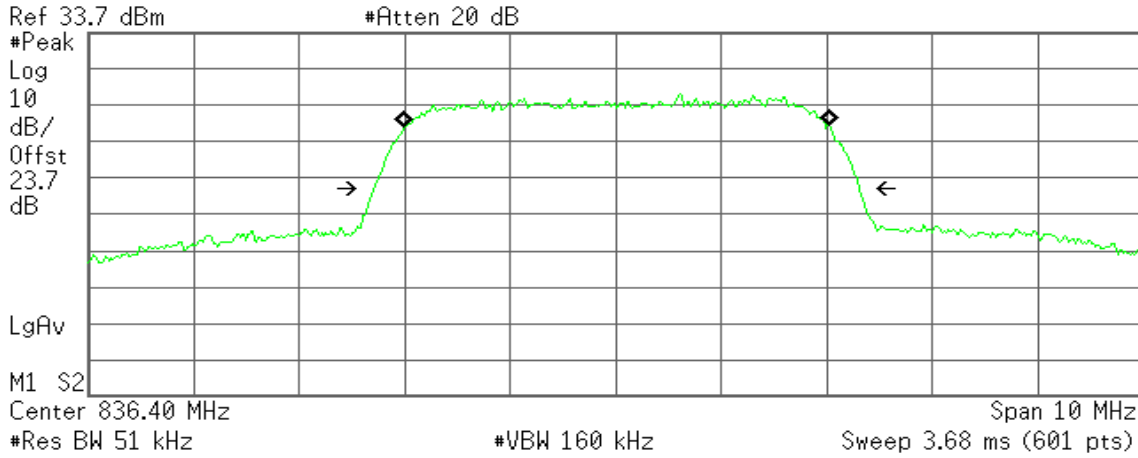

Occupied Bandwidth
4.0526 MHz

Occ BW % Pwr 99.00 %
x dB -26.00 dB

Transmit Freq Error 11.972 kHz
x dB Bandwidth 4.611 MHz

WCDMA Band V (CH Mid)

Agilent

R T

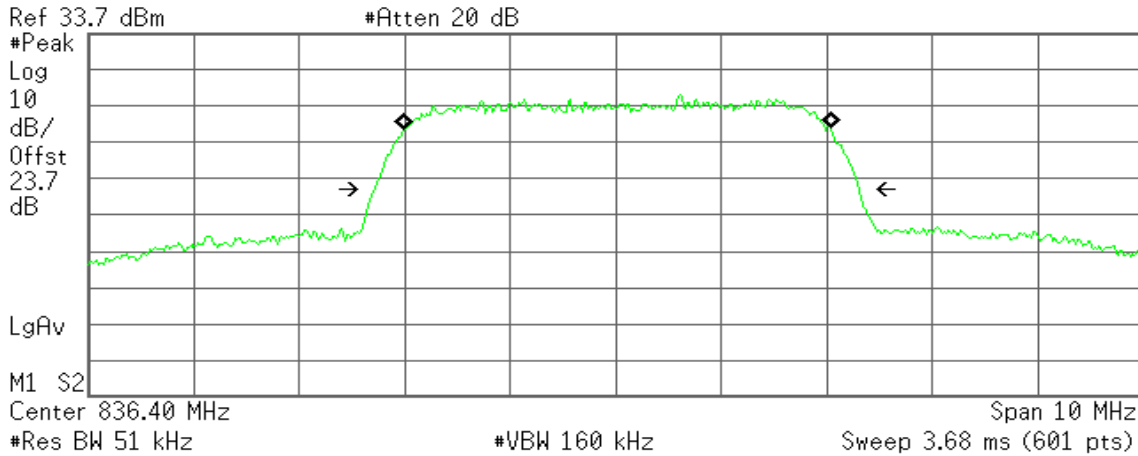

Occupied Bandwidth
4.0600 MHz

Occ BW % Pwr 99.00 %
x dB -26.00 dB

Transmit Freq Error 12.450 kHz
x dB Bandwidth 4.596 MHz



WCDMA Band V (CH High)

Agilent

R T

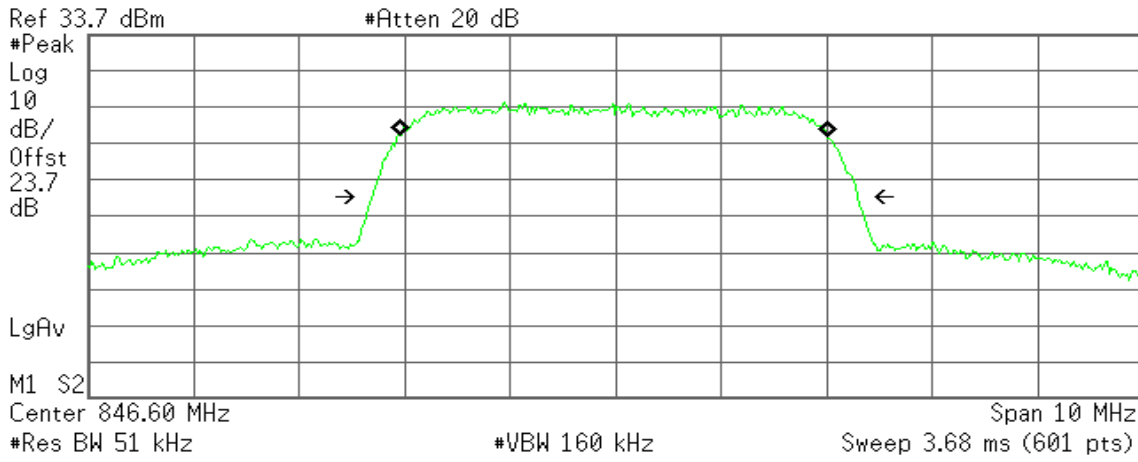

Occupied Bandwidth
4.0621 MHz

Occ BW % Pwr 99.00 %
x dB -26.00 dB

Transmit Freq Error -20.480 kHz
x dB Bandwidth 4.610 MHz



WCDMA / HSDPA Band II (CH Low)

Agilent

R T

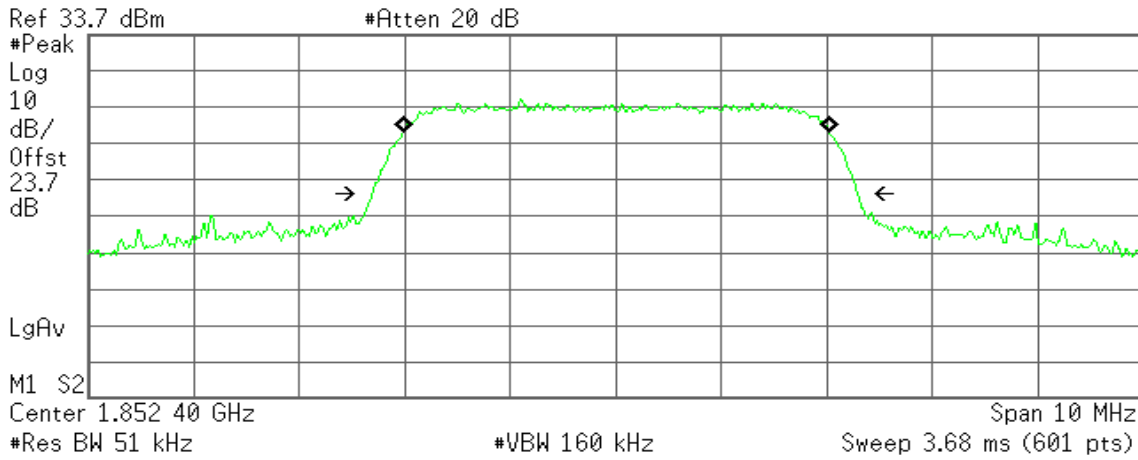

Occupied Bandwidth
4.0559 MHz

Occ BW % Pwr 99.00 %
x dB -26.00 dB

Transmit Freq Error 5.078 kHz
x dB Bandwidth 4.606 MHz

WCDMA / HSDPA Band II (CH Mid)

Agilent

R T

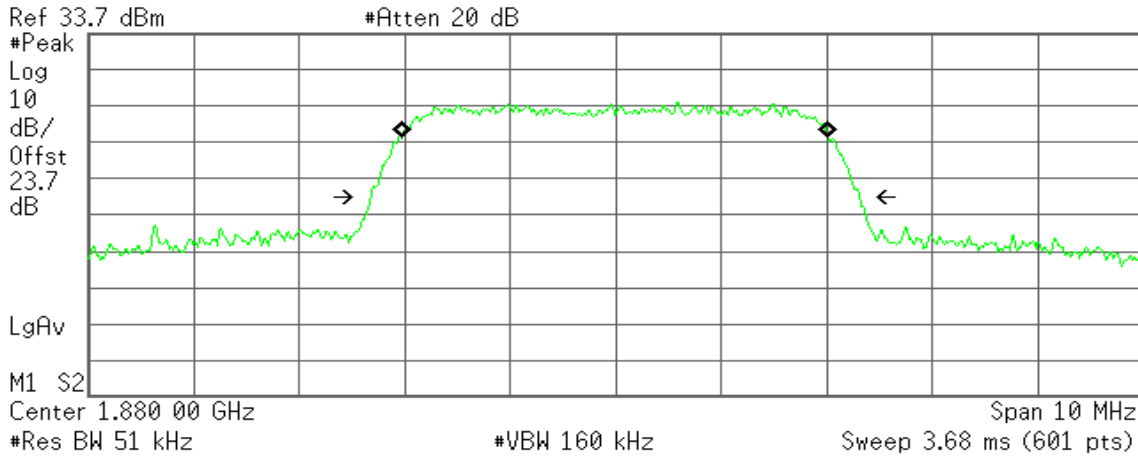

Occupied Bandwidth
4.0585 MHz

Occ BW % Pwr 99.00 %
x dB -26.00 dB

Transmit Freq Error -8.602 kHz
x dB Bandwidth 4.647 MHz



WCDMA / HSDPA Band II (CH High)

Agilent

R T

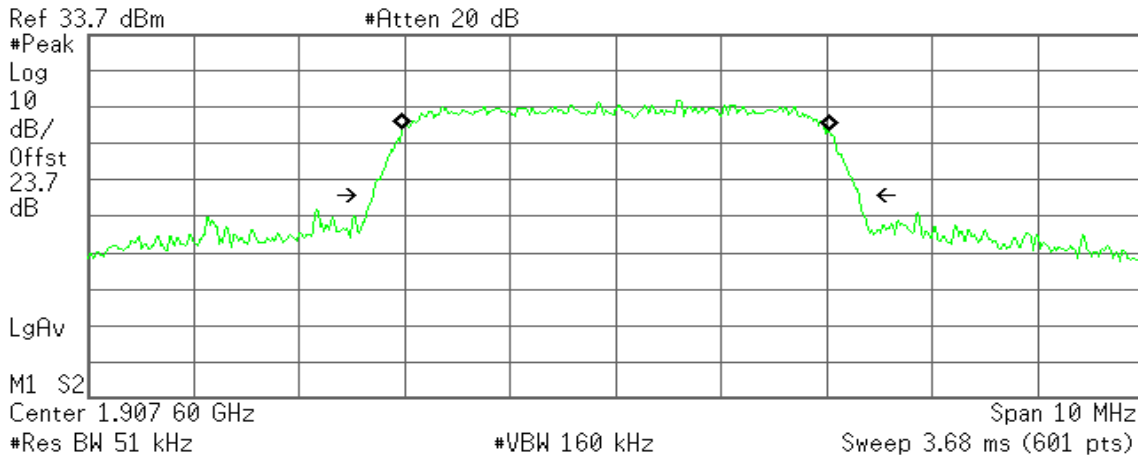

Occupied Bandwidth
4.0638 MHz

Occ BW % Pwr 99.00 %
x dB -26.00 dB

Transmit Freq Error 1.320 kHz
x dB Bandwidth 4.616 MHz



WCDMA / HSDPA Band V (CH Low)

Agilent

R T

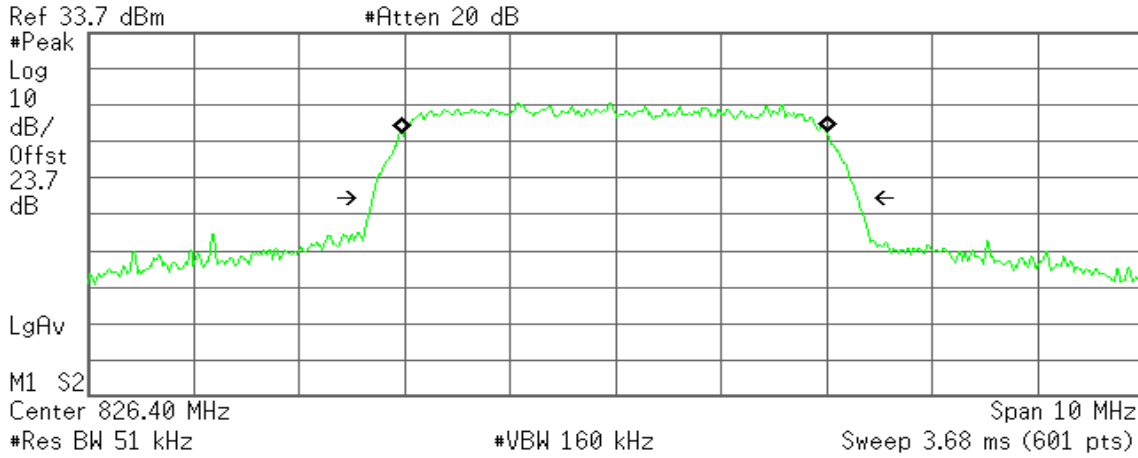

Occupied Bandwidth
4.0549 MHz

Occ BW % Pwr 99.00 %
x dB -26.00 dB

Transmit Freq Error -11.881 kHz
x dB Bandwidth 4.609 MHz

WCDMA / HSDPA Band V (CH Mid)

Agilent

R T

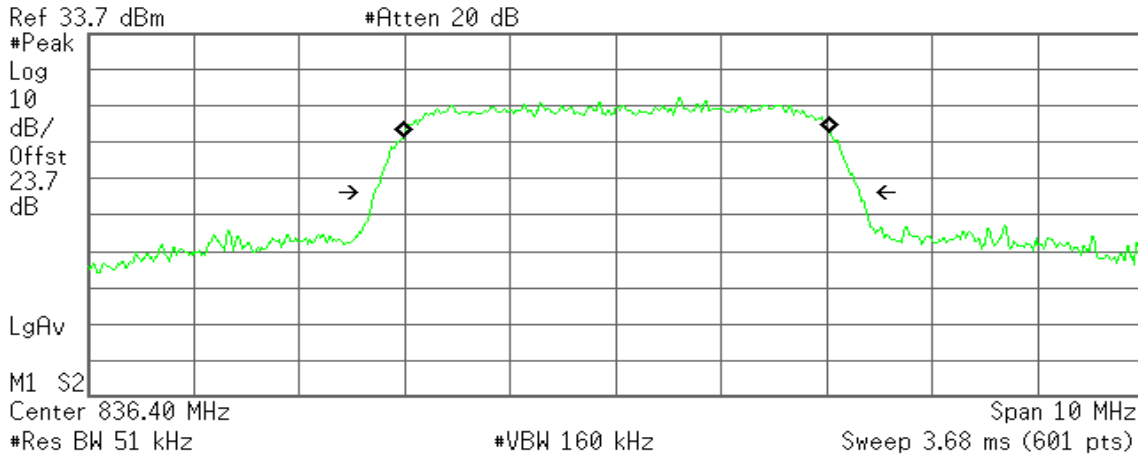

Occupied Bandwidth
4.0541 MHz

Occ BW % Pwr 99.00 %
x dB -26.00 dB

Transmit Freq Error 14.038 kHz
x dB Bandwidth 4.612 MHz



WCDMA / HSDPA Band V (CH High)

Agilent

R T

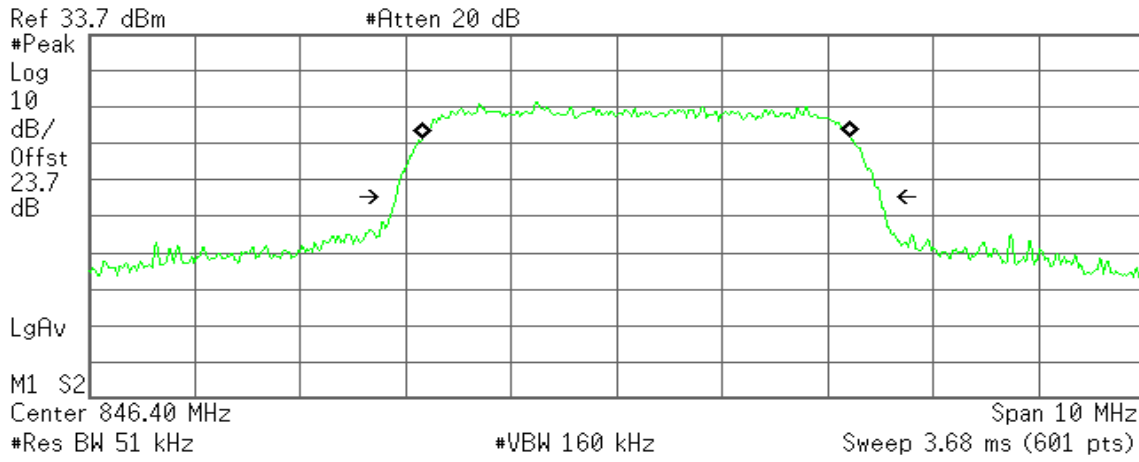

Occupied Bandwidth
4.0521 MHz

Occ BW % Pwr 99.00 %
x dB -26.00 dB

Transmit Freq Error 194.256 kHz
x dB Bandwidth 4.603 MHz



WCDMA / HSUPA Band II (CH Low)

Agilent

R T

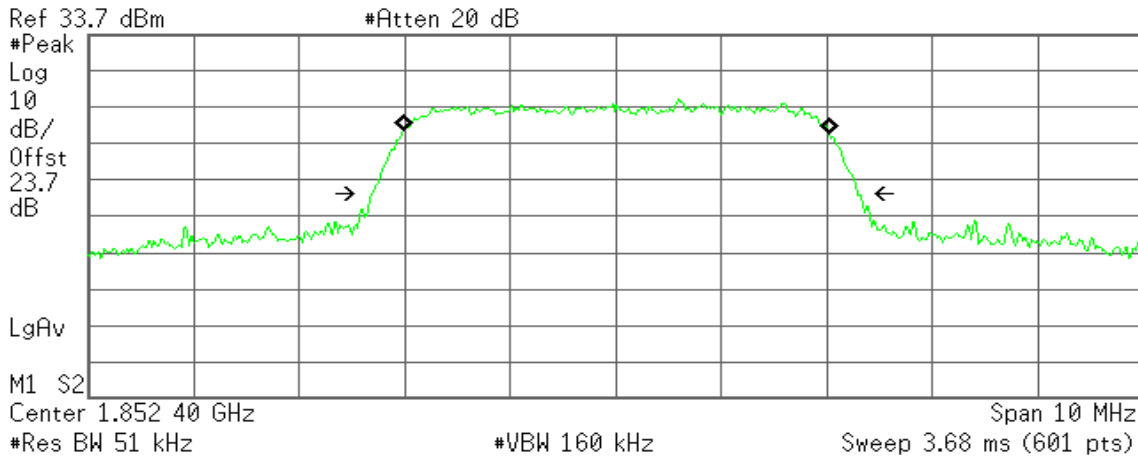

Occupied Bandwidth
4.0552 MHz

Occ BW % Pwr 99.00 %
x dB -26.00 dB

Transmit Freq Error 2.617 kHz
x dB Bandwidth 4.611 MHz

WCDMA / HSUPA Band II (CH Mid)

Agilent

R T

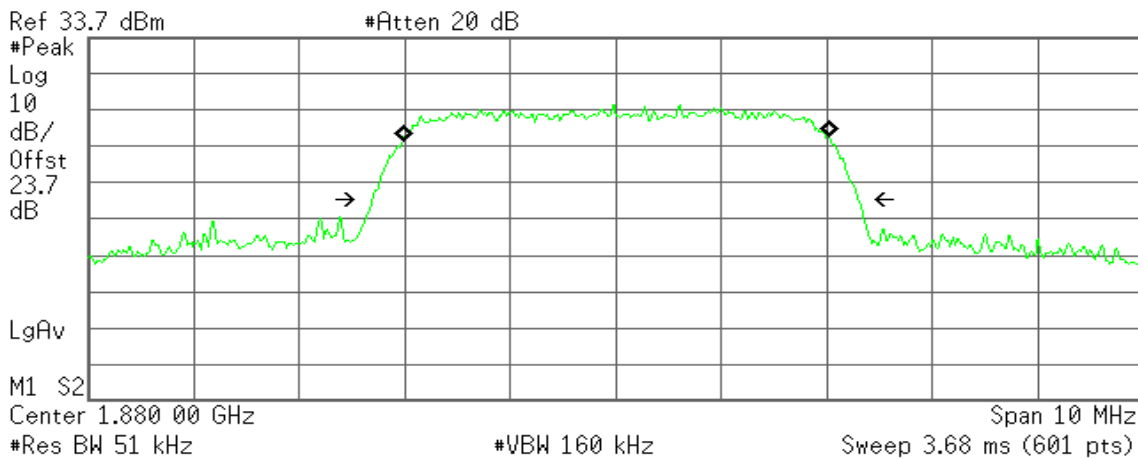

Occupied Bandwidth
4.0550 MHz

Occ BW % Pwr 99.00 %
x dB -26.00 dB

Transmit Freq Error 4.470 kHz
x dB Bandwidth 4.618 MHz



WCDMA / HSUPA Band II (CH High)

Agilent

R T

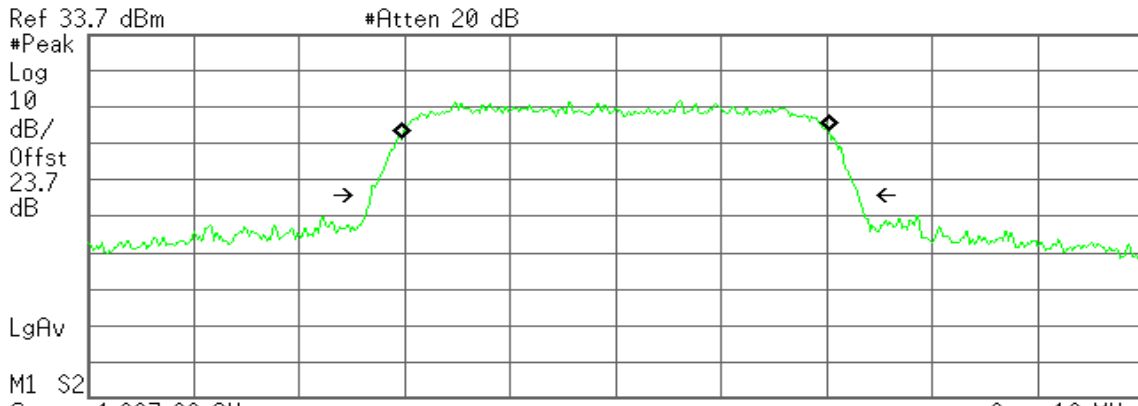

Center 1.907 60 GHz Span 10 MHz
 #Res BW 51 kHz #VBW 160 kHz Sweep 3.68 ms (601 pts)

Occupied Bandwidth
4.0663 MHz

Occ BW % Pwr 99.00 %
x dB -26.00 dB

Transmit Freq Error 1.923 kHz
x dB Bandwidth 4.636 MHz



WCDMA / HSUPA Band V (CH Low)

Agilent

R T

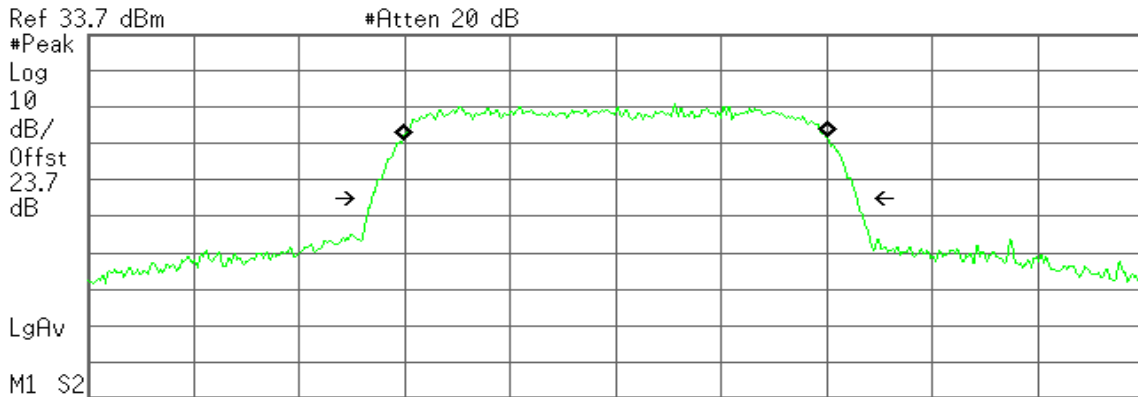

Ref 33.7 dBm #Atten 20 dB
 Center 826.40 MHz Span 10 MHz
 #Res BW 51 kHz #VBW 160 kHz Sweep 3.68 ms (601 pts)

Occupied Bandwidth
4.0291 MHz

Occ BW % Pwr 99.00 %
x dB -26.00 dB

Transmit Freq Error -4.829 kHz
x dB Bandwidth 4.609 MHz

WCDMA / HSUPA Band V (CH Mid)

Agilent

R T

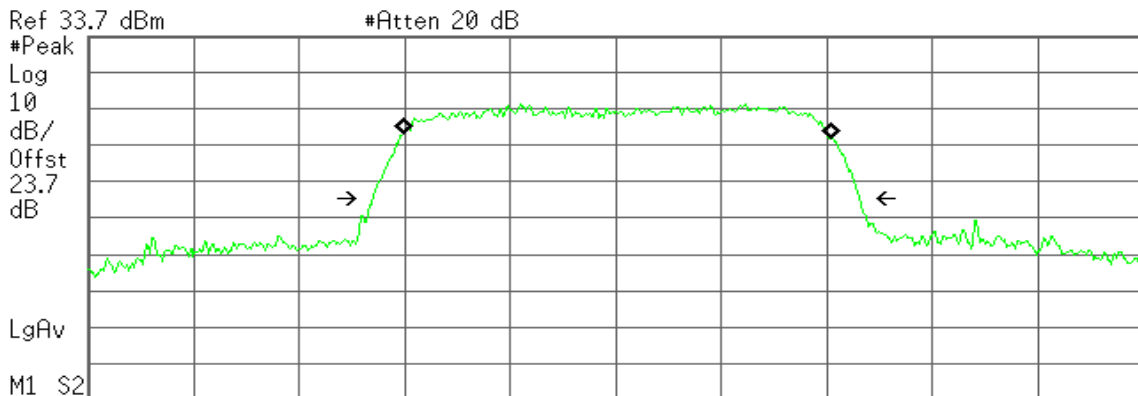

Ref 33.7 dBm #Atten 20 dB
 Center 836.40 MHz Span 10 MHz
 #Res BW 51 kHz #VBW 160 kHz Sweep 3.68 ms (601 pts)

Occupied Bandwidth
4.0641 MHz

Occ BW % Pwr 99.00 %
x dB -26.00 dB

Transmit Freq Error 10.806 kHz
x dB Bandwidth 4.630 MHz



WCDMA / HSUPA Band V (CH High)

Agilent

R T

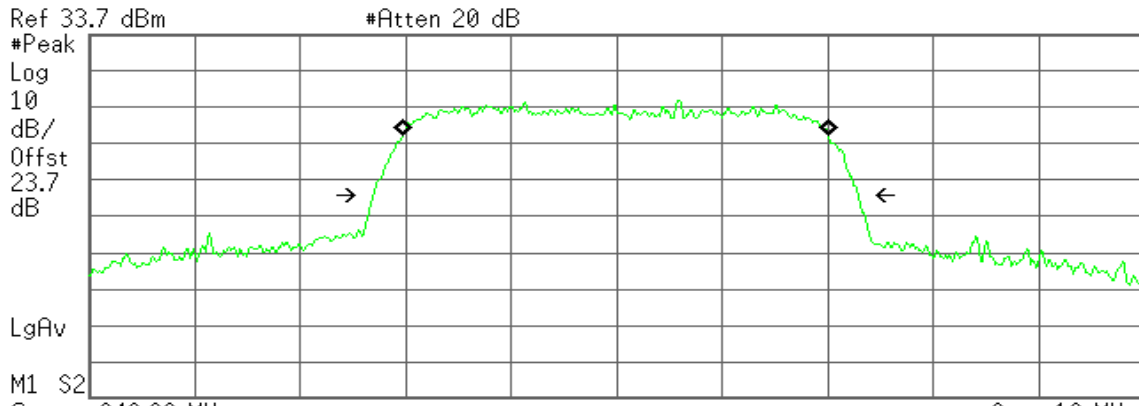

Center 846.60 MHz Span 10 MHz
 #Res BW 51 kHz #VBW 160 kHz Sweep 3.68 ms (601 pts)

Occupied Bandwidth
4.0499 MHz

Occ BW % Pwr 99.00 %
x dB -26.00 dB

Transmit Freq Error -7.072 kHz
x dB Bandwidth 4.605 MHz



7.2 PEAK POWER

LIMIT

According to FCC §2.1046.

Test Configuration

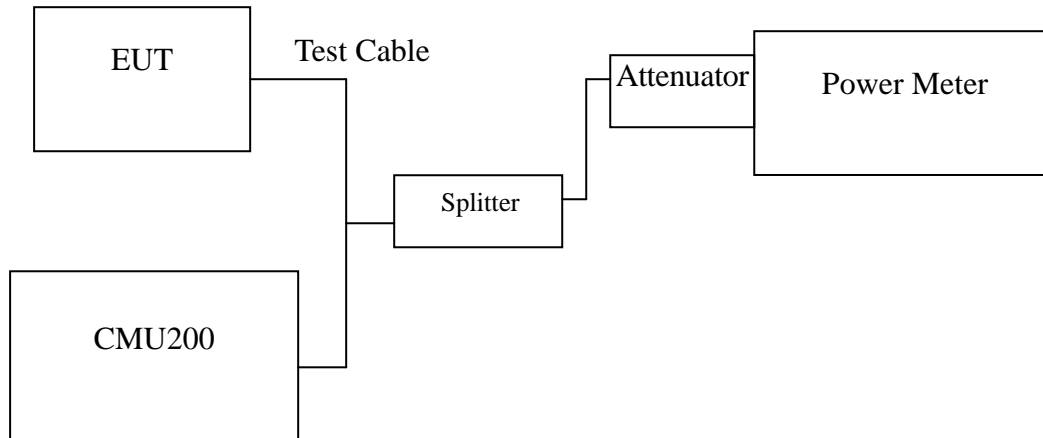

Remark: Measurement setup for testing on Antenna connector

TEST PROCEDURE

The transmitter output was connected to a calibrated attenuator, the other end of which was connected to a power meter. Transmitter output was read off the power meter in dBm. The power output at the transmitter antenna port was determined by adding the value of the attenuator to the power meter reading.

TEST RESULTS

No non-compliance noted.



Test Data

Test Mode	CH	Frequency (MHz)	Peak Power (dBm)	Output Power (W)
GSM 850 (Class B)	128	824.20	32.00	1.58489
	190	836.40	32.00	1.58489
	251	848.80	32.00	1.58489
GPRS 850 (Class 12)	128	824.20	31.00	1.25893
	190	836.40	31.20	1.31826
	251	848.80	31.30	1.34896
EDGE 850 (Class 12)	128	824.20	28.10	0.64565
	190	836.40	28.30	0.67608
	251	848.80	28.40	0.69183

Test Mode	CH	Frequency (MHz)	Peak Power (dBm)	Output Power (W)
GSM 1900 (Class B)	512	1850.20	28.80	0.75858
	661	1880.00	28.90	0.77625
	810	1910.00	28.80	0.75858
GPRS 1900 (Class 12)	512	1850.20	28.00	0.63096
	661	1880.00	27.80	0.60256
	810	1910.00	27.80	0.60256
EDGE 1900 (Class 12)	512	1850.20	27.30	0.53703
	661	1880.00	27.20	0.52481
	810	1910.00	27.20	0.52481

Remark: The value of factor includes both the loss of cable and external attenuator



Test Mode	CH	Frequency (MHz)	Peak Power (dBm)	Output Power (W)
WCDMA (BAND II)	9262	1852.40	27.51	0.56364
	9400	1880.00	25.64	0.36644
	9538	1907.60	25.53	0.35727
WCDMA (BAND V)	4132	826.40	26.32	0.42855
	4182	836.40	26.00	0.39811
	4233	846.60	25.75	0.37584

Test Mode	CH	Frequency (MHz)	Peak Power (dBm)	Output Power (W)
WCDMA / HSDPA (BAND II)	9262	1852.40	27.80	0.60256
	9400	1880.00	26.33	0.42954
	9538	1907.60	26.08	0.40551
WCDMA / HSDPA (BAND V)	4132	826.40	27.37	0.54576
	4182	836.40	27.39	0.54828
	4233	846.60	26.79	0.47753

Test Mode	CH	Frequency (MHz)	Peak Power (dBm)	Output Power (W)
WCDMA / HSUPA (BAND II)	9262	1852.40	27.63	0.57943
	9400	1880.00	26.30	0.42658
	9538	1907.60	26.41	0.43752
WCDMA / HSUPA (BAND V)	4132	826.40	27.32	0.53951
	4182	836.40	27.30	0.53703
	4233	846.60	27.04	0.50582

Remark: The value of factor includes both the loss of cable and external attenuator



7.3 AVERAGE POWER

LIMIT

For reporting purposes only.

Test Configuration

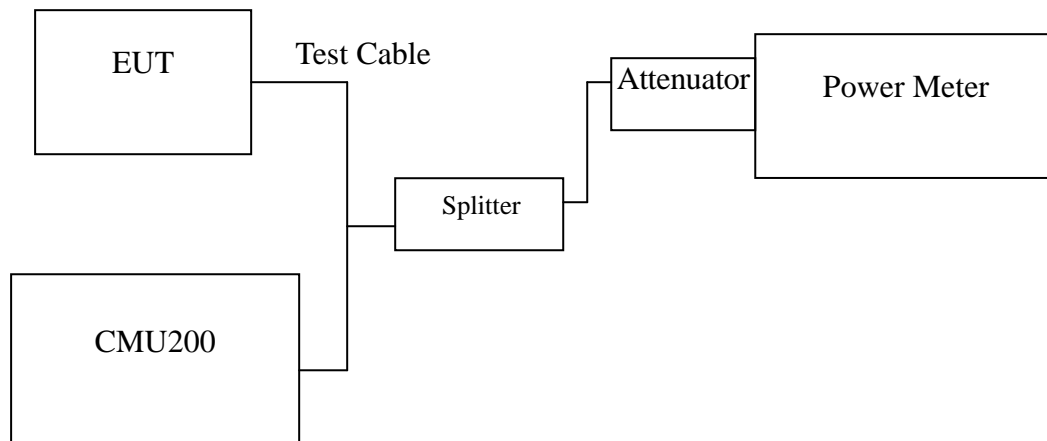

Remark: Measurement setup for testing on Antenna connector

TEST PROCEDURE

The transmitter output was connected to a calibrated attenuator, the other end of which was connected to a power meter. Transmitter output was read off the power meter in dBm. The power output at the transmitter antenna port was determined by adding the value of the attenuator to the power meter reading.

TEST RESULTS

No non-compliance noted.



Test Data

Test Mode	CH	Frequency (MHz)	Average Power (dBm)	Output Power (W)
GSM 850 (Class 12)	128	824.20	31.80	1.51356
	190	836.40	31.90	1.54882
	251	848.80	31.90	1.54882
GPRS 850 (Class 12)	128	824.20	30.90	1.23027
	190	836.40	31.00	1.25893
	251	848.80	31.10	1.28825
EDGE 850 (Class 12)	128	824.20	25.20	0.33113
	190	836.40	25.40	0.34674
	251	848.80	25.50	0.35481

Test Mode	CH	Frequency (MHz)	Average Power (dBm)	Output Power (W)
GSM 1900 (Class 12)	512	1850.20	28.70	0.74131
	661	1880.00	28.80	0.75858
	810	1909.80	28.60	0.72444
GPRS 1900 (Class 12)	512	1850.20	27.80	0.60256
	661	1880.00	27.70	0.58884
	810	1909.80	27.70	0.58884
EDGE 1900 (Class 12)	512	1850.20	24.30	0.26915
	661	1880.00	24.20	0.26303
	810	1909.80	24.30	0.26915

Remark: The value of factor includes both the loss of cable and external attenuator



Test Mode	CH	Frequency (MHz)	Average Power (dBm)	Output Power (W)
WCDMA (BAND II)	9262	1852.40	22.97	0.19815
	9400	1880.00	22.71	0.18664
	9538	1907.60	22.72	0.18707
WCDMA (BAND V)	4132	826.40	22.63	0.18323
	4182	836.40	22.73	0.18750
	4233	846.60	22.36	0.17219

Test Mode	CH	Frequency (MHz)	Average Power (dBm)	Output Power (W)
WCDMA / HSDPA (BAND II)	9262	1852.40	22.98	0.19861
	9400	1880.00	22.80	0.19055
	9538	1907.60	22.78	0.18967
WCDMA / HSDPA (BAND V)	4132	826.40	22.61	0.18239
	4182	836.40	22.70	0.18621
	4233	846.60	22.28	0.16904

Test Mode	CH	Frequency (MHz)	Peak Power (dBm)	Output Power (W)
WCDMA / HSUPA (BAND II)	9262	1852.40	22.94	0.19679
	9400	1880.00	22.72	0.18707
	9538	1907.60	22.80	0.19055
WCDMA / HSUPA (BAND V)	4132	826.40	22.53	0.17906
	4182	836.40	22.62	0.18281
	4233	846.60	22.44	0.17539

Remark: The value of factor includes both the loss of cable and external attenuator



7.4 ERP & EIRP MEASUREMENT

LIMIT

According to FCC §2.1046

FCC 22.913(b): The Effective Radiated Power (ERP) of mobile transmitters must not exceed 7 Watts.

RSS-132 § 4.4 The maximum (ERP) shall be 6.3 Watts for mobile stations.

FCC 24.232(b): The equivalent Isotropic Radiated Power (EIRP) must not exceed 2 Watts.

RSS133 § 6.4: Mobile stations and hand-held portables are limited to 2 watts maximum (EIRP).

Test Configuration

Below 1 GHz

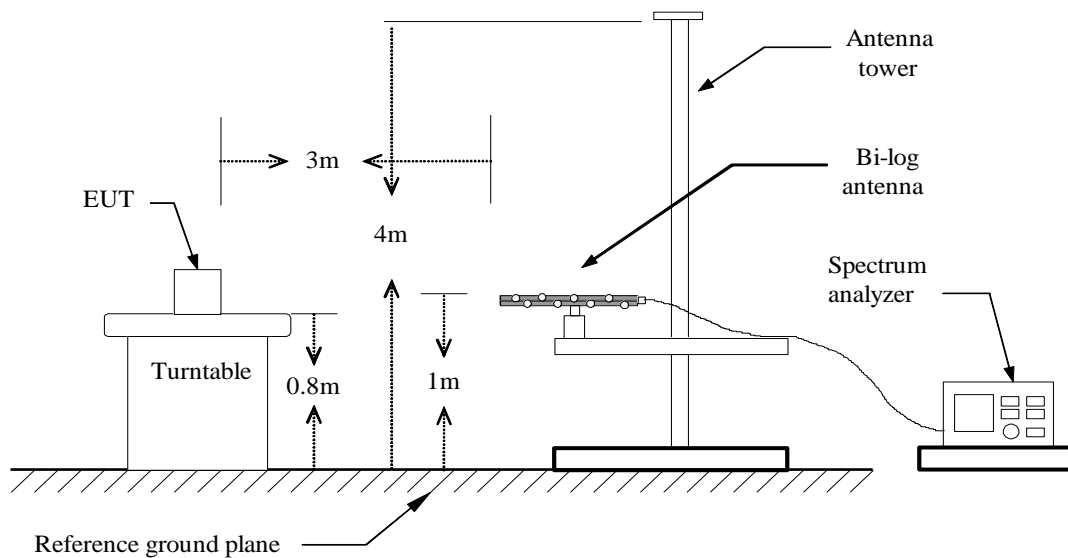

Above 1 GHz

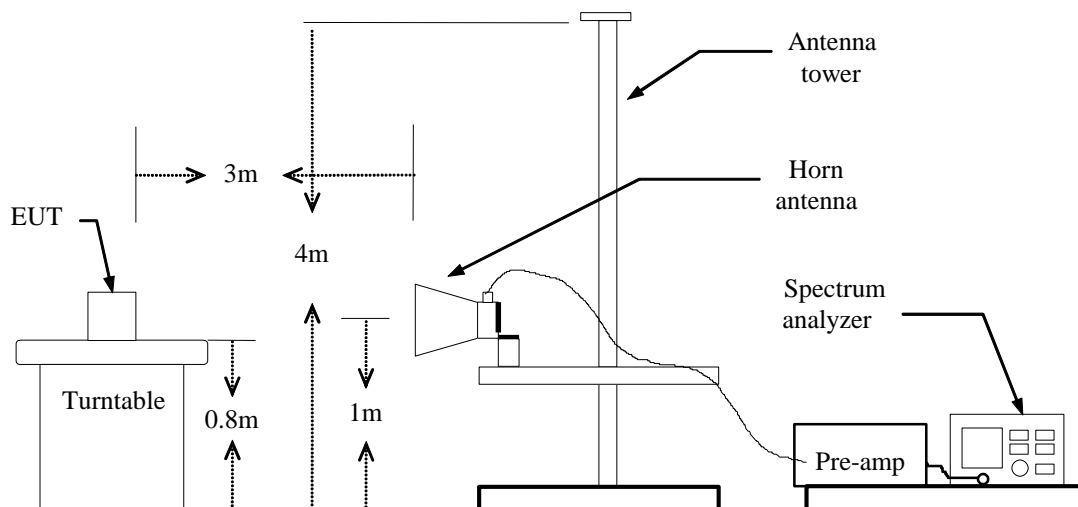



For Substituted Method Test Set-UP

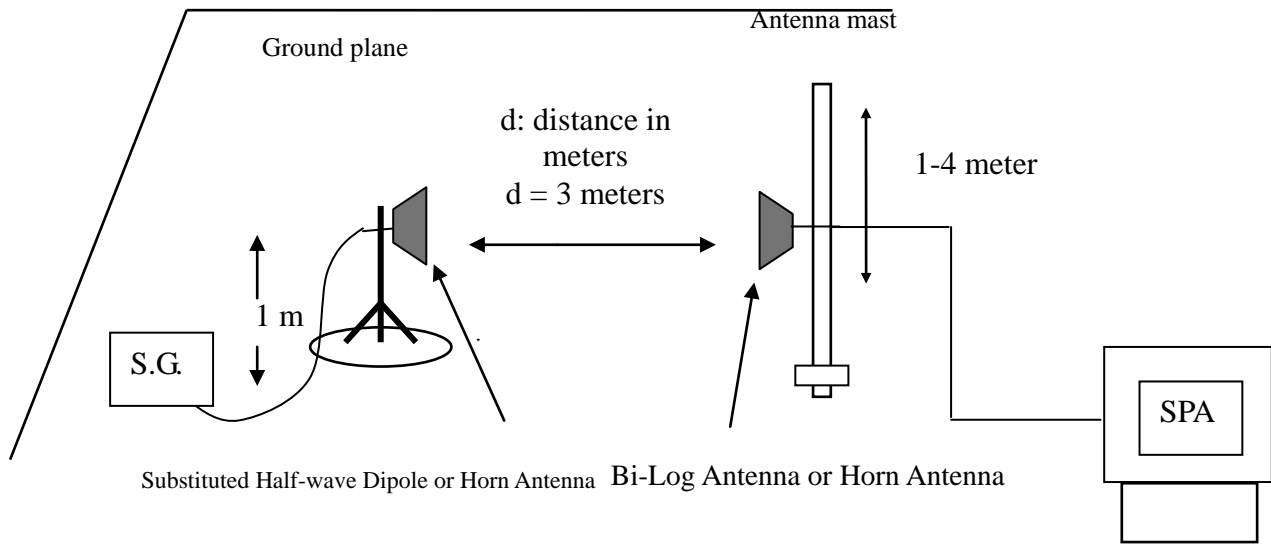

TEST PROCEDURE

The EUT was placed on a non-conductive turntable using a non-conductive support. The radiated emission at the fundamental frequency was measured at 3 m with a test antenna and EMI spectrum analyzer.

During the measurement of the EUT, the resolution bandwidth was set to 5MHz and the average bandwidth was set to 50MHz. The highest emission was recorded with the rotation of the turntable and the lowering of the test antenna. The reading was recorded and the field strength (E in dBuV/m) was calculated.

ERP in frequency band 824-849MHz, and EIRP in frequency band 1851.25 –1910MHz were measured using a substitution method. The EUT was replaced by half-wave dipole (824-849MHz) or horn antenna (1851.25-1910MHz) connected to a signal generator. The spectrum analyzer reading was recorded and ERP/EIRP was calculated as follows:

$$\text{ERP} = \text{S.G. output (dBm)} + \text{Antenna Gain (dBi)} - \text{Cable (dB)} - 2.15$$

$$\text{EIRP} = \text{S.G. output (dBm)} + \text{Antenna Gain (dBi)} - \text{Cable (dB)}$$

TEST RESULTS

No non-compliance noted.

**GSM 850 Test Data**

Channel	Frequency (MHz)	Antenna Pol.	S.G. (dBm)	Cable loss (dB)	Ant.Gain (dBi)	Emission level (dBm)	Limit (dBm)	Margin (dB)
128	824.2900	V	22.31	3.39	6.24	25.16	38.45	-13.29
	824.2200	H	24.44	3.39	6.24	*27.29	38.45	-11.16
190	836.4000	V	19.53	3.4	6.36	22.49	38.45	-15.96
	836.4700	H	22.1	3.4	6.36	25.06	38.45	-13.39
251	848.7900	V	22.12	3.4	6.4	25.12	38.45	-13.33
	848.6500	H	23.44	3.4	6.4	26.44	38.45	-12.01

GPRS 850 Test Data

Channel	Frequency (MHz)	Antenna Pol.	S.G. (dBm)	Cable loss (dB)	Ant.Gain (dBi)	Emission level (dBm)	Limit (dBm)	Margin (dB)
128	824.1500	V	20.09	3.39	6.24	22.94	38.45	-15.51
	824.2200	H	22.38	3.39	6.24	*25.23	38.45	-13.22
190	836.4700	V	17.73	3.4	6.36	20.69	38.45	-17.76
	836.6100	H	20.03	3.4	6.37	23.00	38.45	-15.45
251	848.6500	V	20.39	3.4	6.4	23.39	38.45	-15.06
	848.8600	H	21.51	3.4	6.4	24.51	38.45	-13.94

GSM 1900 Test Data

Channel	Frequency (MHz)	Antenna Pol.	S.G. (dBm)	Cable loss (dB)	Ant.Gain (dBi)	Emission level (dBm)	Limit (dBm)	Margin (dB)
512	1850.160	V	24.96	5.37	5.67	25.26	33.00	-7.74
	1850.280	H	28.01	5.37	5.67	28.31	33.00	-4.69
661	1879.920	V	25.1	5.42	5.62	25.30	33.00	-7.70
	1880.040	H	29.37	5.42	5.62	*29.57	33.00	-3.43
810	1909.800	V	24.63	5.48	5.56	24.71	33.00	-8.29
	1909.920	H	29.47	5.48	5.56	29.55	33.00	-3.45

GPRS 1900 Test Data

Channel	Frequency (MHz)	Antenna Pol.	S.G. (dBm)	Cable loss (dB)	Ant.Gain (dBi)	Emission level (dBm)	Limit (dBm)	Margin (dB)
512	1850.160	V	24.2	5.37	5.67	24.50	33.00	-8.50
	1850.280	H	27.13	5.37	5.67	27.43	33.00	-5.57
661	1879.920	V	24.21	5.42	5.62	24.41	33.00	-8.59
	1879.920	H	28.48	5.42	5.62	*28.68	33.00	-4.32
810	1909.800	V	23.69	5.48	5.56	23.77	33.00	-9.23
	1909.800	H	28.52	5.48	5.56	28.60	33.00	-4.40



EDGE 850 Test Data

Channel	Frequency (MHz)	Antenna Pol.	S.G. (dBm)	Cable loss (dB)	Ant.Gain (dBi)	Emission level (dBm)	Limit (dBm)	Margin (dB)
128	824.2200	V	20.06	3.39	6.24	22.91	38.45	-15.54
	824.2200	H	22.39	3.39	6.24	*25.24	38.45	-13.21
190	836.4700	V	17.69	3.4	6.36	20.65	38.45	-17.80
	836.4700	H	20.06	3.4	6.36	23.02	38.45	-15.43
251	848.7200	V	20.37	3.4	6.4	23.37	38.45	-15.08
	848.7200	H	21.49	3.4	6.4	24.49	38.45	-13.96

EDGE 1900 TEST DATA

Channel	Frequency (MHz)	Antenna Pol.	S.G. (dBm)	Cable loss (dB)	Ant.Gain (dBi)	Emission level (dBm)	Limit (dBm)	Margin (dB)
512	1850.160	V	24.12	5.37	5.67	24.42	33.00	-8.58
	1850.160	H	27.05	5.37	5.67	27.35	33.00	-5.65
661	1880.040	V	24.14	5.42	5.62	24.34	33.00	-8.66
	1879.920	H	28.44	5.42	5.62	*28.64	33.00	-4.36
810	1909.800	V	23.69	5.48	5.56	23.77	33.00	-9.23
	1909.800	H	28.41	5.48	5.56	28.49	33.00	-4.51

**WCDMA BAND II Test Data**

Channel	Frequency (MHz)	Antenna Pol.	S.G. (dBm)	Cable loss (dB)	Ant.Gain (dBi)	Emission level (dBm)	Limit (dBm)	Margin (dB)
9262	1853.640	V	18.76	5.38	5.66	19.04	33.00	-13.96
	1853.640	H	24.21	5.38	5.66	24.49	33.00	-8.51
9400	1878.840	V	18.6	5.42	5.62	18.80	33.00	-14.20
	1878.480	H	25.18	5.42	5.62	*25.38	33.00	-7.62
9538	1906.320	V	18.26	5.47	5.57	18.36	33.00	-14.64
	1906.800	H	25.21	5.47	5.57	25.31	33.00	-7.69

WCDMA BAND V Test Data

Channel	Frequency (MHz)	Antenna Pol.	S.G. (dBm)	Cable loss (dB)	Ant.Gain (dBi)	Emission level (dBm)	Limit (dBm)	Margin (dB)
4132	827.0200	V	17.51	3.39	6.27	20.39	38.45	-18.06
	827.0900	H	17.55	3.39	6.27	20.43	38.45	-18.02
4182	837.1000	V	16.95	3.4	6.37	19.92	38.45	-18.53
	837.3800	H	17.87	3.4	6.37	20.84	38.45	-17.61
4233	845.7800	V	16.15	3.4	6.4	19.15	38.45	-19.30
	847.7400	H	18.37	3.4	6.4	*21.37	38.45	-17.08

HSDPA BAND II Test Data

Channel	Frequency (MHz)	Antenna Pol.	S.G. (dBm)	Cable loss (dB)	Ant.Gain (dBi)	Emission level (dBm)	Limit (dBm)	Margin (dB)
9262	1853.400	V	20.8	5.38	5.66	21.08	33.00	-11.92
	1854.000	H	25.47	5.38	5.66	25.75	33.00	-7.25
9400	1881.360	V	19.21	5.42	5.61	19.40	33.00	-13.60
	1879.920	H	25.63	5.42	5.62	*25.83	33.00	-7.17
9538	1906.800	V	20.62	5.47	5.57	20.72	33.00	-12.28
	1906.680	H	25.73	5.47	5.57	25.83	33.00	-7.17

HSDPA BAND V Test Data

Channel	Frequency (MHz)	Antenna Pol.	S.G. (dBm)	Cable loss (dB)	Ant.Gain (dBi)	Emission level (dBm)	Limit (dBm)	Margin (dB)
4132	827.1600	V	16.24	3.39	6.27	19.12	38.45	-19.33
	827.5100	H	17.99	3.39	6.27	20.87	38.45	-17.58
4182	837.4500	V	16.22	3.4	6.37	19.19	38.45	-19.26
	837.4500	H	17.97	3.4	6.37	20.94	38.45	-17.51
4233	845.4300	V	17.03	3.4	6.4	20.03	38.45	-18.42
	846.6200	H	18.51	3.4	6.4	*21.51	38.45	-16.94



WCDMA / HSUPA BAND II Test Data

Channel	Frequency (MHz)	Antenna Pol.	S.G. (dBm)	Cable loss (dB)	Ant.Gain (dBi)	Emission level (dBm)	Limit (dBm)	Margin (dB)
9262	1853.400	V	20.49	5.38	5.66	20.77	33.00	-12.23
	1853.160	H	25.49	5.38	5.66	25.77	33.00	-7.23
9400	1880.760	V	19.9	5.42	5.61	20.09	33.00	-12.91
	1881.000	H	25.78	5.42	5.61	25.97	33.00	-7.03
9538	1906.560	V	20.97	5.47	5.57	21.07	33.00	-11.93
	1906.560	H	25.93	5.47	5.57	*26.03	33.00	-6.97

WCDMA / HSUPA BAND V Test Data

Channel	Frequency (MHz)	Antenna Pol.	S.G. (dBm)	Cable loss (dB)	Ant.Gain (dBi)	Emission level (dBm)	Limit (dBm)	Margin (dB)
4132	825.3400	V	16.15	3.39	6.25	19.01	38.45	-19.44
	827.5800	H	17.75	3.39	6.27	20.63	38.45	-17.82
4182	837.1700	V	16.12	3.4	6.37	19.09	38.45	-19.36
	837.2400	H	17.78	3.4	6.37	20.75	38.45	-17.70
4233	847.7400	V	16.98	3.4	6.4	19.98	38.45	-18.47
	845.0800	H	18.37	3.4	6.4	*21.37	38.45	-17.08



7.5 OUT OF BAND EMISSION AT ANTENNA TERMINALS

LIMIT

According to FCC §2.1051, FCC §22.917, FCC §24.238(a), RSS-132 (4.5.2), RSS-133 (6.6).

Out of Band Emissions: The mean power of emission must be attenuated below the mean power of the non-modulated carrier (P) on any frequency twice or more than twice the fundamental frequency by at least $43 + 10 \log P$ dB.

Mobile Emissions in Base Frequency Range: The mean power of any emissions appearing in the base station frequency range from cellular mobile transmitters operated must be attenuated to a level not exceed -80 dBm at the transmit antenna connector.

Band Edge Requirements: In the 1MHz bands immediately outside and adjacent to the frequency block, a resolution bandwidth of at least 1% of the emission bandwidth of the fundamental emission of the transmitter may be employed to measure the Out of band Emission

Test Configuration

Out of band emission at antenna terminals:

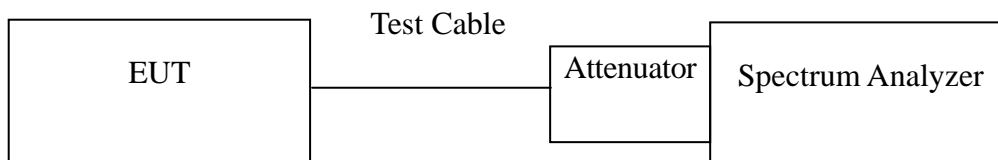

TEST PROCEDURE

The RF output of the transceiver was connected to a spectrum analyzer through appropriate attenuation. The resolution bandwidth of the spectrum analyzer was set at 1MHz, sufficient scans were taken to show the out of band Emissions if any up to 10th harmonic.

For the out of band: Set the RBW, VBW = 1MHz, Start=30MHz, Stop= 10 th harmonic. Limit = -13dBm

Band Edge Requirements (824 MHz and 849 MHz /1850MHz and 1910MHz): In the 1 MHz bands immediately outside and adjacent to the frequency block, a resolution bandwidth of at least 1 percent of the emission bandwidth of the fundamental emission of the transmitter may be employed to measure the out of band Emissions. Limit, -13dBm.

TEST RESULTS

No non-compliance noted.



Test Data

Mode	CH	Location	Description
GSM 850	128	Figure 7-1	Conducted spurious emissions, 30MHz - 20GHz
	190	Figure 7-2	Conducted spurious emissions, 30MHz - 20GHz
	251	Figure 7-3	Conducted spurious emissions, 30MHz - 20GHz
GPRS 850	128	Figure 8-1	Conducted spurious emissions, 30MHz - 20GHz
	190	Figure 8-2	Conducted spurious emissions, 30MHz - 20GHz
	251	Figure 8-3	Conducted spurious emissions, 30MHz - 20GHz

Mode	CH	Location	Description
GSM 1900	512	Figure 9-1	Conducted spurious emissions, 30MHz - 20GHz
	661	Figure 9-2	Conducted spurious emissions, 30MHz - 20GHz
	810	Figure 9-3	Conducted spurious emissions, 30MHz - 20GHz
GPRS 1900	512	Figure 10-1	Conducted spurious emissions, 30MHz - 20GHz
	661	Figure 10-2	Conducted spurious emissions, 30MHz - 20GHz
	810	Figure 10-3	Conducted spurious emissions, 30MHz - 20GHz

Mode	CH	Location	Description
GSM 850	128	Figure 11-1	Band Edge emissions
	251	Figure 11-2	Band Edge emissions
GPRS 850	128	Figure 12-1	Band Edge emissions
	251	Figure 12-2	Band Edge emissions

Mode	CH	Location	Description
GSM 1900	512	Figure 13-1	Band Edge emissions
	810	Figure 13-2	Band Edge emissions
GPRS 1900	512	Figure 14-1	Band Edge emissions
	810	Figure 14-2	Band Edge emissions



Mode	CH	Location	Description
EDGE 850	128	Figure 15-1	Conducted spurious emissions, 30MHz - 20GHz
	190	Figure 15-2	Conducted spurious emissions, 30MHz - 20GHz
	251	Figure 15-3	Conducted spurious emissions, 30MHz - 20GHz
EDGE 1900	512	Figure 16-1	Conducted spurious emissions, 30MHz - 20GHz
	661	Figure 16-2	Conducted spurious emissions, 30MHz - 20GHz
	810	Figure 16-3	Conducted spurious emissions, 30MHz - 20GHz

Mode	CH	Location	Description
EDGE 850	128	Figure 17-1	Band Edge emissions
	251	Figure 17-2	Band Edge emissions
EDGE 1900	512	Figure 18-1	Band Edge emissions
	810	Figure 18-2	Band Edge emissions



Mode	CH	Location	Description
WCDMA (Band II)	9262	Figure 19-1	Conducted spurious emissions, 30MHz - 20GHz
	9400	Figure 19-2	Conducted spurious emissions, 30MHz - 20GHz
	9538	Figure 19-3	Conducted spurious emissions, 30MHz - 20GHz
WCDMA (Band V)	4132	Figure 20-1	Conducted spurious emissions, 30MHz - 20GHz
	4182	Figure 20-2	Conducted spurious emissions, 30MHz - 20GHz
	4233	Figure 20-3	Conducted spurious emissions, 30MHz - 20GHz

Mode	CH	Location	Description
WCDMA (Band II)	9262	Figure 21-1	Band Edge emissions
	9538	Figure 21-2	Band Edge emissions
WCDMA (Band V)	4132	Figure 22-1	Band Edge emissions
	4233	Figure 22-2	Band Edge emissions

Mode	CH	Location	Description
HSDPA WCDMA (Band II)	9262	Figure 23-1	Conducted spurious emissions, 30MHz - 20GHz
	9400	Figure 23-2	Conducted spurious emissions, 30MHz - 20GHz
	9538	Figure 23-3	Conducted spurious emissions, 30MHz - 20GHz
HSDPA WCDMA (Band V)	4132	Figure 24-1	Conducted spurious emissions, 30MHz - 20GHz
	4182	Figure 24-2	Conducted spurious emissions, 30MHz - 20GHz
	4233	Figure 24-3	Conducted spurious emissions, 30MHz - 20GHz

Mode	CH	Location	Description
HSDPA WCDMA (Band II)	9262	Figure 25-1	Band Edge emissions
	9538	Figure 25-2	Band Edge emissions
HSDPA WCDMA (Band V)	4132	Figure 26-1	Band Edge emissions
	4233	Figure 26-2	Band Edge emissions



Mode	CH	Location	Description
HSUPA WCDMA (Band II)	9262	Figure 27-1	Conducted spurious emissions, 30MHz - 20GHz
	9400	Figure 27-2	Conducted spurious emissions, 30MHz - 20GHz
	9538	Figure 27-3	Conducted spurious emissions, 30MHz - 20GHz
HSUPA WCDMA (Band V)	4132	Figure 28-1	Conducted spurious emissions, 30MHz - 20GHz
	4182	Figure 28-2	Conducted spurious emissions, 30MHz - 20GHz
	4233	Figure 28-3	Conducted spurious emissions, 30MHz - 20GHz

Mode	CH	Location	Description
HSUPA WCDMA (Band II)	9262	Figure 29-1	Band Edge emissions
	9538	Figure 29-2	Band Edge emissions
HSUPA WCDMA (Band V)	4132	Figure 30-1	Band Edge emissions
	4233	Figure 30-2	Band Edge emissions



Test Plot

GSM 850

Figure 7-1: Out of Band emission at antenna terminals – GSM CH Low

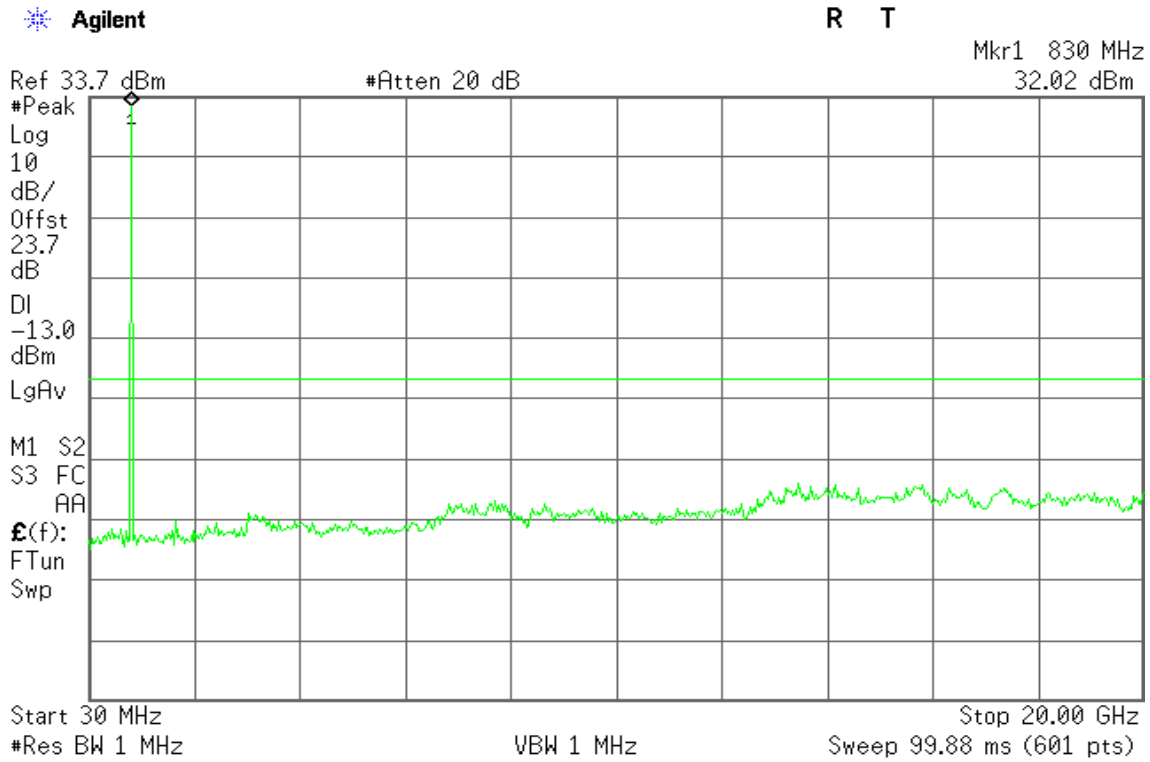

Figure 7-2: Out of Band emission at antenna terminals – GSM CH Mid

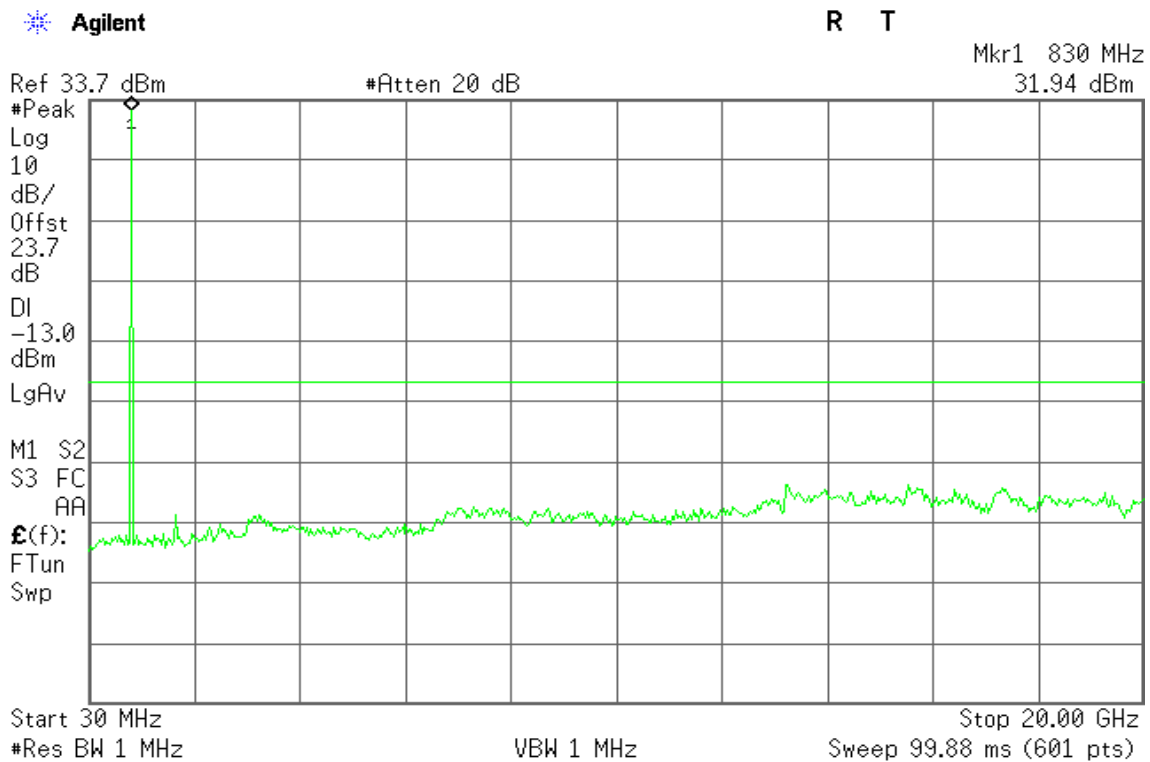
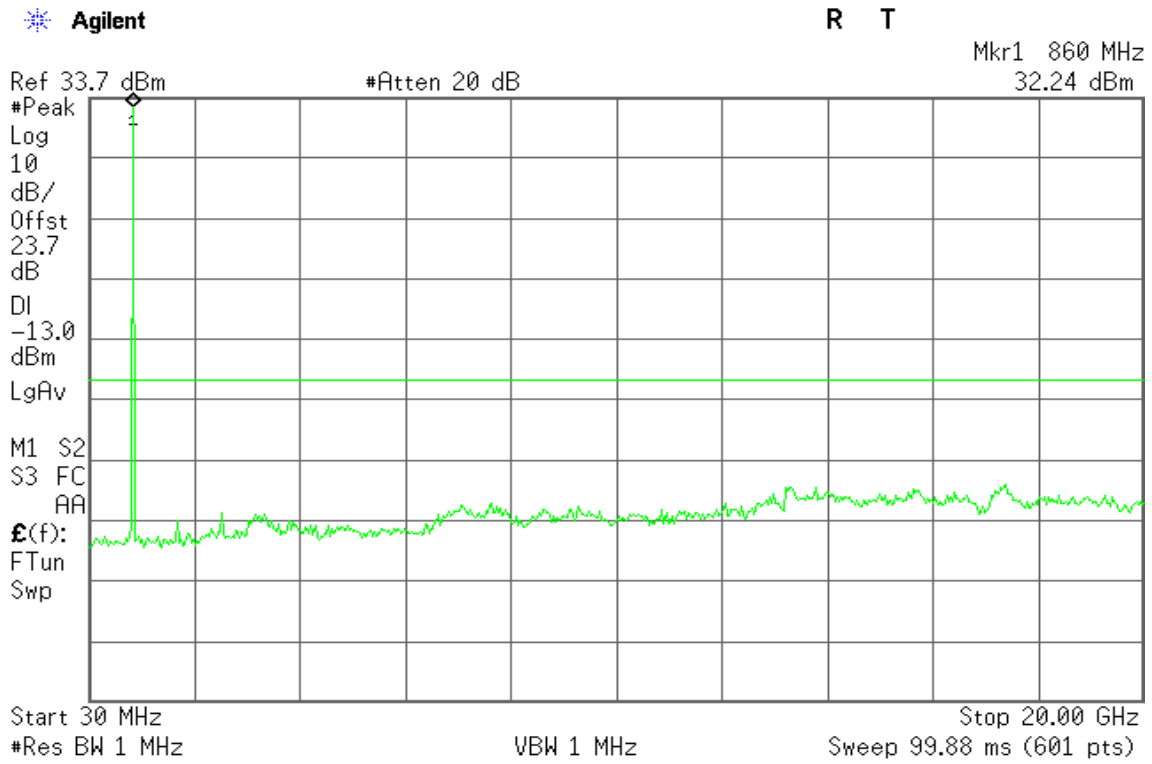



Figure 7-3: Out of Band emission at antenna terminals – GSM CH High





GPRS 850

Figure 8-1: Out of Band emission at antenna terminals – GPRS CH Low

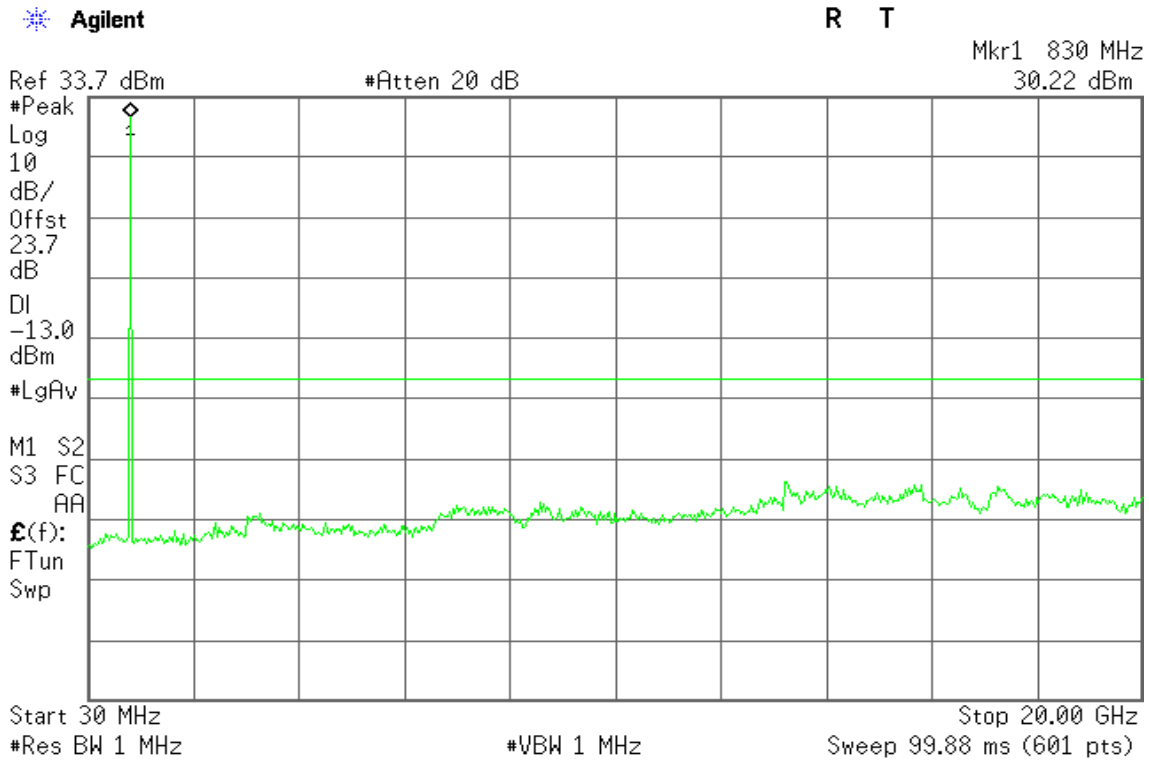

Figure 8-2: Out of Band emission at antenna terminals – GPRS CH Mid

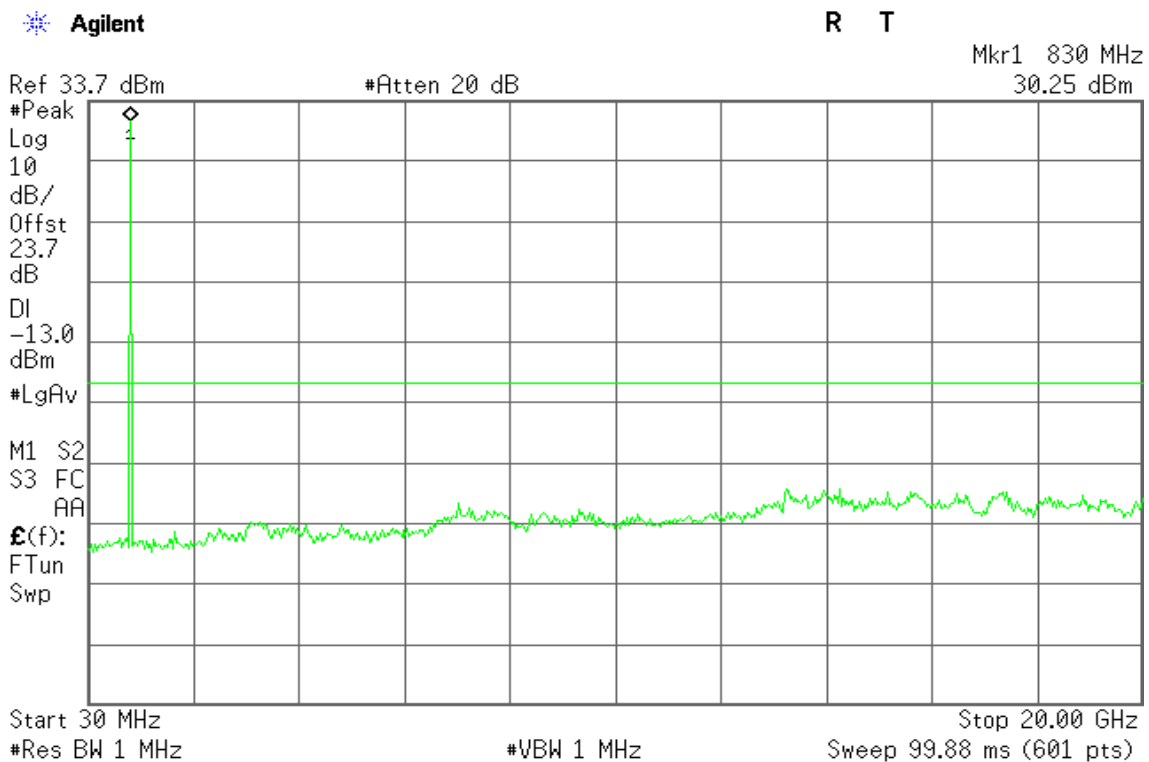
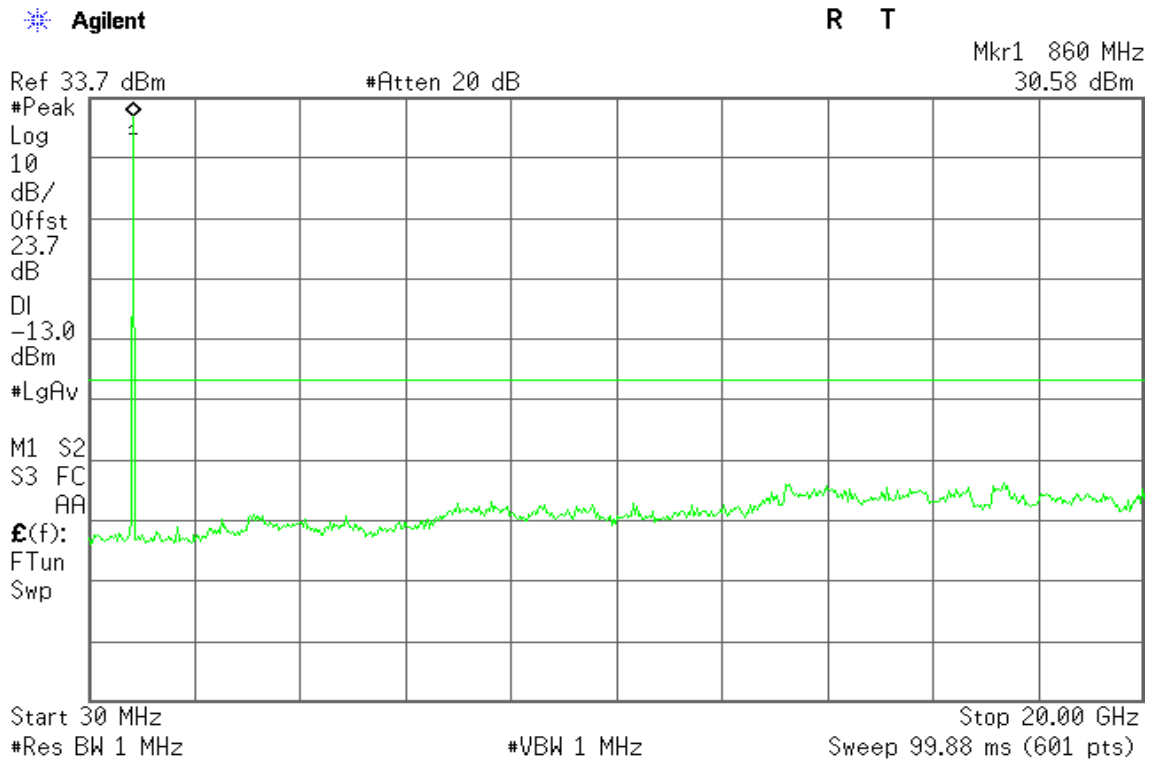



Figure 8-3: Out of Band emission at antenna terminals – GPRS CH High





GSM 1900

Figure 9-1: Out of Band emission at antenna terminals – GSM CH Low

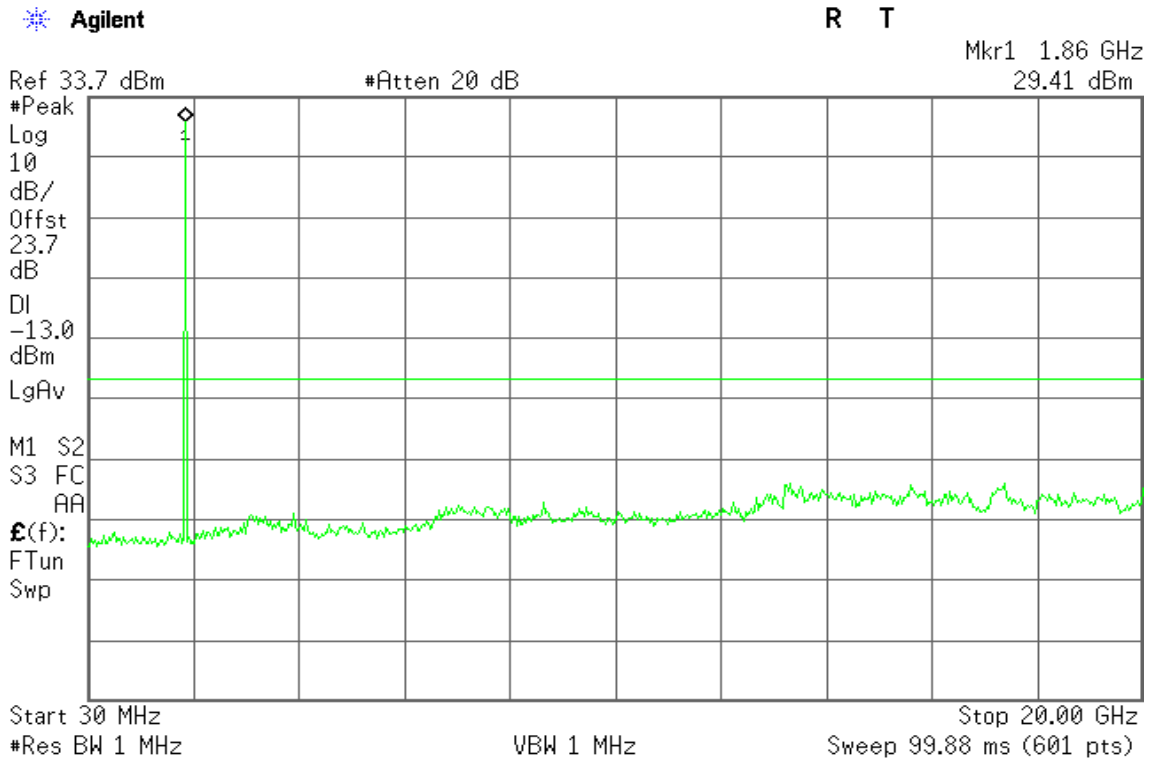

Figure 9-2: Out of Band emission at antenna terminals – GSM CH Mid

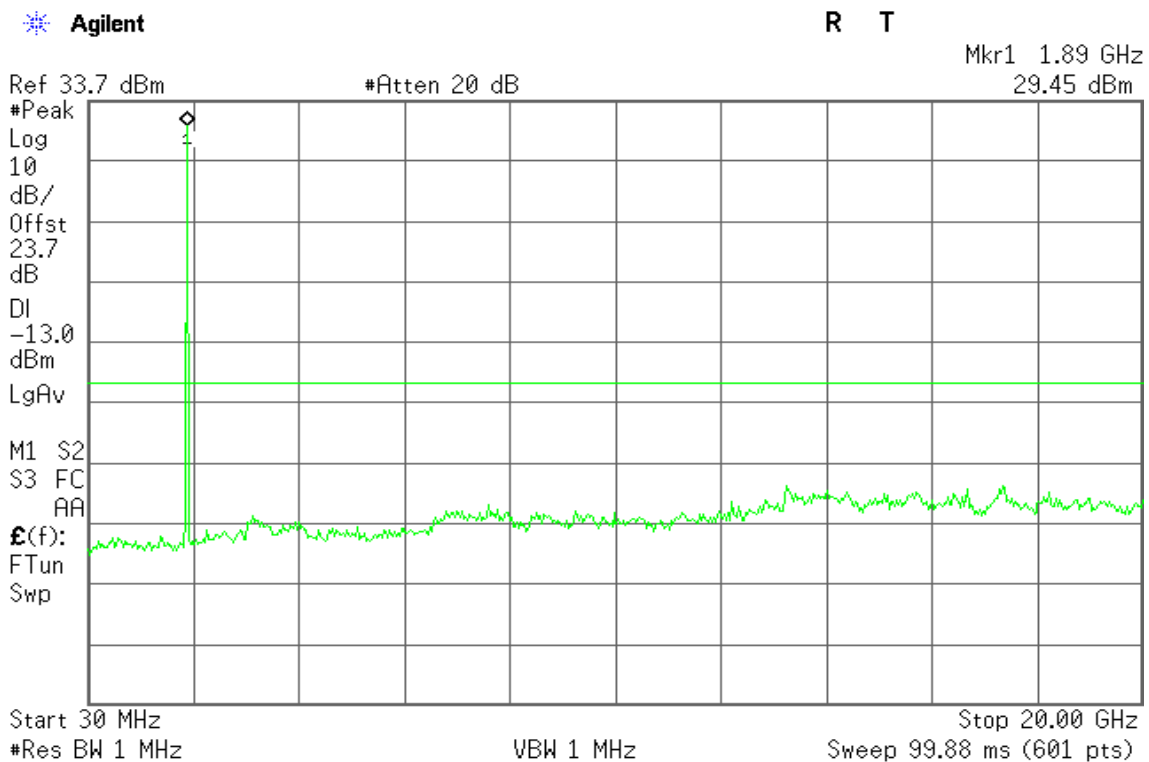
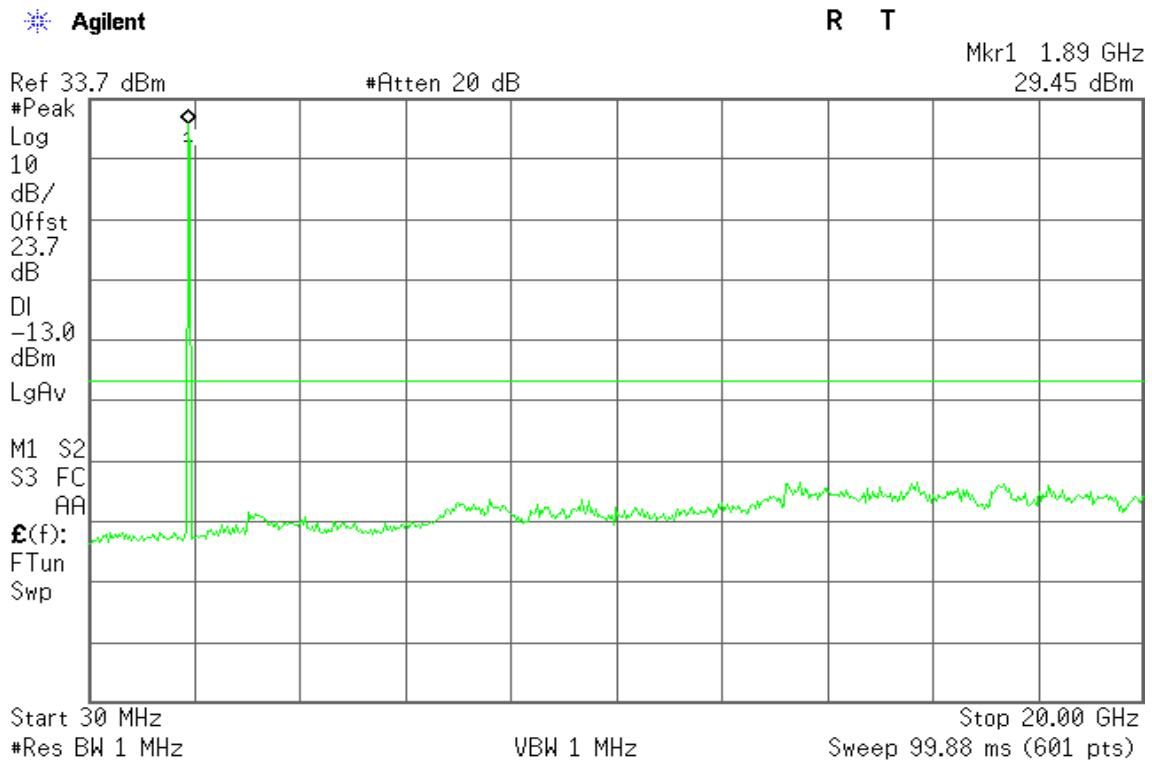



Figure 9-3: Out of Band emission at antenna terminals – GSM CH High





GPRS 1900

Figure 10-1: Out of Band emission at antenna terminals – GSM CH Low

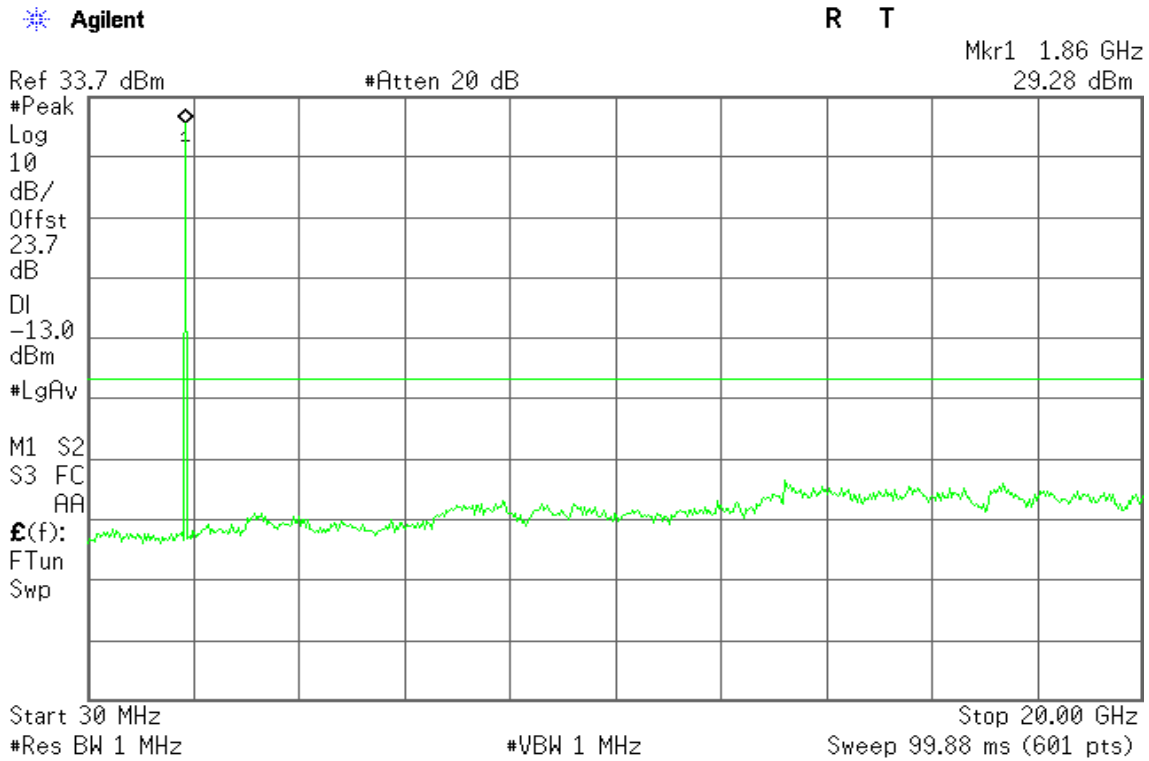

Figure 10-2: Out of Band emission at antenna terminals – GSM CH Mid

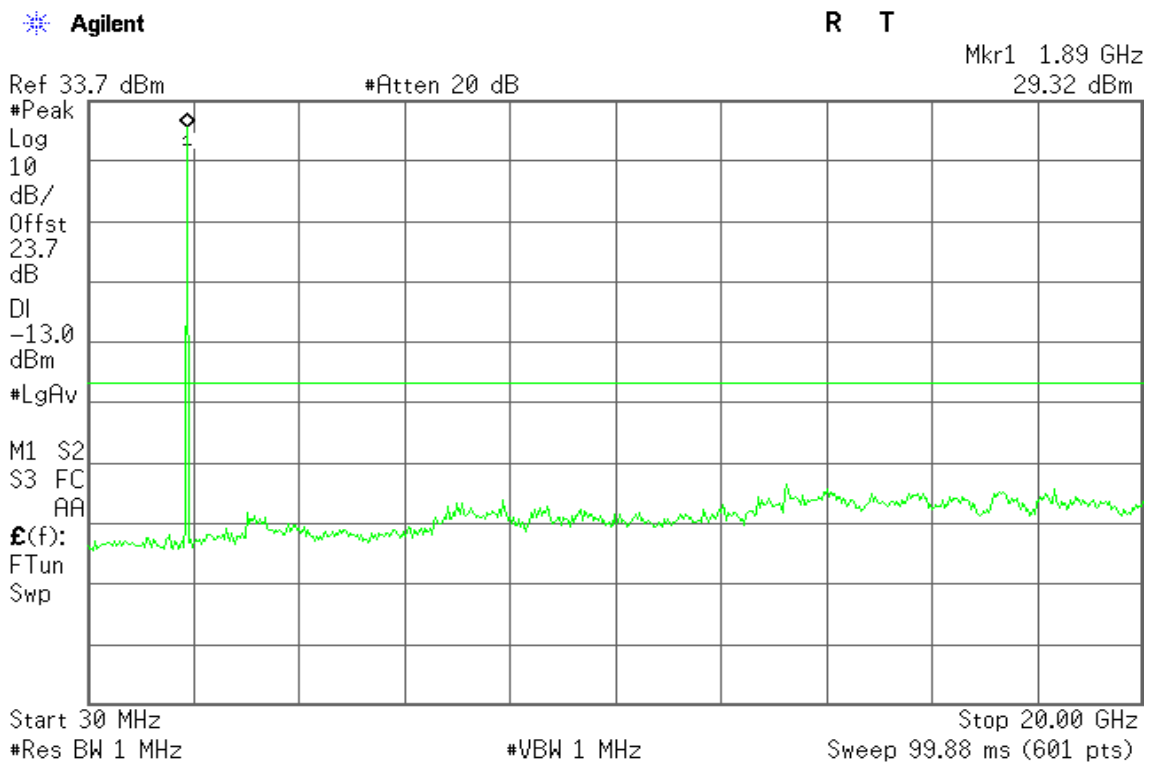
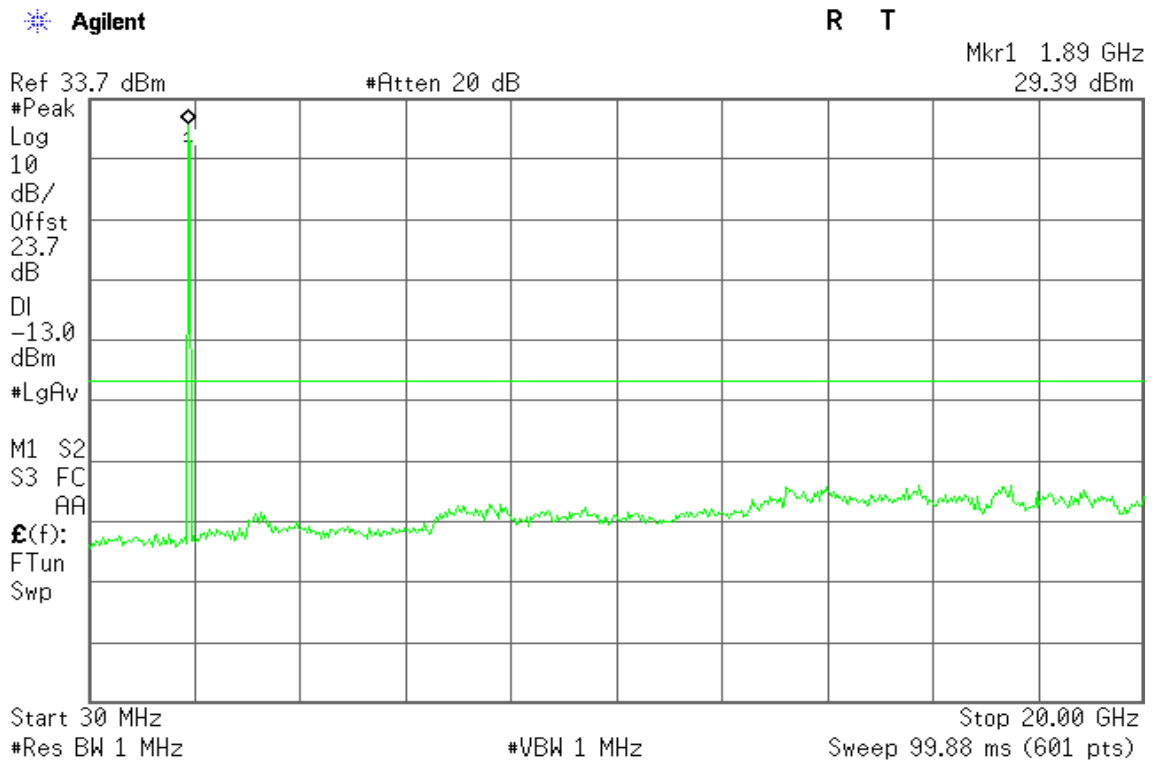



Figure 10-3: Out of Band emission at antenna terminals – GSM CH High





GSM 850

Figure 11-1: Band Edge emissions – GSM CH Low

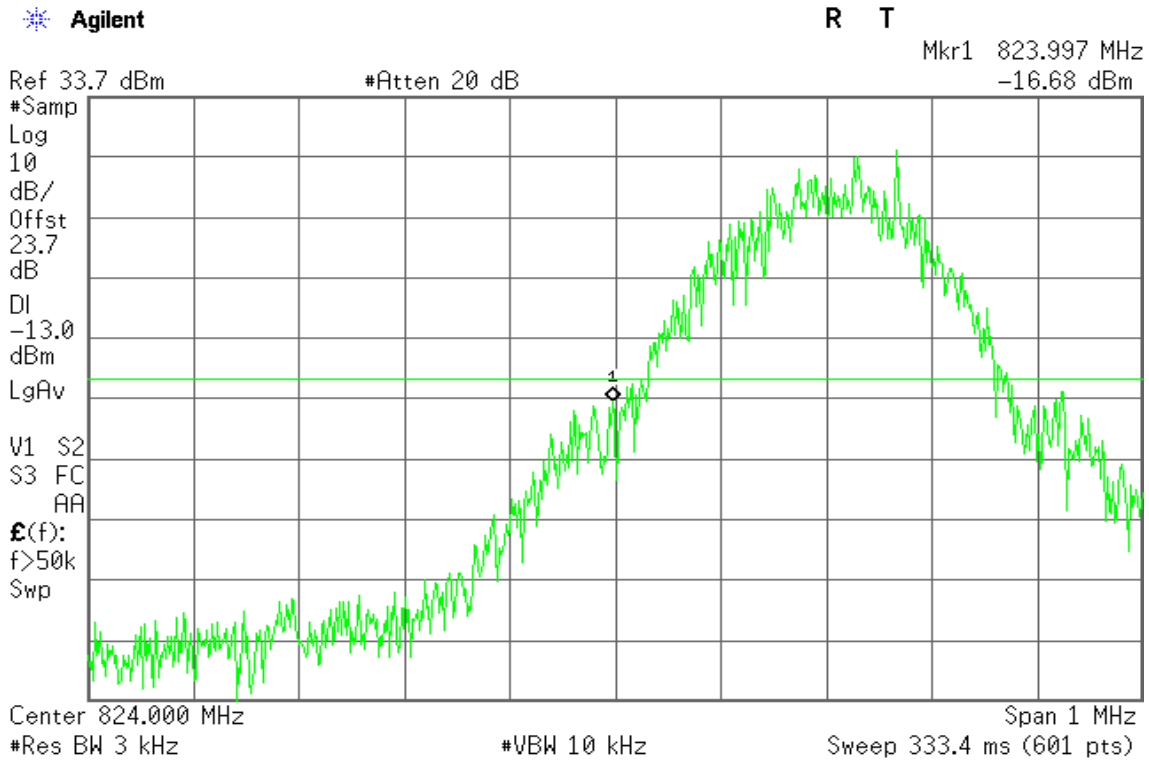
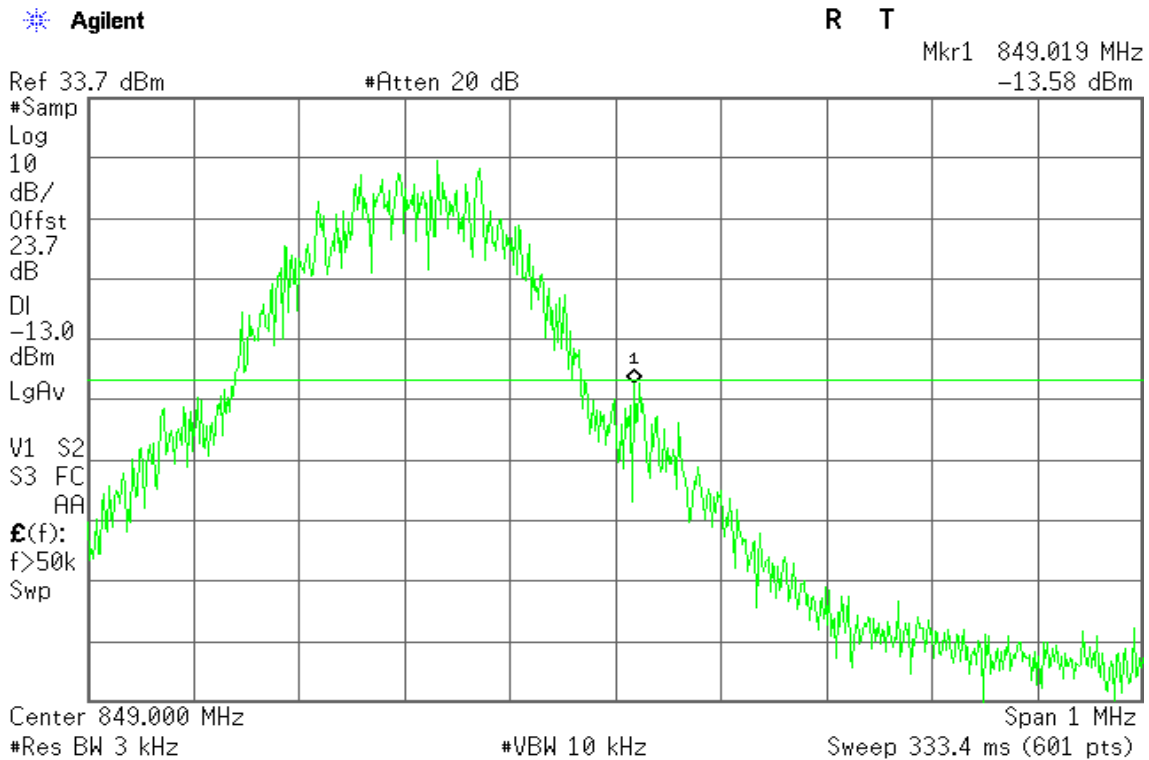

Figure 11-2: Band Edge emissions – GSM CH High





GPRS 850

Figure 12-1: Band Edge emissions – GPRS CH Low

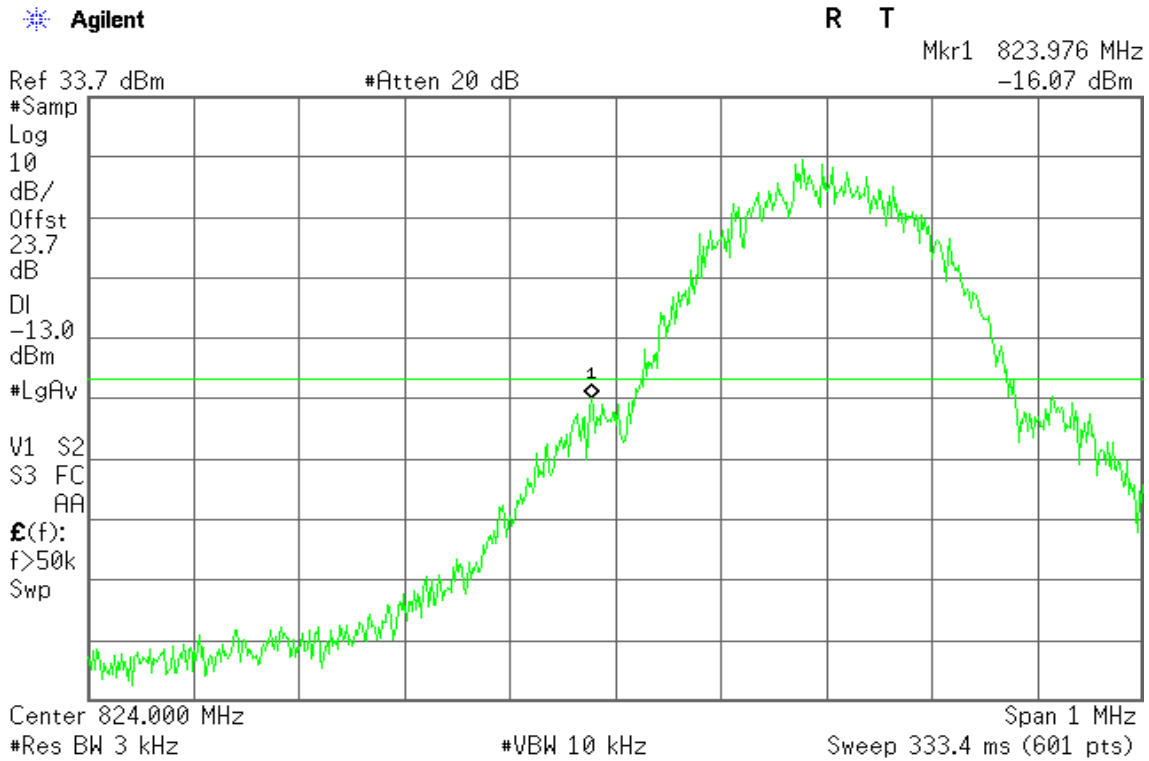
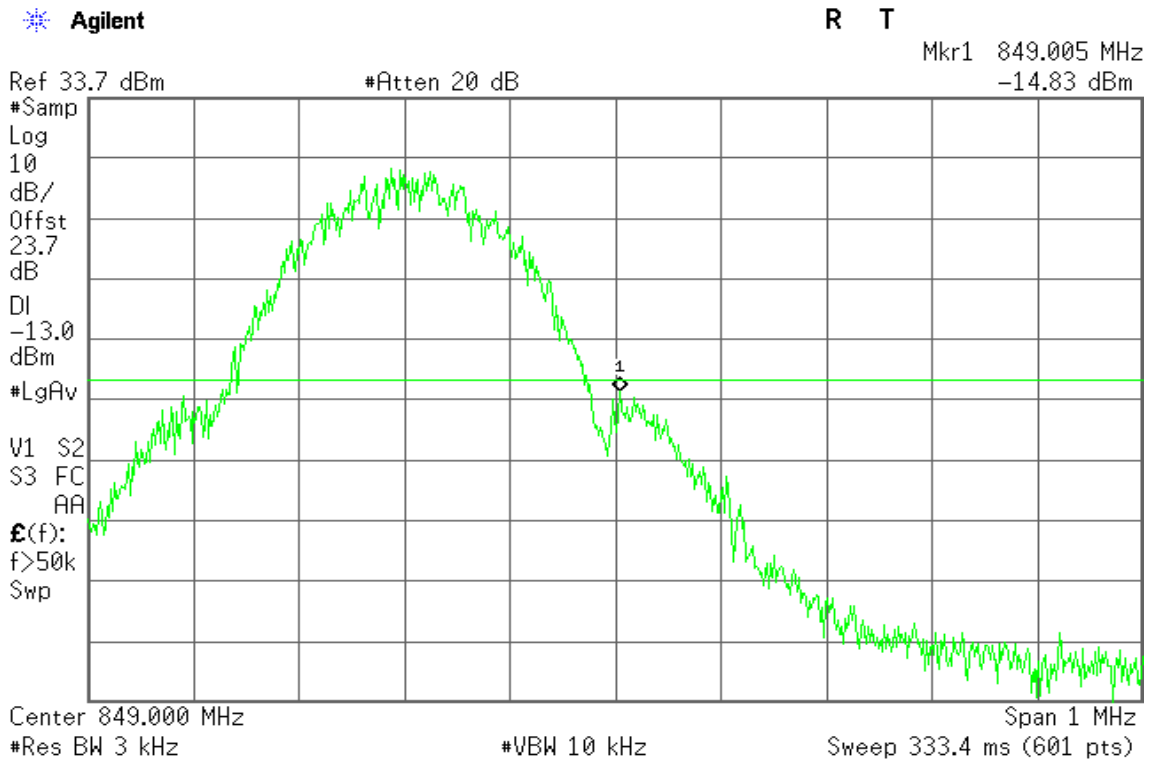

Figure 12-2: Band Edge emissions –GPRS CH High





GSM 1900

Figure 13-1: Band Edge emissions – GSM CH Low

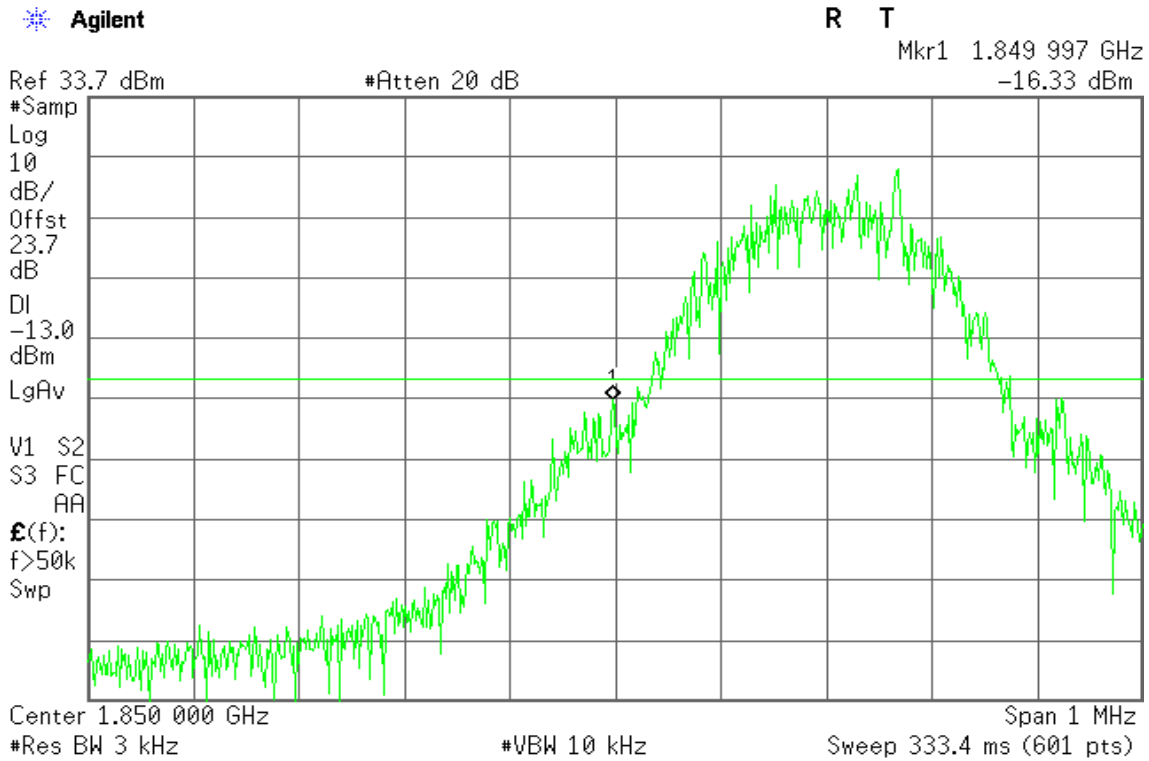
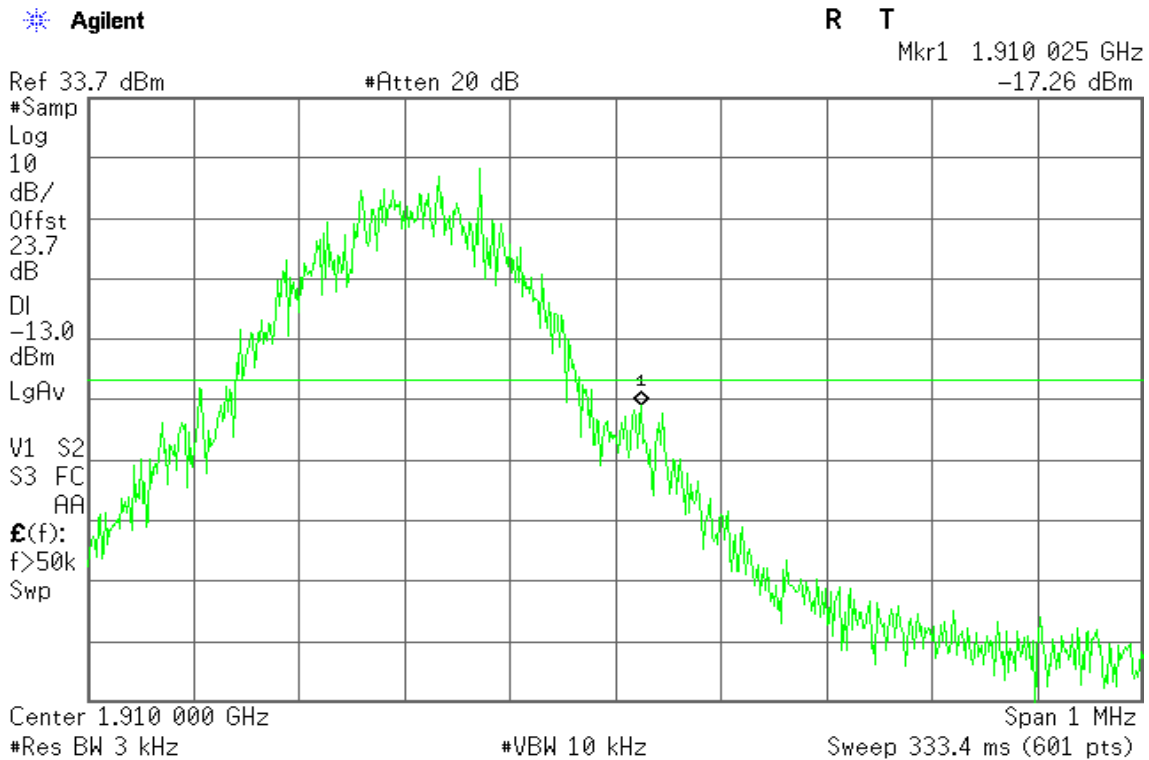

Figure 13-2: Band Edge emissions – GSM CH High





GPRS 1900

Figure 14-1: Band Edge emissions – GPRS CH Low

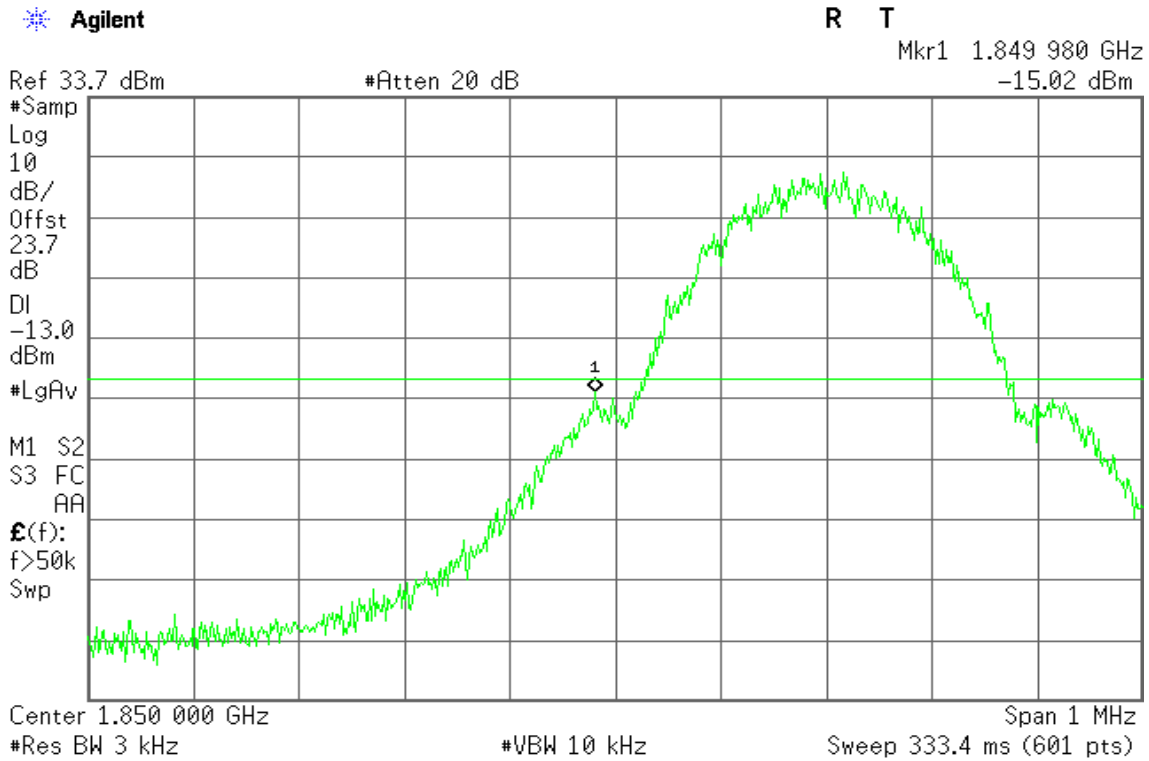
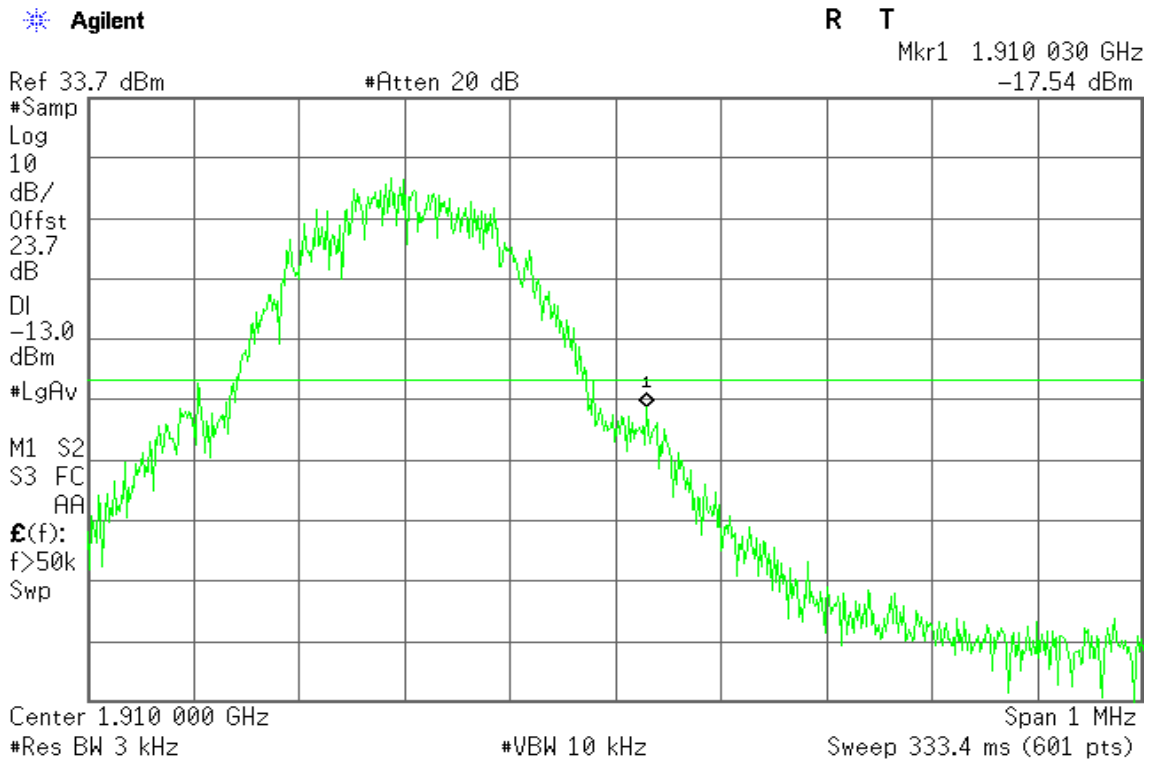

Figure 14-2: Band Edge emissions – GPRS CH High





EDGE 850

Figure 15-1: Out of Band emission at antenna terminals –EDGE CH Low

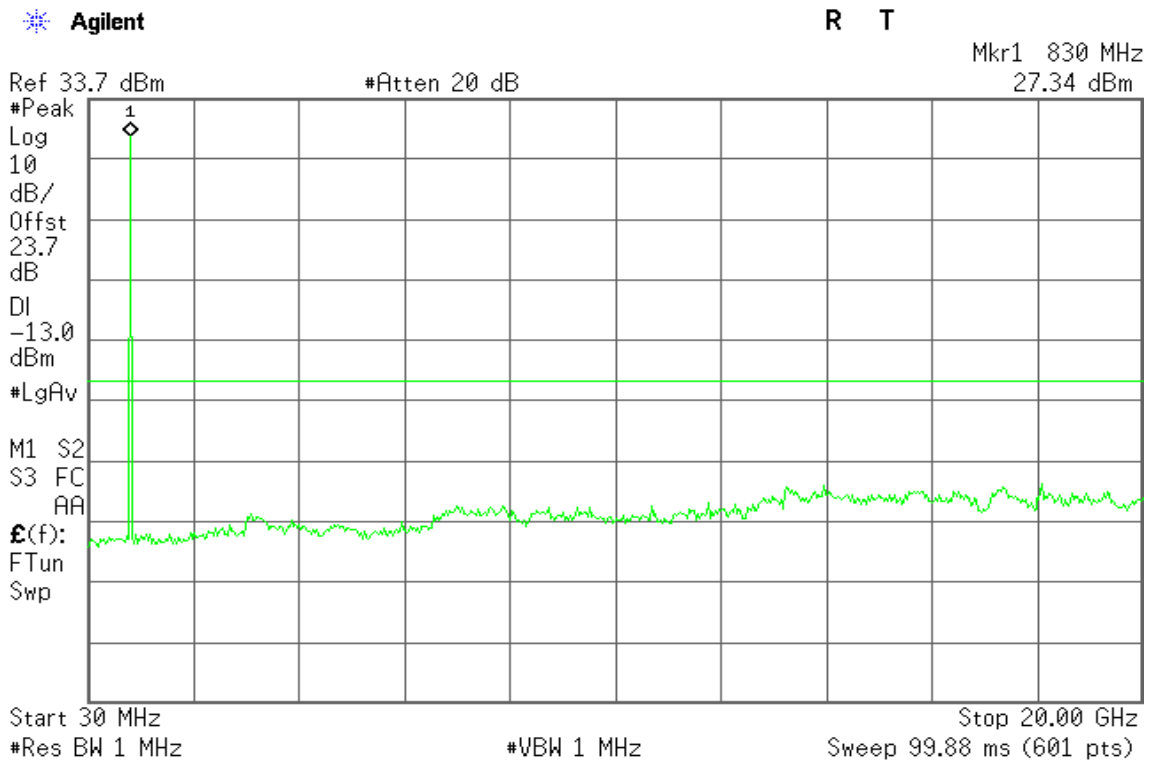

Figure 15-2: Out of Band emission at antenna terminals –EDGE CH Mid

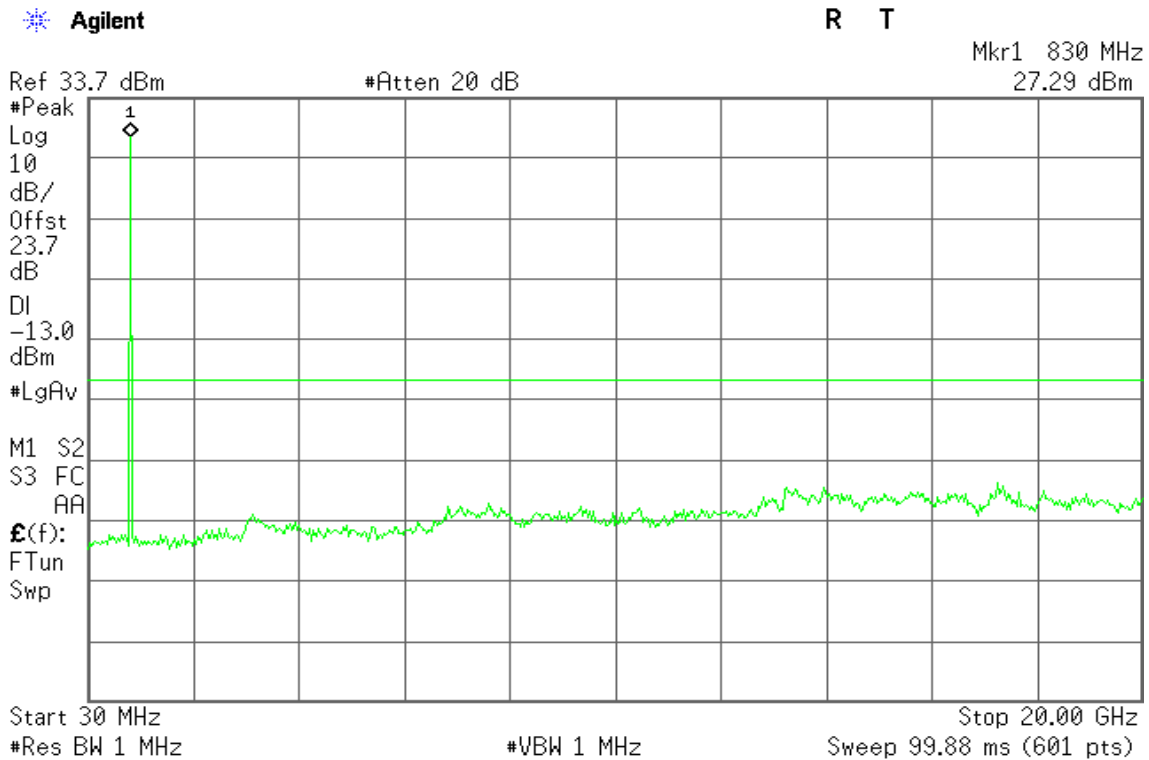
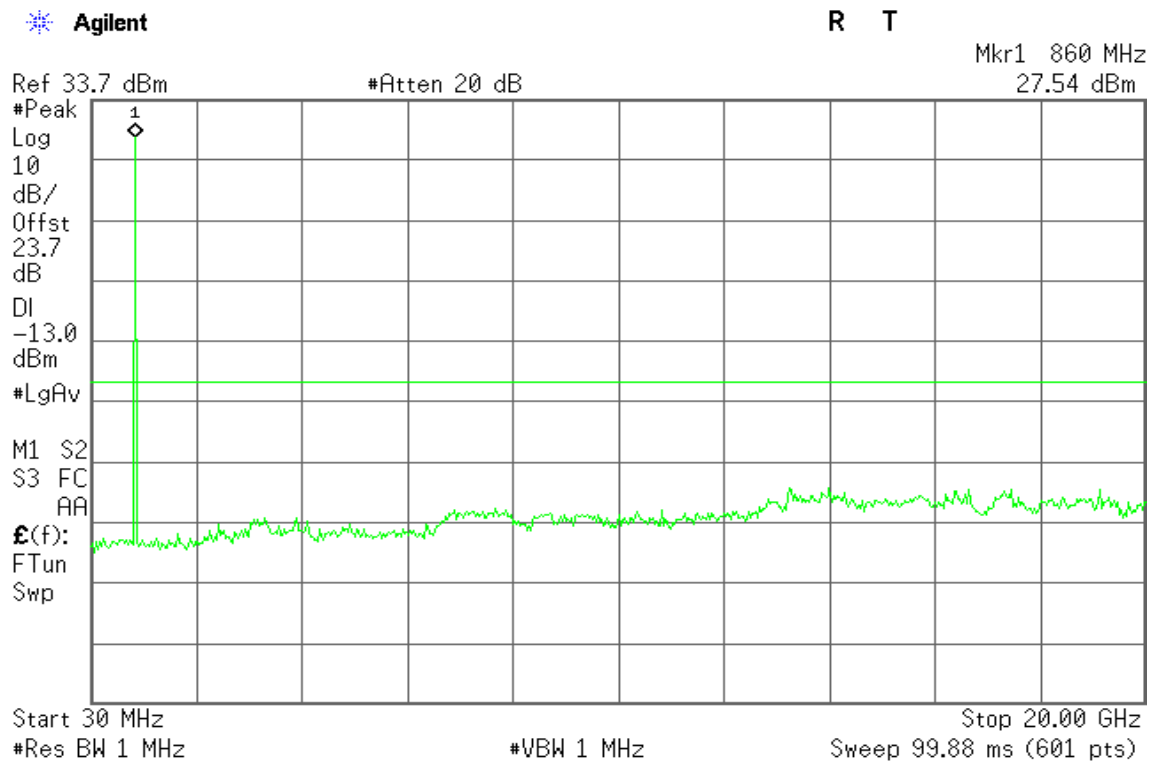



Figure 15-3: Out of Band emission at antenna terminals –EDGE CH High





EDGE 1900

Figure 16-1: Out of Band emission at antenna terminals –EDGE CH Low

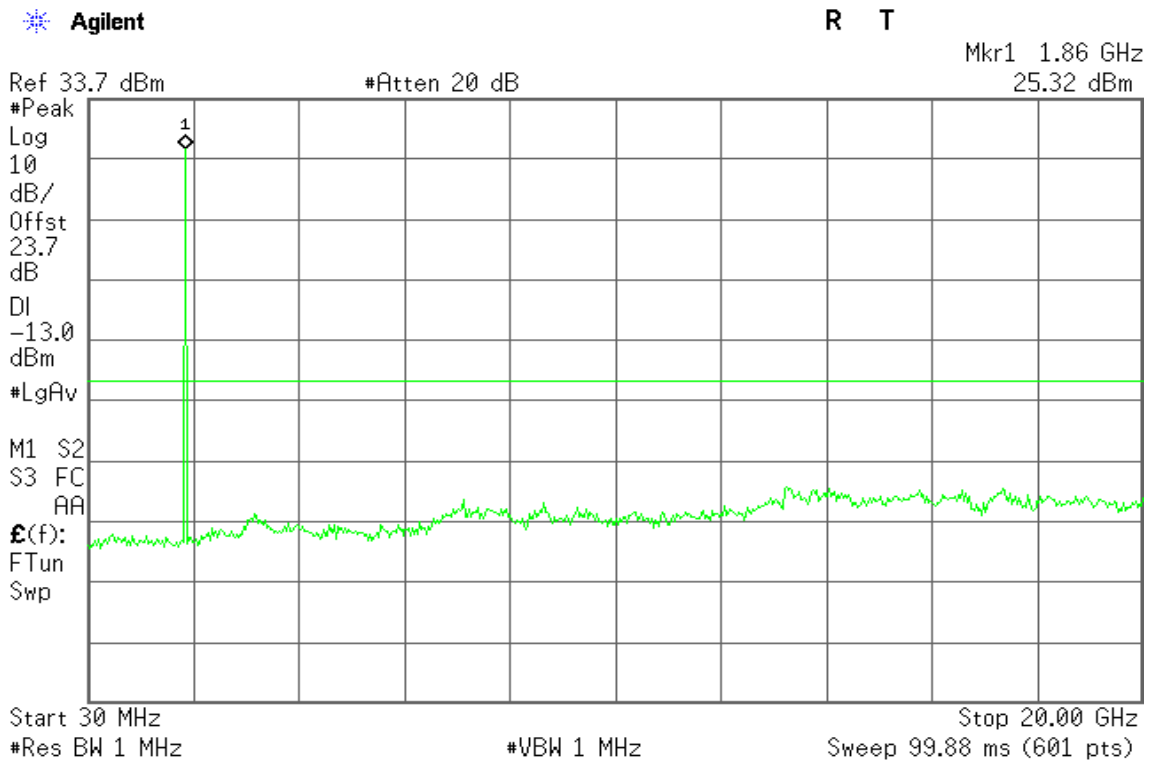

Figure 16-2: Out of Band emission at antenna terminals –EDGE CH Mid

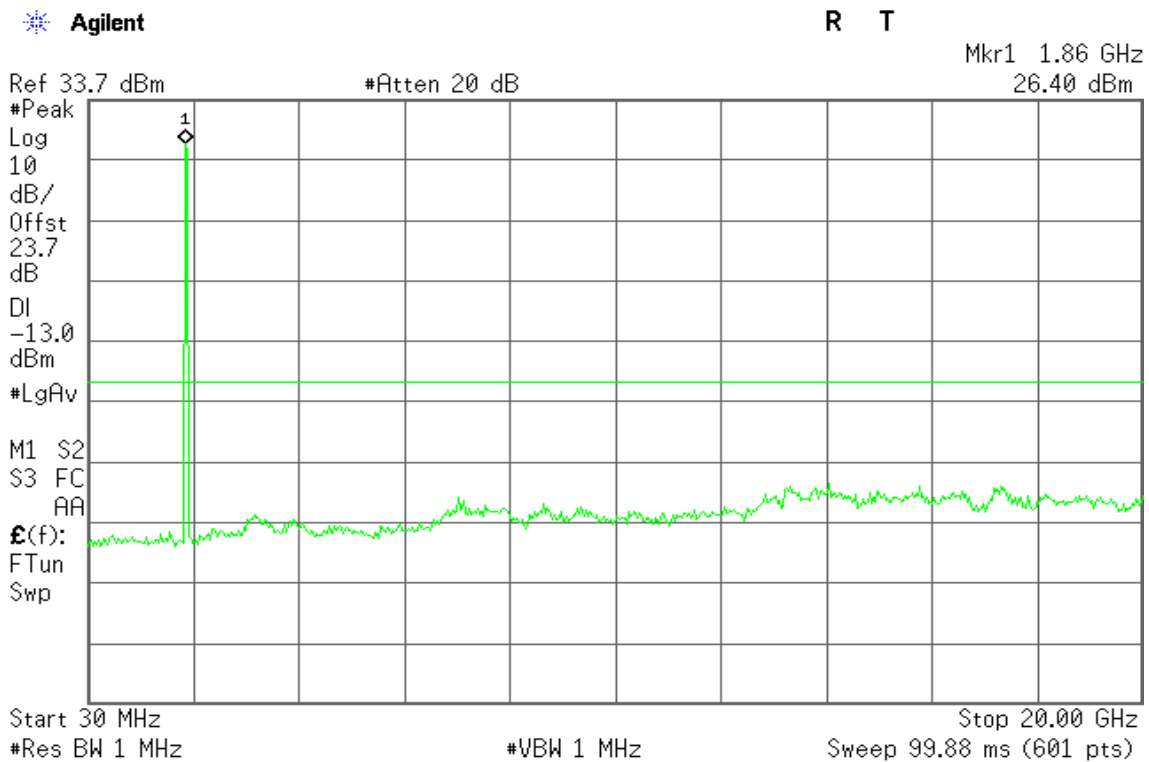
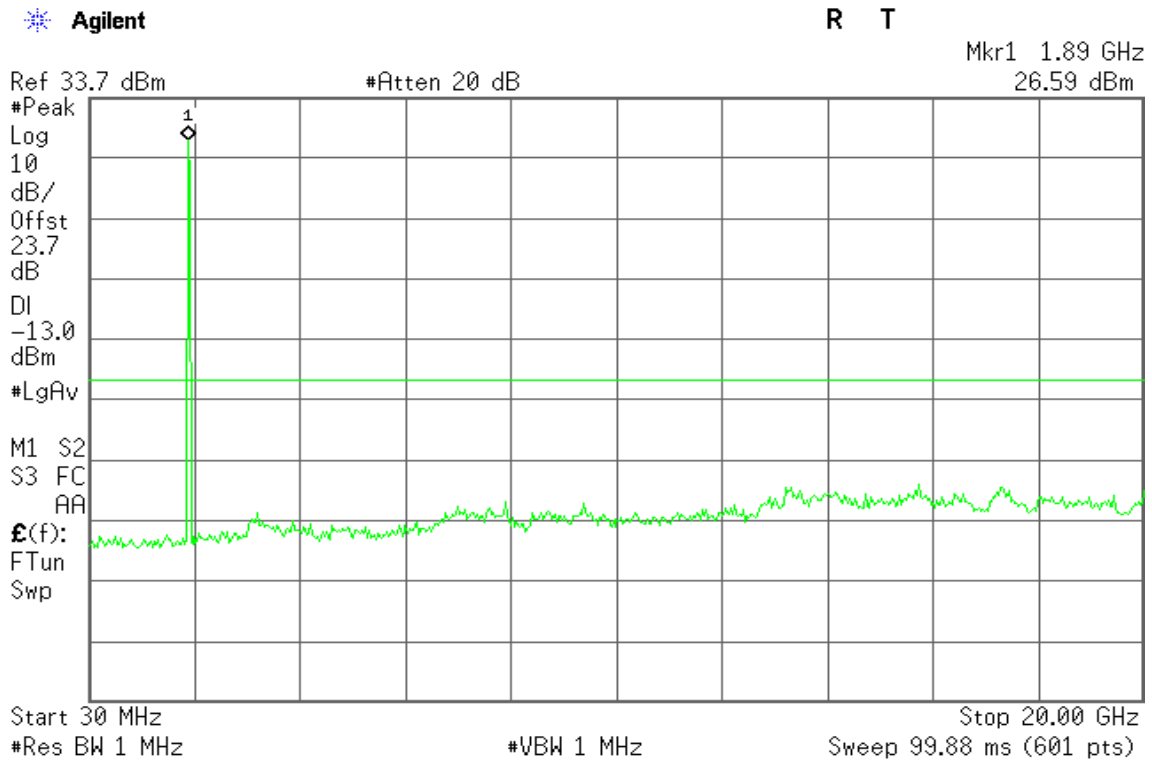



Figure 16-3: Out of Band emission at antenna terminals –EDGE CH High





EDGE 850

Figure 17-1: Band Edge emissions – EDGE CH Low

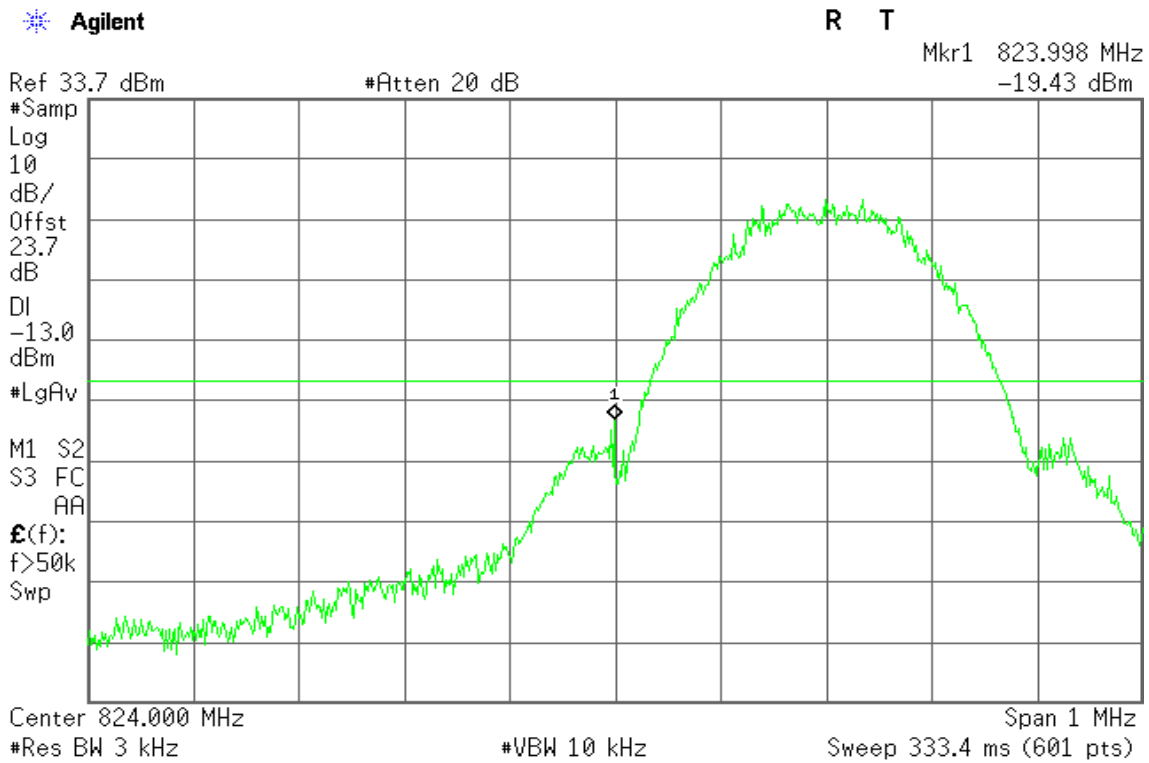
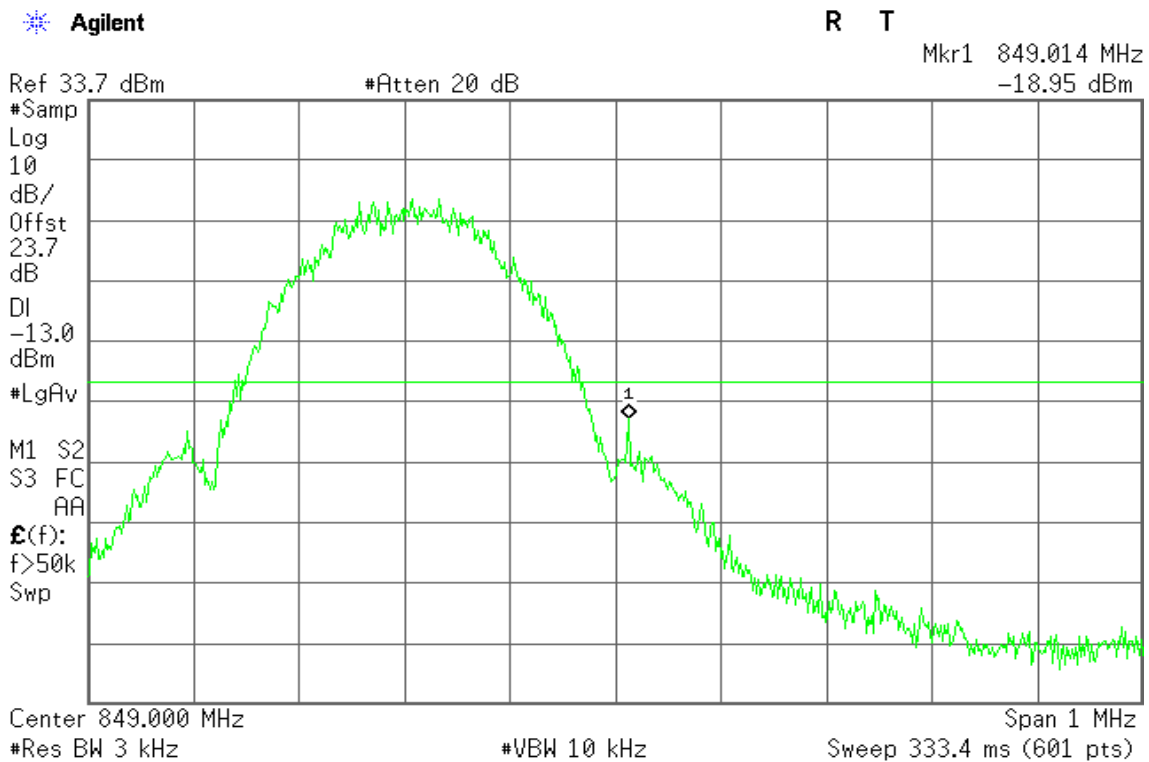

Figure 17-2: Band Edge emissions – EDGE CH High





EDGE 1900

Figure 18-1: Band Edge emissions – EDGE CH Low

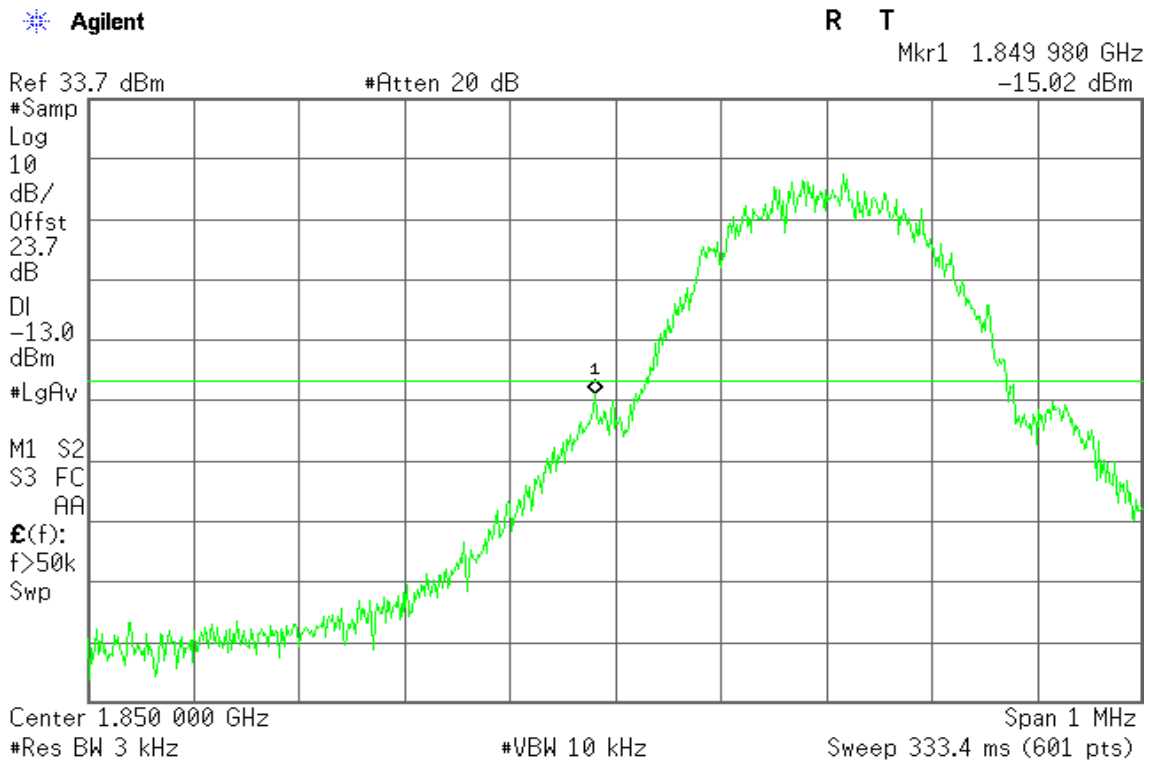
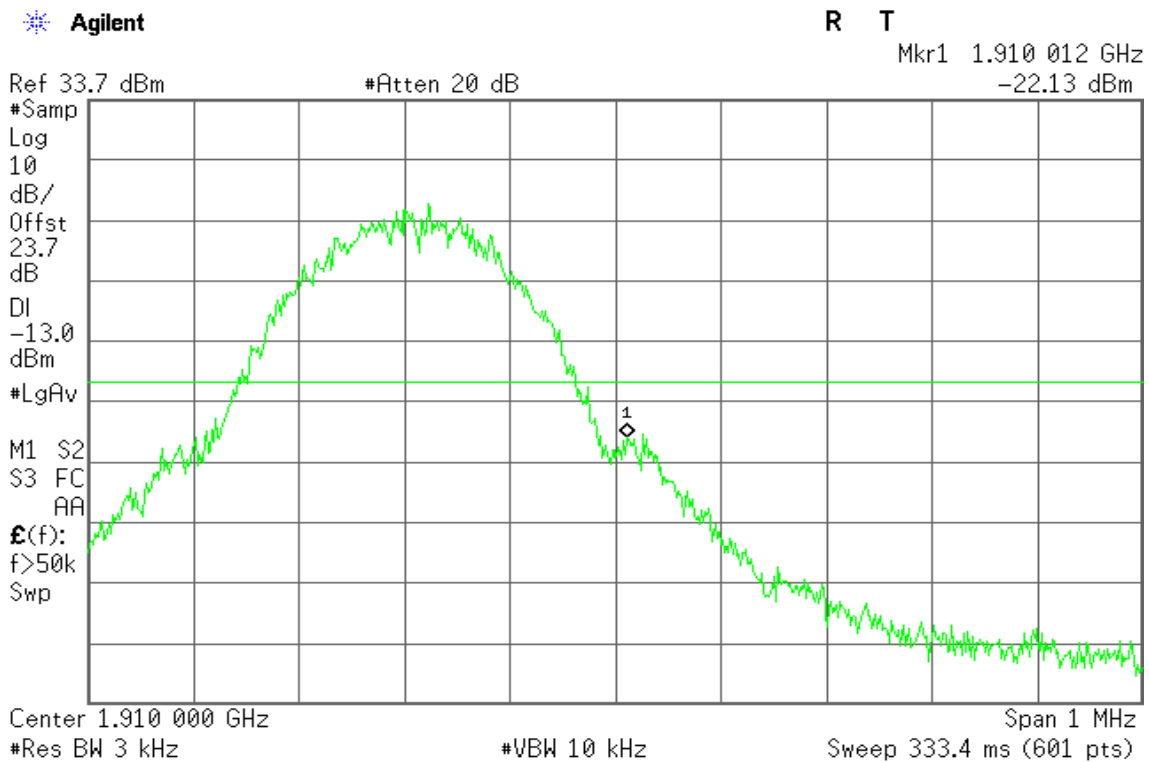

Figure 18-2: Band Edge emissions – EDGE CH High





WCDMA Band II

Figure 19-1: Out of Band emission at antenna terminals – WCDMA CH Low

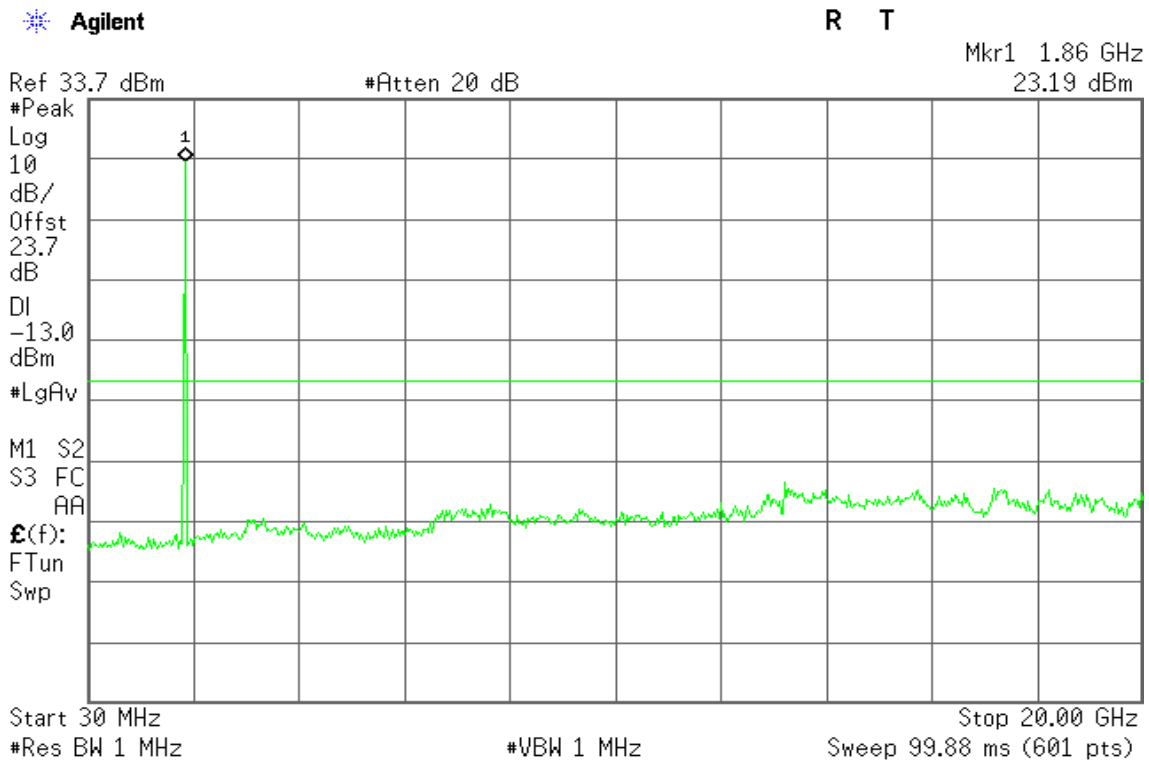

Figure 19-2: Out of Band emission at antenna terminals – WCDMA CH Mid

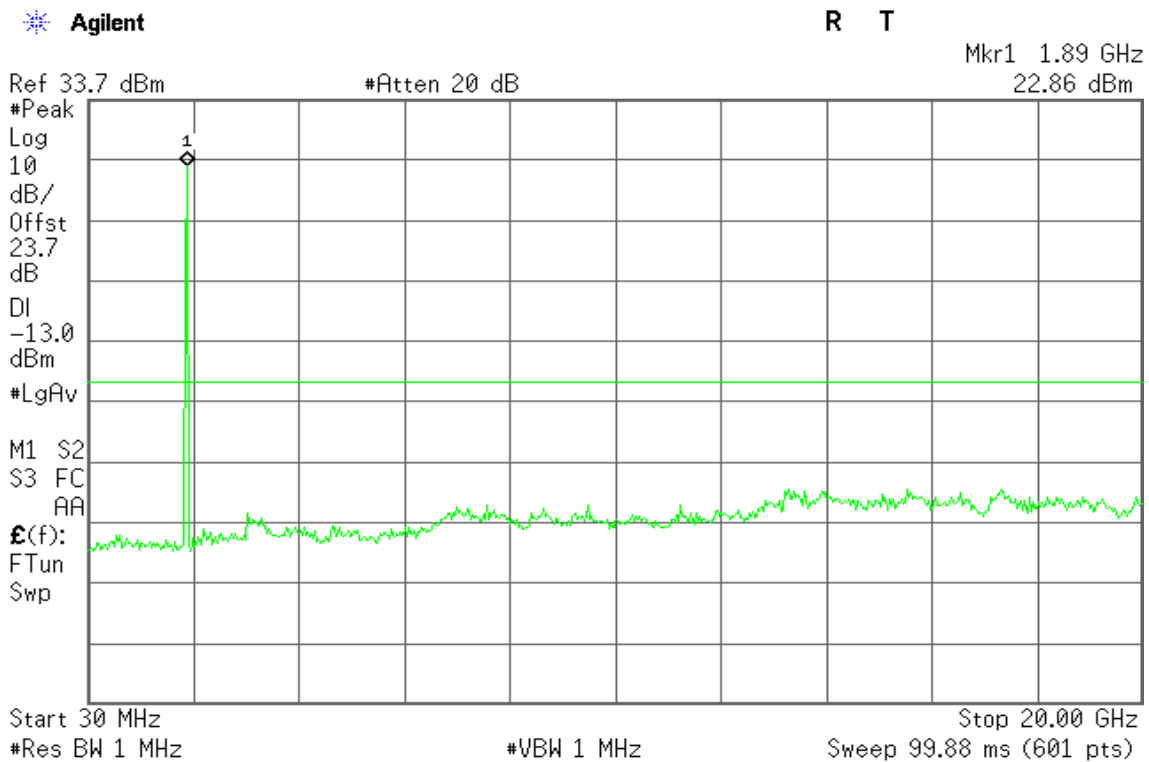
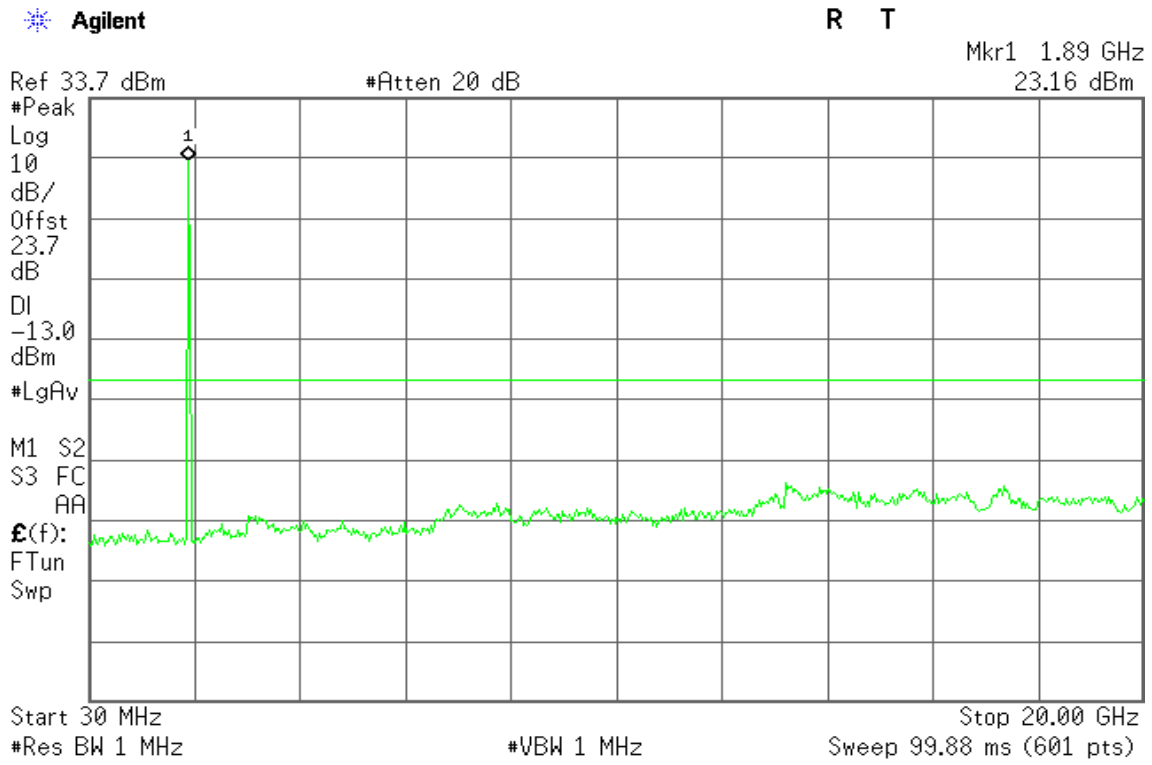



Figure 19-3: Out of Band emission at antenna terminals – WCDMA CH High





WCDMA Band V

Figure 20-1: Out of Band emission at antenna terminals – WCDMA CH Low

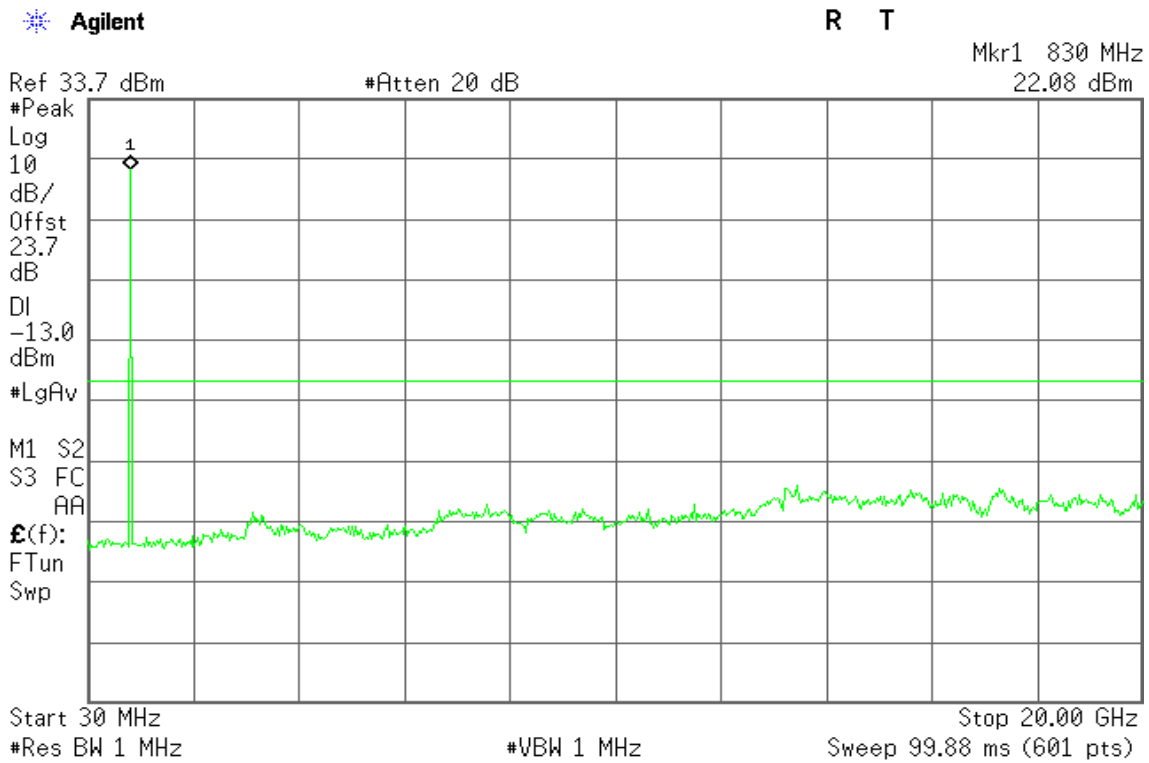

Figure 20-2: Out of Band emission at antenna terminals – WCDMA CH Mid

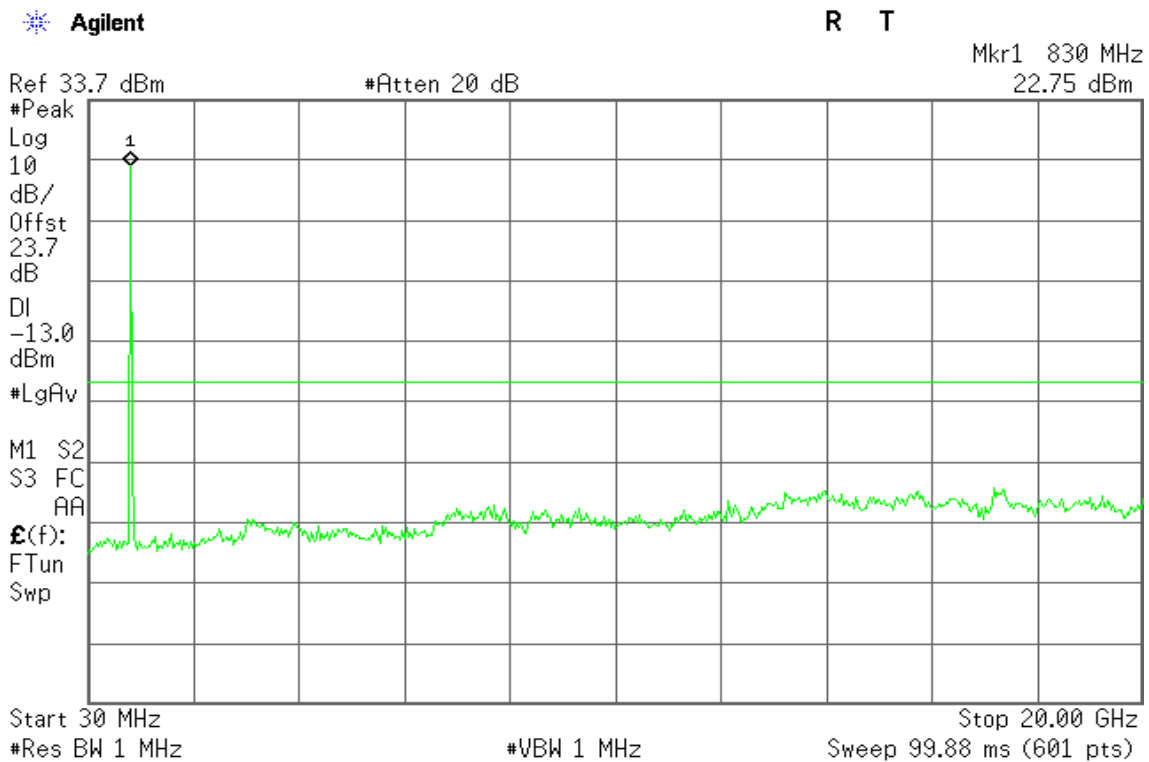
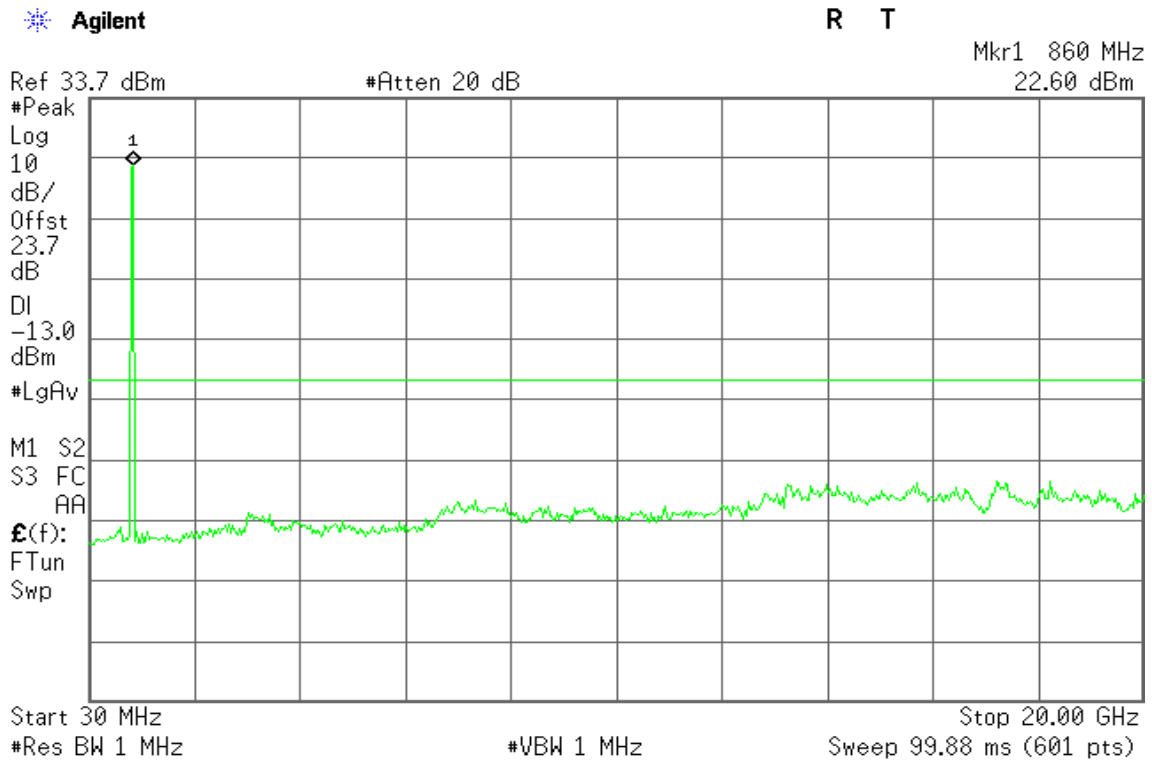



Figure 20-3: Out of Band emission at antenna terminals – WCDMA CH High





WCDMA Band II

Figure 21-1: Band Edge emissions – WCDMA CH Low

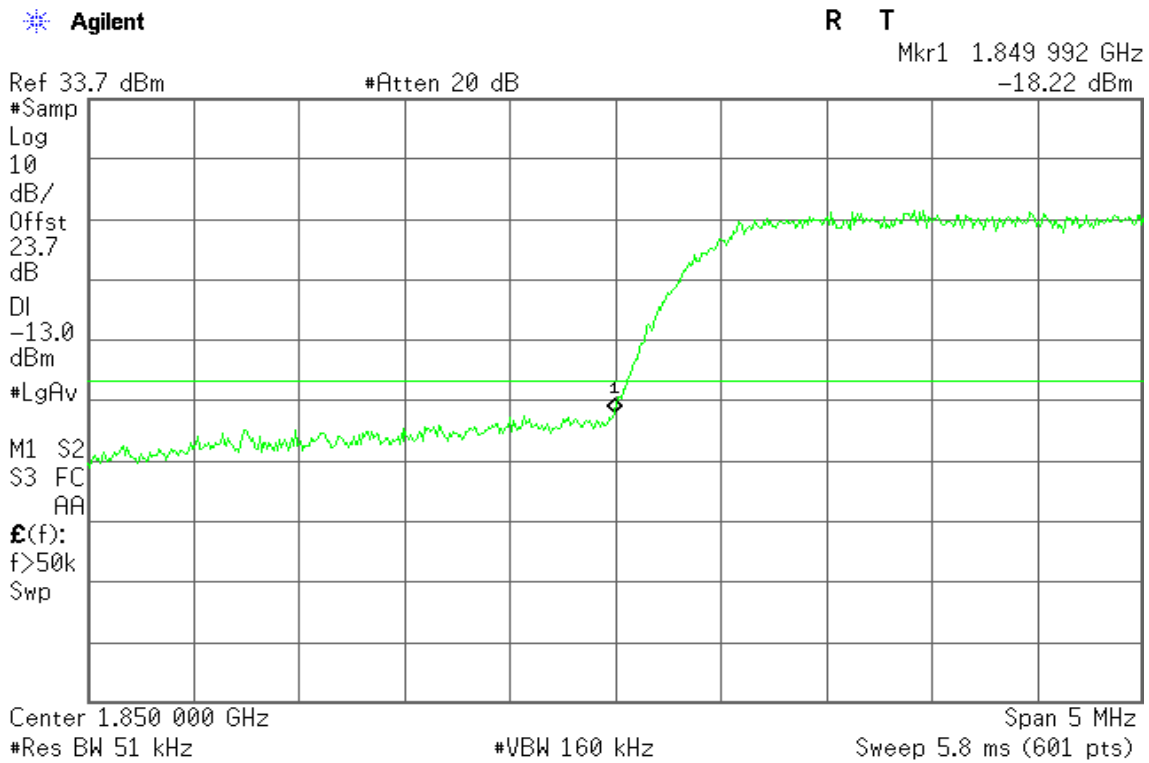
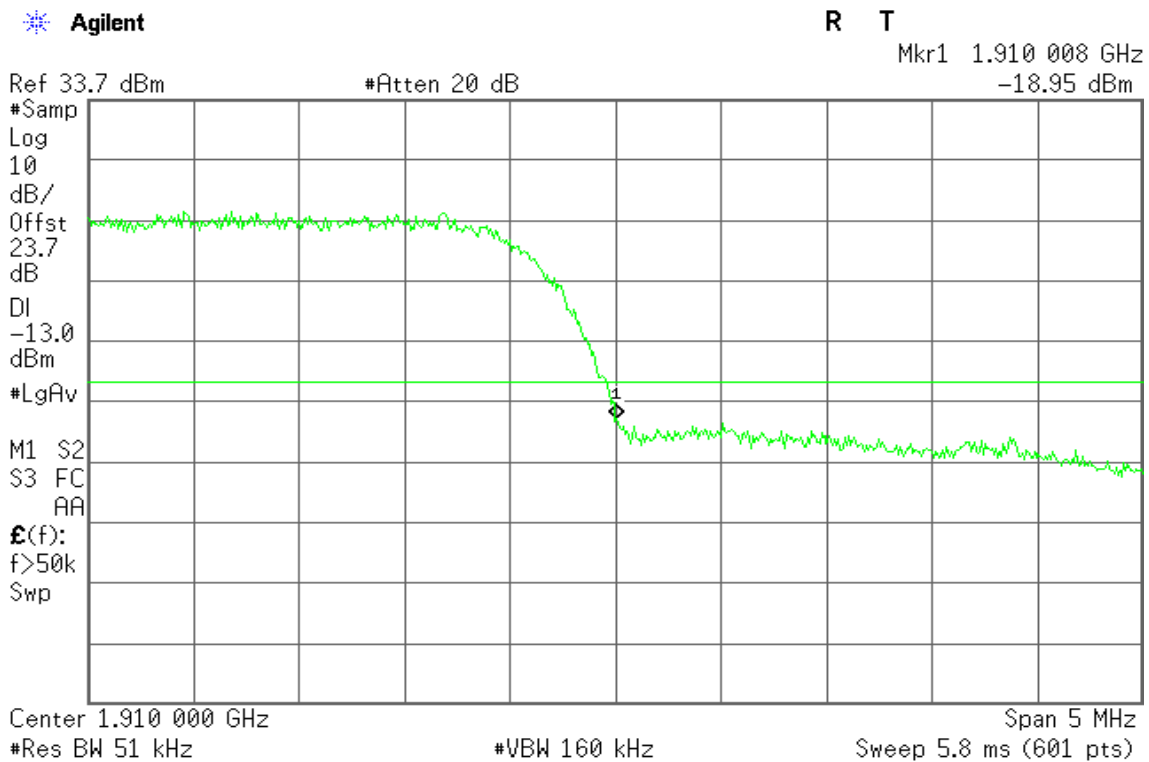

Figure 21-2: Band Edge emissions –WCDMA CH High





WCDMA Band V

Figure 22-1: Band Edge emissions –WCDMA CH Low

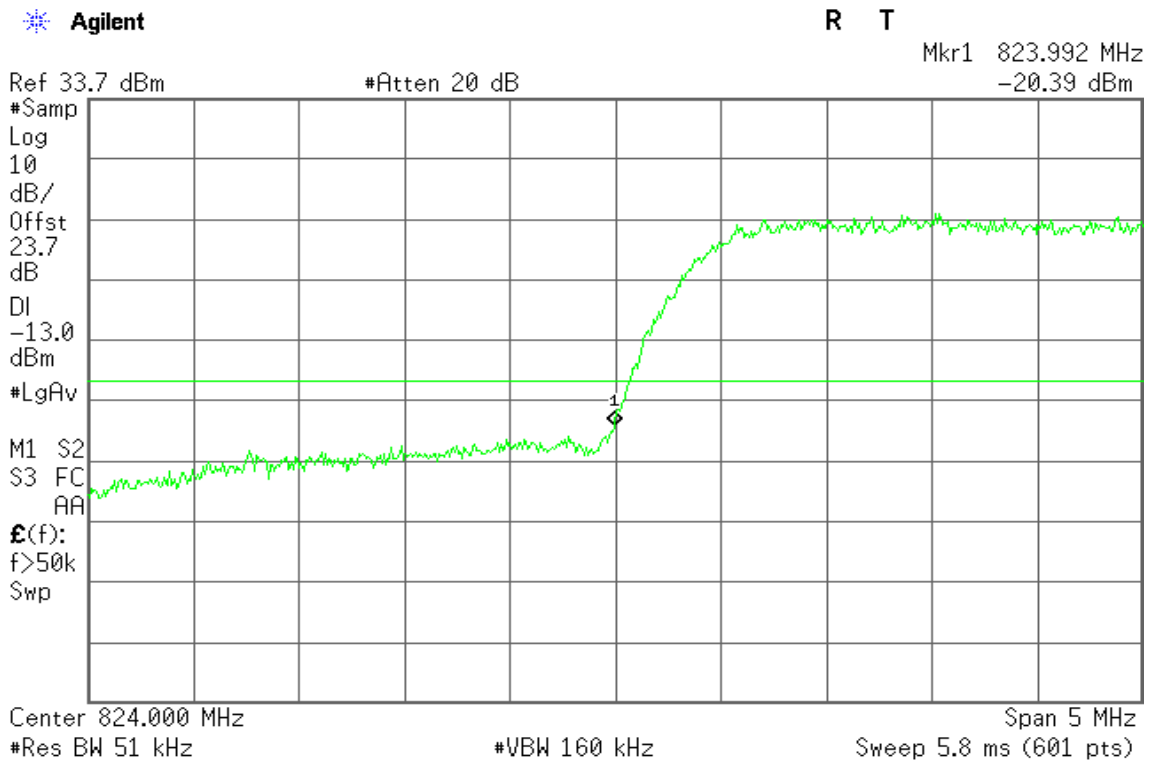
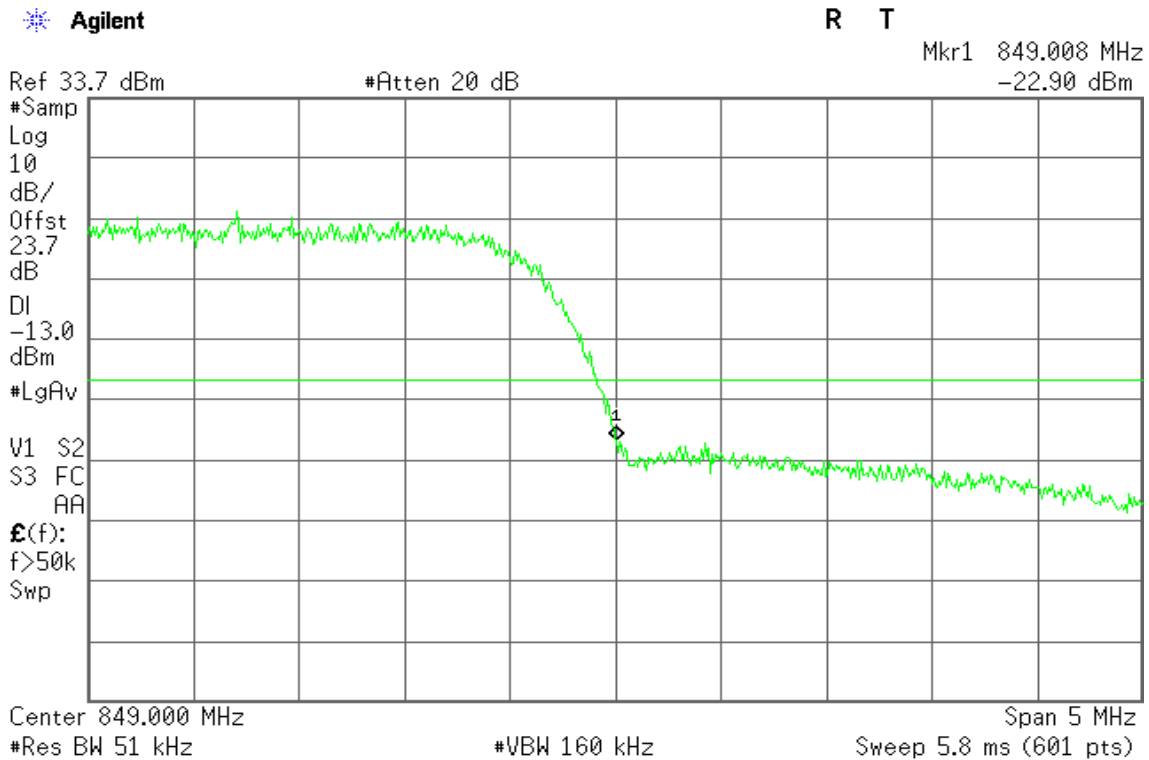

Figure 22-2: Band Edge emissions –WCDMA CH High





WCDMA / HSDPA Band II

Figure 23-1: Out of Band emission at antenna terminals – HSDPA CH Low

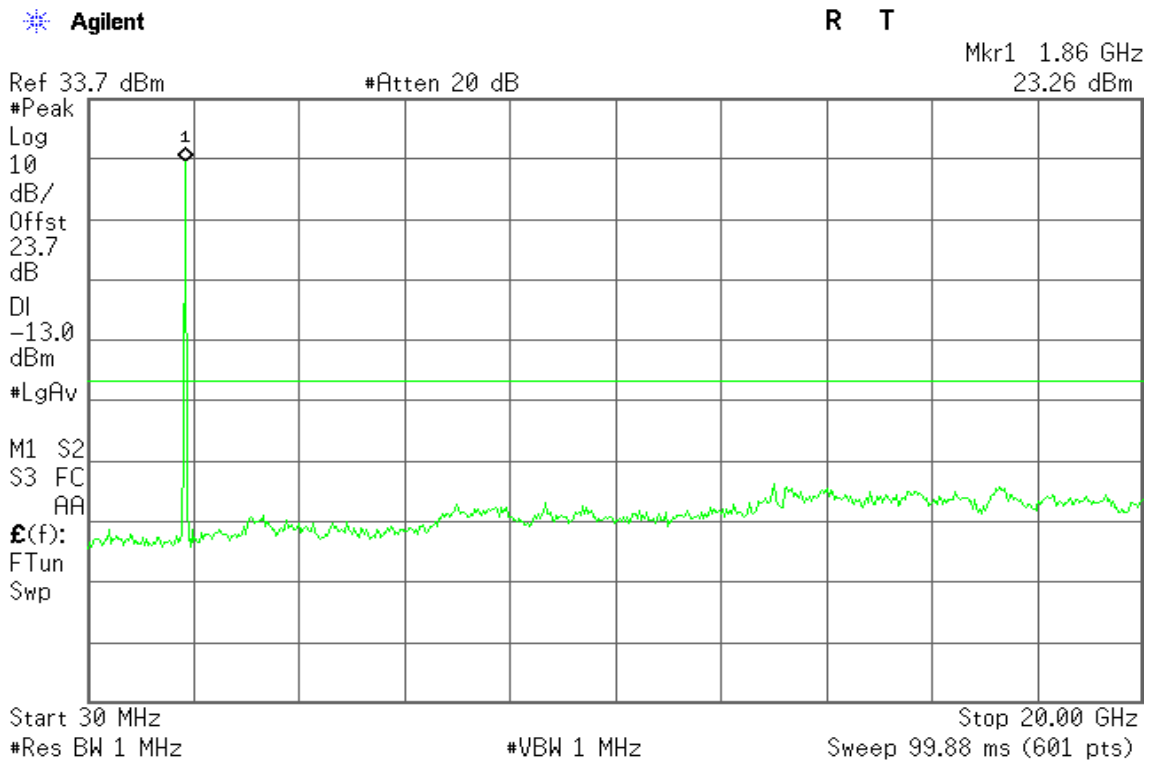

Figure 23-2: Out of Band emission at antenna terminals – HSDPA CH Mid

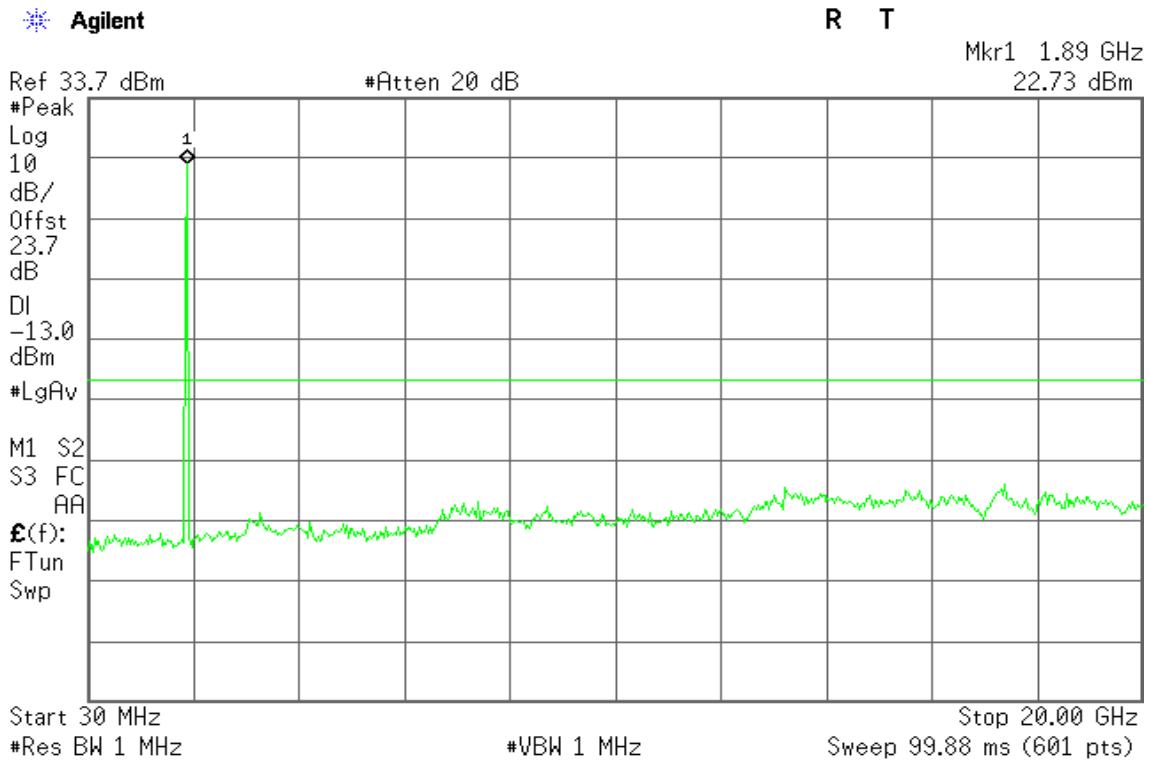
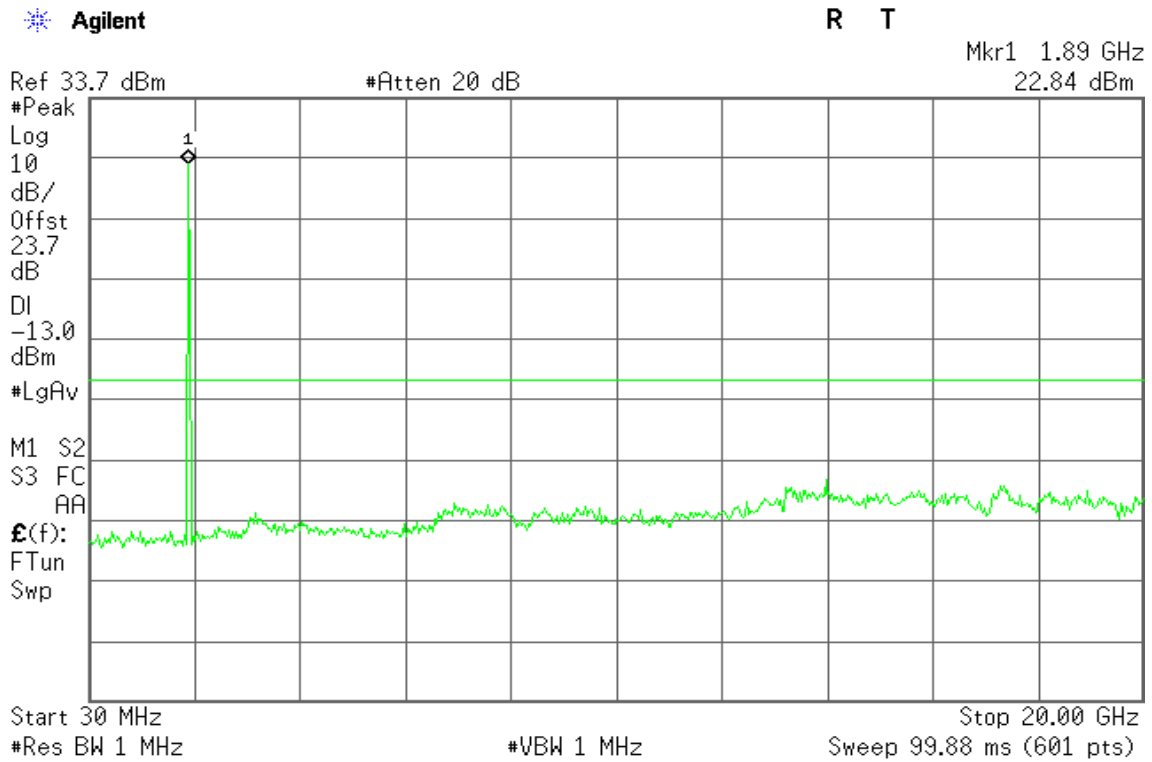



Figure 23-3: Out of Band emission at antenna terminals – HSDPA CH High





WCDMA / HSDPA Band V

Figure 21-1: Out of Band emission at antenna terminals – HSDPA CH Low

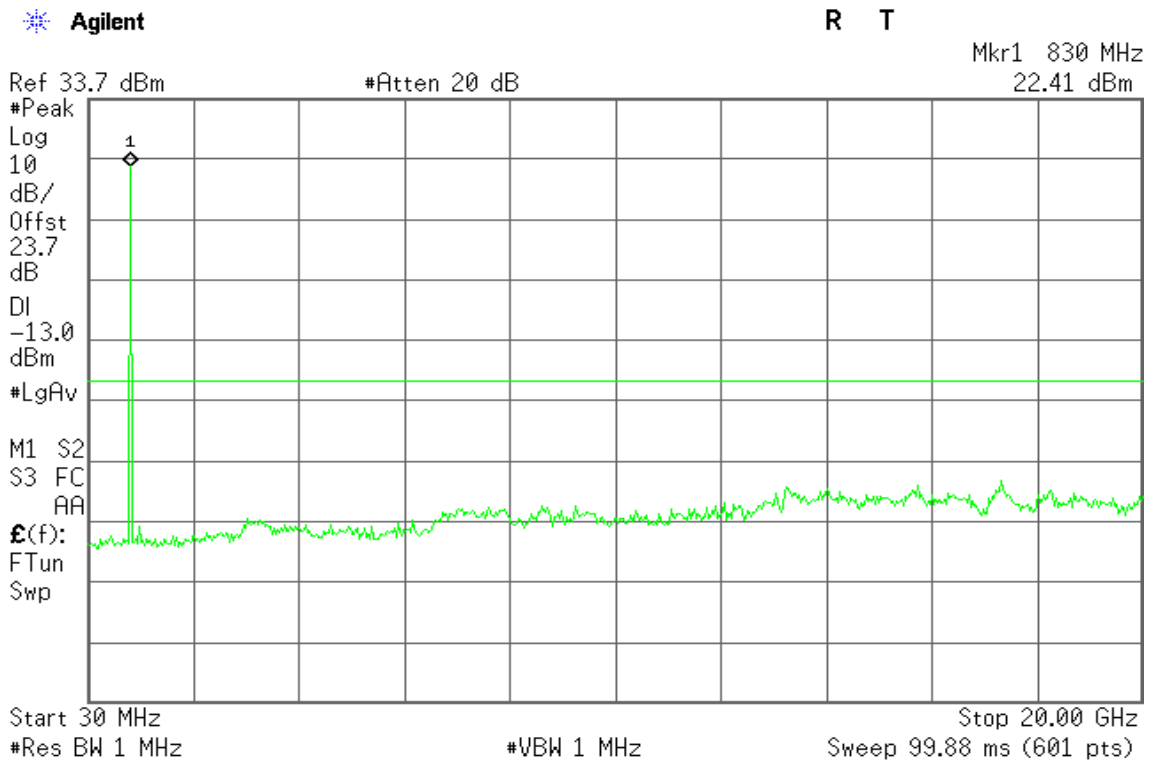

Figure 24-2: Out of Band emission at antenna terminals – HSDPA CH Mid

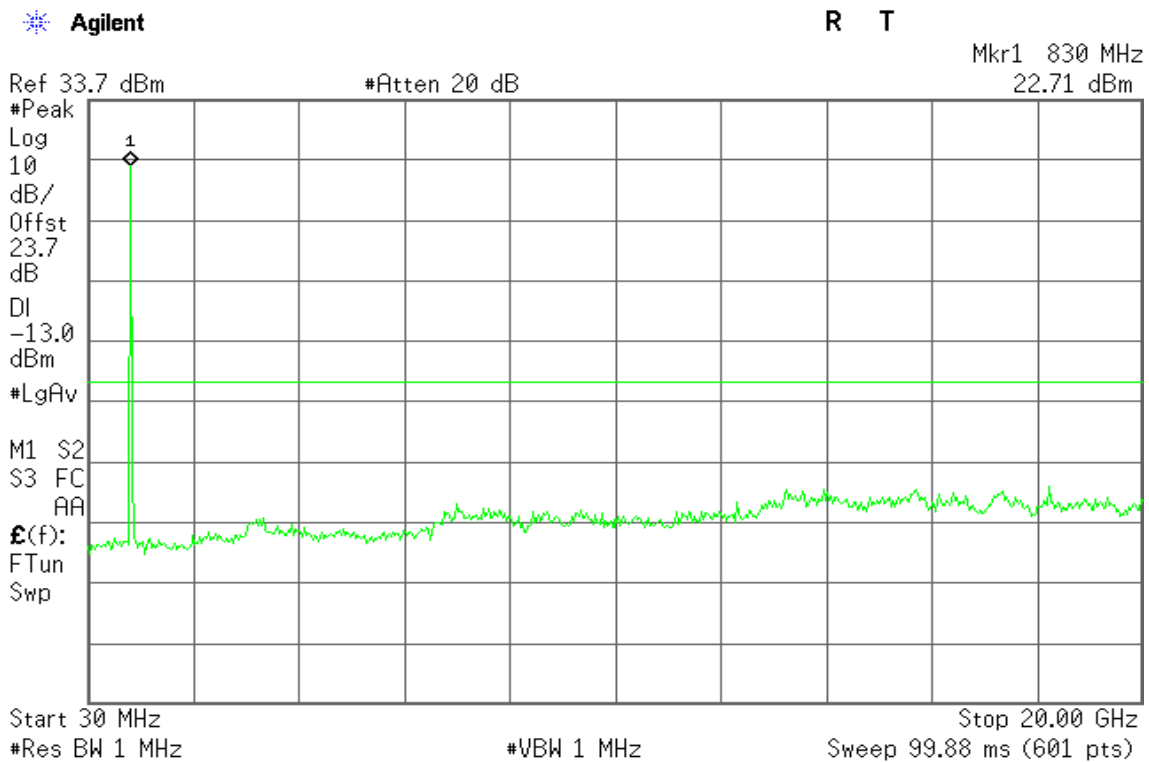
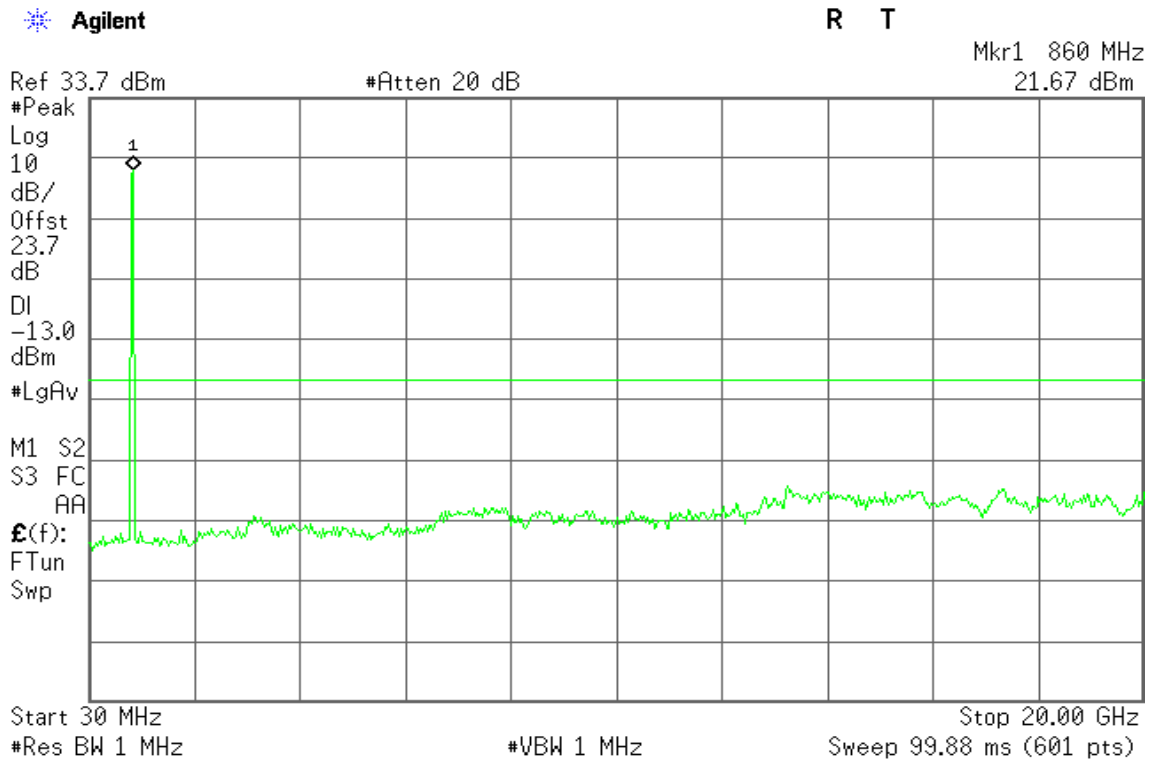



Figure 24-3: Out of Band emission at antenna terminals – HSDPA CH High





WCDMA / HSDPA Band II

Figure 25-1: Band Edge emissions – HSDPA CH Low

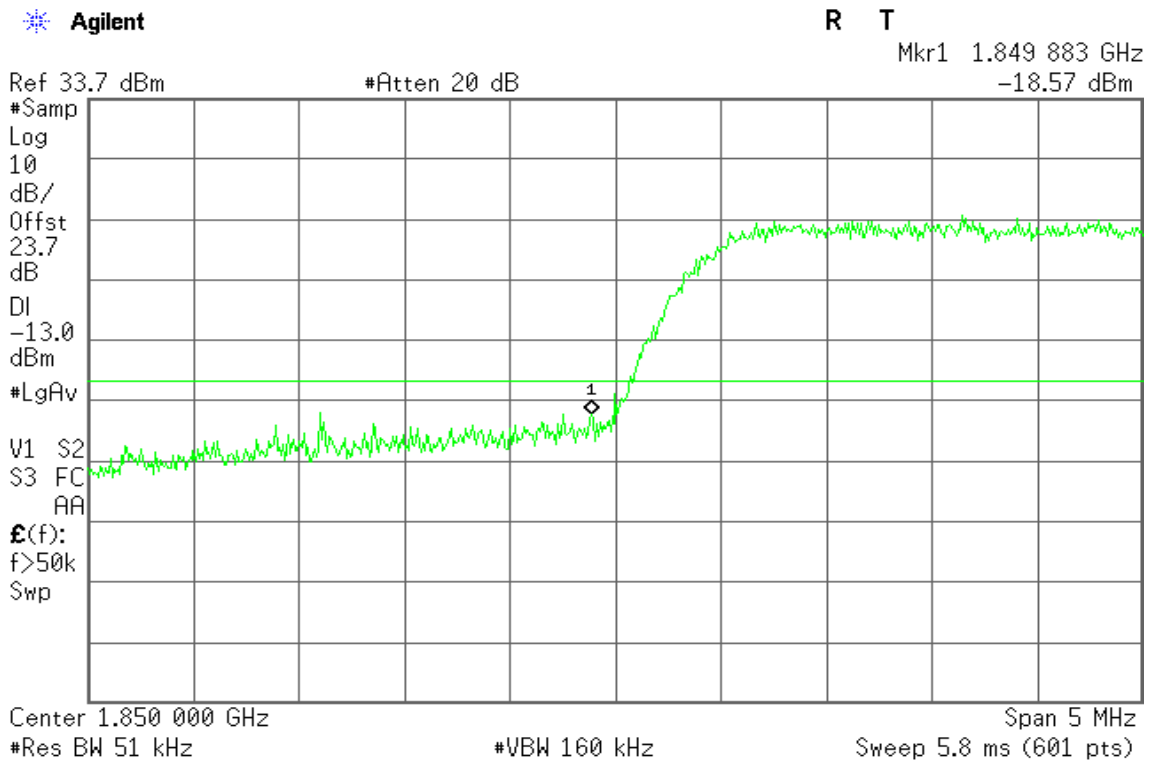
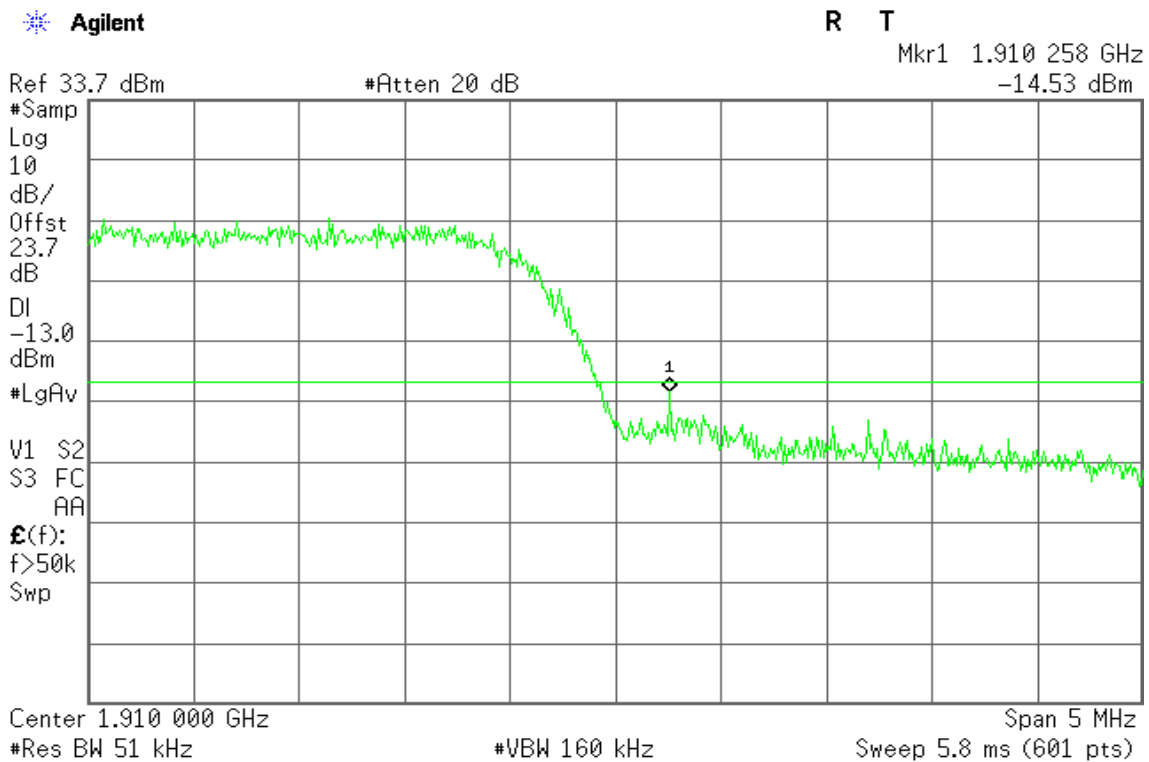

Figure 25-2: Band Edge emissions – HSDPA CH High





WCDMA / HSDPA Band V

Figure 26-1: Band Edge emissions – HSDPA CH Low

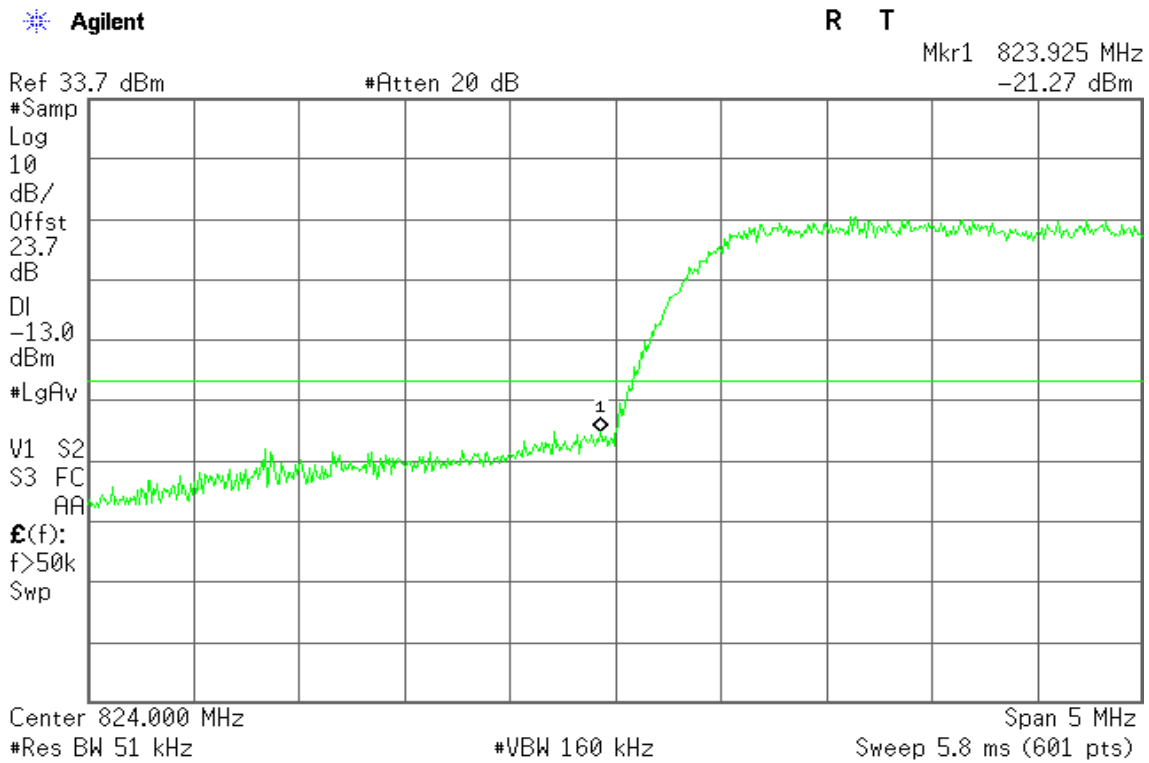
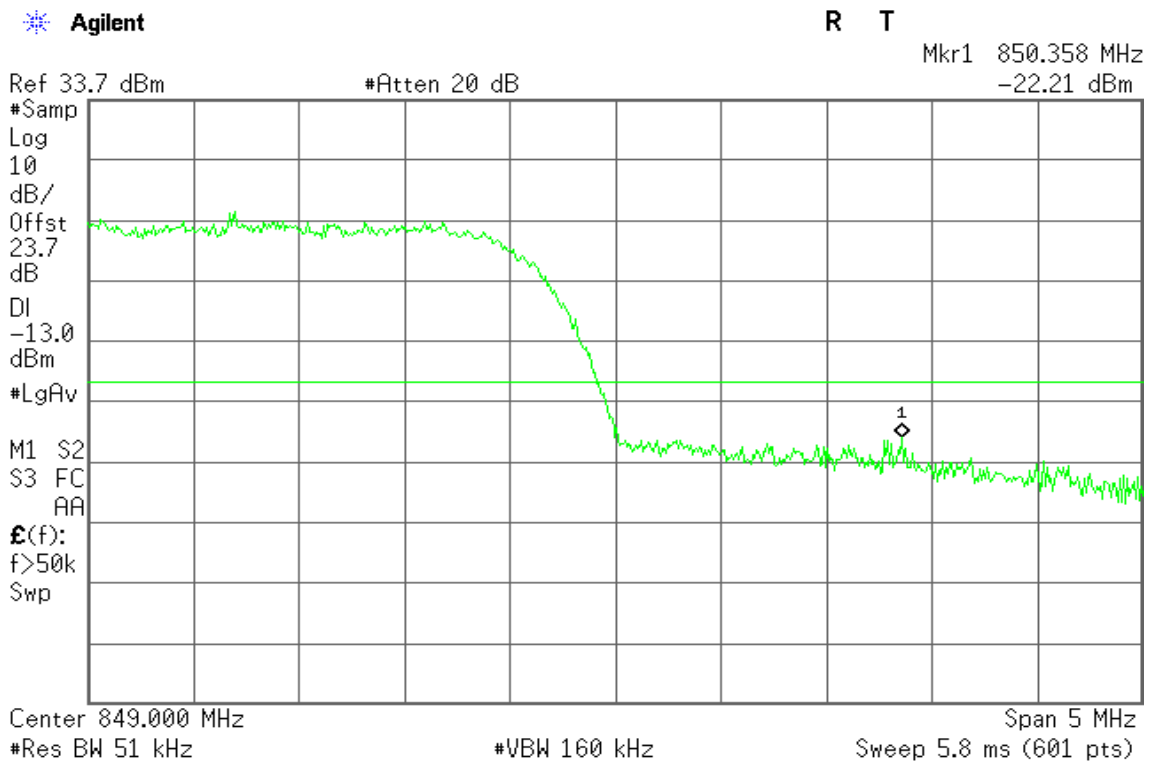

Figure 26-2: Band Edge emissions – HSDPA CH High





WCDMA / HSUPA Band II

Figure 27-1: Out of Band emission at antenna terminals – HSUPA CH Low

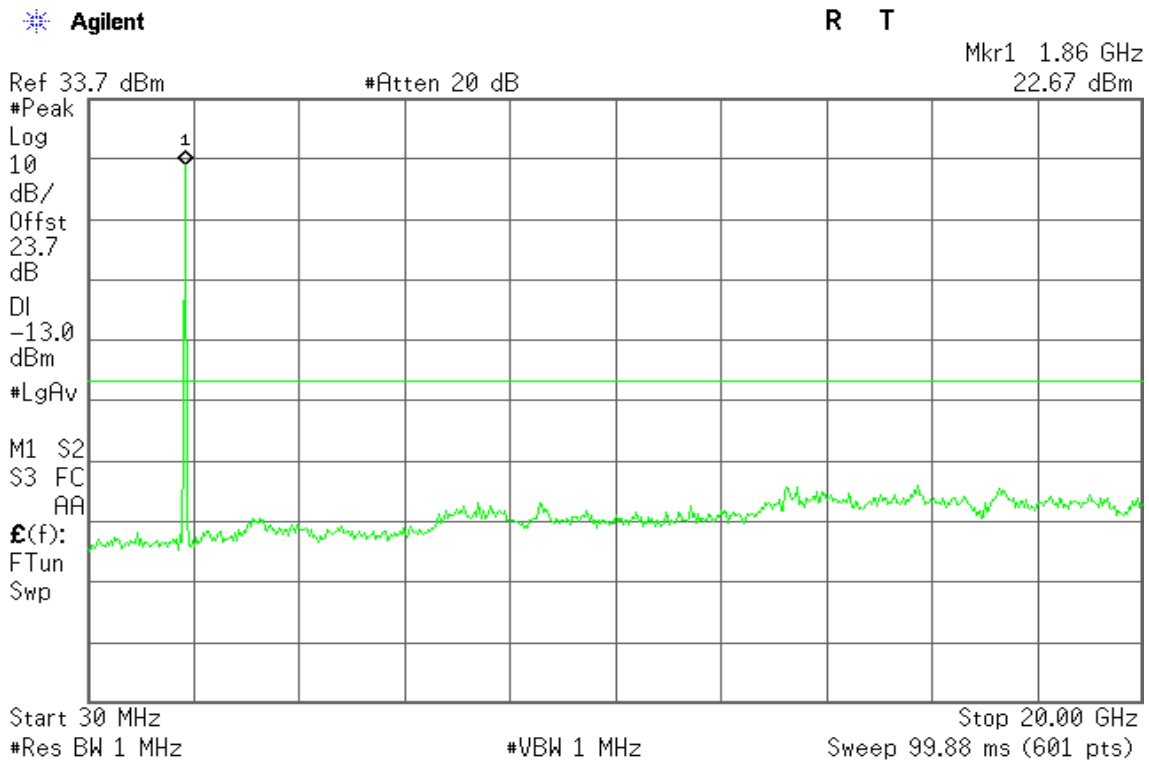

Figure 27-2: Out of Band emission at antenna terminals – HSUPA CH Mid

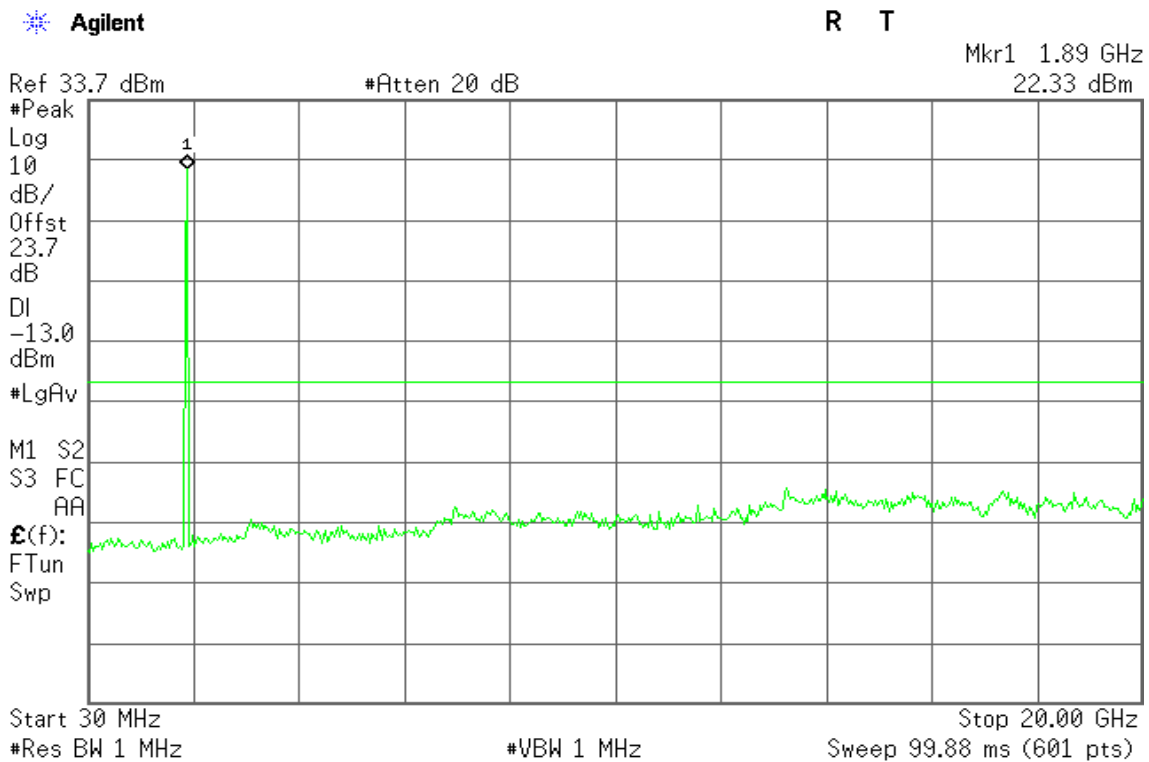
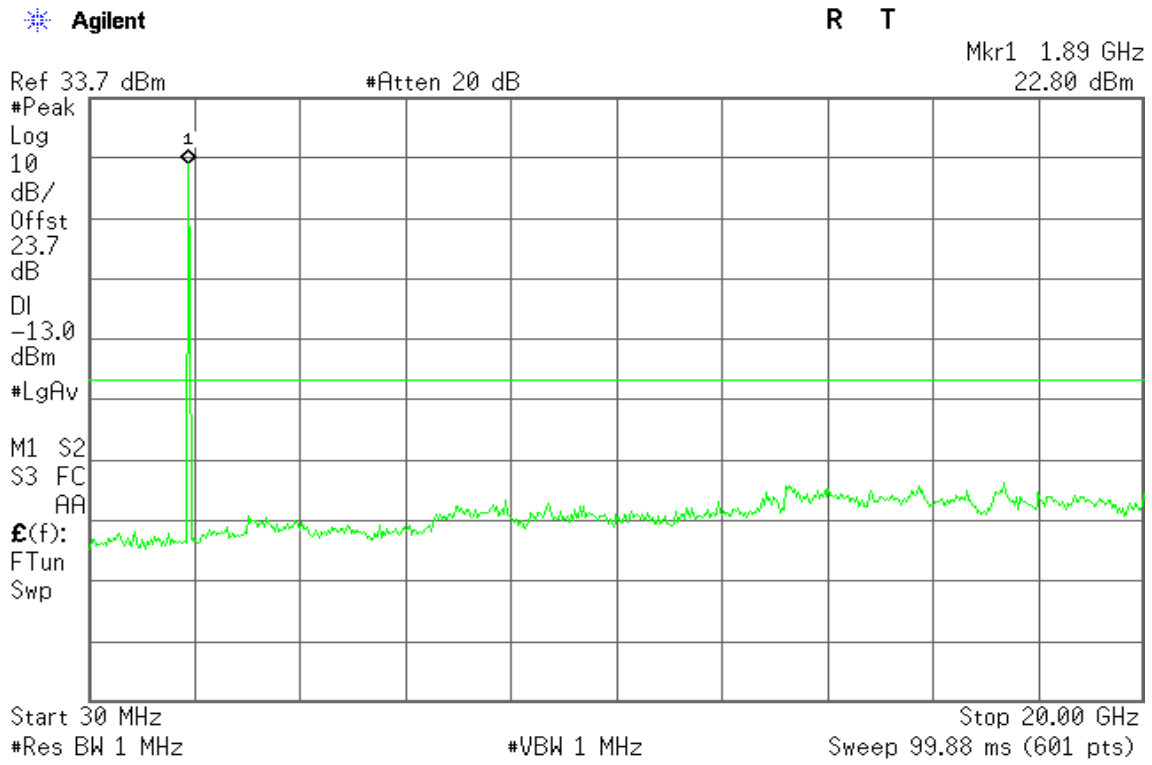



Figure 27-3: Out of Band emission at antenna terminals – HSUPA CH High





HSUPA / WCDMA Band V

Figure 28-1: Out of Band emission at antenna terminals – HSUPA CH Low

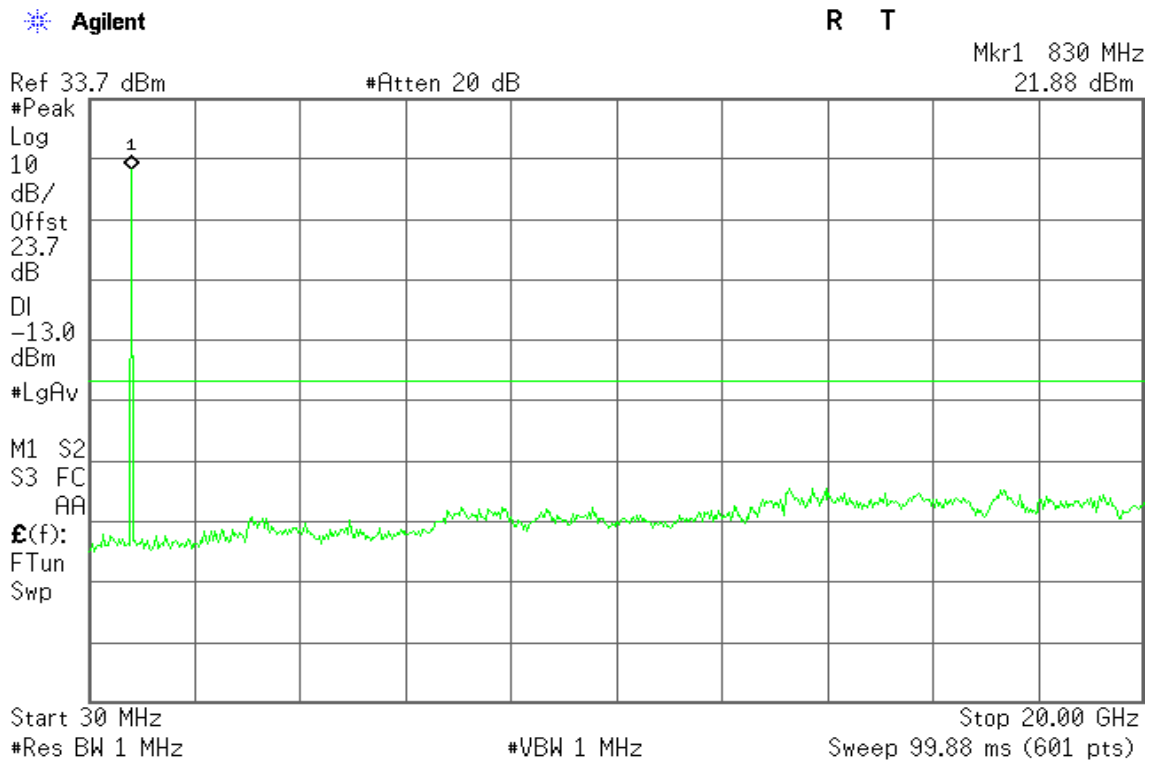

Figure 28-2: Out of Band emission at antenna terminals – HSUPA CH Mid

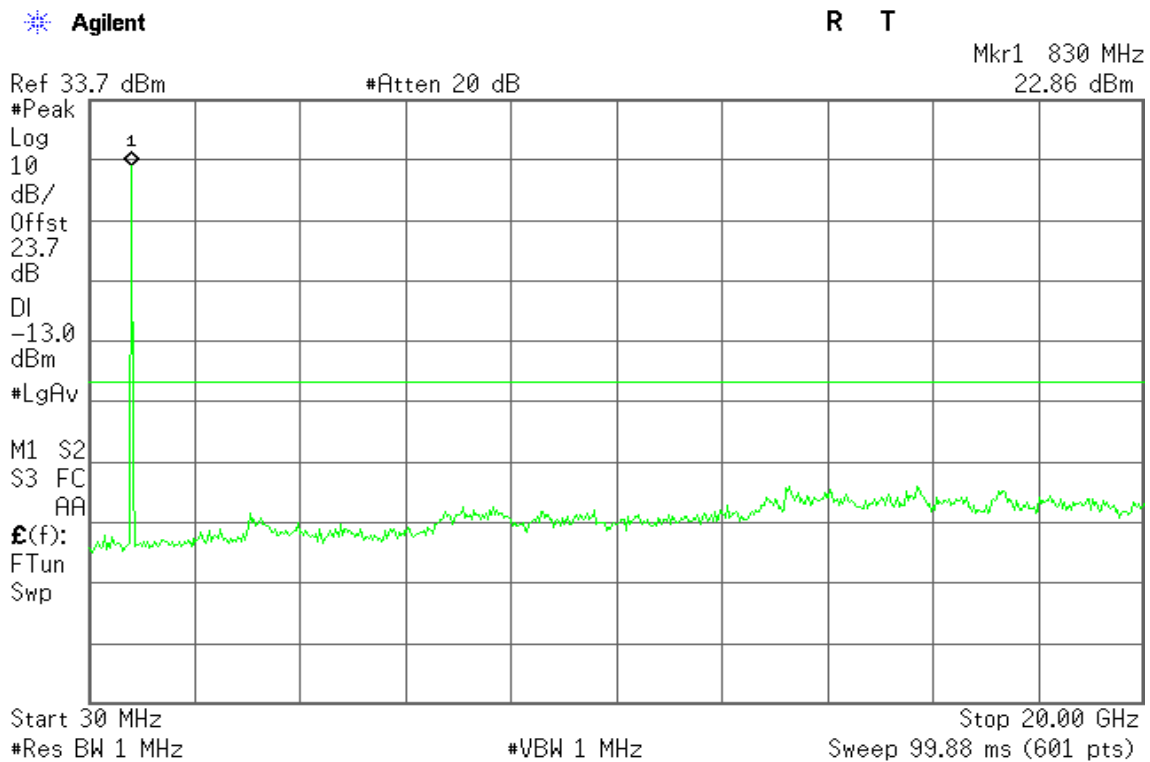
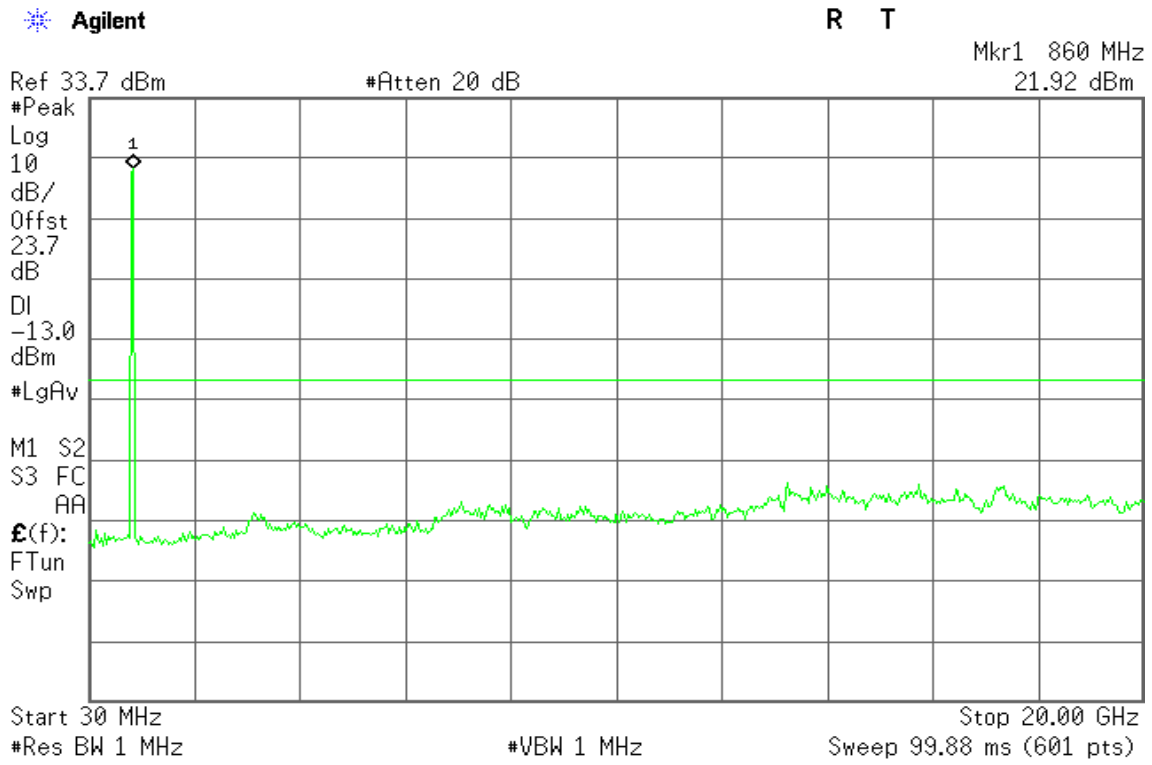



Figure 28-3: Out of Band emission at antenna terminals – HSUPA CH High





WCDMA / HSUPA Band II

Figure 29-1: Band Edge emissions – HSUPA CH Low

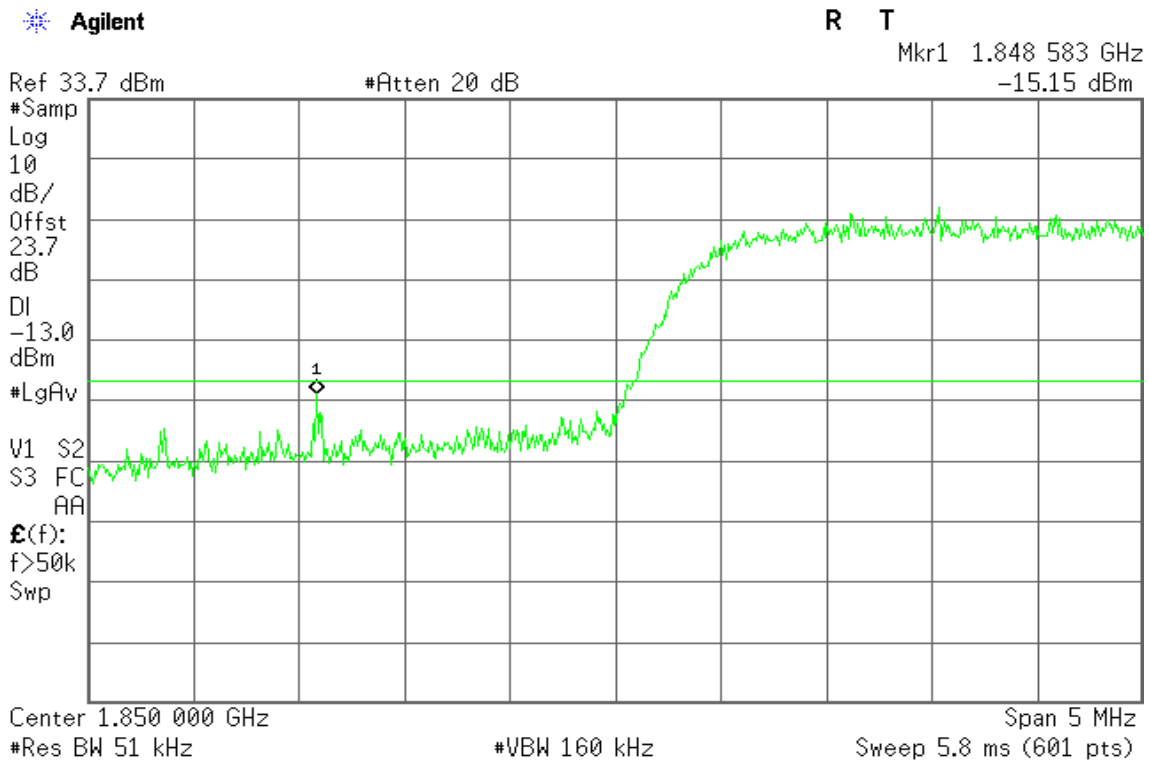
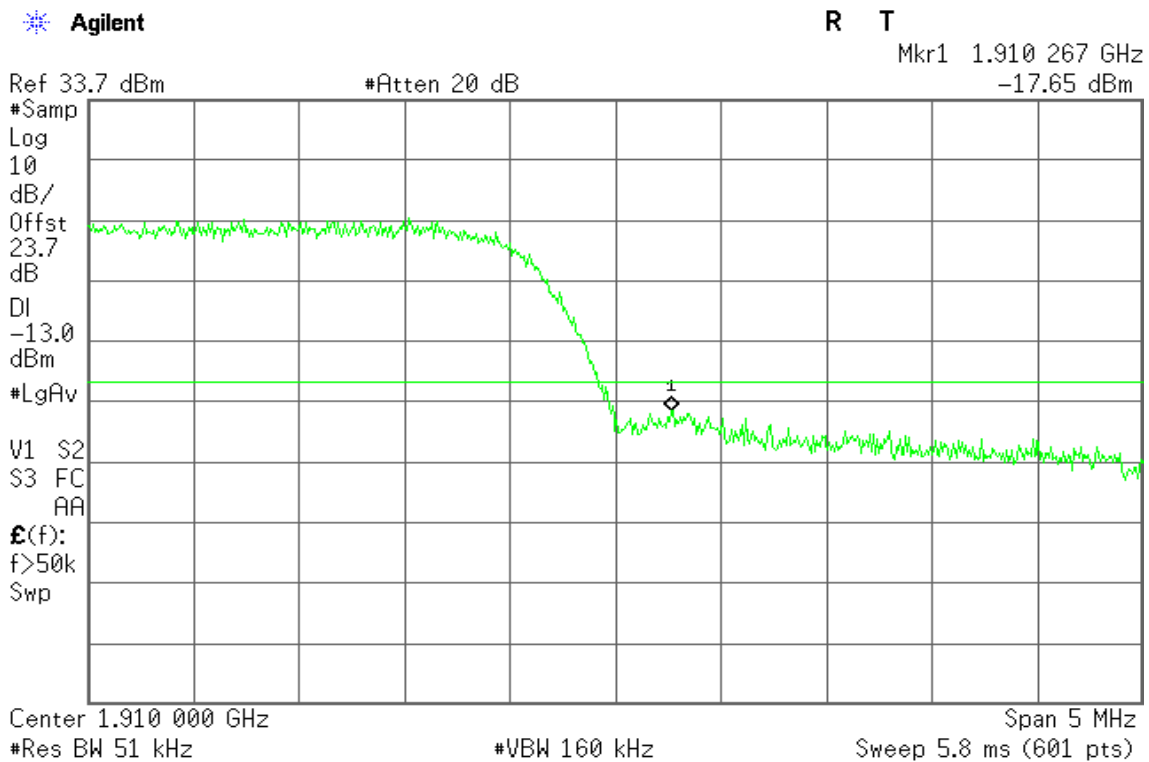

Figure 29-2: Band Edge emissions – HSUPA CH High





WCDMA / HSUPA Band V

Figure 30-1: Band Edge emissions – HSUPA CH Low

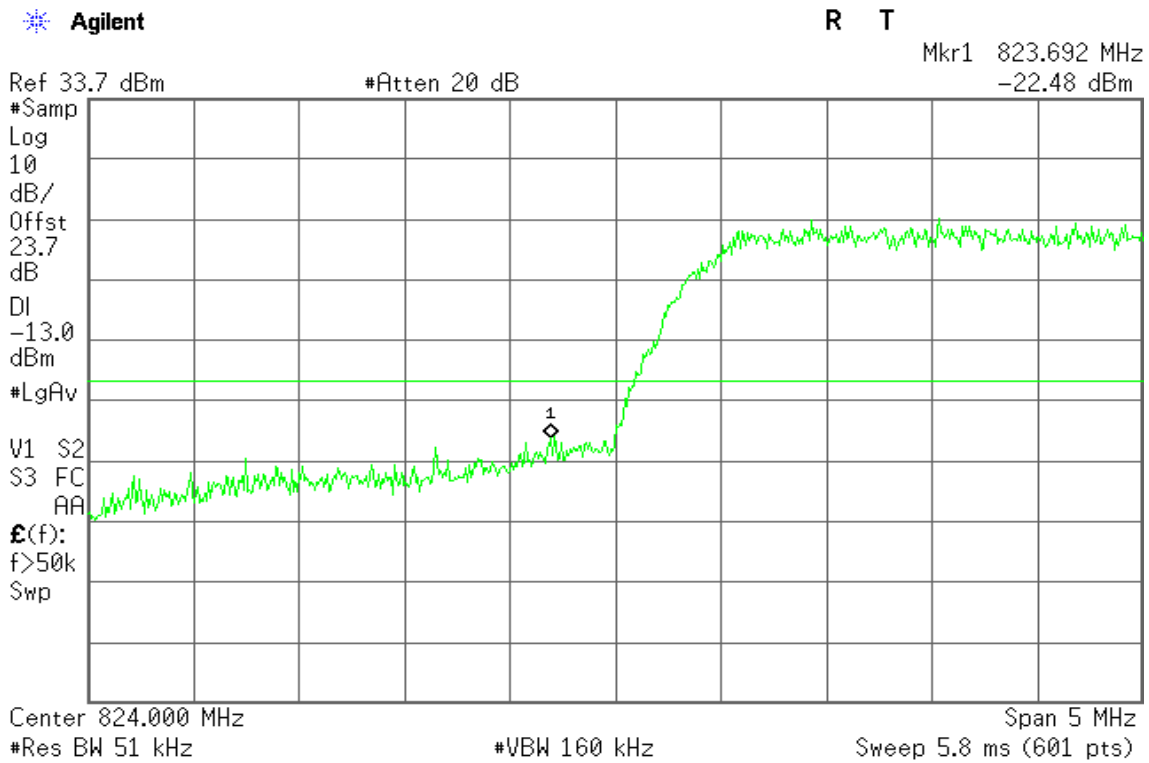
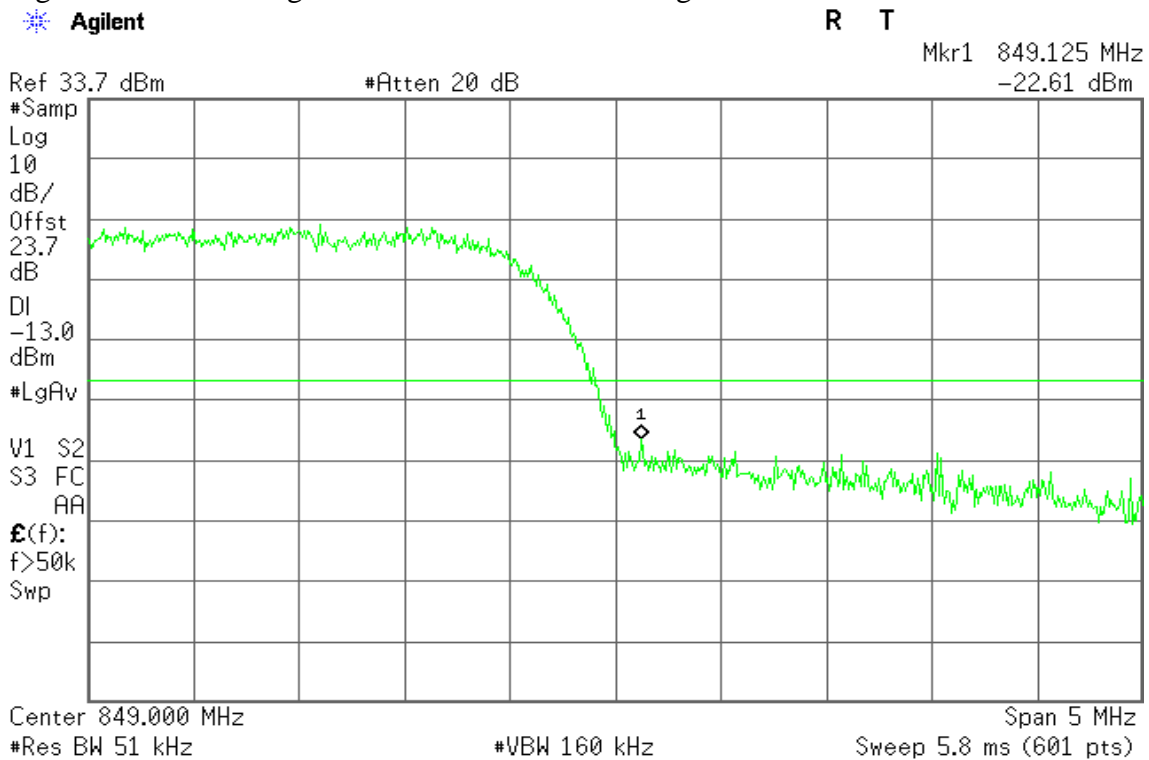

Figure 30-2: Band Edge emissions – HSUPA CH High





7.6 FIELD STRENGTH OF SPURIOUS RADIATION MEASUREMENT

LIMIT

According to FCC §2.1053, RSS-132 (4.6) & RSS-133 (6.5).

Test Configuration

Below 1 GHz

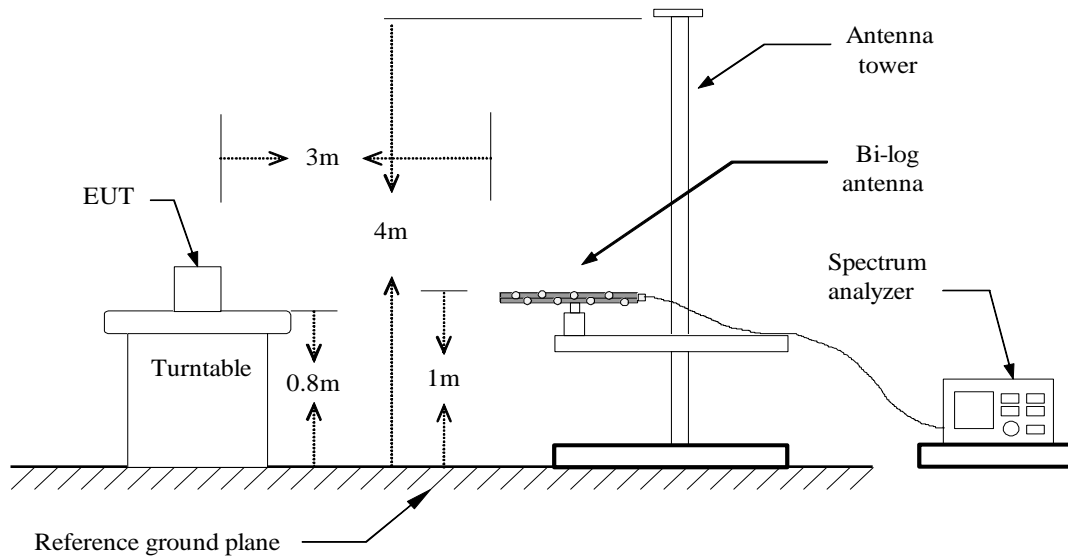

Above 1 GHz

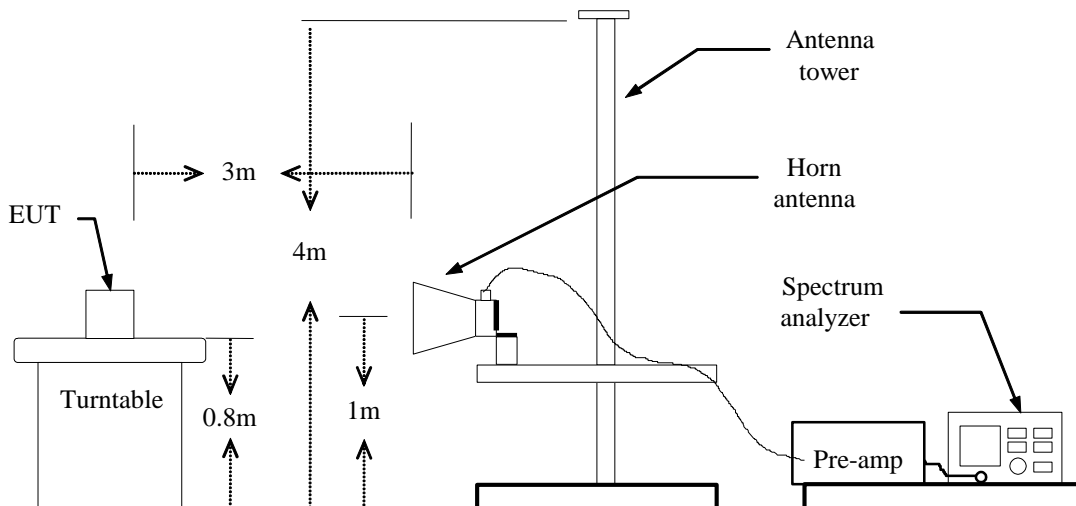



Substituted Method Test Set-up

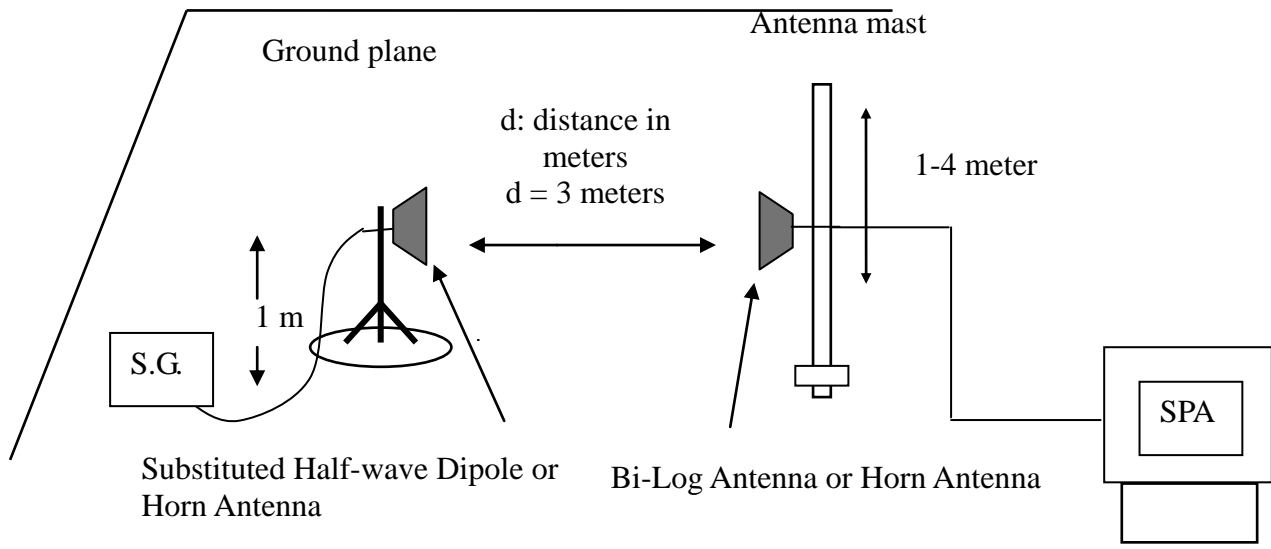

TEST PROCEDURE

The EUT was placed on a non-conductive, the measurement antenna was placed at a distance of 3 meters from the EUT. During the tests, the antenna height and the EUT azimuth were varied in order to identify the maximum level of emissions from the EUT. This maximization process was repeated with the EUT positioned in each of its three orthogonal orientations.

The frequency range up to tenth harmonic was investigated for each of three fundamental frequency (low, middle and high channels). Once spurious emission were identified, the power of the emission was determined using the substitution method.

The spurious emissions attenuation was calculated as the difference between radiated power at the fundamental frequency and the spurious emissions frequency.

$$\text{ERP} = \text{S.G. output (dBm)} + \text{Antenna Gain (dBd)} - \text{Cable (dB)}$$

$$\text{EIRP} = \text{S.G. output (dBm)} + \text{Antenna Gain (dBi)} - \text{Cable (dB)}$$

TEST RESULTS

Refer to the attached tabular data sheets.



Radiated Spurious Emission Measurement Result / Below 1GHz

Operation Mode: GSM 850 / TX / CH 128

Test Date: December 10, 2014

Temperature: 26°C

Tested by: Dennis Li

Humidity: 60 % RH

Polarity: Ver. / Hor.

Frequency (MHz)	S.G. (dBm)	Cable loss (dB)	Ant.Gain (dBi)	Emission level (dBm)	Limit (dBm)	Margin (dB)	Antenna Polarization (V/H)
78.5000	-64.09	1.03	-0.43	-65.55	-13.00	-52.55	V
150.2800	-66.1	1.43	0.71	-66.82	-13.00	-53.82	V
330.7000	-73.86	2.16	5.71	-70.31	-13.00	-57.31	V
448.0700	-77.74	2.58	5.74	-74.58	-13.00	-61.58	V
541.1900	-82.92	2.78	6.25	-79.45	-13.00	-66.45	V
684.7500	-83.33	3.11	6.5	-79.94	-13.00	-66.94	V
120.2100	-55.01	1.27	-2.06	-58.34	-13.00	-45.34	H
161.9200	-59.09	1.5	1.61	-58.98	-13.00	-45.98	H
342.3400	-70.84	2.18	5.8	-67.22	-13.00	-54.22	H
439.3400	-74.37	2.53	5.9	-71.00	-13.00	-58.00	H
529.5500	-73.02	2.75	6	-69.77	-13.00	-56.77	H
634.3100	-78.71	2.99	6.18	-75.52	-13.00	-62.52	H

Remark:

- 1. The emission behaviour belongs to narrowband spurious emission.*
- 2. Measurements above show only up to 6 maximum emissions noted, or would be lesser; with " N/A " remark, if no specific emissions from the EUT are recorded (ie: margin > 20dB from the applicable limit) and considered that's already beyond the background noise floor.*



Operation Mode: GSM 850 / TX / CH 190

Test Date: December 10, 2014

Temperature: 26°C

Tested by: Dennis Li

Humidity: 60 % RH

Polarity: Ver. / Hor.

Frequency (MHz)	S.G. (dBm)	Cable loss (dB)	Ant.Gain (dBi)	Emission level (dBm)	Limit (dBm)	Margin (dB)	Antenna Polarization (V/H)
75.5900	-60.18	1.01	-0.94	-62.13	-13.00	-49.13	V
161.9200	-65.55	1.5	1.61	-65.44	-13.00	-52.44	V
323.9100	-75.44	2.17	5.7	-71.91	-13.00	-58.91	V
439.3400	-78.6	2.53	5.9	-75.23	-13.00	-62.23	V
493.6600	-79.62	2.68	5.83	-76.47	-13.00	-63.47	V
610.0600	-81.73	2.94	6.29	-78.38	-13.00	-65.38	V
75.5900	-63.03	1.01	-0.94	-64.98	-13.00	-51.98	H
150.2800	-59.88	1.43	0.71	-60.60	-13.00	-47.60	H
323.9100	-69.01	2.17	5.7	-65.48	-13.00	-52.48	H
389.8700	-69.95	2.32	6	-66.27	-13.00	-53.27	H
459.7100	-72.43	2.6	5.88	-69.15	-13.00	-56.15	H
529.5500	-74.23	2.75	6	-70.98	-13.00	-57.98	H

Remark:

1. The emission behaviour belongs to narrowband spurious emission.
2. Measurements above show only up to 6 maximum emissions noted, or would be lesser, with " N/A " remark, if no specific emissions from the EUT are recorded (ie: margin>20dB from the applicable limit) and considered that's already beyond the background noise floor.



Operation Mode: GSM 850 / TX / CH 251

Test Date: December 10, 2014

Temperature: 26°C

Tested by: Dennis Li

Humidity: 60 % RH

Polarity: Ver. / Hor.

Frequency (MHz)	S.G. (dBm)	Cable loss (dB)	Ant.Gain (dBi)	Emission level (dBm)	Limit (dBm)	Margin (dB)	Antenna Polarization (V/H)
75.5900	-59.42	1.01	-0.94	-61.37	-13.00	-48.37	V
161.9200	-65.35	1.5	1.61	-65.24	-13.00	-52.24	V
330.7000	-75.64	2.16	5.71	-72.09	-13.00	-59.09	V
439.3400	-78.88	2.53	5.9	-75.51	-13.00	-62.51	V
478.1400	-79.11	2.63	5.59	-76.15	-13.00	-63.15	V
635.2800	-82.36	2.99	6.17	-79.18	-13.00	-66.18	V
120.2100	-59.46	1.27	-2.06	-62.79	-13.00	-49.79	H
150.2800	-59.22	1.43	0.71	-59.94	-13.00	-46.94	H
342.3400	-69.54	2.18	5.8	-65.92	-13.00	-52.92	H
448.0700	-71.55	2.58	5.74	-68.39	-13.00	-55.39	H
529.5500	-73.4	2.75	6	-70.15	-13.00	-57.15	H
625.5800	-76.53	2.96	6.16	-73.33	-13.00	-60.33	H

Remark:

1. *The emission behaviour belongs to narrowband spurious emission.*
2. *Measurements above show only up to 6 maximum emissions noted, or would be lesser, with " N/A " remark, if no specific emissions from the EUT are recorded (ie: margin>20dB from the applicable limit) and considered that's already beyond the background noise floor.*



Operation Mode: GPRS 850 / TX / CH 128

Test Date: December 10, 2014

Temperature: 26°C

Tested by: Dennis Li

Humidity: 60 % RH

Polarity: Ver. / Hor.

Frequency (MHz)	S.G. (dBm)	Cable loss (dB)	Ant.Gain (dBi)	Emission level (dBm)	Limit (dBm)	Margin (dB)	Antenna Polarization (V/H)
78.5000	-63.32	1.03	-0.43	-64.78	-13.00	-51.78	V
150.2800	-66.28	1.43	0.71	-67.00	-13.00	-54.00	V
330.7000	-74.03	2.16	5.71	-70.48	-13.00	-57.48	V
448.0700	-77.89	2.58	5.74	-74.73	-13.00	-61.73	V
571.2600	-83.37	2.87	6.1	-80.14	-13.00	-67.14	V
713.8500	-82.6	3.15	6.38	-79.37	-13.00	-66.37	V
78.5000	-57.22	1.03	-0.43	-58.68	-13.00	-45.68	H
161.9200	-57.78	1.5	1.61	-57.67	-13.00	-44.67	H
273.4700	-77.31	1.99	5.17	-74.13	-13.00	-61.13	H
342.3400	-70.01	2.18	5.8	-66.39	-13.00	-53.39	H
448.0700	-73.29	2.58	5.74	-70.13	-13.00	-57.13	H
529.5500	-74.47	2.75	6	-71.22	-13.00	-58.22	H

Remark:

1. *The emission behaviour belongs to narrowband spurious emission.*
2. *Measurements above show only up to 6 maximum emissions noted, or would be lesser, with " N/A " remark, if no specific emissions from the EUT are recorded (ie: margin>20dB from the applicable limit) and considered that's already beyond the background noise floor.*



Operation Mode: GPRS 850 / TX / CH 190

Test Date: December 10, 2014

Temperature: 26°C

Tested by: Dennis Li

Humidity: 60 % RH

Polarity: Ver. / Hor.

Frequency (MHz)	S.G. (dBm)	Cable loss (dB)	Ant.Gain (dBi)	Emission level (dBm)	Limit (dBm)	Margin (dB)	Antenna Polarization (V/H)
75.5900	-60.14	1.01	-0.94	-62.09	-13.00	-49.09	V
161.9200	-65.66	1.5	1.61	-65.55	-13.00	-52.55	V
323.9100	-72.1	2.17	5.7	-68.57	-13.00	-55.57	V
439.3400	-78.46	2.53	5.9	-75.09	-13.00	-62.09	V
480.0800	-79.37	2.64	5.54	-76.47	-13.00	-63.47	V
610.0600	-81.89	2.94	6.29	-78.54	-13.00	-65.54	V
95.9600	-65.81	1.13	0.26	-66.68	-13.00	-53.68	H
150.2800	-59.58	1.43	0.71	-60.30	-13.00	-47.30	H
217.2100	-70.24	1.74	5.35	-66.63	-13.00	-53.63	H
342.3400	-69.2	2.18	5.8	-65.58	-13.00	-52.58	H
389.8700	-69.44	2.32	6	-65.76	-13.00	-52.76	H
529.5500	-74.12	2.75	6	-70.87	-13.00	-57.87	H

Remark:

1. *The emission behaviour belongs to narrowband spurious emission.*
2. *Measurements above show only up to 6 maximum emissions noted, or would be lesser, with " N/A " remark, if no specific emissions from the EUT are recorded (ie: margin>20dB from the applicable limit) and considered that's already beyond the background noise floor.*



Operation Mode: GPRS 850 / TX / CH 251

Test Date: December 10, 2014

Temperature: 26°C

Tested by: Dennis Li

Humidity: 60 % RH

Polarity: Ver. / Hor.

Frequency (MHz)	S.G. (dBm)	Cable loss (dB)	Ant.Gain (dBi)	Emission level (dBm)	Limit (dBm)	Margin (dB)	Antenna Polarization (V/H)
75.5900	-59.71	1.01	-0.94	-61.66	-13.00	-48.66	V
161.9200	-65.5	1.5	1.61	-65.39	-13.00	-52.39	V
330.7000	-75.99	2.16	5.71	-72.44	-13.00	-59.44	V
439.3400	-77.92	2.53	5.9	-74.55	-13.00	-61.55	V
551.8600	-80.06	2.81	6.16	-76.71	-13.00	-63.71	V
731.3100	-81.59	3.18	6.37	-78.40	-13.00	-65.40	V
150.2800	-59.59	1.43	0.71	-60.31	-13.00	-47.31	H
342.3400	-69.29	2.18	5.8	-65.67	-13.00	-52.67	H
389.8700	-69.63	2.32	6	-65.95	-13.00	-52.95	H
529.5500	-74.24	2.75	6	-70.99	-13.00	-57.99	H
598.4200	-76.31	2.9	6.37	-72.84	-13.00	-59.84	H
704.1500	-78.34	3.13	6.35	-75.12	-13.00	-62.12	H

Remark:

1. *The emission behaviour belongs to narrowband spurious emission.*
2. *Measurements above show only up to 6 maximum emissions noted, or would be lesser, with " N/A " remark, if no specific emissions from the EUT are recorded (ie: margin>20dB from the applicable limit) and considered that's already beyond the background noise floor.*



Operation Mode: GSM 1900 / TX / CH 512

Test Date: December 10, 2014

Temperature: 26°C

Tested by: Dennis Li

Humidity: 60 % RH

Polarity: Ver. / Hor.

Frequency (MHz)	S.G. (dBm)	Cable loss (dB)	Ant.Gain (dBi)	Emission level (dBm)	Limit (dBm)	Margin (dB)	Antenna Polarization (V/H)
75.5900	-61.21	1.01	-0.94	-63.16	-13.00	-50.16	V
161.9200	-65.43	1.5	1.61	-65.32	-13.00	-52.32	V
323.9100	-72.91	2.17	5.7	-69.38	-13.00	-56.38	V
435.4600	-78.73	2.51	5.86	-75.38	-13.00	-62.38	V
573.2000	-82.28	2.88	6.08	-79.08	-13.00	-66.08	V
701.2400	-82.03	3.12	6.38	-78.77	-13.00	-65.77	V
101.7800	-65.48	1.16	-0.64	-67.28	-13.00	-54.28	H
161.9200	-65.63	1.5	1.61	-65.52	-13.00	-52.52	H
330.7000	-68.94	2.16	5.71	-65.39	-13.00	-52.39	H
448.0700	-71.97	2.58	5.74	-68.81	-13.00	-55.81	H
529.5500	-74.44	2.75	6	-71.19	-13.00	-58.19	H
637.2200	-76.88	3	6.15	-73.73	-13.00	-60.73	H

Remark:

1. *Measuring frequencies from 1 GHz to the 10th harmonic of highest fundamental frequency.*
2. *Measurements above show only up to 6 maximum emissions noted, or would be lesser, with “ N/A ” remark, if no specific emissions from the EUT are recorded (ie: margin > 20dB from the applicable limit) and considered that's already beyond the background noise floor.*



Operation Mode: GSM 1900 / TX / CH 661

Test Date: December 10, 2014

Temperature: 26°C

Tested by: Dennis Li

Humidity: 60 % RH

Polarity: Ver. / Hor.

Frequency (MHz)	S.G. (dBm)	Cable loss (dB)	Ant.Gain (dBi)	Emission level (dBm)	Limit (dBm)	Margin (dB)	Antenna Polarization (V/H)
75.5900	-61.27	1.01	-0.94	-63.22	-13.00	-50.22	V
161.9200	-65.86	1.5	1.61	-65.75	-13.00	-52.75	V
323.9100	-75.59	2.17	5.7	-72.06	-13.00	-59.06	V
426.7300	-79.33	2.48	5.8	-76.01	-13.00	-63.01	V
516.9400	-81.62	2.7	6.07	-78.25	-13.00	-65.25	V
717.7300	-82.19	3.16	6.44	-78.91	-13.00	-65.91	V
74.6200	-65.54	1	-1.11	-67.65	-13.00	-54.65	H
150.2800	-59.45	1.43	0.71	-60.17	-13.00	-47.17	H
323.9100	-69.72	2.17	5.7	-66.19	-13.00	-53.19	H
402.4800	-72.82	2.41	5.97	-69.26	-13.00	-56.26	H
529.5500	-74.5	2.75	6	-71.25	-13.00	-58.25	H
736.1600	-78.19	3.2	6.23	-75.16	-13.00	-62.16	H

Remark:

1. Measuring frequencies from 1 GHz to the 10th harmonic of highest fundamental frequency.
2. Measurements above show only up to 6 maximum emissions noted, or would be lesser, with " N/A " remark, if no specific emissions from the EUT are recorded (ie: margin > 20dB from the applicable limit) and considered that's already beyond the background noise floor.



Operation Mode: GSM 1900 / TX / CH 810

Test Date: December 10, 2014

Temperature: 26°C

Tested by: Dennis Li

Humidity: 60 % RH

Polarity: Ver. / Hor.

Frequency (MHz)	S.G. (dBm)	Cable loss (dB)	Ant.Gain (dBi)	Emission level (dBm)	Limit (dBm)	Margin (dB)	Antenna Polarization (V/H)
75.5900	-61.02	1.01	-0.94	-62.97	-13.00	-49.97	V
161.9200	-65.2	1.5	1.61	-65.09	-13.00	-52.09	V
323.9100	-75.94	2.17	5.7	-72.41	-13.00	-59.41	V
426.7300	-79.14	2.48	5.8	-75.82	-13.00	-62.82	V
529.5500	-82.3	2.75	6	-79.05	-13.00	-66.05	V
689.6000	-82.51	3.13	6.5	-79.14	-13.00	-66.14	V
150.2800	-59.56	1.43	0.71	-60.28	-13.00	-47.28	H
345.2500	-70.17	2.2	5.8	-66.57	-13.00	-53.57	H
448.0700	-70.99	2.58	5.74	-67.83	-13.00	-54.83	H
637.2200	-77.03	3	6.15	-73.88	-13.00	-60.88	H
773.0200	-77.47	3.28	6.29	-74.46	-13.00	-61.46	H
926.2800	-75.78	3.59	6.48	-72.89	-13.00	-59.89	H

Remark:

1. *Measuring frequencies from 1 GHz to the 10th harmonic of highest fundamental frequency.*
2. *Measurements above show only up to 6 maximum emissions noted, or would be lesser, with " N/A " remark, if no specific emissions from the EUT are recorded (ie: margin > 20dB from the applicable limit) and considered that's already beyond the background noise floor.*



Operation Mode: GPRS 1900 / TX / CH 512

Test Date: December 10, 2014

Temperature: 26°C

Tested by: Dennis Li

Humidity: 60 % RH

Polarity: Ver. / Hor.

Frequency (MHz)	S.G. (dBm)	Cable loss (dB)	Ant.Gain (dBi)	Emission level (dBm)	Limit (dBm)	Margin (dB)	Antenna Polarization (V/H)
75.5900	-60.34	1.01	-0.94	-62.29	-13.00	-49.29	V
161.9200	-65.35	1.5	1.61	-65.24	-13.00	-52.24	V
330.7000	-76.39	2.16	5.71	-72.84	-13.00	-59.84	V
439.3400	-78.26	2.53	5.9	-74.89	-13.00	-61.89	V
612.9700	-82.3	2.94	6.23	-79.01	-13.00	-66.01	V
781.7500	-80.64	3.31	6.13	-77.82	-13.00	-64.82	V
95.9600	-64.92	1.13	0.26	-65.79	-13.00	-52.79	H
150.2800	-59.53	1.43	0.71	-60.25	-13.00	-47.25	H
342.3400	-69.74	2.18	5.8	-66.12	-13.00	-53.12	H
448.0700	-71.42	2.58	5.74	-68.26	-13.00	-55.26	H
589.6900	-78.06	2.89	6.19	-74.76	-13.00	-61.76	H
771.0800	-77.14	3.27	6.35	-74.06	-13.00	-61.06	H

Remark:

1. *Measuring frequencies from 1 GHz to the 10th harmonic of highest fundamental frequency.*
2. *Measurements above show only up to 6 maximum emissions noted, or would be lesser, with “ N/A ” remark, if no specific emissions from the EUT are recorded (ie: margin > 20dB from the applicable limit) and considered that's already beyond the background noise floor.*



Operation Mode: GPRS 1900 / TX / CH 661

Test Date: December 10, 2014

Temperature: 26°C

Tested by: Dennis Li

Humidity: 60 % RH

Polarity: Ver. / Hor.

Frequency (MHz)	S.G. (dBm)	Cable loss (dB)	Ant.Gain (dBi)	Emission level (dBm)	Limit (dBm)	Margin (dB)	Antenna Polarization (V/H)
75.5900	-60.66	1.01	-0.94	-62.61	-13.00	-49.61	V
161.9200	-66.2	1.5	1.61	-66.09	-13.00	-53.09	V
330.7000	-75.54	2.16	5.71	-71.99	-13.00	-58.99	V
439.3400	-79.46	2.53	5.9	-76.09	-13.00	-63.09	V
519.8500	-82.38	2.7	6.1	-78.98	-13.00	-65.98	V
715.7900	-82.54	3.16	6.41	-79.29	-13.00	-66.29	V
75.5900	-63.22	1.01	-0.94	-65.17	-13.00	-52.17	H
120.2100	-60.13	1.27	-2.06	-63.46	-13.00	-50.46	H
150.2800	-59.37	1.43	0.71	-60.09	-13.00	-47.09	H
330.7000	-70.08	2.16	5.71	-66.53	-13.00	-53.53	H
448.0700	-71.9	2.58	5.74	-68.74	-13.00	-55.74	H
529.5500	-73.81	2.75	6	-70.56	-13.00	-57.56	H

Remark:

1. *Measuring frequencies from 1 GHz to the 10th harmonic of highest fundamental frequency.*
2. *Measurements above show only up to 6 maximum emissions noted, or would be lesser, with " N/A " remark, if no specific emissions from the EUT are recorded (ie: margin > 20dB from the applicable limit) and considered that's already beyond the background noise floor.*



Operation Mode: GPRS 1900 / TX / CH 810

Test Date: December 10, 2014

Temperature: 26°C

Tested by: Dennis Li

Humidity: 60 % RH

Polarity: Ver. / Hor.

Frequency (MHz)	S.G. (dBm)	Cable loss (dB)	Ant.Gain (dBi)	Emission level (dBm)	Limit (dBm)	Margin (dB)	Antenna Polarization (V/H)
75.5900	-60.81	1.01	-0.94	-62.76	-13.00	-49.76	V
138.6400	-63.68	1.39	-0.38	-65.45	-13.00	-52.45	V
330.7000	-76.71	2.16	5.71	-73.16	-13.00	-60.16	V
426.7300	-78.57	2.48	5.8	-75.25	-13.00	-62.25	V
529.5500	-82.76	2.75	6	-79.51	-13.00	-66.51	V
770.1100	-80.37	3.27	6.38	-77.26	-13.00	-64.26	V
75.5900	-64.52	1.01	-0.94	-66.47	-13.00	-53.47	H
150.2800	-59.8	1.43	0.71	-60.52	-13.00	-47.52	H
342.3400	-69.3	2.18	5.8	-65.68	-13.00	-52.68	H
448.0700	-70.78	2.58	5.74	-67.62	-13.00	-54.62	H
529.5500	-74.21	2.75	6	-70.96	-13.00	-57.96	H
712.8800	-78.51	3.15	6.36	-75.30	-13.00	-62.30	H

Remark:

1. *Measuring frequencies from 1 GHz to the 10th harmonic of highest fundamental frequency.*
2. *Measurements above show only up to 6 maximum emissions noted, or would be lesser, with " N/A " remark, if no specific emissions from the EUT are recorded (ie: margin > 20dB from the applicable limit) and considered that's already beyond the background noise floor.*



Operation Mode: EDGE 850 / TX / CH 128

Test Date: December 10, 2014

Temperature: 26°C

Tested by: Dennis Li

Humidity: 60 % RH

Polarity: Ver. / Hor.

Frequency (MHz)	S.G. (dBm)	Cable loss (dB)	Ant.Gain (dBi)	Emission level (dBm)	Limit (dBm)	Margin (dB)	Antenna Polarization (V/H)
78.5000	-63.16	1.03	-0.43	-64.62	-13.00	-51.62	V
150.2800	-66.02	1.43	0.71	-66.74	-13.00	-53.74	V
342.3400	-74.71	2.18	5.8	-71.09	-13.00	-58.09	V
529.5500	-79.09	2.75	6	-75.84	-13.00	-62.84	V
655.6500	-81.51	3.04	6.3	-78.25	-13.00	-65.25	V
760.4100	-82.4	3.22	6.3	-79.32	-13.00	-66.32	V
120.2100	-54.88	1.27	-2.06	-58.21	-13.00	-45.21	H
161.9200	-58.8	1.5	1.61	-58.69	-13.00	-45.69	H
330.7000	-71.03	2.16	5.71	-67.48	-13.00	-54.48	H
448.0700	-72.1	2.58	5.74	-68.94	-13.00	-55.94	H
529.5500	-73.27	2.75	6	-70.02	-13.00	-57.02	H
634.3100	-78.81	2.99	6.18	-75.62	-13.00	-62.62	H

Remark:

1. *Measuring frequencies from 1 GHz to the 10th harmonic of highest fundamental frequency.*
2. *Measurements above show only up to 6 maximum emissions noted, or would be lesser, with " N/A " remark, if no specific emissions from the EUT are recorded (ie: margin>20dB from the applicable limit) and considered that's already beyond the background noise floor.*



Operation Mode: EDGE 850 / TX / CH 190

Test Date: December 10, 2014

Temperature: 26°C

Tested by: Dennis Li

Humidity: 60 % RH

Polarity: Ver. / Hor.

Frequency (MHz)	S.G. (dBm)	Cable loss (dB)	Ant.Gain (dBi)	Emission level (dBm)	Limit (dBm)	Margin (dB)	Antenna Polarization (V/H)
75.5900	-60.15	1.01	-0.94	-62.10	-13.00	-49.10	V
161.9200	-65.03	1.5	1.61	-64.92	-13.00	-51.92	V
324.8800	-75.39	2.17	5.7	-71.86	-13.00	-58.86	V
439.3400	-78.59	2.53	5.9	-75.22	-13.00	-62.22	V
492.6900	-81.21	2.68	5.82	-78.07	-13.00	-65.07	V
633.3400	-81.38	2.99	6.18	-78.19	-13.00	-65.19	V
78.5000	-57.36	1.03	-0.43	-58.82	-13.00	-45.82	H
161.9200	-58.25	1.5	1.61	-58.14	-13.00	-45.14	H
330.7000	-71.73	2.16	5.71	-68.18	-13.00	-55.18	H
439.3400	-73.86	2.53	5.9	-70.49	-13.00	-57.49	H
529.5500	-74.53	2.75	6	-71.28	-13.00	-58.28	H
565.4400	-75.12	2.86	6.04	-71.94	-13.00	-58.94	H

Remark:

1. Measuring frequencies from 1 GHz to the 10th harmonic of highest fundamental frequency.
2. Measurements above show only up to 6 maximum emissions noted, or would be lesser, with " N/A " remark, if no specific emissions from the EUT are recorded (ie: margin > 20dB from the applicable limit) and considered that's already beyond the background noise floor.



Operation Mode: EDGE 850 / TX / CH 251

Test Date: December 10, 2014

Temperature: 26°C

Tested by: Dennis Li

Humidity: 60 % RH

Polarity: Ver. / Hor.

Frequency (MHz)	S.G. (dBm)	Cable loss (dB)	Ant.Gain (dBi)	Emission level (dBm)	Limit (dBm)	Margin (dB)	Antenna Polarization (V/H)
75.5900	-59.31	1.01	-0.94	-61.26	-13.00	-48.26	V
161.9200	-65.51	1.5	1.61	-65.40	-13.00	-52.40	V
330.7000	-75.95	2.16	5.71	-72.40	-13.00	-59.40	V
454.8600	-77.81	2.6	5.8	-74.61	-13.00	-61.61	V
566.4100	-81.44	2.86	6.06	-78.24	-13.00	-65.24	V
611.0300	-81.21	2.94	6.27	-77.88	-13.00	-64.88	V
150.2800	-59.54	1.43	0.71	-60.26	-13.00	-47.26	H
342.3400	-69.02	2.18	5.8	-65.40	-13.00	-52.40	H
448.0700	-70.72	2.58	5.74	-67.56	-13.00	-54.56	H
529.5500	-74.13	2.75	6	-70.88	-13.00	-57.88	H
637.2200	-75.9	3	6.15	-72.75	-13.00	-59.75	H
814.7300	-76.74	3.36	6.2	-73.90	-13.00	-60.90	H

Remark:

1. *Measuring frequencies from 1 GHz to the 10th harmonic of highest fundamental frequency.*
2. *Measurements above show only up to 6 maximum emissions noted, or would be lesser, with " N/A " remark, if no specific emissions from the EUT are recorded (ie: margin > 20dB from the applicable limit) and considered that's already beyond the background noise floor.*



Operation Mode: EDGE 1900 / TX / CH 512

Test Date: December 10, 2014

Temperature: 26°C

Tested by: Dennis Li

Humidity: 60 % RH

Polarity: Ver. / Hor.

Frequency (MHz)	S.G. (dBm)	Cable loss (dB)	Ant.Gain (dBi)	Emission level (dBm)	Limit (dBm)	Margin (dB)	Antenna Polarization (V/H)
75.5900	-60.74	1.01	-0.94	-62.69	-13.00	-49.69	V
161.9200	-66.07	1.5	1.61	-65.96	-13.00	-52.96	V
330.7000	-74.79	2.16	5.71	-71.24	-13.00	-58.24	V
448.0700	-78.84	2.58	5.74	-75.68	-13.00	-62.68	V
511.1200	-80.63	2.69	6.01	-77.31	-13.00	-64.31	V
701.2400	-82.37	3.12	6.38	-79.11	-13.00	-66.11	V
95.9600	-65.48	1.13	0.26	-66.35	-13.00	-53.35	H
150.2800	-59.41	1.43	0.71	-60.13	-13.00	-47.13	H
345.2500	-68.75	2.2	5.8	-65.15	-13.00	-52.15	H
448.0700	-72.42	2.58	5.74	-69.26	-13.00	-56.26	H
529.5500	-74.2	2.75	6	-70.95	-13.00	-57.95	H
719.6700	-78.2	3.17	6.48	-74.89	-13.00	-61.89	H

Remark:

1. Measuring frequencies from 1 GHz to the 10th harmonic of highest fundamental frequency.
2. Measurements above show only up to 6 maximum emissions noted, or would be lesser, with " N/A " remark, if no specific emissions from the EUT are recorded (ie: margin > 20dB from the applicable limit) and considered that's already beyond the background noise floor.



Operation Mode: EDGE 1900 / TX / CH 661

Test Date: December 10, 2014

Temperature: 26°C

Tested by: Dennis Li

Humidity: 60 % RH

Polarity: Ver. / Hor.

Frequency (MHz)	S.G. (dBm)	Cable loss (dB)	Ant.Gain (dBi)	Emission level (dBm)	Limit (dBm)	Margin (dB)	Antenna Polarization (V/H)
75.5900	-60.13	1.01	-0.94	-62.08	-13.00	-49.08	V
161.9200	-66.24	1.5	1.61	-66.13	-13.00	-53.13	V
177.4400	-71.66	1.6	3.31	-69.95	-13.00	-56.95	V
323.9100	-75.79	2.17	5.7	-72.26	-13.00	-59.26	V
448.0700	-78.61	2.58	5.74	-75.45	-13.00	-62.45	V
644.0100	-81.76	3.02	6.17	-78.61	-13.00	-65.61	V
95.9600	-64.89	1.13	0.26	-65.76	-13.00	-52.76	H
150.2800	-59.56	1.43	0.71	-60.28	-13.00	-47.28	H
345.2500	-69.71	2.2	5.8	-66.11	-13.00	-53.11	H
448.0700	-72.08	2.58	5.74	-68.92	-13.00	-55.92	H
529.5500	-73.42	2.75	6	-70.17	-13.00	-57.17	H
612.9700	-76.96	2.94	6.23	-73.67	-13.00	-60.67	H

Remark:

1. *Measuring frequencies from 1 GHz to the 10th harmonic of highest fundamental frequency.*
2. *Measurements above show only up to 6 maximum emissions noted, or would be lesser, with " N/A " remark, if no specific emissions from the EUT are recorded (ie: margin > 20dB from the applicable limit) and considered that's already beyond the background noise floor.*



Operation Mode: EDGE 1900 / TX / CH 810

Test Date: December 10, 2014

Temperature: 26°C

Tested by: Dennis Li

Humidity: 60 % RH

Polarity: Ver. / Hor.

Frequency (MHz)	S.G. (dBm)	Cable loss (dB)	Ant.Gain (dBi)	Emission level (dBm)	Limit (dBm)	Margin (dB)	Antenna Polarization (V/H)
75.5900	-59.74	1.01	-0.94	-61.69	-13.00	-48.69	V
161.9200	-65.9	1.5	1.61	-65.79	-13.00	-52.79	V
323.9100	-75.75	2.17	5.7	-72.22	-13.00	-59.22	V
426.7300	-79.33	2.48	5.8	-76.01	-13.00	-63.01	V
610.0600	-80.68	2.94	6.29	-77.33	-13.00	-64.33	V
877.7800	-81	3.46	6.64	-77.82	-13.00	-64.82	V
95.9600	-64.74	1.13	0.26	-65.61	-13.00	-52.61	H
150.2800	-59.75	1.43	0.71	-60.47	-13.00	-47.47	H
330.7000	-69.97	2.16	5.71	-66.42	-13.00	-53.42	H
448.0700	-71.84	2.58	5.74	-68.68	-13.00	-55.68	H
598.4200	-77.64	2.9	6.37	-74.17	-13.00	-61.17	H
784.6600	-76.78	3.32	6.16	-73.94	-13.00	-60.94	H

Remark:

1. *Measuring frequencies from 1 GHz to the 10th harmonic of highest fundamental frequency.*
2. *Measurements above show only up to 6 maximum emissions noted, or would be lesser, with " N/A " remark, if no specific emissions from the EUT are recorded (ie: margin > 20dB from the applicable limit) and considered that's already beyond the background noise floor.*



Operation Mode: WCDMA Band II / TX / CH 9262

Test Date: December 10, 2014

Temperature: 26°C

Tested by: Dennis Li

Humidity: 60 % RH

Polarity: Ver. / Hor.

Frequency (MHz)	S.G. (dBm)	Cable loss (dB)	Ant.Gain (dBi)	Emission level (dBm)	Limit (dBm)	Margin (dB)	Antenna Polarization (V/H)
101.7800	-63.09	1.16	-0.64	-64.89	-13.00	-51.89	V
150.2800	-63.15	1.43	0.71	-63.87	-13.00	-50.87	V
323.9100	-76.9	2.17	5.7	-73.37	-13.00	-60.37	V
448.0700	-79.07	2.58	5.74	-75.91	-13.00	-62.91	V
612.9700	-82.65	2.94	6.23	-79.36	-13.00	-66.36	V
874.8700	-80.29	3.45	6.6	-77.14	-13.00	-64.14	V
78.5000	-64.7	1.03	-0.43	-66.16	-13.00	-53.16	H
138.6400	-58.54	1.39	-0.38	-60.31	-13.00	-47.31	H
346.2200	-70.22	2.21	5.8	-66.63	-13.00	-53.63	H
439.3400	-72.52	2.53	5.9	-69.15	-13.00	-56.15	H
529.5500	-73.22	2.75	6	-69.97	-13.00	-56.97	H
623.6400	-77.83	2.95	6.14	-74.64	-13.00	-61.64	H

Remark:

1. *Measuring frequencies from 1 GHz to the 10th harmonic of highest fundamental frequency.*
2. *Measurements above show only up to 6 maximum emissions noted, or would be lesser, with " N/A " remark, if no specific emissions from the EUT are recorded (ie: margin > 20dB from the applicable limit) and considered that's already beyond the background noise floor.*



Operation Mode: WCDMA Band II / TX / CH 9400

Test Date: December 10, 2014

Temperature: 26°C

Tested by: Dennis Li

Humidity: 60 % RH

Polarity: Ver. / Hor.

Frequency (MHz)	S.G. (dBm)	Cable loss (dB)	Ant.Gain (dBi)	Emission level (dBm)	Limit (dBm)	Margin (dB)	Antenna Polarization (V/H)
101.7800	-63.09	1.16	-0.64	-64.89	-13.00	-51.89	V
150.2800	-62.92	1.43	0.71	-63.64	-13.00	-50.64	V
330.7000	-76.47	2.16	5.71	-72.92	-13.00	-59.92	V
448.0700	-78.71	2.58	5.74	-75.55	-13.00	-62.55	V
589.6900	-80.58	2.89	6.19	-77.28	-13.00	-64.28	V
850.6200	-80.8	3.4	6.4	-77.80	-13.00	-64.80	V
78.5000	-64.66	1.03	-0.43	-66.12	-13.00	-53.12	H
138.6400	-59.19	1.39	-0.38	-60.96	-13.00	-47.96	H
346.2200	-69.71	2.21	5.8	-66.12	-13.00	-53.12	H
448.0700	-73.22	2.58	5.74	-70.06	-13.00	-57.06	H
529.5500	-74.81	2.75	6	-71.56	-13.00	-58.56	H
873.9000	-77.57	3.45	6.58	-74.44	-13.00	-61.44	H

Remark:

1. *Measuring frequencies from 1 GHz to the 10th harmonic of highest fundamental frequency.*
2. *Measurements above show only up to 6 maximum emissions noted, or would be lesser, with " N/A " remark, if no specific emissions from the EUT are recorded (ie: margin > 20dB from the applicable limit) and considered that's already beyond the background noise floor.*



Operation Mode: WCDMA Band II / TX / CH 9538

Test Date: December 10, 2014

Temperature: 26°C

Tested by: Dennis Li

Humidity: 60 % RH

Polarity: Ver. / Hor.

Frequency (MHz)	S.G. (dBm)	Cable loss (dB)	Ant.Gain (dBi)	Emission level (dBm)	Limit (dBm)	Margin (dB)	Antenna Polarization (V/H)
101.7800	-63.01	1.16	-0.64	-64.81	-13.00	-51.81	V
150.2800	-62.99	1.43	0.71	-63.71	-13.00	-50.71	V
330.7000	-77.47	2.16	5.71	-73.92	-13.00	-60.92	V
459.7100	-80.4	2.6	5.88	-77.12	-13.00	-64.12	V
731.3100	-82.48	3.18	6.37	-79.29	-13.00	-66.29	V
876.8100	-80.52	3.46	6.63	-77.35	-13.00	-64.35	V
78.5000	-65.37	1.03	-0.43	-66.83	-13.00	-53.83	H
138.6400	-58.72	1.39	-0.38	-60.49	-13.00	-47.49	H
346.2200	-70.84	2.21	5.8	-67.25	-13.00	-54.25	H
448.0700	-72.42	2.58	5.74	-69.26	-13.00	-56.26	H
529.5500	-74.39	2.75	6	-71.14	-13.00	-58.14	H
730.3400	-78.42	3.18	6.39	-75.21	-13.00	-62.21	H

Remark:

1. *Measuring frequencies from 1 GHz to the 10th harmonic of highest fundamental frequency.*
2. *Measurements above show only up to 6 maximum emissions noted, or would be lesser, with " N/A " remark, if no specific emissions from the EUT are recorded (ie: margin > 20dB from the applicable limit) and considered that's already beyond the background noise floor.*



Operation Mode: WCDMA Band V / TX / CH 4132

Test Date: December 10, 2014

Temperature: 26°C

Tested by: Dennis Li

Humidity: 60 % RH

Polarity: Ver. / Hor.

Frequency (MHz)	S.G. (dBm)	Cable loss (dB)	Ant.Gain (dBi)	Emission level (dBm)	Limit (dBm)	Margin (dB)	Antenna Polarization (V/H)
101.7800	-63.48	1.16	-0.64	-65.28	-13.00	-52.28	V
150.2800	-63.81	1.43	0.71	-64.53	-13.00	-51.53	V
323.9100	-75.32	2.17	5.7	-71.79	-13.00	-58.79	V
449.0400	-76.85	2.59	5.72	-73.72	-13.00	-60.72	V
589.6900	-81.28	2.89	6.19	-77.98	-13.00	-64.98	V
725.4900	-81.73	3.17	6.45	-78.45	-13.00	-65.45	V
78.5000	-62.75	1.03	-0.43	-64.21	-13.00	-51.21	H
138.6400	-56.17	1.39	-0.38	-57.94	-13.00	-44.94	H
345.2500	-67.88	2.2	5.8	-64.28	-13.00	-51.28	H
529.5500	-72.3	2.75	6	-69.05	-13.00	-56.05	H
589.6900	-74.5	2.89	6.19	-71.20	-13.00	-58.20	H
805.0300	-75.19	3.33	6.41	-72.11	-13.00	-59.11	H

Remark:

1. *Measuring frequencies from 1 GHz to the 10th harmonic of highest fundamental frequency.*
2. *Measurements above show only up to 6 maximum emissions noted, or would be lesser, with " N/A " remark, if no specific emissions from the EUT are recorded (ie: margin > 20dB from the applicable limit) and considered that's already beyond the background noise floor.*



Operation Mode: WCDMA Band V / TX / CH 4182

Test Date: December 10, 2014

Temperature: 26°C

Tested by: Dennis Li

Humidity: 60 % RH

Polarity: Ver. / Hor.

Frequency (MHz)	S.G. (dBm)	Cable loss (dB)	Ant.Gain (dBi)	Emission level (dBm)	Limit (dBm)	Margin (dB)	Antenna Polarization (V/H)
101.7800	-63.34	1.16	-0.64	-65.14	-13.00	-52.14	V
150.2800	-64.2	1.43	0.71	-64.92	-13.00	-51.92	V
323.9100	-73.08	2.17	5.7	-69.55	-13.00	-56.55	V
448.0700	-79.24	2.58	5.74	-76.08	-13.00	-63.08	V
589.6900	-81.56	2.89	6.19	-78.26	-13.00	-65.26	V
723.5500	-81.93	3.17	6.47	-78.63	-13.00	-65.63	V
71.7100	-63.89	0.97	-1.61	-66.47	-13.00	-53.47	H
138.6400	-60.01	1.39	-0.38	-61.78	-13.00	-48.78	H
345.2500	-70.49	2.2	5.8	-66.89	-13.00	-53.89	H
439.3400	-72.53	2.53	5.9	-69.16	-13.00	-56.16	H
529.5500	-73.55	2.75	6	-70.30	-13.00	-57.30	H
730.3400	-78.07	3.18	6.39	-74.86	-13.00	-61.86	H

Remark:

1. *Measuring frequencies from 1 GHz to the 10th harmonic of highest fundamental frequency.*
2. *Measurements above show only up to 6 maximum emissions noted, or would be lesser, with " N/A " remark, if no specific emissions from the EUT are recorded (ie: margin > 20dB from the applicable limit) and considered that's already beyond the background noise floor.*



Operation Mode: WCDMA Band V / TX / CH 4233

Test Date: December 10, 2014

Temperature: 26°C

Tested by: Dennis Li

Humidity: 60 % RH

Polarity: Ver. / Hor.

Frequency (MHz)	S.G. (dBm)	Cable loss (dB)	Ant.Gain (dBi)	Emission level (dBm)	Limit (dBm)	Margin (dB)	Antenna Polarization (V/H)
101.7800	-64.25	1.16	-0.64	-66.05	-13.00	-53.05	V
150.2800	-63.86	1.43	0.71	-64.58	-13.00	-51.58	V
330.7000	-77.38	2.16	5.71	-73.83	-13.00	-60.83	V
448.0700	-79.64	2.58	5.74	-76.48	-13.00	-63.48	V
505.3000	-81.09	2.69	5.95	-77.83	-13.00	-64.83	V
625.5800	-81.57	2.96	6.16	-78.37	-13.00	-65.37	V
78.5000	-64.66	1.03	-0.43	-66.12	-13.00	-53.12	H
138.6400	-58.69	1.39	-0.38	-60.46	-13.00	-47.46	H
267.6500	-75.26	1.96	5.22	-72.00	-13.00	-59.00	H
330.7000	-70.61	2.16	5.71	-67.06	-13.00	-54.06	H
390.8400	-72.06	2.32	6	-68.38	-13.00	-55.38	H
771.0800	-78.3	3.27	6.35	-75.22	-13.00	-62.22	H

Remark:

1. *Measuring frequencies from 1 GHz to the 10th harmonic of highest fundamental frequency.*
2. *Measurements above show only up to 6 maximum emissions noted, or would be lesser, with " N/A " remark, if no specific emissions from the EUT are recorded (ie: margin > 20dB from the applicable limit) and considered that's already beyond the background noise floor.*



Operation Mode: WCDMA / HSDPA Band II / TX / CH 9262

Test Date: December 10, 2014

Temperature: 26°C

Tested by: Dennis Li

Humidity: 60 % RH

Polarity: Ver. / Hor.

Frequency (MHz)	S.G. (dBm)	Cable loss (dB)	Ant.Gain (dBi)	Emission level (dBm)	Limit (dBm)	Margin (dB)	Antenna Polarization (V/H)
101.7800	-63.93	1.16	-0.64	-65.73	-13.00	-52.73	V
171.6200	-69.83	1.57	2.69	-68.71	-13.00	-55.71	V
330.7000	-77.52	2.16	5.71	-73.97	-13.00	-60.97	V
448.0700	-78.29	2.58	5.74	-75.13	-13.00	-62.13	V
612.9700	-81.95	2.94	6.23	-78.66	-13.00	-65.66	V
774.9600	-80.62	3.29	6.24	-77.67	-13.00	-64.67	V
78.5000	-64.05	1.03	-0.43	-65.51	-13.00	-52.51	H
138.6400	-58.58	1.39	-0.38	-60.35	-13.00	-47.35	H
345.2500	-69.31	2.2	5.8	-65.71	-13.00	-52.71	H
439.3400	-73.2	2.53	5.9	-69.83	-13.00	-56.83	H
529.5500	-73.95	2.75	6	-70.70	-13.00	-57.70	H
637.2200	-77.93	3	6.15	-74.78	-13.00	-61.78	H

Remark:

1. Measuring frequencies from 1 GHz to the 10th harmonic of highest fundamental frequency.
2. Measurements above show only up to 6 maximum emissions noted, or would be lesser, with " N/A " remark, if no specific emissions from the EUT are recorded (ie: margin>20dB from the applicable limit) and considered that's already beyond the background noise floor.



Operation Mode: WCDMA / HSDPA Band II / TX / CH 9400

Test Date: December 10, 2014

Temperature: 26°C

Tested by: Dennis Li

Humidity: 60 % RH

Polarity: Ver. / Hor.

Frequency (MHz)	S.G. (dBm)	Cable loss (dB)	Ant.Gain (dBi)	Emission level (dBm)	Limit (dBm)	Margin (dB)	Antenna Polarization (V/H)
101.7800	-63.53	1.16	-0.64	-65.33	-13.00	-52.33	V
150.2800	-62.79	1.43	0.71	-63.51	-13.00	-50.51	V
319.0600	-78.31	2.17	5.71	-74.77	-13.00	-61.77	V
448.0700	-79.57	2.58	5.74	-76.41	-13.00	-63.41	V
541.1900	-81.66	2.78	6.25	-78.19	-13.00	-65.19	V
625.5800	-82.2	2.96	6.16	-79.00	-13.00	-66.00	V
78.5000	-64.98	1.03	-0.43	-66.44	-13.00	-53.44	H
138.6400	-59.03	1.39	-0.38	-60.80	-13.00	-47.80	H
330.7000	-70.44	2.16	5.71	-66.89	-13.00	-53.89	H
390.8400	-73.28	2.32	6	-69.60	-13.00	-56.60	H
529.5500	-73.99	2.75	6	-70.74	-13.00	-57.74	H
754.5900	-78.2	3.21	6.19	-75.22	-13.00	-62.22	H

Remark:

1. Measuring frequencies from 1 GHz to the 10th harmonic of highest fundamental frequency.
2. Measurements above show only up to 6 maximum emissions noted, or would be lesser, with " N/A " remark, if no specific emissions from the EUT are recorded (ie: margin > 20dB from the applicable limit) and considered that's already beyond the background noise floor.



Operation Mode: WCDMA / HSDPA Band II / TX / CH 9538

Test Date: December 10, 2014

Temperature: 26°C

Tested by: Dennis Li

Humidity: 60 % RH

Polarity: Ver. / Hor.

Frequency (MHz)	S.G. (dBm)	Cable loss (dB)	Ant.Gain (dBi)	Emission level (dBm)	Limit (dBm)	Margin (dB)	Antenna Polarization (V/H)
101.7800	-63.03	1.16	-0.64	-64.83	-13.00	-51.83	V
150.2800	-63.03	1.43	0.71	-63.75	-13.00	-50.75	V
330.7000	-77.15	2.16	5.71	-73.60	-13.00	-60.60	V
448.0700	-80.62	2.58	5.74	-77.46	-13.00	-64.46	V
585.8100	-81.76	2.89	6.11	-78.54	-13.00	-65.54	V
771.0800	-81.7	3.27	6.35	-78.62	-13.00	-65.62	V
78.5000	-65.76	1.03	-0.43	-67.22	-13.00	-54.22	H
138.6400	-58.89	1.39	-0.38	-60.66	-13.00	-47.66	H
342.3400	-70.68	2.18	5.8	-67.06	-13.00	-54.06	H
448.0700	-71.28	2.58	5.74	-68.12	-13.00	-55.12	H
529.5500	-74.43	2.75	6	-71.18	-13.00	-58.18	H
914.6400	-76.82	3.57	6.6	-73.79	-13.00	-60.79	H

Remark:

1. Measuring frequencies from 1 GHz to the 10th harmonic of highest fundamental frequency.
2. Measurements above show only up to 6 maximum emissions noted, or would be lesser, with " N/A " remark, if no specific emissions from the EUT are recorded (ie: margin>20dB from the applicable limit) and considered that's already beyond the background noise floor.



Operation Mode: WCDMA / HSDPA Band V / TX / CH 4132 **Test Date:** December 10, 2014

Temperature: 26°C **Tested by:** Dennis Li

Humidity: 60 % RH **Polarity:** Ver. / Hor.

Frequency (MHz)	S.G. (dBm)	Cable loss (dB)	Ant.Gain (dBi)	Emission level (dBm)	Limit (dBm)	Margin (dB)	Antenna Polarization (V/H)
101.7800	-62.82	1.16	-0.64	-64.62	-13.00	-51.62	V
150.2800	-63.12	1.43	0.71	-63.84	-13.00	-50.84	V
323.9100	-73.25	2.17	5.7	-69.72	-13.00	-56.72	V
448.0700	-79.3	2.58	5.74	-76.14	-13.00	-63.14	V
505.3000	-80.4	2.69	5.95	-77.14	-13.00	-64.14	V
769.1400	-80.43	3.27	6.39	-77.31	-13.00	-64.31	V
78.5000	-63.48	1.03	-0.43	-64.94	-13.00	-51.94	H
138.6400	-56.89	1.39	-0.38	-58.66	-13.00	-45.66	H
345.2500	-67.72	2.2	5.8	-64.12	-13.00	-51.12	H
439.3400	-70.06	2.53	5.9	-66.69	-13.00	-53.69	H
529.5500	-72.18	2.75	6	-68.93	-13.00	-55.93	H
665.3500	-76.71	3.06	6.3	-73.47	-13.00	-60.47	H

Remark:

1. *Measuring frequencies from 1 GHz to the 10th harmonic of highest fundamental frequency.*
2. *Measurements above show only up to 6 maximum emissions noted, or would be lesser, with " N/A " remark, if no specific emissions from the EUT are recorded (ie: margin > 20dB from the applicable limit) and considered that's already beyond the background noise floor.*



Operation Mode: WCDMA / HSDPA Band V / TX / CH 4182 **Test Date:** December 10, 2014

Temperature: 26°C **Tested by:** Dennis Li

Humidity: 60 % RH **Polarity:** Ver. / Hor.

Frequency (MHz)	S.G. (dBm)	Cable loss (dB)	Ant.Gain (dBi)	Emission level (dBm)	Limit (dBm)	Margin (dB)	Antenna Polarization (V/H)
101.7800	-63.47	1.16	-0.64	-65.27	-13.00	-52.27	V
150.2800	-63.62	1.43	0.71	-64.34	-13.00	-51.34	V
323.9100	-76.22	2.17	5.7	-72.69	-13.00	-59.69	V
448.0700	-79.75	2.58	5.74	-76.59	-13.00	-63.59	V
562.5300	-81.19	2.85	6.01	-78.03	-13.00	-65.03	V
736.1600	-81.39	3.2	6.23	-78.36	-13.00	-65.36	V
78.5000	-65.14	1.03	-0.43	-66.60	-13.00	-53.60	H
138.6400	-60.02	1.39	-0.38	-61.79	-13.00	-48.79	H
330.7000	-71.1	2.16	5.71	-67.55	-13.00	-54.55	H
439.3400	-72.38	2.53	5.9	-69.01	-13.00	-56.01	H
529.5500	-74.89	2.75	6	-71.64	-13.00	-58.64	H
625.5800	-78.06	2.96	6.16	-74.86	-13.00	-61.86	H

Remark:

1. *Measuring frequencies from 1 GHz to the 10th harmonic of highest fundamental frequency.*
2. *Measurements above show only up to 6 maximum emissions noted, or would be lesser, with " N/A " remark, if no specific emissions from the EUT are recorded (ie: margin > 20dB from the applicable limit) and considered that's already beyond the background noise floor.*



Operation Mode: WCDMA / HSDPA Band V / TX / CH 4233 **Test Date:** December 10, 2014

Temperature: 26°C **Tested by:** Dennis Li

Humidity: 60 % RH **Polarity:** Ver. / Hor.

Frequency (MHz)	S.G. (dBm)	Cable loss (dB)	Ant.Gain (dBi)	Emission level (dBm)	Limit (dBm)	Margin (dB)	Antenna Polarization (V/H)
101.7800	-63.69	1.16	-0.64	-65.49	-13.00	-52.49	V
150.2800	-64.21	1.43	0.71	-64.93	-13.00	-51.93	V
330.7000	-75.84	2.16	5.71	-72.29	-13.00	-59.29	V
448.0700	-79.11	2.58	5.74	-75.95	-13.00	-62.95	V
541.1900	-82.17	2.78	6.25	-78.70	-13.00	-65.70	V
703.1800	-82.68	3.12	6.36	-79.44	-13.00	-66.44	V
78.5000	-64.87	1.03	-0.43	-66.33	-13.00	-53.33	H
138.6400	-60.33	1.39	-0.38	-62.10	-13.00	-49.10	H
342.3400	-70.48	2.18	5.8	-66.86	-13.00	-53.86	H
439.3400	-71.62	2.53	5.9	-68.25	-13.00	-55.25	H
604.2400	-77.66	2.92	6.36	-74.22	-13.00	-61.22	H
748.7700	-77.51	3.2	6.1	-74.61	-13.00	-61.61	H

Remark:

1. *Measuring frequencies from 1 GHz to the 10th harmonic of highest fundamental frequency.*
2. *Measurements above show only up to 6 maximum emissions noted, or would be lesser, with “ N/A ” remark, if no specific emissions from the EUT are recorded (ie: margin > 20dB from the applicable limit) and considered that's already beyond the background noise floor.*



Operation Mode: WCDMA / HSUPA Band II / TX / CH 9262

Test Date: December 10, 2014

Temperature: 26°C

Tested by: Dennis Li

Humidity: 60 % RH

Polarity: Ver. / Hor.

Frequency (MHz)	S.G. (dBm)	Cable loss (dB)	Ant.Gain (dBi)	Emission level (dBm)	Limit (dBm)	Margin (dB)	Antenna Polarization (V/H)
101.7800	-63.89	1.16	-0.64	-65.69	-13.00	-52.69	V
150.2800	-63.28	1.43	0.71	-64.00	-13.00	-51.00	V
330.7000	-77.41	2.16	5.71	-73.86	-13.00	-60.86	V
426.7300	-80.67	2.48	5.8	-77.35	-13.00	-64.35	V
585.8100	-80.63	2.89	6.11	-77.41	-13.00	-64.41	V
770.1100	-80.8	3.27	6.38	-77.69	-13.00	-64.69	V
78.5000	-64.02	1.03	-0.43	-65.48	-13.00	-52.48	H
138.6400	-59.21	1.39	-0.38	-60.98	-13.00	-47.98	H
342.3400	-71.14	2.18	5.8	-67.52	-13.00	-54.52	H
439.3400	-72.44	2.53	5.9	-69.07	-13.00	-56.07	H
529.5500	-73.65	2.75	6	-70.40	-13.00	-57.40	H
768.1700	-77.68	3.26	6.38	-74.56	-13.00	-61.56	H

Remark:

1. Measuring frequencies from 1 GHz to the 10th harmonic of highest fundamental frequency.
2. Measurements above show only up to 6 maximum emissions noted, or would be lesser, with " N/A " remark, if no specific emissions from the EUT are recorded (ie: margin > 20dB from the applicable limit) and considered that's already beyond the background noise floor.



Operation Mode: WCDMA / HSUPA Band II /
TX / CH 9400

Test Date: December 10, 2014

Temperature: 26°C

Tested by: Dennis Li

Humidity: 60 % RH

Polarity: Ver. / Hor.

Frequency (MHz)	S.G. (dBm)	Cable loss (dB)	Ant.Gain (dBi)	Emission level (dBm)	Limit (dBm)	Margin (dB)	Antenna Polarization (V/H)
101.7800	-63.8	1.16	-0.64	-65.60	-13.00	-52.60	V
150.2800	-62.91	1.43	0.71	-63.63	-13.00	-50.63	V
330.7000	-77.74	2.16	5.71	-74.19	-13.00	-61.19	V
448.0700	-79.67	2.58	5.74	-76.51	-13.00	-63.51	V
541.1900	-81.26	2.78	6.25	-77.79	-13.00	-64.79	V
901.0600	-80.23	3.52	6.6	-77.15	-13.00	-64.15	V
78.5000	-65.49	1.03	-0.43	-66.95	-13.00	-53.95	H
138.6400	-59.43	1.39	-0.38	-61.20	-13.00	-48.20	H
342.3400	-71.67	2.18	5.8	-68.05	-13.00	-55.05	H
435.4600	-73.09	2.51	5.86	-69.74	-13.00	-56.74	H
529.5500	-74.41	2.75	6	-71.16	-13.00	-58.16	H
769.1400	-77.9	3.27	6.39	-74.78	-13.00	-61.78	H

Remark:

1. Measuring frequencies from 1 GHz to the 10th harmonic of highest fundamental frequency.
2. Measurements above show only up to 6 maximum emissions noted, or would be lesser, with " N/A " remark, if no specific emissions from the EUT are recorded (ie: margin>20dB from the applicable limit) and considered that's already beyond the background noise floor.



Operation Mode: WCDMA / HSUPA Band II / TX / CH 9538

Test Date: December 10, 2014

Temperature: 26°C

Tested by: Dennis Li

Humidity: 60 % RH

Polarity: Ver. / Hor.

Frequency (MHz)	S.G. (dBm)	Cable loss (dB)	Ant.Gain (dBi)	Emission level (dBm)	Limit (dBm)	Margin (dB)	Antenna Polarization (V/H)
101.7800	-63.73	1.16	-0.64	-65.53	-13.00	-52.53	V
150.2800	-62.85	1.43	0.71	-63.57	-13.00	-50.57	V
330.7000	-77.56	2.16	5.71	-74.01	-13.00	-61.01	V
448.0700	-78.27	2.58	5.74	-75.11	-13.00	-62.11	V
585.8100	-81.28	2.89	6.11	-78.06	-13.00	-65.06	V
729.3700	-81.6	3.18	6.4	-78.38	-13.00	-65.38	V
95.9600	-65.52	1.13	0.26	-66.39	-13.00	-53.39	H
138.6400	-59.39	1.39	-0.38	-61.16	-13.00	-48.16	H
342.3400	-71.45	2.18	5.8	-67.83	-13.00	-54.83	H
439.3400	-72.9	2.53	5.9	-69.53	-13.00	-56.53	H
577.0800	-77.51	2.88	6.04	-74.35	-13.00	-61.35	H
799.2100	-77.33	3.33	6.49	-74.17	-13.00	-61.17	H

Remark:

1. Measuring frequencies from 1 GHz to the 10th harmonic of highest fundamental frequency.
2. Measurements above show only up to 6 maximum emissions noted, or would be lesser, with " N/A " remark, if no specific emissions from the EUT are recorded (ie: margin>20dB from the applicable limit) and considered that's already beyond the background noise floor.



Operation Mode: WCDMA / HSUPA Band V / TX / CH 4132

Test Date: December 10, 2014

Temperature: 26°C

Tested by: Dennis Li

Humidity: 60 % RH

Polarity: Ver. / Hor.

Frequency (MHz)	S.G. (dBm)	Cable loss (dB)	Ant.Gain (dBi)	Emission level (dBm)	Limit (dBm)	Margin (dB)	Antenna Polarization (V/H)
101.7800	-63.02	1.16	-0.64	-64.82	-13.00	-51.82	V
150.2800	-63.26	1.43	0.71	-63.98	-13.00	-50.98	V
323.9100	-75.19	2.17	5.7	-71.66	-13.00	-58.66	V
505.3000	-79.67	2.69	5.95	-76.41	-13.00	-63.41	V
644.9800	-81.59	3.02	6.19	-78.42	-13.00	-65.42	V
769.1400	-80.58	3.27	6.39	-77.46	-13.00	-64.46	V
78.5000	-63.76	1.03	-0.43	-65.22	-13.00	-52.22	H
138.6400	-58.19	1.39	-0.38	-59.96	-13.00	-46.96	H
346.2200	-70.03	2.21	5.8	-66.44	-13.00	-53.44	H
439.3400	-70.57	2.53	5.9	-67.20	-13.00	-54.20	H
529.5500	-73.31	2.75	6	-70.06	-13.00	-57.06	H
625.5800	-76.24	2.96	6.16	-73.04	-13.00	-60.04	H

Remark:

1. Measuring frequencies from 1 GHz to the 10th harmonic of highest fundamental frequency.
2. Measurements above show only up to 6 maximum emissions noted, or would be lesser, with " N/A " remark, if no specific emissions from the EUT are recorded (ie: margin > 20dB from the applicable limit) and considered that's already beyond the background noise floor.



Operation Mode: WCDMA / HSUPA Band V / TX / CH 4182

Test Date: December 10, 2014

Temperature: 26°C

Tested by: Dennis Li

Humidity: 60 % RH

Polarity: Ver. / Hor.

Frequency (MHz)	S.G. (dBm)	Cable loss (dB)	Ant.Gain (dBi)	Emission level (dBm)	Limit (dBm)	Margin (dB)	Antenna Polarization (V/H)
101.7800	-64.15	1.16	-0.64	-65.95	-13.00	-52.95	V
161.9200	-65.82	1.5	1.61	-65.71	-13.00	-52.71	V
330.7000	-77.54	2.16	5.71	-73.99	-13.00	-60.99	V
448.0700	-78.72	2.58	5.74	-75.56	-13.00	-62.56	V
541.1900	-81.66	2.78	6.25	-78.19	-13.00	-65.19	V
612.9700	-82.07	2.94	6.23	-78.78	-13.00	-65.78	V
71.7100	-64.17	0.97	-1.61	-66.75	-13.00	-53.75	H
138.6400	-59.35	1.39	-0.38	-61.12	-13.00	-48.12	H
330.7000	-69.33	2.16	5.71	-65.78	-13.00	-52.78	H
439.3400	-72.14	2.53	5.9	-68.77	-13.00	-55.77	H
529.5500	-74.4	2.75	6	-71.15	-13.00	-58.15	H
619.7600	-77.39	2.94	6.11	-74.22	-13.00	-61.22	H

Remark:

1. Measuring frequencies from 1 GHz to the 10th harmonic of highest fundamental frequency.
2. Measurements above show only up to 6 maximum emissions noted, or would be lesser, with " N/A " remark, if no specific emissions from the EUT are recorded (ie: margin>20dB from the applicable limit) and considered that's already beyond the background noise floor.



Operation Mode: WCDMA / HSUPA Band V / TX / CH 4233

Test Date: December 10, 2014

Temperature: 26°C

Tested by: Dennis Li

Humidity: 60 % RH

Polarity: Ver. / Hor.

Frequency (MHz)	S.G. (dBm)	Cable loss (dB)	Ant.Gain (dBi)	Emission level (dBm)	Limit (dBm)	Margin (dB)	Antenna Polarization (V/H)
101.7800	-63.28	1.16	-0.64	-65.08	-13.00	-52.08	V
150.2800	-63.94	1.43	0.71	-64.66	-13.00	-51.66	V
323.9100	-76.38	2.17	5.7	-72.85	-13.00	-59.85	V
448.0700	-78.94	2.58	5.74	-75.78	-13.00	-62.78	V
505.3000	-80.37	2.69	5.95	-77.11	-13.00	-64.11	V
632.3700	-81.46	2.98	6.19	-78.25	-13.00	-65.25	V
71.7100	-64.67	0.97	-1.61	-67.25	-13.00	-54.25	H
138.6400	-60.27	1.39	-0.38	-62.04	-13.00	-49.04	H
345.2500	-71.03	2.2	5.8	-67.43	-13.00	-54.43	H
439.3400	-72.68	2.53	5.9	-69.31	-13.00	-56.31	H
529.5500	-74.54	2.75	6	-71.29	-13.00	-58.29	H
657.5900	-78.79	3.05	6.3	-75.54	-13.00	-62.54	H

Remark:

1. Measuring frequencies from 1 GHz to the 10th harmonic of highest fundamental frequency.
2. Measurements above show only up to 6 maximum emissions noted, or would be lesser, with " N/A " remark, if no specific emissions from the EUT are recorded (ie: margin>20dB from the applicable limit) and considered that's already beyond the background noise floor.



Above 1GHz

Operation Mode: GSM 850 / TX / CH 128

Test Date: December 10, 2014

Temperature: 26°C

Tested by: Dennis Li

Humidity: 60 % RH

Polarity: Ver. / Hor.

Frequency (MHz)	S.G. (dBm)	Cable loss (dB)	Ant.Gain (dBi)	Emission level (dBm)	Limit (dBm)	Margin (dB)	Antenna Polarization (V/H)
1651.000	-44.14	5.05	6.03	-43.16	-13.00	-30.16	V
6593.000	-42.92	11.22	11.41	-42.73	-13.00	-29.73	V
N/A							
1651.000	-36.84	5.05	6.03	-35.86	-13.00	-22.86	H
4122.000	-45.89	8.47	9.5	-44.86	-13.00	-31.86	H
N/A							

Remark:

1. Measuring frequencies from 1 GHz to the 10th harmonic of highest fundamental frequency.
2. Measurements above show only up to 6 maximum emissions noted, or would be lesser, with " N/A " remark, if no specific emissions from the EUT are recorded (ie: margin > 20dB from the applicable limit) and considered that's already beyond the background noise floor.



Operation Mode: GSM 850 / TX / CH 190

Test Date: December 10, 2014

Temperature: 26°C

Tested by: Dennis Li

Humidity: 60 % RH

Polarity: Ver. / Hor.

Frequency (MHz)	S.G. (dBm)	Cable loss (dB)	Ant.Gain (dBi)	Emission level (dBm)	Limit (dBm)	Margin (dB)	Antenna Polarization (V/H)
1672.000	-38.65	5.07	5.99	-37.73	-13.00	-24.73	V
4185.000	-44.33	8.49	9.55	-43.27	-13.00	-30.27	V
N/A							
1672.000	-40.02	5.07	5.99	-39.10	-13.00	-26.10	H
4185.000	-47.37	8.49	9.55	-46.31	-13.00	-33.31	H
N/A							

Remark:

1. Measuring frequencies from 1 GHz to the 10th harmonic of highest fundamental frequency.
2. Measurements above show only up to 6 maximum emissions noted, or would be lesser, with " N/A " remark, if no specific emissions from the EUT are recorded (ie: margin > 20dB from the applicable limit) and considered that's already beyond the background noise floor.



Operation Mode: GSM 850 / TX / CH 251

Test Date: December 10, 2014

Temperature: 26°C

Tested by: Dennis Li

Humidity: 60 % RH

Polarity: Ver. / Hor.

Frequency (MHz)	S.G. (dBm)	Cable loss (dB)	Ant.Gain (dBi)	Emission level (dBm)	Limit (dBm)	Margin (dB)	Antenna Polarization (V/H)
1700.000	-46.76	5.11	5.94	-45.93	-13.00	-32.93	V
4248.000	-49.17	8.54	9.6	-48.11	-13.00	-35.11	V
N/A							
1700.000	-42.4	5.11	5.94	-41.57	-13.00	-28.57	H
2547.000	-44.9	6.42	6.22	-45.10	-13.00	-32.10	H
N/A							

Remark:

1. Measuring frequencies from 1 GHz to the 10th harmonic of highest fundamental frequency.
2. Measurements above show only up to 6 maximum emissions noted, or would be lesser; with " N/A " remark, if no specific emissions from the EUT are recorded (ie: margin > 20dB from the applicable limit) and considered that's already beyond the background noise floor.



Operation Mode: GPRS 850 / TX / CH 128

Test Date: December 10, 2014

Temperature: 26°C

Tested by: Dennis Li

Humidity: 60 % RH

Polarity: Ver. / Hor.

Frequency (MHz)	S.G. (dBm)	Cable loss (dB)	Ant.Gain (dBi)	Emission level (dBm)	Limit (dBm)	Margin (dB)	Antenna Polarization (V/H)
1651.000	-46.68	5.05	6.03	-45.70	-13.00	-32.70	V
4122.000	-48.91	8.47	9.5	-47.88	-13.00	-34.88	V
N/A							
1651.000	-40.26	5.05	6.03	-39.28	-13.00	-26.28	H
4122.000	-48.4	8.47	9.5	-47.37	-13.00	-34.37	H
N/A							

Remark:

1. Measuring frequencies from 1 GHz to the 10th harmonic of highest fundamental frequency.
2. Measurements above show only up to 6 maximum emissions noted, or would be lesser; with " N/A " remark, if no specific emissions from the EUT are recorded (ie: margin > 20dB from the applicable limit) and considered that's already beyond the background noise floor.



Operation Mode: GPRS 850 / TX / CH 190

Test Date: December 10, 2014

Temperature: 26°C

Tested by: Dennis Li

Humidity: 60 % RH

Polarity: Ver. / Hor.

Frequency (MHz)	S.G. (dBm)	Cable loss (dB)	Ant.Gain (dBi)	Emission level (dBm)	Limit (dBm)	Margin (dB)	Antenna Polarization (V/H)
1672.000	-48.82	5.07	5.99	-47.90	-13.00	-34.90	V
3527.000	-50.98	7.93	8.93	-49.98	-13.00	-36.98	V
N/A							
1672.000	-43.2	5.07	5.99	-42.28	-13.00	-29.28	H
3527.000	-48.53	7.93	8.93	-47.53	-13.00	-34.53	H
N/A							

Remark:

1. Measuring frequencies from 1 GHz to the 10th harmonic of highest fundamental frequency.
2. Measurements above show only up to 6 maximum emissions noted, or would be lesser, with " N/A " remark, if no specific emissions from the EUT are recorded (ie: margin>20dB from the applicable limit) and considered that's already beyond the background noise floor.



Operation Mode: GPRS 850 / TX / CH 251

Test Date: December 10, 2014

Temperature: 26°C

Tested by: Dennis Li

Humidity: 60 % RH

Polarity: Ver. / Hor.

Frequency (MHz)	S.G. (dBm)	Cable loss (dB)	Ant.Gain (dBi)	Emission level (dBm)	Limit (dBm)	Margin (dB)	Antenna Polarization (V/H)
1945.000	-49.48	5.57	5.5	-49.55	-13.00	-36.55	V
4241.000	-50.73	8.54	9.59	-49.68	-13.00	-36.68	V
N/A							
1700.000	-44.06	5.11	5.94	-43.23	-13.00	-30.23	H
2547.000	-47.96	6.42	6.22	-48.16	-13.00	-35.16	H
N/A							

Remark:

1. Measuring frequencies from 1 GHz to the 10th harmonic of highest fundamental frequency.
2. Measurements above show only up to 6 maximum emissions noted, or would be lesser, with " N/A " remark, if no specific emissions from the EUT are recorded (ie: margin>20dB from the applicable limit) and considered that's already beyond the background noise floor.



Operation Mode: GSM 1900 / TX / CH 512

Test Date: December 10, 2014

Temperature: 26°C

Tested by: Dennis Li

Humidity: 60 % RH

Polarity: Ver. / Hor.

Frequency (MHz)	S.G. (dBm)	Cable loss (dB)	Ant.Gain (dBi)	Emission level (dBm)	Limit (dBm)	Margin (dB)	Antenna Polarization (V/H)
3702.000	-42.99	8.2	9.1	-42.09	-13.00	-29.09	V
5921.000	-52.88	10.49	10.88	-52.49	-13.00	-39.49	V
N/A							
3702.000	-37.92	8.2	9.1	-37.02	-13.00	-24.02	H
5550.000	-50.76	10.06	10.81	-50.01	-13.00	-37.01	H
N/A							

Remark:

1. Measuring frequencies from 1 GHz to the 10th harmonic of highest fundamental frequency.
2. Measurements above show only up to 6 maximum emissions noted, or would be lesser, with " N/A " remark, if no specific emissions from the EUT are recorded (ie: margin>20dB from the applicable limit) and considered that's already beyond the background noise floor.



Operation Mode: GSM 1900 / TX / CH 661

Test Date: December 10, 2014

Temperature: 26°C

Tested by: Dennis Li

Humidity: 60 % RH

Polarity: Ver. / Hor.

Frequency (MHz)	S.G. (dBm)	Cable loss (dB)	Ant.Gain (dBi)	Emission level (dBm)	Limit (dBm)	Margin (dB)	Antenna Polarization (V/H)
3758.000	-45.52	8.23	9.16	-44.59	-13.00	-31.59	V
6817.000	-48.37	11.34	11.68	-48.03	-13.00	-35.03	V
N/A							
3758.000	-41.74	8.23	9.16	-40.81	-13.00	-27.81	H
5641.000	-51.7	10.18	10.83	-51.05	-13.00	-38.05	H
N/A							

Remark:

1. Measuring frequencies from 1 GHz to the 10th harmonic of highest fundamental frequency.
2. Measurements above show only up to 6 maximum emissions noted, or would be lesser, with " N/A " remark, if no specific emissions from the EUT are recorded (ie: margin>20dB from the applicable limit) and considered that's already beyond the background noise floor.



Operation Mode: GSM 1900 / TX / CH 810

Test Date: December 10, 2014

Temperature: 26°C

Tested by: Dennis Li

Humidity: 60 % RH

Polarity: Ver. / Hor.

Frequency (MHz)	S.G. (dBm)	Cable loss (dB)	Ant.Gain (dBi)	Emission level (dBm)	Limit (dBm)	Margin (dB)	Antenna Polarization (V/H)
3821.000	-46.29	8.29	9.22	-45.36	-13.00	-32.36	V
6313.000	-51.59	10.81	11.15	-51.25	-13.00	-38.25	V
N/A							
3821.000	-43.9	8.29	9.22	-42.97	-13.00	-29.97	H
6180.000	-50.11	11.1	11.04	-50.17	-13.00	-37.17	H
N/A							

Remark:

1. Measuring frequencies from 1 GHz to the 10th harmonic of highest fundamental frequency.
2. Measurements above show only up to 6 maximum emissions noted, or would be lesser, with " N/A " remark, if no specific emissions from the EUT are recorded (ie: margin>20dB from the applicable limit) and considered that's already beyond the background noise floor.



Operation Mode: GPRS 1900 / TX / CH 512

Test Date: December 10, 2014

Temperature: 26°C

Tested by: Dennis Li

Humidity: 60 % RH

Polarity: Ver. / Hor.

Frequency (MHz)	S.G. (dBm)	Cable loss (dB)	Ant.Gain (dBi)	Emission level (dBm)	Limit (dBm)	Margin (dB)	Antenna Polarization (V/H)
3702.000	-42.89	8.2	9.1	-41.99	-13.00	-28.99	V
6131.000	-52.06	10.81	11	-51.87	-13.00	-38.87	V
N/A							
3702.000	-37.05	8.2	9.1	-36.15	-13.00	-23.15	H
5550.000	-50.1	10.06	10.81	-49.35	-13.00	-36.35	H
N/A							

Remark:

1. Measuring frequencies from 1 GHz to the 10th harmonic of highest fundamental frequency.
2. Measurements above show only up to 6 maximum emissions noted, or would be lesser, with " N/A " remark, if no specific emissions from the EUT are recorded (ie: margin>20dB from the applicable limit) and considered that's already beyond the background noise floor.



Operation Mode: GPRS 1900 / TX / CH 661

Test Date: December 10, 2014

Temperature: 26°C

Tested by: Dennis Li

Humidity: 60 % RH

Polarity: Ver. / Hor.

Frequency (MHz)	S.G. (dBm)	Cable loss (dB)	Ant.Gain (dBi)	Emission level (dBm)	Limit (dBm)	Margin (dB)	Antenna Polarization (V/H)
3758.000	-45.77	8.23	9.16	-44.84	-13.00	-31.84	V
5641.000	-54.63	10.18	10.83	-53.98	-13.00	-40.98	V
N/A							
3758.000	-41.97	8.23	9.16	-41.04	-13.00	-28.04	H
5641.000	-51.16	10.18	10.83	-50.51	-13.00	-37.51	H
N/A							

Remark:

1. Measuring frequencies from 1 GHz to the 10th harmonic of highest fundamental frequency.
2. Measurements above show only up to 6 maximum emissions noted, or would be lesser, with " N/A " remark, if no specific emissions from the EUT are recorded (ie: margin>20dB from the applicable limit) and considered that's already beyond the background noise floor.



Operation Mode: GPRS 1900 / TX / CH 810

Test Date: December 10, 2014

Temperature: 26°C

Tested by: Dennis Li

Humidity: 60 % RH

Polarity: Ver. / Hor.

Frequency (MHz)	S.G. (dBm)	Cable loss (dB)	Ant.Gain (dBi)	Emission level (dBm)	Limit (dBm)	Margin (dB)	Antenna Polarization (V/H)
3821.000	-44.96	8.29	9.22	-44.03	-13.00	-31.03	V
6831.000	-49.46	11.37	11.7	-49.13	-13.00	-36.13	V
N/A							
3821.000	-40.82	8.29	9.22	-39.89	-13.00	-26.89	H
5732.000	-51.8	10.24	10.85	-51.19	-13.00	-38.19	H
N/A							

Remark:

1. Measuring frequencies from 1 GHz to the 10th harmonic of highest fundamental frequency.
2. Measurements above show only up to 6 maximum emissions noted, or would be lesser, with " N/A " remark, if no specific emissions from the EUT are recorded (ie: margin>20dB from the applicable limit) and considered that's already beyond the background noise floor.



Operation Mode: EDGE 850 / TX / CH 128

Test Date: December 10, 2014

Temperature: 26°C

Tested by: Dennis Li

Humidity: 60 % RH

Polarity: Ver. / Hor.

Frequency (MHz)	S.G. (dBm)	Cable loss (dB)	Ant.Gain (dBi)	Emission level (dBm)	Limit (dBm)	Margin (dB)	Antenna Polarization (V/H)
1651.000	-47	5.05	6.03	-46.02	-13.00	-33.02	V
4122.000	-50.19	8.47	9.5	-49.16	-13.00	-36.16	V
N/A							
1651.000	-39.95	5.05	6.03	-38.97	-13.00	-25.97	H
4122.000	-47.18	8.47	9.5	-46.15	-13.00	-33.15	H
N/A							

Remark:

1. Measuring frequencies from 1 GHz to the 10th harmonic of highest fundamental frequency.
2. Measurements above show only up to 6 maximum emissions noted, or would be lesser; with " N/A " remark, if no specific emissions from the EUT are recorded (ie: margin > 20dB from the applicable limit) and considered that's already beyond the background noise floor.



Operation Mode: EDGE 850 / TX / CH 190

Test Date: December 10, 2014

Temperature: 26°C

Tested by: Dennis Li

Humidity: 60 % RH

Polarity: Ver. / Hor.

Frequency (MHz)	S.G. (dBm)	Cable loss (dB)	Ant.Gain (dBi)	Emission level (dBm)	Limit (dBm)	Margin (dB)	Antenna Polarization (V/H)
1672.000	-48.66	5.07	5.99	-47.74	-13.00	-34.74	V
4185.000	-50.79	8.49	9.55	-49.73	-13.00	-36.73	V
N/A							
1672.000	-42.86	5.07	5.99	-41.94	-13.00	-28.94	H
4185.000	-49.67	8.49	9.55	-48.61	-13.00	-35.61	H
N/A							

Remark:

1. Measuring frequencies from 1 GHz to the 10th harmonic of highest fundamental frequency.
2. Measurements above show only up to 6 maximum emissions noted, or would be lesser; with " N/A " remark, if no specific emissions from the EUT are recorded (ie: margin > 20dB from the applicable limit) and considered that's already beyond the background noise floor.



Operation Mode: EDGE 850 / TX / CH 251

Test Date: December 10, 2014

Temperature: 26°C

Tested by: Dennis Li

Humidity: 60 % RH

Polarity: Ver. / Hor.

Frequency (MHz)	S.G. (dBm)	Cable loss (dB)	Ant.Gain (dBi)	Emission level (dBm)	Limit (dBm)	Margin (dB)	Antenna Polarization (V/H)
1700.000	-50.96	5.11	5.94	-50.13	-13.00	-37.13	V
4241.000	-52.2	8.54	9.59	-51.15	-13.00	-38.15	V
N/A							
1700.000	-44.03	5.11	5.94	-43.20	-13.00	-30.20	H
3576.000	-48.95	8.05	8.98	-48.02	-13.00	-35.02	H
N/A							

Remark:

1. Measuring frequencies from 1 GHz to the 10th harmonic of highest fundamental frequency.
2. Measurements above show only up to 6 maximum emissions noted, or would be lesser, with " N/A " remark, if no specific emissions from the EUT are recorded (ie: margin > 20dB from the applicable limit) and considered that's already beyond the background noise floor.



Operation Mode: EDGE 1900 / TX / CH 512

Test Date: December 10, 2014

Temperature: 26°C

Tested by: Dennis Li

Humidity: 60 % RH

Polarity: Ver. / Hor.

Frequency (MHz)	S.G. (dBm)	Cable loss (dB)	Ant.Gain (dBi)	Emission level (dBm)	Limit (dBm)	Margin (dB)	Antenna Polarization (V/H)
3702.000	-42.82	8.2	9.1	-41.92	-13.00	-28.92	V
5550.000	-53.15	10.06	10.81	-52.40	-13.00	-39.40	V
N/A							
3702.000	-36.06	8.2	9.1	-35.16	-13.00	-22.16	H
6320.000	-49.79	10.84	11.16	-49.47	-13.00	-36.47	H
N/A							

Remark:

1. Measuring frequencies from 1 GHz to the 10th harmonic of highest fundamental frequency.
2. Measurements above show only up to 6 maximum emissions noted, or would be lesser, with " N/A " remark, if no specific emissions from the EUT are recorded (ie: margin > 20dB from the applicable limit) and considered that's already beyond the background noise floor.



Operation Mode: EDGE 1900 / TX / CH 661

Test Date: December 10, 2014

Temperature: 26°C

Tested by: Dennis Li

Humidity: 60 % RH

Polarity: Ver. / Hor.

Frequency (MHz)	S.G. (dBm)	Cable loss (dB)	Ant.Gain (dBi)	Emission level (dBm)	Limit (dBm)	Margin (dB)	Antenna Polarization (V/H)
3758.000	-45.45	8.23	9.16	-44.52	-13.00	-31.52	V
5578.000	-54.49	10.13	10.82	-53.80	-13.00	-40.80	V
N/A							
3758.000	-42.59	8.23	9.16	-41.66	-13.00	-28.66	H
6117.000	-51.82	10.72	10.99	-51.55	-13.00	-38.55	H
N/A							

Remark:

1. Measuring frequencies from 1 GHz to the 10th harmonic of highest fundamental frequency.
2. Measurements above show only up to 6 maximum emissions noted, or would be lesser, with " N/A " remark, if no specific emissions from the EUT are recorded (ie: margin > 20dB from the applicable limit) and considered that's already beyond the background noise floor.



Operation Mode: EDGE 1900 / TX / CH 810

Test Date: December 10, 2014

Temperature: 26°C

Tested by: Dennis Li

Humidity: 60 % RH

Polarity: Ver. / Hor.

Frequency (MHz)	S.G. (dBm)	Cable loss (dB)	Ant.Gain (dBi)	Emission level (dBm)	Limit (dBm)	Margin (dB)	Antenna Polarization (V/H)
3821.000	-47.06	8.29	9.22	-46.13	-13.00	-33.13	V
5872.000	-52.56	10.41	10.87	-52.10	-13.00	-39.10	V
N/A							
3821.000	-41.78	8.29	9.22	-40.85	-13.00	-27.85	H
6180.000	-51.16	11.1	11.04	-51.22	-13.00	-38.22	H
N/A							

Remark:

1. Measuring frequencies from 1 GHz to the 10th harmonic of highest fundamental frequency.
2. Measurements above show only up to 6 maximum emissions noted, or would be lesser, with " N/A " remark, if no specific emissions from the EUT are recorded (ie: margin > 20dB from the applicable limit) and considered that's already beyond the background noise floor.



Operation Mode: WCDMA Band II / TX / CH 9262

Test Date: December 10, 2014

Temperature: 26°C

Tested by: Dennis Li

Humidity: 60 % RH

Polarity: Ver. / Hor.

Frequency (MHz)	S.G. (dBm)	Cable loss (dB)	Ant.Gain (dBi)	Emission level (dBm)	Limit (dBm)	Margin (dB)	Antenna Polarization (V/H)
3709.000	-45.72	8.21	9.11	-44.82	-13.00	-31.82	V
6502.000	-50.19	11.04	11.3	-49.93	-13.00	-36.93	V
N/A							
3709.000	-43.7	8.21	9.11	-42.80	-13.00	-29.80	H
6096.000	-51.47	10.63	10.98	-51.12	-13.00	-38.12	H
N/A							

Remark:

1. Measuring frequencies from 1 GHz to the 10th harmonic of highest fundamental frequency.
2. Measurements above show only up to 6 maximum emissions noted, or would be lesser, with " N/A " remark, if no specific emissions from the EUT are recorded (ie: margin > 20dB from the applicable limit) and considered that's already beyond the background noise floor.



Operation Mode: WCDMA Band II / TX / CH 9400

Test Date: December 10, 2014

Temperature: 26°C

Tested by: Dennis Li

Humidity: 60 % RH

Polarity: Ver. / Hor.

Frequency (MHz)	S.G. (dBm)	Cable loss (dB)	Ant.Gain (dBi)	Emission level (dBm)	Limit (dBm)	Margin (dB)	Antenna Polarization (V/H)
3758.000	-45.85	8.23	9.16	-44.92	-13.00	-31.92	V
6110.000	-52.24	10.68	10.99	-51.93	-13.00	-38.93	V
N/A							
3758.000	-43.73	8.23	9.16	-42.80	-13.00	-29.80	H
6250.000	-49.71	10.98	11.1	-49.59	-13.00	-36.59	H
N/A							

Remark:

1. Measuring frequencies from 1 GHz to the 10th harmonic of highest fundamental frequency.
2. Measurements above show only up to 6 maximum emissions noted, or would be lesser, with " N/A " remark, if no specific emissions from the EUT are recorded (ie: margin > 20dB from the applicable limit) and considered that's already beyond the background noise floor.



Operation Mode: WCDMA Band II / TX / CH 9538

Test Date: December 10, 2014

Temperature: 26°C

Tested by: Dennis Li

Humidity: 60 % RH

Polarity: Ver. / Hor.

Frequency (MHz)	S.G. (dBm)	Cable loss (dB)	Ant.Gain (dBi)	Emission level (dBm)	Limit (dBm)	Margin (dB)	Antenna Polarization (V/H)
3814.000	-45.11	8.28	9.21	-44.18	-13.00	-31.18	V
6019.000	-52.77	10.79	10.92	-52.64	-13.00	-39.64	V
N/A							
3814.000	-45.07	8.28	9.21	-44.14	-13.00	-31.14	H
5389.000	-52.81	9.8	10.76	-51.85	-13.00	-38.85	H
N/A							

Remark:

1. Measuring frequencies from 1 GHz to the 10th harmonic of highest fundamental frequency.
2. Measurements above show only up to 6 maximum emissions noted, or would be lesser, with " N/A " remark, if no specific emissions from the EUT are recorded (ie: margin > 20dB from the applicable limit) and considered that's already beyond the background noise floor.



Operation Mode: WCDMA Band V / TX / CH 4132

Test Date: December 10, 2014

Temperature: 26°C

Tested by: Dennis Li

Humidity: 60 % RH

Polarity: Ver. / Hor.

Frequency (MHz)	S.G. (dBm)	Cable loss (dB)	Ant.Gain (dBi)	Emission level (dBm)	Limit (dBm)	Margin (dB)	Antenna Polarization (V/H)
1651.000	-58.36	5.05	6.03	-57.38	-13.00	-44.38	V
3303.000	-53.23	7.46	8.31	-52.38	-13.00	-39.38	V
N/A							
1658.000	-52.44	5.06	6.02	-51.48	-13.00	-38.48	H
3310.000	-53.42	7.47	8.33	-52.56	-13.00	-39.56	H
N/A							

Remark:

1. Measuring frequencies from 1 GHz to the 10th harmonic of highest fundamental frequency.
2. Measurements above show only up to 6 maximum emissions noted, or would be lesser, with " N/A " remark, if no specific emissions from the EUT are recorded (ie: margin > 20dB from the applicable limit) and considered that's already beyond the background noise floor.



Operation Mode: WCDMA Band V / TX / CH 4182

Test Date: December 10, 2014

Temperature: 26°C

Tested by: Dennis Li

Humidity: 60 % RH

Polarity: Ver. / Hor.

Frequency (MHz)	S.G. (dBm)	Cable loss (dB)	Ant.Gain (dBi)	Emission level (dBm)	Limit (dBm)	Margin (dB)	Antenna Polarization (V/H)
1672.000	-56.38	5.07	5.99	-55.46	-13.00	-42.46	V
3338.000	-53.79	7.5	8.41	-52.88	-13.00	-39.88	V
N/A							
1672.000	-51.01	5.07	5.99	-50.09	-13.00	-37.09	H
3352.000	-53.08	7.52	8.46	-52.14	-13.00	-39.14	H
N/A							

Remark:

1. Measuring frequencies from 1 GHz to the 10th harmonic of highest fundamental frequency.
2. Measurements above show only up to 6 maximum emissions noted, or would be lesser, with " N/A " remark, if no specific emissions from the EUT are recorded (ie: margin > 20dB from the applicable limit) and considered that's already beyond the background noise floor.



Operation Mode: WCDMA Band V / TX / CH 4233

Test Date: December 10, 2014

Temperature: 26°C

Tested by: Dennis Li

Humidity: 60 % RH

Polarity: Ver. / Hor.

Frequency (MHz)	S.G. (dBm)	Cable loss (dB)	Ant.Gain (dBi)	Emission level (dBm)	Limit (dBm)	Margin (dB)	Antenna Polarization (V/H)
1693.000	-49.32	5.1	5.95	-48.47	-13.00	-35.47	V
3800.000	-53.82	8.26	9.2	-52.88	-13.00	-39.88	V
N/A							
1693.000	-47.67	5.1	5.95	-46.82	-13.00	-33.82	H
3380.000	-51.35	7.55	8.54	-50.36	-13.00	-37.36	H
N/A							

Remark:

1. Measuring frequencies from 1 GHz to the 10th harmonic of highest fundamental frequency.
2. Measurements above show only up to 6 maximum emissions noted, or would be lesser, with " N/A " remark, if no specific emissions from the EUT are recorded (ie: margin > 20dB from the applicable limit) and considered that's already beyond the background noise floor.



Operation Mode: WCDMA / HSDPA Band II / TX / CH 9262

Test Date: December 10, 2014

Temperature: 26°C

Tested by: Dennis Li

Humidity: 60 % RH

Polarity: Ver. / Hor.

Frequency (MHz)	S.G. (dBm)	Cable loss (dB)	Ant.Gain (dBi)	Emission level (dBm)	Limit (dBm)	Margin (dB)	Antenna Polarization (V/H)
3702.000	-44.24	8.2	9.1	-43.34	-13.00	-30.34	V
6922.000	-48.67	11.53	11.81	-48.39	-13.00	-35.39	V
N/A							
3709.000	-44.9	8.21	9.11	-44.00	-13.00	-31.00	H
6306.000	-51.11	10.78	11.14	-50.75	-13.00	-37.75	H
N/A							

Remark:

1. Measuring frequencies from 1 GHz to the 10th harmonic of highest fundamental frequency.
2. Measurements above show only up to 6 maximum emissions noted, or would be lesser, with " N/A " remark, if no specific emissions from the EUT are recorded (ie: margin > 20dB from the applicable limit) and considered that's already beyond the background noise floor.



Operation Mode: WCDMA / HSDPA Band II / TX / CH 9400 Test Date: December 10, 2014

Temperature: 26°C Tested by: Dennis Li

Humidity: 60 % RH Polarity: Ver. / Hor.

Frequency (MHz)	S.G. (dBm)	Cable loss (dB)	Ant.Gain (dBi)	Emission level (dBm)	Limit (dBm)	Margin (dB)	Antenna Polarization (V/H)
3765.000	-47.24	8.24	9.16	-46.32	-13.00	-33.32	V
5732.000	-53.68	10.24	10.85	-53.07	-13.00	-40.07	V
N/A							
3765.000	-46.13	8.24	9.16	-45.21	-13.00	-32.21	H
6369.000	-50.92	11.07	11.2	-50.79	-13.00	-37.79	H
N/A							

Remark:

1. Measuring frequencies from 1 GHz to the 10th harmonic of highest fundamental frequency.
2. Measurements above show only up to 6 maximum emissions noted, or would be lesser, with " N/A " remark, if no specific emissions from the EUT are recorded (ie: margin > 20dB from the applicable limit) and considered that's already beyond the background noise floor.



Operation Mode: WCDMA / HSDPA Band II / TX / CH 9538

Test Date: December 10, 2014

Temperature: 26°C

Tested by: Dennis Li

Humidity: 60 % RH

Polarity: Ver. / Hor.

Frequency (MHz)	S.G. (dBm)	Cable loss (dB)	Ant.Gain (dBi)	Emission level (dBm)	Limit (dBm)	Margin (dB)	Antenna Polarization (V/H)
3814.000	-44.63	8.28	9.21	-43.70	-13.00	-30.70	V
6201.000	-51.47	11.22	11.06	-51.63	-13.00	-38.63	V
N/A							
3814.000	-46.45	8.28	9.21	-45.52	-13.00	-32.52	H
6537.000	-49.04	11.11	11.34	-48.81	-13.00	-35.81	H
N/A							

Remark:

1. Measuring frequencies from 1 GHz to the 10th harmonic of highest fundamental frequency.
2. Measurements above show only up to 6 maximum emissions noted, or would be lesser, with " N/A " remark, if no specific emissions from the EUT are recorded (ie: margin > 20dB from the applicable limit) and considered that's already beyond the background noise floor.



Operation Mode: WCDMA / HSDPA Band V / TX / CH 4132 Test Date: December 10, 2014

Temperature: 26°C Tested by: Dennis Li

Humidity: 60 % RH Polarity: Ver. / Hor.

Frequency (MHz)	S.G. (dBm)	Cable loss (dB)	Ant.Gain (dBi)	Emission level (dBm)	Limit (dBm)	Margin (dB)	Antenna Polarization (V/H)
1651.000	-55.98	5.05	6.03	-55.00	-13.00	-42.00	V
3303.000	-50.33	7.46	8.31	-49.48	-13.00	-36.48	V
N/A							
1651.000	-49.92	5.05	6.03	-48.94	-13.00	-35.94	H
3310.000	-50.48	7.47	8.33	-49.62	-13.00	-36.62	H
N/A							

Remark:

1. Measuring frequencies from 1 GHz to the 10th harmonic of highest fundamental frequency.
2. Measurements above show only up to 6 maximum emissions noted, or would be lesser, with " N/A " remark, if no specific emissions from the EUT are recorded (ie: margin > 20dB from the applicable limit) and considered that's already beyond the background noise floor.



Operation Mode: WCDMA / HSDPA Band V / TX / CH 4182

Test Date: December 10, 2014

Temperature: 26°C

Tested by: Dennis Li

Humidity: 60 % RH

Polarity: Ver. / Hor.

Frequency (MHz)	S.G. (dBm)	Cable loss (dB)	Ant.Gain (dBi)	Emission level (dBm)	Limit (dBm)	Margin (dB)	Antenna Polarization (V/H)
3352.000	-51.39	7.52	8.46	-50.45	-13.00	-37.45	V
6586.000	-49.9	11.2	11.4	-49.70	-13.00	-36.70	V
N/A							
1672.000	-53.8	5.07	5.99	-52.88	-13.00	-39.88	H
3352.000	-52.64	7.52	8.46	-51.70	-13.00	-38.70	H
N/A							

Remark:

1. Measuring frequencies from 1 GHz to the 10th harmonic of highest fundamental frequency.
2. Measurements above show only up to 6 maximum emissions noted, or would be lesser, with " N/A " remark, if no specific emissions from the EUT are recorded (ie: margin > 20dB from the applicable limit) and considered that's already beyond the background noise floor.



Operation Mode: WCDMA / HSDPA Band V / TX / CH 4233

Test Date: December 10, 2014

Temperature: 26°C

Tested by: Dennis Li

Humidity: 60 % RH

Polarity: Ver. / Hor.

Frequency (MHz)	S.G. (dBm)	Cable loss (dB)	Ant.Gain (dBi)	Emission level (dBm)	Limit (dBm)	Margin (dB)	Antenna Polarization (V/H)
1693.000	-57.35	5.1	5.95	-56.50	-13.00	-43.50	V
3380.000	-53.7	7.55	8.54	-52.71	-13.00	-39.71	V
N/A							
1693.000	-50.91	5.1	5.95	-50.06	-13.00	-37.06	H
3380.000	-52.39	7.55	8.54	-51.40	-13.00	-38.40	H
N/A							

Remark:

1. Measuring frequencies from 1 GHz to the 10th harmonic of highest fundamental frequency.
2. Measurements above show only up to 6 maximum emissions noted, or would be lesser, with " N/A " remark, if no specific emissions from the EUT are recorded (ie: margin > 20dB from the applicable limit) and considered that's already beyond the background noise floor.



Operation Mode: WCDMA / HSUPA Band II / TX / CH 9262

Test Date: December 10, 2014

Temperature: 26°C

Tested by: Dennis Li

Humidity: 60 % RH

Polarity: Ver. / Hor.

Frequency (MHz)	S.G. (dBm)	Cable loss (dB)	Ant.Gain (dBi)	Emission level (dBm)	Limit (dBm)	Margin (dB)	Antenna Polarization (V/H)
3709.000	-45.21	8.21	9.11	-44.31	-13.00	-31.31	V
5984.000	-51.94	10.76	10.9	-51.80	-13.00	-38.80	V
N/A							
3709.000	-44.66	8.21	9.11	-43.76	-13.00	-30.76	H
6145.000	-51.37	10.89	11.02	-51.24	-13.00	-38.24	H
N/A							

Remark:

1. Measuring frequencies from 1 GHz to the 10th harmonic of highest fundamental frequency.
2. Measurements above show only up to 6 maximum emissions noted, or would be lesser, with " N/A " remark, if no specific emissions from the EUT are recorded (ie: margin > 20dB from the applicable limit) and considered that's already beyond the background noise floor.



Operation Mode: WCDMA / HSUPA Band II / TX / CH 9400

Test Date: December 10, 2014

Temperature: 26°C

Tested by: Dennis Li

Humidity: 60 % RH

Polarity: Ver. / Hor.

Frequency (MHz)	S.G. (dBm)	Cable loss (dB)	Ant.Gain (dBi)	Emission level (dBm)	Limit (dBm)	Margin (dB)	Antenna Polarization (V/H)
3758.000	-47.57	8.23	9.16	-46.64	-13.00	-33.64	V
5844.000	-53.32	10.41	10.87	-52.86	-13.00	-39.86	V
N/A							
3758.000	-45.14	8.23	9.16	-44.21	-13.00	-31.21	H
5158.000	-53.71	9.51	10.66	-52.56	-13.00	-39.56	H
N/A							

Remark:

1. Measuring frequencies from 1 GHz to the 10th harmonic of highest fundamental frequency.
2. Measurements above show only up to 6 maximum emissions noted, or would be lesser, with " N/A " remark, if no specific emissions from the EUT are recorded (ie: margin > 20dB from the applicable limit) and considered that's already beyond the background noise floor.



Operation Mode: WCDMA / HSUPA Band II / TX / CH 9538

Test Date: December 10, 2014

Temperature: 26°C

Tested by: Dennis Li

Humidity: 60 % RH

Polarity: Ver. / Hor.

Frequency (MHz)	S.G. (dBm)	Cable loss (dB)	Ant.Gain (dBi)	Emission level (dBm)	Limit (dBm)	Margin (dB)	Antenna Polarization (V/H)
3814.000	-45.57	8.28	9.21	-44.64	-13.00	-31.64	V
5571.000	-53.48	10.12	10.81	-52.79	-13.00	-39.79	V
N/A							
3814.000	-45.74	8.28	9.21	-44.81	-13.00	-31.81	H
6824.000	-48.41	11.36	11.69	-48.08	-13.00	-35.08	H
N/A							

Remark:

1. Measuring frequencies from 1 GHz to the 10th harmonic of highest fundamental frequency.
2. Measurements above show only up to 6 maximum emissions noted, or would be lesser, with " N/A " remark, if no specific emissions from the EUT are recorded (ie: margin > 20dB from the applicable limit) and considered that's already beyond the background noise floor.



Operation Mode: WCDMA / HSUPA Band V / TX / CH 4132

Test Date: December 10, 2014

Temperature: 26°C

Tested by: Dennis Li

Humidity: 60 % RH

Polarity: Ver. / Hor.

Frequency (MHz)	S.G. (dBm)	Cable loss (dB)	Ant.Gain (dBi)	Emission level (dBm)	Limit (dBm)	Margin (dB)	Antenna Polarization (V/H)
1651.000	-57.67	5.05	6.03	-56.69	-13.00	-43.69	V
3310.000	-51.93	7.47	8.33	-51.07	-13.00	-38.07	V
N/A							
1651.000	-51.3	5.05	6.03	-50.32	-13.00	-37.32	H
3310.000	-51.59	7.47	8.33	-50.73	-13.00	-37.73	H
N/A							

Remark:

1. Measuring frequencies from 1 GHz to the 10th harmonic of highest fundamental frequency.
2. Measurements above show only up to 6 maximum emissions noted, or would be lesser, with " N/A " remark, if no specific emissions from the EUT are recorded (ie: margin > 20dB from the applicable limit) and considered that's already beyond the background noise floor.



Operation Mode: WCDMA / HSUPA Band V / TX / CH 4182

Test Date: December 10, 2014

Temperature: 26°C

Tested by: Dennis Li

Humidity: 60 % RH

Polarity: Ver. / Hor.

Frequency (MHz)	S.G. (dBm)	Cable loss (dB)	Ant.Gain (dBi)	Emission level (dBm)	Limit (dBm)	Margin (dB)	Antenna Polarization (V/H)
3352.000	-54.18	7.52	8.46	-53.24	-13.00	-40.24	V
5109.000	-54.34	9.46	10.64	-53.16	-13.00	-40.16	V
N/A							
1672.000	-52.74	5.07	5.99	-51.82	-13.00	-38.82	H
3352.000	-54.57	7.52	8.46	-53.63	-13.00	-40.63	H
N/A							

Remark:

1. Measuring frequencies from 1 GHz to the 10th harmonic of highest fundamental frequency.
2. Measurements above show only up to 6 maximum emissions noted, or would be lesser, with " N/A " remark, if no specific emissions from the EUT are recorded (ie: margin > 20dB from the applicable limit) and considered that's already beyond the background noise floor.



Operation Mode: WCDMA / HSUPA Band V / TX / CH 4233

Test Date: December 10, 2014

Temperature: 26°C

Tested by: Dennis Li

Humidity: 60 % RH

Polarity: Ver. / Hor.

Frequency (MHz)	S.G. (dBm)	Cable loss (dB)	Ant.Gain (dBi)	Emission level (dBm)	Limit (dBm)	Margin (dB)	Antenna Polarization (V/H)
1945.000	-51.86	5.57	5.5	-51.93	-13.00	-38.93	V
3352.000	-54.14	7.52	8.46	-53.20	-13.00	-40.20	V
N/A							
1672.000	-53.74	5.07	5.99	-52.82	-13.00	-39.82	H
3352.000	-53.18	7.52	8.46	-52.24	-13.00	-39.24	H
N/A							

Remark:

1. Measuring frequencies from 1 GHz to the 10th harmonic of highest fundamental frequency.
2. Measurements above show only up to 6 maximum emissions noted, or would be lesser, with " N/A " remark, if no specific emissions from the EUT are recorded (ie: margin > 20dB from the applicable limit) and considered that's already beyond the background noise floor.



7.7 FREQUENCY STABILITY V.S. TEMPERATURE MEASUREMENT

LIMIT

According to FCC §2.1055, FCC §24.235, RSS-132 (4.3) & RSS-133 (6.3).

Frequency Tolerance: 2.5 ppm

Test Configuration

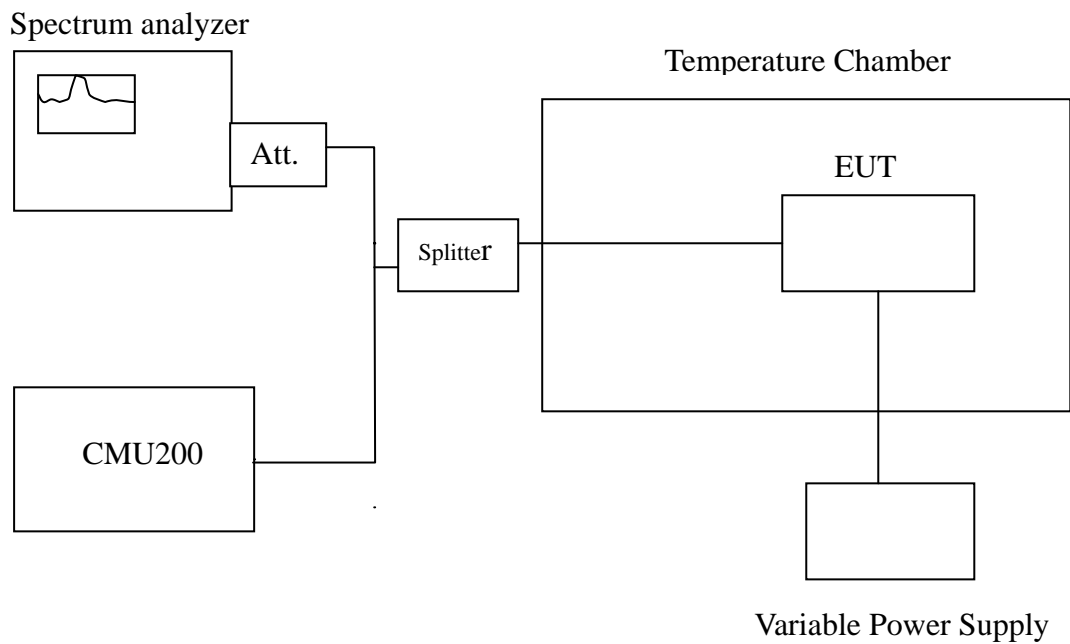

Remark: Measurement setup for testing on Antenna connector.



TEST PROCEDURE

The equipment under test was connected to an external AC or DC power supply and input rated voltage. RF output was connected to a frequency counter or spectrum analyzer via feed through attenuators. The EUT was placed inside the temperature chamber. Set the spectrum analyzer RBW low enough to obtain the desired frequency resolution and measure EUT 20°C operating frequency as reference frequency. Turn EUT off and set the chamber temperature to -30°C. After the temperature stabilized for approximately 30 minutes recorded the frequency. Repeat step measure with 10°C increased per stage until the highest temperature of +50°C reached.

TEST RESULTS

No non-compliance noted.

Reference Frequency: GSM Mid Channel 836.6 MHz @ 20°C				
Limit: +/- 2.5 ppm = 2091 Hz				
Power Supply Vdc	Environment Temperature (°C)	Frequency (Hz)	Delta (Hz)	Limit (Hz)
3.6	50	836599999	2	2091
	40	836599975	-22	
	30	836599993	-4	
	20	836599997	0	
	10	836599986	-11	
	0	836599975	-22	
	-10	836599981	-16	
	-20	836599995	-2	
	55	836599976	-21	

Reference Frequency: GSM Mid Channel 1880 MHz @ 20°C				
Limit: ± 2.5 ppm = 4700Hz				
Power Supply Vdc	Environment Temperature (°C)	Frequency (Hz)	Delta (Hz)	Limit (Hz)
3.6	50	1879999998	7	4700
	40	1879999986	-5	
	30	1879999987	-4	
	20	1879999991	0	
	10	1880000000	9	
	0	1880000014	23	
	-10	1880000017	26	
	-20	1879999995	4	
	55	1879999982	-9	



Reference Frequency: GPRS Mid Channel 836.6 MHz @ 20°C				
Limit: +/- 2.5 ppm = 2091 Hz				
Power Supply Vdc	Environment Temperature (°C)	Frequency (Hz)	Delta (Hz)	Limit (Hz)
3.6	50	836600021	27	2091
	40	836600006	12	
	30	836599999	5	
	20	836599994	0	
	10	836600018	24	
	0	836599999	5	
	-10	836600012	18	
	-20	836599999	5	
	55	836599987	-7	

Reference Frequency: GPRS Mid Channel 1880 MHz @ 20°C				
Limit: ± 2.5 ppm = 4700Hz				
Power Supply Vdc	Environment Temperature (°C)	Frequency (Hz)	Delta (Hz)	Limit (Hz)
3.6	50	1880000018	8	4700
	40	1879999995	-15	
	30	1880000001	-9	
	20	1880000010	0	
	10	1880000009	-1	
	0	1879999992	-18	
	-10	1880000003	-7	
	-20	1879999982	-28	
	55	1880000010	0	



Reference Frequency: EDGE Mid Channel 836.6 MHz @ 20°C				
Limit: +/- 2.5 ppm = 2091 Hz				
Power Supply Vdc	Environment Temperature (°C)	Frequency (Hz)	Delta (Hz)	Limit (Hz)
3.6	50	836600003	8	2091
	40	836600002	7	
	30	836599987	-8	
	20	836599995	0	
	10	836600011	16	
	0	836599992	-3	
	-10	836600016	21	
	-20	836599996	1	
	55	836600022	27	

Reference Frequency: EDGE Mid Channel 1880 MHz @ 20°C				
Limit: ± 2.5 ppm = 4700Hz				
Power Supply Vdc	Environment Temperature (°C)	Frequency (Hz)	Delta (Hz)	Limit (Hz)
3.6	50	1879999978	-25	4700
	40	1879999986	-17	
	30	1880000014	11	
	20	1880000003	0	
	10	1880000001	-2	
	0	1879999979	-24	
	-10	1879999981	-22	
	-20	1880000006	3	
	55	1880000018	15	



Reference Frequency: WCDMA Band V Mid Channel 836.6 MHz @ 20°C				
Limit: +/- 2.5 ppm = 2091 Hz				
Power Supply Vdc	Environment Temperature (°C)	Frequency (Hz)	Delta (Hz)	Limit (Hz)
3.6	50	836399991	-18	2091
	40	836399999	-10	
	30	836400012	3	
	20	836400009	0	
	10	836399987	-22	
	0	836400004	-5	
	-10	836399988	-21	
	-20	836400015	6	
	55	836400015	6	

Reference Frequency: WCDMA Band II Mid Channel 1880 MHz @ 20°C				
Limit: ± 2.5 ppm = 4700Hz				
Power Supply Vdc	Environment Temperature (°C)	Frequency (Hz)	Delta (Hz)	Limit (Hz)
3.6	50	1880000020	15	4700
	40	1880000012	7	
	30	1879999984	-21	
	20	1880000005	0	
	10	1880000001	-4	
	0	1879999979	-26	
	-10	1880000024	19	
	-20	1879999987	-18	
	55	1879999993	-12	



Reference Frequency: WCDMA / HSDPA Band V Mid Channel 836.6 MHz @ 20°C				
Limit: +/- 2.5 ppm = 2091 Hz				
Power Supply Vdc	Environment Temperature (°C)	Frequency (Hz)	Delta (Hz)	Limit (Hz)
3.6	50	836399984	-24	2091
	40	836399997	-11	
	30	836400003	-5	
	20	836400008	0	
	10	836400006	-2	
	0	836400004	-4	
	-10	836399996	-12	
	-20	836399976	-32	
	55	836400000	-8	

Reference Frequency: WCDMA / HSDPA Band II Mid Channel 1880 MHz @ 20°C				
Limit: ± 2.5 ppm = 4700Hz				
Power Supply Vdc	Environment Temperature (°C)	Frequency (Hz)	Delta (Hz)	Limit (Hz)
3.6	50	1880000021	21	4700
	40	1880000004	4	
	30	1879999996	-4	
	20	1880000000	0	
	10	1879999994	-6	
	0	1880000008	8	
	-10	1880000014	14	
	-20	1880000022	22	
	55	1879999998	-2	



Reference Frequency: WCDMA / HSUPA Band V Mid Channel 836.6 MHz @ 20°C				
Limit: +/- 2.5 ppm = 2091 Hz				
Power Supply Vdc	Environment Temperature (°C)	Frequency (Hz)	Delta (Hz)	Limit (Hz)
3.6	50	836399990	-15	2091
	40	836399999	-6	
	30	836400008	3	
	20	836400005	0	
	10	836400020	15	
	0	836399997	-8	
	-10	836400011	6	
	-20	836399997	-8	
	55	836400008	3	

Reference Frequency: WCDMA / HSUPA Band II Mid Channel 1880 MHz @ 20°C				
Limit: ± 2.5 ppm = 4700 Hz				
Power Supply Vdc	Environment Temperature (°C)	Frequency (Hz)	Delta (Hz)	Limit (Hz)
3.6	50	1880000010	15	4700
	40	1880000016	21	
	30	1879999998	3	
	20	1879999995	0	
	10	1879999983	-12	
	0	1879999993	-2	
	-10	1879999983	-12	
	-20	1880000012	17	
	55	1880000012	17	



7.8 FREQUENCY STABILITY V.S. VOLTAGE MEASUREMENT

LIMIT

According to FCC §2.1055, FCC §24.235,

Frequency Tolerance: 2.5 ppm.

According to RSS-132 (4.3) & RSS-133 (6.3).

The carrier frequency shall not depart from the reference frequency in excess of ± 2.5 ppm for mobile stations and ± 1.0 ppm for base stations.

Test Configuration

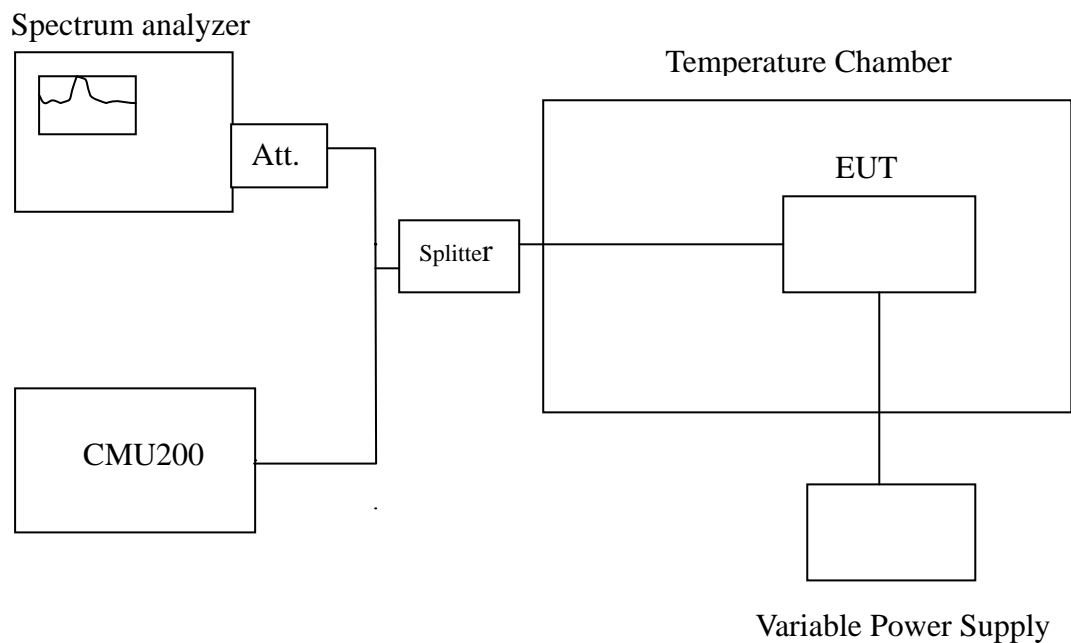

Remark: Measurement setup for testing on Antenna connector.



TEST PROCEDURE

Set chamber temperature to 20°C. Use a variable AC power supply / DC power source to power the EUT and set the voltage to rated voltage. Set the spectrum analyzer RBW low enough to obtain the desired frequency resolution and recorded the frequency.

Reduce the input voltage to specify extreme voltage variation (± 15%) and endpoint, record the maximum frequency change.

TEST RESULTS

No non-compliance noted.

Reference Frequency: GSM Mid Channel 836.6 MHz @ 20°C				
Limit: ± 2.5 ppm = 2091Hz				
Power Supply Vdc	Environment Temperature (°C)	Frequency (Hz)	Delta (Hz)	Limit (Hz)
3.96	20	836600011	1	2091
3.6		836600010	0	
3.24		836600010	0	

Reference Frequency: GSM Mid Channel 1880 MHz @ 20°C				
Limit: ± 2.5 ppm = 4700Hz				
Power Supply Vdc	Environment Temperature (°C)	Frequency (Hz)	Delta (Hz)	Limit (Hz)
3.96	20	1879999997	2	4700
3.6		1879999995	0	
3.24		1880000002	7	



Reference Frequency: GPRS Mid Channel 836.6 MHz @ 20°C				
Limit: ± 2.5 ppm = 2091Hz				
Power Supply Vdc	Environment Temperature (°C)	Frequency (Hz)	Delta (Hz)	Limit (Hz)
3.96	20	836599994	-13	2091
3.6		836600007	0	
3.24		836600003	-4	

Reference Frequency: GPRS Mid Channel 1880 MHz @ 20°C				
Limit: ± 2.5 ppm = 4700Hz				
Power Supply Vdc	Environment Temperature (°C)	Frequency (Hz)	Delta (Hz)	Limit (Hz)
3.96	20	1879999989	-2	4700
3.6		1879999991	0	
3.24		1880000016	25	



Reference Frequency: EDGE Mid Channel 836.6 MHz @ 20°C				
Limit: ± 2.5 ppm = 2091Hz				
Power Supply Vdc	Environment Temperature (°C)	Frequency (Hz)	Delta (Hz)	Limit (Hz)
3.96	20	836600016	20	2091
3.6		836599996	0	
3.24		836599988	-8	

Reference Frequency: EDGE Mid Channel 1880 MHz @ 20°C				
Limit: ± 2.5 ppm = 4700Hz				
Power Supply Vdc	Environment Temperature (°C)	Frequency (Hz)	Delta (Hz)	Limit (Hz)
3.96	20	1880000002	-4	4700
3.6		1880000006	0	
3.24		1880000013	7	



Reference Frequency: WCDMA Band V Mid Channel 836.6 MHz @ 20°C				
Limit: ± 2.5 ppm = 2091Hz				
Power Supply Vdc	Environment Temperature (°C)	Frequency (Hz)	Delta (Hz)	Limit (Hz)
3.96	20	836400001	-3	2091
3.6		836400004	0	
3.24		836400013	9	

Reference Frequency: WCDMA Band II Mid Channel 1880 MHz @ 20°C				
Limit: ± 2.5 ppm = 4700Hz				
Power Supply Vdc	Environment Temperature (°C)	Frequency (Hz)	Delta (Hz)	Limit (Hz)
3.96	20	1879999984	-20	4700
3.6		1880000004	0	
3.24		1880000013	9	



Reference Frequency: WCDMA / HSDPA Band V Mid Channel 836.6 MHz @ 20°C				
Limit: ± 2.5 ppm = 2091Hz				
Power Supply Vdc	Environment Temperature (°C)	Frequency (Hz)	Delta (Hz)	Limit (Hz)
3.96	20	836399990	-5	2091
3.6		836399995	0	
3.24		836399997	2	

Reference Frequency: WCDMA / HSDPA Band II Mid Channel 1880 MHz @ 20°C				
Limit: ± 2.5 ppm = 4700Hz				
Power Supply Vdc	Environment Temperature (°C)	Frequency (Hz)	Delta (Hz)	Limit (Hz)
3.96	20	1880000000	7	4700
3.6		1879999993	0	
3.24		1879999998	5	



Reference Frequency: WCDMA HSUPA Band V Mid Channel 836.6 MHz @ 20°C				
Limit: ± 2.5 ppm = 2091Hz				
Power Supply Vdc	Environment Temperature (°C)	Frequency (Hz)	Delta (Hz)	Limit (Hz)
3.96	20	836399995	-11	2091
3.6		836400006	0	
3.24		836400008	2	

Reference Frequency: WCDMA HSUPA Band II Mid Channel 1880 MHz @ 20°C				
Limit: ± 2.5 ppm = 4700 Hz				
Power Supply Vdc	Environment Temperature (°C)	Frequency (Hz)	Delta (Hz)	Limit (Hz)
3.96	20	1880000004	-1	4700
3.6		1880000005	0	
3.24		1879999984	-21	