



**SGS-CSTC Standards Technical Services Co., Ltd.  
Shenzhen Branch**

No. 1 Workshop, M-10, Middle section, Science & Technology Park, Nanshan District, Shenzhen, Guangdong, China 518057

Telephone: +86 (0) 755 2601 2053  
Fax: +86 (0) 755 2671 0594  
Email: ee.shenzhen@sgs.com

Report No.: SZEM1609008050RG  
Page: 1 of 26

## FCC&IC REPORT

**Application No:** SZEM1609008050RG  
**Applicant:** Sierra Wireless Inc.  
**Product Name:** Wireless Module  
**Mode No.(EUT):** HL8548  
**Standards:** 47 CFR Part 2 (2015)  
47 CFR Part 22 subpart H (2015)  
47 CFR Part 24 subpart E (2015)  
RSS-132 Issue 3 January 2013  
RSS-133 Issue 6 January 2013  
RSS-Gen Issue 4 Nov 2014  
**Test Method:** FCC KDB 971168 D01 Power Meas License Digital Systems v02r02  
RSS-132  
RSS-133  
RSS-Gen Issue 4  
**Date of Receipt:** 2016-09-24  
**Date of Test:** 2016-09-26 to 2016-09-30  
**Date of Issue:** 2016-11-03

<b>Test Result :</b>	<b>PASS *</b>
----------------------	---------------

\* In the configuration tested, the EUT detailed in this report complied with the standards specified above.

Authorized Signature:

Derek Yang  
Wireless Laboratory Manager

The manufacturer should ensure that all products in series production are in conformity with the product sample detailed in this report. If the product in this report is used in any configuration other than that detailed in the report, the manufacturer must ensure the new system complies with all relevant standards. Any mention of SGS International Electrical Approvals or testing done by SGS International Electrical Approvals in connection with, distribution or use of the product described in this report must be approved by SGS International Electrical Approvals in writing.

The report must not be used by the client to claim product certification, approval, or endorsement by NVLAP, NIST, or any agency of the federal government. All test results in this report can be traceable to National or International Standards.

"This document is issued by the Company subject to its General Conditions of Service printed overleaf, available on request or accessible at [www.sgs.com/terms\\_and\\_conditions.htm](http://www.sgs.com/terms_and_conditions.htm) and, for electronic format documents, subject to Terms and Conditions for Electronic Documents at [www.sgs.com/terms\\_e-document.htm](http://www.sgs.com/terms_e-document.htm). Attention is drawn to the limitation of liability, indemnification and jurisdiction issues defined therein. Any holder of this document is advised that information contained hereon reflects the Company's findings at the time of its intervention only and within the limits of Client's instructions, if any. The Company's sole responsibility is to its Client and this document does not exonerate parties to a transaction from exercising all their rights and obligations under the transaction documents. This document cannot be reproduced except in full, without prior written approval of the Company. Any unauthorized alteration, forgery or falsification of the content or appearance of this document is unlawful and offenders may be prosecuted to the fullest extent of the law. Unless otherwise stated the results shown in this test report refer only to the sample(s) tested and such sample(s) are retained for 90 days only."



## Version

Revision Record				
Version	Chapter	Date	Modifier	Remark
00		2016-09-30		Original
01		2016-11-03		Add test data for conducted power and bandwidth.

Authorized for issue by:			
Tested By		<hr/>	2016-09-26
			Date
Prepared By		<hr/>	2016-09-30
			Date
Checked By		<hr/>	2016-11-03
			Date



## 2 Test Summary

Test Item	FCC Rule No.	Requirements	Test Result
Effective (Isotropic) Radiated Power Output Data	§2.1046, §22.913, §24.232	FCC: ERP $\leq$ 7 W. EIRP $\leq$ 2 W.	PASS
Peak-Average Ratio	§24.232	$\leq$ 13dB	PASS
Modulation Characteristics	§2.1047	Digital modulation	PASS
Bandwidth	§2.1049(h), §22.917, §24.238	OBW: No limit EBW: No limit	PASS
Band Edge Compliance	§2.1051, §22.917, §24.238	$\leq$ -13dBm/1%*EBW, in 1 MHz bands immediately outside and adjacent to the frequency block.	PASS
Spurious emissions at antenna terminals	§2.1051, §22.917, §24.238	FCC: $\leq$ -13dBm/100 kHz, from 9 kHz to 10th harmonics but outside authorized operating frequency ranges.	PASS
Field strength of spurious radiation	§2.1051, §22.917, §24.238	FCC: $\leq$ -13dBm/100 kHz,	PASS
Frequency stability	§2.1055, §22.355, §24.235	$\leq$ $\pm$ 2.5ppm.	PASS



**SGS-CSTC Standards Technical Services Co., Ltd.**  
**Shenzhen Branch**

Report No.: SZEM16098050RG

Page: 4 of 26

Test Item	IC Rule No.	Requirements	Result
<b>GSM 850, WCDMA 850(Band V)</b>			
Conducted output power	RSS-132 clause 5.4 SRSP503 clause 5.1.3	RSS-Gen Issue 4	PASS
Effective Radiated Power of Transmitter(ERP)	RSS-132 clause 5.4 SRSP503 clause 5.1.3	RSS-Gen Issue 4	PASS
99% Occupied Bandwidth	N/A	RSS-Gen Issue 4	PASS
Band Edge at antenna terminals	RSS-132 clause 5.5	RSS-132 clause 4.5	PASS
Spurious emissions at antenna terminals	RSS-132 clause 5.5	RSS-Gen Issue 4	PASS
Field strength of spurious radiation	RSS-132 clause 5.5	RSS-Gen Issue 4	PASS
Frequency stability	RSS-132 clause 5.3	RSS-Gen Issue 4	PASS
<b>GSM 1900,WCDMA 1900 (Band II)</b>			
Conducted output power	RSS-133 clause 6.4 SRSP510 clause 5.1.2	RSS-Gen Issue 4	PASS
Effective Radiated Power of Transmitter(EIRP)	RSS-133 clause 6.4 SRSP510 clause 5.1.2	RSS-Gen Issue 4	PASS
99% Occupied Bandwidth	N/A	RSS-Gen Issue 4	PASS
Band Edge at antenna terminals	RSS-133 clause 6.5	RSS-133 clause 6.5	PASS
Spurious emissions at antenna terminals	RSS-133 clause 6.5	RSS-Gen Issue 4	PASS
Field strength of spurious radiation	RSS-133 clause 6.5	RSS-Gen Issue 4	PASS
Frequency stability	RSS-133 clause 6.3	RSS-Gen Issue 4	PASS

"This document is issued by the Company subject to its General Conditions of Service printed overleaf, available on request or accessible at [www.sgs.com/terms\\_and\\_conditions.htm](http://www.sgs.com/terms_and_conditions.htm) and, for electronic format documents, subject to Terms and Conditions for Electronic Documents at [www.sgs.com/terms\\_e-document.htm](http://www.sgs.com/terms_e-document.htm). Attention is drawn to the limitation of liability, indemnification and jurisdiction issues defined therein. Any holder of this document is advised that information contained hereon reflects the Company's findings at the time of its intervention only and within the limits of Client's instructions, if any. The Company's sole responsibility is to its Client and this document does not exonerate parties to a transaction from exercising all their rights and obligations under the transaction documents. This document cannot be reproduced except in full, without prior written approval of the Company. Any unauthorized alteration, forgery or falsification of the content or appearance of this document is unlawful and offenders may be prosecuted to the fullest extent of the law. Unless otherwise stated the results shown in this test report refer only to the sample(s) tested and such sample(s) are retained for 90 days only."



### 3 Content

	Page
<b>1 COVER PAGE</b> .....	<b>1</b>
<b>2 TEST SUMMARY</b> .....	<b>3</b>
<b>3 CONTENT</b> .....	<b>5</b>
<b>4 GENERAL INFORMATION</b> .....	<b>6</b>
4.1 CLIENT INFORMATION .....	6
4.2 GENERAL DESCRIPTION OF EUT .....	6
4.3 TEST MODE .....	6
4.4 TEST ENVIRONMENT .....	6
4.5 TEST FREQUENCY .....	7
4.6 TEST LOCATION .....	7
4.7 TEST FACILITY .....	8
4.8 DEVIATION FROM STANDARDS .....	8
4.9 ABNORMALITIES FROM STANDARD CONDITIONS .....	8
4.10 OTHER INFORMATION REQUESTED BY THE CUSTOMER .....	8
4.11 TECHNICAL SPECIFICATION .....	9
<b>5 DESCRIPTION OF TESTS</b> .....	<b>10</b>
5.1 CONDUCTED OUTPUT POWER .....	10
5.2 EFFECTIVE (ISOTROPIC) RADIATED POWER OF TRANSMITTER .....	10
5.3 OCCUPIED BANDWIDTH .....	11
5.4 BAND EDGE AT ANTENNA TERMINALS .....	12
5.5 SPURIOUS AND HARMONIC EMISSIONS AT ANTENNA TERMINAL .....	12
5.6 PEAK-AVERAGE RATIO .....	13
5.7 FIELD STRENGTH OF SPURIOUS RADIATION .....	13
5.8 FREQUENCY STABILITY / TEMPERATURE VARIATION .....	14
5.9 TEST SETUPS .....	16
5.9.1 Test Setup 1 .....	16
5.9.2 Test Setup 2 .....	17
5.9.3 Test Setup 3 .....	18
5.9.4 Test Setup 4 .....	19
5.10 TEST CONDITIONS .....	20
<b>6 MAIN TEST INSTRUMENTS</b> .....	<b>22</b>
<b>7 MEASUREMENT UNCERTAINTY</b> .....	<b>25</b>
<b>8 PHOTOGRAPHS - EUT TEST SETUP</b> .....	<b>26</b>
<b>9 PHOTOGRAPHS - EUT CONSTRUCTIONAL DETAILS</b> .....	<b>26</b>



## 4 General Information

### 4.1 Client Information

Applicant:	Sierra Wireless Inc.
Address of Applicant:	13811 Wireless Way Richmond, British Columbia, Canada, V6V 3A4.

### 4.2 General Description of EUT

Product Name:	Wireless Module
Model No.:	HL8548
Sample Type:	Mobile production
Antenna Type:	External antenna
Antenna Gain:	GSM 850:1.4dBi, GSM 1900: 1.35dBi, WCDMA B2: 1.35dBi,, WCDMA B5:1.4dBi
Battery:	DC main: 3.7V

### 4.3 Test Mode

Test Mode	Test Modes Description
GSM/TM1	GSM system, GSM/GPRS/EGPRS, GMSK modulation
GSM/TM2	GSM system, EGPRS, 8PSK modulation
UMTS/TM1	UMTS system, WCDMA, QPSK modulation

NOTE: The test mode(s) are selected according to relevant radio technology specifications.

### 4.4 Test Environment

Environment Parameter	Selected Values During Tests	
Relative Humidity	52%	
Atmospheric Pressure:	1025Pa	
Temperature	TN	25 °C
Voltage :	VL	3.2V
	VN	3.7V
	VH	4.5V

NOTE: VL= lower extreme test voltage

VN= nominal voltage

VH= upper extreme test voltage

TN= normal temperature



#### 4.5 Test Frequency

Test Mode	TX / RX	RF Channel		
		Low (L)	Middle (M)	High (H)
GSM850	TX	Channel 128	Channel 190	Channel 251
		824.2MHz	836.6MHz	848.8MHz
	RX	Channel 128	Channel 190	Channel 251
		869.2MHz	881.6MHz	893.8MHz
Test Mode	TX / RX	RF Channel		
		Low (L)	Middle (M)	High (H)
GSM1900	TX	Channel 512	Channel 661	Channel 810
		1850.2MHz	1880.0MHz	1909.8MHz
	RX	Channel 512	Channel 661	Channel 810
		1930.2 MHz	1960.0 MHz	1989.8 MHz
Test Mode	TX / RX	RF Channel		
		Low (L)	Middle (M)	High (H)
WCDMA BAND 5	TX	Channel 4132	Channel 4183	Channel 4233
		826.4MHz	836.6MHz	846.6MHz
	RX	Channel 4357	Channel 4407	Channel 4458
		871.4 MHz	881.6 MHz	891.6 MHz
Test Mode	TX / RX	RF Channel		
		Low (L)	Middle (M)	High (H)
WCDMA BAND 2	TX	Channel 9262	Channel 9400	Channel 9538
		1852.4MHz	1880MHz	1907.6MHz
	RX	Channel 9662	Channel 9800	Channel 9938
		1932.4 MHz	1960 MHz	1987.6 MHz

#### 4.6 Test Location

All tests were performed at:

SGS-CSTC Standards Technical Services Co., Ltd., Shenzhen Branch E&E Lab,

No. 1 Workshop, M-10, Middle Section, Science & Technology Park, Shenzhen, Guangdong, China.  
 518057.

Tel: +86 755 2601 2053 Fax: +86 755 2671 0594

No tests were sub-contracted.

"This document is issued by the Company subject to its General Conditions of Service printed overleaf, available on request or accessible at [www.sgs.com/terms\\_and\\_conditions.htm](http://www.sgs.com/terms_and_conditions.htm) and, for electronic format documents, subject to Terms and Conditions for Electronic Documents at [www.sgs.com/terms\\_e-document.htm](http://www.sgs.com/terms_e-document.htm). Attention is drawn to the limitation of liability, indemnification and jurisdiction issues defined therein. Any holder of this document is advised that information contained hereon reflects the Company's findings at the time of its intervention only and within the limits of Client's instructions, if any. The Company's sole responsibility is to its Client and this document does not exonerate parties to a transaction from exercising all their rights and obligations under the transaction documents. This document cannot be reproduced except in full, without prior written approval of the Company. Any unauthorized alteration, forgery or falsification of the content or appearance of this document is unlawful and offenders may be prosecuted to the fullest extent of the law. Unless otherwise stated the results shown in this test report refer only to the sample(s) tested and such sample(s) are retained for 90 days only."



## 4.7 Test Facility

The test facility is recognized, certified, or accredited by the following organizations:

- **CNAS (No. CNAS L2929)**

CNAS has accredited SGS-CSTC Standards Technical Services Co., Ltd. Shenzhen Branch EMC Lab to ISO/IEC 17025:2005 General Requirements for the Competence of Testing and Calibration Laboratories (CNAS-CL01 Accreditation Criteria for the Competence of Testing and Calibration Laboratories) for the competence in the field of testing.

- **A2LA (Certificate No. 3816.01)**

SGS-CSTC Standards Technical Services Co., Ltd., Shenzhen EMC Laboratory is accredited by the American Association for Laboratory Accreditation(A2LA). Certificate No. 3816.01.

- **VCCI**

The 10m Semi-anechoic chamber and Shielded Room of SGS-CSTC Standards Technical Services Co., Ltd. have been registered in accordance with the Regulations for Voluntary Control Measures with Registration No.: G-823, R-4188, T-1153 and C-2383 respectively.

- **FCC – Registration No.: 556682**

SGS-CSTC Standards Technical Services Co., Ltd., Shenzhen EMC Laboratory has been registered and fully described in a report filed with the (FCC) Federal Communications Commission. The acceptance letter from the FCC is maintained in our files. Registration No.: 556682.

- **Industry Canada (IC)**

Two 3m Semi-anechoic chambers and the 10m Semi-anechoic chamber of SGS-CSTC Standards Technical Services Co., Ltd. Shenzhen Branch EMC Lab have been registered by Certification and Engineering Bureau of Industry Canada for radio equipment testing with Registration No.: 4620C-1, 4620C-2, 4620C-3.

## 4.8 Deviation from Standards

None.

## 4.9 Abnormalities from Standard Conditions

None.

## 4.10 Other Information Requested by the Customer

None.





#### 4.11 Technical Specification

Characteristics	Description	
Radio System Type	<input checked="" type="checkbox"/> GSM	
	<input checked="" type="checkbox"/> UMTS	
Supported Frequency Range	GSM850	Transmission (TX): 824 to 849 MHz
		Receiving (RX): 869 to 894 MHz
	GSM1900	Transmission (TX): 1850 to 1910 MHz
		Receiving (RX): 1930 to 1990 MHz
	UMTS 850	Transmission (TX): 824 to 849 MHz
		Receiving (RX): 869 to 894 MHz
UMTS 1900	Transmission (TX): 1850 to 1910 MHz	
	Receiving (RX): 1930 to 1990 MHz	
Target TX Output Power	GSM850: 33dBm GSM1900: 30dBm UMTS 850: 23dBm UMTS 1900: 23dBm	
Supported Channel Bandwidth	GSM system:	<input checked="" type="checkbox"/> 200 kHz
	UMTS system:	<input checked="" type="checkbox"/> 5 MHz
Designation of Emissions (Note: the necessary bandwidth of which is the worst value from the measured occupied bandwidths for each type of channel bandwidth configuration.)	GPRS850:	241KGXW
	GPRS(4slots)850:	240KGXW
	EGPRS850:	243KG7W
	GPRS1900	243KGXW
	GPRS(4slots)1900:	243KGXW
	EGPRS1900:	244KG7W
	UMTS850:	4M07F9W
	HSDPA850	4M07F9W
	HSUPA850	4M07F9W
	UMTS1900:	4M07F9W
	HSDPA1900	4M08F9W
	HSUPA1900	4M08F9W



## **5 Description of Tests**

### **5.1 Conducted Output Power**

Measurement Procedure: FCC KDB 971168 D01 Power Meas License Digital Systems v02r02

The transmitter output was connected to a calibrated coaxial cable, attenuator and power meter, the other end of which was connected to a Base Station Simulator. The Base Station Simulator was set to force the EUT to its maximum power setting. The power output at the transmitter antenna port was determined by adding the value of the cable insertion loss to the power reading. The tests were performed at three frequencies (low channel, middle channel and high channel) and on the highest power levels, which can be setup on the transmitters.

**Note: Reference test setup 1**

### **5.2 Effective (Isotropic) Radiated Power of Transmitter**

Measurement Procedure: FCC KDB 971168 D01 Power Meas License Digital Systems v02r02

#### **Below 1GHz test procedure as below:**

- 1). The EUT was powered ON and placed on a 0.8m high table in the chamber. The antenna of the transmitter was extended to its maximum length.
- 2). The disturbance of the transmitter was maximized on the test receiver display by raising and lowering from 1m to 4m the receive antenna and by rotating through 360° the turntable. After the fundamental emission was maximized, a field strength measurement was made.
- 3). Steps 1) and 2) were performed with the EUT and the receive antenna in both vertical and horizontal polarization.
- 4). The transmitter was then removed and replaced with another antenna. The center of the antenna was approximately at the same location as the center of the transmitter.
- 5). A signal at the disturbance was fed to the substitution antenna by means of a non-radiating cable. With both the substitution and the receive antennas horizontally polarized, the receive antenna was raised and lowered to obtain a maximum reading at the test receiver. The level of the signal generator was adjusted until the measured field strength level in step 2) is obtained for this set of conditions.
- 6). The output power into the substitution antenna was then measured.
- 7). Steps 5) and 6) were repeated with both antennas polarized.
- 8). Calculate power in dBm by the following formula:



$$\text{ERP (dBm)} = \text{Pg(dBm)} - \text{cable loss (dB)} + \text{antenna gain (dBd)}$$

Where:

Pg is the generator output power into the substitution antenna.

**Above 1GHz test procedure as below:**

- 1). Different between above is the test site, change from Semi- Anechoic Chamber to fully Anechoic Chamber
- 2). Calculate power in dBm by the following formula:  
$$\text{EIRP(dBm)} = \text{Pg(dBm)} - \text{cable loss (dB)} + \text{antenna gain (dBi)}$$
$$\text{EIRP} = \text{ERP} + 2.15\text{dB}$$
- Where:  
Pg is the generator output power into the substitution antenna.
- 3). Test the EUT in the lowest channel, the middle channel the Highest channel
- 4). The radiation measurements are performed in X, Y, Z axis positioning. And found the X axis positioning which it is worse case, Only the test worst case mode is recorded in the report.
- 5). Repeat above procedures until all frequencies measured was complete.

**Note: Reference test setup 2**

## **5.3 Occupied Bandwidth**

Measurement Procedure: FCC KDB 971168 D01 Power Meas License Digital Systems v02r02

The occupied bandwidth, that is the frequency bandwidth such that, below its lower and above its upper frequency limits, the mean powers radiated are each equal to 0.5 percent of the total mean power radiated by a given emission shall be measured. The transmitter output was connected to a calibrated coaxial cable, attenuator and Spectrum analyser, the other end of which was connected to a Base Station Simulator. The Base Station Simulator was set to force the EUT to its maximum power setting. The tests were performed at three frequencies (low channel, middle channel and high channel). The span of the analyzer shall be set to capture all products of the modulation process, including the emission skirts. The resolution bandwidth shall be set to as close to 1 percent of the selected span as is possible without being below 1 percent. The video bandwidth shall be set to 3 times the resolution bandwidth. Video averaging is not permitted. Where practical, a sampling detector shall be used since a peak or, peak hold, may produce a wider bandwidth than actual. The trace data points are recovered and are directly summed in linear terms. The recovered amplitude data points, beginning at the lowest frequency, are placed in a running sum until 0.5 percent of the total is reached and that frequency recorded. The process is repeated for the highest frequency data points. This frequency is recorded. The span between the two recorded frequencies is the occupied bandwidth.

"This document is issued by the Company subject to its General Conditions of Service printed overleaf, available on request or accessible at [www.sgs.com/terms\\_and\\_conditions.htm](http://www.sgs.com/terms_and_conditions.htm) and, for electronic format documents, subject to Terms and Conditions for Electronic Documents at [www.sgs.com/terms\\_e-document.htm](http://www.sgs.com/terms_e-document.htm). Attention is drawn to the limitation of liability, indemnification and jurisdiction issues defined therein. Any holder of this document is advised that information contained hereon reflects the Company's findings at the time of its intervention only and within the limits of Client's instructions, if any. The Company's sole responsibility is to its Client and this document does not exonerate parties to a transaction from exercising all their rights and obligations under the transaction documents. This document cannot be reproduced except in full, without prior written approval of the Company. Any unauthorized alteration, forgery or falsification of the content or appearance of this document is unlawful and offenders may be prosecuted to the fullest extent of the law. Unless otherwise stated the results shown in this test report refer only to the sample(s) tested and such sample(s) are retained for 90 days only."



**Note: Reference test setup 1**

## **Band Edge at Antenna Terminals**

Measurement Procedure: FCC KDB 971168 D01 Power Meas License Digital Systems v02r02

The transmitter output was connected to a calibrated coaxial cable, attenuator and Spectrum analyser, the other end of which was connected to a Base Station Simulator. The Base Station Simulator was set to force the EUT to its maximum power setting. The tests were performed at three frequencies (low channel and high channel).in the 1MHz bands immediately outside and adjacent to the frequency block a resolution bandwidth of 100kHz or 1% of the emission bandwidth of the fundamental emission of the transmitter may be employed. The EUT emission bandwidth is measured as the width of the signal between two points, outside of which all emission are attenuated at least 26dB below the transmitter power. The video bandwidth of the spectrum analyzer was set at thrice the resolution bandwidth. Detector Mode was set to peak or peak hold power.

**Note: Reference test setup 1**

## **5.4 Spurious And Harmonic Emissions at Antenna Terminal**

Measurement Procedure: FCC KDB 971168 D01 Power Meas License Digital Systems v02r02

The transmitter output was connected to a calibrated coaxial cable, attenuator and Spectrum analyzer, the other end of which was connected to a Base Station Simulator. The Base Station Simulator was set to force the EUT to its maximum power setting. The tests were performed at three frequencies (low channel and high channel).The level of the carrier and the various conducted spurious and harmonic frequencies is measured by means of a calibrated spectrum analyzer. The spectrum is scanned from the lowest frequency generated in the equipment up to a frequency including its 10th harmonic. On any frequency outside a licensee's frequency block, the power of any emission shall be attenuated below the transmitter power (P) by at least  $43 + 10 \log(P)$  dB. Compliance with these provisions is based on the use of measurement instrumentation employing a resolution bandwidth of 1 MHz or greater. However, in the 1 MHz bands immediately outside and adjacent to the frequency block a resolution bandwidth of at least one percent of the emission bandwidth of the fundamental emission of the transmitter may be employed. The emission bandwidth is defined as the width of the signal between two points, one below the carrier center frequency and one above the carrier center frequency, outside of which all emission are attenuated at least 26 dB below the transmitter power.

**Note: Reference test setup 1**

"This document is issued by the Company subject to its General Conditions of Service printed overleaf, available on request or accessible at [www.sgs.com/terms\\_and\\_conditions.htm](http://www.sgs.com/terms_and_conditions.htm) and, for electronic format documents, subject to Terms and Conditions for Electronic Documents at [www.sgs.com/terms\\_e-document.htm](http://www.sgs.com/terms_e-document.htm). Attention is drawn to the limitation of liability, indemnification and jurisdiction issues defined therein. Any holder of this document is advised that information contained hereon reflects the Company's findings at the time of its intervention only and within the limits of Client's instructions, if any. The Company's sole responsibility is to its Client and this document does not exonerate parties to a transaction from exercising all their rights and obligations under the transaction documents. This document cannot be reproduced except in full, without prior written approval of the Company. Any unauthorized alteration, forgery or falsification of the content or appearance of this document is unlawful and offenders may be prosecuted to the fullest extent of the law. Unless otherwise stated the results shown in this test report refer only to the sample(s) tested and such sample(s) are retained for 90 days only."



## 5.5 Peak-Average Ratio

Measurement Procedure: FCC KDB 971168 D01 Power Meas License Digital Systems v02r02

A peak to average ratio measurement is performed at the conducted port of the EUT. For WCDMA signals, the spectrum analyzers Complementary Cumulative Distribution Function (CCDF) measurement profile is used to determine the largest deviation between the average and the peak power of the EUT in a given bandwidth. The CCDF curve shows how much time the peak waveform spends at or above a given average power level. The percent of time the signal spends at or above the level defines the probability for that particular power level. For GSM signals, an average and a peak trace are used on a spectrum analyzer to determine the largest deviation between the average and the peak power of the EUT in a bandwidth greater than the emission bandwidth. The traces are generated with the spectrum analyzer set to zero span mode.

**Note: Reference test setup 1**

## 5.6 Field Strength of Spurious Radiation

Measurement Procedure: FCC KDB 971168 D01 Power Meas License Digital Systems v02r02

**Below 1GHz test procedure as below:**

- 1). The EUT was powered ON and placed on a 80cm high table in the chamber. The antenna of the transmitter was extended to its maximum length.
- 2). The disturbance of the transmitter was maximized on the test receiver display by raising and lowering from 1m to 4m (for the test frequency of below 30MHz, the antenna was tuned to heights 1 meter) the receive antenna and by rotating through 360° the turntable. After the fundamental emission was maximized, a field strength measurement was made.
- 3). Steps 1) and 2) were performed with the EUT and the receive antenna in both vertical and horizontal polarization.
- 4). The transmitter was then removed and replaced with another antenna. The center of the antenna was approximately at the same location as the center of the transmitter.
- 5). A signal at the disturbance was fed to the substitution antenna by means of a non-radiating cable. With both the substitution and the receive antennas horizontally polarized, the receive antenna was raised and lowered to obtain a maximum reading at the test receiver. The level of the signal generator was adjusted until the measured field strength level in step 2) is obtained for this set of conditions.
- 6). The output power into the substitution antenna was then measured.
- 7). Steps 5) and 6) were repeated with both antennas polarized.
- 8) Calculate power in dBm by the following formula:

$$\text{ERP(dBm)} = \text{Pg(dBm)} - \text{cable loss (dB)} + \text{antenna gain (dBd)}$$

"This document is issued by the Company subject to its General Conditions of Service printed overleaf, available on request or accessible at [www.sgs.com/terms\\_and\\_conditions.htm](http://www.sgs.com/terms_and_conditions.htm) and, for electronic format documents, subject to Terms and Conditions for Electronic Documents at [www.sgs.com/terms\\_e-document.htm](http://www.sgs.com/terms_e-document.htm). Attention is drawn to the limitation of liability, indemnification and jurisdiction issues defined therein. Any holder of this document is advised that information contained hereon reflects the Company's findings at the time of its intervention only and within the limits of Client's instructions, if any. The Company's sole responsibility is to its Client and this document does not exonerate parties to a transaction from exercising all their rights and obligations under the transaction documents. This document cannot be reproduced except in full, without prior written approval of the Company. Any unauthorized alteration, forgery or falsification of the content or appearance of this document is unlawful and offenders may be prosecuted to the fullest extent of the law. Unless otherwise stated the results shown in this test report refer only to the sample(s) tested and such sample(s) are retained for 90 days only."



Where:

$P_d$  is the dipole equivalent power,  $P_g$  is the generator output into the substitution antenna, and the antenna gain is the gain of the substitute antenna used relative to either a half-wave dipole (dBd) or an isotropic source (dBi). The substitute level is equal to  $P_g$  [dBm] – cable loss [dB]. The calculated  $P_d$  levels are then compared to the absolute spurious emission limit of -13dBm which is equivalent to the required minimum attenuation of  $43 + 10\log_{10}(\text{Power [Watts]})$ .

**Above 1GHz test procedure as below:**

- 1) Different between above is the test site, change from Semi- Anechoic Chamber to fully Anechoic Chamber
- 2) Calculate power in dBm by the following formula:

$$\text{EIRP(dBm)} = P_g(\text{dBm}) - \text{cable loss (dB)} + \text{antenna gain (dBi)}$$

$$\text{EIRP} = \text{ERP} + 2.15\text{dB}$$

Where:

$P_g$  is the generator output power into the substitution antenna.

3. Test the EUT in the lowest channel, the middle channel the Highest channel
4. The radiation measurements are performed in X, Y, Z axis positioning. And found the X axis positioning which it is worse case, Only the test worst case mode is recorded in the report.
5. Repeat above procedures until all frequencies measured was complete

**Note: Reference test setup 3**

## **5.7 Frequency Stability / Temperature Variation**

Measurement Procedure:

Frequency stability testing is performed in accordance with the guidelines of FCC KDB 971168 D01 Power Meas License Digital Systems v02r02. The frequency stability of the transmitter is measured by:

- a.) **Temperature:** The temperature is varied from -30°C to +50°C in 10°C increments using an environmental chamber.
- b.) **Primary Supply Voltage:** The primary supply voltage is varied from 85% to 115% of the nominal value for non hand-carried battery and AC powered equipment. For hand-carried, battery-powered equipment, primary supply voltage is reduced to the battery operating end point which shall be specified by the manufacturer.

Specification – The frequency stability shall be sufficient to ensure that the fundamental emission stays within the authorized frequency block. The frequency stability of the transmitter shall be maintained within  $\pm 0.00025\%$  ( $\pm 2.5$  ppm ) of the center frequency.

**Time Period and Procedure:**

1. The carrier frequency of the transmitter is measured at room temperature (20°C to provide a

"This document is issued by the Company subject to its General Conditions of Service printed overleaf, available on request or accessible at [www.sgs.com/terms\\_and\\_conditions.htm](http://www.sgs.com/terms_and_conditions.htm) and, for electronic format documents, subject to Terms and Conditions for Electronic Documents at [www.sgs.com/terms\\_e-document.htm](http://www.sgs.com/terms_e-document.htm). Attention is drawn to the limitation of liability, indemnification and jurisdiction issues defined therein. Any holder of this document is advised that information contained hereon reflects the Company's findings at the time of its intervention only and within the limits of Client's instructions, if any. The Company's sole responsibility is to its Client and this document does not exonerate parties to a transaction from exercising all their rights and obligations under the transaction documents. This document cannot be reproduced except in full, without prior written approval of the Company. Any unauthorized alteration, forgery or falsification of the content or appearance of this document is unlawful and offenders may be prosecuted to the fullest extent of the law. Unless otherwise stated the results shown in this test report refer only to the sample(s) tested and such sample(s) are retained for 90 days only."



reference).

2. The equipment is turned on in a “standby” condition for fifteen minutes before applying power to the transmitter. Measurement of the carrier frequency of the transmitter is made within one minute after applying power to the transmitter.
3. Frequency measurements are made at 10°C intervals ranging from -30°C to +50°C. A period of at least one half-hour is provided to allow stabilization of the equipment at each temperature level.

**Note: Reference test setup 4**

## 5.8 Test Setups

### 5.8.1 Test Setup 1

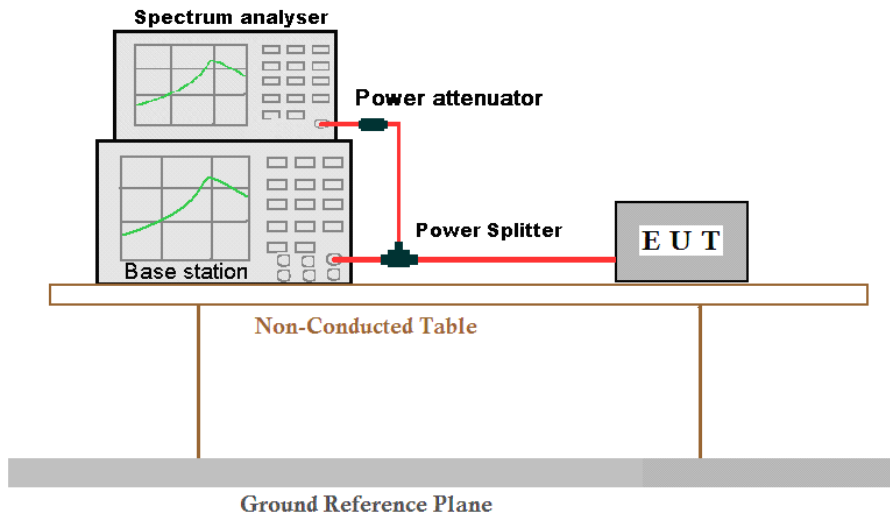



**5.8.2 Test Setup 2**

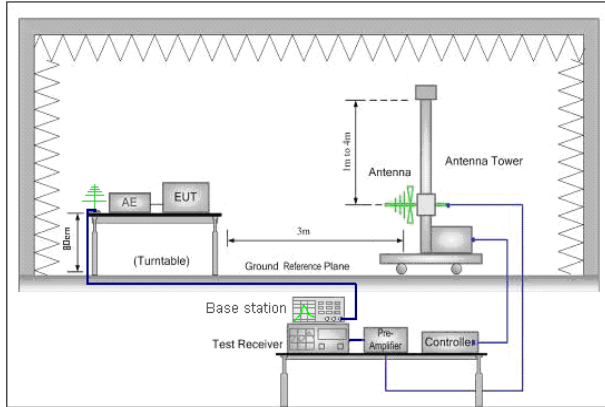

Figure 1. 30MHz to 1GHz

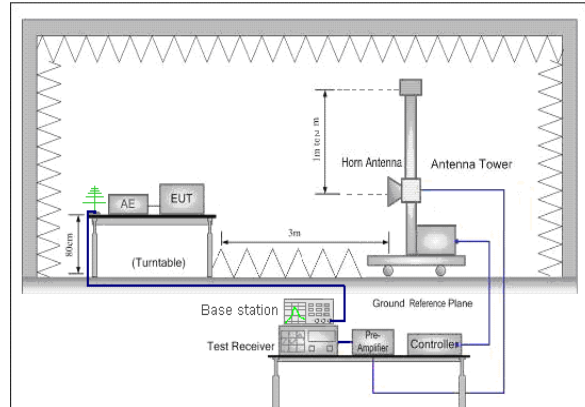

Figure 2. above 1GHz

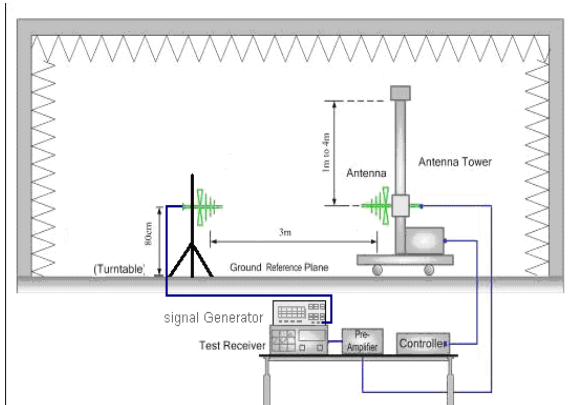

Figure 1. 30MHz to 1GHz

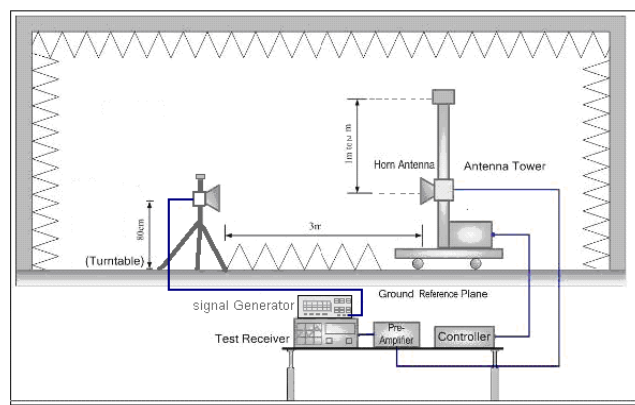

Figure 2. above 1GHz

### 5.8.3 Test Setup 3

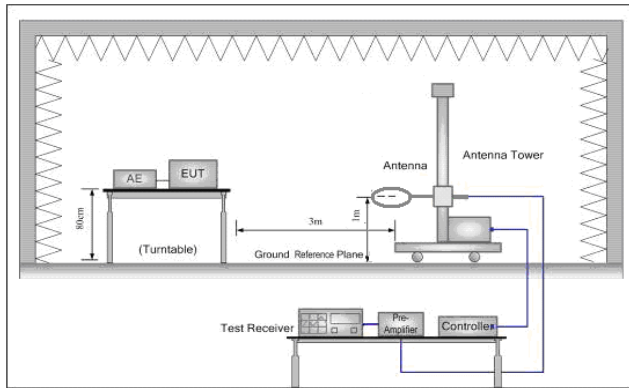

Figure 1. Below 30MHz

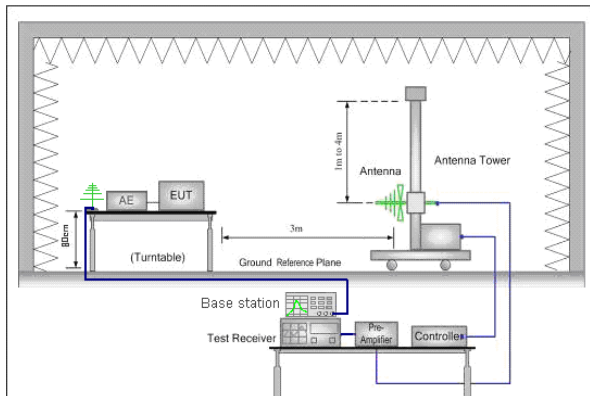

Figure 2. 30MHz to 1GHz

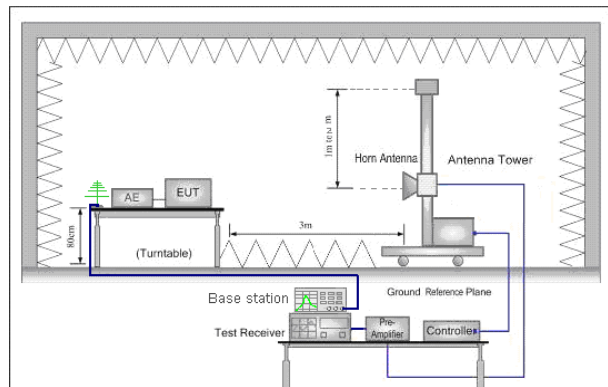

Figure 3. above 1GHz

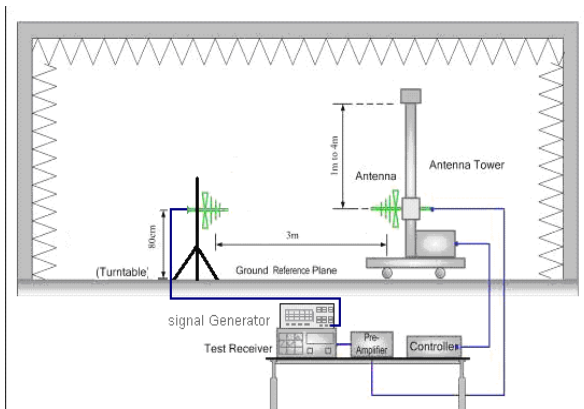

Figure 2. 30MHz to 1GHz

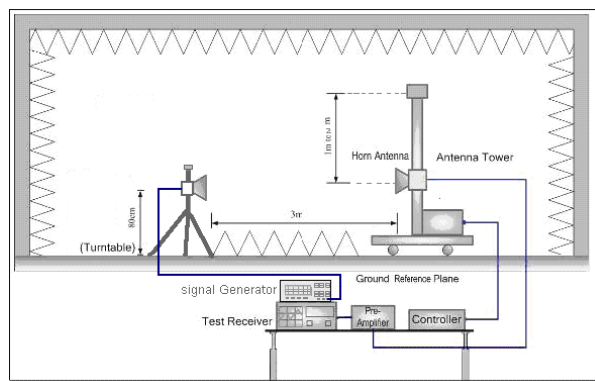
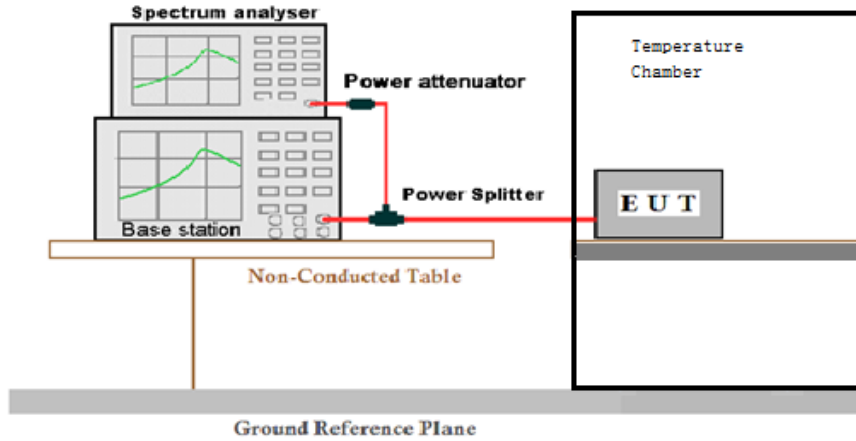

Figure 3. above 1GHz

#### 5.8.4 Test Setup 4





## 5.9 Test Conditions

Test Case		Test Conditions	
Transmit Output Power Data	Average Power, Total	Test Environment	Ambient Climate & Rated Voltage
		Test Setup	Test Setup 1
		RF Channels (TX)	L, M, H (L= low channel, M= middle channel, H= high channel )
		Test Mode	GSM/TM1;GSM/TM2;UMTS/TM1
	Average Power, Spectral Density (if required)	Test Environment	Ambient Climate & Rated Voltage
		Test Setup	Test Setup 1
		RF Channels (TX)	L, M, H (L= low channel, M= middle channel, H= high channel )
		Test Mode	GSM/TM1;GSM/TM2;UMTS/TM1
Peak-to-Average Ratio (if required)	Test Environment	Ambient Climate & Rated Voltage	
	Test Setup	Test Setup 1	
	RF Channels (TX)	L, M, H (L= low channel, M= middle channel, H= high channel )	
	Test Mode	GSM/TM1;GSM/TM2;UMTS/TM1	
Modulation Characteristics	Test Environment	Ambient Climate & Rated Voltage	
	Test Setup	Test Setup 1	
	RF Channels (TX)	M (M= middle channe )	
	Test Mode	GSM/TM1;GSM/TM2;UMTS/TM1	
Bandwidth	Occupied Bandwidth	Test Environment	Ambient Climate & Rated Voltage
		Test Setup	Test Setup 1
		RF Channels (TX)	M (M= middle channel )
		Test Mode	GSM/TM1;GSM/TM2;UMTS/TM1
	Emission Bandwidth (if required)	Test Environment	Ambient Climate & Rated Voltage
		Test Setup	Test Setup 1
		RF Channels (TX)	M (M= middle channel )
		Test Mode	GSM/TM1;GSM/TM2;UMTS/TM1
Band Edges Compliance	Test Environment	Ambient Climate & Rated Voltage	
	Test Setup	Test Setup 1	
	RF Channels (TX)	L, H (L= low channel, H= high channel )	

"This document is issued by the Company subject to its General Conditions of Service printed overleaf, available on request or accessible at [www.sgs.com/terms\\_and\\_conditions.htm](http://www.sgs.com/terms_and_conditions.htm) and, for electronic format documents, subject to Terms and Conditions for Electronic Documents at [www.sgs.com/terms\\_e-document.htm](http://www.sgs.com/terms_e-document.htm). Attention is drawn to the limitation of liability, indemnification and jurisdiction issues defined therein. Any holder of this document is advised that information contained herein reflects the Company's findings at the time of its intervention only and within the limits of Client's instructions, if any. The Company's sole responsibility is to its Client and this document does not exonerate parties to a transaction from exercising all their rights and obligations under the transaction documents. This document cannot be reproduced except in full, without prior written approval of the Company. Any unauthorized alteration, forgery or falsification of the content or appearance of this document is unlawful and offenders may be prosecuted to the fullest extent of the law. Unless otherwise stated the results shown in this test report refer only to the sample(s) tested and such sample(s) are retained for 90 days only."



**SGS-CSTC Standards Technical Services Co., Ltd.**  
**Shenzhen Branch**

Report No.: SZEM16098050RG

Page: 21 of 26

	Test Mode	GSM/TM1;GSM/TM2;UMTS/TM1
Spurious Emission at Antenna Terminals	Test Environment	Ambient Climate & Rated Voltage
	Test Setup	Test Setup 1
	RF Channels (TX)	L, M,H (L= low channel, M= middle channel, H= high channel )
	Test Mode	GSM/TM1;GSM/TM2;UMTS/TM1
Field Strength of Spurious Radiation	Test Environment	Ambient Climate & Rated Voltage
	Test Setup	Test Setup 2
	Test Mode	GSM/TM1;GSM/TM2;UMTS/TM1 NOTE: If applicable, the EUT conf. that has maximum power density (based on the equivalent power level) is selected.
	RF Channels (TX)	L, M, H (L= low channel, M= middle channel, H= high channel )
Frequency Stability	Test Env.	(1) -30 °C to +50 °C with step 10 °C at Rated Voltage; (2) VL, VN and VH of Rated Voltage at Ambient Climate.
	Test Setup	Test Setup 3
	RF Channels (TX)	L, M, H (L= low channel, M= middle channel, H= high channel )
	Test Mode	GSM/TM1;GSM/TM2;UMTS/TM1

"This document is issued by the Company subject to its General Conditions of Service printed overleaf, available on request or accessible at [www.sgs.com/terms\\_and\\_conditions.htm](http://www.sgs.com/terms_and_conditions.htm) and, for electronic format documents, subject to Terms and Conditions for Electronic Documents at [www.sgs.com/terms\\_e-document.htm](http://www.sgs.com/terms_e-document.htm). Attention is drawn to the limitation of liability, indemnification and jurisdiction issues defined therein. Any holder of this document is advised that information contained hereon reflects the Company's findings at the time of its intervention only and within the limits of Client's instructions, if any. The Company's sole responsibility is to its Client and this document does not exonerate parties to a transaction from exercising all their rights and obligations under the transaction documents. This document cannot be reproduced except in full, without prior written approval of the Company. Any unauthorized alteration, forgery or falsification of the content or appearance of this document is unlawful and offenders may be prosecuted to the fullest extent of the law. Unless otherwise stated the results shown in this test report refer only to the sample(s) tested and such sample(s) are retained for 90 days only."



## 6 Main Test Instruments

Conducted Emission						
Item	Test Equipment	Manufacturer	Model No.	Inventory No.	Cal. date (yyyy-mm-dd)	Cal.Due date (yyyy-mm-dd)
1	Shielding Room	ZhongYu Electron	GB-88	SEL0042	2016-05-13	2017-05-13
2	LISN	Rohde & Schwarz	ENV216	SEL0152	2015-10-09	2016-10-09
3	LISN	ETS-LINDGREN	3816/2	SEL0021	2016-05-13	2017-05-13
4	8 Line ISN	Fischer Custom Communications Inc.	FCC-TLISN-T8-02	EMC0120	2015-08-30	2016-08-30
5	4 Line ISN	Fischer Custom Communications Inc.	FCC-TLISN-T4-02	EMC0121	2015-08-30	2016-08-30
6	2 Line ISN	Fischer Custom Communications Inc.	FCC-TLISN-T2-02	EMC0122	2015-08-30	2016-08-30
7	EMI Test Receiver	Rohde & Schwarz	ESCI	SEL0022	2016-05-13	2017-05-13
8	Coaxial Cable	SGS	N/A	SEL0025	2016-05-13	2017-05-13
9	Universal radio communication tester	Rohde & Schwarz	CMU200	SEL0091	2015-10-23	2016-10-23
10	Universal radio communication tester	Rohde & Schwarz	CMU200	SEL0194	2015-10-23	2016-10-23
11	DC Power Supply	Zhao Xin	RXN-305D	SEL0117	2015-10-09	2016-10-09



**SGS-CSTC Standards Technical Services Co., Ltd.**  
**Shenzhen Branch**

Report No.: SZEM16098050RG

Page: 23 of 26

RE in Chamber						
Item	Test Equipment	Manufacturer	Model No.	Inventory No.	Cal. date (yyyy-mm-dd)	Cal.Due date (yyyy-mm-dd)
1	3m Semi-Anechoic Chamber	ETS-LINDGREN	N/A	SEL0017	2016-05-13	2017-05-13
2	EMI Test Receiver	Agilent Technologies	N9038A	SEL0312	2016-09-16	2017-09-16
3	EMI Test software	AUDIX	E3	SEL0050	N/A	N/A
4	BiConiLog Antenna (26-3000MHz)	ETS-LINDGREN	3142C	SEL0015	2014-11-15	2017-11-15
5	Double-ridged horn (1-18GHz)	ETS-LINDGREN	3117	SEL0006	2015-10-17	2016-10-17
6	Horn Antenna (18-26GHz)	ETS-LINDGREN	3160	SEL0076	2014-11-24	2017-11-24
7	Pre-amplifier (0.1-1300MHz)	Agilent Technologies	8447D	SEL0053	2016-05-13	2017-05-13
8	Pre-Amplifier (0.1-26.5GHz)	Compliance Directions Systems Inc.	PAP-0126	SEL0168	2015-10-17	2016-10-17
9	Coaxial cable	SGS	N/A	SEL0027	2016-05-13	2017-05-13
10	Coaxial cable	SGS	N/A	SEL0189	2016-05-13	2017-05-13
11	Coaxial cable	SGS	N/A	SEL0121	2016-05-13	2017-05-13
12	Coaxial cable	SGS	N/A	SEL0178	2016-05-13	2017-05-13
13	Band filter	Amindeon	82346	SEL0094	2016-05-13	2017-05-13
14	Barometer	Chang Chun	DYM3	SEL0088	2016-05-13	2017-05-13
15	DC Power Supply	Zhao Xin	RXN-305D	SEL0117	2015-10-09	2016-10-09
16	Humidity/ Temperature Indicator	Shanghai Qixiang	ZJ1-2B	SEL0103	2015-10-24	2016-10-24
17	Signal Generator (10M-27GHz)	Rohde & Schwarz	SMR27	SEL0067	2016-05-13	2017-05-13
18	Loop Antenna	Beijing Daze	ZN30401	SEL0203	2016-05-13	2017-05-13
19	Universal radio communication tester	Rohde & Schwarz	CMU200	SEL0091	2016-05-13	2017-05-13
20	Universal radio communication tester	Rohde & Schwarz	CMU200	SEL0194	2015-10-23	2016-10-23

"This document is issued by the Company subject to its General Conditions of Service printed overleaf, available on request or accessible at [www.sgs.com/terms\\_and\\_conditions.htm](http://www.sgs.com/terms_and_conditions.htm) and, for electronic format documents, subject to Terms and Conditions for Electronic Documents at [www.sgs.com/terms\\_e-document.htm](http://www.sgs.com/terms_e-document.htm). Attention is drawn to the limitation of liability, indemnification and jurisdiction issues defined therein. Any holder of this document is advised that information contained hereon reflects the Company's findings at the time of its intervention only and within the limits of Client's instructions, if any. The Company's sole responsibility is to its Client and this document does not exonerate parties to a transaction from exercising all their rights and obligations under the transaction documents. This document cannot be reproduced except in full, without prior written approval of the Company. Any unauthorized alteration, forgery or falsification of the content or appearance of this document is unlawful and offenders may be prosecuted to the fullest extent of the law. Unless otherwise stated the results shown in this test report refer only to the sample(s) tested and such sample(s) are retained for 90 days only."



**SGS-CSTC Standards Technical Services Co., Ltd.  
Shenzhen Branch**

Report No.: SZEM16098050RG

Page: 24 of 26

RF connected test						
Item	Test Equipment	Manufacturer	Model No.	Inventory No.	Cal. date (yyyy-mm-dd)	Cal.Due date (yyyy-mm-dd)
1	DC Power Supply	Zhao Xin	RXN-305D	SEL0117	2015-10-09	2016-10-09
2	Humidity/ Temperature Indicator	HYGRO	ZJ1-2B	SEL0033	2015-10-24	2016-10-24
3	Spectrum Analyzer	Rohde & Schwarz	FSP	SEL0154	2015-10-17	2016-10-17
4	Coaxial cable	SGS	N/A	SEL0178	2016-05-13	2017-05-13
5	Coaxial cable	SGS	N/A	SEL0179	2016-05-13	2017-05-13
6	Barometer	ChangChun	DYM3	SEL0088	2016-05-13	2017-05-13
7	Signal Generator	Rohde & Schwarz	SML03	SEL0068	2016-04-25	2017-04-25
8	POWER METER	R & S	NRVS	SEL0144	2015-10-09	2016-10-09
9	Attenuator	Beijin feihang taida	TST-2-6dB	SEL0205	2016-04-25	2017-04-25
10	Universal radio communication tester	Rohde & Schwarz	CMU200	SEL0091	2015-10-23	2016-10-23
11	Universal radio communication tester	Rohde & Schwarz	CMU200	SEL0194	2015-10-23	2016-10-23
12	Band filter	amideon	82346	SEL0094	2016-05-16	2017-05-16
13	Power Divier(splitter))	Agilent Technologies	11636B	SEL0130	2015-10-24	2016-10-24

"This document is issued by the Company subject to its General Conditions of Service printed overleaf, available on request or accessible at [www.sgs.com/terms\\_and\\_conditions.htm](http://www.sgs.com/terms_and_conditions.htm) and, for electronic format documents, subject to Terms and Conditions for Electronic Documents at [www.sgs.com/terms\\_e-document.htm](http://www.sgs.com/terms_e-document.htm). Attention is drawn to the limitation of liability, indemnification and jurisdiction issues defined therein. Any holder of this document is advised that information contained hereon reflects the Company's findings at the time of its intervention only and within the limits of Client's instructions, if any. The Company's sole responsibility is to its Client and this document does not exonerate parties to a transaction from exercising all their rights and obligations under the transaction documents. This document cannot be reproduced except in full, without prior written approval of the Company. Any unauthorized alteration, forgery or falsification of the content or appearance of this document is unlawful and offenders may be prosecuted to the fullest extent of the law. Unless otherwise stated the results shown in this test report refer only to the sample(s) tested and such sample(s) are retained for 90 days only."





## 7 Measurement Uncertainty

For a 95% confidence level ( $k = 2$ ), the measurement expanded uncertainties for defined systems, in accordance with the recommendations of ISO 17025 as following:

Test Item	Extended Uncertainty	Data
Transmit Output Power Data	Power [dBm]	U = 0.37 dB
Bandwidth	Magnitude [%]	U = 0.2%
Band Edge Compliance	Disturbance Power [dBm]	U = 2.0 dB
Spurious Emissions, Conducted	Disturbance Power [dBm]	U = 2.0 dB
Field Strength of Spurious Radiation	ERP [dBm]	For 3 m Chamber: U = 4.5 dB (30 MHz to 1GHz) U = 3.3 dB (above 1 GHz) For 10 m Chamber: U = 4.5 dB (30 MHz to 1GHz) U = 3.2 dB (above 1 GHz)
Frequency Stability	Frequency Accuracy [ppm]	U = 0.24 ppm



## **8 Photographs - EUT Test Setup**

Refer to Appendix A - Photographs of EUT Test Setup for SZEM1609008050RG

## **9 Photographs - EUT Constructional Details**

Refer to Appendix A - Photographs of EUT Constructional Details for SZEM1609008050RG.

---

The End