



FCC RF Test Report

APPLICANT : Sierra Wireless Inc.
EQUIPMENT : Embedded module
BRAND NAME : AirPrime
MODEL NAME : HL8529
FCC ID : N7NHL8529
STANDARD : FCC 47 CFR Part 2, 22(H), 24(E)
CLASSIFICATION : PCS Licensed Transmitter (PCB)

The product was received on Oct. 09, 2015 and testing was completed on Nov. 18, 2015. We, SPORTON INTERNATIONAL(SHENZHEN) INC., would like to declare that the tested sample has been evaluated in accordance with the test procedures given in ANSI / TIA / EIA-603-D-2010 and has been in compliance with the applicable technical standards.

The test results in this report apply exclusively to the tested model / sample. Without written approval of SPORTON INTERNATIONAL (SHENZHEN) INC., the test report shall not be reproduced except in full.

Prepared by: Andy Yeh / Manager

Approved by: Jones Tsai / Manager



Testing Laboratory
2353

SPORTON INTERNATIONAL (SHENZHEN) INC.

**1F & 2F, Building A, Morning Business Center, No. 4003 ShiGu Rd., Xili Town,
Nanshan District, Shenzhen, Guangdong, P. R. China**



TABLE OF CONTENTS

REVISION HISTORY..... 3

SUMMARY OF TEST RESULT 4

1 GENERAL DESCRIPTION 5

 1.1 Applicant..... 5

 1.2 Manufacturer 5

 1.3 Product Feature of Equipment Under Test 5

 1.4 Product Specification subjective to this standard..... 6

 1.5 Modification of EUT 6

 1.6 Maximum Conducted Power, Frequency Tolerance, and Emission Designator..... 7

 1.7 Testing Location 7

 1.8 Applicable Standards 8

2 TEST CONFIGURATION OF EQUIPMENT UNDER TEST 9

 2.1 Test Mode..... 9

 2.2 Connection Diagram of Test System 10

 2.3 Support Unit used in test configuration 10

 2.4 Measurement Results Explanation Example 11

3 CONDUCTED TEST RESULT 12

 3.1 Measuring Instruments..... 12

 3.2 Test Setup 12

 3.3 Test Result of Conducted Test..... 12

 3.4 Conducted Output Power and ERP/EIRP 13

 3.5 Peak-to-Average Ratio 14

 3.6 99% Occupied Bandwidth and 26dB Bandwidth Measurement..... 15

 3.7 Conducted Band Edge 16

 3.8 Conducted Spurious Emission 17

 3.9 Frequency Stability..... 18

4 RADIATED TEST ITEMS 19

 4.1 Measuring Instruments..... 19

 4.2 Test Setup 19

 4.3 Test Result of Radiated Test..... 19

 4.4 Field Strength of Spurious Radiation Measurement 20

5 LIST OF MEASURING EQUIPMENT 21

6 UNCERTAINTY OF EVALUATION 22

APPENDIX A. TEST RESULTS OF CONDUCTED TEST

APPENDIX B. TEST RESULTS OF RADIATED TEST

APPENDIX C. TEST SETUP PHOTOGRAPHS

APPENDIX D. PRODUCT EQUALITY DECLARATION



REVISION HISTORY

REPORT NO.	VERSION	DESCRIPTION	ISSUED DATE
FG500918	Rev. 01	This report is for HL8529. The product equality declaration could be referred to Appendix D and all the test result of WCDMA Bands shown in this report were leveraged from HL8528 (Sporton Report Number FG 500917; FCC ID: N7NHL8528).	Jan. 12, 2016



SUMMARY OF TEST RESULT

Report Section	FCC Rule	IC Rule	Description	Limit	Result	Remark
3.4	§2.1046	RSS-132 (5.4) RSS-133 (6.4)	Conducted Output Power	Reporting Only	PASS	-
	§22.913(a)(2)	RSS-132(5.4) SRSP-503(5.1.3)	Effective Radiated Power	< 7 Watts	PASS	-
	§24.232(c)	RSS-133 (6.4) SRSP-510(5.1.2)	Equivalent Isotropic Radiated Power	< 2 Watts	PASS	-
3.5	§24.232(d)	RSS-132 (5.4) RSS-133 (6.4)	Peak-to-Average Ratio	< 13 dB	PASS	-
3.6	§2.1049 §22.917(b) §24.238(b)	RSS-GEN(6.6) RSS-132(3.1) RSS-133(3.1)	Occupied Bandwidth	Reporting Only	PASS	-
3.7	§2.1051 §22.917(a) §24.238(a)	RSS-132 (5.5) RSS-133 (6.5)	Band Edge Measurement	< 43+10log10(P[Watts])	PASS	-
3.8	§2.1051 §22.917(a) §24.238(a)	RSS-132 (5.5) RSS-133 (6.5)	Conducted Emission	< 43+10log10(P[Watts])	PASS	-
3.9	§2.1055 §22.355	RSS-GEN(6.11) RSS-132 (5.3)	Frequency Stability for Temperature & Voltage	< 2.5 ppm for Part 22H	PASS	-
	§2.1055 §24.235	RSS-GEN(6.11) RSS-133 (6.3)		Within Authorized Band		
4.4	§2.1053 §22.917(a) §24.238(a)	RSS-132 (5.5) RSS-133 (6.5)	Field Strength of Spurious Radiation	< 43+10log10(P[Watts])	PASS	Under limit 33.47 dB at 7630.400 MHz



1 General Description

1.1 Applicant

Sierra Wireless Inc.

13811 Wireless Way, Richmond, British Columbia V6V 3A4

1.2 Manufacturer

Sierra Wireless Inc.

13811 Wireless Way, Richmond, British Columbia V6V 3A4

1.3 Product Feature of Equipment Under Test

Product Feature	
Equipment	Embedded module
Brand Name	AirPrime
Model Name	HL8529
FCC ID	N7NHL8529
EUT supports Radios application	WCDMA/HSPA
IMEI Code	004999010640000
HW Version	1
SW Version	AHL85xx.5.14.3.1.20150720.x6255_3
EUT Stage	Production Unit

Remark: The above EUT's information was declared by manufacturer. Please refer to the specifications or user's manual for more detailed description.



1.4 Product Specification subjective to this standard

Product Specification subjective to this standard	
Tx Frequency	WCDMA: Band V: 826.4 MHz ~ 846.6 MHz Band II: 1852.4 MHz ~ 1907.6 MHz
Rx Frequency	WCDMA: Band V: 871.4 MHz ~ 891.6 MHz Band II: 1932.4 MHz ~ 1987.6 MHz
Maximum Output Power to Antenna	WCDMA: Band V: 22.77 dBm Band II: 23.12 dBm
Antenna Type	body mounted Antenna
Type of Modulation	WCDMA: QPSK (Uplink) HSDPA: QPSK (Uplink) HSUPA: QPSK (Uplink)

1.5 Modification of EUT

No modifications are made to the EUT during all test items.



1.6 Maximum Conducted Power, Frequency Tolerance, and Emission Designator

FCC Rule	System	Type of Modulation	Maximum Conducted Power	Frequency Tolerance (ppm)	Emission Designator
Part 22H	WCDMA Band V RMC 12.2Kbps	QPSK	0.1892	0.0347	4M07F9W
Part 24E	WCDMA Band II RMC 12.2Kbps	QPSK	0.2051	0.0165	4M07F9W

1.7 Testing Location

Test Site	SPORTON INTERNATIONAL (SHENZHEN) INC.	
Test Site Location	1F & 2F, Building A, Morning Business Center, No. 4003 ShiGu Rd., Xili Town, Nanshan District, Shenzhen, Guangdong, P. R. China TEL: +86-755-8637-9589 FAX: +86-755-8637-9595	
Test Site No.	Sporton Site No.	
	TH01-SZ	

Test Site	SPORTON INTERNATIONAL (SHENZHEN) INC.	
Test Site Location	No. 3 Building, the third floor of south, Shahe River west, Fengzeyuan warehouse, Nanshan District, Shenzhen, Guangdong, P. R. China TEL: +86-755- 3320-2398	
Test Site No.	Sporton Site No.	FCC/IC Registration No.
	03CH01-SZ	831040/4086F



1.8 Applicable Standards

According to the specifications of the manufacturer, the EUT must comply with the requirements of the following standards:

- ♦ 47 CFR Part 2, 22(H), 24(E)
- ♦ ANSI / TIA / EIA-603-D-2010
- ♦ FCC KDB 971168 D01 Power Meas. License Digital Systems v02r02
- ♦ FCC KDB 412172 D01 Determining ERP and EIRP v01r01
- ♦ IC RSS-132 Issue 3
- ♦ IC RSS-133 Issue 6
- ♦ IC RSS-Gen Issue 4

Remark: All test items were verified and recorded according to the standards and without any deviation during the test.



2 Test Configuration of Equipment Under Test

2.1 Test Mode

Antenna port conducted and radiated test items were performed according to KDB 971168 D01 Power Meas. License Digital Systems v02r02 with maximum output power.

Radiated emissions were investigated as following frequency range:

1. 30 MHz to 10th harmonic for WCDMA Band V.
2. 30 MHz to 10th harmonic for WCDMA Band II.

All modes and data rates and positions were investigated.

Test modes are chosen to be reported as the worst case configuration below:

Test Modes		
Band	Radiated TCs	Conducted TCs
WCDMA Band V	■ RMC 12.2Kbps Link	■ RMC 12.2Kbps Link
WCDMA Band II	■ RMC 12.2Kbps Link	■ RMC 12.2Kbps Link

2.2 Connection Diagram of Test System

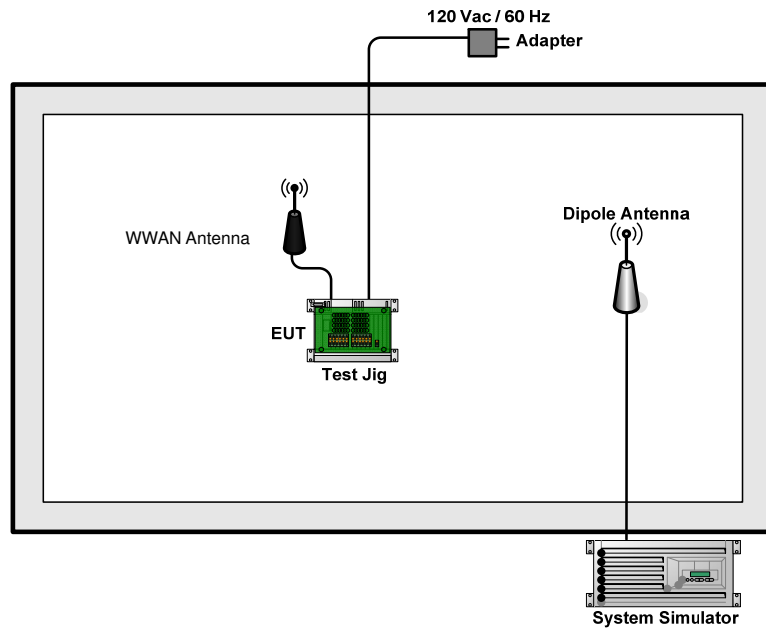

2.3 Support Unit used in test configuration

Item	Equipment	Trade Name	Model No.	FCC ID	Data Cable	Power Cord
1.	System Simulator	R&S	CMU 200	N/A	N/A	Unshielded, 1.8 m
2.	DC Power Supply	GW INSTRON	GPS-3030D	N/A	N/A	Unshielded, 1.8 m
3.	Adapter	Glob Tek	GT-41060-1505-1.0	N/A	N/A	Unshielded, 1.2 m
4.	WWAN Antenna	N/A	N/A	N/A	N/A	N/A
5.	Test jig	N/A	N/A	N/A	N/A	N/A



2.4 Measurement Results Explanation Example

For all conducted test items:

The offset level is set in the spectrum analyzer to compensate the RF cable loss and attenuator factor between RF conducted output port and spectrum analyzer. With the offset compensation, the spectrum analyzer reading level will be exactly the RF output level.

The spectrum analyzer offset is derived from RF cable loss and attenuator factor.

Offset = RF cable loss + attenuator factor.

The following shows an offset computation example with RF cable loss 4.5 dB and a 10dB attenuator.

Example :

$$\begin{aligned} \text{Offset(dB)} &= \text{RF cable loss(dB)} + \text{attenuator factor(dB)} \\ &= 4.5 + 10 = 14.5 \text{ (dB)} \end{aligned}$$

3 Conducted Test Result

3.1 Measuring Instruments

See list of measuring instruments of this test report.

3.2 Test Setup

3.2.1 Conducted Output Power

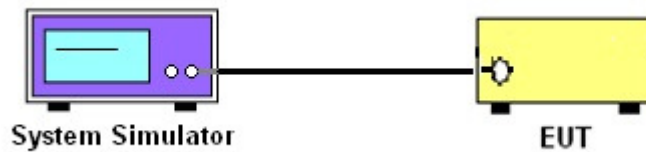

3.2.2 Peak-to-Average Ratio, Occupied Bandwidth, Conducted Band-Edge and Conducted Spurious Emission

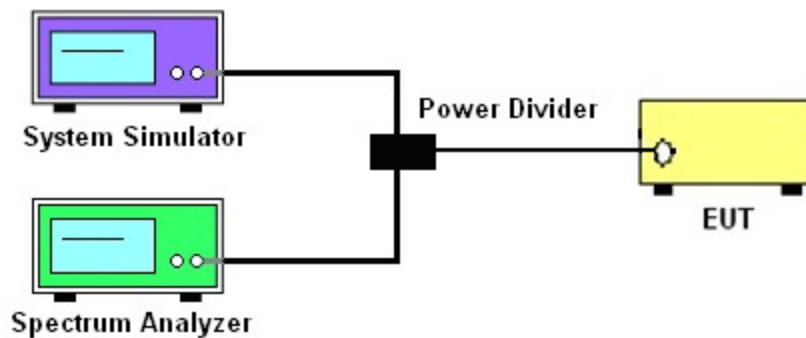

3.2.3 Frequency Stability

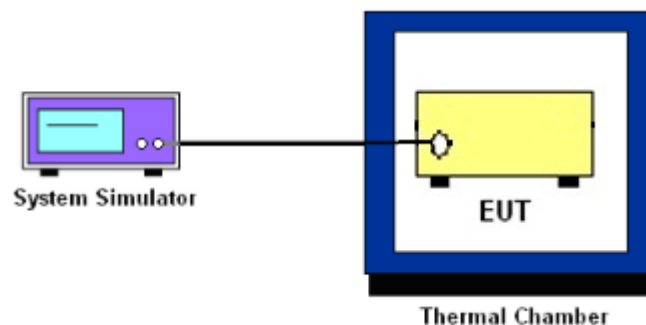

3.3 Test Result of Conducted Test

Please refer to Appendix A.



3.4 Conducted Output Power and ERP/EIRP

3.4.1 Description of the Conducted Output Power and ERP/EIRP

A system simulator was used to establish communication with the EUT. Its parameters were set to enforce EUT transmitting at the maximum power. The measured power in the radio frequency on the transmitter output terminals shall be reported.

The ERP of mobile transmitters must not exceed 7 Watts for WCDMA Band V.

The EIRP of mobile transmitters must not exceed 2 Watts for WCDMA Band II.

According to KDB 412172 D01 Power Approach,

$EIRP = P_T + G_T - L_C$, $ERP = EIRP - 2.15$, where

P_T = transmitter output power in dBm

G_T = gain of the transmitting antenna in dBi

L_C = signal attenuation in the connecting cable between the transmitter and antenna in dB

3.4.2 Test Procedures

1. The transmitter output port was connected to the system simulator.
2. Set EUT at maximum power through system simulator.
3. Select lowest, middle, and highest channels for each band and different modulation.
4. Measure the maximum burst average power for WCDMA.



3.5 Peak-to-Average Ratio

3.5.1 Description of the PAR Measurement

The peak-to-average ratio (PAR) of the transmission may not exceed 13 dB.

3.5.2 Test Procedures

1. The testing follows FCC KDB 971168 D01 v02r02 Section 5.7.1.
2. The EUT was connected to spectrum analyzer and system simulator via a power divider.
3. Set EUT to transmit at maximum output power.
4. When the duty cycle is less than 98%, then signal gating will be implemented on the spectrum analyzer by triggering from the system simulator.
5. Set the CCDF (Complementary Cumulative Distribution Function) option of the spectrum analyzer.
Record the maximum PAPR level associated with a probability of 0.1%.

3.6 99% Occupied Bandwidth and 26dB Bandwidth Measurement

3.6.1 Description of 99% Occupied Bandwidth and 26dB Bandwidth Measurement

The occupied bandwidth is the width of a frequency band such that, below the lower and above the upper frequency limits, the mean powers emitted are each equal to a specified percentage 0.5% of the total mean transmitted power.

The 26 dB emission bandwidth is defined as the frequency range between two points, one above and one below the carrier frequency, at which the spectral density of the emission is attenuated 26 dB below the maximum in-band spectral density of the modulated signal. Spectral density (power per unit bandwidth) is to be measured with a detector of resolution bandwidth equal to approximately 1.0% of the emission bandwidth.

3.6.2 Test Procedures

1. The testing follows FCC KDB 971168 v02r02 Section 4.2.
2. The EUT was connected to spectrum analyzer and system simulator via a power divider.
3. The spectrum analyzer center frequency is set to the nominal EUT channel center frequency. The span range for the spectrum analyzer shall be between two and five times the anticipated OBW.
4. The nominal resolution bandwidth (RBW) shall be in the range of 1 to 5 % of the anticipated OBW, and the VBW shall be at least 3 times the RBW.
5. Set the detection mode to peak, and the trace mode to max hold.
6. Determine the reference value: Set the EUT to transmit a modulated signal. Allow the trace to stabilize. Set the spectrum analyzer marker to the highest level of the displayed trace.
(this is the reference value)
7. Determine the “-26 dB down amplitude” as equal to (Reference Value – X).
8. Place two markers, one at the lowest and the other at the highest frequency of the envelope of the spectral display such that each marker is at or slightly below the “-X dB down amplitude” determined in step 6. If a marker is below this “-X dB down amplitude” value it shall be placed as close as possible to this value. The OBW is the positive frequency difference between the two markers.
9. Use the 99 % power bandwidth function of the spectrum analyzer and report the measured bandwidth.



3.7 Conducted Band Edge

3.7.1 Description of Conducted Band Edge Measurement

The power of any emission outside of the authorized operating frequency ranges must be lower than the transmitter power (P) by a factor of at least $43 + 10 \log (P)$ dB.

3.7.2 Test Procedures

1. The testing follows FCC KDB 971168 D01 v02r02 Section 6.0.
2. The EUT was connected to the spectrum analyzer and system simulator via a power divider.
3. The RF output of EUT was connected to the spectrum analyzer by an RF cable and attenuator. The path loss was compensated to the results for each measurement.
4. The band edges of low and high channels for the highest RF powers were measured.
5. The RF fundamental frequency should be excluded against the limit line in the operating frequency band.
6. The limit line is derived from $43 + 10\log(P)$ dB below the transmitter power P(Watts)
= $P(W) - [43 + 10\log(P)]$ (dB)
= $[30 + 10\log(P)]$ (dBm) - $[43 + 10\log(P)]$ (dB)
= -13dBm.



3.8 Conducted Spurious Emission

3.8.1 Description of Conducted Spurious Emission Measurement

The power of any emission outside of the authorized operating frequency ranges must be lower than the transmitter power (P) by a factor of at least $43 + 10 \log (P)$ dB.

It is measured by means of a calibrated spectrum analyzer and scanned from 30 MHz up to a frequency including its 10th harmonic.

3.8.2 Test Procedures

1. The testing follows FCC KDB 971168 D01 v02r02 Section 6.0.
2. The EUT was connected to the spectrum analyzer and system simulator via a power divider.
3. The RF output of EUT was connected to the spectrum analyzer by an RF cable and attenuator. The path loss was compensated to the results for each measurement.
4. The middle channel for the highest RF power within the transmitting frequency was measured.
5. The conducted spurious emission for the whole frequency range was taken.
6. The RF fundamental frequency should be excluded against the limit line in the operating frequency band.
7. The limit line is derived from $43 + 10\log(P)$ dB below the transmitter power P(Watts)
= $P(W) - [43 + 10\log(P)]$ (dB)
= $[30 + 10\log(P)]$ (dBm) - $[43 + 10\log(P)]$ (dB)
= -13dBm.



3.9 Frequency Stability

3.9.1 Description of Frequency Stability Measurement

The frequency stability shall be measured by variation of ambient temperature and variation of primary supply voltage to ensure that the fundamental emission stays within the authorized frequency block. The frequency stability of the transmitter shall be maintained within $\pm 0.00025\%$ ($\pm 2.5\text{ppm}$) of the center frequency.

3.9.2 Test Procedures for Temperature Variation

1. The testing follows FCC KDB 971168 D01 v02r02 Section 9.0.
2. The EUT was set up in the thermal chamber and connected with the system simulator.
3. With power OFF, the temperature was decreased to -30°C and the EUT was stabilized before testing. Power was applied and the maximum change in frequency was recorded within one minute.
4. With power OFF, the temperature was raised in 10°C steps up to 50°C . The EUT was stabilized at each step for at least half an hour. Power was applied and the maximum frequency change was recorded within one minute.

3.9.3 Test Procedures for Voltage Variation

1. The testing follows FCC KDB 971168 D01 v02r02 Section 9.0.
2. The EUT was placed in a temperature chamber at $25\pm 5^{\circ}\text{C}$ and connected with the system simulator.
3. The power supply voltage to the EUT was varied from 85% to 115% of the nominal value measured at the input to the EUT.
4. The variation in frequency was measured for the worst case.

4 Radiated Test Items

4.1 Measuring Instruments

See list of measuring instruments of this test report.

4.2 Test Setup

4.2.1 For radiated test from 30MHz to 1GHz

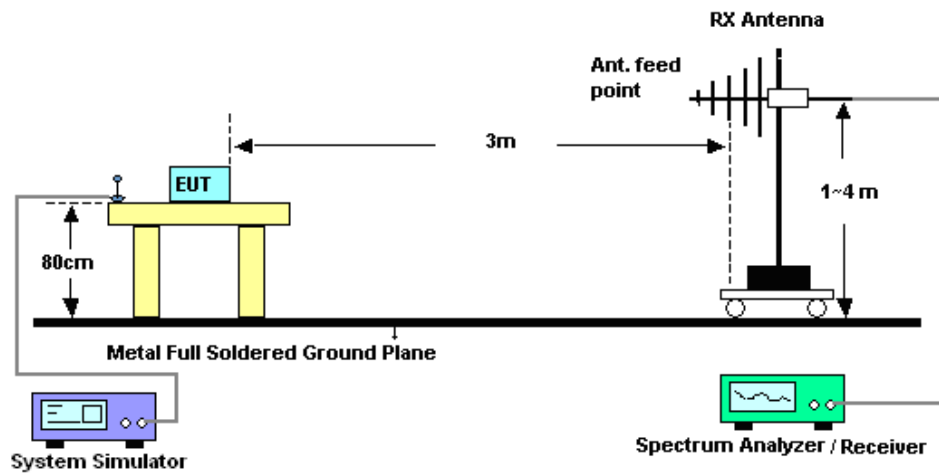

4.2.2 For radiated test above 1GHz

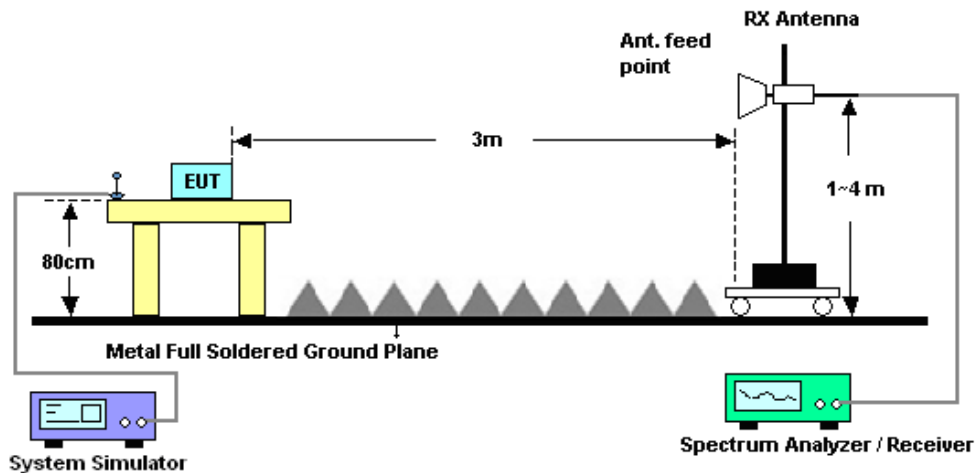

4.3 Test Result of Radiated Test

Please refer to Appendix B.



4.4 Field Strength of Spurious Radiation Measurement

4.4.1 Description of Field Strength of Spurious Radiated Measurement

The power of any emission outside of the authorized operating frequency ranges must be attenuated below the transmitter power (P) by a factor of at least $43 + 10 \log (P)$ dB. The spectrum is scanned from 30 MHz up to a frequency including its 10th harmonic.

4.4.2 Test Procedures

1. The testing follows FCC KDB 971168 D01 v02r02 Section 5.8 and ANSI / TIA-603-D-2010 Section 2.2.12.
2. The EUT was placed on a rotatable wooden table 0.8 meters above the ground.
3. The EUT was set 3 meters from the receiving antenna, which was mounted on the antenna tower.
4. The table was rotated 360 degrees to determine the position of the highest spurious emission.
5. The height of the receiving antenna is varied between one meter and four meters to search for the maximum spurious emission for both horizontal and vertical polarizations.
6. Make the measurement with the spectrum analyzer's RBW = 1MHz, VBW = 3MHz, taking record of maximum spurious emission.
7. A horn antenna was substituted in place of the EUT and was driven by a signal generator.
8. Tune the output power of signal generator to the same emission level with EUT maximum spurious emission.
9. Taking the record of output power at antenna port.
10. Repeat step 7 to step 8 for another polarization.
11. EIRP (dBm) = S.G. Power – Tx Cable Loss + Tx Antenna Gain
12. ERP (dBm) = EIRP - 2.15
13. The RF fundamental frequency should be excluded against the limit line in the operating frequency band.
14. The limit line is derived from $43 + 10\log(P)$ dB below the transmitter power P(Watts)
= $P(W) - [43 + 10\log(P)]$ (dB)
= $[30 + 10\log(P)]$ (dBm) - $[43 + 10\log(P)]$ (dB)
= -13dBm.



5 List of Measuring Equipment

Instrument	Manufacturer	Model No.	Serial No.	Characteristics	Calibration Date	Test Date	Due Date	Remark
Spectrum Analyzer	R&S	FSP30	101400	9kHz~30GHz	Jan. 28, 2015	Nov. 13, 2015~ Nov. 18, 2015	Jan. 27, 2016	Conducted (TH01-SZ)
Thermal Chamber	Ten Billion Hongzhangroup	LP-150U	H2014081803	-40~+150°C	Aug. 07, 2015	Nov. 13, 2015~ Nov. 18, 2015	Aug. 06, 2016	Conducted (TH01-SZ)
EMI Test Receiver&SA	Agilent Technologies	N9038A	MY52260185	20Hz~26.5GHz	May 26, 2015	Nov. 10, 2015	May 25, 2016	Radiation (03CH01-SZ)
Spectrum Analyzer	KEYSIGHT	N9010A	MY55150213	10Hz~44GHz;Max 30dBm	Jun. 07, 2015	Nov. 10, 2015	Jun. 06, 2016	Radiation (03CH01-SZ)
Bilog Antenna	TeseQ	CBL6112D	23188	30MHz-2GHz	Oct. 17, 2015	Nov. 10, 2015	Oct. 16, 2016	Radiation (03CH01-SZ)
Double Ridge Horn Antenna	SCHWARZBECK	BBHA 9120D	9120D-1285	1GHz~18GHz	Jan. 20, 2015	Nov. 10, 2015	Jan. 19, 2016	Radiation (03CH01-SZ)
SHF-EHF Horn	com-power	AH-840	101071	18Ghz-40GHz	Aug.19, 2015	Nov. 10, 2015	Aug. 18, 2016	Radiation (03CH01-SZ)
Amplifier	ADVANTEST	BB525C	E9007003	9kHz ~3000MHz / 30 dB	Jan. 28, 2015	Nov. 10, 2015	Jan. 27, 2016	Radiation (03CH01-SZ)
Amplifier	Agilent Technologies	83017A	MY39501302	500MHz~26.5GHz	Jan. 28, 2015	Nov. 10, 2015	Jan. 27, 2016	Radiation (03CH01-SZ)
Amplifier	Yiai	AV3860B	04030	2GHz~26.5GHz	May 05, 2015	Nov. 10, 2015	May 04, 2016	Radiation (03CH01-SZ)
AC Power Source	Chroma	61601	616010001985	N/A	NCR	Nov. 10, 2015	NCR	Radiation (03CH01-SZ)
Turn Table	EM	EM1000	N/A	0~360 degree	NCR	Nov. 10, 2015	NCR	Radiation (03CH01-SZ)
Antenna Mast	EM	EM1000	N/A	1 m~4 m	NCR	Nov. 10, 2015	NCR	Radiation (03CH01-SZ)



6 Uncertainty of Evaluation

Uncertainty of Radiated Emission Measurement (30 MHz ~ 1000 MHz)

Measuring Uncertainty for a Level of Confidence of 95% ($U = 2Uc(y)$)	4.8dB
---	-------



Appendix A. Test Results of Conducted Test

Conducted Output Power(Average power)

Conducted Power (*Unit: dBm)						
Band	WCDMA Band V			WCDMA Band II		
Channel	4132	4182	4233	9262	9400	9538
Frequency	826.4	836.4	846.6	1852.4	1880	1907.6
RMC 12.2K	22.77	22.71	22.63	23.05	23.12	23.08
HSDPA Subtest-1	22.50	22.51	22.42	22.35	22.49	22.37
HSDPA Subtest-2	22.32	22.25	22.19	22.14	22.24	22.15
HSDPA Subtest-3	22.06	22.01	21.95	21.88	22.01	21.89
HSDPA Subtest-4	21.80	21.72	21.73	21.61	21.73	21.62
HSUPA Subtest-1	21.16	20.88	20.87	20.90	20.96	20.85
HSUPA Subtest-2	20.29	20.22	20.21	20.12	20.24	20.10
HSUPA Subtest-3	21.21	20.87	21.08	21.14	21.01	20.96
HSUPA Subtest-4	20.28	20.37	20.49	20.39	20.48	20.11
HSUPA Subtest-5	22.20	22.20	22.20	22.10	22.20	22.10



Cellular Band (GT - LC = 2.1 dB)			
Modes	WCDMA Band V (RMC 12.2Kbps)		
Channel	4132 (Low)	4182 (Mid)	4233 (High)
Frequency (MHz)	826.4	836.4	846.6
Conducted Power (dBm)	22.77	22.71	22.63
Conducted Power (Watts)	0.1892	0.1866	0.1832
ERP(dBm)	22.72	22.66	22.58
ERP(Watts)	0.1871	0.1845	0.1811
PCS Band (GT - LC = 2.0 dB)			
Modes	WCDMA Band II (RMC 12.2Kbps)		
Channel	9262 (Low)	9400 (Mid)	9538 (High)
Frequency (MHz)	1852.4	1880	1907.6
Conducted Power (dBm)	23.05	23.12	23.08
Conducted Power (Watts)	0.2018	0.2051	0.2032
EIRP(dBm)	25.05	25.12	25.08
EIRP(Watts)	0.3199	0.3251	0.3221



A1. WCDMA

Peak-to-Average Ratio

Mode	WCDMA Band V	WCDMA Band II	Limit: 13dB
Mod.	RMC 12.2Kbps	RMC 12.2Kbps	Result
Lowest CH	3.19	3.16	PASS
Middle CH	3.13	3.10	
Highest CH	3.13	3.07	

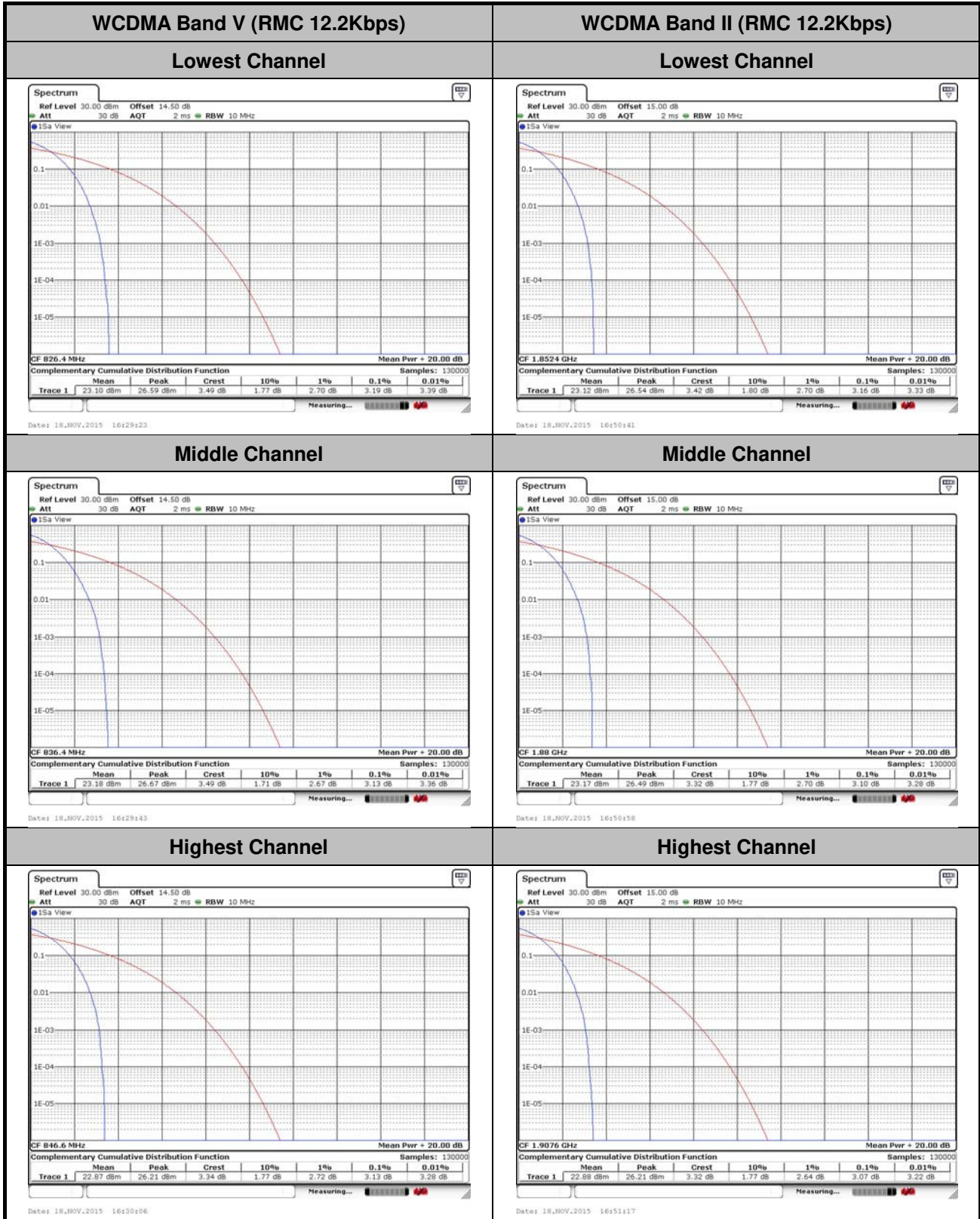



26dB Bandwidth

Mode	WCDMA Band V	WCDMA Band II
Mod.	RMC 12.2Kbps	RMC 12.2Kbps
Lowest CH	4.64	4.63
Middle CH	4.64	4.63
Highest CH	4.63	4.63



WCDMA Band V (RMC 12.2Kbps)

Lowest Channel

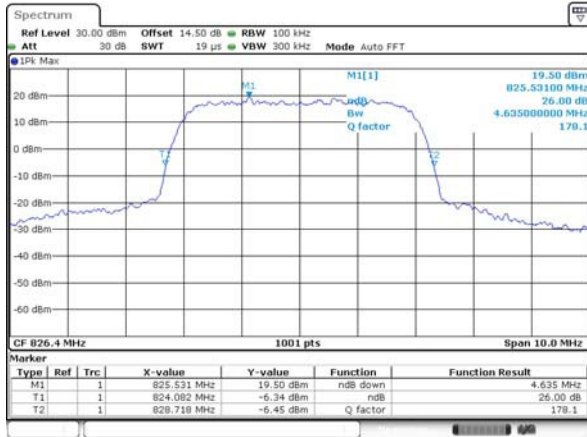

WCDMA Band II (RMC 12.2Kbps)

Lowest Channel

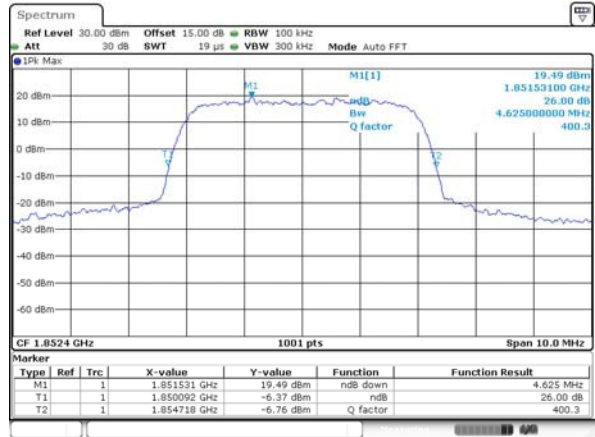

Middle Channel

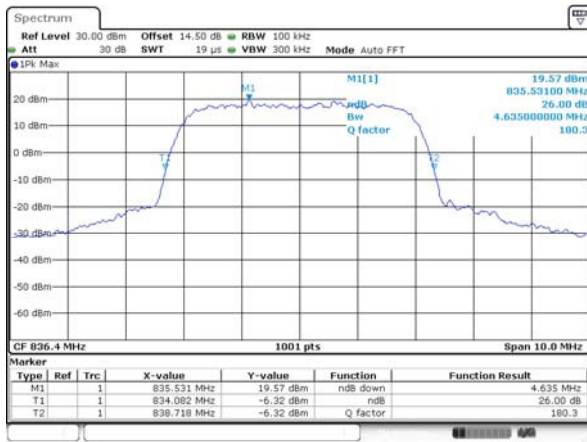

Middle Channel

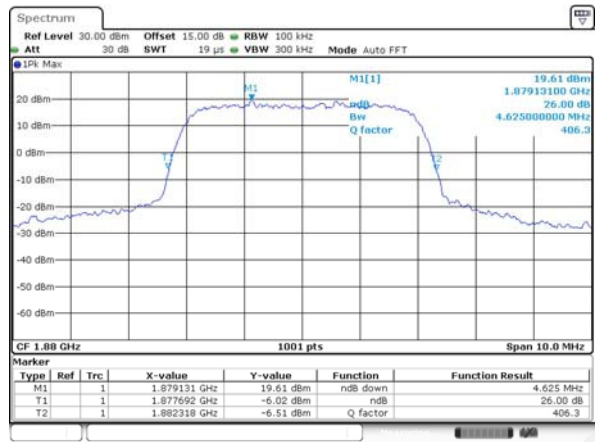

Highest Channel

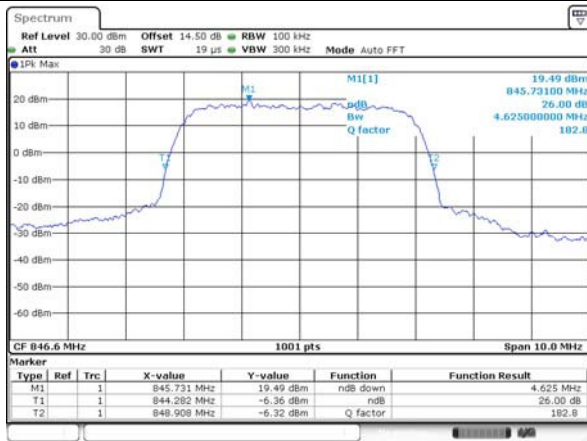

Highest Channel

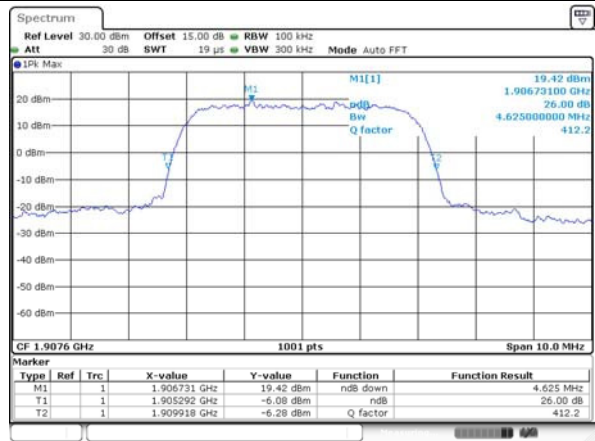



Occupied Bandwidth

Mode	WCDMA Band V	WCDMA Band II
Mod.	RMC 12.2Kbps	RMC 12.2Kbps
Lowest CH	4.07	4.07
Middle CH	4.07	4.07
Highest CH	4.06	4.06



WCDMA Band V (RMC 12.2Kbps)

Lowest Channel

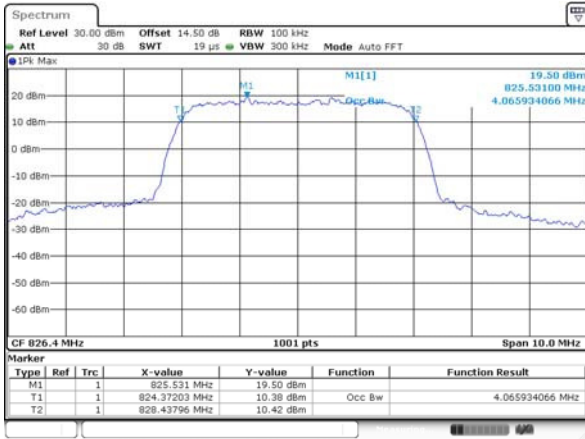

Date: 18_NOV_2015 16:14:09

WCDMA Band II (RMC 12.2Kbps)

Lowest Channel

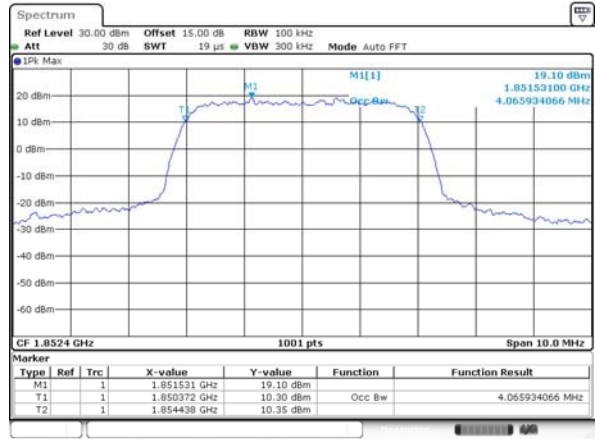

Date: 18_NOV_2015 16:13:12

Middle Channel

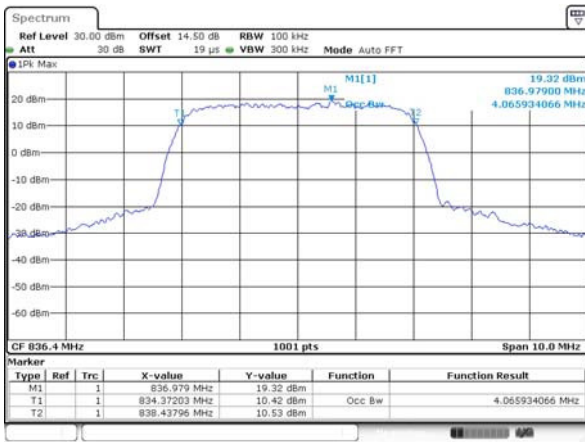

Date: 18_NOV_2015 16:14:48

Middle Channel

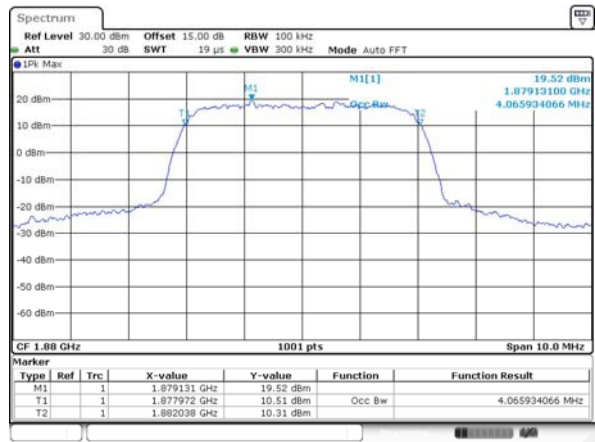

Date: 18_NOV_2015 16:13:49

Highest Channel

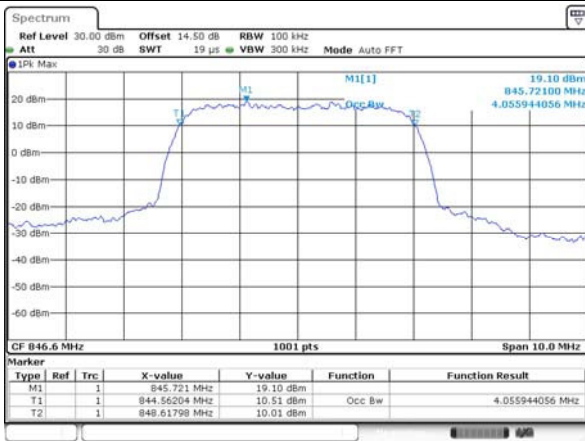

Date: 18_NOV_2015 16:15:30

Highest Channel

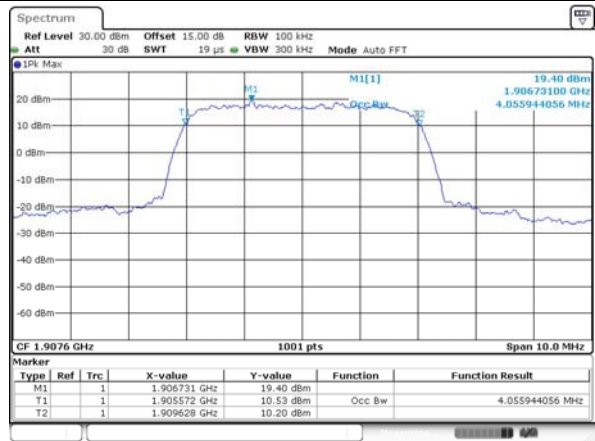

Date: 18_NOV_2015 16:13:27



Conducted Band Edge

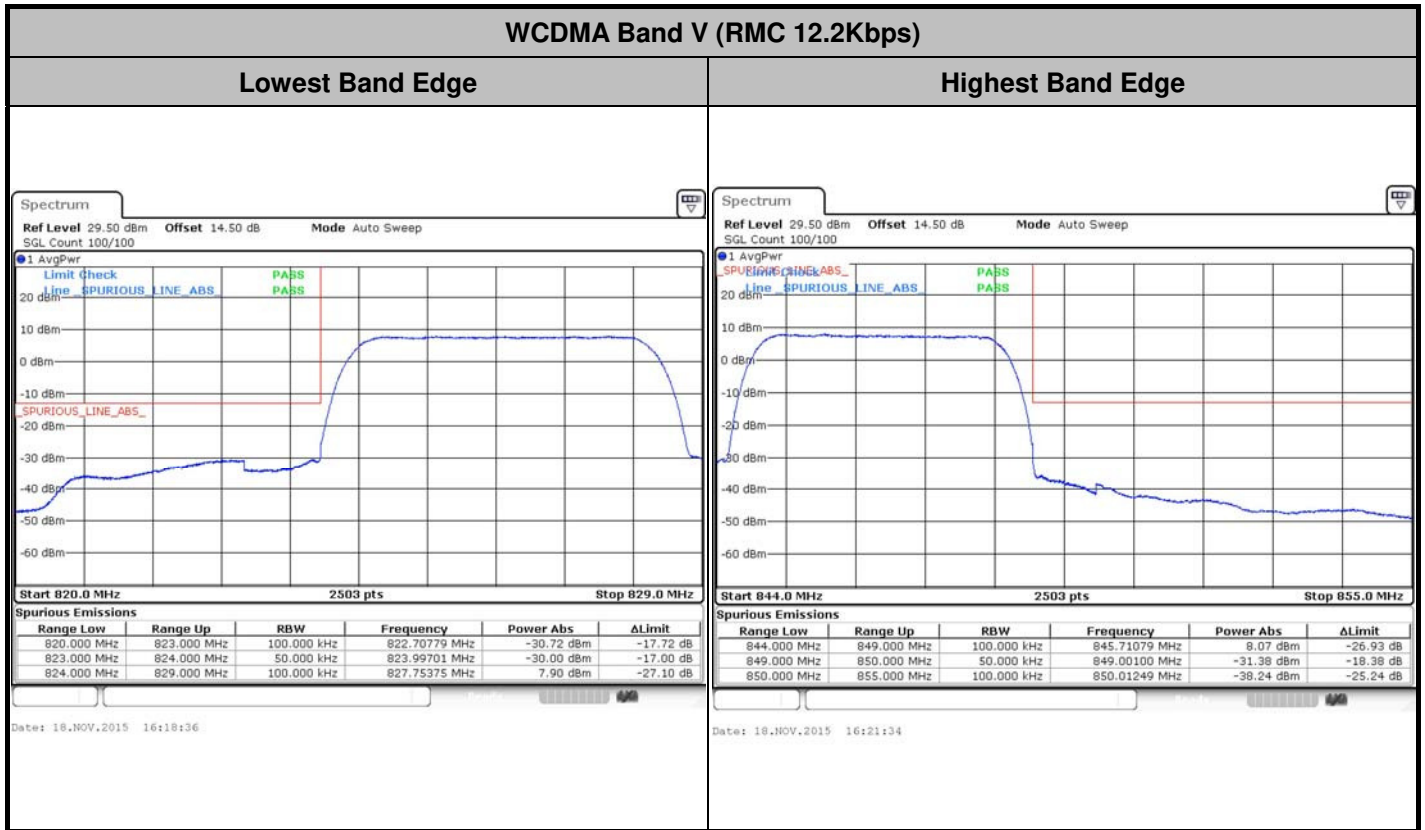

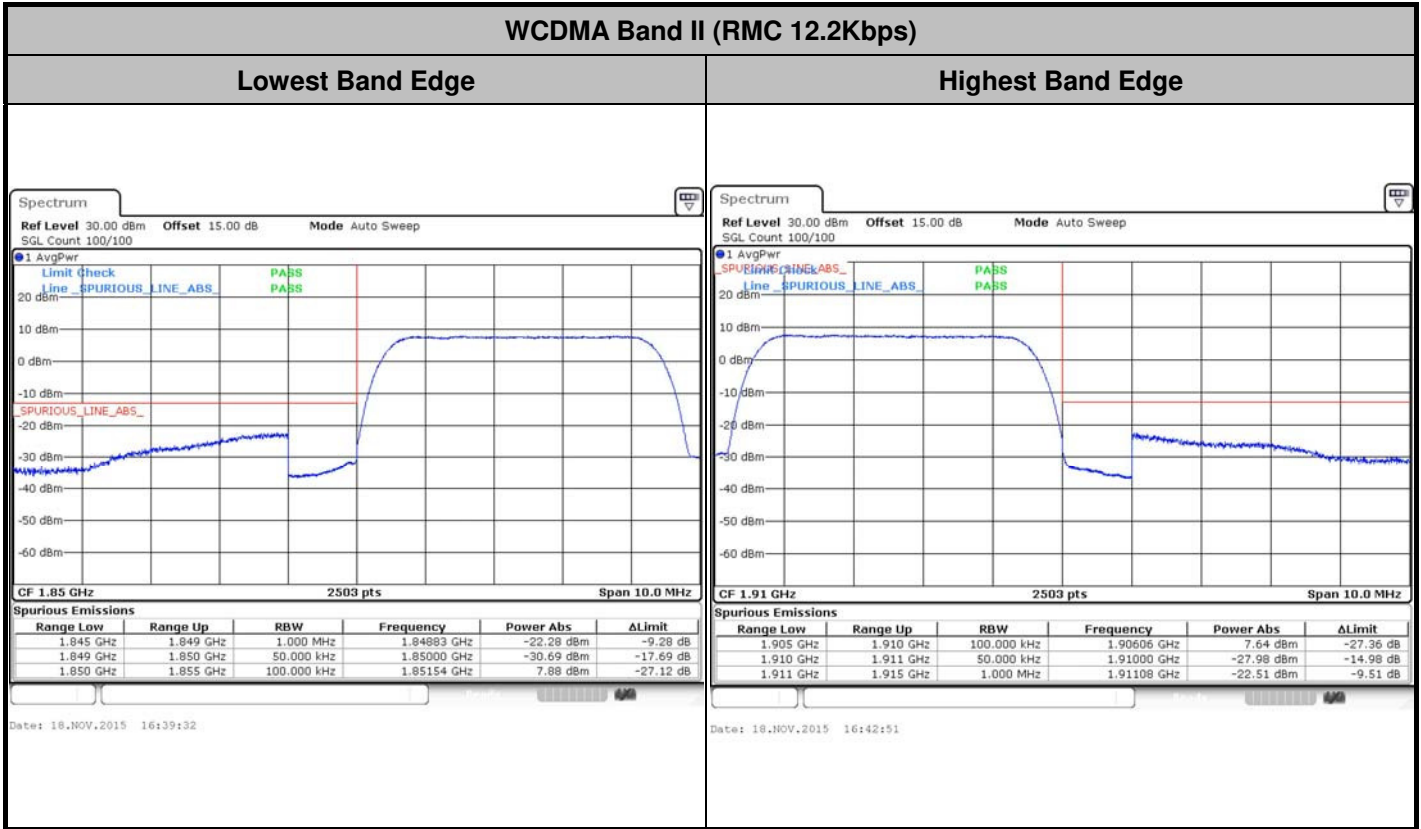



Conducted Spurious Emission

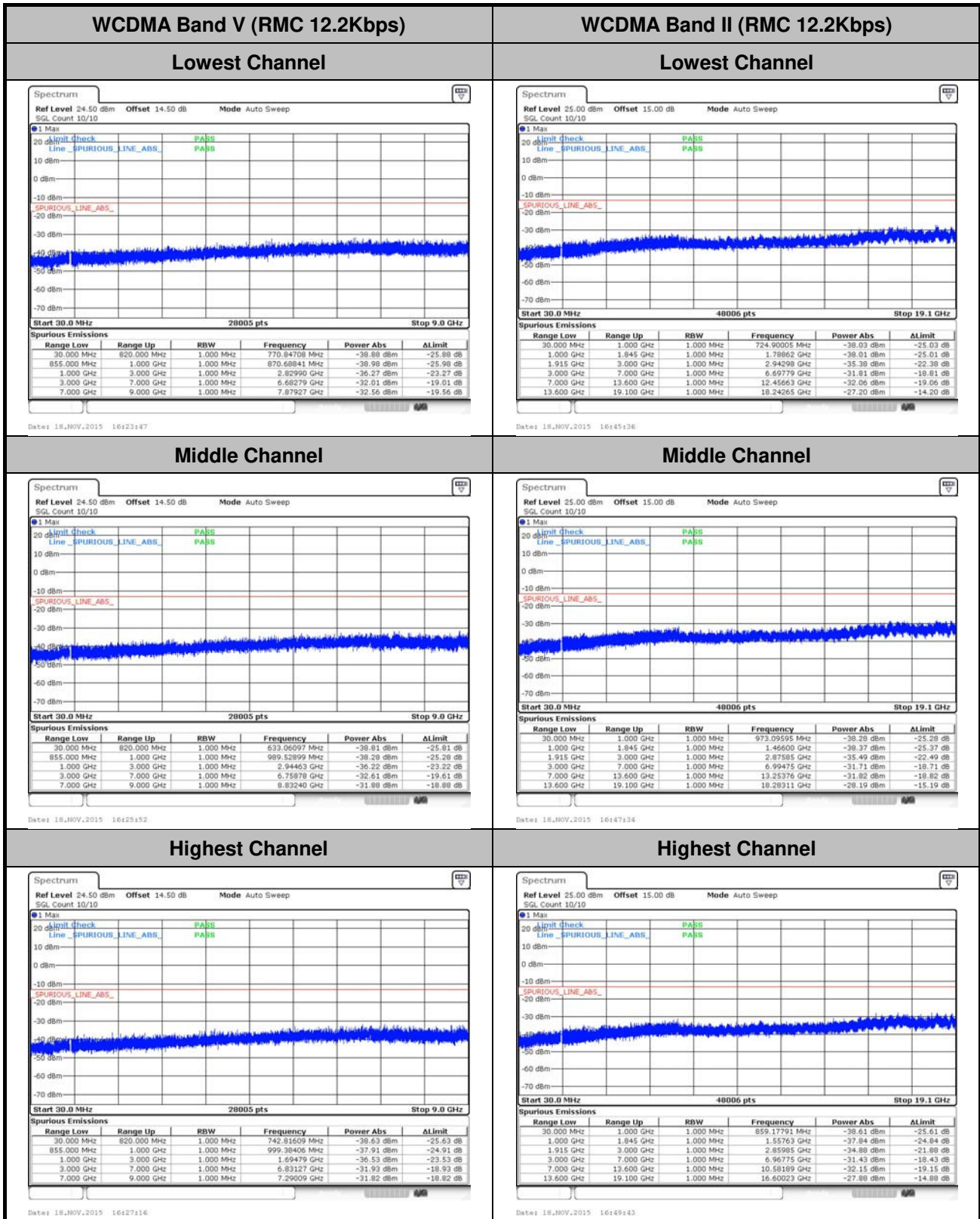



Frequency Stability

Test Conditions	Middle Channel	WCDMA Band V (RMC 12.2KbpsRMC 12.2Kbps)	Limit 2.5ppm
Temperature (°C)	Voltage (Volt)	Deviation (ppm)	Result
50	Normal Voltage	0.0311	PASS
40	Normal Voltage	0.0155	
30	Normal Voltage	0.0060	
20(Ref.)	Normal Voltage	0.0000	
10	Normal Voltage	0.0060	
0	Normal Voltage	0.0012	
-10	Normal Voltage	0.0096	
-20	Normal Voltage	0.0179	
-30	Normal Voltage	0.0347	
20	Maximum Voltage	0.0060	
20	Normal Voltage	0.0000	
20	Battery End Point	0.0132	

Note: Normal Voltage = 3.7V. ; Battery End Point (BEP) = 3.2 V. ; Maximum Voltage =4.5 V



Test Conditions	Middle Channel	WCDMA Band II (RMC 12.2Kbps)	Limit Note 2.
Temperature (°C)	Voltage (Volt)	Deviation (ppm)	Result
50	Normal Voltage	0.0165	PASS
40	Normal Voltage	0.0112	
30	Normal Voltage	0.0069	
20(Ref.)	Normal Voltage	0.0000	
10	Normal Voltage	0.0064	
0	Normal Voltage	0.0101	
-10	Normal Voltage	0.0037	
-20	Normal Voltage	0.0000	
-30	Normal Voltage	0.0064	
20	Maximum Voltage	0.0122	
20	Normal Voltage	0.0000	
20	Battery End Point	0.0064	

Note:

1. Normal Voltage = 3.7V. ; Battery End Point (BEP) = 3.2 V. ; Maximum Voltage =4.5 V
2. The frequency fundamental emissions stay within the authorized frequency block based on the frequency deviation measured is small.



Appendix B. Test Results of Radiated Test

Radiated Spurious Emission

WCDMA Band V(RMC 12.2Kbps)									
Channel	Frequency (MHz)	ERP (dBm)	Limit (dBm)	Over Limit (dB)	SPA Reading (dBm)	S.G. Power (dBm)	TX Cable loss (dB)	TX Antenna Gain (dBi)	Polarization (H/V)
Lowest	1652.8	-60.07	-13	-47.07	-62.62	-63.89	0.53	6.50	H
	2479.2	-58.16	-13	-45.16	-63.58	-61.03	0.68	5.70	H
	3305.6	-55.16	-13	-42.16	-65.18	-60.20	0.81	8.00	H
	1652.8	-59.57	-13	-46.57	-62.48	-63.39	0.53	6.50	V
	2479.2	-58.89	-13	-45.89	-63.21	-61.76	0.68	5.70	V
	3305.6	-57.03	-13	-44.03	-66.04	-62.07	0.81	8.00	V
Middle	1672	-60.47	-13	-47.47	-63.02	-64.29	0.53	6.50	H
	2510	-58.66	-13	-45.66	-64.08	-61.53	0.68	5.70	H
	3346	-55.75	-13	-42.75	-65.77	-60.79	0.81	8.00	H
	1672	-59.96	-13	-46.96	-62.87	-63.78	0.53	6.50	V
	2510	-59.80	-13	-46.80	-64.12	-62.67	0.68	5.70	V
	3346	-57.14	-13	-44.14	-66.15	-62.18	0.81	8.00	V
Highest	1693.2	-60.16	-13	-47.16	-62.71	-63.98	0.53	6.50	H
	2539.8	-56.40	-13	-43.40	-61.82	-59.27	0.68	5.70	H
	3386.4	-55.04	-13	-42.04	-65.06	-60.08	0.81	8.00	H
	1693.2	-59.02	-13	-46.02	-61.93	-62.84	0.53	6.50	V
	2539.8	-57.83	-13	-44.83	-62.15	-60.70	0.68	5.70	V
	3386.4	-56.62	-13	-43.62	-65.63	-61.66	0.81	8.00	V

Remark: Spurious emissions within 30-1000MHz were found more than 20dB below limit line.



WCDMA Band II(RMC 12.2Kbps)									
Channel	Frequency (MHz)	EIRP (dBm)	Limit (dBm)	Over Limit (dB)	SPA Reading (dBm)	S.G. Power (dBm)	TX Cable loss (dB)	TX Antenna Gain (dBi)	Polarization (H/V)
Lowest	3704.8	-53.02	-13	-40.02	-65.79	-60.21	0.81	8.00	H
	5557.2	-48.48	-13	-35.48	-67.23	-58.47	1.01	11.00	H
	7409.6	-48.09	-13	-35.09	-70.26	-60.33	1.46	13.70	H
	3704.8	-53.15	-13	-40.15	-66.22	-60.34	0.81	8	V
	5557.2	-49.47	-13	-36.47	-68.53	-59.46	1.01	11	V
	7409.6	-47.36	-13	-34.36	-69.85	-59.60	1.46	13.7	V
Middle	3760	-53.27	-13	-40.27	-66.04	-60.46	0.81	8.00	H
	5640	-49.93	-13	-36.93	-68.68	-59.92	1.01	11.00	H
	7520	-48.22	-13	-35.22	-70.39	-60.46	1.46	13.70	H
	3760	-53.09	-13	-40.09	-66.16	-60.28	0.81	8	V
	5640	-49.36	-13	-36.36	-68.42	-59.35	1.01	11	V
	7520	-47.26	-13	-34.26	-69.75	-59.50	1.46	13.7	V
Highest	3815.2	-52.61	-13	-39.61	-65.38	-59.80	0.81	8.00	H
	5722.8	-49.80	-13	-36.80	-68.55	-59.79	1.01	11.00	H
	7630.4	-46.47	-13	-33.47	-68.64	-58.71	1.46	13.70	H
	3815.2	-53.65	-13	-40.65	-66.72	-60.84	0.81	8	V
	5722.8	-49.95	-13	-36.95	-69.01	-59.94	1.01	11	V
	7630.4	-46.71	-13	-33.71	-69.2	-58.95	1.46	13.7	V

Remark: Spurious emissions within 30-1000MHz were found more than 20dB below limit line.



APPENDIX D. PRODUCT EQUALITY DECLARATION



Product Equity Declaration Letter

23-Dec-2015

To Whom It May Concern,

We, Sierra Wireless, certify that AirPrime HL8528 and AirPrime HL8529 shall be considered as identical.

From a HW point of view, the only difference is ONE non-connected resistor to identify them on production line.

There is no schematic diagram for a resistor (1 passive component) that has no other purpose than the one mentioned above.

Additionally the firmware is the same and depending on the above resistor, the FW will enable or not the 2G functionality.

Sincerely,

A handwritten signature in black ink, appearing to read "Denis Chabot", with a stylized flourish at the end.

Denis CHABOT
Sierra Wireless