

## FCC Test Report

### (PART 22)

**Report No.:** RF180425C07A

**FCC ID:** N7NHL78M

**Test Model:** HL7800-M

**Received Date:** Jun. 14, 2018

**Test Date:** Jun. 29, 2018 ~ Jul. 05, 2018

**Issued Date:** Jul. 18, 2018

**Applicant:** Sierra Wireless Inc.

**Address:** 13811 Wireless Way, Richmond, BC, Canada V6V3A4

**Issued By:** Bureau Veritas Consumer Products Services (H.K.) Ltd., Taoyuan Branch

**Lab Address:** No. 47-2, 14th Ling, Chia Pau Vil., Lin Kou Dist., New Taipei City, Taiwan  
( R.O.C )

**Test Location:** No. 19, Hwa Ya 2nd Rd, Wen Hwa Vil, Kwei Shan Dist., Taoyuan City  
33383, Taiwan (R.O.C)

**FCC Registration /  
Designation Number:** 788550 / TW0003



This report is for your exclusive use. Any copying or replication of this report to or for any other person or entity, or use of our name or trademark, is permitted only with our prior written permission. This report sets forth our findings solely with respect to the test samples identified herein. The results set forth in this report are not indicative or representative of the quality or characteristics of the lot from which a test sample was taken or any similar or identical product unless specifically and expressly noted. Our report includes all of the tests requested by you and the results thereof based upon the information that you provided to us. You have 60 days from date of issuance of this report to notify us of any material error or omission caused by our negligence, provided, however, that such notice shall be in writing and shall specifically address the issue you wish to raise. A failure to raise such issue within the prescribed time shall constitute your unqualified acceptance of the completeness of this report, the tests conducted and the correctness of the report contents. Unless specific mention, the uncertainty of measurement has been explicitly taken into account to declare the compliance or non-compliance to the specification. The report must not be used by the client to claim product certification, approval, or endorsement by TAF or any government agencies

## Table of Contents

<b>Release Control Record</b> .....	<b>4</b>
<b>1 Certificate of Conformity</b> .....	<b>5</b>
<b>2 Summary of Test Results</b> .....	<b>6</b>
2.1 Measurement Uncertainty .....	6
2.2 Test Site and Instruments .....	7
<b>3 General Information</b> .....	<b>8</b>
3.1 General Description of EUT .....	8
3.2 Configuration of System under Test .....	9
3.2.1 Description of Support Units .....	9
3.3 Test Mode Applicability and Tested Channel Detail .....	10
3.4 EUT Operating Conditions .....	12
3.5 General Description of Applied Standards .....	12
<b>4 Test Types and Results</b> .....	<b>13</b>
4.1 Output Power Measurement .....	13
4.1.1 Limits of Output Power Measurement .....	13
4.1.2 Test Procedures .....	13
4.1.3 Test Setup .....	14
4.1.4 Test Results .....	15
4.2 Modulation characteristics Measurement .....	32
4.2.1 Limits of Modulation characteristics .....	32
4.2.2 Test Procedure .....	32
4.2.3 Test Setup .....	32
4.3 Frequency Stability Measurement .....	35
4.3.1 Limits of Frequency Stability Measurement .....	35
4.3.2 Test Procedure .....	35
4.3.3 Test Setup .....	35
4.3.4 Test Results .....	36
4.4 Occupied Bandwidth Measurement .....	45
4.4.1 Test Procedure .....	45
4.4.2 Test Setup .....	45
4.4.3 Test Result .....	46
4.5 Band Edge Measurement .....	51
4.5.1 Limits of Band Edge Measurement .....	51
4.5.2 Test Setup .....	51
4.5.3 Test Procedures .....	51
4.5.4 Test Results .....	52
4.6 Peak to Average Ratio .....	61
4.6.1 Limits of Peak to Average Ratio Measurement .....	61
4.6.2 Test Setup .....	61
4.6.3 Test Procedures .....	61
4.6.4 Test Results .....	62
4.7 Conducted Spurious Emissions .....	67
4.7.1 Limits of Conducted Spurious Emissions Measurement .....	67
4.7.2 Test Setup .....	67
4.7.3 Test Procedure .....	67
4.7.4 Test Results .....	68
4.8 Radiated Emission Measurement .....	77
4.8.1 Limits of Radiated Emission Measurement .....	77
4.8.2 Test Procedure .....	77
4.8.3 Deviation from Test Standard .....	77
4.8.4 Test Setup .....	78
4.8.5 Test Results .....	79

<b>5 Pictures of Test Arrangements.....</b>	<b>115</b>
<b>Appendix – Information on the Testing Laboratories .....</b>	<b>116</b>



### Release Control Record

Issue No.	Description	Date Issued
RF180425C07A	Original Release	Jul. 18, 2018

## 1 Certificate of Conformity

**Product:** Embedded Module

**Brand:** AirPrime

**Test Model:** HL7800-M

**Sample Status:** ENGINEERING SAMPLE

**Applicant:** Sierra Wireless Inc.

**Test Date:** Jun. 29, 2018 ~ Jul. 05, 2018

**Standards:** FCC Part 22, Subpart H

The above equipment has been tested by **Bureau Veritas Consumer Products Services (H.K.) Ltd., Taoyuan Branch**, and found compliance with the requirement of the above standards. The test record, data evaluation & Equipment Under Test (EUT) configurations represented herein are true and accurate accounts of the measurements of the sample's RF characteristics under the conditions specified in this report.

**Prepared by :**                     Gina Liu                    , **Date:**                     Jul. 18, 2018                      
Gina Liu / Specialist

**Approved by :**                     Dylan Chiou                    , **Date:**                     Jul. 18, 2018                      
Dylan Chiou / Project Engineer

## 2 Summary of Test Results

Applied Standard: FCC Part 22 & Part 2			
FCC Clause	Test Item	Result	Remarks
2.1046 22.913 (a)	Effective Radiated Power	Pass	Meet the requirement of limit.
2.1047	Modulation characteristics	Pass	Meet the requirement
---	Peak to Average Ratio	Pass	Meet the requirement of limit.
2.1055 22.355	Frequency Stability	Pass	Meet the requirement of limit.
2.1049	Occupied Bandwidth	Pass	Meet the requirement of limit.
22.917	Band Edge Measurements	Pass	Meet the requirement of limit.
2.1051 22.917	Conducted Spurious Emissions	Pass	Meet the requirement of limit.
2.1053 22.917	Radiated Spurious Emissions	Pass	Meet the requirement of limit. Minimum passing margin is -31.73 dB at 2544.90 MHz.

### 2.1 Measurement Uncertainty

Where relevant, the following measurement uncertainty levels have been estimated for tests performed on the EUT as specified in CISPR 16-4-2:

Measurement	Frequency	Expanded Uncertainty (k=2) ( $\pm$ )
Conducted Emissions at mains ports	150 kHz ~ 30 MHz	2.44 dB
Radiated Emissions up to 1 GHz	30 MHz ~ 200 MHz	2.93 dB
	200 MHz ~ 1000 MHz	2.95 dB
Radiated Emissions above 1 GHz	1 GHz ~ 18 GHz	2.26 dB
	18 GHz ~ 40 GHz	1.94 dB

## 2.2 Test Site and Instruments

Description & Manufacturer	Model No.	Serial No.	Date of Calibration	Due Date of Calibration
Test Receiver Agilent	N9038A	MY51210203	Mar. 16, 2018	Mar. 15, 2019
Spectrum Analyzer Agilent	N9010A	MY52220314	Nov. 24, 2017	Nov. 23, 2018
Spectrum Analyzer ROHDE & SCHWARZ	FSU43	101261	Jan. 11, 2018	Jan. 10, 2019
Double Ridge Guide Horn Antenna EMCO	3115	5619	Nov. 30, 2017	Nov. 29, 2018
BILOG Antenna SCHWARZBECK	VULB 9168	9168-153	Dec. 06, 2017	Dec. 05, 2018
Radio Communication Analyzer Anritsu	MT8820C	6201300640	Aug. 16, 2017	Aug. 15, 2019
Preamplifier EMCI	EMC 012645	980115	Oct. 20, 2017	Oct. 19, 2018
Preamplifier EMCI	EMC 184045	980116	Oct. 20, 2017	Oct. 19, 2018
Preamplifier EMCI	EMC 330H	980112	Oct. 13, 2017	Oct. 12, 2018
Power Meter Anritsu	ML2495A	1012010	Aug. 15, 2017	Aug. 14, 2018
Power Sensor Anritsu	MA2411B	1315050	Aug. 15, 2017	Aug. 14, 2018
RF Coaxial Cable HUBER+SUHNNER	EMC104-SM-SM-8000 &3000	140811+170717	Oct. 20, 2017	Oct. 19, 2018
RF Coaxial Cable HUBER+SUHNNER	SUCOFLEX 104	EMC104-SM-SM-10 00(140807)	Oct. 20, 2017	Oct. 19, 2018
RF Coaxial Cable Worken	8D-FB	Cable-Ch10-01	Oct. 20, 2017	Oct. 19, 2018
Software BV ADT	E3 6.120103	NA	NA	NA
Antenna Tower MF	MFA-440H	NA	NA	NA
Turn Table MF	MFT-201SS	NA	NA	NA
Antenna Tower & Turn Table Controller MF	MF-7802	NA	NA	NA
DC Power Supply Topward	33010D	807748	Oct. 25, 2016	Oct. 24, 2018
STANDARD TEMPERATURE & HUMIDITY CHAMBER TERCHY	MHU-225AU	920842	Jun. 01, 2018	May 30, 2019

- Note: 1. The calibration interval of the above test instruments is 12 / 24 months and the calibrations are traceable to NML/ROC and NIST/USA.
2. The test was performed in HwaYa Chamber 10.
3. The horn antenna and preamplifier (model: EMC 184045) are used only for the measurement of emission frequency above 1 GHz if tested.
4. The IC Site Registration No. is IC7450F-10.

### 3 General Information

#### 3.1 General Description of EUT

<b>Product</b>	Embedded Module	
<b>Brand</b>	AirPrime	
<b>Test Model</b>	HL7800-M	
<b>Status of EUT</b>	ENGINEERING SAMPLE	
<b>Power Supply Rating</b>	5.0 Vdc (host equipment) 12.0 Vdc (adapter)	
<b>Modulation Type</b>	LTE	QPSK, 16QAM
<b>Frequency Range</b>	LTE 5 (Channel Bandwidth: 1.4 MHz)	824.7 ~ 848.3 MHz
	LTE 5 (Channel Bandwidth: 3 MHz)	825.5 ~ 847.5 MHz
	LTE 5 (Channel Bandwidth: 5 MHz)	826.5 ~ 846.5 MHz
	LTE 5 (Channel Bandwidth: 10 MHz)	829 ~ 844 MHz
	LTE 26 (Channel Bandwidth: 1.4 MHz)	824.7 ~ 848.3 MHz
	LTE 26 (Channel Bandwidth: 3 MHz)	825.5 ~ 847.5 MHz
	LTE 26 (Channel Bandwidth: 5 MHz)	826.5 ~ 846.5 MHz
	LTE 26 (Channel Bandwidth: 10 MHz)	829 ~ 844 MHz
	LTE 26 (Channel Bandwidth: 15 MHz)	831.5 ~ 841.5 MHz
<b>Max. ERP Power</b>	LTE 5 (Channel Bandwidth: 1.4 MHz)	314.77 mW
	LTE 5 (Channel Bandwidth: 3 MHz)	292.42 mW
	LTE 5 (Channel Bandwidth: 5 MHz)	274.16 mW
	LTE 5 (Channel Bandwidth: 10 MHz)	254.10 mW
	LTE 26 (Channel Bandwidth: 1.4 MHz)	263.63 mW
	LTE 26 (Channel Bandwidth: 3 MHz)	248.89 mW
	LTE 26 (Channel Bandwidth: 5 MHz)	233.88 mW
	LTE 26 (Channel Bandwidth: 10 MHz)	217.77 mW
	LTE 26 (Channel Bandwidth: 15 MHz)	204.64 mW
<b>Emission Designator</b>	LTE 5 (Channel Bandwidth: 1.4 MHz)	1M09G7D
	LTE 5 (Channel Bandwidth: 3 MHz)	1M09G7D
	LTE 5 (Channel Bandwidth: 5 MHz)	1M08G7D
	LTE 5 (Channel Bandwidth: 10 MHz)	1M09G7D
	LTE 26 (Channel Bandwidth: 1.4 MHz)	1M09G7D
	LTE 26 (Channel Bandwidth: 3 MHz)	1M09G7D
	LTE 26 (Channel Bandwidth: 5 MHz)	1M08G7D
	LTE 26 (Channel Bandwidth: 10 MHz)	1M09G7D
	LTE 26 (Channel Bandwidth: 15 MHz)	1M09G7D
<b>Antenna Type</b>	Dipole Antenna with 2 dBi gain	
<b>Accessory Device</b>	N/A	
<b>Data Cable Supplied</b>	N/A	

Note:

1. The above EUT information is declared by manufacturer and for more detailed features description, please refers to the manufacturer's specifications or user's manual.



### 3.2 Configuration of System under Test

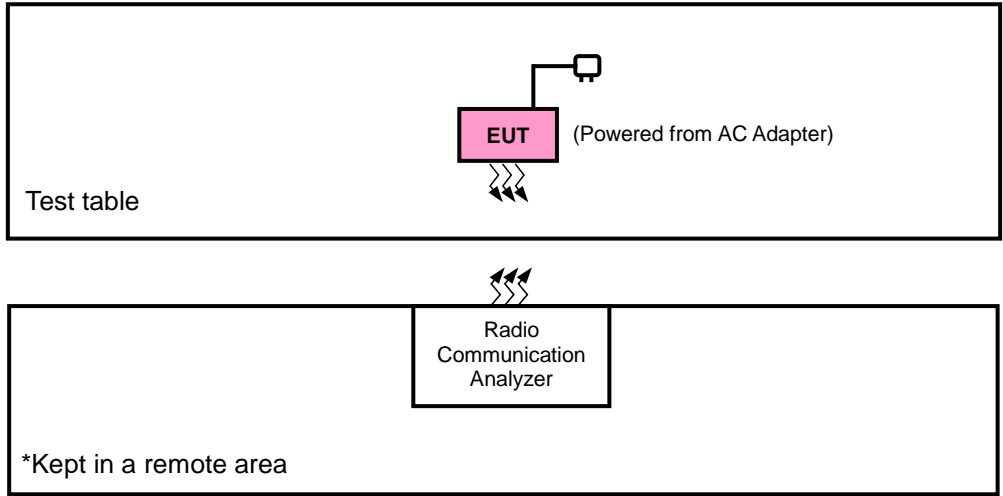

#### 3.2.1 Description of Support Units

The EUT has been tested as an independent unit together with other necessary accessories or support units. The following support units or accessories were used to form a representative test configuration during the tests.

No.	Product	Brand	Model No.	Serial No.	FCC ID
1.	Adapter	N/A	N/A	N/A	N/A
2.	Radio Communication Analyzer	Anritsu	MT8820C	6201300640	NA

No.	Signal Cable Description Of The Above Support Units
1.	N/A
2.	N/A

Note:

1. All power cords of the above support units are non-shielded (1.8m).
2. Item 1 was provided by client.
3. Item 2 acted as communication partners to transfer data.

### 3.3 Test Mode Applicability and Tested Channel Detail

Pre-Scan has been conducted to determine the worst-case mode from all possible combinations between available modulations, data rates, XYZ axis, and antenna ports.

The worst case was found when positioned as the table below. Following channel(s) was (were) selected for the final test as listed below:

Band	ERP	Radiated Emission
LTE Band 5	X-plane	X-axis
LTE Band 26	X-plane	X-axis

#### LTE Band 5

EUT Configure Mode	Test Item	Available Channel	Tested Channel	Channel Bandwidth	Modulation	Mode
-	ERP	20407 to 20643	20407, 20525, 20643	1.4 MHz	QPSK, 16QAM	1 RB / 2 RB Offset
		20415 to 20635	20415, 20525, 20635	3 MHz	QPSK, 16QAM	1 RB / 7 RB Offset
		20425 to 20625	20425, 20525, 20625	5 MHz	QPSK, 16QAM	1 RB / 12 RB Offset
		20450 to 20600	20450, 20525, 20600	10 MHz	QPSK, 16QAM	1 RB / 24 RB Offset
-	Modulation characteristics	20425 to 20625	20525	5 MHz	QPSK, 16QAM	5 RB / 0 RB Offset
-	Frequency Stability	20407 to 20643	20407, 20643	1.4 MHz	QPSK	1 RB / 2 RB Offset
		20415 to 20635	20415, 20635	3 MHz	QPSK	1 RB / 7 RB Offset
		20425 to 20625	20425, 20625	5 MHz	QPSK	1 RB / 12 RB Offset
		20450 to 20600	20450, 20600	10 MHz	QPSK	1 RB / 24 RB Offset
-	Occupied Bandwidth	20407 to 20643	20407, 20525, 20643	1.4 MHz	QPSK, 16QAM	6 RB / 0 RB Offset
		20415 to 20635	20415, 20525, 20635	3 MHz	QPSK, 16QAM	15 RB / 0 RB Offset
		20425 to 20625	20425, 20525, 20625	5 MHz	QPSK, 16QAM	25 RB / 0 RB Offset
		20450 to 20600	20450, 20525, 20600	10 MHz	QPSK, 16QAM	50 RB / 0 RB Offset
-	Band Edge	20407 to 20643	20407	1.4MHz	QPSK	1 RB / 0 RB Offset 6 RB / 0 RB Offset
			20643	1.4MHz	QPSK	1 RB / 5 RB Offset 6 RB / 0 RB Offset
		20415 to 20635	20415	3 MHz	QPSK	1 RB / 0 RB Offset 15 RB / 0 RB Offset
			20635	3 MHz	QPSK	1 RB / 14 RB Offset 15 RB / 0 RB Offset
		20425 to 20625	20425	5 MHz	QPSK	1 RB / 0 RB Offset 25 RB / 0 RB Offset
			20625	5 MHz	QPSK	1 RB / 24 RB Offset 25 RB / 0 RB Offset
		20450 to 20600	20450	10 MHz	QPSK	1 RB / 0 RB Offset 50 RB / 0 RB Offset
			20600	10 MHz	QPSK	1 RB / 49 RB Offset 50 RB / 0 RB Offset

-	Peak to Average Ratio	20407 to 20643	20407, 20525, 20643	1.4 MHz	QPSK, 16QAM	6 RB / 0 RB Offset
		20415 to 20635	20415, 20525, 20635	3 MHz	QPSK, 16QAM	15 RB / 0 RB Offset
		20425 to 20625	20425, 20525, 20625	5 MHz	QPSK, 16QAM	25 RB / 0 RB Offset
		20450 to 20600	20450, 20525, 20600	10 MHz	QPSK, 16QAM	50 RB / 0 RB Offset
-	Conducted Emission	20407 to 20643	20407, 20525, 20643	1.4 MHz	QPSK	1 RB / 2 RB Offset
		20415 to 20635	20415, 20525, 20635	3 MHz	QPSK	1 RB / 7 RB Offset
		20425 to 20625	20425, 20525, 20625	5 MHz	QPSK	1 RB / 12 RB Offset
		20450 to 20600	20450, 20525, 20600	10 MHz	QPSK	1 RB / 24 RB Offset
-	Radiated Emission	20407 to 20643	20407, 20525, 20643	1.4 MHz	QPSK	1 RB / 2 RB Offset
		20425 to 20625	20425, 20525, 20625	5 MHz	QPSK	1 RB / 12 RB Offset
		20450 to 20600	20450, 20525, 20600	10 MHz	QPSK	1 RB / 24 RB Offset

**Note:** This device was tested under all bandwidths, RB configurations and modulations. The worst case was found in QPSK modulation.

### LTE Band 26

EUT Configure Mode	Test Item	Available Channel	Tested Channel	Channel Bandwidth	Modulation	Mode
-	ERP	26797 to 27033	26797, 26915, 27033	1.4 MHz	QPSK, 16QAM	1 RB / 5 RB Offset
		26805 to 27025	26805, 26915, 27025	3 MHz	QPSK, 16QAM	1 RB / 14 RB Offset
		26815 to 27015	26815, 26915, 27015	5 MHz	QPSK, 16QAM	1 RB / 24 RB Offset
		26840 to 26990	26840, 26915, 26990	10 MHz	QPSK, 16QAM	1 RB / 49 RB Offset
		26865 to 26965	26865, 26915, 26965	15 MHz	QPSK, 16QAM	1 RB / 49 RB Offset
-	Modulation characteristics	26815 to 27015	26915	5 MHz	QPSK, 16QAM	5 RB / 0 RB Offset
-	Frequency Stability	26797 to 27033	26797, 27033	1.4 MHz	QPSK	1 RB / 5 RB Offset
		26805 to 27025	26805, 27025	3 MHz	QPSK	1 RB / 14 RB Offset
		26815 to 27015	26815, 27015	5 MHz	QPSK	1 RB / 24 RB Offset
		26840 to 26990	26840, 26990	10 MHz	QPSK	1 RB / 49 RB Offset
		26865 to 26965	26865, 26965	15 MHz	QPSK	1 RB / 49 RB Offset
-	Occupied Bandwidth	26797 to 27033	26797, 26915, 27033	1.4 MHz	QPSK, 16QAM	6 RB / 0 RB Offset
		26805 to 27025	26805, 26915, 27025	3 MHz	QPSK, 16QAM	15 RB / 0 RB Offset
		26815 to 27015	26815, 26915, 27015	5 MHz	QPSK, 16QAM	25 RB / 0 RB Offset
		26840 to 26990	26840, 26915, 26990	10 MHz	QPSK, 16QAM	50 RB / 0 RB Offset
		26865 to 26965	26865, 26915, 26965	15 MHz	QPSK, 16QAM	75 RB / 0 RB Offset
-	Band Edge	26797 to 27033	26797	1.4 MHz	QPSK	1 RB / 0 RB Offset 6 RB / 0 RB Offset
			27033	1.4 MHz	QPSK	1 RB / 5 RB Offset 6 RB / 0 RB Offset
		26805 to 27025	26805	3 MHz	QPSK	1 RB / 0 RB Offset 15 RB / 0 RB Offset
			27025	3 MHz	QPSK	1 RB / 14 RB Offset 15 RB / 0 RB Offset
		26815 to 27015	26815	5 MHz	QPSK	1 RB / 0 RB Offset 25 RB / 0 RB Offset
			27015	5 MHz	QPSK	1 RB / 24 RB Offset 25 RB / 0 RB Offset
		26840 to 26990	26840	10 MHz	QPSK	1 RB / 0 RB Offset 50 RB / 0 RB Offset
			26990	10 MHz	QPSK	1 RB / 49 RB Offset 50 RB / 0 RB Offset
		26865 to 26965	26865	15 MHz	QPSK	1 RB / 0 RB Offset 75 RB / 0 RB Offset

			26965	15 MHz	QPSK	1 RB / 74 RB Offset 75 RB / 0 RB Offset
-	Peak to Average Ratio	26797 to 27033	26797, 26915, 27033	1.4 MHz	QPSK, 16QAM	1 RB / 0 RB Offset
		26805 to 27025	26805, 26915, 27025	3 MHz	QPSK, 16QAM	15 RB / 0 RB Offset
		26815 to 27015	26815, 26915, 27015	5 MHz	QPSK, 16QAM	25 RB / 0 RB Offset
		26840 to 26990	26840, 26915, 26990	10 MHz	QPSK, 16QAM	50 RB / 0 RB Offset
		26865 to 26965	26865, 26915, 26965	15 MHz	QPSK, 16QAM	75 RB / 0 RB Offset
-	Conducted Emission	26797 to 27033	26797, 26915, 27033	1.4 MHz	QPSK	1 RB / 0 RB Offset
		26805 to 27025	26805, 26915, 27025	3 MHz	QPSK	15 RB / 0 RB Offset
		26815 to 27015	26815, 26915, 27015	5 MHz	QPSK	25 RB / 0 RB Offset
		26840 to 26990	26840, 26915, 26990	10 MHz	QPSK	1 RB / 0 RB Offset
		26865 to 26965	26865, 26915, 26965	15 MHz	QPSK	25 RB / 0 RB Offset
-	Radiated Emission	26797 to 27033	26797, 26915, 27033	1.4 MHz	QPSK	1 RB / 0 RB Offset
		26815 to 27015	26815, 26915, 27015	5 MHz	QPSK	25 RB / 0 RB Offset
		26865 to 26965	26865, 26915, 26965	15 MHz	QPSK	25 RB / 0 RB Offset

**Note:** This device was tested under all bandwidths, RB configurations and modulations. The worst case was found in QPSK modulation.

#### **Test Condition:**

Test Item	Environmental Conditions	Input Power	Tested By
ERP	25 deg. C, 65 % RH	12 Vdc	Jisyong Wang
Modulation characteristics	25 deg. C, 65 % RH	12 Vdc	Getaz Yang
Frequency Stability	25 deg. C, 65 % RH	12 Vdc	Getaz Yang
Occupied Bandwidth	25 deg. C, 65 % RH	12 Vdc	Getaz Yang
Band Edge	25 deg. C, 65 % RH	12 Vdc	Getaz Yang
Peak to Average Ratio	25 deg. C, 65 % RH	12 Vdc	Getaz Yang
Conducted Emission	25 deg. C, 65 % RH	12 Vdc	Getaz Yang
Radiated Emission	25 deg. C, 65 % RH	120 Vac, 60 Hz	Jisyong Wang

### **3.4 EUT Operating Conditions**

The EUT makes a call to the communication simulator. The communication simulator station system controlled a EUT to export maximum output power under transmission mode and specific channel frequency.

### **3.5 General Description of Applied Standards**

The EUT is a RF Product. According to the specifications of the manufacturer, it must comply with the requirements of the following standards:

**FCC 47 CFR Part 2**

**FCC 47 CFR Part 22**

**KDB 971168 D01 Power Meas License Digital Systems v03r01**

**ANSI/TIA/EIA-603-E 2016**

**ANSI 63.26-2015**

**Note:** All test items have been performed and recorded as per the above standards.

## 4 Test Types and Results

### 4.1 Output Power Measurement

#### 4.1.1 Limits of Output Power Measurement

Mobile / Portable station are limited to 7 watts e.r.p.

#### 4.1.2 Test Procedures

##### **EIRP / ERP Measurement:**

- a. All measurements were done at low, middle and high operational frequency range. RBW and VBW is 1 MHz for GSM, GPRS & EDGE, and 5 MHz for WCDMA and CDMA, and 10 MHz for LTE mode.
- b. Substitution method is used for E.I.R.P measurement. In the semi-anechoic chamber, EUT placed on the 0.8 m (below or equal 1 GHz) and/or 1.5 m (above 1 GHz) height of Turn Table, rotated the table around 360 degrees to search the maximum radiation power and receiver antenna shall be rotated vertical and horizontal polarization and moved height from 1 m to 4 m to find the maximum polar radiated power. The "Read Value" is the spectrum reading the maximum power value.
- c. The substitution horn antenna is substituted for EUT at the same position and signals generator export the CW signal to the substitution antenna via a tx cable. Rotated the Turn Table and moved receiving antenna to find the maximum radiation power. Adjust output power level of S.G to get a Value of spectrum reading equal to "Read Value" of step b. Record the power level of S.G.
- d.  $EIRP = \text{Output power level of S.G} - \text{TX cable loss} + \text{Antenna gain of substitution horn}$ . E.R.P power can be calculated form E.I.R.P power by subtracting the gain of dipole,  $E.R.P \text{ power} = E.I.R.P \text{ power} - 2.15 \text{ dB}$ .

##### **Conducted Power Measurement:**

The EUT was set up for the maximum power with GSM, GPRS, EDGE, WCDMA, CDMA, and LTE link data modulation and link up with simulator. Set the EUT to transmit under low, middle and high channel and record the power level shown on simulator.

4.1.3 Test Setup

**EIRP / ERP Measurement:**

**<Radiated Emission below or equal 1 GHz>**

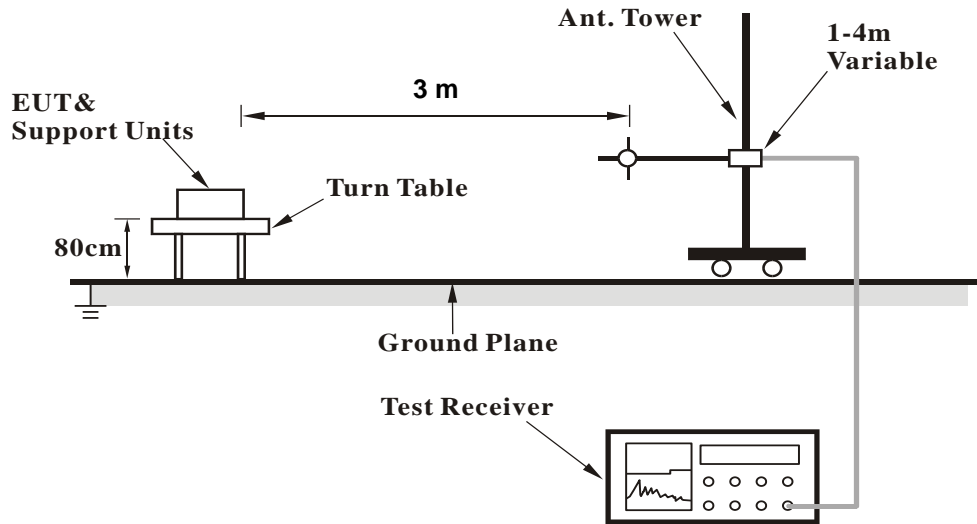

**<Radiated Emission above 1 GHz>**

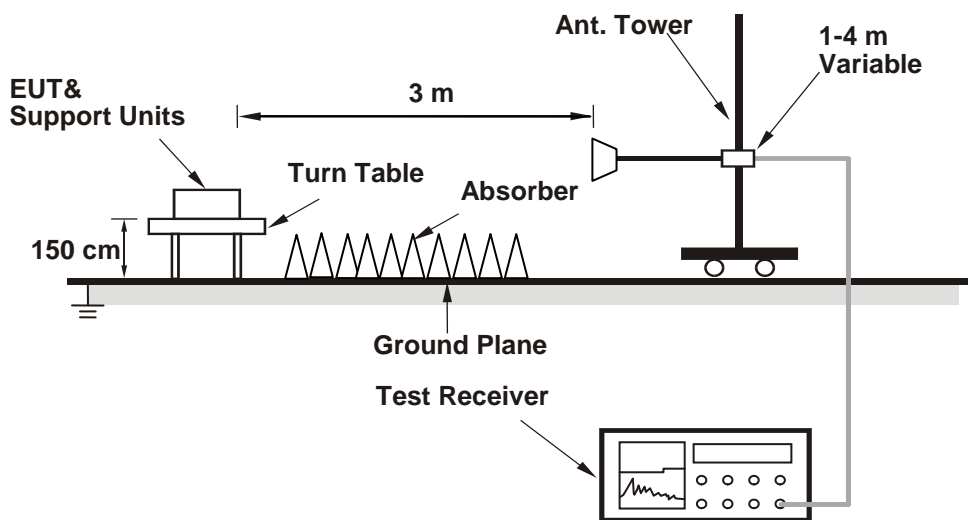

For the actual test configuration, please refer to the attached file (Test Setup Photo).

**Conducted Power Measurement:**

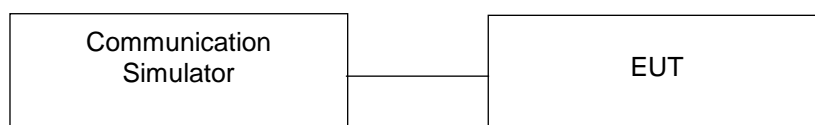

4.1.4 Test Results

**Conducted Output Power (dBm)**

**LTE Band 5**

BW(MHz): 1.4

Test Frequency ID	N <sub>UL</sub>	Frequency of Uplink [MHz]	N <sub>DL</sub>	Frequency of Downlink [MHz]	Test Configuration Initial of Power				EUT	
					Modulation	RB Size	RB Offset	Narrowband Index	Cell power (dBm/15kHz)	power (dBm)
Low Range	20407	824.7	2407	869.7	QPSK	1	0	0	-85	23.98
					QPSK	1	5	0	-85	23.43
					QPSK	3	3	0	-85	21.81
					QPSK	6	0	0	-85	21.01
					16QAM	1	0	0	-85	21.38
					16QAM	1	5	0	-85	21.53
					16QAM	3	0	0	-85	20.78
					16QAM	6	0	0	-85	20.69
Mid Range	20525	836.5	2525	881.5	QPSK	1	0	0	-85	23.89
					QPSK	1	5	0	-85	23.44
					QPSK	3	3	0	-85	21.77
					QPSK	6	0	0	-85	20.97
					16QAM	1	0	0	-85	21.35
					16QAM	1	5	0	-85	21.42
					16QAM	3	0	0	-85	20.74
					16QAM	5	0	0	-85	20.4
High Range	20643	848.3	2643	893.3	QPSK	1	0	0	-85	23.88
					QPSK	1	5	0	-85	23.43
					QPSK	3	3	0	-85	21.84
					QPSK	6	0	0	-85	20.99
					16QAM	1	0	0	-85	21.37
					16QAM	1	5	0	-85	21.47
					16QAM	3	0	0	-85	20.69
					16QAM	6	0	0	-85	20.44

BW(MHz):		3				Test Configuration Initial of Power				EUT	
Test Frequency ID	N <sub>UL</sub>	Frequency of Uplink [MHz]	N <sub>DL</sub>	Frequency of Downlink [MHz]	Modulation	RB Size	RB Offset	Narrowband Index	Cell power (dBm/15kHz)	power (dBm)	
Low Range	20415	825.5	2415	870.5	QPSK	1	0	0	-85	22.87	
					QPSK	1	5	0	-85	22.76	
					QPSK	1	0	1	-85	22.79	
					QPSK	1	5	1	-85	22.69	
					QPSK	3	3	0	-85	21.65	
					QPSK	3	3	1	-85	21.57	
					QPSK	6	0	0	-85	20.66	
					QPSK	6	0	1	-85	20.58	
					16QAM	1	0	0	-85	22.75	
					16QAM	1	5	0	-85	22.65	
					16QAM	1	0	1	-85	22.67	
					16QAM	1	5	1	-85	22.58	
					16QAM	3	0	0	-85	21.59	
					16QAM	3	3	1	-85	21.62	
					16QAM	5	0	0	-85	21.57	
					16QAM	5	0	1	-85	21.49	
Mid Range	20525	836.5	2525	881.5	QPSK	1	0	0	-85	22.76	
					QPSK	1	5	0	-85	22.59	
					QPSK	1	0	1	-85	22.87	
					QPSK	1	5	1	-85	22.74	
					QPSK	3	3	0	-85	21.62	
					QPSK	3	3	1	-85	21.65	
					QPSK	6	0	0	-85	20.71	
					QPSK	6	0	1	-85	20.78	
					16QAM	1	0	0	-85	22.57	
					16QAM	1	5	0	-85	22.73	
					16QAM	1	0	1	-85	22.93	
					16QAM	1	5	1	-85	22.67	
					16QAM	3	0	0	-85	21.68	
					16QAM	3	3	1	-85	21.71	
					16QAM	5	0	0	-85	21.66	
					16QAM	5	0	1	-85	21.61	
High Range	20635	847.5	2635	892.5	QPSK	1	0	0	-85	22.81	
					QPSK	1	5	0	-85	22.73	
					QPSK	1	0	1	-85	22.77	
					QPSK	1	5	1	-85	22.69	
					QPSK	3	3	0	-85	21.62	
					QPSK	3	3	1	-85	21.56	
					QPSK	6	0	0	-85	20.68	
					QPSK	6	0	1	-85	20.55	
					16QAM	1	0	0	-85	22.64	
					16QAM	1	5	0	-85	22.54	
					16QAM	1	0	1	-85	22.49	
					16QAM	1	5	1	-85	22.63	
					16QAM	3	0	0	-85	21.67	
					16QAM	3	3	1	-85	21.73	
					16QAM	5	0	0	-85	21.7	
					16QAM	5	0	1	-85	21.68	



BW(MHz):										
5										
Test Frequency ID	N <sub>UL</sub>	Frequency of Uplink [MHz]	N <sub>DL</sub>	Frequency of Downlink [MHz]	Test Configuration Initial of Power				EUT	
					Modulation	RB Size	RB Offset	Narrowband Index	Cell power (dBm/15kHz)	power (dBm)
Low Range	20425	826.5	2425	871.5	QPSK	1	0	0	-85	22.82
					QPSK	1	5	0	-85	22.81
					QPSK	1	0	1	-85	22.79
					QPSK	1	5	1	-85	22.77
					QPSK	1	0	3	-85	22.78
					QPSK	1	5	3	-85	22.71
					QPSK	3	0	0	-85	21.98
					QPSK	3	3	3	-85	21.77
					QPSK	6	0	0	-85	21.99
					QPSK	6	0	1	-85	21.92
					QPSK	6	0	3	-85	21.97
					16QAM	1	0	0	-85	22.62
					16QAM	1	5	0	-85	22.69
					16QAM	1	0	1	-85	22.67
					16QAM	1	5	1	-85	22.68
					16QAM	1	0	3	-85	22.64
					16QAM	1	5	3	-85	22.66
					16QAM	3	0	0	-85	21.77
					16QAM	3	3	3	-85	21.79
					16QAM	5	0	0	-85	21.81
16QAM	5	0	1	-85	21.83					
16QAM	5	0	3	-85	21.82					
Mid Range	20525	836.5	2525	881.5	QPSK	1	0	0	-85	22.69
					QPSK	1	5	0	-85	22.64
					QPSK	1	0	1	-85	22.66
					QPSK	1	5	1	-85	22.45
					QPSK	1	0	3	-85	22.67
					QPSK	1	5	3	-85	22.56
					QPSK	3	0	0	-85	21.81
					QPSK	3	3	3	-85	21.64
					QPSK	6	0	0	-85	21.84
					QPSK	6	0	1	-85	21.87
					QPSK	6	0	3	-85	21.79
					16QAM	1	0	0	-85	22.49
					16QAM	1	5	0	-85	22.47
					16QAM	1	0	1	-85	22.57
					16QAM	1	5	1	-85	22.53
					16QAM	1	0	3	-85	22.55
					16QAM	1	5	3	-85	22.46
					16QAM	3	0	0	-85	21.69
					16QAM	3	3	3	-85	21.67
					16QAM	5	0	0	-85	21.73
16QAM	5	0	1	-85	21.66					
16QAM	5	0	3	-85	21.68					

Test Frequency ID	N <sub>UL</sub>	Frequency of Uplink [MHz]	N <sub>DL</sub>	Frequency of Downlink [MHz]	Test Configuration Initial of Power			EUT		
					Modulation	RB Size	RB Offset	Narrowband Index	Cell power (dBm/15kHz)	power (dBm)
High Range	20625	846.5	2625	891.5	QPSK	1	0	0	-85	22.69
					QPSK	1	5	0	-85	22.63
					QPSK	1	0	1	-85	22.91
					QPSK	1	5	1	-85	22.78
					QPSK	1	0	3	-85	22.59
					QPSK	1	5	3	-85	22.51
					QPSK	3	0	0	-85	21.71
					QPSK	3	3	3	-85	21.59
					QPSK	6	0	0	-85	21.71
					QPSK	6	0	1	-85	22.1
					QPSK	6	0	3	-85	21.77
					16QAM	1	0	0	-85	22.42
					16QAM	1	5	0	-85	22.31
					16QAM	1	0	1	-85	22.82
					16QAM	1	5	1	-85	22.75
					16QAM	1	0	3	-85	22.42
					16QAM	1	5	3	-85	22.35
					16QAM	3	0	0	-85	21.47
16QAM	3	3	3	-85	21.58					
16QAM	5	0	0	-85	21.61					
16QAM	5	0	1	-85	21.97					
16QAM	5	0	3	-85	21.69					

BW(MHz): 10

Test Frequency ID	N <sub>UL</sub>	Frequency of Uplink [MHz]	N <sub>DL</sub>	Frequency of Downlink [MHz]	Test Configuration Initial of Power			EUT		
					Modulation	RB Size	RB Offset	Narrowband Index	Cell power (dBm/15kHz)	power (dBm)
Low Range	20450	829	2450	874	QPSK	1	0	0	-85	22.75
					QPSK	1	5	0	-85	22.67
					QPSK	1	0	3	-85	22.63
					QPSK	1	5	3	-85	22.61
					QPSK	1	0	7	-85	22.61
					QPSK	1	5	7	-85	22.57
					QPSK	4	0	0	-85	22.71
					QPSK	4	2	7	-85	22.91
					QPSK	6	0	0	-85	21.74
					QPSK	6	0	7	-85	21.69
					16QAM	1	0	0	-85	22.76
					16QAM	1	5	0	-85	22.71
					16QAM	1	0	3	-85	22.71
					16QAM	1	5	3	-85	22.65
					16QAM	1	0	7	-85	22.61
					16QAM	1	5	7	-85	22.56
					16QAM	4	2	0	-85	22.75
					16QAM	4	2	7	-85	22.71
16QAM	5	0	0	-85	21.76					
16QAM	5	0	7	-85	21.77					

Test Frequency ID	N <sub>UL</sub>	Frequency of Uplink [MHz]	N <sub>DL</sub>	Frequency of Downlink [MHz]	Test Configuration Initial of Power				EUT	
					Modulation	RB Size	RB Offset	Narrowband Index	Cell power (dBm/15kHz)	power (dBm)
Mid Range	20525	836.5	2525	881.5	QPSK	1	0	0	-85	22.72
					QPSK	1	5	0	-85	22.66
					QPSK	1	0	3	-85	22.62
					QPSK	1	5	3	-85	22.68
					QPSK	1	0	7	-85	22.51
					QPSK	1	5	7	-85	22.46
					QPSK	4	0	0	-85	22.71
					QPSK	4	2	7	-85	22.71
					QPSK	6	0	0	-85	21.88
					QPSK	6	0	7	-85	21.64
					16QAM	1	0	0	-85	22.72
					16QAM	1	5	0	-85	22.67
					16QAM	1	0	3	-85	22.77
					16QAM	1	5	3	-85	22.69
					16QAM	1	0	7	-85	22.57
					16QAM	1	5	7	-85	22.49
					16QAM	4	2	0	-85	22.85
					16QAM	4	2	7	-85	22.74
16QAM	5	0	0	-85	21.79					
16QAM	5	0	7	-85	21.678					
High Range	20600	844	2600	889	QPSK	1	0	0	-85	22.57
					QPSK	1	5	0	-85	22.58
					QPSK	1	5	7	-85	22.87
					QPSK	1	0	3	-85	22.87
					QPSK	1	5	3	-85	22.81
					QPSK	1	0	7	-85	22.94
					QPSK	4	0	0	-85	22.55
					QPSK	4	2	7	-85	22.89
					QPSK	6	0	0	-85	21.53
					QPSK	6	0	7	-85	21.99
					16QAM	1	0	0	-85	22.67
					16QAM	1	5	0	-85	22.55
					16QAM	1	0	3	-85	22.79
					16QAM	1	5	3	-85	22.59
					16QAM	1	0	7	-85	22.96
					16QAM	1	5	7	-85	22.82
					16QAM	4	2	0	-85	22.61
					16QAM	4	2	7	-85	22.73
16QAM	5	0	0	-85	21.67					
16QAM	5	0	7	-85	21.96					

**LTE Band 26**

BW(MHz):		1.4								
Test Frequency ID	N <sub>UL</sub>	Frequency of Uplink [MHz]	N <sub>DL</sub>	Frequency of Downlink [MHz]	Test Configuration Initial of Power				EUT	
					Modulation	RB Size	RB Offset	Narrowband Index	Cell power (dBm/15kHz)	power (dBm)
Low Range	26797	824.7	8797	869.7	QPSK	1	0	0	-85	23.62
					QPSK	1	5	0	-85	23.64
					QPSK	3	3	0	-85	22.19
					QPSK	6	0	0	-85	21.37
					16QAM	1	0	0	-85	23.24
					16QAM	1	5	0	-85	23.15
					16QAM	3	0	0	-85	22.36
					16QAM	5	0	0	-85	22.12
Mid Range	26915	836.5	8915	881.5	QPSK	1	0	0	-85	23.41
					QPSK	1	5	0	-85	23.51
					QPSK	3	3	0	-85	22.14
					QPSK	6	0	0	-85	21.41
					16QAM	1	0	0	-85	23.27
					16QAM	1	5	0	-85	23.18
					16QAM	3	0	0	-85	22.43
					16QAM	5	0	0	-85	22.22
High Range	27033	848.3	9033	893.3	QPSK	1	0	0	-85	23.79
					QPSK	1	5	0	-85	23.75
					QPSK	3	3	0	-85	22.27
					QPSK	6	0	0	-85	21.44
					16QAM	1	0	0	-85	23.33
					16QAM	1	5	0	-85	23.34
					16QAM	3	0	0	-85	22.46
					16QAM	5	0	0	-85	22.28

BW(MHz):		3								
Test Frequency ID	N <sub>UL</sub>	Frequency of Uplink [MHz]	N <sub>DL</sub>	Frequency of Downlink [MHz]	Test Configuration Initial of Power				EUT	
					Modulation	RB Size	RB Offset	Narrowband Index	Cell power (dBm/15kHz)	power (dBm)
Low Range	26805	825.5	8805	870.5	QPSK	1	0	0	-85	23.25
					QPSK	1	5	0	-85	23.46
					QPSK	1	0	1	-85	23.37
					QPSK	1	5	1	-85	23.48
					QPSK	3	3	0	-85	22.15
					QPSK	3	3	1	-85	22.12
					QPSK	6	0	0	-85	21.27
					QPSK	6	0	1	-85	21.19
					16QAM	1	0	0	-85	23.19
					16QAM	1	5	0	-85	23.01
					16QAM	1	0	1	-85	23.41
					16QAM	1	5	1	-85	23.43
					16QAM	3	0	0	-85	22.49
					16QAM	3	3	1	-85	22.14
					16QAM	5	0	0	-85	22.24
					16QAM	5	0	1	-85	22.37

Test Frequency ID	N <sub>UL</sub>	Frequency of Uplink [MHz]	N <sub>DL</sub>	Frequency of Downlink [MHz]	Test Configuration Initial of Power				EUT	
					Modulation	RB Size	RB Offset	Narrowband Index	Cell power (dBm/15kHz)	power (dBm)
Mid Range	26915	836.5	8915	881.5	QPSK	1	0	0	-85	23.41
					QPSK	1	5	0	-85	23.33
					QPSK	1	0	1	-85	23.42
					QPSK	1	5	1	-85	23.41
					QPSK	3	3	0	-85	23.39
					QPSK	3	3	1	-85	22.26
					QPSK	6	0	0	-85	21.18
					QPSK	6	0	1	-85	21.28
					16QAM	1	0	0	-85	23.22
					16QAM	1	5	0	-85	23.12
					16QAM	1	0	1	-85	23.21
					16QAM	1	5	1	-85	23.14
					16QAM	3	0	0	-85	22.42
					16QAM	3	3	1	-85	22.37
					16QAM	5	0	0	-85	22.34
					16QAM	5	0	1	-85	22.36
High Range	27025	847.5	9025	892.5	QPSK	1	0	0	-85	23.55
					QPSK	1	5	0	-85	23.41
					QPSK	1	0	1	-85	23.35
					QPSK	1	5	1	-85	23.44
					QPSK	3	3	0	-85	22.29
					QPSK	3	3	1	-85	22.36
					QPSK	6	0	0	-85	21.32
					QPSK	6	0	1	-85	21.24
					16QAM	1	0	0	-85	23.26
					16QAM	1	5	0	-85	23.24
					16QAM	1	0	1	-85	23.51
					16QAM	1	5	1	-85	23.49
					16QAM	3	0	0	-85	22.52
					16QAM	3	3	1	-85	22.35
					16QAM	5	0	0	-85	22.43
					16QAM	5	0	1	-85	22.42

BW(MHz):		5				Test Configuration Initial of Power			EUT	
Test Frequency ID	N <sub>UL</sub>	Frequency of Uplink [MHz]	N <sub>DL</sub>	Frequency of Downlink [MHz]	Modulation	RB Size	RB Offset	Narrowband Index	Cell power (dBm/15kHz)	power (dBm)
Low Range	26815	826.5	8815	871.5	QPSK	1	0	0	-85	23.17
					QPSK	1	5	0	-85	23.18
					QPSK	1	0	1	-85	23.11
					QPSK	1	5	1	-85	23.17
					QPSK	1	0	3	-85	23.27
					QPSK	1	5	3	-85	23.32
					QPSK	3	0	0	-85	22.47
					QPSK	3	3	3	-85	22.18
					QPSK	6	0	0	-85	22.19
					QPSK	6	0	1	-85	22.42
					QPSK	6	0	3	-85	22.27
					16QAM	1	0	0	-85	23.17
					16QAM	1	5	0	-85	23.18
					16QAM	1	0	1	-85	23.14
					16QAM	1	5	1	-85	23.02
					16QAM	1	0	3	-85	23.21
					16QAM	1	5	3	-85	23.14
					16QAM	3	0	0	-85	22.36
					16QAM	3	3	3	-85	22.34
					16QAM	5	0	0	-85	22.37
16QAM	5	0	1	-85	22.34					
16QAM	5	0	3	-85	22.37					
Mid Range	26915	836.5	8915	881.5	QPSK	1	0	0	-85	23.31
					QPSK	1	5	0	-85	23.26
					QPSK	1	0	1	-85	23.27
					QPSK	1	5	1	-85	23.36
					QPSK	1	0	3	-85	23.25
					QPSK	1	5	3	-85	23.31
					QPSK	3	0	0	-85	22.67
					QPSK	3	3	3	-85	22.15
					QPSK	6	0	0	-85	22.25
					QPSK	6	0	1	-85	22.54
					QPSK	6	0	3	-85	22.21
					16QAM	1	0	0	-85	23.15
					16QAM	1	5	0	-85	23.14
					16QAM	1	0	1	-85	23.17
					16QAM	1	5	1	-85	23.21
					16QAM	1	0	3	-85	23.23
					16QAM	1	5	3	-85	23.11
					16QAM	3	0	0	-85	22.51
					16QAM	3	3	3	-85	22.43
					16QAM	5	0	0	-85	22.38
16QAM	5	0	1	-85	22.31					
16QAM	5	0	3	-85	22.27					

Test Frequency ID	N <sub>UL</sub>	Frequency of Uplink [MHz]	N <sub>DL</sub>	Frequency of Downlink [MHz]	Test Configuration Initial of Power				EUT	
					Modulation	RB Size	RB Offset	Narrowband Index	Cell power (dBm/15kHz)	power (dBm)
High Range	27015	846.5	9015	891.5	QPSK	1	0	0	-85	23.27
					QPSK	1	5	0	-85	23.55
					QPSK	1	0	1	-85	23.33
					QPSK	1	5	1	-85	23.41
					QPSK	1	0	3	-85	23.22
					QPSK	1	5	3	-85	23.24
					QPSK	3	0	0	-85	22.87
					QPSK	3	3	3	-85	22.66
					QPSK	6	0	0	-85	22.47
					QPSK	6	0	1	-85	22.35
					QPSK	6	0	3	-85	22.11
					16QAM	1	0	0	-85	23.51
					16QAM	1	5	0	-85	23.47
					16QAM	1	0	1	-85	23.19
					16QAM	1	5	1	-85	23.32
					16QAM	1	0	3	-85	23.24
					16QAM	1	5	3	-85	23.15
					16QAM	3	0	0	-85	22.63
16QAM	3	3	3	-85	22.55					
16QAM	5	0	0	-85	22.64					
16QAM	5	0	1	-85	22.33					
16QAM	5	0	3	-85	22.56					

BW(MHz): 10

Test Frequency ID	N <sub>UL</sub>	Frequency of Uplink [MHz]	N <sub>DL</sub>	Frequency of Downlink [MHz]	Test Configuration Initial of Power				EUT	
					Modulation	RB Size	RB Offset	Narrowband Index	Cell power (dBm/15kHz)	power (dBm)
Low Range	26840	829	8840	874	QPSK	1	0	0	-85	23.02
					QPSK	1	5	0	-85	23.16
					QPSK	1	0	3	-85	23.17
					QPSK	1	5	3	-85	23.14
					QPSK	1	0	7	-85	23.25
					QPSK	1	5	7	-85	23.29
					QPSK	4	0	0	-85	23.17
					QPSK	4	2	7	-85	23.38
					QPSK	6	0	0	-85	22.25
					QPSK	6	0	7	-85	22.67
					16QAM	1	0	0	-85	23.44
					16QAM	1	5	0	-85	23.1
					16QAM	1	0	3	-85	23.15
					16QAM	1	5	3	-85	23.14
					16QAM	1	0	7	-85	23.41
					16QAM	1	5	7	-85	23.34
					16QAM	4	2	0	-85	23.12
					16QAM	4	2	7	-85	23.39
16QAM	5	0	0	-85	22.28					
16QAM	5	0	7	-85	22.47					

Test Frequency ID	N <sub>UL</sub>	Frequency of Uplink [MHz]	N <sub>DL</sub>	Frequency of Downlink [MHz]	Test Configuration Initial of Power				EUT	
					Modulation	RB Size	RB Offset	Narrowband Index	Cell power (dBm/15kHz)	power (dBm)
Mid Range	26915	836.5	8915	881.5	QPSK	1	0	0	-85	23.02
					QPSK	1	5	0	-85	23.19
					QPSK	1	0	3	-85	23.18
					QPSK	1	5	3	-85	23.13
					QPSK	1	0	7	-85	23.31
					QPSK	1	5	7	-85	23.34
					QPSK	4	0	0	-85	23.18
					QPSK	4	2	7	-85	23.41
					QPSK	6	0	0	-85	22.47
					QPSK	6	0	7	-85	22.77
					16QAM	1	0	0	-85	23.48
					16QAM	1	5	0	-85	23.13
					16QAM	1	0	3	-85	23.13
					16QAM	1	5	3	-85	23.34
					16QAM	1	0	7	-85	23.51
					16QAM	1	5	7	-85	23.36
					16QAM	4	2	0	-85	23.16
					16QAM	4	2	7	-85	23.05
16QAM	5	0	0	-85	22.45					
16QAM	5	0	7	-85	22.44					
High Range	26990	844	8990	889	QPSK	1	0	0	-85	23.12
					QPSK	1	5	0	-85	23.16
					QPSK	1	5	7	-85	23.23
					QPSK	1	0	3	-85	23.22
					QPSK	1	5	3	-85	23.25
					QPSK	1	0	7	-85	23.36
					QPSK	4	0	0	-85	23.11
					QPSK	4	2	7	-85	23.52
					QPSK	6	0	0	-85	22.47
					QPSK	6	0	7	-85	22.56
					16QAM	1	0	0	-85	23.43
					16QAM	1	5	0	-85	23.25
					16QAM	1	0	3	-85	23.11
					16QAM	1	5	3	-85	23.15
					16QAM	1	0	7	-85	23.2
					16QAM	1	5	7	-85	23.26
					16QAM	4	2	0	-85	23.21
					16QAM	4	2	7	-85	23.09
16QAM	5	0	0	-85	22.37					
16QAM	5	0	7	-85	22.43					



BW(MHz):		15								
Test Frequency ID	N <sub>UL</sub>	Frequency of Uplink [MHz]	N <sub>DL</sub>	Frequency of Downlink [MHz]	Test Configuration Initial of Power			EUT		
					Modulation	RB Size	RB Offset	Narrowband Index	Cell power (dBm/15kHz)	power (dBm)
Low Range	26865	831.5	8865	876.5	QPSK	1	0	0	-85	23.15
					QPSK	1	5	0	-85	23.25
					QPSK	1	0	5	-85	23.13
					QPSK	1	5	5	-85	23.26
					QPSK	1	0	11	-85	23.18
					QPSK	1	5	11	-85	23.17
					QPSK	3	0	0	-85	23.36
					QPSK	3	3	11	-85	23.13
					QPSK	6	0	0	-85	23.11
					QPSK	6	0	11	-85	23.24
					16QAM	1	0	0	-85	23.31
					16QAM	1	5	0	-85	23.26
					16QAM	1	0	5	-85	23.33
					16QAM	1	5	5	-85	23.19
					16QAM	1	0	11	-85	23.02
					16QAM	1	5	11	-85	23.15
					16QAM	3	0	0	-85	23.17
					16QAM	3	3	11	-85	23.21
16QAM	5	0	0	-85	23.12					
16QAM	5	0	11	-85	23.15					
Mid Range	26915	836.5	8915	881.5	QPSK	1	0	0	-85	23.25
					QPSK	1	5	0	-85	23.22
					QPSK	1	0	5	-85	23.26
					QPSK	1	5	5	-85	23.24
					QPSK	1	0	11	-85	23.07
					QPSK	1	5	11	-85	23.09
					QPSK	3	0	0	-85	23.32
					QPSK	3	3	11	-85	23.02
					QPSK	6	0	0	-85	23.17
					QPSK	6	0	11	-85	23.18
					16QAM	1	0	0	-85	23.33
					16QAM	1	5	0	-85	23.19
					16QAM	1	0	5	-85	23.37
					16QAM	1	5	5	-85	23.41
					16QAM	1	0	11	-85	23.15
					16QAM	1	5	11	-85	23.24
					16QAM	3	0	0	-85	23.28
					16QAM	3	3	11	-85	23.15
16QAM	5	0	0	-85	23.22					
16QAM	5	0	11	-85	23.22					

Test Frequency ID	N <sub>UL</sub>	Frequency of Uplink [MHz]	N <sub>DL</sub>	Frequency of Downlink [MHz]	Test Configuration Initial of Power			EUT		
					Modulation	RB Size	RB Offset	Narrowband Index	Cell power (dBm/15kHz)	power (dBm)
High Range	26965	841.5	8965	886.5	QPSK	1	0	0	-85	23.22
					QPSK	1	5	11	-85	23.31
					QPSK	1	0	5	-85	23.48
					QPSK	1	5	5	-85	23.44
					QPSK	1	0	11	-85	23.52
					QPSK	1	5	11	-85	23.45
					QPSK	3	0	0	-85	23.21
					QPSK	3	3	11	-85	23.43
					QPSK	6	0	0	-85	23.19
					QPSK	6	0	11	-85	23.17
					16QAM	1	0	0	-85	23.39
					16QAM	1	5	0	-85	23.25
					16QAM	1	0	5	-85	23.46
					16QAM	1	5	5	-85	23.44
					16QAM	1	0	11	-85	23.39
					16QAM	1	5	11	-85	23.38
					16QAM	3	0	0	-85	23.23
					16QAM	3	3	11	-85	23.27
16QAM	5	0	0	-85	23.27					
16QAM	5	0	11	-85	23.18					

**ERP Power (dBm)**

LTE Band 5							
Channel Bandwidth: 1.4 MHz / QPSK							
Plane	Channel	Frequency (MHz)	Reading (dBm)	Correction Factor (dB)	ERP (dBm)	ERP (mW)	Polarization (H/V)
X	20407	824.7	-5.76	32.62	24.71	295.80	H
	20525	836.5	-5.39	32.52	24.98	314.77	
	20643	848.3	-5.91	32.65	24.59	287.74	
	20407	824.7	-12.30	32.76	18.31	67.76	V
	20525	836.5	-11.72	32.39	18.52	71.12	
	20643	848.3	-12.38	32.54	18.01	63.24	
Channel Bandwidth: 1.4 MHz / 16QAM							
X	20407	824.7	-6.75	32.62	23.72	235.50	H
	20525	836.5	-6.38	32.52	23.99	250.61	
	20643	848.3	-6.90	32.65	23.60	229.09	
	20407	824.7	-13.29	32.76	17.32	53.95	V
	20525	836.5	-12.71	32.39	17.53	56.62	
	20643	848.3	-13.37	32.54	17.02	50.35	

Note: ERP (dBm) = Reading (dBm) + Correction Factor (dB) – 2.15

LTE Band 5							
Channel Bandwidth: 3 MHz / QPSK							
Plane	Channel	Frequency (MHz)	Reading (dBm)	Correction Factor (dB)	ERP (dBm)	ERP (mW)	Polarization (H/V)
X	20415	825.5	-6.08	32.62	24.39	274.79	H
	20525	836.5	-5.71	32.52	24.66	292.42	
	20635	847.5	-6.23	32.65	24.27	267.30	
	20415	825.5	-12.62	32.76	17.99	62.95	V
	20525	836.5	-12.04	32.39	18.20	66.07	
	20635	847.5	-12.70	32.54	17.69	58.75	
Channel Bandwidth: 3 MHz / 16QAM							
X	20415	825.5	-7.07	32.62	23.40	218.78	H
	20525	836.5	-6.70	32.52	23.67	232.81	
	20635	847.5	-7.22	32.65	23.28	212.81	
	20415	825.5	-13.61	32.76	17.00	50.12	V
	20525	836.5	-13.03	32.39	17.21	52.60	
	20635	847.5	-13.69	32.54	16.70	46.77	

Note: ERP (dBm) = Reading (dBm) + Correction Factor (dB) – 2.15

LTE Band 5							
Channel Bandwidth: 5 MHz / QPSK							
Plane	Channel	Frequency (MHz)	Reading (dBm)	Correction Factor (dB)	ERP (dBm)	ERP (mW)	Polarization (H/V)
X	20425	826.5	-6.36	32.62	24.11	257.63	H
	20525	836.5	-5.99	32.52	24.38	274.16	
	20625	846.5	-6.51	32.65	23.99	250.61	
	20425	826.5	-12.90	32.76	17.71	59.02	V
	20525	836.5	-12.32	32.39	17.92	61.94	
	20625	846.5	-12.98	32.54	17.41	55.08	
Channel Bandwidth: 5 MHz / 16QAM							
X	20425	826.5	-7.39	32.62	23.08	203.24	H
	20525	836.5	-7.02	32.52	23.35	216.27	
	20625	846.5	-7.54	32.65	22.96	197.70	
	20425	826.5	-13.93	32.76	16.68	46.56	V
	20525	836.5	-13.35	32.39	16.89	48.87	
	20625	846.5	-14.01	32.54	16.38	43.45	

Note: ERP (dBm) = Reading (dBm) + Correction Factor (dB) – 2.15

LTE Band 5							
Channel Bandwidth: 10 MHz / QPSK							
Plane	Channel	Frequency (MHz)	Reading (dBm)	Correction Factor (dB)	ERP (dBm)	ERP (mW)	Polarization (H/V)
X	20450	829.0	-6.69	32.62	23.78	238.78	H
	20525	836.5	-6.32	32.52	24.05	254.10	
	20600	844.0	-6.84	32.65	23.66	232.27	
	20450	829.0	-13.23	32.76	17.38	54.70	V
	20525	836.5	-12.65	32.39	17.59	57.41	
	20600	844.0	-13.31	32.54	17.08	51.05	
Channel Bandwidth: 10 MHz / 16QAM							
X	20425	826.5	-7.71	32.62	22.76	188.80	H
	20525	836.5	-7.34	32.52	23.03	200.91	
	20625	846.5	-7.86	32.65	22.64	183.65	
	20425	826.5	-14.25	32.76	16.36	43.25	V
	20525	836.5	-13.67	32.39	16.57	45.39	
	20625	846.5	-14.33	32.54	16.06	40.36	

Note: ERP (dBm) = Reading (dBm) + Correction Factor (dB) – 2.15

LTE Band 26							
Channel Bandwidth: 1.4 MHz / QPSK							
Plane	Channel	Frequency (MHz)	Reading (dBm)	Correction Factor (dB)	ERP (dBm)	ERP (mW)	Polarization (H/V)
X	26797	824.7	-6.39	32.62	24.08	255.86	H
	26915	836.5	-6.38	32.52	23.99	250.61	
	27033	848.3	-6.29	32.65	24.21	263.63	
	26797	824.7	-11.92	32.76	18.69	73.96	V
	26915	836.5	-11.76	32.39	18.48	70.47	
	27033	848.3	-11.40	32.54	18.99	79.25	
Channel Bandwidth: 1.4 MHz / 16QAM							
X	26797	824.7	-7.40	32.62	23.07	202.77	H
	26915	836.5	-7.39	32.52	22.98	198.61	
	27033	848.3	-7.30	32.65	23.20	208.93	
	26797	824.7	-12.93	32.76	17.68	58.61	V
	26915	836.5	-12.77	32.39	17.47	55.85	
	27033	848.3	-12.41	32.54	17.98	62.81	

Note: ERP (dBm) = Reading (dBm) + Correction Factor (dB) – 2.15

LTE Band 26							
Channel Bandwidth: 3 MHz / QPSK							
Plane	Channel	Frequency (MHz)	Reading (dBm)	Correction Factor (dB)	ERP (dBm)	ERP (mW)	Polarization (H/V)
X	26805	825.5	-6.64	32.62	23.83	241.55	H
	26915	836.5	-6.63	32.52	23.74	236.59	
	27025	847.5	-6.54	32.65	23.96	248.89	
	26805	825.5	-12.17	32.76	18.44	69.82	V
	26915	836.5	-12.01	32.39	18.23	66.53	
	27025	847.5	-11.65	32.54	18.74	74.82	
Channel Bandwidth: 3 MHz / 16QAM							
X	26805	825.5	-7.63	32.62	22.84	192.31	H
	26915	836.5	-7.62	32.52	22.75	188.36	
	27025	847.5	-7.53	32.65	22.97	198.15	
	26805	825.5	-13.16	32.76	17.45	55.59	V
	26915	836.5	-13.00	32.39	17.24	52.97	
	27025	847.5	-12.64	32.54	17.75	59.57	

Note: ERP (dBm) = Reading (dBm) + Correction Factor (dB) – 2.15

LTE Band 26							
Channel Bandwidth: 5 MHz / QPSK							
Plane	Channel	Frequency (MHz)	Reading (dBm)	Correction Factor (dB)	ERP (dBm)	ERP (mW)	Polarization (H/V)
X	26815	826.5	-6.91	32.62	23.56	226.99	H
	26915	836.5	-6.90	32.52	23.47	222.33	
	27015	846.5	-6.81	32.65	23.69	233.88	
	26815	826.5	-12.44	32.76	18.17	65.61	V
	26919	836.5	-12.28	32.39	17.96	62.52	
	27015	846.5	-11.92	32.54	18.47	70.31	
Channel Bandwidth: 5 MHz / 16QAM							
X	26815	826.5	-7.89	32.62	22.58	181.13	H
	26915	836.5	-7.88	32.52	22.49	177.42	
	27015	846.5	-7.79	32.65	22.71	186.64	
	26815	826.5	-13.42	32.76	17.19	52.36	V
	26919	836.5	-13.26	32.39	16.98	49.89	
	27015	846.5	-12.90	32.54	17.49	56.10	

Note: ERP (dBm) = Reading (dBm) + Correction Factor (dB) – 2.15

LTE Band 26							
Channel Bandwidth: 10 MHz / QPSK							
Plane	Channel	Frequency (MHz)	Reading (dBm)	Correction Factor (dB)	ERP (dBm)	ERP (mW)	Polarization (H/V)
X	26840	829.0	-7.22	32.62	23.25	211.35	H
	26915	836.5	-7.21	32.52	23.16	207.01	
	26990	844.0	-7.12	32.65	23.38	217.77	
	26840	829.0	-12.75	32.76	17.86	61.09	V
	26919	836.5	-12.59	32.39	17.65	58.21	
	26990	844.0	-12.23	32.54	18.16	65.46	
Channel Bandwidth: 10 MHz / 16QAM							
X	26840	829.0	-8.24	32.62	22.23	167.11	H
	26915	836.5	-8.23	32.52	22.14	163.68	
	26990	844.0	-8.14	32.65	22.36	172.19	
	26840	829.0	-13.77	32.76	16.84	48.31	V
	26919	836.5	-13.61	32.39	16.63	46.03	
	26990	844.0	-13.25	32.54	17.14	51.76	

Note: ERP (dBm) = Reading (dBm) + Correction Factor (dB) – 2.15

LTE Band 26							
Channel Bandwidth: 15 MHz / QPSK							
Plane	Channel	Frequency (MHz)	Reading (dBm)	Correction Factor (dB)	ERP (dBm)	ERP (mW)	Polarization (H/V)
X	26865	831.5	-7.49	32.62	22.98	198.61	H
	26915	836.5	-7.48	32.52	22.89	194.54	
	26965	841.5	-7.39	32.65	23.11	204.64	
	26865	831.5	-13.02	32.76	17.59	57.41	V
	26915	836.5	-12.86	32.39	17.38	54.70	
	26965	841.5	-12.50	32.54	17.89	61.52	
Channel Bandwidth: 15 MHz / 16QAM							
X	26865	831.5	-8.50	32.62	21.97	157.40	H
	26915	836.5	-8.49	32.52	21.88	154.17	
	26965	841.5	-8.40	32.65	22.10	162.18	
	26865	831.5	-14.03	32.76	16.58	45.50	V
	26915	836.5	-13.87	32.39	16.37	43.35	
	26965	841.5	-13.51	32.54	16.88	48.75	

Note: ERP (dBm) = Reading (dBm) + Correction Factor (dB) – 2.15

## 4.2 Modulation characteristics Measurement

### 4.2.1 Limits of Modulation characteristics

N/A

### 4.2.2 Test Procedure

Connect the EUT to Communication Simulator via the antenna connector, The frequency band is set as EUT supported Modulation and Channels, the EUT output is matched with 50 ohm load, the waveform quality and constellation of the EUT was tested.

### 4.2.3 Test Setup





### LTE Band 5

#### Spectrum Plot of Measurement Value

##### Channel: 20525 (QPSK) Frequency (MHz): 836.5

Phone1  
CAT-M1  
30.70S#021

UL Channel: 20525 ch  
Operation Band: 5

TPC Pattern: Auto  
Channel Bandwidth: 5 MHz

Input Level: 30.0 dBm  
Output Level: -60.2 dBm

**UL RMC - MCS Index** ULIMCS

This sets MCS Index for the uplink signal. When setting MCS Index, changes to the modulation scheme and TBS Index settings are linked.

MT8821C  
2018/07/06 23:16  
RF Output: On

Common

- Call Processing:  UL RMC
- TX Measurement: Number of RB: 5
- RX Measurement: Starting RB: 0
- Fundamental Measurement: Max UL Throughput: 36 kbps
- MCS Index: 0 QPSK - 120
- DL RMC:

Measurement | Signaling | IP Data

UE Power: 21.9 dBm

Fundamental > Constellation

270 Symbol

	Avg.	Max.	Min.	Limit
EVM	1.93	1.93	1.93 %(rms)	
Peak Vector Error	10.45	10.45	10.45 %	
Carrier Leakage	-72.69	-72.69	-72.69 dBc	

Main Screen

- Fundamental
- Sub Screen
- Constellation

Number of RB: 5

Starting RB: 0

Interpolation (Constellation): None

4 Views

#### Channel: 20525 (16QAM)

##### Frequency (MHz): 836.5

Phone1  
CAT-M1  
30.70S#021

UL Channel: 20525 ch  
Operation Band: 5

TPC Pattern: Auto  
Channel Bandwidth: 5 MHz

Input Level: 30.0 dBm  
Output Level: -60.2 dBm

**UL RMC - MCS Index** ULIMCS

This sets MCS Index for the uplink signal. When setting MCS Index, changes to the modulation scheme and TBS Index settings are linked.

MT8821C  
2018/07/06 23:16  
RF Output: On

Common

- Call Processing:  UL RMC
- TX Measurement: Number of RB: 5
- RX Measurement: Starting RB: 0
- Fundamental Measurement: Max UL Throughput: 262 kbps
- MCS Index: 11 16QAM 10 872
- DL RMC:

Measurement | Signaling | IP Data

UE Power: 21.2 dBm

Fundamental > Constellation

270 Symbol

	Avg.	Max.	Min.	Limit
EVM	2.03	2.03	2.03 %(rms)	
Peak Vector Error	8.32	8.32	8.32 %	
Carrier Leakage	-80.77	-80.77	-80.77 dBc	

Main Screen

- Fundamental
- Sub Screen
- Constellation

Number of RB: 5

Starting RB: 0

Interpolation (Constellation): None

4 Views

### LTE Band 26

#### Spectrum Plot of Measurement Value

##### Channel: 26915 (QPSK) Frequency (MHz): 836.5

Phone1  
CAT-M1  
30.70S#021

UL Channel: 26915 ch  
Operation Band: 26

TPC Pattern: Auto  
Channel Bandwidth: 5 MHz

Input Level: 30.0 dBm  
Output Level: -60.2 dBm

UL Channel: ULCHAN  
This sets the uplink channel. When changing the set value of the uplink channel, the downlink channel and uplink frequency are changed automatically.

MT8821C  
2018/07/06 23:26  
RF Output: On

Common

Call Processing: UL RMC

TX Measurement: Number of RB: 5, Starting RB: 0

RX Measurement: Max UL Throughput: 36 kbps

Fundamental Measurement: MCS Index: 0 QPSK - 120

DL RMC

Measurement | Signaling | IP Data

UE Power: 21.9 dBm

Fundamental > Constellation

270 Symbol

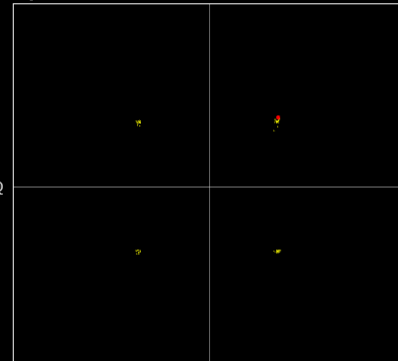

Meas. Count: 1/ 1

	Avg.	Max.	Min.	Limit
EVM	2.23	2.23	2.23 %(rms)	
Peak Vector Error	10.55	10.55	10.55 %	
Carrier Leakage	-73.38	-73.38	-73.38 dBc	

Main Screen

Fundamental

Sub Screen

Constellation

Number of RB: 5

Starting RB: 0

Interpolation (Constellation): None

4 Views

#### Channel: 26915 (16QAM) Frequency (MHz): 836.5

Phone1  
CAT-M1  
30.70S#021

UL Channel: 26915 ch  
Operation Band: 26

TPC Pattern: Auto  
Channel Bandwidth: 5 MHz

Input Level: 30.0 dBm  
Output Level: -60.2 dBm

UL RMC - MCS Index: ULIMCS  
This sets MCS Index for the uplink signal. When setting MCS Index, changes to the modulation scheme and TBS Index settings are linked.

MT8821C  
2018/07/06 23:27  
RF Output: On

Common

Call Processing: UL RMC

TX Measurement: Number of RB: 5, Starting RB: 0

RX Measurement: Max UL Throughput: 262 kbps

Fundamental Measurement: MCS Index: 11 16QAM 10 872

DL RMC

Measurement | Signaling | IP Data

UE Power: 21.3 dBm

Fundamental > Constellation

270 Symbol

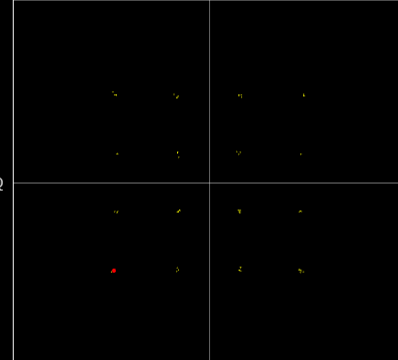

Meas. Count: 1/ 1

	Avg.	Max.	Min.	Limit
EVM	2.07	2.07	2.07 %(rms)	
Peak Vector Error	8.80	8.80	8.80 %	
Carrier Leakage	-80.08	-80.08	-80.08 dBc	

Main Screen

Fundamental

Sub Screen

Constellation

Number of RB: 5

Starting RB: 0

Interpolation (Constellation): None

4 Views

### 4.3 Frequency Stability Measurement

#### 4.3.1 Limits of Frequency Stability Measurement

1.5 ppm is for base and fixed station. 2.5 ppm is for mobile station.

#### 4.3.2 Test Procedure

- a. Device is placed at the oven room. The oven room could control the temperatures and humidity. Power warm up is at least 15 min and power applied should perform before recording frequency error.
- b. EUT is connected the external power supply to control the DC input power. The test voltage range is from minimum to maximum working voltage. Each step shall be record the frequency error rate.
- c. The temperature range step is 10 degrees in this test items. All temperature levels shall be hold the  $\pm 0.5$  °C during the measurement testing. The each temperature step shall be at least 0.5 hours, consider the EUT could be test under the stability condition.

**NOTE:** The frequency error was recorded frequency error from the communication simulator.

#### 4.3.3 Test Setup

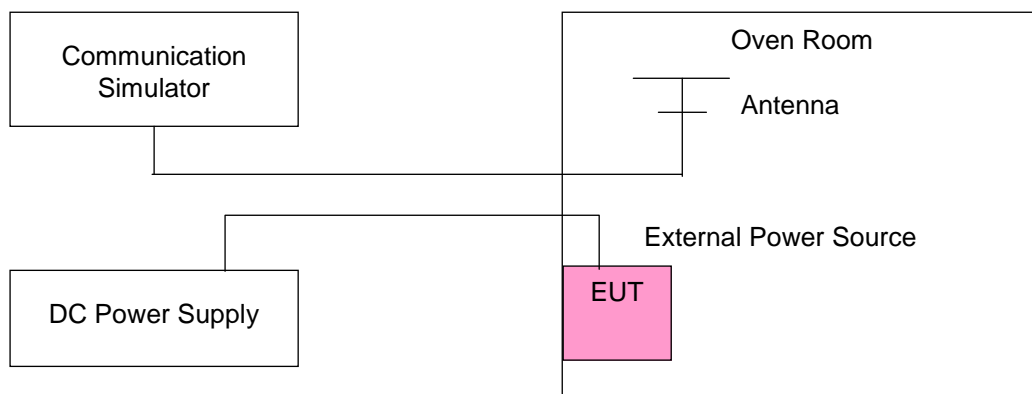

#### 4.3.4 Test Results

##### Frequency Error vs. Voltage

Voltage (Volts)	LTE Band 5				Limit (ppm)
	Channel Bandwidth: 1.4 MHz				
	Low Channel		High Channel		
	Frequency (MHz)	Frequency Error (ppm)	Frequency (MHz)	Frequency Error (ppm)	
108	824.700003	0.003	848.300002	0.002	2.5
120	824.700004	0.004	848.300003	0.004	2.5
132	824.700003	0.003	848.300003	0.004	2.5

**Note:** The applicant defined the normal working voltage of the adapter is from 108 Vac to 132 Vac.

##### Frequency Error vs. Temperature

Temp. (°C)	LTE Band 5				Limit (ppm)
	Channel Bandwidth: 1.4 MHz				
	Low Channel		High Channel		
	Frequency (MHz)	Frequency Error (ppm)	Frequency (MHz)	Frequency Error (ppm)	
-30	824.700003	0.004	848.300001	0.002	2.5
-20	824.700001	0.001	848.300003	0.003	2.5
-10	824.700004	0.004	848.300004	0.005	2.5
0	824.700002	0.002	848.300001	0.001	2.5
10	824.700002	0.002	848.300002	0.003	2.5
20	824.700001	0.001	848.300004	0.005	2.5
30	824.699997	-0.004	848.299999	-0.001	2.5
40	824.699999	-0.002	848.299996	-0.004	2.5
50	824.699998	-0.003	848.299999	-0.002	2.5
60	824.699998	-0.003	848.299998	-0.003	2.5
70	824.699999	-0.001	848.299999	-0.002	2.5
80	824.699998	-0.002	848.299998	-0.002	2.5
85	824.699998	-0.003	848.299999	-0.002	2.5

## Frequency Error vs. Voltage

Voltage (Volts)	LTE Band 5				Limit (ppm)
	Channel Bandwidth: 3 MHz				
	Low Channel		High Channel		
	Frequency (MHz)	Frequency Error (ppm)	Frequency (MHz)	Frequency Error (ppm)	
10.2	825.500002	0.003	847.500003	0.004	2.5
12.0	825.500004	0.005	847.500003	0.003	2.5
13.8	825.500002	0.002	847.500002	0.002	2.5

**Note:** The applicant defined the normal working voltage of the adapter is from 108 Vac to 132 Vac.

## Frequency Error vs. Temperature

Temp. (°C)	LTE Band 5				Limit (ppm)
	Channel Bandwidth: 3 MHz				
	Low Channel		High Channel		
	Frequency (MHz)	Frequency Error (ppm)	Frequency (MHz)	Frequency Error (ppm)	
-30	825.500003	0.004	847.500002	0.002	2.5
-20	825.500003	0.004	847.500003	0.003	2.5
-10	825.500001	0.001	847.500004	0.005	2.5
0	825.500004	0.004	847.500002	0.003	2.5
10	825.500002	0.002	847.500001	0.002	2.5
20	825.500003	0.004	847.499997	-0.003	2.5
30	825.499999	-0.002	847.499996	-0.004	2.5
40	825.499996	-0.004	847.499997	-0.004	2.5
50	825.499996	-0.005	847.499998	-0.003	2.5
60	825.499997	-0.004	847.499996	-0.004	2.5
70	825.499998	-0.002	847.499998	-0.003	2.5
80	825.499998	-0.003	847.499998	-0.003	2.5
85	825.499997	-0.004	847.499996	-0.004	2.5

Frequency Error vs. Voltage

Voltage (Volts)	LTE Band 5				Limit (ppm)
	Channel Bandwidth: 5 MHz				
	Low Channel		High Channel		
	Frequency (MHz)	Frequency Error (ppm)	Frequency (MHz)	Frequency Error (ppm)	
120	826.500002	0.002	846.500002	0.003	2.5
108	826.500003	0.004	846.500003	0.004	2.5
132	826.500002	0.002	846.500001	0.001	2.5

**Note:** The applicant defined the normal working voltage of the adapter is from 108 Vac to 132 Vac.

Frequency Error vs. Temperature

Temp. (°C)	LTE Band 5				Limit (ppm)
	Channel Bandwidth: 5 MHz				
	Low Channel		High Channel		
	Frequency (MHz)	Frequency Error (ppm)	Frequency (MHz)	Frequency Error (ppm)	
-30	826.500003	0.004	846.500002	0.002	2.5
-20	826.500002	0.002	846.500002	0.002	2.5
-10	826.500004	0.004	846.500002	0.002	2.5
0	826.500002	0.002	846.500002	0.003	2.5
10	826.500002	0.002	846.500001	0.002	2.5
20	826.499996	-0.005	846.499998	-0.003	2.5
30	826.499997	-0.004	846.499999	-0.001	2.5
40	826.499999	-0.002	846.499996	-0.004	2.5
50	826.499997	-0.004	846.499996	-0.004	2.5
60	826.499998	-0.003	846.499997	-0.004	2.5
70	826.499997	-0.004	846.499996	-0.004	2.5
80	826.499997	-0.004	846.499996	-0.004	2.5
85	826.499998	-0.003	846.499997	-0.004	2.5

## Frequency Error vs. Voltage

Voltage (Volts)	LTE Band 5				Limit (ppm)
	Channel Bandwidth: 10 MHz				
	Low Channel		High Channel		
	Frequency (MHz)	Frequency Error (ppm)	Frequency (MHz)	Frequency Error (ppm)	
120	829.000004	0.005	844.000001	0.002	2.5
108	829.000001	0.002	844.000004	0.005	2.5
132	829.000004	0.004	844.000004	0.005	2.5

**Note:** The applicant defined the normal working voltage of the adapter is from 108 Vac to 132 Vac.

## Frequency Error vs. Temperature

Temp. (°C)	LTE Band 5				Limit (ppm)
	Channel Bandwidth: 10 MHz				
	Low Channel		High Channel		
	Frequency (MHz)	Frequency Error (ppm)	Frequency (MHz)	Frequency Error (ppm)	
-30	829.000002	0.002	844.000004	0.005	2.5
-20	829.000004	0.004	844.000003	0.004	2.5
-10	829.000003	0.003	844.000004	0.004	2.5
0	829.000003	0.004	844.000004	0.005	2.5
10	829.000002	0.002	844.000003	0.004	2.5
20	828.999999	-0.002	843.999998	-0.002	2.5
30	828.999999	-0.002	843.999999	-0.001	2.5
40	828.999997	-0.004	843.999997	-0.004	2.5
50	828.999998	-0.003	843.999998	-0.003	2.5
60	828.999998	-0.002	843.999998	-0.002	2.5
70	828.999998	-0.003	843.999998	-0.003	2.5
80	828.999998	-0.003	843.999998	-0.003	2.5
85	828.999998	-0.002	843.999998	-0.002	2.5

## Frequency Error vs. Voltage

Voltage (Volts)	LTE Band 26				Limit (ppm)
	Channel Bandwidth: 1.4 MHz				
	Low Channel		High Channel		
	Frequency (MHz)	Frequency Error (ppm)	Frequency (MHz)	Frequency Error (ppm)	
120	824.700003	0.003	848.300002	0.002	2.5
108	824.700004	0.004	848.300003	0.004	2.5
132	824.700002	0.002	848.300003	0.004	2.5

**Note:** The applicant defined the normal working voltage of the adapter is from 108 Vac to 132 Vac.

## Frequency Error vs. Temperature

Temp. (°C)	LTE Band 26				Limit (ppm)
	Channel Bandwidth: 1.4 MHz				
	Low Channel		High Channel		
	Frequency (MHz)	Frequency Error (ppm)	Frequency (MHz)	Frequency Error (ppm)	
-30	824.700002	0.002	848.300001	0.001	2.5
-20	824.700002	0.002	848.300004	0.005	2.5
-10	824.700003	0.003	848.300004	0.004	2.5
0	824.700002	0.002	848.300002	0.002	2.5
10	824.700002	0.003	848.300002	0.003	2.5
20	824.699997	-0.004	848.299999	-0.001	2.5
30	824.699997	-0.004	848.299997	-0.004	2.5
40	824.699998	-0.003	848.299998	-0.003	2.5
50	824.699997	-0.003	848.299998	-0.003	2.5
60	824.699998	-0.003	848.299998	-0.003	2.5
70	824.699997	-0.003	848.299998	-0.003	2.5
80	824.699997	-0.003	848.299998	-0.003	2.5
85	824.699998	-0.003	848.299998	-0.003	2.5



## Frequency Error vs. Voltage

Voltage (Volts)	LTE Band 26				Limit (ppm)
	Channel Bandwidth: 3 MHz				
	Low Channel		High Channel		
	Frequency (MHz)	Frequency Error (ppm)	Frequency (MHz)	Frequency Error (ppm)	
120	825.500002	0.003	847.500002	0.002	2.5
108	825.500001	0.001	847.500002	0.003	2.5
132	825.500003	0.004	847.500002	0.002	2.5

**Note:** The applicant defined the normal working voltage of the adapter is from 108 Vac to 132 Vac.

## Frequency Error vs. Temperature

Temp. (°C)	LTE Band 26				Limit (ppm)
	Channel Bandwidth: 3 MHz				
	Low Channel		High Channel		
	Frequency (MHz)	Frequency Error (ppm)	Frequency (MHz)	Frequency Error (ppm)	
-30	825.500004	0.004	847.500003	0.004	2.5
-20	825.500002	0.003	847.500001	0.001	2.5
-10	825.500003	0.004	847.500003	0.004	2.5
0	825.500003	0.004	847.500002	0.003	2.5
10	825.500003	0.004	847.500002	0.002	2.5
20	825.499997	-0.003	847.499998	-0.003	2.5
30	825.500003	0.004	847.500002	0.003	2.5
40	825.500003	0.004	847.500002	0.002	2.5
50	825.499997	-0.003	847.499998	-0.003	2.5
60	825.499997	-0.004	847.499998	-0.002	2.5
70	825.499996	-0.005	847.499999	-0.001	2.5
50	825.499999	-0.002	847.499999	-0.002	2.5
85	825.499998	-0.003	847.499998	-0.002	2.5

## Frequency Error vs. Voltage

Voltage (Volts)	LTE Band 26				Limit (ppm)
	Channel Bandwidth: 5 MHz				
	Low Channel		High Channel		
	Frequency (MHz)	Frequency Error (ppm)	Frequency (MHz)	Frequency Error (ppm)	
120	826.500001	0.001	846.500004	0.004	2.5
108	826.500003	0.004	846.500003	0.004	2.5
132	826.500003	0.004	846.500003	0.004	2.5

**Note:** The applicant defined the normal working voltage of the adapter is from 108 Vac to 132 Vac.

## Frequency Error vs. Temperature

Temp. (°C)	LTE Band 26				Limit (ppm)
	Channel Bandwidth: 5 MHz				
	Low Channel		High Channel		
	Frequency (MHz)	Frequency Error (ppm)	Frequency (MHz)	Frequency Error (ppm)	
-30	826.500003	0.003	846.500001	0.002	2.5
-20	826.500001	0.001	846.500001	0.001	2.5
-10	826.500001	0.001	846.500004	0.005	2.5
0	826.500002	0.002	846.500004	0.005	2.5
10	826.500003	0.003	846.500002	0.002	2.5
20	826.499999	-0.001	846.499999	-0.002	2.5
30	826.500002	0.002	846.500004	0.005	2.5
40	826.500003	0.003	846.500002	0.002	2.5
50	826.499999	-0.001	846.499999	-0.002	2.5
60	826.499998	-0.003	846.499997	-0.004	2.5
70	826.499998	-0.002	846.499997	-0.004	2.5
50	826.499998	-0.002	846.499997	-0.004	2.5
85	826.499997	-0.004	846.499998	-0.003	2.5

## Frequency Error vs. Voltage

Voltage (Volts)	LTE Band 26				Limit (ppm)
	Channel Bandwidth: 10 MHz				
	Low Channel		High Channel		
	Frequency (MHz)	Frequency Error (ppm)	Frequency (MHz)	Frequency Error (ppm)	
120	829.000003	0.004	844.000003	0.003	2.5
108	829.000002	0.003	844.000002	0.003	2.5
132	829.000002	0.003	844.000002	0.003	2.5

**Note:** The applicant defined the normal working voltage of the adapter is from 108 Vac to 132 Vac.

## Frequency Error vs. Temperature

Temp. (°C)	LTE Band 26				Limit (ppm)
	Channel Bandwidth: 10 MHz				
	Low Channel		High Channel		
	Frequency (MHz)	Frequency Error (ppm)	Frequency (MHz)	Frequency Error (ppm)	
-30	829.000004	0.005	844.000001	0.001	2.5
-20	829.000001	0.001	844.000004	0.005	2.5
-10	829.000002	0.003	844.000002	0.003	2.5
0	829.000002	0.003	844.000002	0.002	2.5
10	829.000004	0.004	844.000001	0.002	2.5
20	828.999996	-0.004	843.999998	-0.002	2.5
30	829.000002	0.003	844.000002	0.002	2.5
40	829.000004	0.004	844.000001	0.002	2.5
50	828.999996	-0.004	843.999998	-0.002	2.5
60	828.999998	-0.003	843.999997	-0.004	2.5
70	828.999998	-0.002	843.999999	-0.002	2.5
50	828.999999	-0.001	843.999999	-0.001	2.5
85	828.999998	-0.002	843.999996	-0.004	2.5

## Frequency Error vs. Voltage

Voltage (Volts)	LTE Band 26				Limit (ppm)
	Channel Bandwidth: 15 MHz				
	Low Channel		High Channel		
	Frequency (MHz)	Frequency Error (ppm)	Frequency (MHz)	Frequency Error (ppm)	
120	831.500004	0.005	841.500002	0.002	2.5
108	831.500004	0.005	841.500002	0.003	2.5
132	831.500004	0.005	841.500002	0.002	2.5

**Note:** The applicant defined the normal working voltage of the adapter is from 108 Vac to 132 Vac.

## Frequency Error vs. Temperature

Temp. (°C)	LTE Band 26				Limit (ppm)
	Channel Bandwidth: 15 MHz				
	Low Channel		High Channel		
	Frequency (MHz)	Frequency Error (ppm)	Frequency (MHz)	Frequency Error (ppm)	
-30	831.500003	0.004	841.500002	0.002	2.5
-20	831.500001	0.001	841.500003	0.003	2.5
-10	831.500002	0.003	841.500001	0.001	2.5
0	831.500002	0.002	841.500002	0.002	2.5
10	831.500001	0.001	841.500004	0.005	2.5
20	831.499998	-0.002	841.499996	-0.005	2.5
30	831.500002	0.002	841.500002	0.002	2.5
40	831.500001	0.001	841.500004	0.005	2.5
50	831.499998	-0.002	841.499996	-0.005	2.5
60	831.499996	-0.005	841.499998	-0.002	2.5
70	831.499997	-0.004	841.499998	-0.002	2.5
50	831.499996	-0.005	841.499998	-0.003	2.5
85	831.499998	-0.002	841.499998	-0.002	2.5

## 4.4 Occupied Bandwidth Measurement

### 4.4.1 Test Procedure

The EUT makes a call to the communication simulator. All measurements were done at low, middle and high operational frequency range. The communication simulator station system controlled a EUT to export maximum output power under transmission mode and specific channel frequency. Use OBW measurement function of Spectrum analyzer to measure 99 % occupied bandwidth.

### 4.4.2 Test Setup

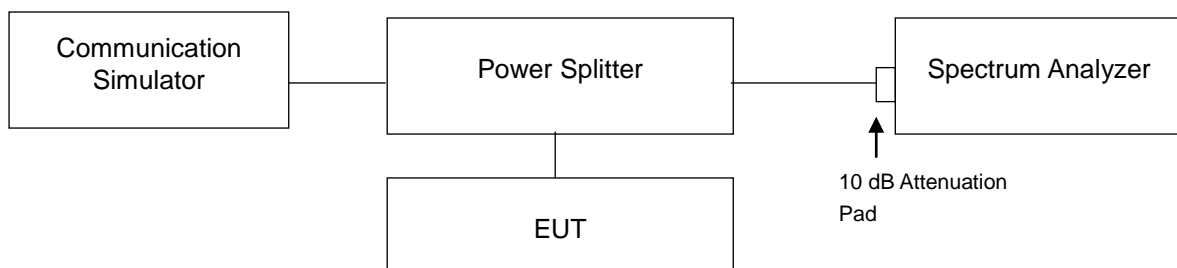

### 4.4.3 Test Result

LTE Band 5							
Channel Bandwidth: 1.4 MHz				Channel Bandwidth: 3 MHz			
Channel	Frequency (MHz)	99 % Occupied Bandwidth (MHz)		Channel	Frequency (MHz)	99 % Occupied Bandwidth (MHz)	
		QPSK	16QAM			QPSK	16QAM
20407	824.7	1.088	0.915	20415	825.5	1.085	0.902
20525	836.5	1.088	0.913	20525	836.5	1.087	0.917
20643	848.3	1.090	0.912	20635	847.5	1.083	0.915

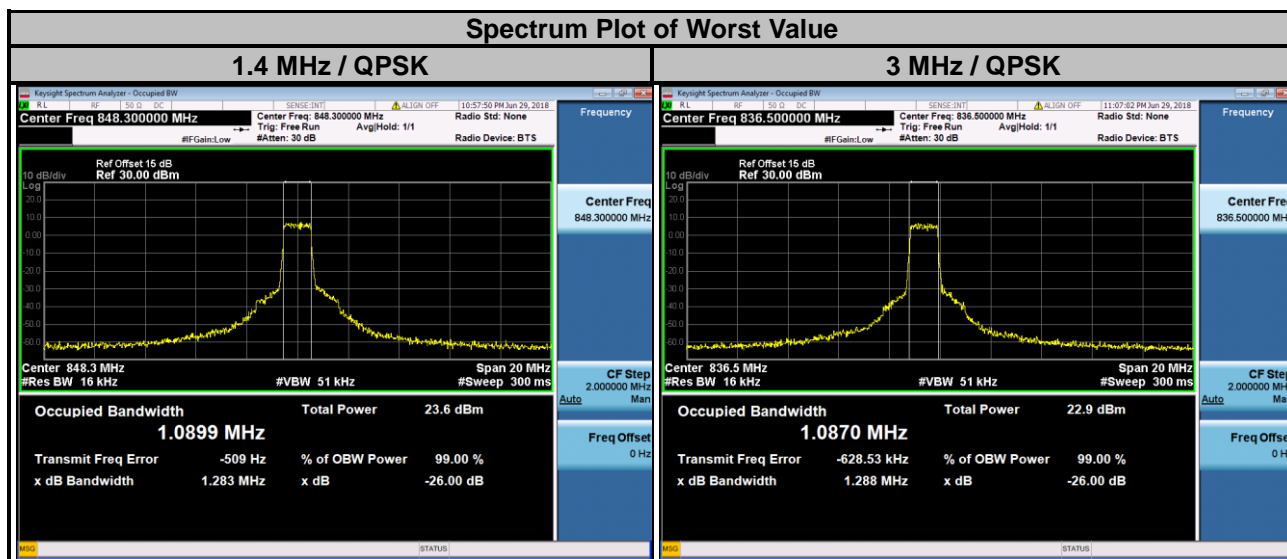

### LTE Band 5

Channel Bandwidth: 5 MHz				Channel Bandwidth: 10 MHz			
Channel	Frequency (MHz)	99 % Occupied Bandwidth (MHz)		Channel	Frequency (MHz)	99 % Occupied Bandwidth (MHz)	
		QPSK	16QAM			QPSK	16QAM
20425	826.5	1.083	0.915	20450	829.0	1.089	0.914
20525	836.5	1.084	0.912	20525	836.5	1.086	0.911
20625	846.5	1.079	0.912	20600	844.0	1.087	0.914

### Spectrum Plot of Worst Value

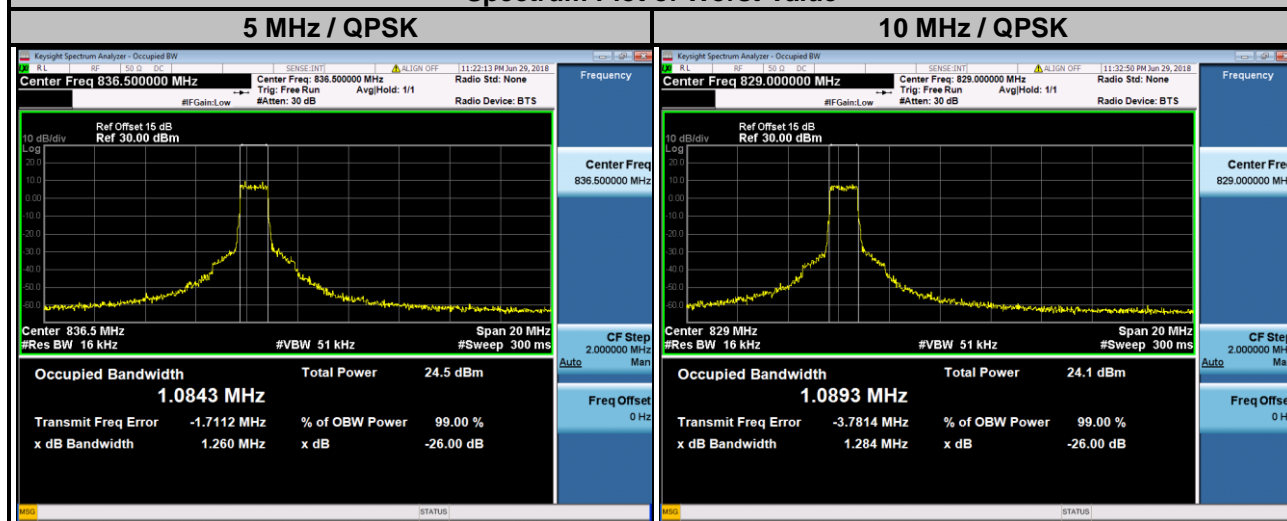

LTE Band 26							
Channel Bandwidth: 1.4 MHz				Channel Bandwidth: 3 MHz			
Channel	Frequency (MHz)	99 % Occupied Bandwidth (MHz)		Channel	Frequency (MHz)	99 % Occupied Bandwidth (MHz)	
		QPSK	16QAM			QPSK	16QAM
26797	824.7	1.090	0.914	26805	825.5	1.089	0.917
26915	836.5	1.088	0.911	26915	836.5	1.081	0.918
27033	848.3	1.087	0.910	27025	847.5	1.083	0.904

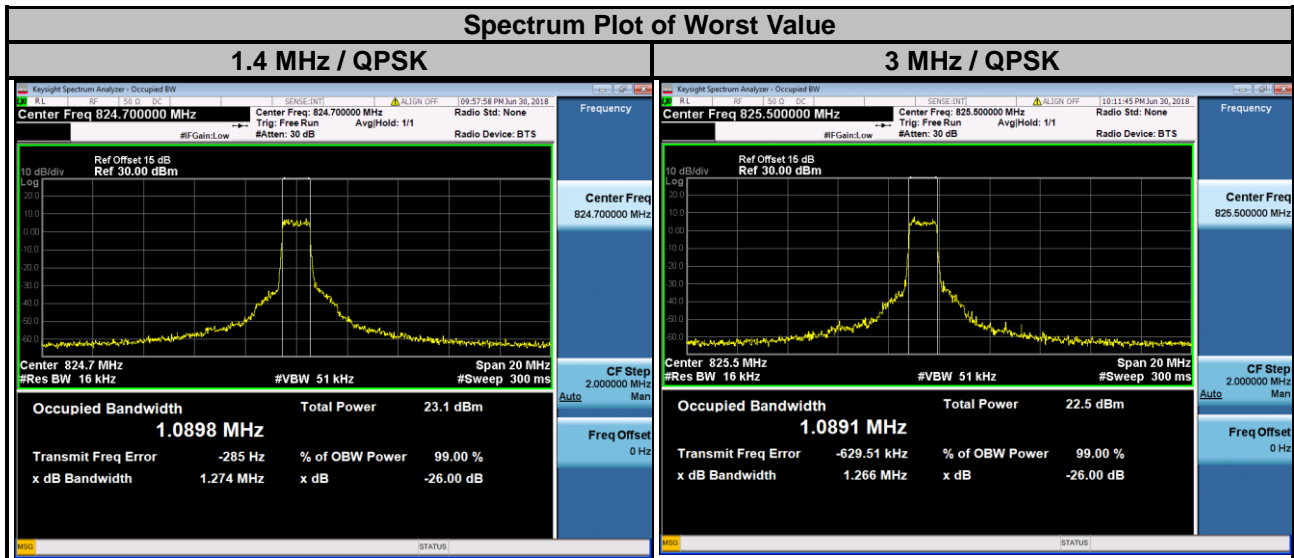



### LTE Band 26

Channel Bandwidth: 5 MHz				Channel Bandwidth: 10 MHz			
Channel	Frequency (MHz)	99 % Occupied Bandwidth (MHz)		Channel	Frequency (MHz)	99 % Occupied Bandwidth (MHz)	
		QPSK	16QAM			QPSK	16QAM
26815	826.5	1.083	0.907	26840	829.0	1.084	0.914
26915	836.5	1.078	0.910	26915	836.5	1.087	0.912
27015	846.5	1.077	0.911	26990	844.0	1.090	0.913

### Spectrum Plot of Worst Value

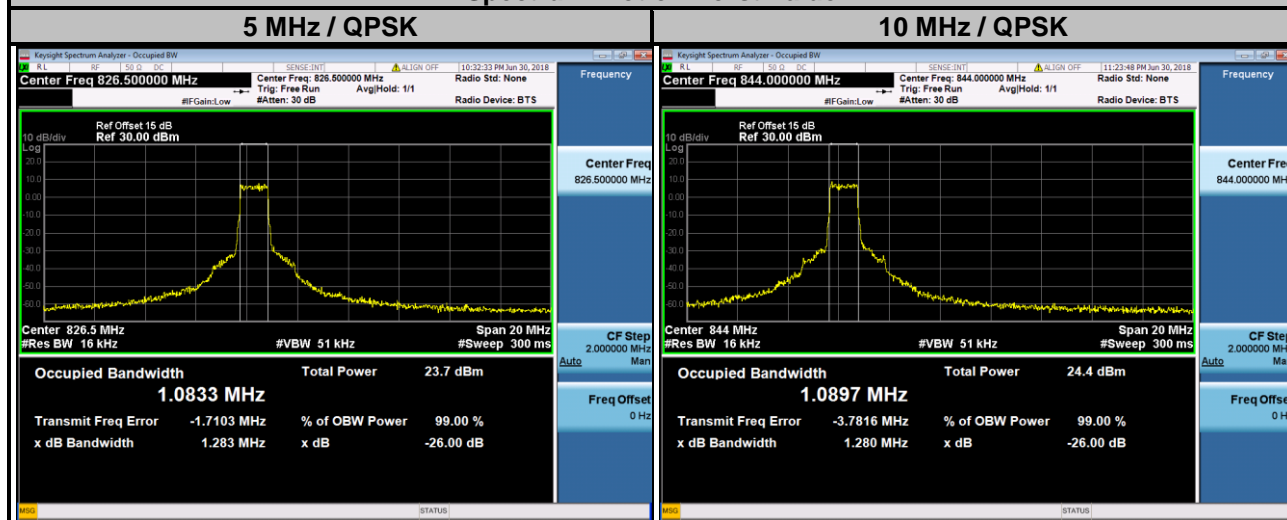

LTE Band 26			
Channel Bandwidth: 15 MHz			
Channel	Frequency (MHz)	99 % Occupied Bandwidth (MHz)	
		QPSK	16QAM
26865	831.5	1.085	0.914
26915	836.5	1.080	0.924
26965	841.5	1.092	0.919

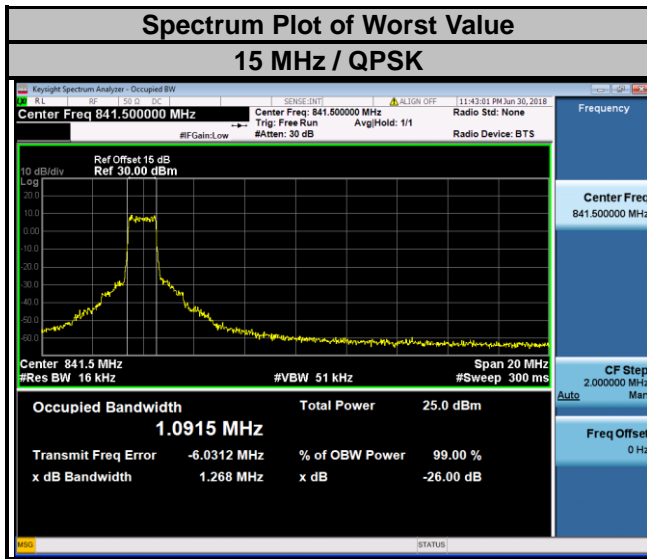

## 4.5 Band Edge Measurement

### 4.5.1 Limits of Band Edge Measurement

Power of any emission outside of the authorized operating frequency ranges must be attenuated below the transmitting power (P) by a factor of at least  $43 + 10 \log(P)$  dB. In the 1 MHz bands immediately outside and adjacent to the frequency block a resolution bandwidth of at least one percent of the emission bandwidth of the fundamental emission of the transmitter may be employed.

### 4.5.2 Test Setup

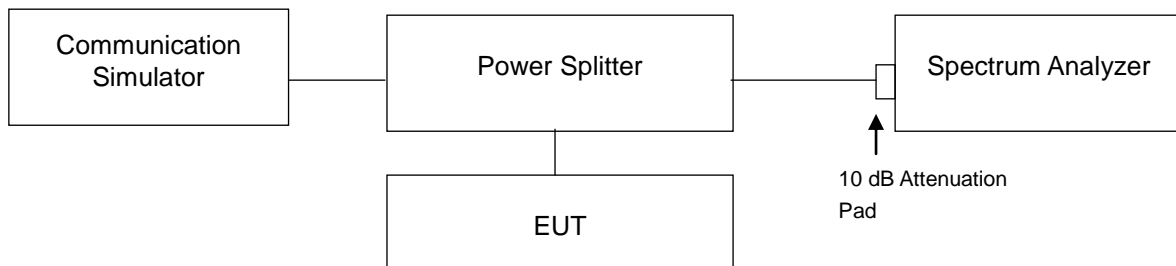

### 4.5.3 Test Procedures

- All measurements were done at low and high operational frequency range.
- The center frequency of spectrum is the band edge frequency and span is 1 MHz. RB of the spectrum is 30 kHz and VB of the spectrum is 100 kHz (LTE Bandwidth 1.4 MHz).
- The center frequency of spectrum is the band edge frequency and span is 1 MHz. RB of the spectrum is 62 kHz and VB of the spectrum is 200 kHz (LTE Bandwidth 3 MHz).
- The center frequency of spectrum is the band edge frequency and span is 1 MHz. RB of the spectrum is 100 kHz and VB of the spectrum is 300 kHz (LTE Bandwidth 5 MHz).
- The center frequency of spectrum is the band edge frequency and span is 1 MHz. RB of the spectrum is 200 kHz and VB of the spectrum is 1 MHz (LTE Bandwidth 10 MHz).
- The center frequency of spectrum is the band edge frequency and span is 1 MHz. RB of the spectrum is 300 kHz and VB of the spectrum is 1 MHz (LTE Bandwidth 15 MHz).
- Record the max trace plot into the test report.

### 4.5.4 Test Results

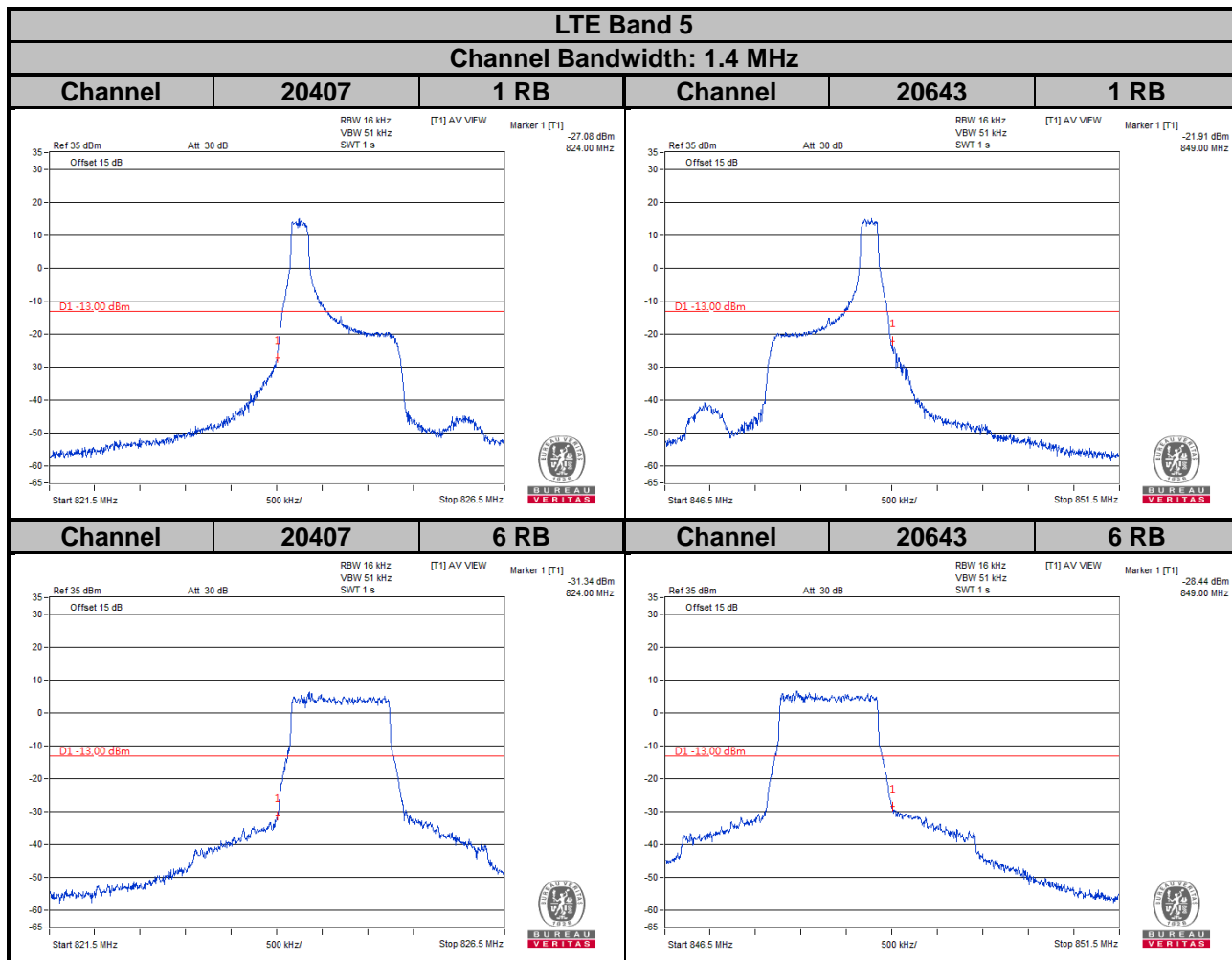

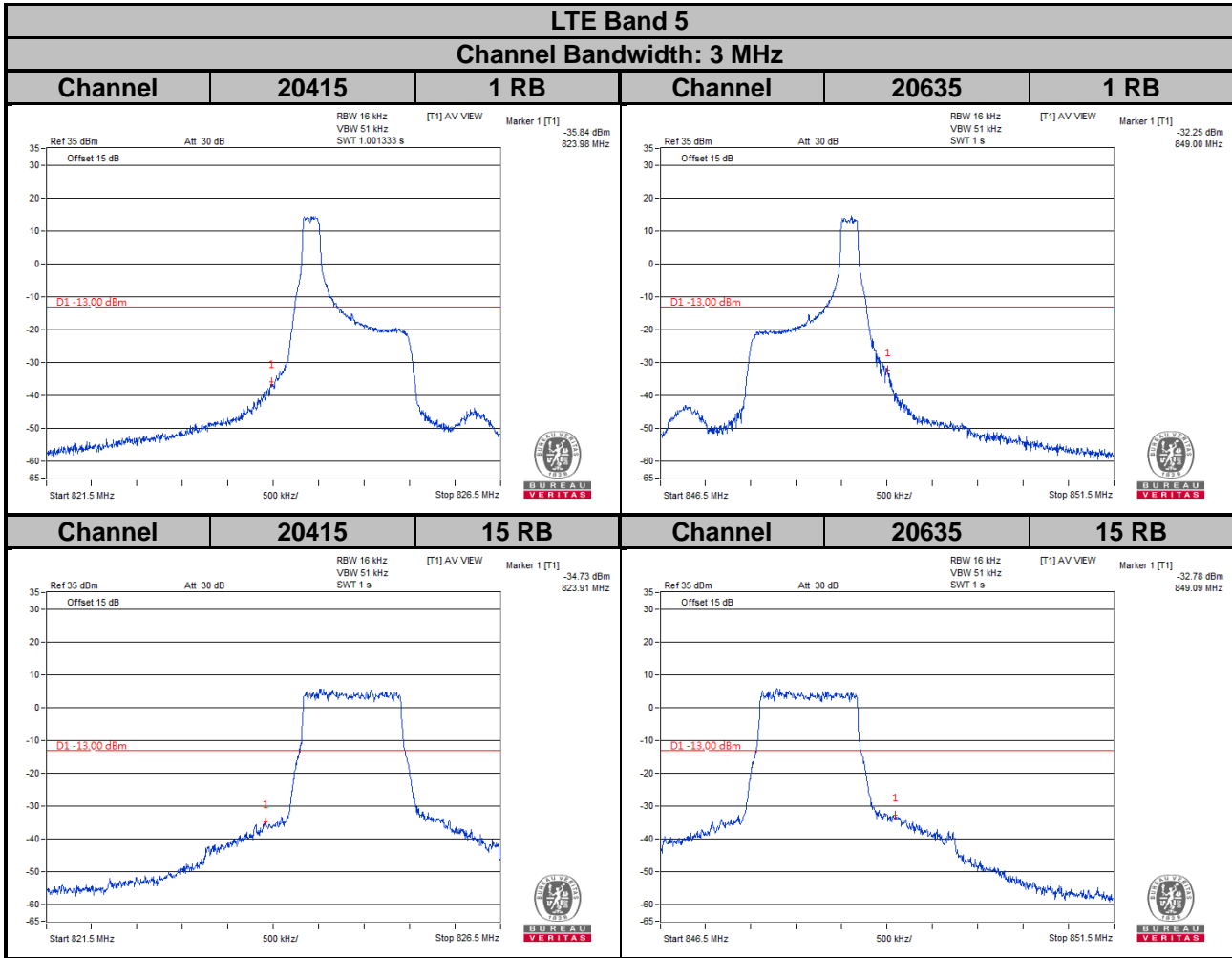

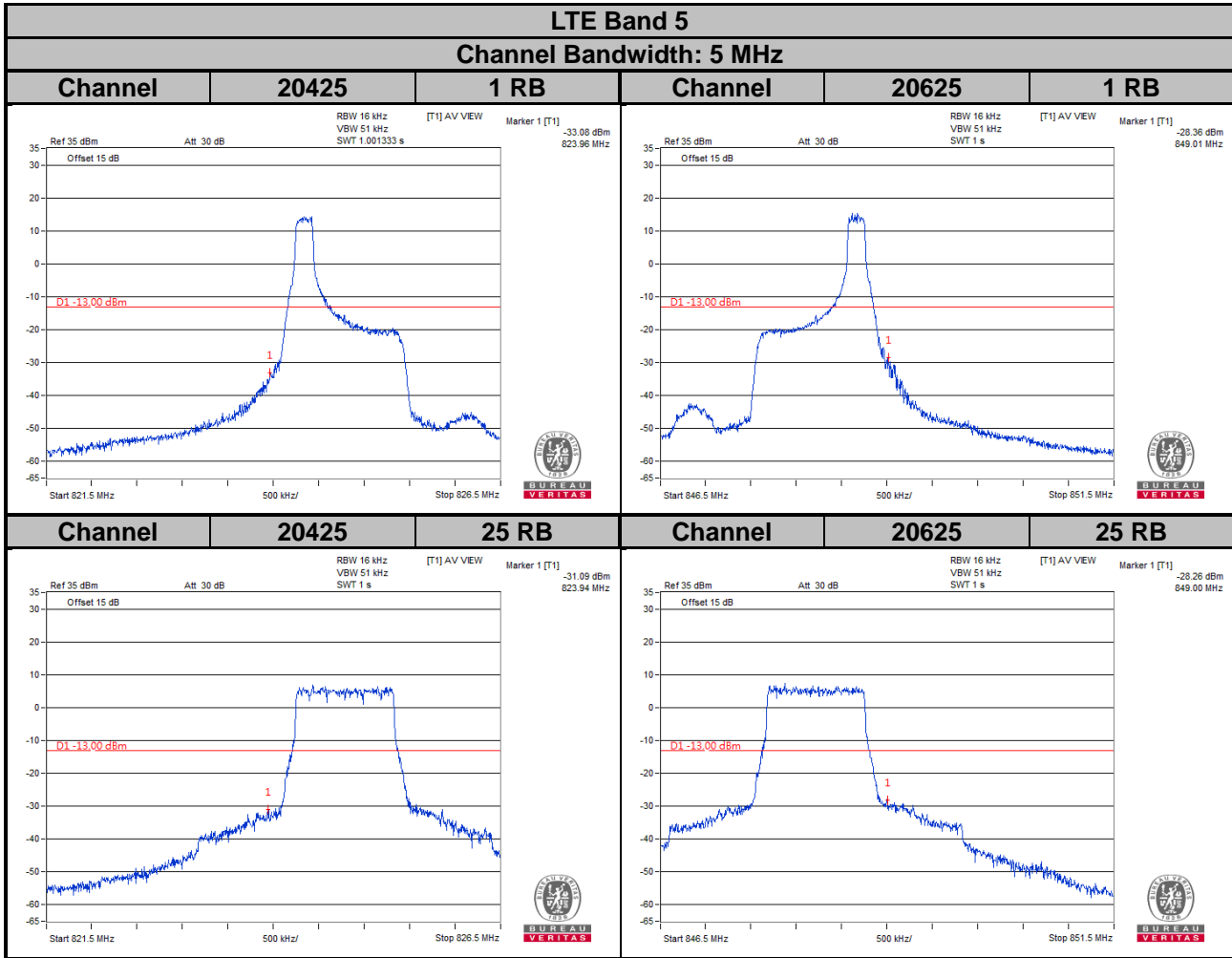

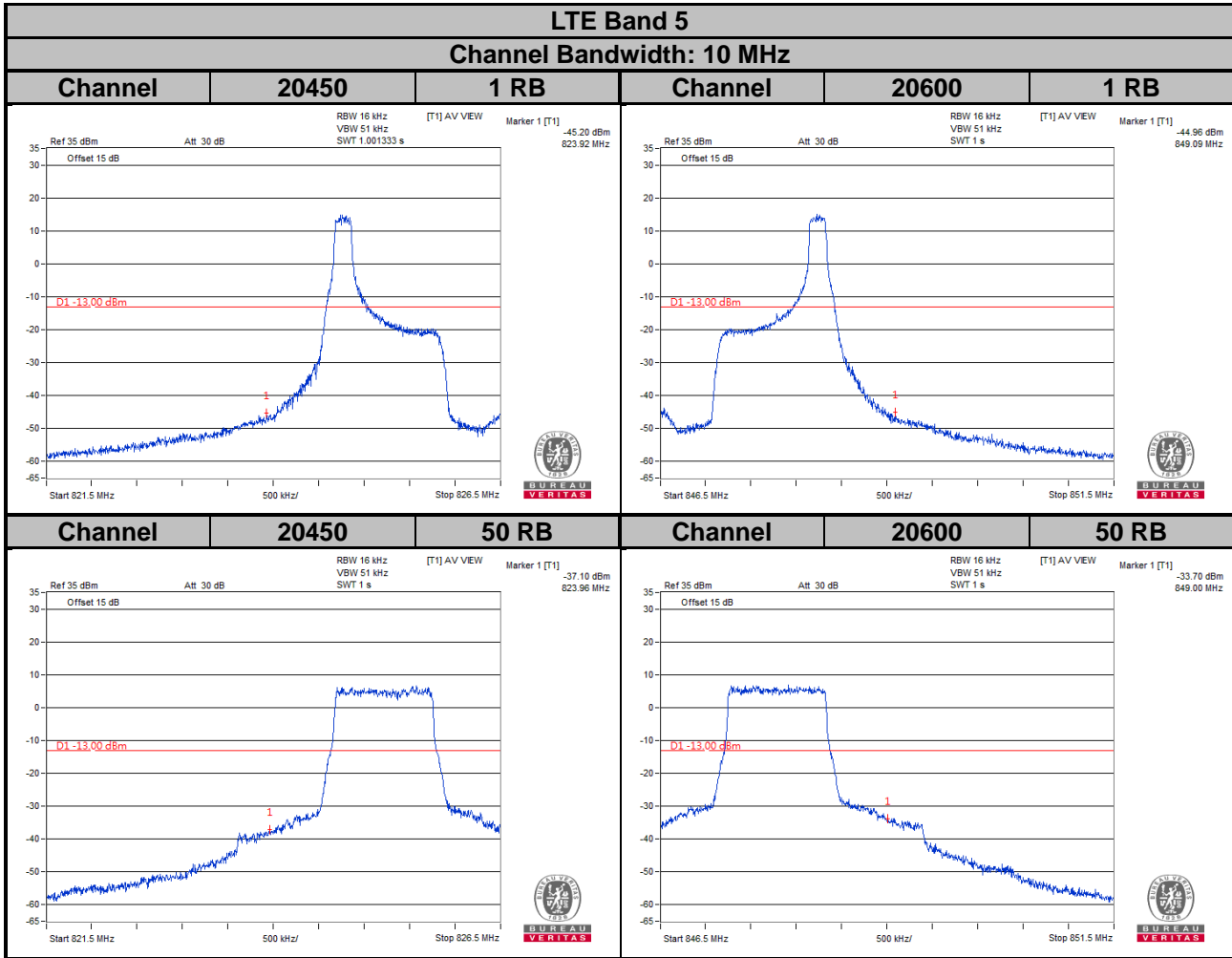

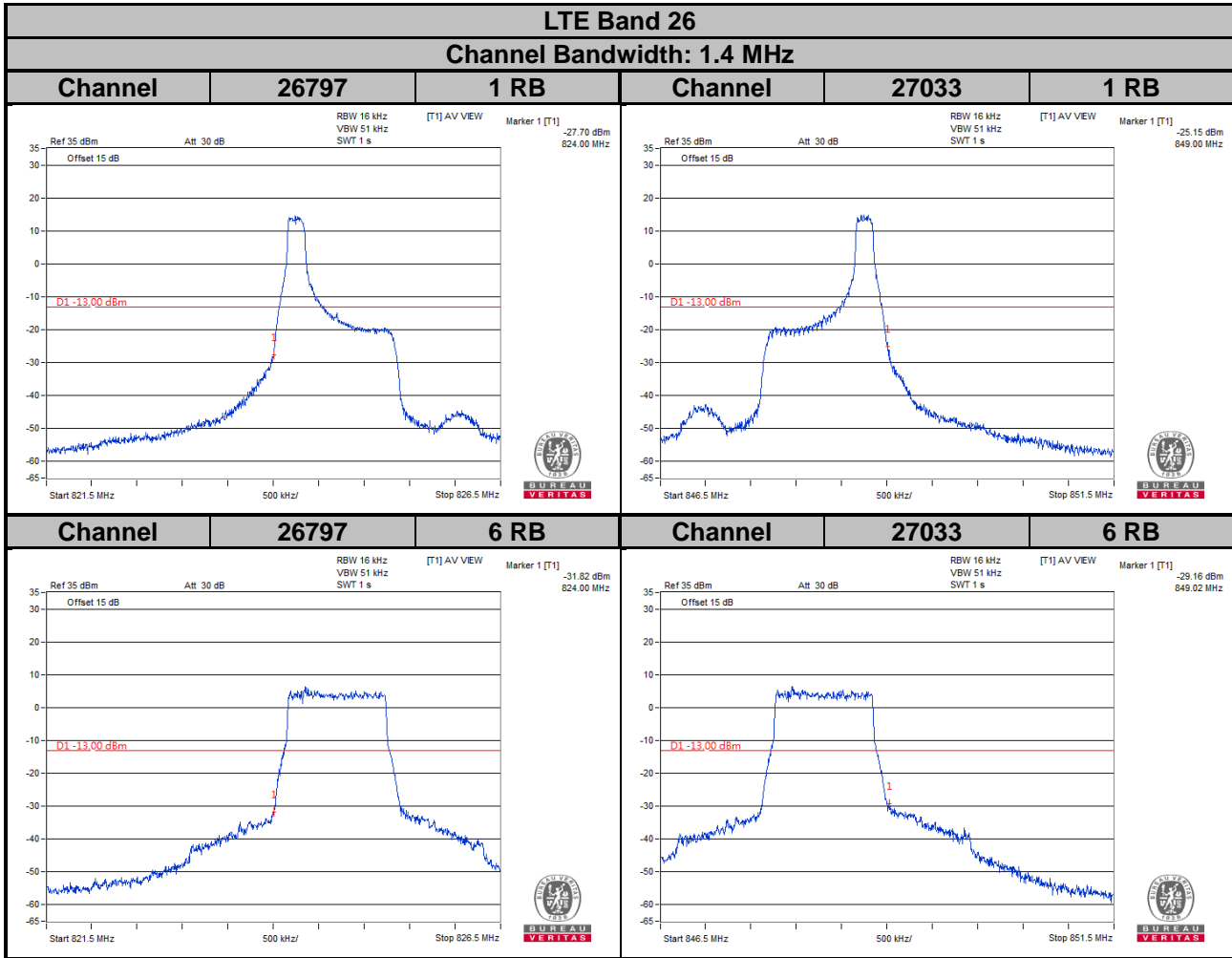



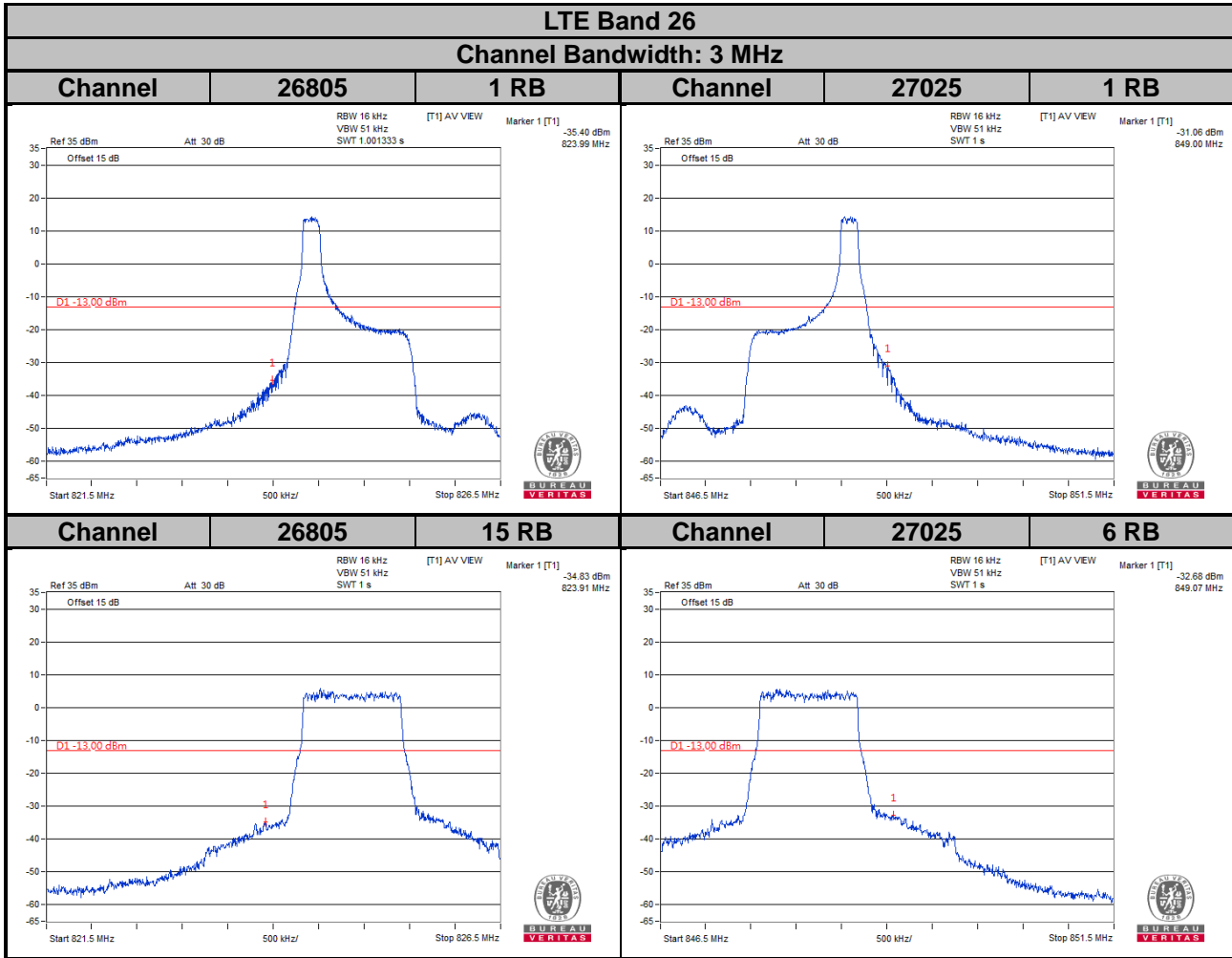

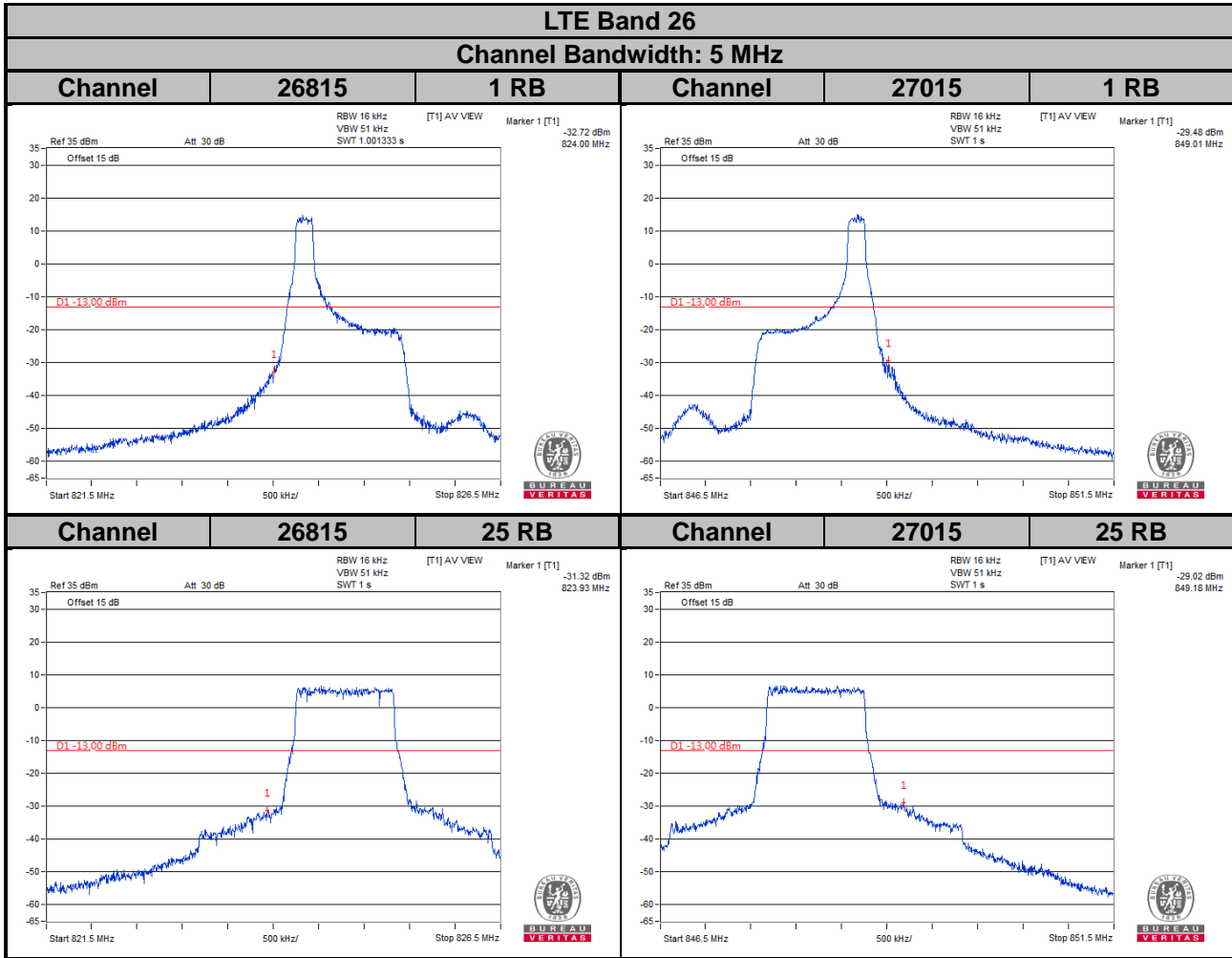

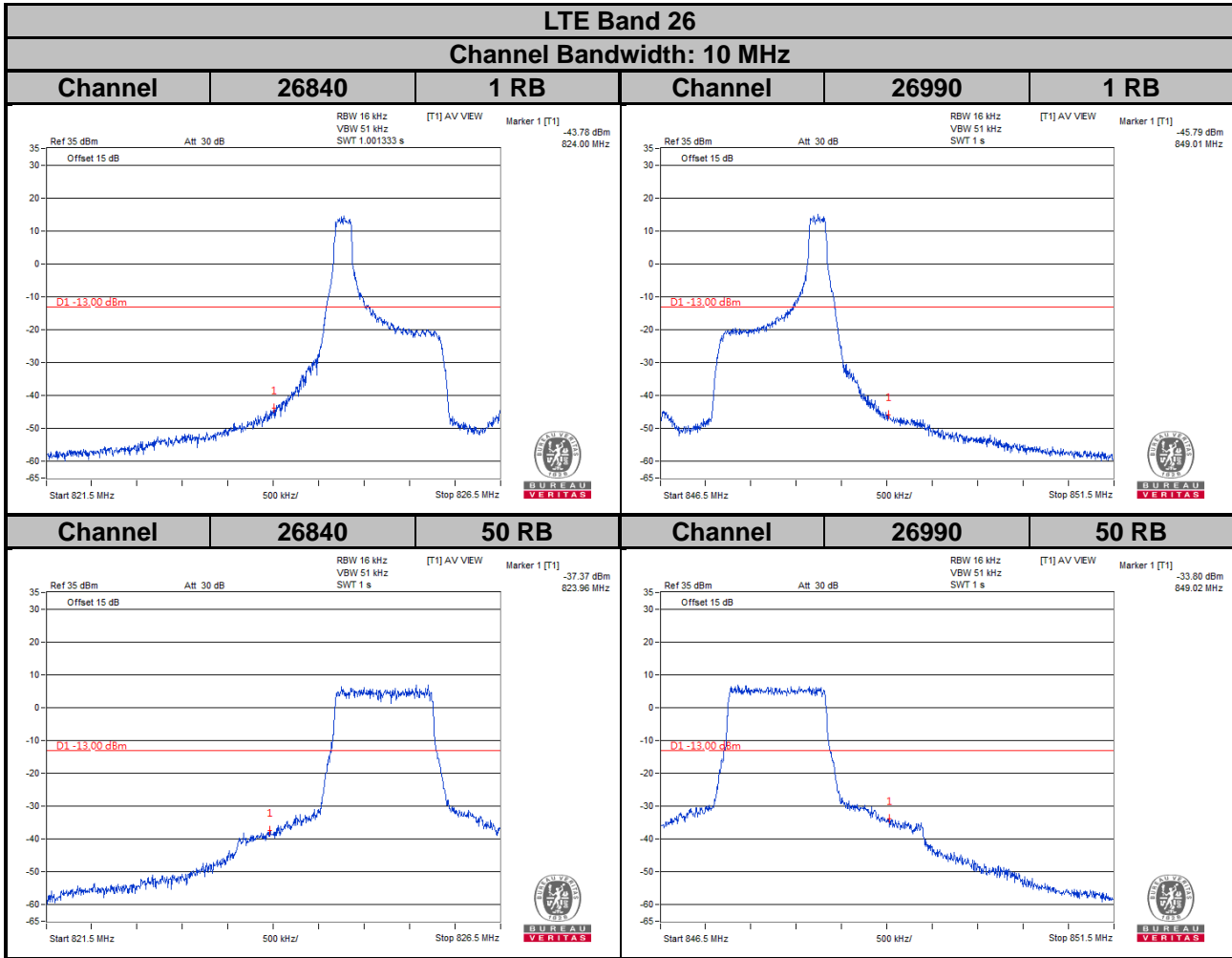

**LTE Band 26**  
**Channel Bandwidth: 15 MHz**

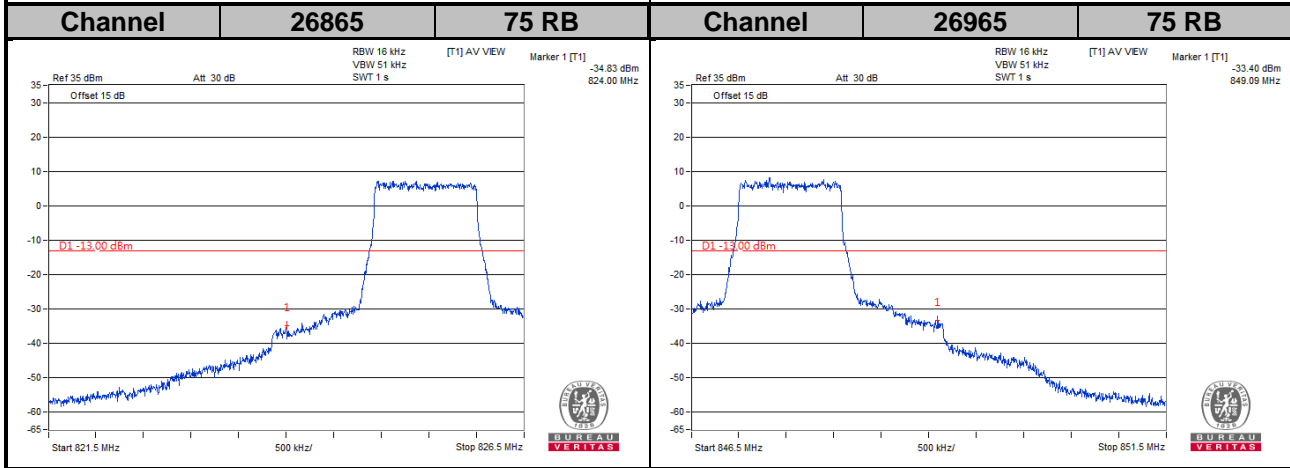
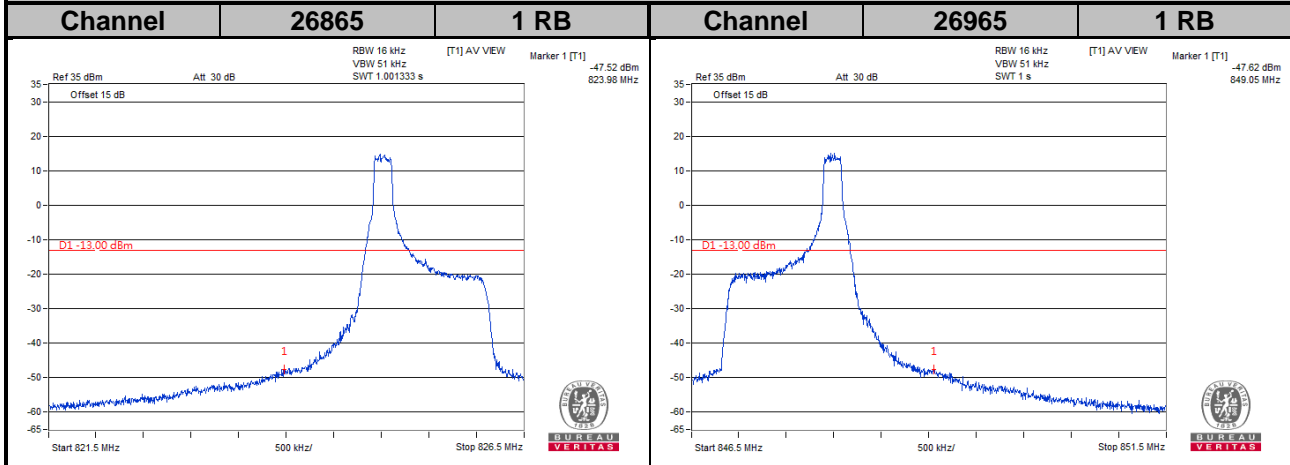

## 4.6 Peak to Average Ratio

### 4.6.1 Limits of Peak to Average Ratio Measurement

In measuring transmissions in this band using an average power technique, the peak to-average ratio (PAR) of the transmission may not exceed 13 dB.

### 4.6.2 Test Setup

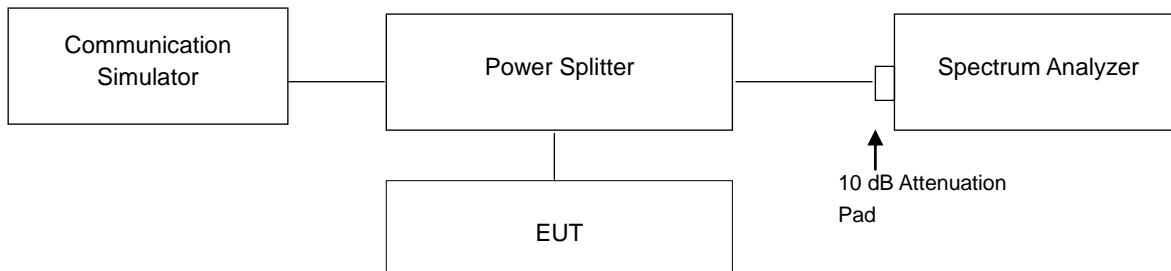

### 4.6.3 Test Procedures

1. Set resolution/measurement bandwidth  $\geq$  signal's occupied bandwidth;
2. Set the number of counts to a value that stabilizes the measured CCDF curve;
3. Record the maximum PAPR level associated with a probability of 0.1 %.

#### 4.6.4 Test Results

LTE Band 5							
Channel Bandwidth: 1.4 MHz				Channel Bandwidth: 3 MHz			
Channel	Frequency (MHz)	Peak to Average Ratio (dB)		Channel	Frequency (MHz)	Peak to Average Ratio (dB)	
		QPSK	16QAM			QPSK	16QAM
20407	824.7	6.42	6.39	20415	825.5	6.45	6.30
20525	836.5	6.45	6.42	20525	836.5	6.48	6.41
20643	848.3	6.37	6.37	20635	847.5	6.61	6.63

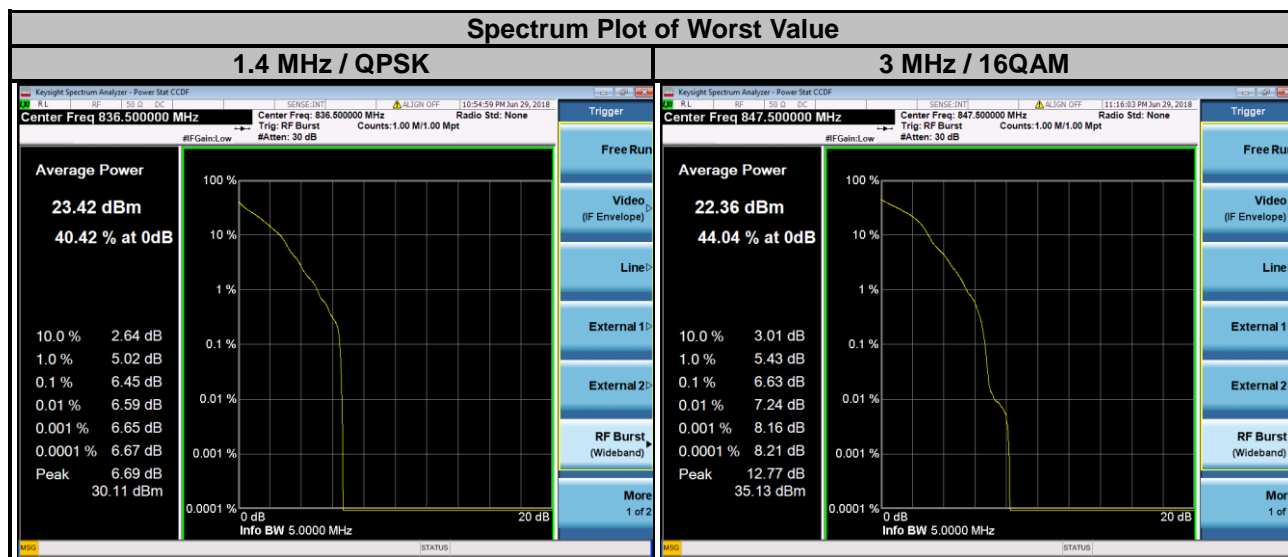

### LTE Band 5

Channel Bandwidth: 5 MHz				Channel Bandwidth: 10 MHz			
Channel	Frequency (MHz)	Peak to Average Ratio (dB)		Channel	Frequency (MHz)	Peak to Average Ratio (dB)	
		QPSK	16QAM			QPSK	16QAM
20425	826.5	6.30	6.48	20450	829.0	6.51	6.75
20525	836.5	6.42	6.45	20525	836.5	6.75	6.68
20625	846.5	6.44	6.65	20600	844.0	6.56	6.77

### Spectrum Plot of Worst Value

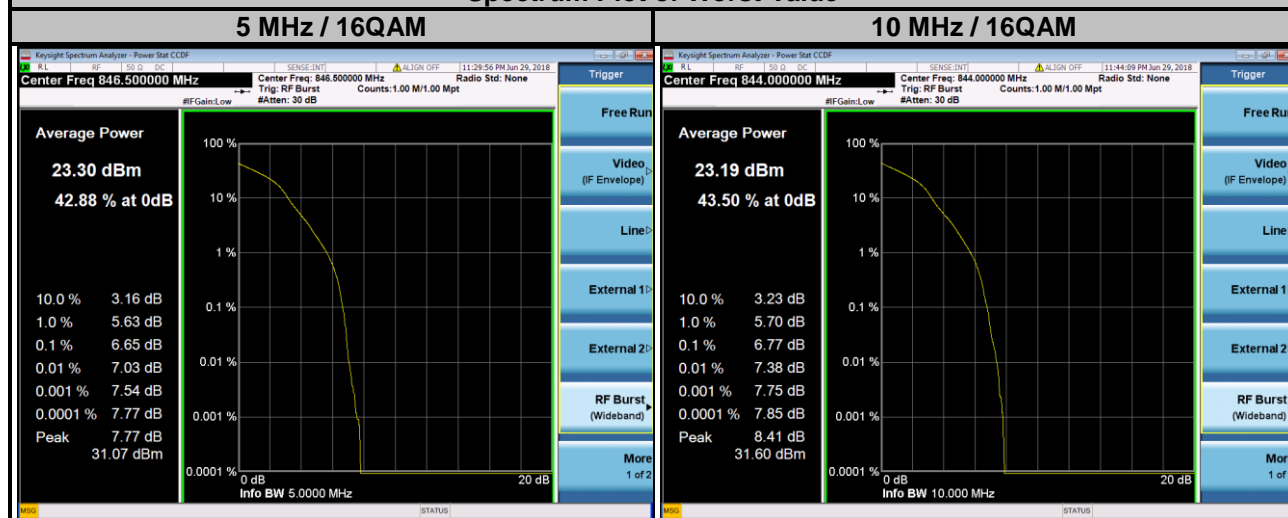

LTE Band 26							
Channel Bandwidth: 1.4 MHz				Channel Bandwidth: 3 MHz			
Channel	Frequency (MHz)	Peak to Average Ratio (dB)		Channel	Frequency (MHz)	Peak to Average Ratio (dB)	
		QPSK	16QAM			QPSK	16QAM
26797	824.7	6.60	6.26	26805	825.5	6.62	6.26
26915	836.5	6.63	6.38	26915	836.5	6.62	6.37
27033	848.3	6.61	6.47	27025	847.5	6.88	6.48

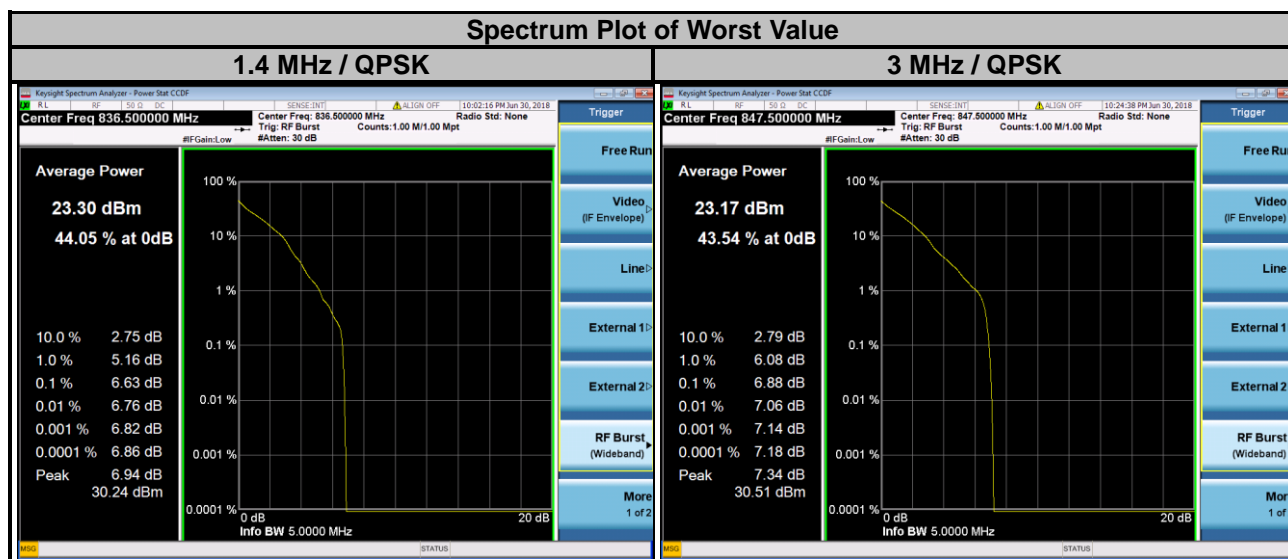



LTE Band 26							
Channel Bandwidth: 5 MHz				Channel Bandwidth: 10 MHz			
Channel	Frequency (MHz)	Peak to Average Ratio (dB)		Channel	Frequency (MHz)	Peak to Average Ratio (dB)	
		QPSK	16QAM			QPSK	16QAM
26815	826.5	6.34	6.42	26840	829.0	7.11	6.94
26915	836.5	6.72	6.89	26915	836.5	7.58	6.80
27015	846.5	6.76	6.85	26990	844.0	7.79	7.81

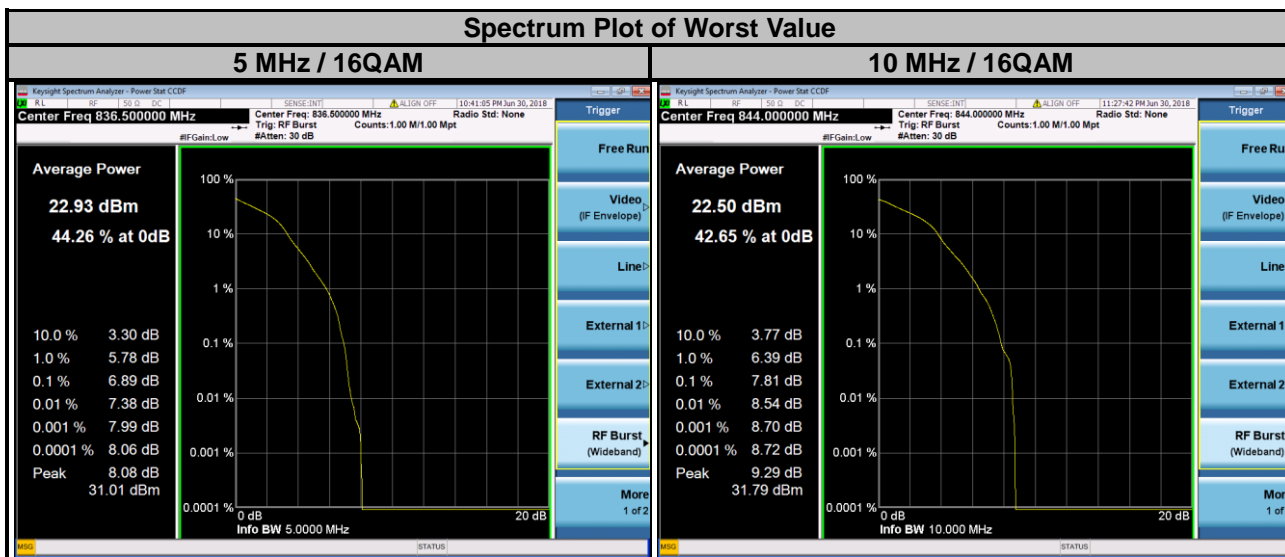

LTE Band 26			
Channel Bandwidth: 15 MHz			
Channel	Frequency (MHz)	Peak to Average Ratio (dB)	
		QPSK	16QAM
26865	831.5	8.16	8.37
26915	836.5	7.72	6.77
26965	841.5	7.42	7.96

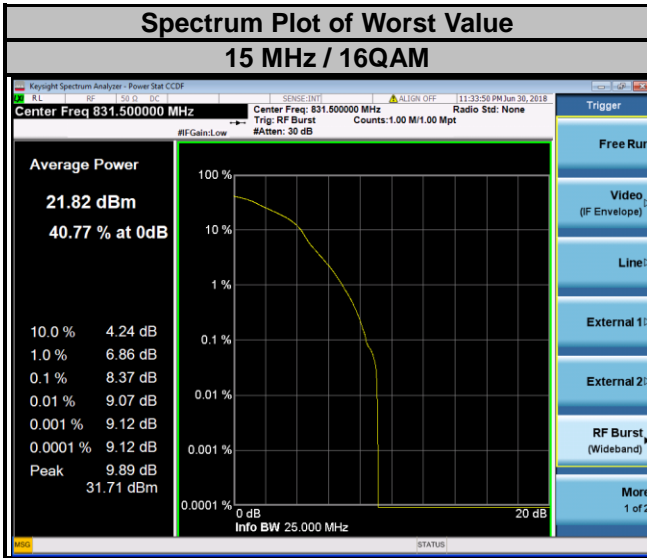

## 4.7 Conducted Spurious Emissions

### 4.7.1 Limits of Conducted Spurious Emissions Measurement

The power of any emission outside of the authorized operating frequency ranges must be attenuated below the transmitting power (P) by a factor of at least  $43 + 10 \log(P)$  dB. The emission limit equal to -13 dBm.

### 4.7.2 Test Setup

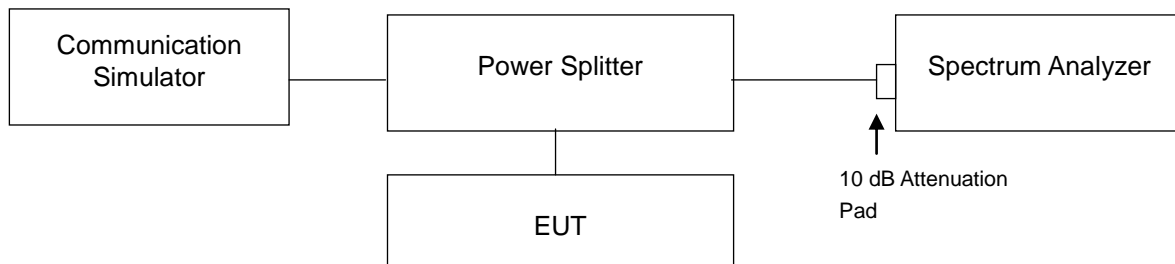

### 4.7.3 Test Procedure

- The EUT makes a phone call to the communication simulator. All measurements were done at low, middle and high operational frequency range.
- Measuring frequency range is from 9 kHz to 10 GHz. 20 dB attenuation pad is connected with spectrum. RBW = 1 MHz and VBW = 3 MHz is used for conducted emission measurement.

### 4.7.4 Test Results

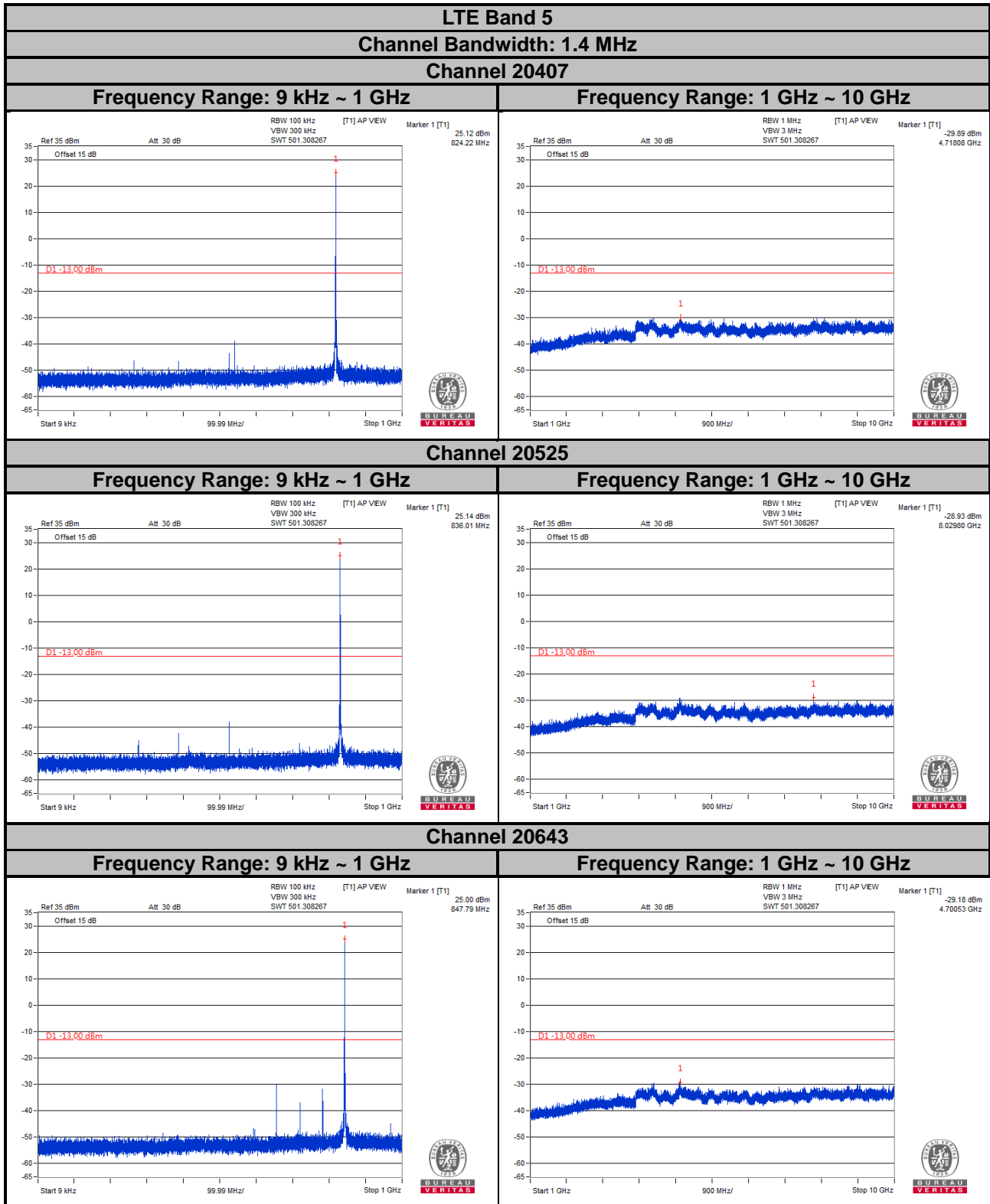

**LTE Band 5**  
**Channel Bandwidth: 3 MHz**

**Channel 20415**

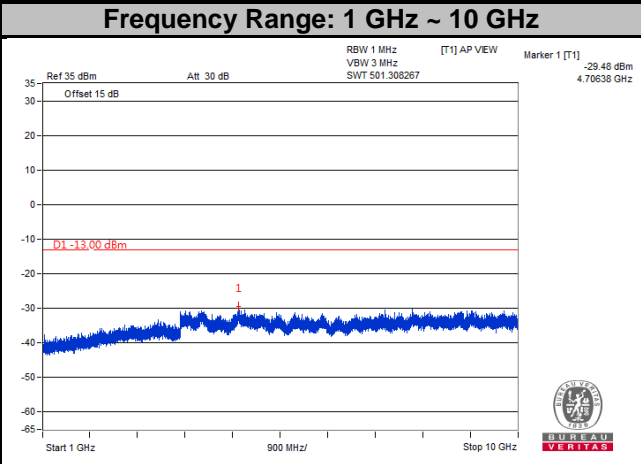
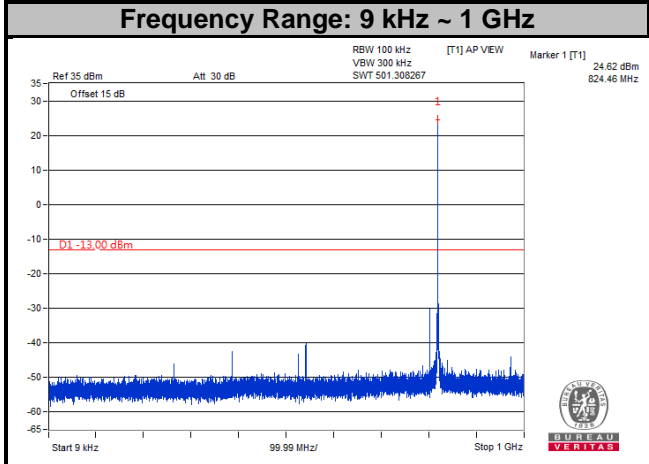

**Channel 20525**

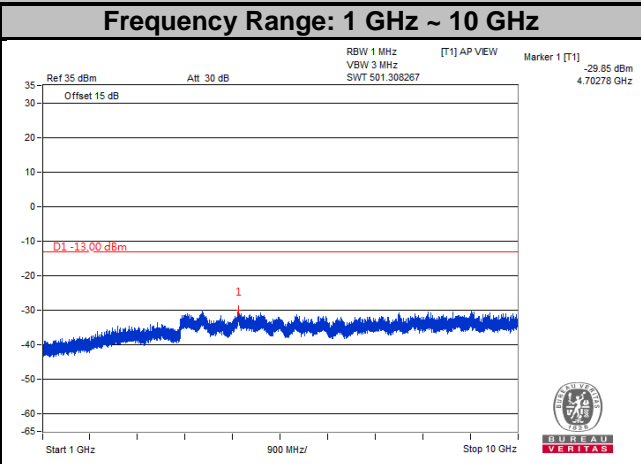
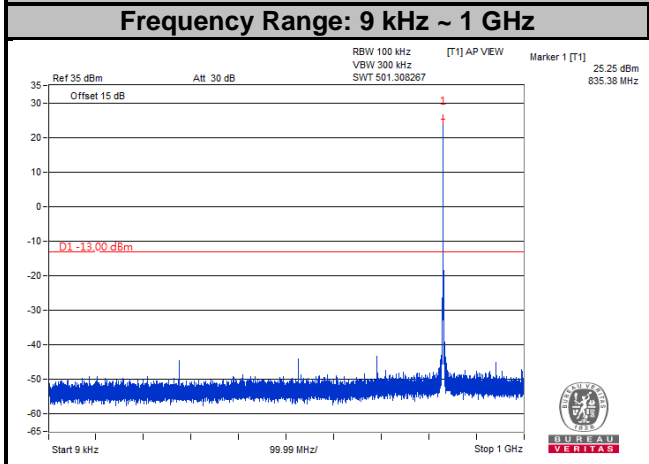

**Channel 20635**

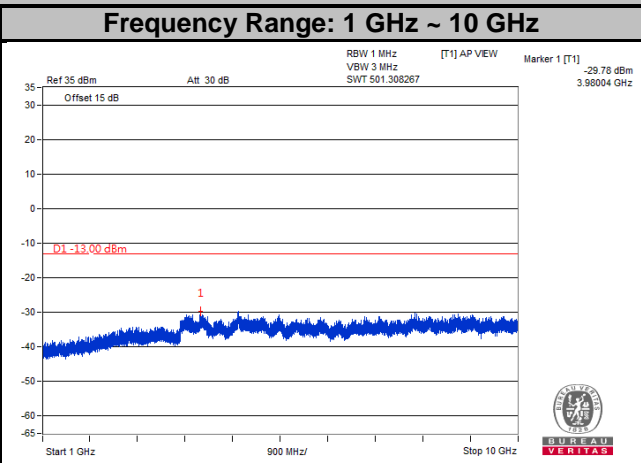
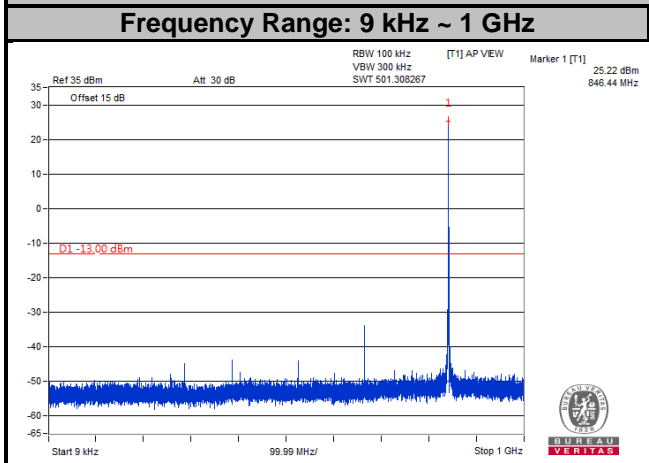

**LTE Band 5**  
**Channel Bandwidth: 5 MHz**  
**Channel 20425**

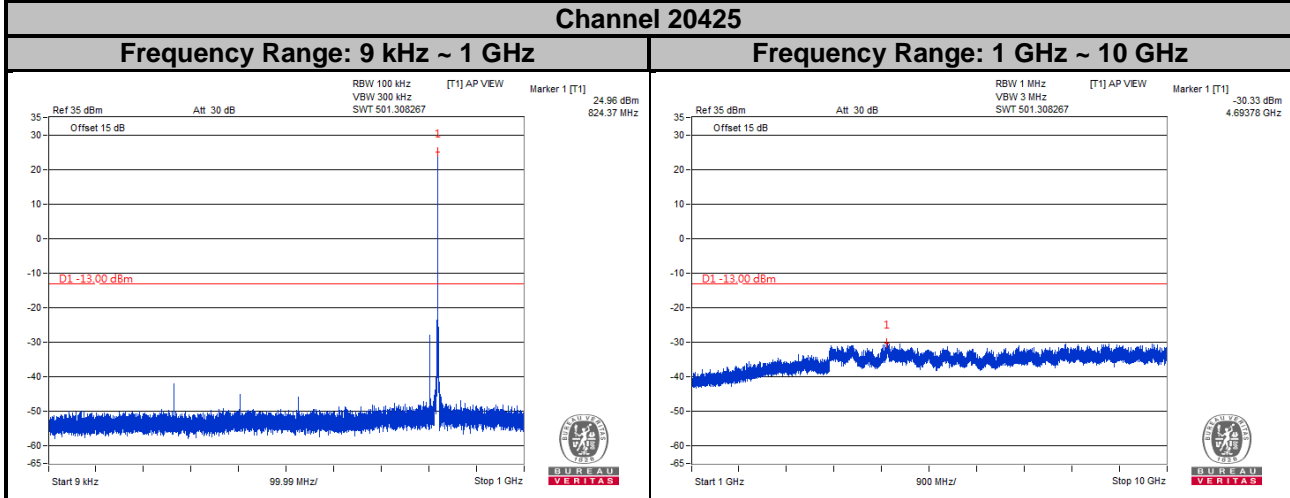

**Channel 20525**

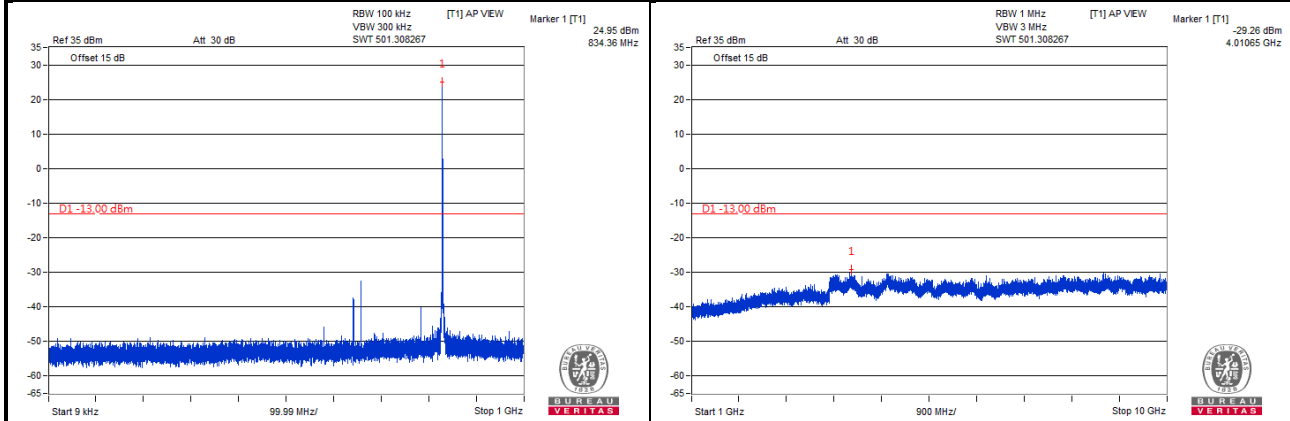

**Channel 20625**

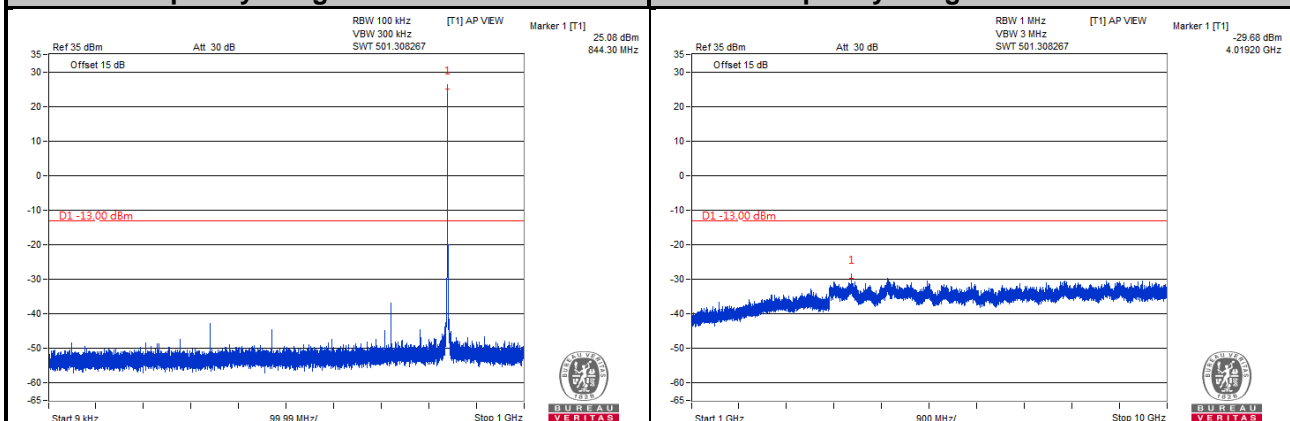

**LTE Band 5**  
**Channel Bandwidth: 10 MHz**

**Channel 20450**

**Frequency Range: 9 kHz ~ 1 GHz**

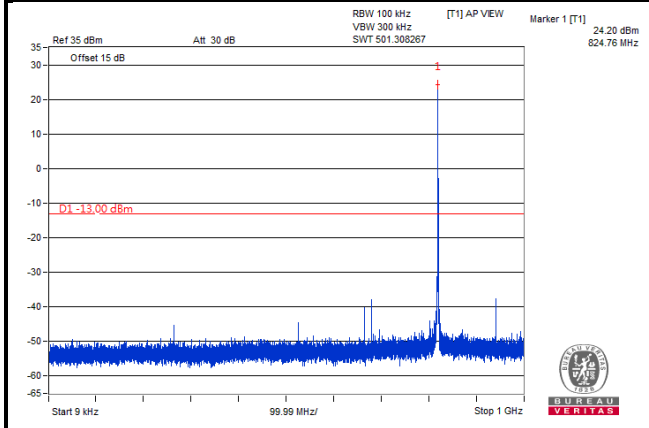

**Frequency Range: 1 GHz ~ 10 GHz**

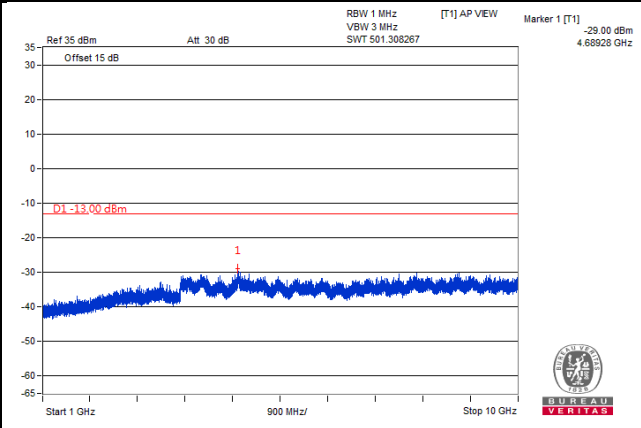

**Channel 20525**

**Frequency Range: 9 kHz ~ 1 GHz**

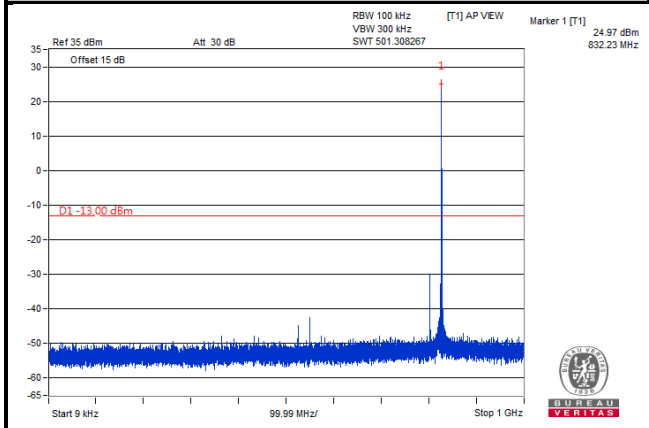

**Frequency Range: 1 GHz ~ 10 GHz**

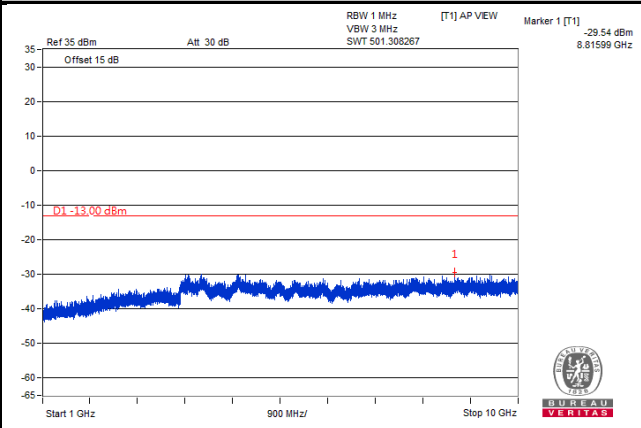

**Channel 20600**

**Frequency Range: 9 kHz ~ 1 GHz**

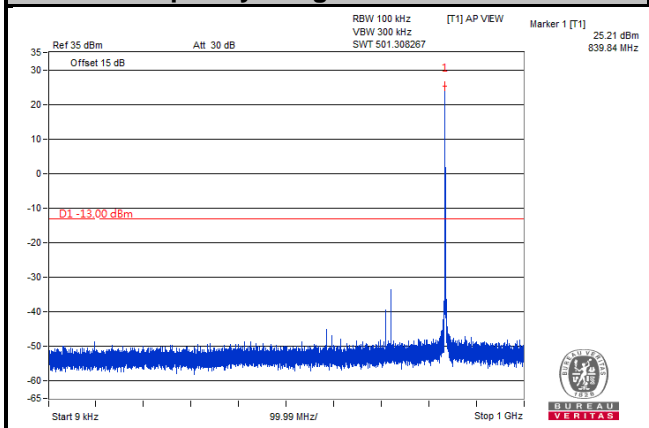

**Frequency Range: 1 GHz ~ 10 GHz**

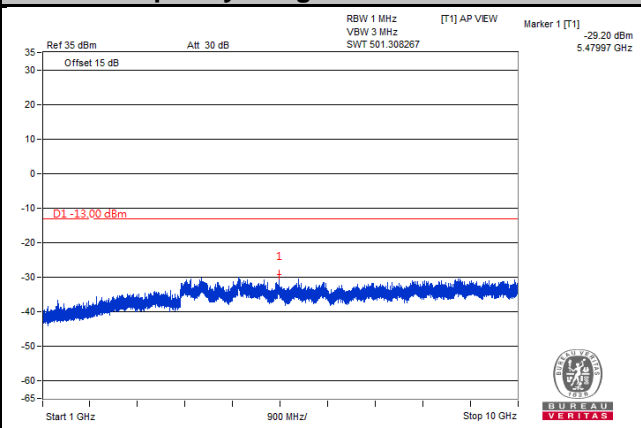

**LTE Band 26**  
**Channel Bandwidth: 1.4 MHz**  
**Channel 26797**

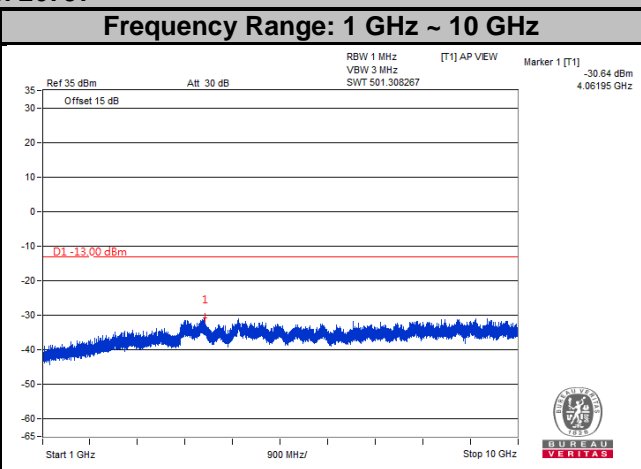
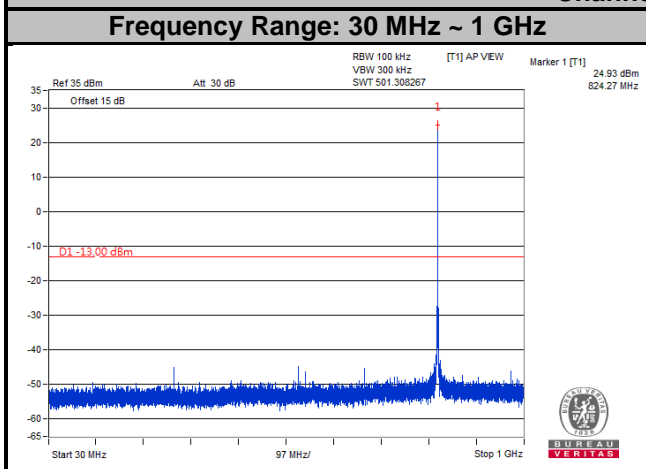

**Channel 26915**

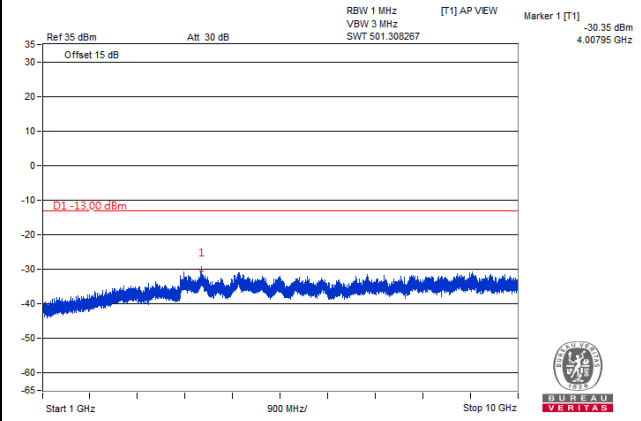
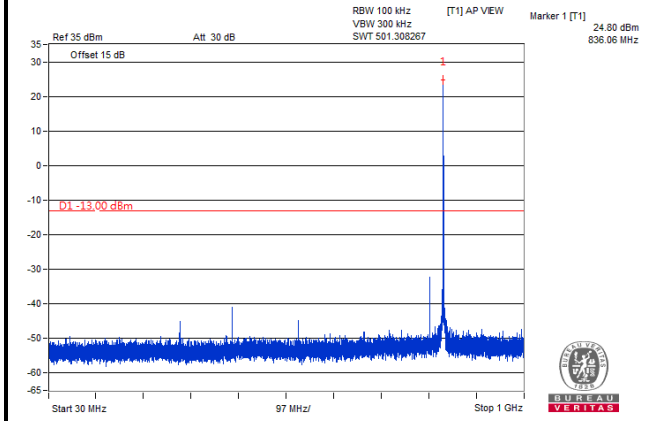

**Channel 27033**

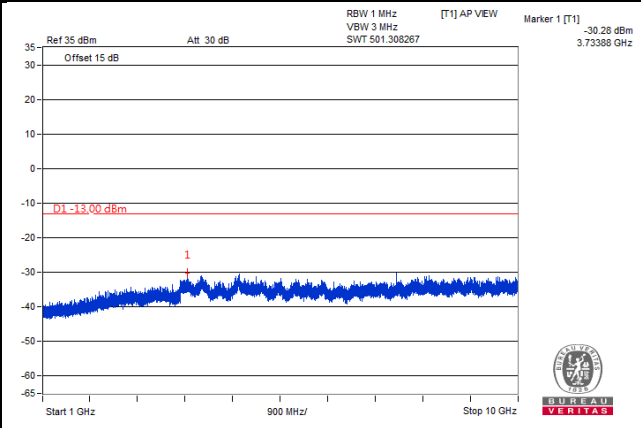
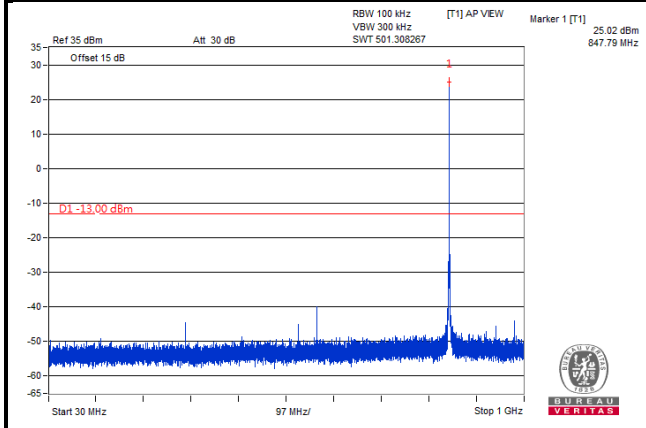



**LTE Band 26**

**Channel Bandwidth: 3 MHz**

**Channel 26805**

**Frequency Range: 30 MHz ~ 1 GHz**

**Frequency Range: 1 GHz ~ 10 GHz**

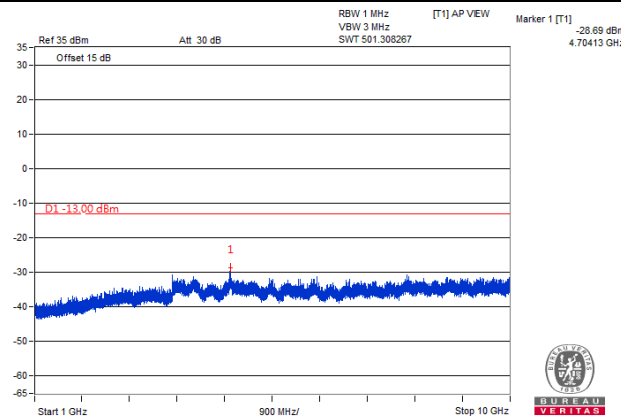
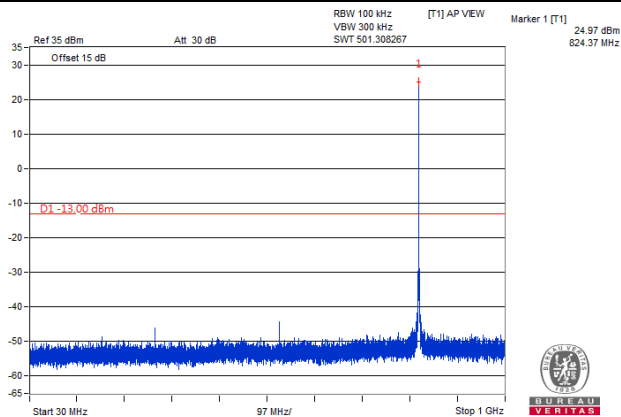

**Channel 26915**

**Frequency Range: 30 MHz ~ 1 GHz**

**Frequency Range: 1 GHz ~ 10 GHz**

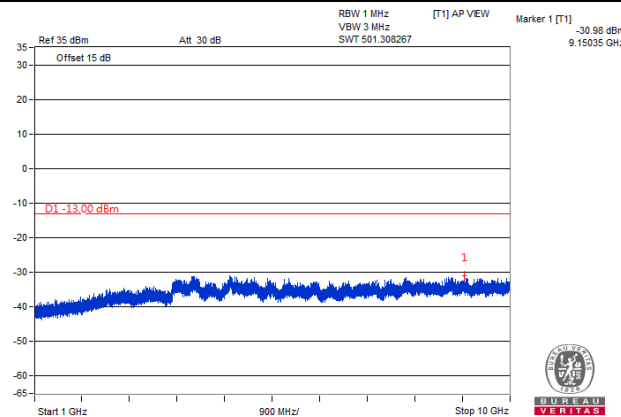
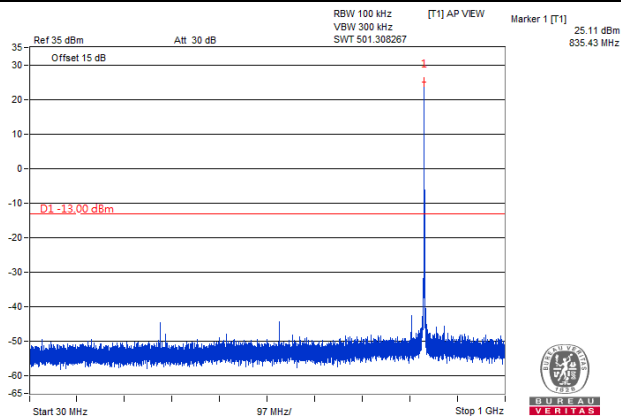

**Channel 27025**

**Frequency Range: 30 MHz ~ 1 GHz**

**Frequency Range: 1 GHz ~ 10 GHz**

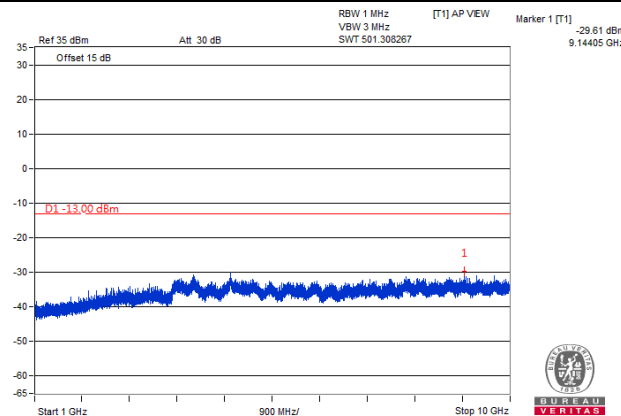
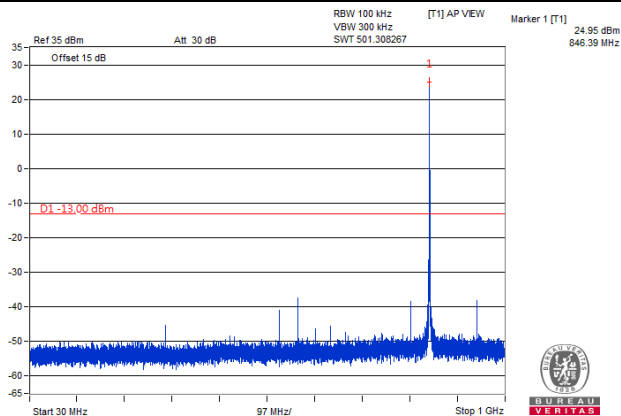

**LTE Band 26**  
**Channel Bandwidth: 5 MHz**  
**Channel 26815**

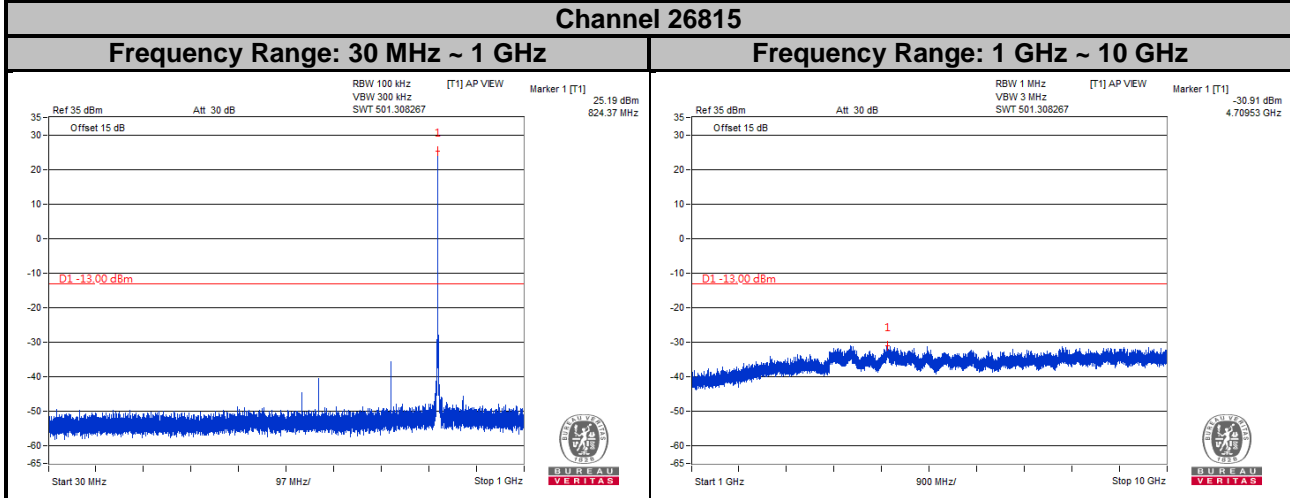

**Channel 26915**

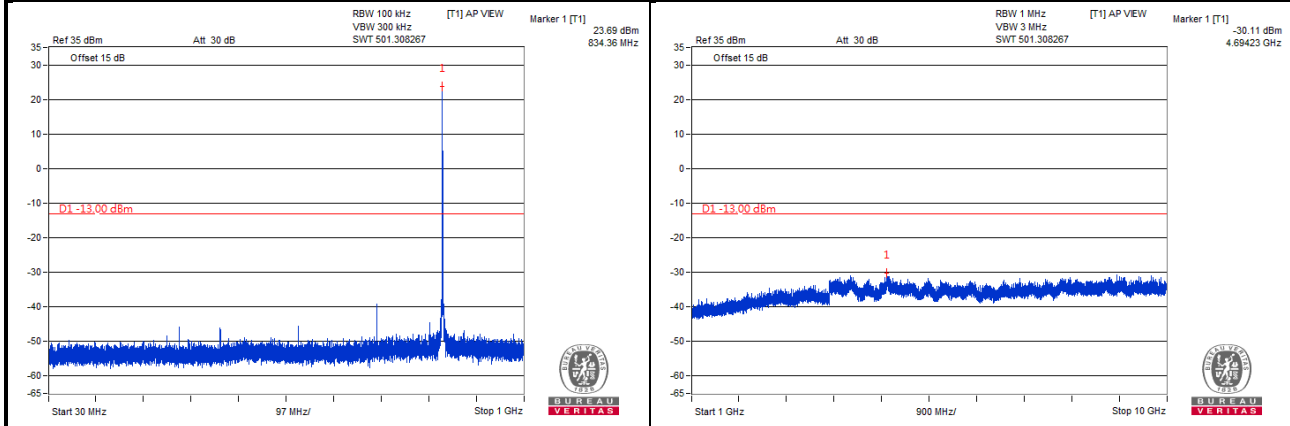

**Channel 27015**

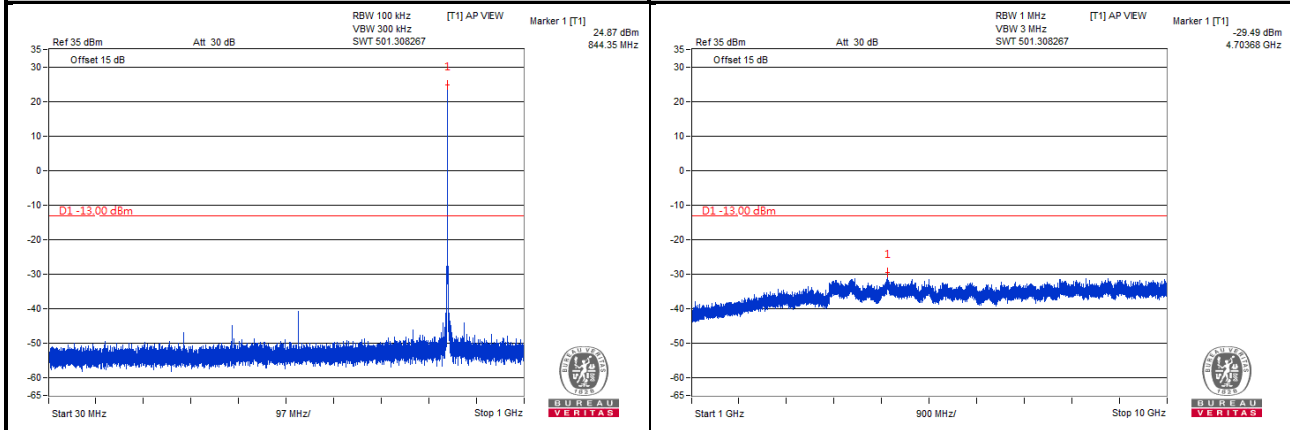

**LTE Band 26**  
**Channel Bandwidth: 10 MHz**

**Channel 26840**

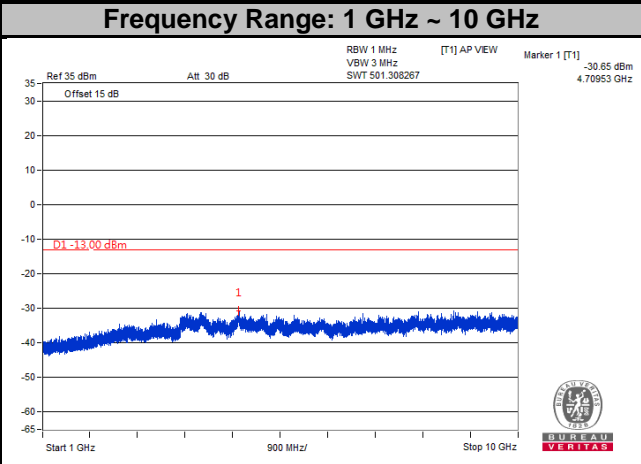
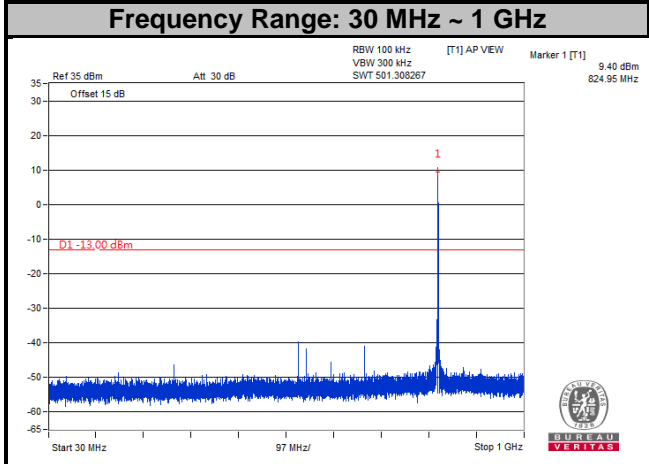

**Channel 26915**

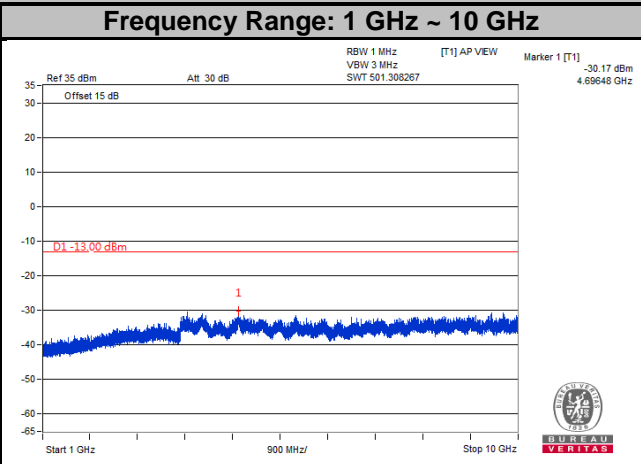
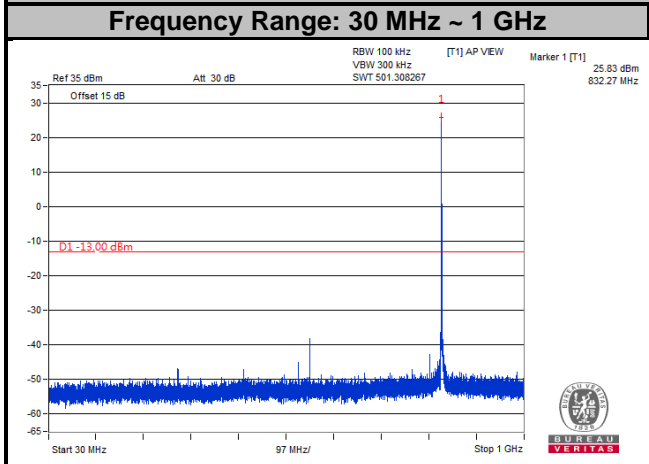

**Channel 26990**

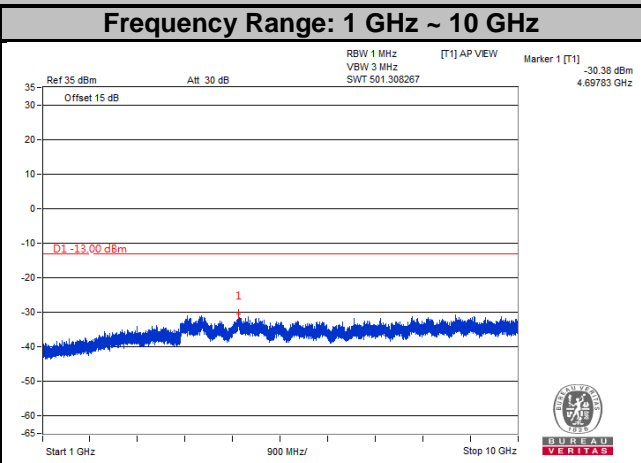
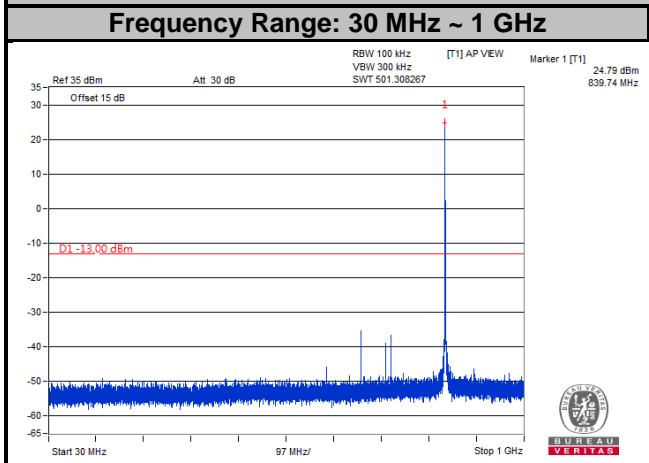

**LTE Band 26**  
**Channel Bandwidth: 15 MHz**  
**Channel 26865**

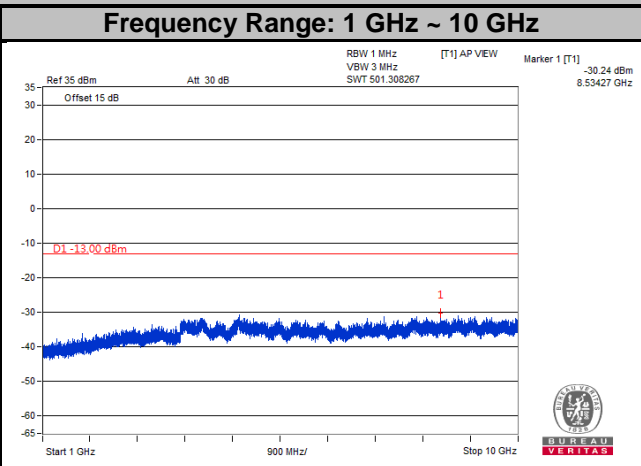
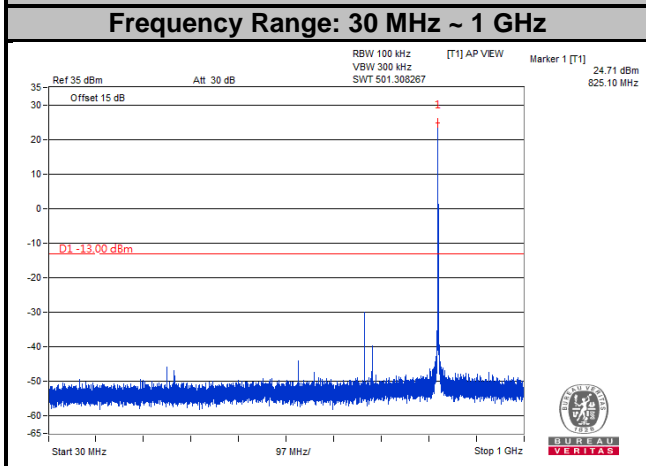

**Channel 26915**

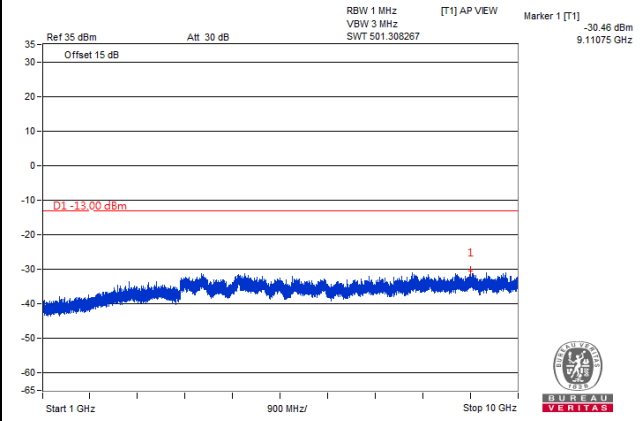
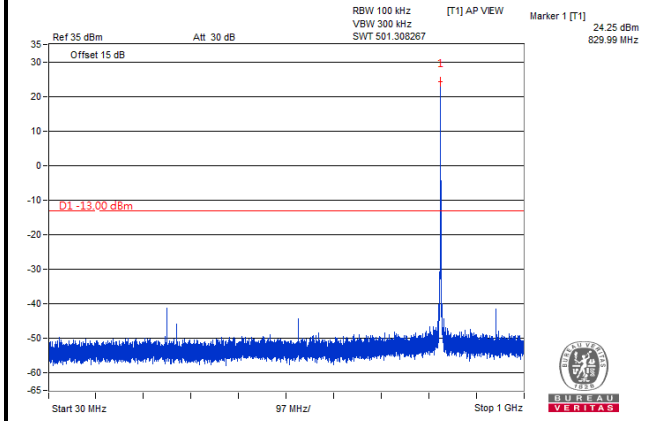

**Channel 26965**

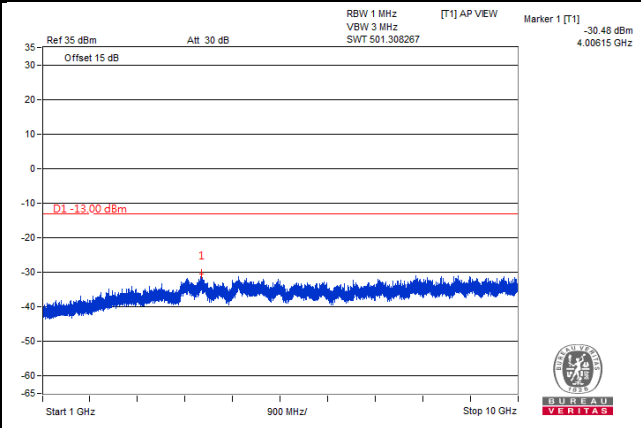
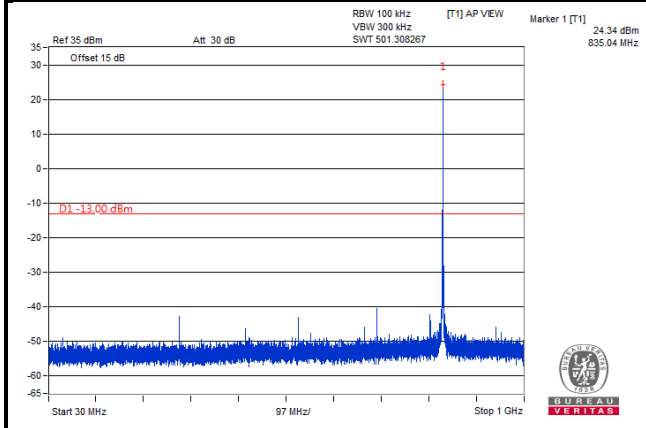

## 4.8 Radiated Emission Measurement

### 4.8.1 Limits of Radiated Emission Measurement

The power of any emission outside of the authorized operating frequency ranges must be attenuated below the transmitting power (P) by a factor of at least  $43 + 10 \log(P)$  dB. The emission limit is equal to -13 dBm.

### 4.8.2 Test Procedure

- a. Substitution method is used for E.I.R.P measurement. In the semi-anechoic chamber, EUT placed on the 0.8 m (below or equal 1 GHz) and/or 1.5 m (above 1 GHz) height of Turn Table, rotated the table around 360 degrees to search the maximum radiation power and receiver antenna shall be rotated vertical and horizontal polarization and moved height from 1 m to 4 m to find the maximum polar radiated power. The "Read Value" is the spectrum reading the maximum power value.
- b. The substitution horn antenna is substituted for EUT at the same position and signals generator export the CW signal to the substitution antenna via a TX cable. Rotated the Turn Table and moved receiving antenna to find the maximum radiation power. Adjust output power level of S.G to get a Value of spectrum reading equal to "Read Value" of step a. Record the power level of S.G
- c. EIRP = Output power level of S.G – TX cable loss + Antenna gain of substitution horn.
- d. E.R.P power can be calculated form E.I.R.P power by subtracting the gain of dipole, E.R.P power = E.I.R.P power - 2.15 dB.

**NOTE:** The resolution bandwidth and video bandwidth of test receiver/spectrum analyzer is 1 MHz/3 MHz.

### 4.8.3 Deviation from Test Standard

No deviation.

4.8.4 Test Setup

<Radiated Emission below or equal 1 GHz>

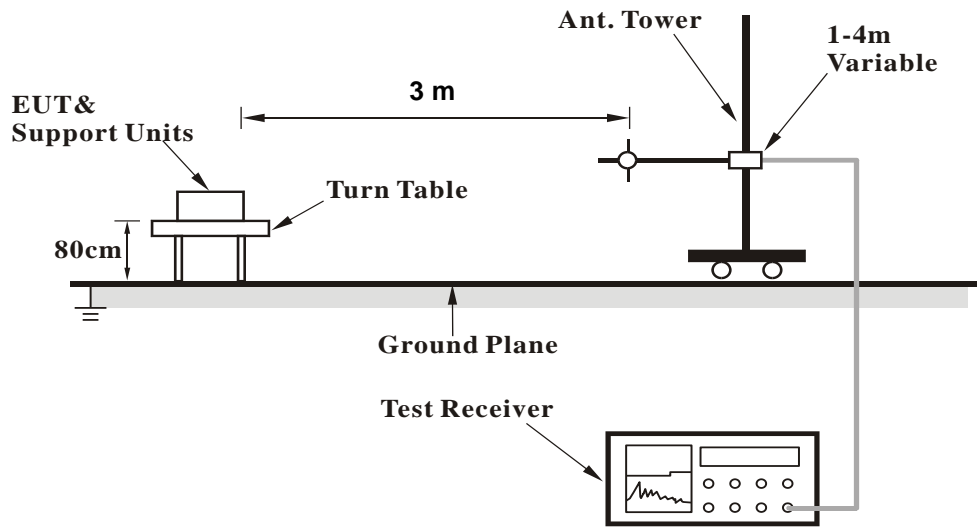

<Radiated Emission above 1 GHz>

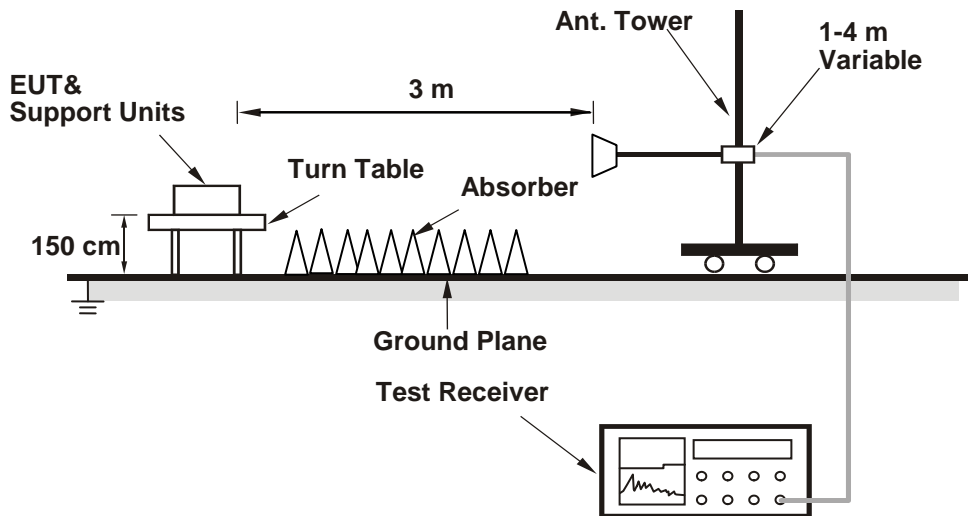

For the actual test configuration, please refer to the attached file (Test Setup Photo).

4.8.5 Test Results

LTE Band 5

Channel Bandwidth: 1.4 MHz / QPSK

Low Channel



Bureau Veritas Consumer Products Services Ltd., Taoyuan Branch

A D T

Data: 1

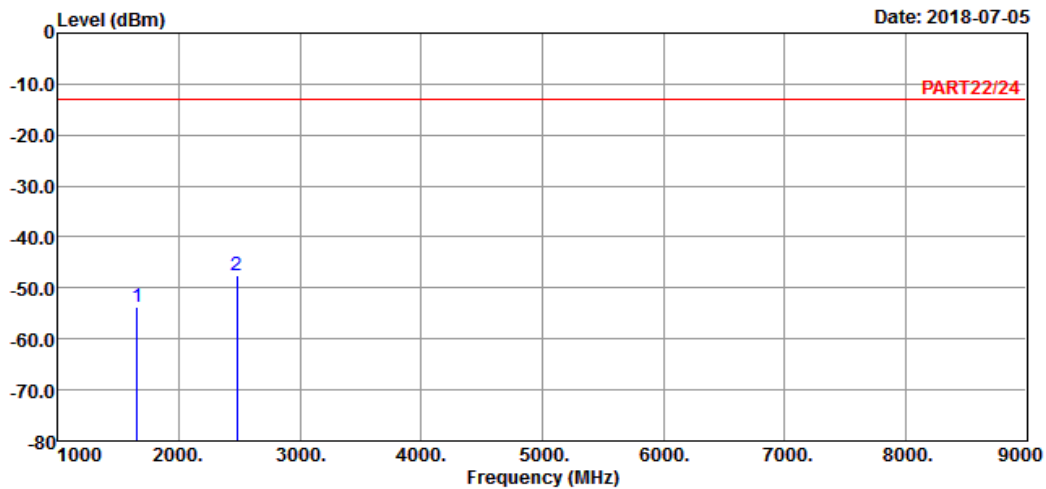

Site : 966 Chamber 5  
 Condition: PART22/24 HORIZONTAL  
 Remak : Cat-M1 Band 5 QPSK\_1.4M Link\_L-CH  
 Tested by: Jisyong Wang

	Freq	Level	Read Level	Limit Line	Over Limit	Factor	Remark
	MHz	dBm	dBm	dBm	dB	dB	
1	1649.40	-53.62	-39.88	-13.00	-40.62	-13.74	Peak
2	2474.10	-47.57	-37.55	-13.00	-34.57	-10.02	Peak



Bureau Veritas Consumer Products Services Ltd., Taoyuan Branch

A D T

Data: 2

Date: 2018-07-05

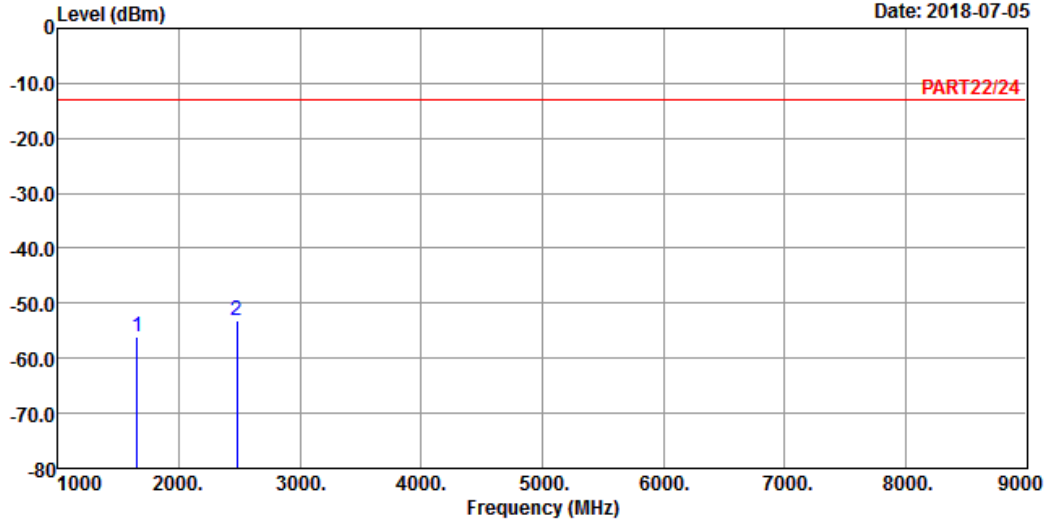

Site : 966 Chamber 5  
 Condition: PART22/24 VERTICAL  
 Remak : Cat-M1 Band 5 QPSK\_1.4M Link\_L-CH  
 Tested by: Jisyong Wang

	Freq	Level	Read Level	Limit Line	Over Limit	Factor	Remark
	MHz	dBm	dBm	dBm	dB	dB	
1	1649.40	-56.14	-42.40	-13.00	-43.14	-13.74	Peak
2 pp	2474.10	-53.01	-42.99	-13.00	-40.01	-10.02	Peak



Middle Channel



Bureau Veritas Consumer Products Services Ltd., Taoyuan Branch

A D T

Data: 1

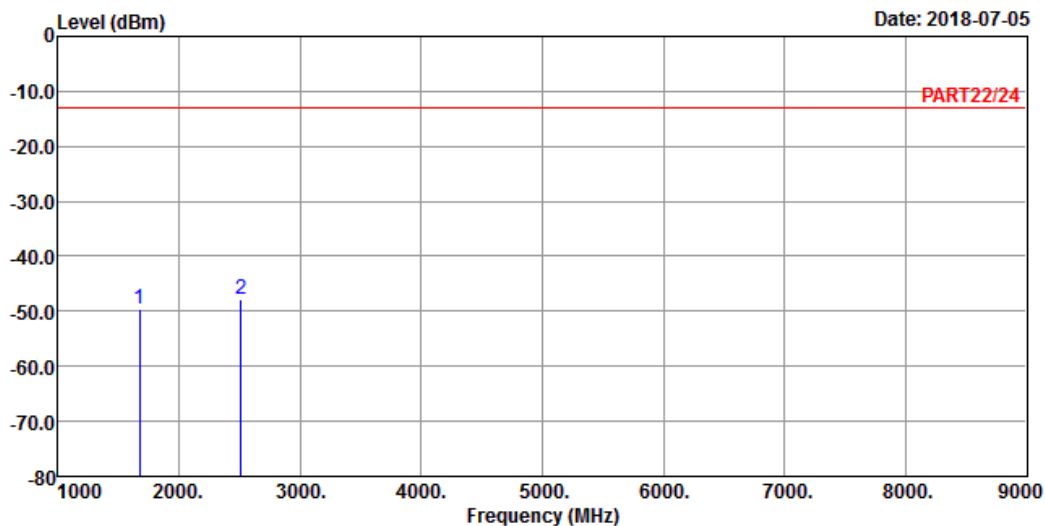

Site : 966 Chamber 5  
 Condition: PART22/24 HORIZONTAL  
 Remak : Cat-M1 Band 5 QPSK\_1.4M Link\_M-CH  
 Tested by: Jisyong Wang

	Read	Limit	Over			
Freq	Level	Level	Line	Limit	Factor	Remark
MHz	dBm	dBm	dBm	dB	dB	
1	1673.00	-49.52	-35.62	-13.00	-36.52	-13.90 Peak
2	pp 2509.50	-47.85	-37.77	-13.00	-34.85	-10.08 Peak



Bureau Veritas Consumer Products Services Ltd., Taoyuan Branch

A D T

Data: 2

Date: 2018-07-05

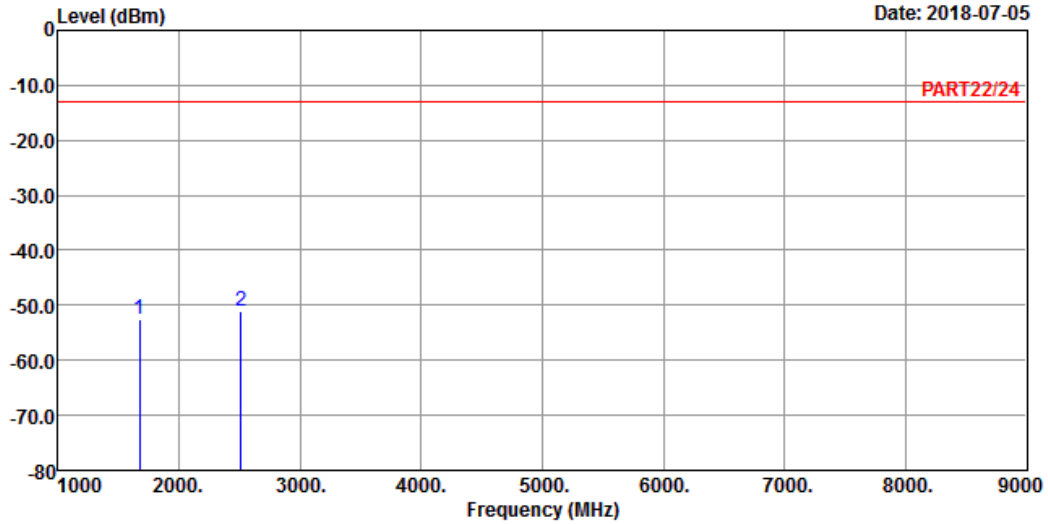

Site : 966 Chamber 5  
 Condition: PART22/24 VERTICAL  
 Remak : Cat-M1 Band 5 QPSK\_1.4M Link\_M-CH  
 Tested by: Jisyong Wang

	Freq	Level	Read Level	Limit Line	Over Limit	Factor	Remark
	MHz	dBm	dBm	dBm	dB	dB	
1	1673.00	-52.52	-38.62	-13.00	-39.52	-13.90	Peak
2 pp	2509.50	-51.05	-40.97	-13.00	-38.05	-10.08	Peak

## High Channel



Bureau Veritas Consumer Products Services Ltd., Taoyuan Branch

A D T

Data: 7

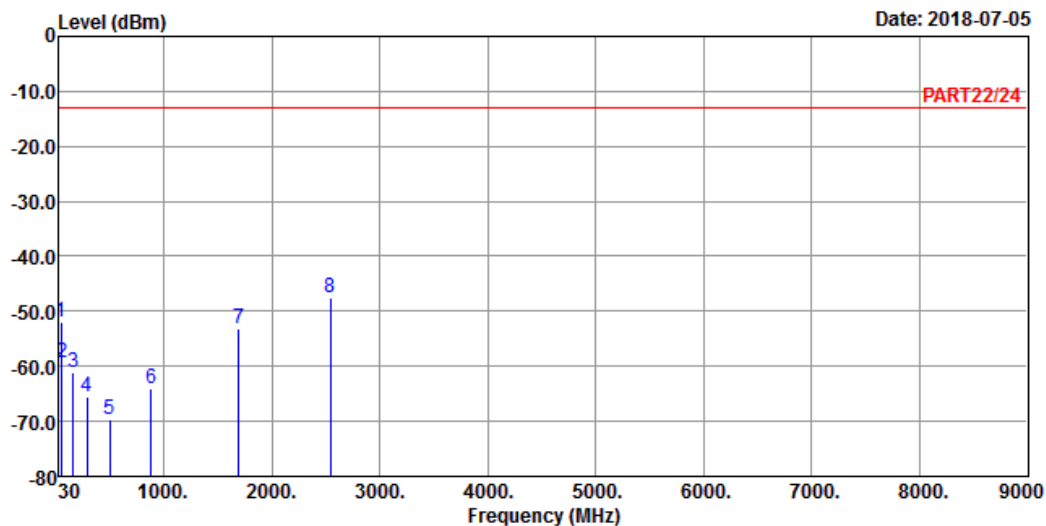

Site : 966 Chamber 5  
 Condition: PART22/24 HORIZONTAL  
 Remak : Cat-M1 Band 5 QPSK\_1.4M Link\_H-CH  
 Tested by: Jisyong Wang

	Read	Limit	Over				
Freq	Level	Level	Line	Limit	Factor	Remark	
MHz	dBm	dBm	dBm	dB	dB		
1	43.77	-51.99	-50.52	-13.00	-38.99	-1.47	Peak
2	54.30	-59.20	-53.13	-13.00	-46.20	-6.07	Peak
3	163.38	-61.00	-55.88	-13.00	-48.00	-5.12	Peak
4	286.23	-65.49	-58.76	-13.00	-52.49	-6.73	Peak
5	498.10	-69.66	-65.01	-13.00	-56.66	-4.65	Peak
6	878.90	-64.18	-64.63	-13.00	-51.18	0.45	Peak
7	1696.60	-53.25	-39.23	-13.00	-40.25	-14.02	Peak
8 pp	2544.90	-47.52	-37.46	-13.00	-34.52	-10.06	Peak



Bureau Veritas Consumer Products Services Ltd., Taoyuan Branch

A D T

Data: 8

Date: 2018-07-05

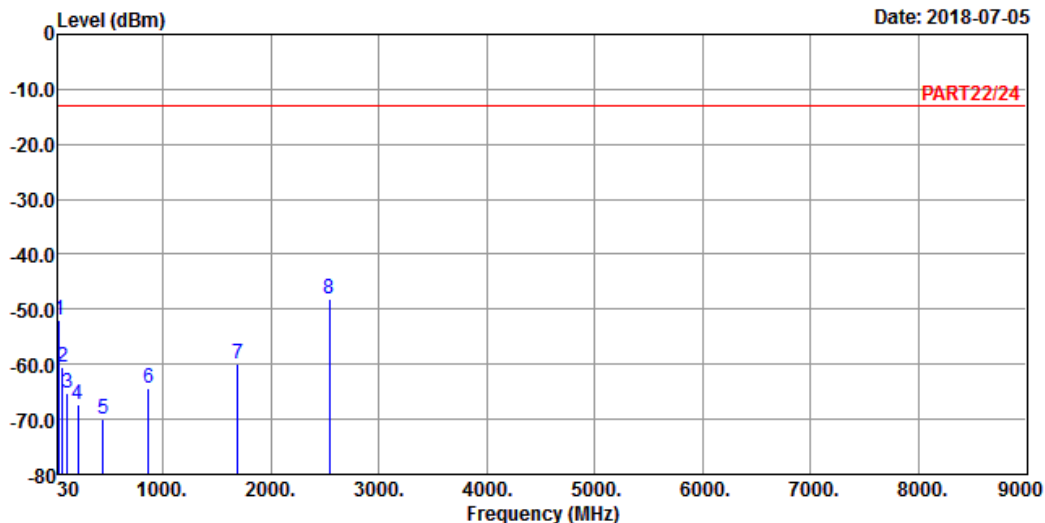

Site : 966 Chamber 5  
 Condition: PART22/24 VERTICAL  
 Remak : Cat-M1 Band 5 QPSK\_1.4M Link\_H-CH  
 Tested by: Jisyong Wang

	Freq	Level	Read Level	Limit Line	Over Limit	Factor	Remark
	MHz	dBm	dBm	dBm	dB	dB	
1	42.96	-51.99	-51.05	-13.00	-38.99	-0.94	Peak
2	68.34	-60.64	-52.32	-13.00	-47.64	-8.32	Peak
3	113.43	-65.39	-55.24	-13.00	-52.39	-10.15	Peak
4	209.55	-67.28	-59.65	-13.00	-54.28	-7.63	Peak
5	447.70	-70.06	-64.49	-13.00	-57.06	-5.57	Peak
6	866.30	-64.28	-64.66	-13.00	-51.28	0.38	Peak
7	1696.60	-60.01	-45.99	-13.00	-47.01	-14.02	Peak
8 pp	2544.90	-48.01	-37.95	-13.00	-35.01	-10.06	Peak

Channel Bandwidth: 5 MHz / QPSK  
Low Channel



Bureau Veritas Consumer Products Services Ltd., Taoyuan Branch

A D T

Data: 1

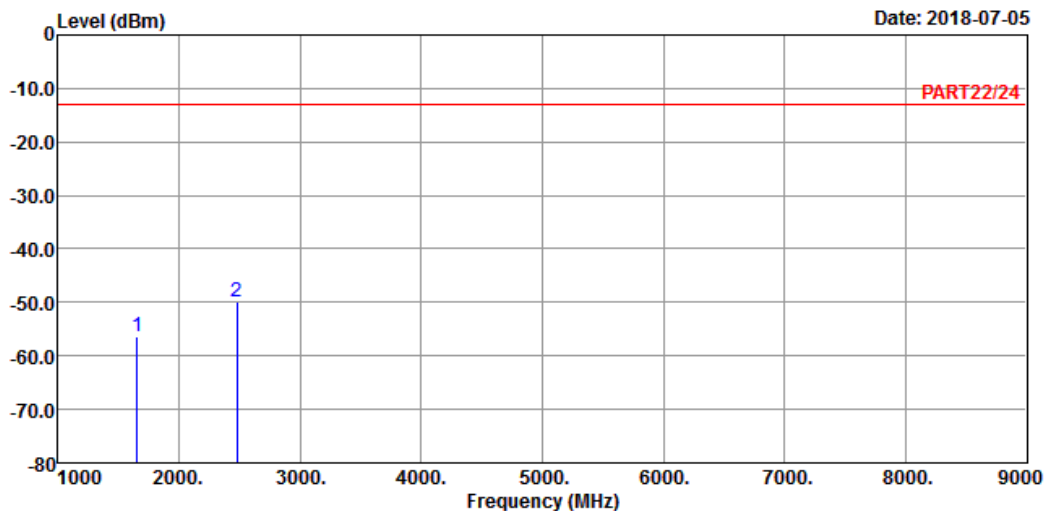

Site : 966 Chamber 5  
Condition: PART22/24 HORIZONTAL  
Remak : Cat-M1 Band 5 QPSK\_5M Link\_L-CH  
Tested by: Jisyong Wang

	Freq	Level	Read Level	Limit Line	Over Limit	Factor	Remark
	MHz	dBm	dBm	dBm	dB	dB	
1	1653.00	-56.52	-42.75	-13.00	-43.52	-13.77	Peak
2 pp	2479.50	-49.98	-39.95	-13.00	-36.98	-10.03	Peak



Bureau Veritas Consumer Products Services Ltd., Taoyuan Branch

A D T

Data: 2

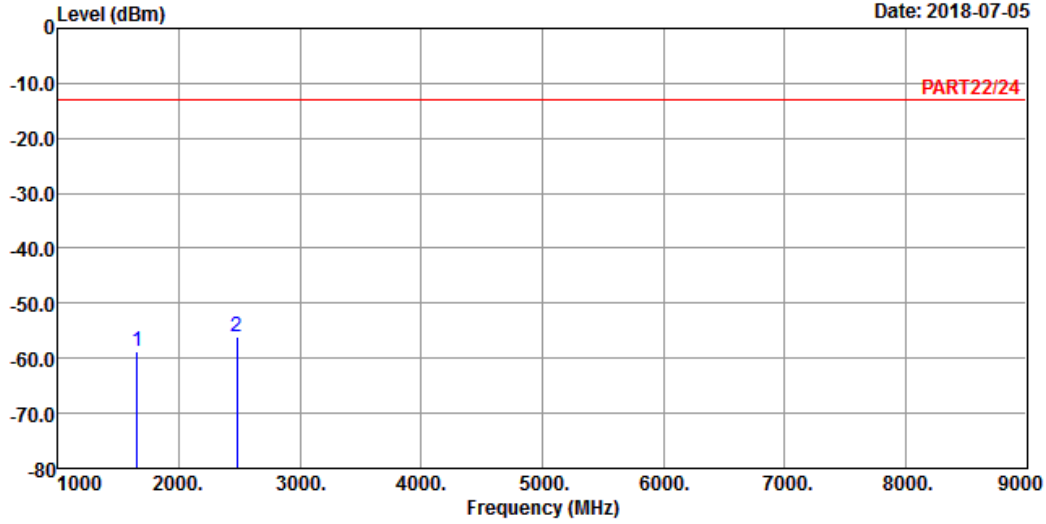

Site : 966 Chamber 5  
 Condition: PART22/24 VERTICAL  
 Remak : Cat-M1 Band 5 QPSK\_5M Link\_L-CH  
 Tested by: Jisyong Wang

	Freq	Level	Read Level	Limit Line	Over Limit	Factor	Remark
	MHz	dBm	dBm	dBm	dB	dB	
1	1653.00	-58.63	-44.86	-13.00	-45.63	-13.77	Peak
2 pp	2479.50	-55.96	-45.93	-13.00	-42.96	-10.03	Peak

Middle Channel



Bureau Veritas Consumer Products Services Ltd., Taoyuan Branch

A D T

Data: 1

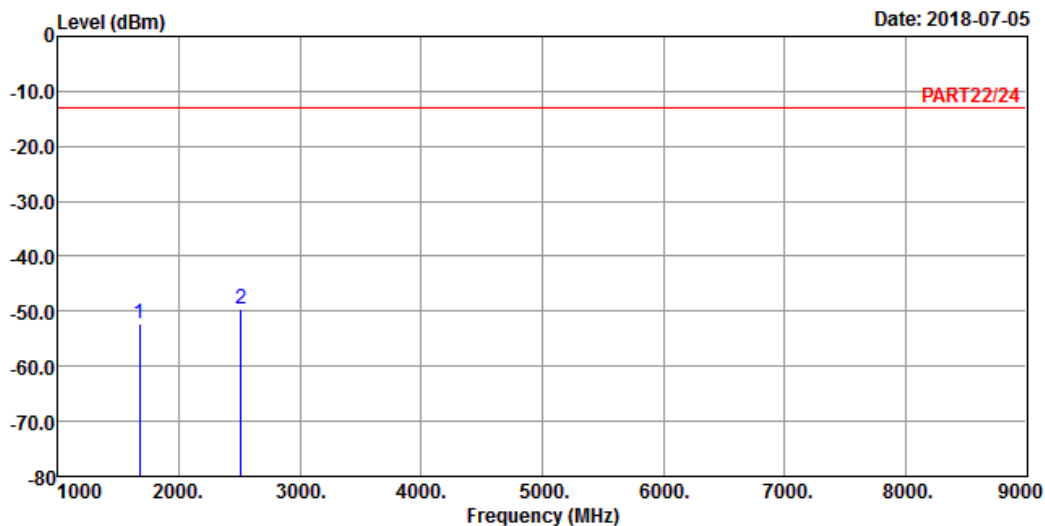

Site : 966 Chamber 5  
 Condition: PART22/24 HORIZONTAL  
 Remak : Cat-M1 Band 5 QPSK\_5M Link\_M-CH  
 Tested by: Jisyong Wang

	Freq	Level	Read Level	Limit	Over	Factor	Remark
	MHz	dBm	dBm	dBm	dB	dB	
1	1673.00	-52.25	-38.35	-13.00	-39.25	-13.90	Peak
2	2509.50	-49.52	-39.44	-13.00	-36.52	-10.08	Peak



Bureau Veritas Consumer Products Services Ltd., Taoyuan Branch

A D T

Data: 2

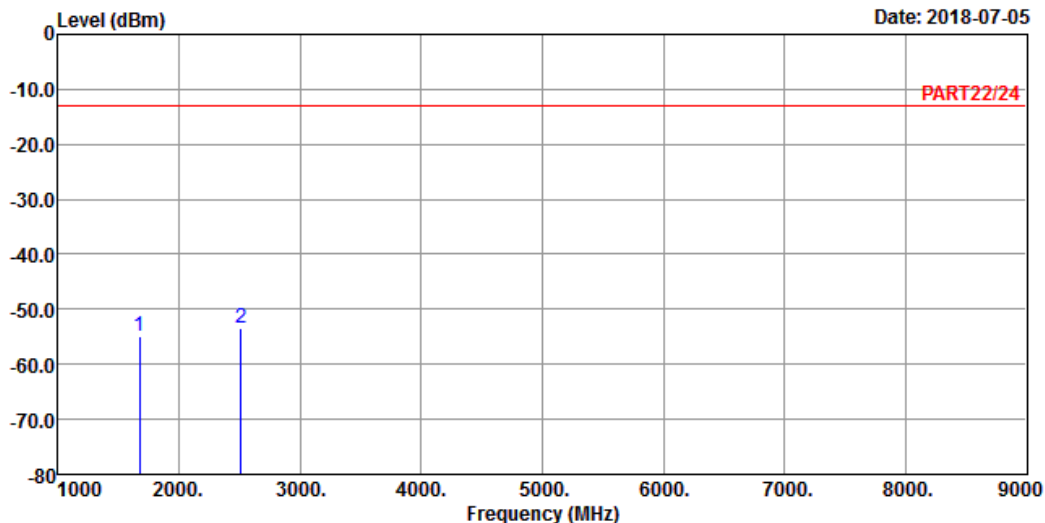

Site : 966 Chamber 5  
 Condition: PART22/24 VERTICAL  
 Remak : Cat-M1 Band 5 QPSK\_5M Link\_M-CH  
 Tested by: Jisyong Wang

	Freq	Level	Read Level	Limit Line	Over Limit	Factor	Remark
	MHz	dBm	dBm	dBm	dB	dB	
1	1673.00	-55.01	-41.11	-13.00	-42.01	-13.90	Peak
2 pp	2509.50	-53.52	-43.44	-13.00	-40.52	-10.08	Peak



High Channel



Bureau Veritas Consumer Products Services Ltd., Taoyuan Branch

A D T

Data: 1

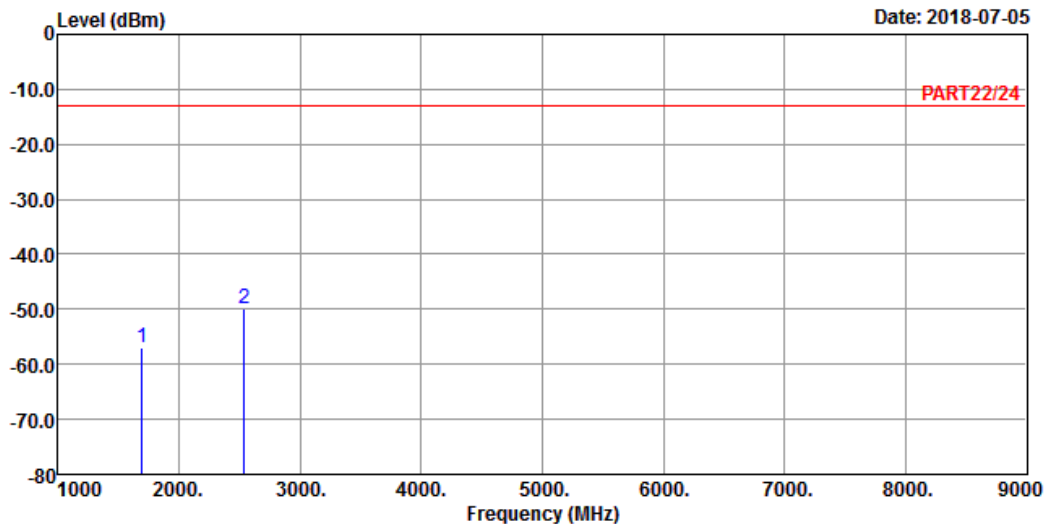

Site : 966 Chamber 5  
 Condition: PART22/24 HORIZONTAL  
 Remak : Cat-M1 Band 5 QPSK\_5M Link\_H-CH  
 Tested by: Jisyong Wang

	Freq	Level	Read Level	Limit	Over	Factor	Remark
	MHz	dBm	dBm	dBm	dB	dB	
1	1693.00	-56.85	-42.83	-13.00	-43.85	-14.02	Peak
2	2539.50	-49.98	-39.92	-13.00	-36.98	-10.06	Peak



Bureau Veritas Consumer Products Services Ltd., Taoyuan Branch

A D T

Data: 2

Date: 2018-07-05

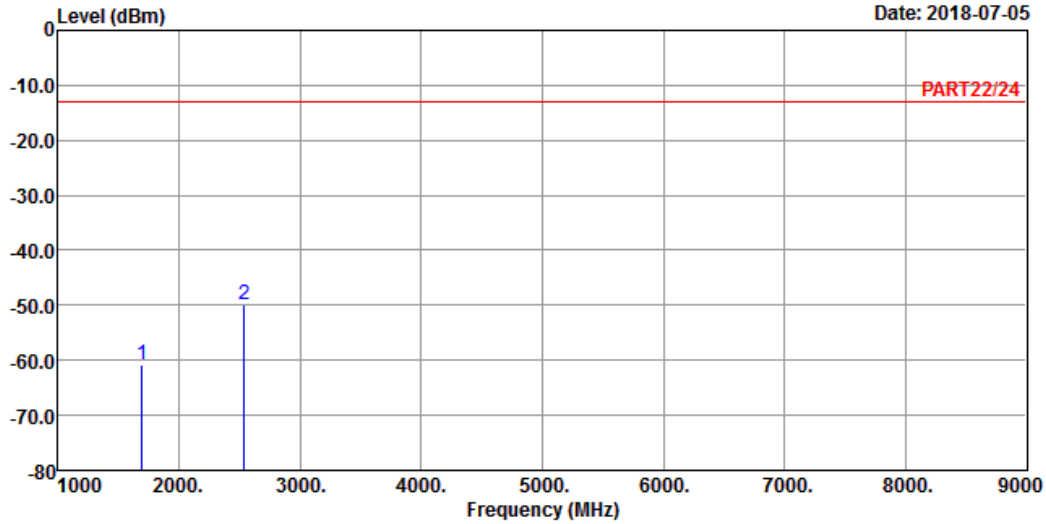

Site : 966 Chamber 5  
 Condition: PART22/24 VERTICAL  
 Remak : Cat-M1 Band 5 QPSK\_5M Link\_H-CH  
 Tested by: Jisyong Wang

	Freq	Level	Read Level	Limit Line	Over Limit	Factor	Remark
	MHz	dBm	dBm	dBm	dB	dB	
1	1693.00	-60.85	-46.83	-13.00	-47.85	-14.02	Peak
2 pp	2539.50	-49.85	-39.79	-13.00	-36.85	-10.06	Peak

Channel Bandwidth: 10 MHz / QPSK  
Low Channel



Bureau Veritas Consumer Products Services Ltd., Taoyuan Branch

A D T

Data: 1

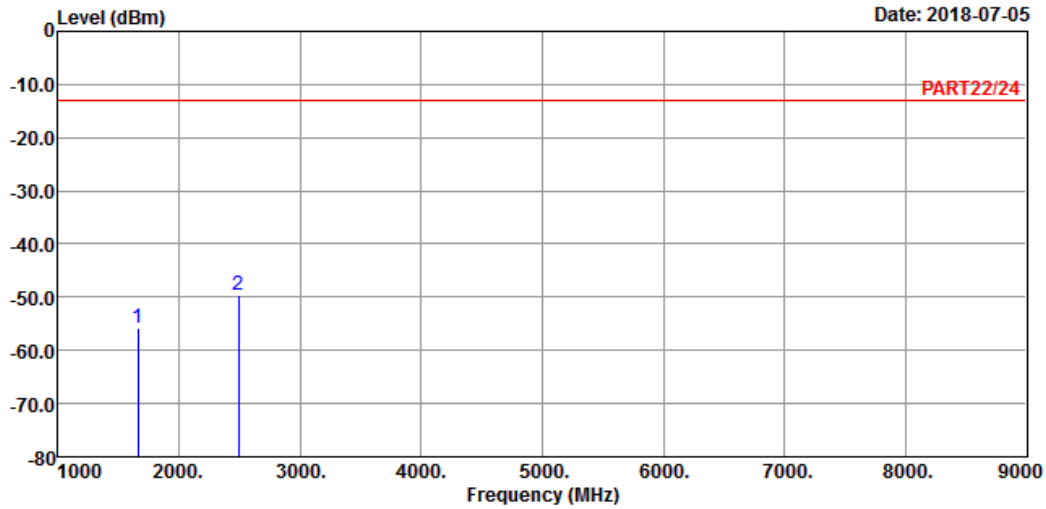

Site : 966 Chamber 5  
Condition: PART22/24 HORIZONTAL  
Remak : Cat-M1 Band 5 QPSK\_10M Link\_L-CH  
Tested by: Jisyong Wang

	Freq	Level	Read Level	Limit Line	Over Limit	Factor	Remark
	MHz	dBm	dBm	dBm	dB	dB	
1	1658.00	-55.83	-42.03	-13.00	-42.83	-13.80	Peak
2 pp	2487.00	-49.47	-39.42	-13.00	-36.47	-10.05	Peak



Bureau Veritas Consumer Products Services Ltd., Taoyuan Branch

A D T

Data: 2

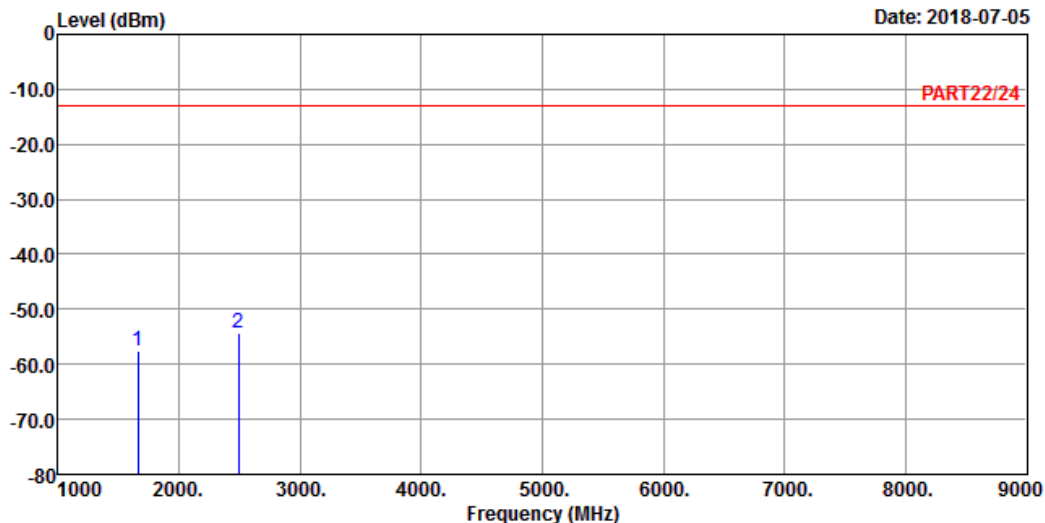

Site : 966 Chamber 5  
 Condition: PART22/24 VERTICAL  
 Remak : Cat-M1 Band 5 QPSK\_10M Link\_L-CH  
 Tested by: Jisyong Wang

	Freq	Level	Read Level	Limit Line	Over Limit	Factor	Remark
	MHz	dBm	dBm	dBm	dB	dB	
1	1658.00	-57.65	-43.85	-13.00	-44.65	-13.80	Peak
2 pp	2487.00	-54.41	-44.36	-13.00	-41.41	-10.05	Peak

Middle Channel



Bureau Veritas Consumer Products Services Ltd., Taoyuan Branch

A D T

Data: 1

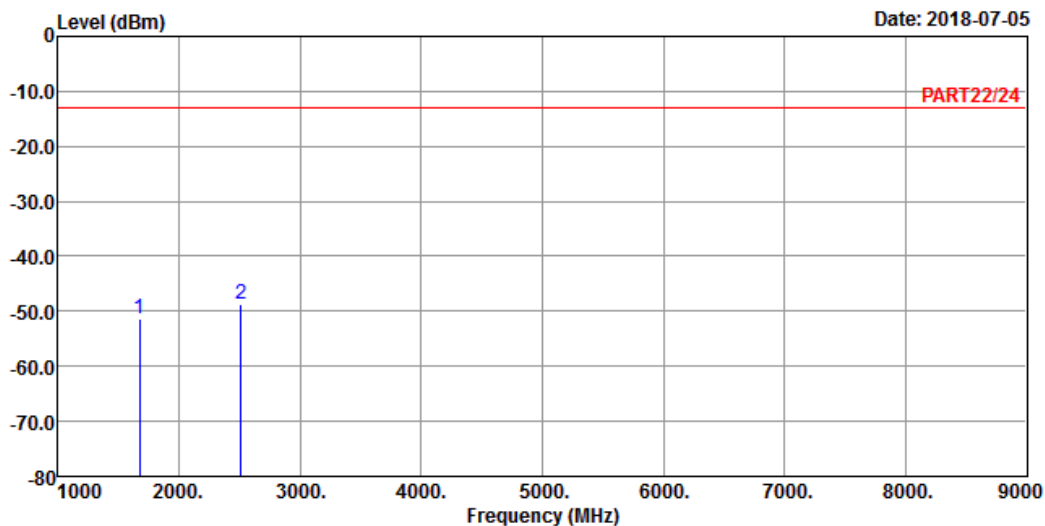

Site : 966 Chamber 5  
 Condition: PART22/24 HORIZONTAL  
 Remak : Cat-M1 Band 5 QPSK\_10M Link\_M-CH  
 Tested by: Jisyong Wang

	Freq	Level	Read Level	Limit	Over	Factor	Remark
	MHz	dBm	dBm	dBm	dB	dB	
1	1673.00	-51.49	-37.59	-13.00	-38.49	-13.90	Peak
2	2509.50	-48.83	-38.75	-13.00	-35.83	-10.08	Peak



Bureau Veritas Consumer Products Services Ltd., Taoyuan Branch

A D T

Data: 2

Date: 2018-07-05

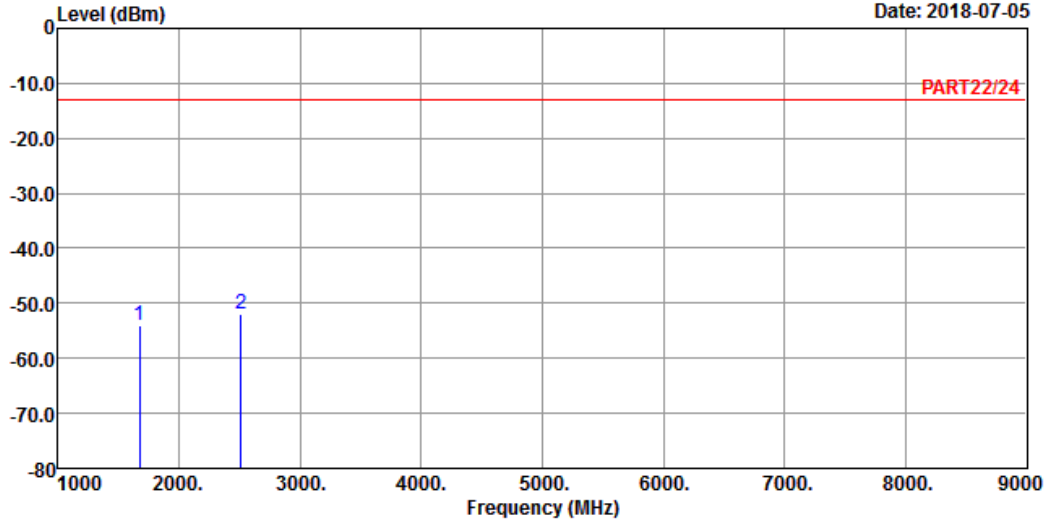

Site : 966 Chamber 5  
 Condition: PART22/24 VERTICAL  
 Remak : Cat-M1 Band 5 QPSK\_10M Link\_M-CH  
 Tested by: Jisyong Wang

	Freq	Level	Read Level	Limit Line	Over Limit	Factor	Remark
	MHz	dBm	dBm	dBm	dB	dB	
1	1673.00	-54.09	-40.19	-13.00	-41.09	-13.90	Peak
2 pp	2509.50	-52.00	-41.92	-13.00	-39.00	-10.08	Peak

High Channel



Bureau Veritas Consumer Products Services Ltd., Taoyuan Branch

A D T

Data: 1

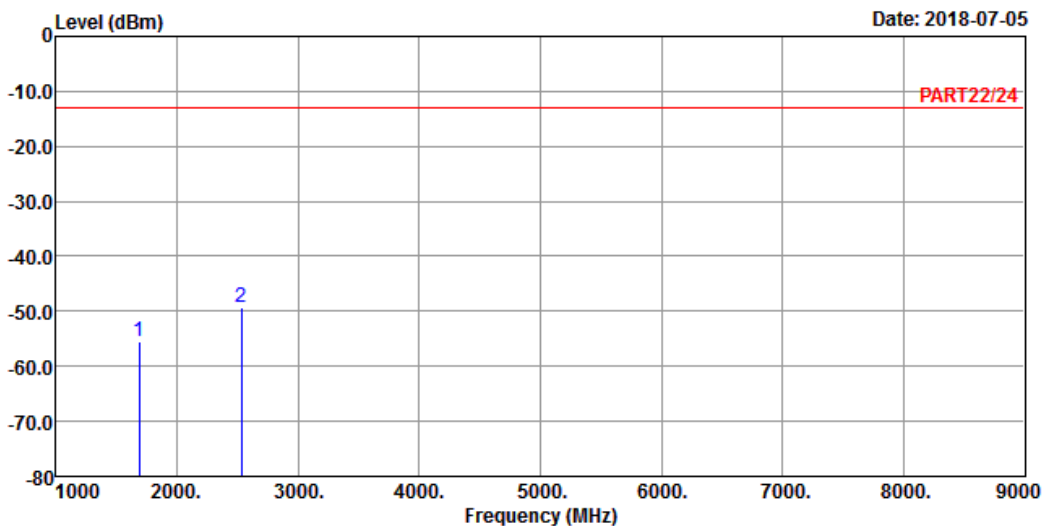

Site : 966 Chamber 5  
 Condition: PART22/24 HORIZONTAL  
 Remak : Cat-M1 Band 5 QPSK\_10M Link\_H-CH  
 Tested by: Jisyong Wang

	Freq	Level	Read Level	Limit	Over	Factor	Remark
	MHz	dBm	dBm	dBm	dB	dB	
1	1688.00	-55.49	-41.50	-13.00	-42.49	-13.99	Peak
2	2532.00	-49.38	-39.31	-13.00	-36.38	-10.07	Peak



Bureau Veritas Consumer Products Services Ltd., Taoyuan Branch

A D T

Data: 2

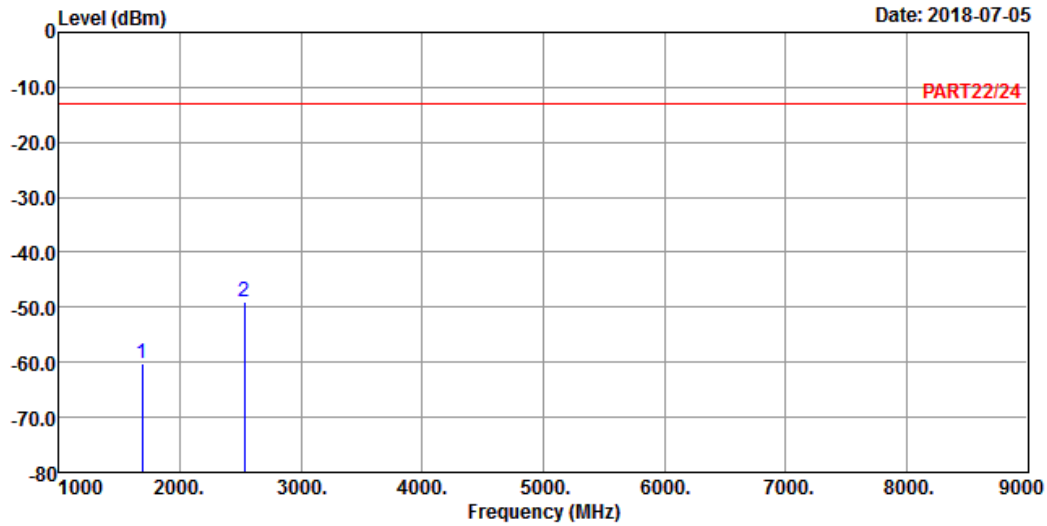

Site : 966 Chamber 5  
 Condition: PART22/24 VERTICAL  
 Remak : Cat-M1 Band 5 QPSK\_10M Link\_H-CH  
 Tested by: Jisyong Wang

	Freq	Level	Read Level	Limit Line	Over Limit	Factor	Remark
	MHz	dBm	dBm	dBm	dB	dB	
1	1688.00	-60.22	-46.23	-13.00	-47.22	-13.99	Peak
2 pp	2532.00	-49.08	-39.01	-13.00	-36.08	-10.07	Peak



LTE Band 26  
 Channel Bandwidth: 1.4 MHz / QPSK  
 Low Channel



Bureau Veritas Consumer Products Services Ltd., Taoyuan Branch

A D T

Data: 1

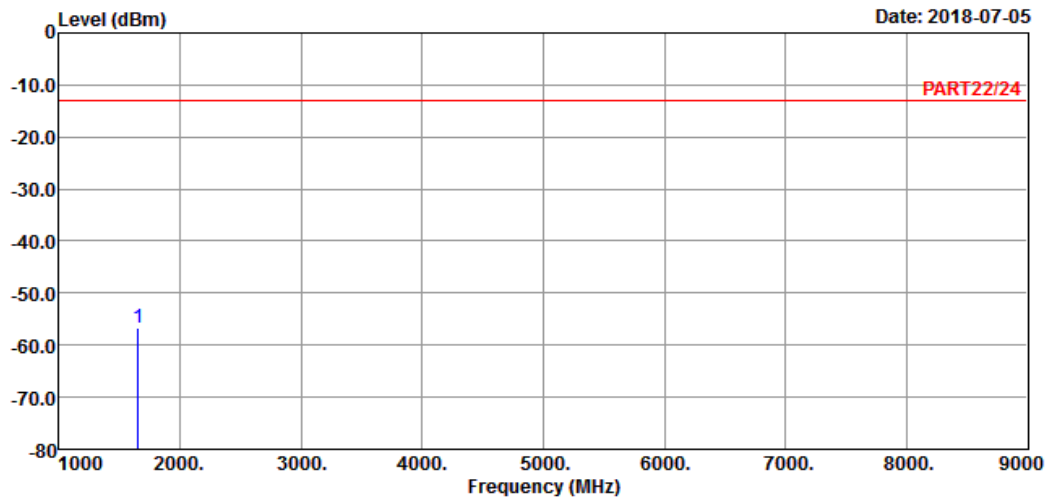

Site : 966 Chamber 5  
 Condition: PART22/24 HORIZONTAL  
 Remak : Cat-M1 Band 26 QPSK\_1.4M Link\_L-CH  
 Tested by: Thomas Wei

Freq	Level	Read Level	Limit Line	Over Limit	Factor	Remark
MHz	dBm	dBm	dBm	dB	dB	
1 pp 1649.40	-56.55	-42.81	-13.00	-43.55	-13.74	Peak



Bureau Veritas Consumer Products Services Ltd., Taoyuan Branch

A D T

Data: 2

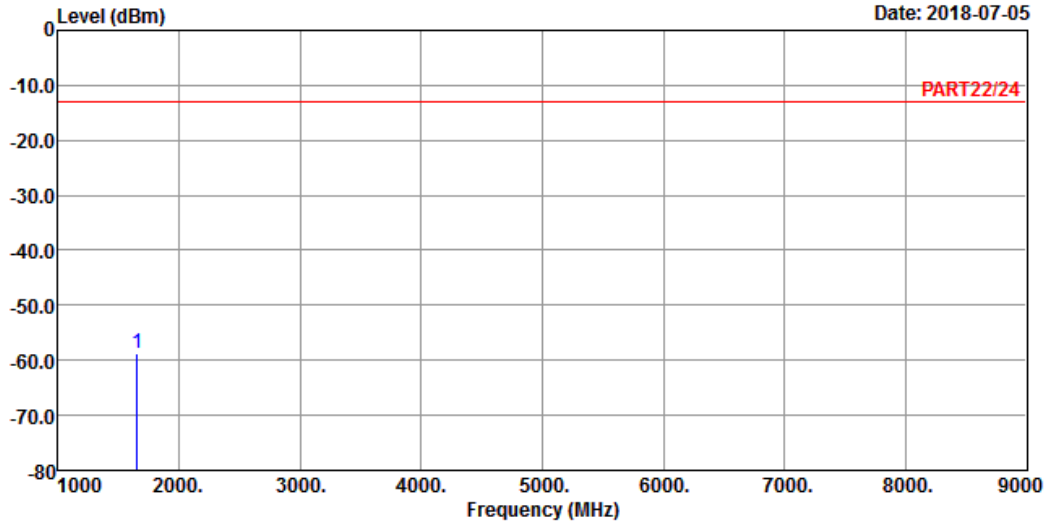

Site : 966 Chamber 5  
 Condition: PART22/24 VERTICAL  
 Remak : Cat-M1 Band 26 QPSK\_1.4M Link\_L-CH  
 Tested by: Thomas Wei

Freq	Level	Read Level	Limit Line	Over Limit	Factor	Remark
MHz	dBm	dBm	dBm	dB	dB	
1 pp 1649.40	-58.69	-44.95	-13.00	-45.69	-13.74	Peak

Middle Channel



Bureau Veritas Consumer Products Services Ltd., Taoyuan Branch

A D T

Data: 1

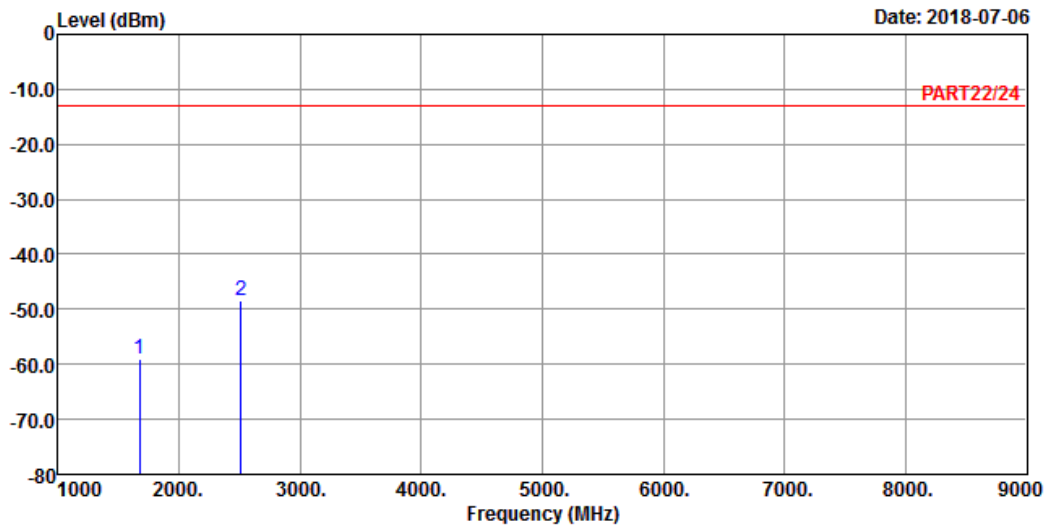

Site : 966 Chamber 5  
 Condition: PART22/24 HORIZONTAL  
 Remak : Cat-M1 Band 26 QPSK\_1.4M Link\_M-CH  
 Tested by: Thomas Wei

	Freq	Level	Read Level	Limit Line	Over Limit	Factor	Remark
	MHz	dBm	dBm	dBm	dB	dB	
1	1673.00	-59.02	-45.12	-13.00	-46.02	-13.90	Peak
2 pp	2509.50	-48.54	-38.46	-13.00	-35.54	-10.08	Peak



Bureau Veritas Consumer Products Services Ltd., Taoyuan Branch

A D T

Data: 2

Date: 2018-07-06

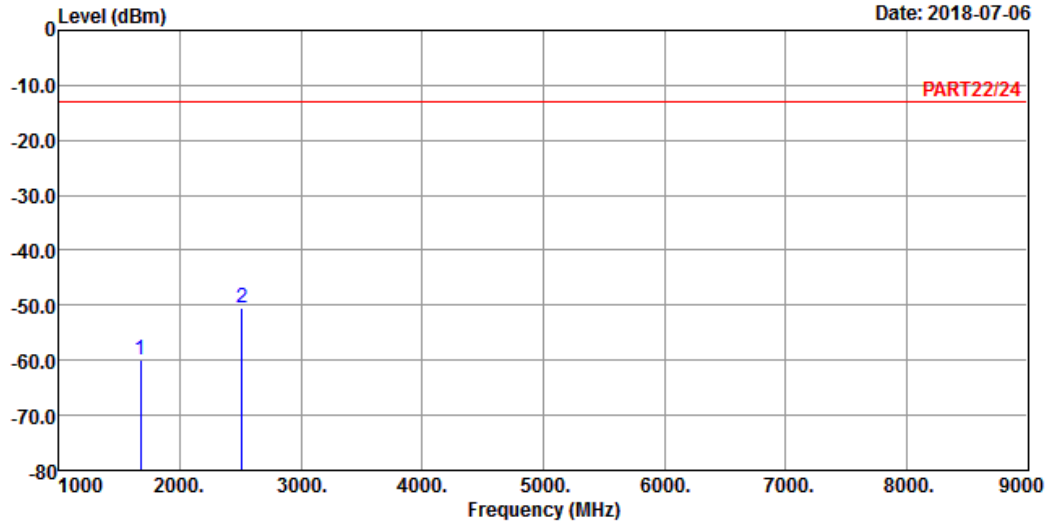

Site : 966 Chamber 5  
 Condition: PART22/24 VERTICAL  
 Remak : Cat-M1 Band 26 QPSK\_1.4M Link\_M-CH  
 Tested by: Thomas Wei

	Freq	Level	Read Level	Limit Line	Over Limit	Factor	Remark
	MHz	dBm	dBm	dBm	dB	dB	
1	1673.00	-59.90	-46.00	-13.00	-46.90	-13.90	Peak
2 pp	2509.50	-50.47	-40.39	-13.00	-37.47	-10.08	Peak

## High Channel



Bureau Veritas Consumer Products Services Ltd., Taoyuan Branch

A D T

Data: 7

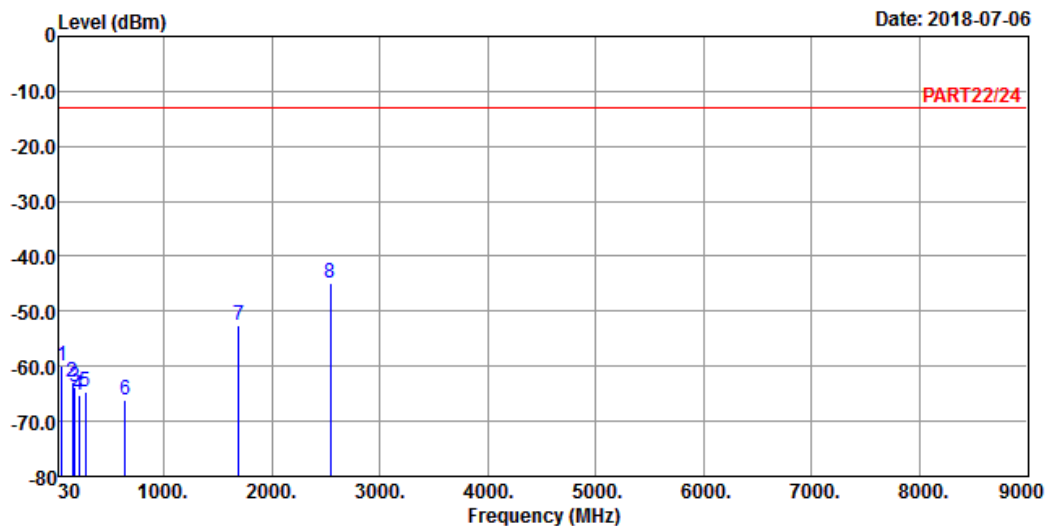

Site : 966 Chamber 5  
 Condition: PART22/24 HORIZONTAL  
 Remak : Cat-M1 Band 26 QPSK\_1.4M Link\_H-CH  
 Tested by: Thomas Wei

	Freq	Level	Read Level	Limit Line	Over Limit	Factor	Remark
	MHz	dBm	dBm	dBm	dB	dB	
1	54.57	-60.05	-53.98	-13.00	-47.05	-6.07	Peak
2	153.66	-63.00	-56.24	-13.00	-50.00	-6.76	Peak
3	171.75	-63.72	-57.85	-13.00	-50.72	-5.87	Peak
4	215.49	-65.29	-57.89	-13.00	-52.29	-7.40	Peak
5	273.00	-64.78	-58.31	-13.00	-51.78	-6.47	Peak
6	640.20	-65.99	-65.13	-13.00	-52.99	-0.86	Peak
7	1696.60	-52.61	-38.59	-13.00	-39.61	-14.02	Peak
8 pp	2544.90	-44.73	-34.67	-13.00	-31.73	-10.06	Peak



Bureau Veritas Consumer Products Services Ltd., Taoyuan Branch

A D T

Data: 8

Date: 2018-07-06

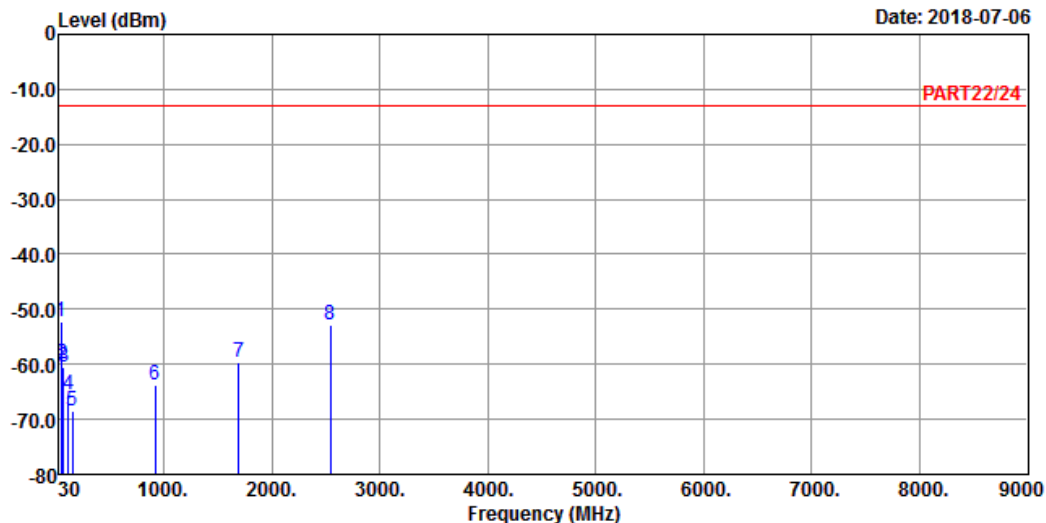

Site : 966 Chamber 5  
 Condition: PART22/24 VERTICAL  
 Remak : Cat-M1 Band 26 QPSK\_1.4M Link\_H-CH  
 Tested by: Thomas Wei

	Freq	Level	Read Level	Limit Line	Over Limit	Factor	Remark
	MHz	dBm	dBm	dBm	dB	dB	
1 pp	43.77	-52.14	-50.67	-13.00	-39.14	-1.47	Peak
2	54.30	-59.91	-53.84	-13.00	-46.91	-6.07	Peak
3	68.34	-60.64	-52.32	-13.00	-47.64	-8.32	Peak
4	112.35	-65.41	-55.21	-13.00	-52.41	-10.20	Peak
5	154.74	-68.57	-62.36	-13.00	-55.57	-6.21	Peak
6	919.50	-63.84	-64.89	-13.00	-50.84	1.05	Peak
7	1696.60	-59.51	-45.49	-13.00	-46.51	-14.02	Peak
8	2544.90	-52.70	-42.64	-13.00	-39.70	-10.06	Peak

Channel Bandwidth: 5 MHz / QPSK  
Low Channel



Bureau Veritas Consumer Products Services Ltd., Taoyuan Branch

A D T

Data: 1

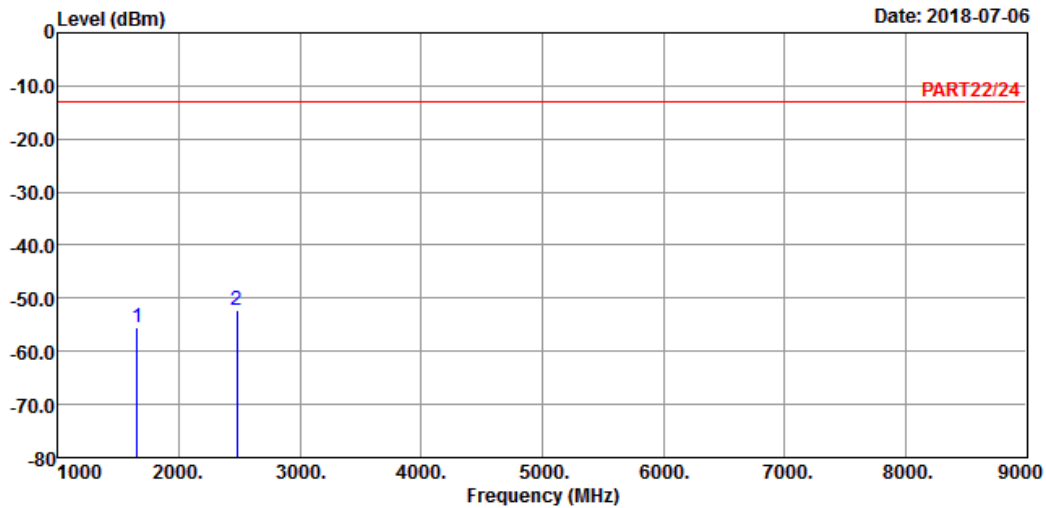

Site : 966 Chamber 5  
Condition: PART22/24 HORIZONTAL  
Remak : Cat-M1 Band 26 QPSK\_5M Link\_L-CH  
Tested by: Thomas Wei

	Freq	Level	Read Level	Limit Line	Over Limit	Factor	Remark
	MHz	dBm	dBm	dBm	dB	dB	
1	1653.00	-55.51	-41.74	-13.00	-42.51	-13.77	Peak
2 pp	2479.50	-52.19	-42.16	-13.00	-39.19	-10.03	Peak



Bureau Veritas Consumer Products Services Ltd., Taoyuan Branch

A D T

Data: 2

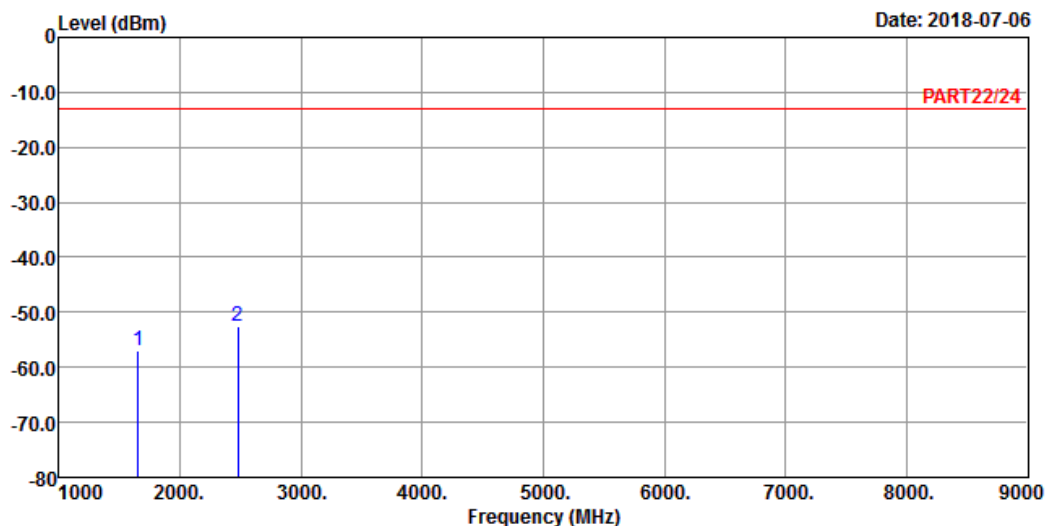

Site : 966 Chamber 5  
 Condition: PART22/24 VERTICAL  
 Remak : Cat-M1 Band 26 QPSK\_5M Link\_L-CH  
 Tested by: Thomas Wei

	Freq	Level	Read Level	Limit Line	Over Limit	Factor	Remark
	MHz	dBm	dBm	dBm	dB	dB	
1	1653.00	-56.85	-43.08	-13.00	-43.85	-13.77	Peak
2 pp	2479.50	-52.60	-42.57	-13.00	-39.60	-10.03	Peak



Middle Channel



Bureau Veritas Consumer Products Services Ltd., Taoyuan Branch

A D T

Data: 1

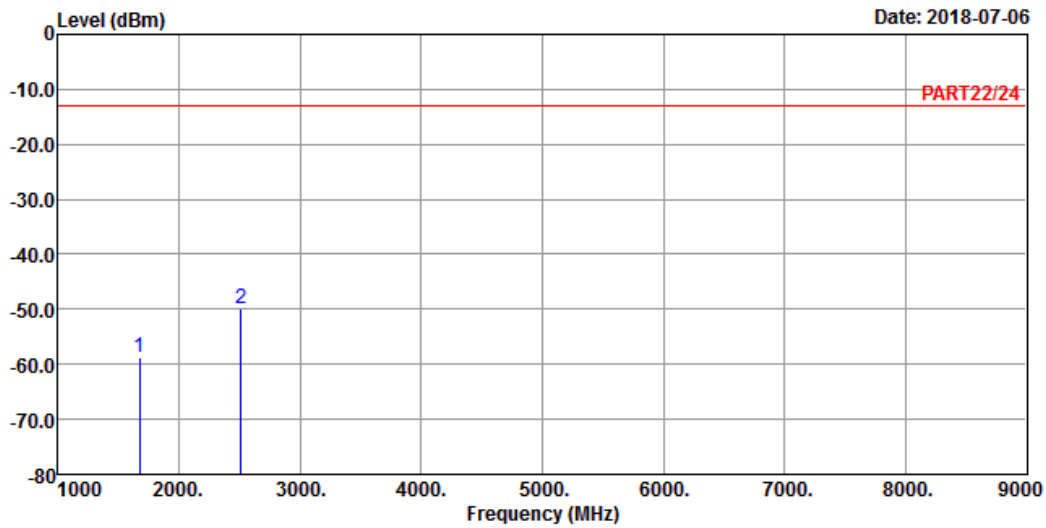

Site : 966 Chamber 5  
 Condition: PART22/24 HORIZONTAL  
 Remak : Cat-M1 Band 26 QPSK\_5M Link\_M-CH  
 Tested by: Thomas Wei

	Freq	Level	Read Level	Limit Line	Over Limit	Factor	Remark
	MHz	dBm	dBm	dBm	dB	dB	
1	1673.00	-58.88	-44.98	-13.00	-45.88	-13.90	Peak
2	2509.50	-49.92	-39.84	-13.00	-36.92	-10.08	Peak



Bureau Veritas Consumer Products Services Ltd., Taoyuan Branch

A D T

Data: 2

Date: 2018-07-06

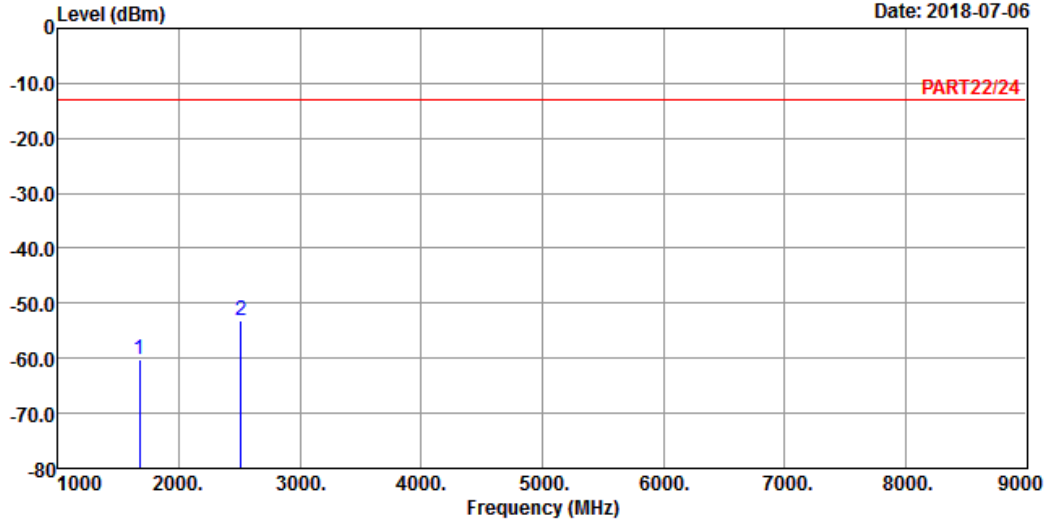

Site : 966 Chamber 5  
 Condition: PART22/24 VERTICAL  
 Remak : Cat-M1 Band 26 QPSK\_5M Link\_M-CH  
 Tested by: Thomas Wei

	Freq	Level	Read Level	Limit Line	Over Limit	Factor	Remark
	MHz	dBm	dBm	dBm	dB	dB	
1	1673.00	-60.17	-46.27	-13.00	-47.17	-13.90	Peak
2 pp	2509.50	-53.07	-42.99	-13.00	-40.07	-10.08	Peak

High Channel



Bureau Veritas Consumer Products Services Ltd., Taoyuan Branch

A D T

Data: 1

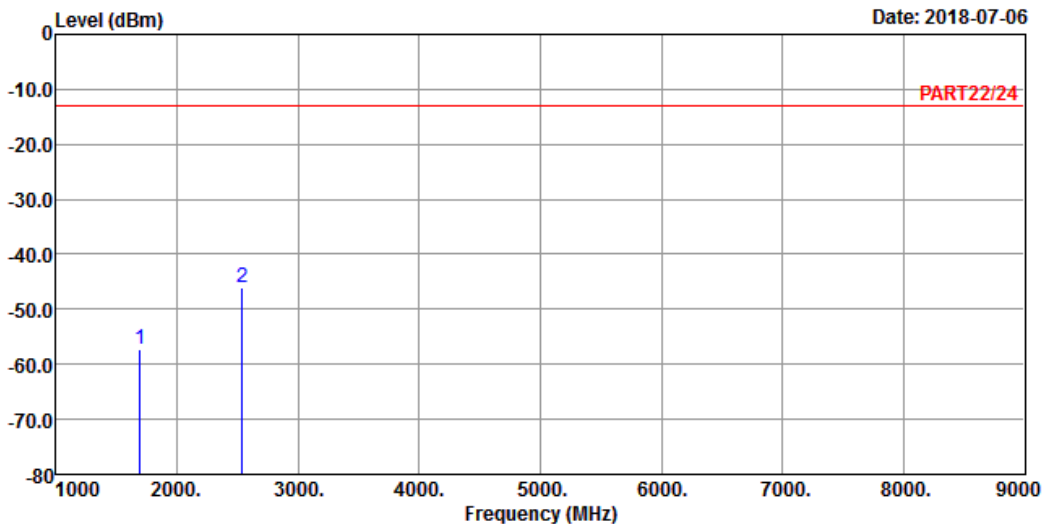

Site : 966 Chamber 5  
 Condition: PART22/24 HORIZONTAL  
 Remak : Cat-M1 Band 26 QPSK\_5M Link\_H-CH  
 Tested by: Thomas Wei

	Freq	Level	Read Level	Limit Line	Over Limit	Factor	Remark
	MHz	dBm	dBm	dBm	dB	dB	
1	1693.00	-57.24	-43.22	-13.00	-44.24	-14.02	Peak
2 pp	2539.50	-45.99	-35.93	-13.00	-32.99	-10.06	Peak



A D T

Data: 2

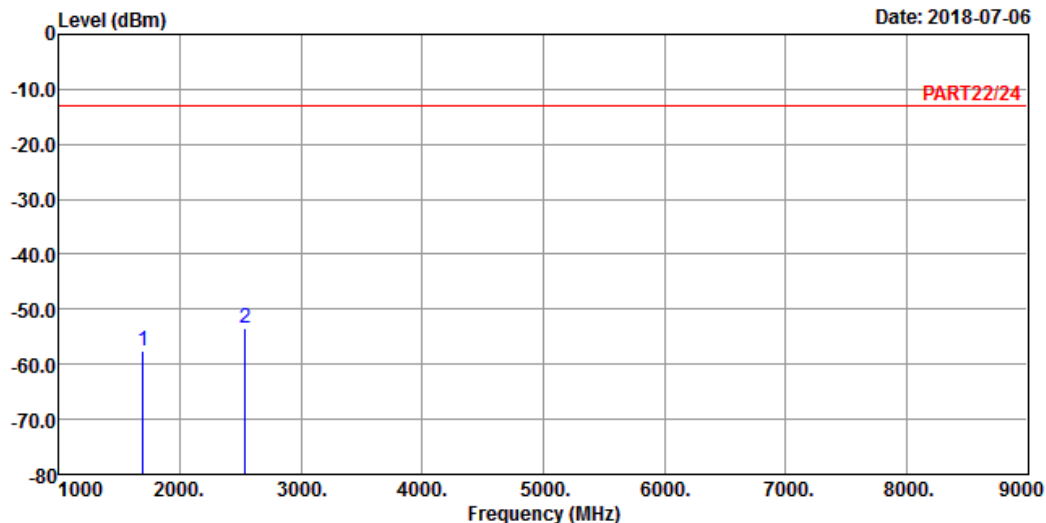

Site : 966 Chamber 5  
 Condition: PART22/24 VERTICAL  
 Remak : Cat-M1 Band 26 QPSK\_5M Link\_H-CH  
 Tested by: Thomas Wei

	Freq	Level	Read Level	Limit Line	Over Limit	Factor	Remark
	MHz	dBm	dBm	dBm	dB	dB	
1	1693.00	-57.44	-43.42	-13.00	-44.44	-14.02	Peak
2 pp	2539.50	-53.50	-43.44	-13.00	-40.50	-10.06	Peak

Channel Bandwidth: 15 MHz / QPSK  
Low Channel



Bureau Veritas Consumer Products Services Ltd., Taoyuan Branch

A D T

Data: 1

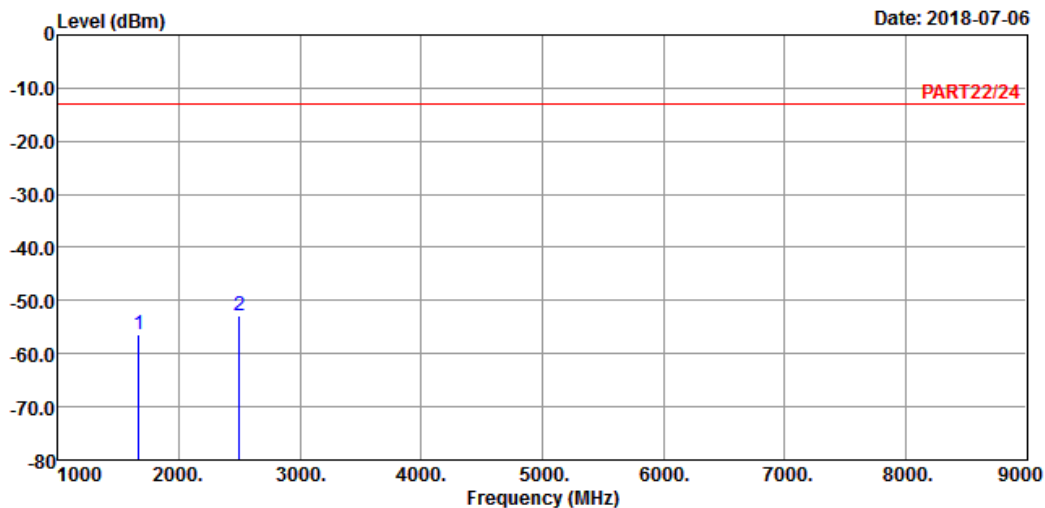

Site : 966 Chamber 5  
Condition: PART22/24 HORIZONTAL  
Remak : Cat-M1 Band 26 QPSK\_15M Link\_L-CH  
Tested by: Thomas Wei

	Freq	Level	Read Level	Limit Line	Over Limit	Factor	Remark
	MHz	dBm	dBm	dBm	dB	dB	
1	1663.00	-56.28	-42.51	-13.00	-43.28	-13.77	Peak
2 pp	2494.50	-52.77	-42.74	-13.00	-39.77	-10.03	Peak



Bureau Veritas Consumer Products Services Ltd., Taoyuan Branch

A D T

Data: 2

Date: 2018-07-06

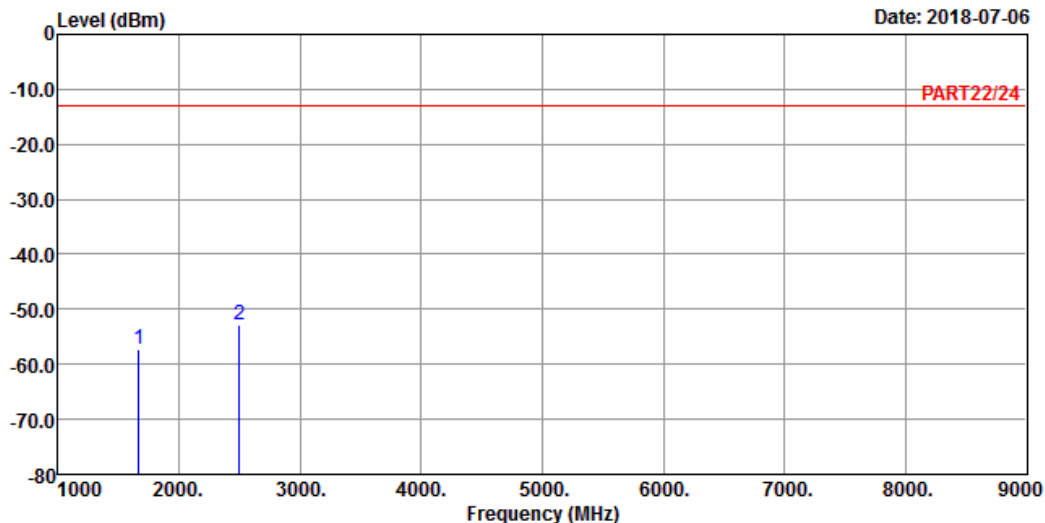

Site : 966 Chamber 5  
 Condition: PART22/24 VERTICAL  
 Remak : Cat-M1 Band 26 QPSK\_15M Link\_L-CH  
 Tested by: Thomas Wei

	Freq	Level	Read Level	Limit Line	Over Limit	Factor	Remark
	MHz	dBm	dBm	dBm	dB	dB	
1	1663.00	-57.33	-43.56	-13.00	-44.33	-13.77	Peak
2 pp	2494.50	-52.91	-42.88	-13.00	-39.91	-10.03	Peak

Middle Channel



Bureau Veritas Consumer Products Services Ltd., Taoyuan Branch

A D T

Data: 1

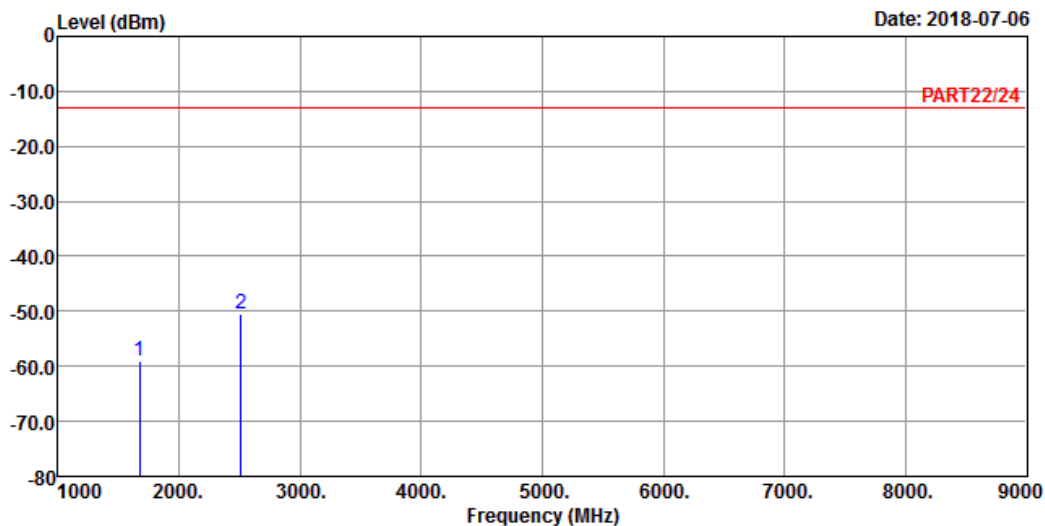

Site : 966 Chamber 5  
 Condition: PART22/24 HORIZONTAL  
 Remak : Cat-M1 Band 26 QPSK\_15M Link\_M-CH  
 Tested by: Thomas Wei

	Freq	Level	Read Level	Limit Line	Over Limit	Factor	Remark
	MHz	dBm	dBm	dBm	dB	dB	
1	1673.00	-59.11	-45.21	-13.00	-46.11	-13.90	Peak
2	pp 2509.50	-50.34	-40.26	-13.00	-37.34	-10.08	Peak



Bureau Veritas Consumer Products Services Ltd., Taoyuan Branch

A D T

Data: 2

Date: 2018-07-06

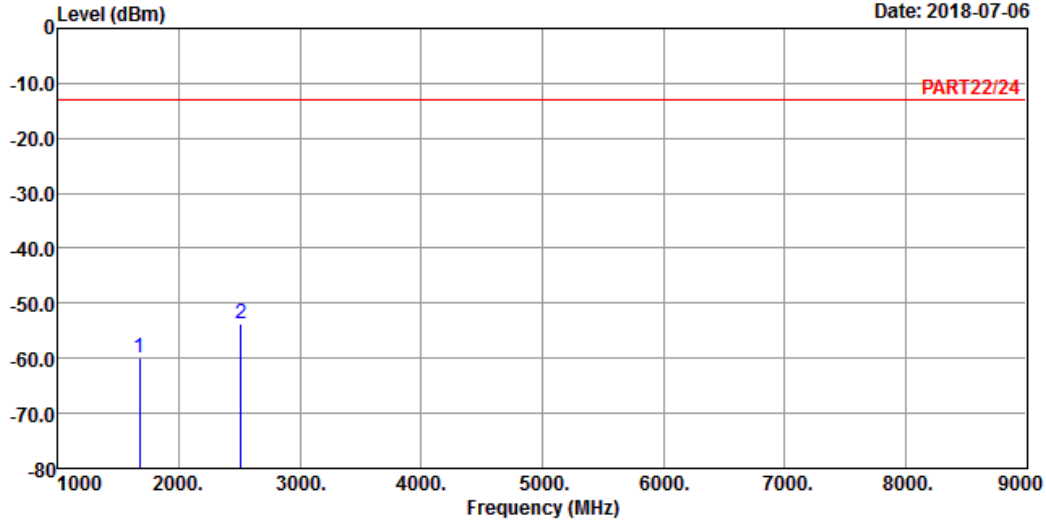

Site : 966 Chamber 5  
 Condition: PART22/24 VERTICAL  
 Remak : Cat-M1 Band 26 QPSK\_15M Link\_M-CH  
 Tested by: Thomas Wei

	Freq	Level	Read Level	Limit Line	Over Limit	Factor	Remark
	MHz	dBm	dBm	dBm	dB	dB	
1	1673.00	-59.88	-45.98	-13.00	-46.88	-13.90	Peak
2 pp	2509.50	-53.72	-43.64	-13.00	-40.72	-10.08	Peak



High Channel



Bureau Veritas Consumer Products Services Ltd., Taoyuan Branch

A D T

Data: 1

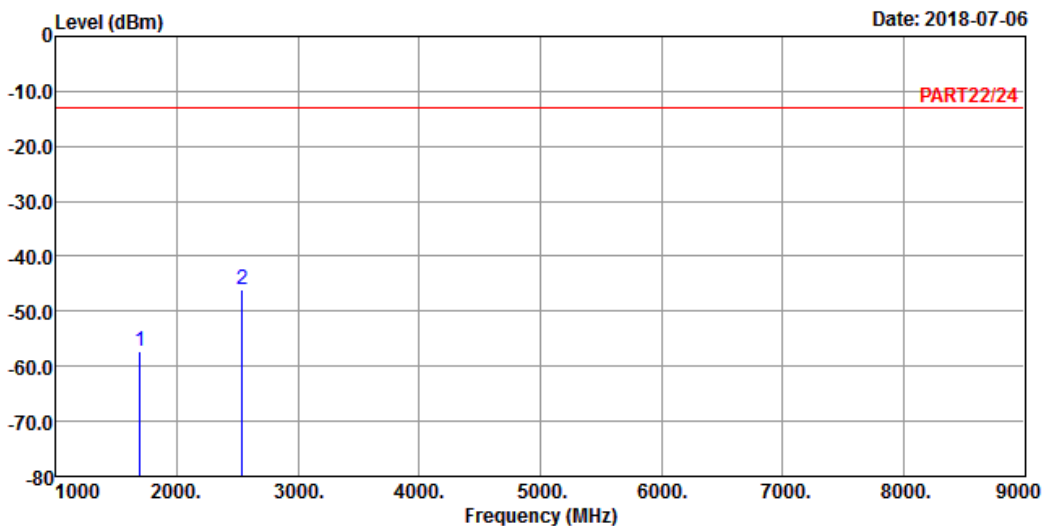

Site : 966 Chamber 5  
 Condition: PART22/24 HORIZONTAL  
 Remak : Cat-M1 Band 26 QPSK\_5M Link\_H-CH  
 Tested by: Thomas Wei

	Freq	Level	Read Level	Limit Line	Over Limit	Factor	Remark
	MHz	dBm	dBm	dBm	dB	dB	
1	1693.00	-57.24	-43.22	-13.00	-44.24	-14.02	Peak
2 pp	2539.50	-45.99	-35.93	-13.00	-32.99	-10.06	Peak



Bureau Veritas Consumer Products Services Ltd., Taoyuan Branch

A D T

Data: 2

Date: 2018-07-06

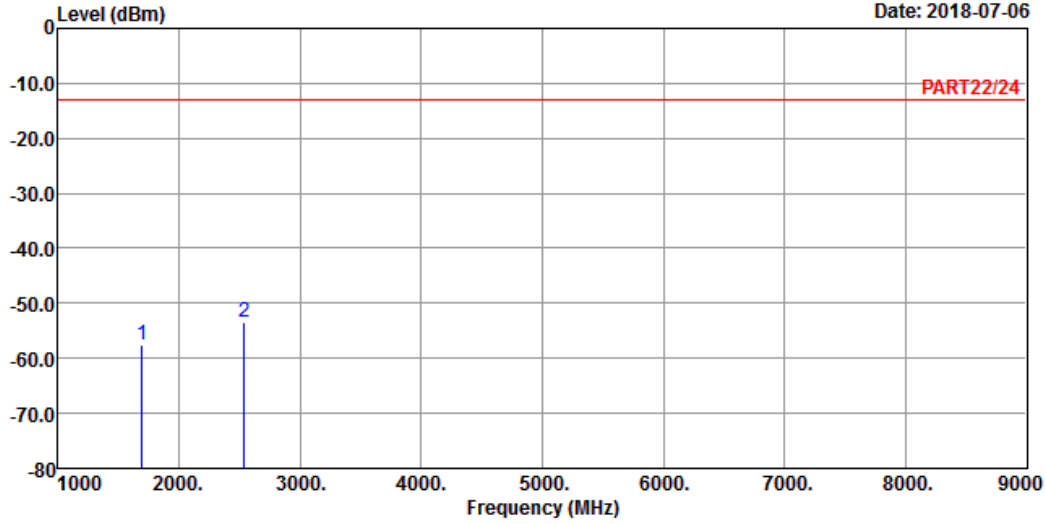

Site : 966 Chamber 5  
 Condition: PART22/24 VERTICAL  
 Remak : Cat-M1 Band 26 QPSK\_5M Link\_H-CH  
 Tested by: Thomas Wei

	Freq	Level	Read Level	Limit Line	Over Limit	Factor	Remark
	MHz	dBm	dBm	dBm	dB	dB	
1	1693.00	-57.44	-43.42	-13.00	-44.44	-14.02	Peak
2 pp	2539.50	-53.50	-43.44	-13.00	-40.50	-10.06	Peak

## 5 Pictures of Test Arrangements

Please refer to the attached file (Test Setup Photo).

## Appendix – Information on the Testing Laboratories

We, Bureau Veritas Consumer Products Services (H.K.) Ltd., Taoyuan Branch, were founded in 1988 to provide our best service in EMC, Radio, Telecom and Safety consultation. Our laboratories are FCC recognized accredited test firms and accredited according to ISO/IEC 17025.

If you have any comments, please feel free to contact us at the following:

**Linko EMC/RF Lab**

Tel: 886-2-26052180

Fax: 886-2-26051924

**Hsin Chu EMC/RF/Telecom Lab**

Tel: 886-3-6668565

Fax: 886-3-6668323

**Hwa Ya EMC/RF/Safety**

Tel: 886-3-3183232

Fax: 886-3-3270892

**Email:** [service.adt@tw.bureauveritas.com](mailto:service.adt@tw.bureauveritas.com)

**Web Site:** [www.bureauveritas-adt.com](http://www.bureauveritas-adt.com)

The address and road map of all our labs can be found in our web site also.

--- END ---