

FCC Test Report

(PART 90S)

Report No.: RF181126C15B-3

FCC ID: N7NHL78

Test Model: HL7800

Received Date: Jun. 02, 2020

Test Date: Jun. 03 ~ Jul. 01, 2020

Issued Date: Jul. 09, 2020

Applicant: Sierra Wireless Inc.

Address: 13811 Wireless Way, Richmond, BC, Canada V6V3A4

Issued By: Bureau Veritas Consumer Products Services (H.K.) Ltd., Taoyuan Branch
Lin Kou Laboratories

Lab Address: No. 47-2, 14th Ling, Chia Pau Vil., Lin Kou Dist., New Taipei City, Taiwan

Test Location: No.19, Hwa Ya 2nd Rd., Wen Hwa Vil., Kwei Shan Dist., Taoyuan City
33383, Taiwan

**FCC Registration /
Designation Number:** 788550 / TW0003



This report is for your exclusive use. Any copying or replication of this report to or for any other person or entity, or use of our name or trademark, is permitted only with our prior written permission. This report sets forth our findings solely with respect to the test samples identified herein. The results set forth in this report are not indicative or representative of the quality or characteristics of the lot from which a test sample was taken or any similar or identical product unless specifically and expressly noted. Our report includes all of the tests requested by you and the results thereof based upon the information that you provided to us. You have 60 days from date of issuance of this report to notify us of any material error or omission caused by our negligence, provided, however, that such notice shall be in writing and shall specifically address the issue you wish to raise. A failure to raise such issue within the prescribed time shall constitute your unqualified acceptance of the completeness of this report, the tests conducted and the correctness of the report contents. Unless specific mention, the uncertainty of measurement has been explicitly taken into account to declare the compliance or non-compliance to the specification. This report should not be used by the client to claim any endorsement by TAF.

Table of Contents

Release Control Record	3
1 Certificate of Conformity	4
2 Summary of Test Results	5
2.1 Measurement Uncertainty	5
2.2 Test Site and Instruments	6
3 General Information	7
3.1 General Description of EUT	7
3.2 Configuration of System under Test	8
3.2.1 Description of Support Units	8
3.3 Test Mode Applicability and Tested Channel Detail	9
3.4 EUT Operating Conditions	11
3.5 General Description of Applied Standards	11
4 Test Types and Results	12
4.1 Output Power Measurement	12
4.1.1 Limits of Output Power Measurement	12
4.1.2 Test Procedures	12
4.1.3 Test Setup	13
4.1.4 Test Results	14
4.2 Modulation Characteristics Measurement	23
4.2.1 Limits of Modulation Characteristics	23
4.2.2 Test Setup	23
4.2.3 Test Procedure	23
4.2.4 Test Results	24
4.3 Frequency Stability Measurement	25
4.3.1 Limits of Frequency Stability Measurement	25
4.3.2 Test Procedure	25
4.3.3 Test Setup	25
4.3.4 Test Results	26
4.4 Occupied Bandwidth Measurement	31
4.4.1 Limits of Occupied Bandwidth Measurement	31
4.4.2 Test Procedure	31
4.4.3 Test Setup	31
4.4.4 Test Results	32
4.5 Emission Mask Measurement	35
4.5.1 Limits of Emission Mask Measurement	35
4.5.2 Test Setup	35
4.5.3 Test Procedures	35
4.5.4 Test Results	36
4.6 Conducted Spurious Emissions	45
4.6.1 Limits of Conducted Spurious Emissions Measurement	45
4.6.2 Test Setup	45
4.6.3 Test Procedure	45
4.6.4 Test Results	46
4.7 Radiated Emission Measurement	51
4.7.1 Limits of Radiated Emission Measurement	51
4.7.2 Test Procedure	51
4.7.3 Deviation from Test Standard	51
4.7.4 Test Setup	52
4.7.5 Test Results	53
5 Pictures of Test Arrangements	73
Appendix – Information of the Testing Laboratories	74

Release Control Record

Issue No.	Description	Date Issued
RF181126C15B-3	Original Release	Jul. 09, 2020

1 Certificate of Conformity

Product: Embedded Module
Brand: AirPrime
Test Model: HL7800
Sample Status: Engineering Sample
Applicant: Sierra Wireless Inc.
Test Date: Jun. 03 ~ Jul. 01, 2020
Standards: FCC Part 90, Subpart I, S
FCC Part 2

The above equipment has been tested by **Bureau Veritas Consumer Products Services (H.K.) Ltd., Taoyuan Branch**, and found compliance with the requirement of the above standards. The test record, data evaluation & Equipment Under Test (EUT) configurations represented herein are true and accurate accounts of the measurements of the sample's RF characteristics under the conditions specified in this report.

Prepared by : Gina Liu, **Date:** Jul. 09, 2020
Gina Liu / Specialist

Approved by : Dylan Chiou, **Date:** Jul. 09, 2020
Dylan Chiou / Project Engineer

2 Summary of Test Results

Applied Standard: FCC Part 90 & Part 2 (LTE 26)			
FCC Clause	Test Item	Result	Remarks
2.1046 90.635 (b)	Effective Radiated Power	Pass	Meet the requirement of limit.
2.1047	Modulation Characteristics	Pass	Meet the requirement.
2.1055 90.213	Frequency Stability	Pass	Meet the requirement of limit.
2.1049 90.209	Occupied Bandwidth	Pass	Meet the requirement of limit.
2.1051 90.691	Emission Masks	Pass	Meet the requirement of limit.
2.1051 90.691	Conducted Spurious Emissions	Pass	Meet the requirement of limit.
2.1053 90.691	Radiated Spurious Emissions	Pass	Meet the requirement of limit. Minimum passing margin is -34.92 dB at 2457.00 MHz.

Note: Determining compliance based on the results of the compliance measurement, not taking into account measurement instrumentation uncertainty.

2.1 Measurement Uncertainty

Where relevant, the following measurement uncertainty levels have been estimated for tests performed on the EUT as specified in CISPR 16-4-2:

Measurement	Frequency	Expanded Uncertainty (k=2) (±)
Radiated Emissions up to 1 GHz	9 kHz ~ 30 MHz	3.04 dB
	30 MHz ~ 200 MHz	2.93 dB
	200 MHz ~ 1000 MHz	2.95 dB
Radiated Emissions above 1 GHz	1 GHz ~ 18 GHz	2.26 dB
	18 GHz ~ 40 GHz	1.94 dB

2.2 Test Site and Instruments

Description & Manufacturer	Model No.	Serial No.	Date of Calibration	Due Date of Calibration
Test Receiver Agilent	N9038A	MY51210203	Mar. 18, 2020	Mar. 17, 2021
Spectrum Analyzer Agilent	N9010A	MY52220314	Dec. 12, 2019	Dec. 11, 2020
Spectrum Analyzer ROHDE & SCHWARZ	FSU43	101261	Apr. 16, 2020	Apr. 15, 2021
HORN Antenna SCHWARZBECK	BBHA 9120D	9120D-969	Nov. 24, 2019	Nov. 23, 2020
BILOG Antenna SCHWARZBECK	VULB 9168	9168-160	Nov. 07, 2019	Nov. 06, 2020
BILOG Antenna SCHWARZBECK	VULB 9168	9168-472	Nov. 08, 2019	Nov. 07, 2020
Fixed Attenuator Mini-Circuits	MDCS18N-10	MDCS18N-10-01	Apr. 14, 2020	Apr. 13, 2021
MXG Vector signal generator Agilent	N5182B	MY53050430	Oct. 25, 2019	Oct. 24, 2020
Preamplifier EMCI	EMC 012645	980115	Oct. 08, 2019	Oct. 07, 2020
Preamplifier EMCI	EMC 330H	980112	Oct. 08, 2019	Oct. 07, 2020
RF Coaxial Cable HUBER+SUHNNER	EMC104-SM-SM-8000& 3000	140811+170717	Oct. 08, 2019	Oct. 07, 2020
RF Coaxial Cable HUBER+SUHNNER	SUCOFLEX 104	EMC104-SM-SM-100 0(140807)	Oct. 08, 2019	Oct. 07, 2020
RF Coaxial Cable WOKEN	8D-FB	Cable-Ch10-01	Oct. 08, 2019	Oct. 07, 2020
Boresight Antenna Fixture	FBA-01	FBA-SIP01	NA	NA
Software BV ADT	E3 6.120103	NA	NA	NA
Antenna Tower MF	MFA-440H	NA	NA	NA
Turn Table MF	MFT-201SS	NA	NA	NA
Antenna Tower & Turn Table Controller MF	MF-7802	NA	NA	NA
Radio Communication Analyzer Anritsu	MT8821C	6261806803	Jan. 18, 2020	Jan. 17, 2021
Spectrum Analyzer R&S	FSW43	101582	Mar. 31, 2020	Mar. 30 2021
Temperature & Humidity Chamber	GTH-120-40-CP-AR	MAA1306-019	Sep. 10, 2019	Sep. 09, 2020
DC Power Supply Topward	33010D	807748	NA	NA
Digital Multimeter Fluke	87-III	70360742	Jun. 27, 2019	Jun. 26, 2020
			Jun. 23, 2020	Jun. 22, 2021

- Note: 1. The calibration interval of the above test instruments is 12 months and the calibrations are traceable to NML/ROC and NIST/USA.
2. The test was performed in HwaYa Chamber 10.

3 General Information

3.1 General Description of EUT

Product	Embedded Module		
Brand	AirPrime		
Test Model	HL7800		
Status of EUT	Engineering Sample		
Power Supply Rating	5.0 Vdc (host equipment) 12.0 Vdc (adapter)		
Modulation Type	Cat-M1	QPSK, 16QAM	
	NB-IoT	BPSK, QPSK	
Frequency Range	Cat-M1	LTE Band 26 (Channel Bandwidth: 1.4 MHz)	814.7 ~ 823.3 MHz
		LTE Band 26 (Channel Bandwidth: 3 MHz)	815.5 ~ 822.5 MHz
		LTE Band 26 (Channel Bandwidth: 5 MHz)	816.5 ~ 821.5 MHz
		LTE Band 26 (Channel Bandwidth: 10 MHz)	819 MHz
	NB-IoT	LTE Band 26	814.2 ~ 823.8 MHz
Emission Designator	Cat-M1	LTE Band 26 (Channel Bandwidth: 1.4 MHz)	1M09G7D
		LTE Band 26 (Channel Bandwidth: 3 MHz)	1M09G7D
		LTE Band 26 (Channel Bandwidth: 5 MHz)	1M09D7W
		LTE Band 26 (Channel Bandwidth: 10 MHz)	1M09G7D
	NB-IoT	LTE Band 26	192KG7D
Max. ERP Power	Cat-M1	LTE Band 26 (Channel Bandwidth: 1.4 MHz)	181.55 mW
		LTE Band 26 (Channel Bandwidth: 3 MHz)	196.34 mW
		LTE Band 26 (Channel Bandwidth: 5 MHz)	207.01 mW
		LTE Band 26 (Channel Bandwidth: 10 MHz)	224.39 mW
	NB-IoT	LTE Band 26	169.43 mW (BPSK) 214.29 mW (QPSK)
Antenna Type	Dipole Antenna with 2 dBi gain		
Accessory Device	Refer to Note as below		
Data Cable Supplied	Refer to Note as below		

Note:

1. The above Antenna information is declared by manufacturer and for more detailed features description, please refer to the manufacturer's specifications, the laboratory shall not be held responsible.
2. The above EUT information is declared by manufacturer and for more detailed features description, please refers to the manufacturer's specifications or user's manual.

3.2 Configuration of System under Test

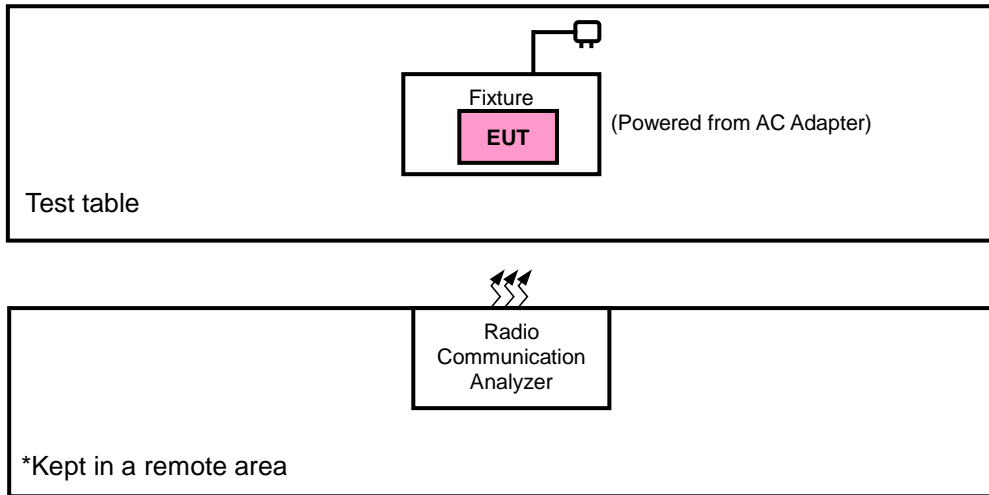

3.2.1 Description of Support Units

The EUT has been tested as an independent unit together with other necessary accessories or support units. The following support units or accessories were used to form a representative test configuration during the tests.

No.	Product	Brand	Model No.	Serial No.	FCC ID
1.	Adapter	N/A	N/A	N/A	N/A
2.	Radio Communication Analyzer	Anritsu	MT8821C	6201462755	N/A

No.	Signal Cable Description Of The Above Support Units
1.	N/A
2.	N/A

Note:

1. All power cords of the above support units are non-shielded (1.8m).
2. Item 1 was provided by client.

3.3 Test Mode Applicability and Tested Channel Detail

Pre-Scan has been conducted to determine the worst-case mode from all possible combinations between available modulations, data rates, XYZ axis, and antenna ports

The worst case was found when positioned as the table below. Following channel(s) was (were) selected for the final test as listed below:

Band	ERP	Radiated Emission
LTE Band 26	X-plane (Cat-M1) Z-plane (NB-IoT)	Z-axis (Cat-M1) X-axis (NB-IoT)

Cat-M1

LTE Band 26

-	ERP	26697 to 26783	26697, 26740, 26783	1.4 MHz	QPSK, 16QAM	1 RB / 0 RB Offset
		26705 to 26775	26705, 26740, 26775	3 MHz	QPSK, 16QAM	1 RB / 0 RB Offset
		26715 to 26765	26715, 26740, 26765	5 MHz	QPSK, 16QAM	1 RB / 0 RB Offset
		26740	26740	10 MHz	QPSK, 16QAM	1 RB / 0 RB Offset
-	Modulation characteristics	26740	26740	10 MHz	QPSK, 16QAM	6 RB / 0 RB Offset
-	Frequency Stability	26697 to 26783	26697, 26783	1.4 MHz	QPSK	6 RB / 0 RB Offset
		26705 to 26775	26705, 26775	3 MHz	QPSK	6 RB / 0 RB Offset
		26715 to 26765	26715, 26765	5 MHz	QPSK	6 RB / 0 RB Offset
		26740	26740	10 MHz	QPSK	6 RB / 0 RB Offset
-	Occupied Bandwidth	26697 to 26783	26697, 26740, 26783	1.4 MHz	QPSK, 16QAM	6 RB / 0 RB Offset
		26705 to 26775	26705, 26740, 26775	3 MHz	QPSK, 16QAM	6 RB / 0 RB Offset
		26715 to 26765	26715, 26740, 26765	5 MHz	QPSK, 16QAM	6 RB / 0 RB Offset
		26740	26740	10 MHz	QPSK, 16QAM	6 RB / 0 RB Offset
-	Emission Mask	26697 to 26783	26697, 26783	1.4 MHz	QPSK, 16QAM	6 RB / 0 RB Offset 1 RB / 0 RB Offset 1 RB / 5 RB Offset
		26705 to 26775	26705, 26775	3 MHz	QPSK, 16QAM	6 RB / 0 RB Offset 1 RB / 0 RB Offset 1 RB / 5 RB Offset
		26715 to 26765	26715, 26765	5 MHz	QPSK, 16QAM	6 RB / 0 RB Offset 1 RB / 0 RB Offset 1 RB / 5 RB Offset
		26740	26740	10 MHz	QPSK, 16QAM	6 RB / 0 RB Offset 1 RB / 0 RB Offset 1 RB / 5 RB Offset
-	Conducted Emission	26697 to 26783	26697, 26740, 26783	1.4 MHz	QPSK	1 RB / 0 RB Offset
		26705 to 26775	26705, 26740, 26775	3 MHz	QPSK	1 RB / 0 RB Offset
		26715 to 26765	26715, 26740, 26765	5 MHz	QPSK	1 RB / 0 RB Offset
		26740	26740	10 MHz	QPSK	1 RB / 0 RB Offset
-	Radiated Emission	26697 to 26783	26697, 26740, 26783	1.4 MHz	QPSK	1 RB / 0 RB Offset
		26715 to 26765	26715, 26740, 26765	5 MHz	QPSK	1 RB / 0 RB Offset
		26740	26740	10 MHz	QPSK	1 RB / 0 RB Offset

Note:

1. This device was tested under all bandwidths, RB configurations and modulations. The worst case was found in QPSK modulation. Therefore, only ERP, modulation characteristics, occupied bandwidth items had been tested under QPSK, 16QAM mode, the other items were performed under QPSK mode only.
2. For radiated emission above 1 GHz, according to 3GPP 36.521 Section 6.6.3.1.4, choose the lowest, 5 MHz & highest channel bandwidth for final test.
3. For radiated emissions below 1 GHz, select the worst radiated emission channel for final testing.

NB-IoT
LTE Band 26

EUT Configure Mode	Test Item	Available Channel	Tested Channel	Sub-carrier Bandwidth	Modulation	N _{tones}
-	ERP	26692 to 26788	26692, 26740, 26788	3.75 kHz	BPSK	1@0
				15 kHz	QPSK	3@3
-	Modulation Characteristics	26692 to 26788	26740	3.75 kHz	BPSK	1@0
				15 kHz	QPSK	12@0
-	Frequency Stability	26692 to 26788	26692, 26788	15 kHz	QPSK	12@0
-	Occupied Bandwidth	26692 to 26788	26692	3.75 kHz	BPSK	1@0
				15 kHz	QPSK	1@0
						3@3
						12@0
			26740	3.75 kHz	BPSK	1@0
				15 kHz	QPSK	3@3
						12@0
						12@0
			26788	3.75 kHz	BPSK	1@47
				15 kHz	QPSK	1@11
						3@3
						12@0
-	Band Edge	26692 to 26788	26692	3.75 kHz	BPSK	1@0
				15 kHz	QPSK	1@0
						3@3
						12@0
			26788	3.75 kHz	BPSK	1@47
				15 kHz	QPSK	1@11
						3@3
						12@0
-	Peak to Average Ratio	26692 to 26788	26740	3.75 kHz	BPSK	1@0
				15 kHz	QPSK	1@0
						3@3
-	Conducted Emission	26692 to 26788	26692, 26740, 26788	15 kHz	QPSK	3@3
-	Radiated Emission	26692 to 26788	26692, 26740, 26788	15 kHz	QPSK	3@3

Note:

1. Selection is tested with Stand-alone, In-band and Guard-band, the worst case was found in Stand-alone.
2. For radiated emission and conducted emission test, pre-tested BPSK, QPSK modulation type and found QPSK was the worst, therefore chosen for the final test.
3. The emission measurement was based on the worst maximum conducted power.

Test Condition:

Test Item	Environmental Conditions	Input Power	Tested By
ERP	25 deg. C, 65 % RH	12 Vdc	Jisyong Wang
Frequency Stability	25 deg. C, 65 % RH	12 Vdc	Getaz Yang
Occupied Bandwidth	25 deg. C, 65 % RH	12 Vdc	Getaz Yang
Peak to Average Ratio	25 deg. C, 65 % RH	12 Vdc	Getaz Yang
Emission Mask	25 deg. C, 65 % RH	12 Vdc	Getaz Yang
Band Edge	25 deg. C, 65 % RH	12 Vdc	Getaz Yang
Conducted Emission	25 deg. C, 65 % RH	12 Vdc	Getaz Yang
Radiated Emission	25 deg. C, 65 % RH	12 Vdc	Jisyong Wang

3.4 EUT Operating Conditions

The EUT makes a call to the communication simulator. The communication simulator station system controlled a EUT to export maximum output power under transmission mode and specific channel frequency

3.5 General Description of Applied Standards

The EUT is a RF Product. According to the specifications of the manufacturer, it must comply with the requirements of the following standards and references:

Test Standard:

FCC 47 CFR Part 2

FCC 47 CFR Part 90

ANSI 63.26-2015

Note: All test items have been performed and recorded as per the above standards.

References Test Guidance:

KDB 971168 D01 Power Meas License Digital Systems v03r01

KDB 971168 D02 Misc Rev Approv License Devices v02r01

ANSI/TIA/EIA-603-E 2016

Note: All test items have been performed as a reference to the above KDB test guidance.

4 Test Types and Results

4.1 Output Power Measurement

4.1.1 Limits of Output Power Measurement

The maximum output power of the transmitter for mobile stations is 100 watts (20 dBw) ERP.

4.1.2 Test Procedures

EIRP / ERP Measurement:

- a. All measurements were done at low, middle and high operational frequency range. RBW is 10 MHz for LTE mode, and VBW $\geq 3 \times$ RBW.
- b. Substitution method is used for E.I.R.P measurement. In the semi-anechoic chamber, EUT placed on the 0.8 m (below or equal 1 GHz) and/or 1.5 m (above 1 GHz) height of Turn Table, rotated the table around 360 degrees to search the maximum radiation power and receiver antenna shall be rotated vertical and horizontal polarization and moved height from 1 m to 4 m to find the maximum polar radiated power. The "Read Value" is the spectrum reading the maximum power value.
- c. The substitution horn antenna is substituted for EUT at the same position and signals generator export the CW signal to the substitution antenna via a tx cable. Rotated the Turn Table and moved receiving antenna to find the maximum radiation power. Adjust output power level of S.G to get a Value of spectrum reading equal to "Read Value" of step b. Record the power level of S.G.
- d. $EIRP = \text{Output power level of S.G} - \text{TX cable loss} + \text{Antenna gain of substitution horn}$. E.R.P power can be calculated form E.I.R.P power by subtracting the gain of dipole, $E.R.P \text{ power} = E.I.P.R \text{ power} - 2.15 \text{ dB}$.

Conducted Power Measurement:

- a. The EUT was set up for the maximum power with LTE link data modulation and link up with simulator.
- b. Set the EUT to transmit under low, middle and high channel and record the power level shown on simulator.

4.1.3 Test Setup

EIRP / ERP Measurement:

<Radiated Emission below or equal 1 GHz>

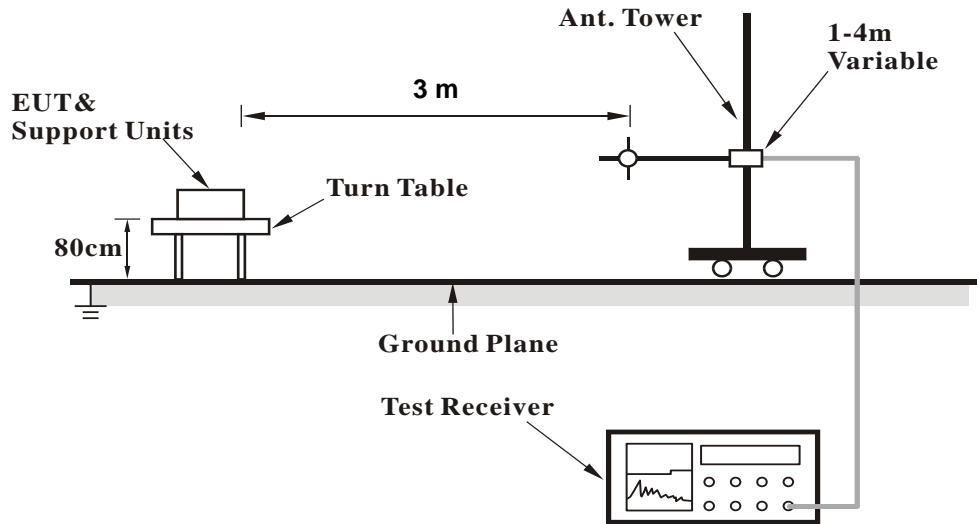

<Radiated Emission above 1 GHz>

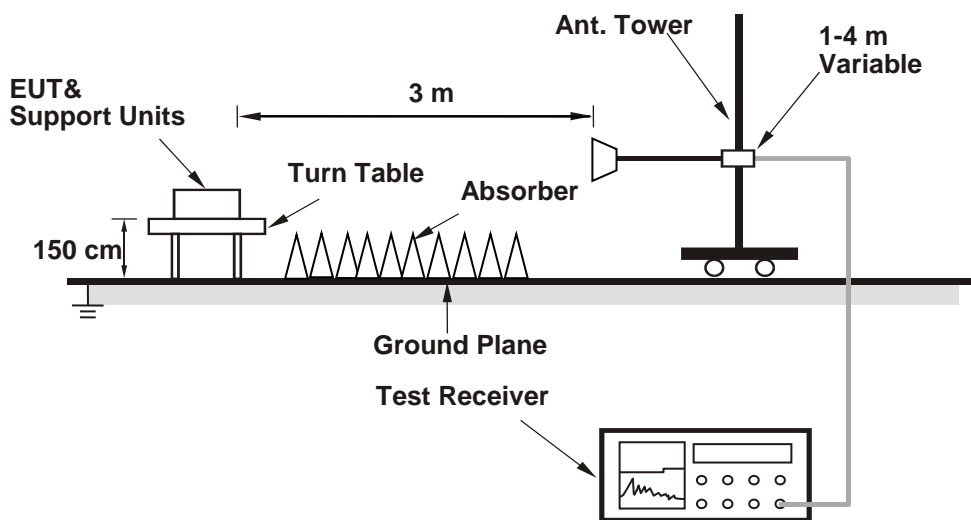

For the actual test configuration, please refer to the attached file (Test Setup Photo).

Conducted Power Measurement:



4.1.4 Test Results

Conducted Output Power (dBm)

Cat-M1

LTE Band 26								
BW (MHz): 1.4								
Test Frequency ID	N _{UL}	Frequency of Uplink (MHz)	Test Configuration Initial of Power				EUT	
			Modulation	RB Size	RB Offset	Narrowband Index	Cell Power (dBm/15 kHz)	Power (dBm)
Low Range	26697	814.7	QPSK	1	0	0	-85	23.61
			QPSK	1	5	0	-85	23.55
			QPSK	3	3	0	-85	21.99
			QPSK	6	0	0	-85	21.37
			16QAM	1	0	0	-85	23.21
			16QAM	1	5	0	-85	23.1
			16QAM	3	0	0	-85	22.18
Mid. Range	26740	819	16QAM	5	0	0	-85	22.22
			QPSK	1	0	0	-85	23.48
			QPSK	1	5	0	-85	23.46
			QPSK	3	3	0	-85	21.9
			QPSK	6	0	0	-85	21.3
			16QAM	1	0	0	-85	23.04
			16QAM	1	5	0	-85	23.12
High Range	26783	823.3	16QAM	3	0	0	-85	22.2
			16QAM	5	0	0	-85	22.12
			QPSK	1	0	0	-85	23.55
			QPSK	1	5	0	-85	23.42
			QPSK	3	3	0	-85	22.1
			QPSK	6	0	0	-85	21.32
			16QAM	1	0	0	-85	23.08
			16QAM	1	5	0	-85	23.04
			16QAM	3	0	0	-85	22.19
			16QAM	5	0	0	-85	22.03

LTE Band 26								
BW (MHz): 3								
Test Frequency ID	N _{UL}	Frequency of Uplink (MHz)	Test Configuration Initial of Power				EUT	
			Modulation	RB Size	RB Offset	Narrowband Index	Cell Power (dBm/15 kHz)	Power (dBm)
Low Range	26705	815.5	QPSK	1	0	0	-85	23.24
			QPSK	1	5	0	-85	23.27
			QPSK	1	0	1	-85	23.46
			QPSK	1	5	1	-85	23.35
			QPSK	3	3	0	-85	22.99
			QPSK	3	3	1	-85	22.22
			QPSK	6	0	0	-85	21.55
			QPSK	6	0	1	-85	21.03
			16QAM	1	0	0	-85	23.43
			16QAM	1	5	0	-85	23.1
			16QAM	1	0	1	-85	23.19
			16QAM	1	5	1	-85	23.2
			16QAM	3	0	0	-85	22.45
			16QAM	3	3	1	-85	22.28
16QAM	5	0	0	-85	22.07			
16QAM	5	0	1	-85	22.2			
Mid. Range	26740	819	QPSK	1	0	0	-85	23.5
			QPSK	1	5	0	-85	23.55
			QPSK	1	0	1	-85	23.59
			QPSK	1	5	1	-85	23.39
			QPSK	3	3	0	-85	22.2
			QPSK	3	3	1	-85	22.24
			QPSK	6	0	0	-85	21.23
			QPSK	6	0	1	-85	20.94
			16QAM	1	0	0	-85	23.28
			16QAM	1	5	0	-85	23.23
			16QAM	1	0	1	-85	23.3
			16QAM	1	5	1	-85	23.11
			16QAM	3	0	0	-85	22.61
			16QAM	3	3	1	-85	22.25
16QAM	5	0	0	-85	22.38			
16QAM	5	0	1	-85	22.11			
High Range	26775	822.5	QPSK	1	0	0	-85	23.45
			QPSK	1	5	0	-85	23.54
			QPSK	1	0	1	-85	23.56
			QPSK	1	5	1	-85	23.43
			QPSK	3	3	0	-85	22.15
			QPSK	3	3	1	-85	22.2
			QPSK	6	0	0	-85	21.23
			QPSK	6	0	1	-85	20.97
			16QAM	1	0	0	-85	23.19
			16QAM	1	5	0	-85	23.17
			16QAM	1	0	1	-85	23.27
			16QAM	1	5	1	-85	23.13
			16QAM	3	0	0	-85	22.37
			16QAM	3	3	1	-85	22.19
16QAM	5	0	0	-85	22.32			
16QAM	5	0	1	-85	22			

LTE Band 26								
BW (MHz): 5								
Test Frequency ID	N _{UL}	Frequency of Uplink (MHz)	Test Configuration Initial of Power				EUT	
			Modulation	RB Size	RB Offset	Narrowband Index	Cell Power (dBm/15 kHz)	Power (dBm)
Low Range	26715	816.5	QPSK	1	0	0	-85	23.35
			QPSK	1	5	0	-85	23.44
			QPSK	1	0	1	-85	23.38
			QPSK	1	5	1	-85	23.3
			QPSK	1	0	3	-85	23.21
			QPSK	1	5	3	-85	23.23
			QPSK	3	0	0	-85	22.51
			QPSK	3	3	3	-85	22.27
			QPSK	6	0	0	-85	22.2
			QPSK	6	0	1	-85	22.42
			QPSK	6	0	3	-85	22.26
			16QAM	1	0	0	-85	23.35
			16QAM	1	5	0	-85	23.48
			16QAM	1	0	1	-85	23.4
			16QAM	1	5	1	-85	23.44
			16QAM	1	0	3	-85	23.34
			16QAM	1	5	3	-85	23.29
			16QAM	3	0	0	-85	22.44
16QAM	3	3	3	-85	22.25			
16QAM	5	0	0	-85	22.35			
16QAM	5	0	1	-85	22.42			
16QAM	5	0	3	-85	22.3			
Mid. Range	26740	819	QPSK	1	0	0	-85	23.65
			QPSK	1	5	0	-85	23.55
			QPSK	1	0	1	-85	23.39
			QPSK	1	5	1	-85	23.38
			QPSK	1	0	3	-85	23.34
			QPSK	1	5	3	-85	23.33
			QPSK	3	0	0	-85	22.96
			QPSK	3	3	3	-85	23.05
			QPSK	6	0	0	-85	22.65
			QPSK	6	0	1	-85	22.72
			QPSK	6	0	3	-85	22.39
			16QAM	1	0	0	-85	23.49
			16QAM	1	5	0	-85	23.48
			16QAM	1	0	1	-85	23.4
			16QAM	1	5	1	-85	23.49
			16QAM	1	0	3	-85	23.31
			16QAM	1	5	3	-85	23.27
			16QAM	3	0	0	-85	22.65
16QAM	3	3	3	-85	22.55			
16QAM	5	0	0	-85	22.71			
16QAM	5	0	1	-85	22.75			
16QAM	5	0	3	-85	22.37			

LTE Band 26								
BW (MHz): 5								
Test Frequency ID	N _{UL}	Frequency of Uplink (MHz)	Test Configuration Initial of Power				EUT	
			Modulation	RB Size	RB Offset	Narrowband Index	Cell Power (dBm/15 kHz)	Power (dBm)
High Range	26765	821.5	QPSK	1	0	0	-85	23.22
			QPSK	1	5	0	-85	23.1
			QPSK	1	0	1	-85	23.13
			QPSK	1	5	1	-85	23.18
			QPSK	1	0	3	-85	23.3
			QPSK	1	5	3	-85	23.27
			QPSK	3	0	0	-85	22.5
			QPSK	3	3	3	-85	22.47
			QPSK	6	0	0	-85	22.53
			QPSK	6	0	1	-85	22.54
			QPSK	6	0	3	-85	22.44
			16QAM	1	0	0	-85	23.61
			16QAM	1	5	0	-85	23.42
			16QAM	1	0	1	-85	23.42
			16QAM	1	5	1	-85	23.32
			16QAM	1	0	3	-85	23.23
			16QAM	1	5	3	-85	23.27
			16QAM	3	0	0	-85	22.33
16QAM	3	3	3	-85	22.26			
16QAM	5	0	0	-85	22.38			
16QAM	5	0	1	-85	23.38			
16QAM	5	0	3	-85	23.33			

LTE Band 26								
BW (MHz): 10								
Test Frequency ID	N _{UL}	Frequency of Uplink (MHz)	Test Configuration Initial of Power				EUT	
			Modulation	RB Size	RB Offset	Narrowband Index	Cell Power (dBm/15 kHz)	Power (dBm)
Mid. Range	26740	819	QPSK	1	0	0	-85	23.71
			QPSK	1	5	0	-85	23.68
			QPSK	1	0	3	-85	23.09
			QPSK	1	5	3	-85	23.34
			QPSK	1	0	7	-85	23.28
			QPSK	1	5	7	-85	23.33
			QPSK	4	0	0	-85	23.28
			QPSK	4	2	7	-85	23.55
			QPSK	6	0	0	-85	22.43
			QPSK	6	0	7	-85	22.81
			16QAM	1	0	0	-85	23.32
			16QAM	1	5	0	-85	23.18
			16QAM	1	0	3	-85	23.37
			16QAM	1	5	3	-85	23.22
			16QAM	1	0	7	-85	23.47
			16QAM	1	5	7	-85	23.63
			16QAM	4	2	0	-85	23.3
			16QAM	4	2	7	-85	23.49
16QAM	5	0	0	-85	22.24			
16QAM	5	0	7	-85	22.7			

NB-IoT

LTE Band 26							
Stand-alone							
N _{UL}	M _{UL}	Frequency of Uplink (MHz)	Test Configuration Initial of Power			EUT	
			Modulation	N _{tones}	Sub-carrier Spacing (kHz)	Cell Power (dBm/15 kHz)	Power (dBm)
26692	0	814.2	BPSK	1@0	3.75	-110	21.61
			BPSK	1@0	15	-110	21.62
			QPSK	1@0	3.75	-110	21.7
			QPSK	1@0	15	-110	21.72
			QPSK	3@3	15	-110	21.94
			QPSK	12@0	15	-110	21.59
26740	0	819	BPSK	1@0	3.75	-110	23.22
			BPSK	1@0	15	-110	23.25
			BPSK	1@47	3.75	-110	23.21
			QPSK	1@0	3.75	-110	23.31
			QPSK	1@0	15	-110	23.33
			QPSK	1@11	15	-110	23.34
			QPSK	3@3	15	-110	23.54
26788	0	823.8	BPSK	1@47	3.75	-110	21.67
			BPSK	1@47	15	-110	21.68
			QPSK	1@11	3.75	-110	21.74
			QPSK	1@11	15	-110	21.77
			QPSK	3@3	15	-110	21.98
			QPSK	12@0	15	-110	21.55

LTE Band 26							
In-Band	BW (MHz): 3						
N _{UL}	M _{UL}	Frequency of Uplink (MHz)	Test Configuration Initial of Power			EUT	
			Modulation	N _{tones}	Sub-carrier Spacing (kHz)	Cell Power (dBm/15 kHz)	Power (dBm)
26698	0	814.8	BPSK	1@0	3.75	-110	21.51
			QPSK	1@0	15	-110	21.63
			QPSK	3@3	15	-110	21.81
			QPSK	12@0	15	-110	21.46
26731	0	818.1	BPSK	1@0	3.75	-110	23.11
			BPSK	1@47	3.75	-110	23.09
			QPSK	1@0	15	-110	23.2
			QPSK	1@11	15	-110	23.19
			QPSK	3@3	15	-110	23.43
			QPSK	12@0	15	-110	22.9
26782	0	823.2	BPSK	1@47	3.75	-110	21.53
			QPSK	1@11	15	-110	21.62
			QPSK	3@3	15	-110	21.86
			QPSK	12@0	15	-110	21.42

LTE Band 26							
In-Band	BW (MHz): 10	NB-IoT PRB: 30					
N _{UL}	M _{UL}	Frequency of Uplink (MHz)	Test Configuration Initial of Power			EUT	
			Modulation	N _{tones}	Sub-carrier Spacing (kHz)	Cell Power (dBm/15 kHz)	Power (dBm)
26750	-2	819.99	BPSK	1@0	3.75	-110	23.07
			BPSK	1@47	3.75	-110	23.09
			QPSK	1@0	15	-110	23.22
			QPSK	1@11	15	-110	23.23
			QPSK	3@3	15	-110	23.45
			QPSK	12@0	15	-110	22.91

LTE Band 26							
In-Band	BW (MHz): 10	NB-IoT PRB: 35	Test Configuration Initial of Power			EUT	
N _{UL}	M _{UL}	Frequency of Uplink (MHz)	Modulation	N _{tones}	Sub-carrier Spacing (kHz)	Cell Power (dBm/15 kHz)	Power (dBm)
			26759	-2	820.89	BPSK	1@0
			BPSK	1@47	3.75	-110	23.11
			QPSK	1@0	15	-110	23.18
			QPSK	1@11	15	-110	23.21
			QPSK	3@3	15	-110	23.38
			QPSK	12@0	15	-110	22.92

LTE Band 26							
Guard-Band	BW (MHz): 5	Frequency of Uplink (MHz)	Test Configuration Initial of Power			EUT	
N _{UL}	M _{UL}		Modulation	N _{tones}	Sub-carrier Spacing (kHz)	Cell Power (dBm/15 kHz)	Power (dBm)
26692	0	814.2	BPSK	1@0	3.75	-110	21.51
			QPSK	1@0	15	-110	21.61
			QPSK	3@3	15	-110	21.82
			QPSK	12@0	15	-110	21.49
26716	0	816.6	BPSK	1@0	3.75	-110	23.12
			BPSK	1@47	3.75	-110	23.07
			QPSK	1@0	15	-110	23.24
			QPSK	1@11	15	-110	23.25
26788	0	823.8	QPSK	3@3	15	-110	23.44
			QPSK	12@0	15	-110	22.89
			BPSK	1@47	3.75	-110	21.53
			QPSK	1@11	15	-110	21.64
			QPSK	3@3	15	-110	21.88
			QPSK	12@0	15	-110	21.39

ERP Power (dBm)
Cat-M1

LTE Band 26							
Channel Bandwidth: 1.4 MHz / QPSK							
Plane	Channel	Frequency (MHz)	Reading (dBm)	Correction Factor (dB)	ERP (dBm)	ERP (mW)	Polarization (H/V)
Z	26697	814.7	-7.39	32.01	22.47	176.60	H
	26740	819.0	-7.37	32.11	22.59	181.55	
	26783	823.3	-7.59	32.32	22.58	181.13	
	26697	814.7	-12.90	32.54	17.49	56.10	V
	26740	819.0	-12.76	32.51	17.60	57.54	
	26783	823.3	-12.82	32.51	17.54	56.75	
Channel Bandwidth: 1.4 MHz / 16QAM							
Z	26697	814.7	-8.33	32.01	21.53	142.23	H
	26740	819.0	-8.31	32.11	21.65	146.22	
	26783	823.3	-8.53	32.32	21.64	145.88	
	26697	814.7	-13.84	32.54	16.55	45.19	V
	26740	819.0	-13.70	32.51	16.66	46.34	
	26783	823.3	-13.76	32.51	16.60	45.71	

Note: ERP (dBm) = Reading (dBm) + Correction Factor (dB) – 2.15

LTE Band 26							
Channel Bandwidth: 3 MHz / QPSK							
Plane	Channel	Frequency (MHz)	Reading (dBm)	Correction Factor (dB)	ERP (dBm)	ERP (mW)	Polarization (H/V)
Z	26705	815.5	-7.06	32.02	22.81	190.99	H
	26740	819.0	-7.03	32.11	22.93	196.34	
	26775	822.5	-7.11	32.18	22.92	195.88	
	26705	815.5	-12.52	32.5	17.83	60.67	V
	26740	819.0	-12.42	32.51	17.94	62.23	
	26775	822.5	-12.44	32.47	17.88	61.38	
Channel Bandwidth: 3 MHz / 16QAM							
Z	26705	815.5	-8.09	32.02	21.78	150.66	H
	26740	819.0	-8.06	32.11	21.90	154.88	
	26775	822.5	-8.14	32.18	21.89	154.53	
	26705	815.5	-13.55	32.5	16.80	47.86	V
	26740	819.0	-13.45	32.51	16.91	49.09	
	26775	822.5	-13.47	32.47	16.85	48.42	

Note: ERP (dBm) = Reading (dBm) + Correction Factor (dB) – 2.15

LTE Band 26							
Channel Bandwidth: 5 MHz / QPSK							
Plane	Channel	Frequency (MHz)	Reading (dBm)	Correction Factor (dB)	ERP (dBm)	ERP (mW)	Polarization (H/V)
Z	26715	816.5	-6.85	32.04	23.04	201.37	H
	26740	819.0	-6.80	32.11	23.16	207.01	
	26765	821.5	-6.49	31.79	23.15	206.54	
	26715	816.5	-12.31	32.52	18.06	63.97	V
	26740	819.0	-12.19	32.51	18.17	65.61	
	26765	821.5	-11.91	32.17	18.11	64.71	
Channel Bandwidth: 5 MHz / 16QAM							
Z	26715	816.5	-7.87	32.04	22.02	159.22	H
	26740	819.0	-7.82	32.11	22.14	163.68	
	26765	821.5	-7.51	31.79	22.13	163.31	
	26715	816.5	-13.33	32.52	17.04	50.58	V
	26740	819.0	-13.21	32.51	17.15	51.88	
	26765	821.5	-12.93	32.17	17.09	51.17	

Note: ERP (dBm) = Reading (dBm) + Correction Factor (dB) – 2.15

LTE Band 26							
Channel Bandwidth: 10 MHz / QPSK							
Plane	Channel	Frequency (MHz)	Reading (dBm)	Correction Factor (dB)	ERP (dBm)	ERP (mW)	Polarization (H/V)
Z	26740	819.0	-6.45	32.11	23.51	224.39	H
	26740	819.0	-11.84	32.51	18.52	71.12	V
Channel Bandwidth: 10 MHz / 16QAM							
Z	26740	819.0	-7.46	32.11	22.50	177.83	H
	26740	819.0	-12.85	32.51	17.51	56.36	V

Note: ERP (dBm) = Reading (dBm) + Correction Factor (dB) – 2.15

NB-IoT

LTE Band 26							
BPSK							
Plane	Channel	Frequency (MHz)	Reading (dBm)	Correction Factor (dB)	ERP (dBm)	ERP (mW)	Polarization (H/V)
Z	26692	814.2	-12.99	32.01	16.87	48.64	H
	26740	819	-12.36	32.11	17.60	57.54	
	26788	823.8	-13.16	32.32	17.01	50.23	
	V	26692	814.2	-9.69	32.54	20.70	117.49
		26740	819	-8.07	32.51	22.29	169.43
		26788	823.8	-9.60	32.51	20.76	119.12
QPSK							
Z	26692	814.2	-11.97	32.01	17.89	61.52	H
	26740	819	-11.34	32.11	18.62	72.78	
	26788	823.8	-12.14	32.32	18.03	63.53	
	V	26692	814.2	-8.67	32.54	21.72	148.59
		26740	819	-7.05	32.51	23.31	214.29
		26788	823.8	-8.58	32.51	21.78	150.66

Note: ERP (dBm) = Reading (dBm) + Correction Factor (dB) – 2.15

4.2 Modulation Characteristics Measurement

4.2.1 Limits of Modulation Characteristics

N/A

4.2.2 Test Setup



4.2.3 Test Procedure

Connect the EUT to Communication Simulator via the antenna connector. The frequency band is set as EUT supported Modulation and Channels, the EUT output is matched with 50 ohm load, the waveform quality and constellation of the EUT was tested.

4.2.4 Test Results

Cat-M1

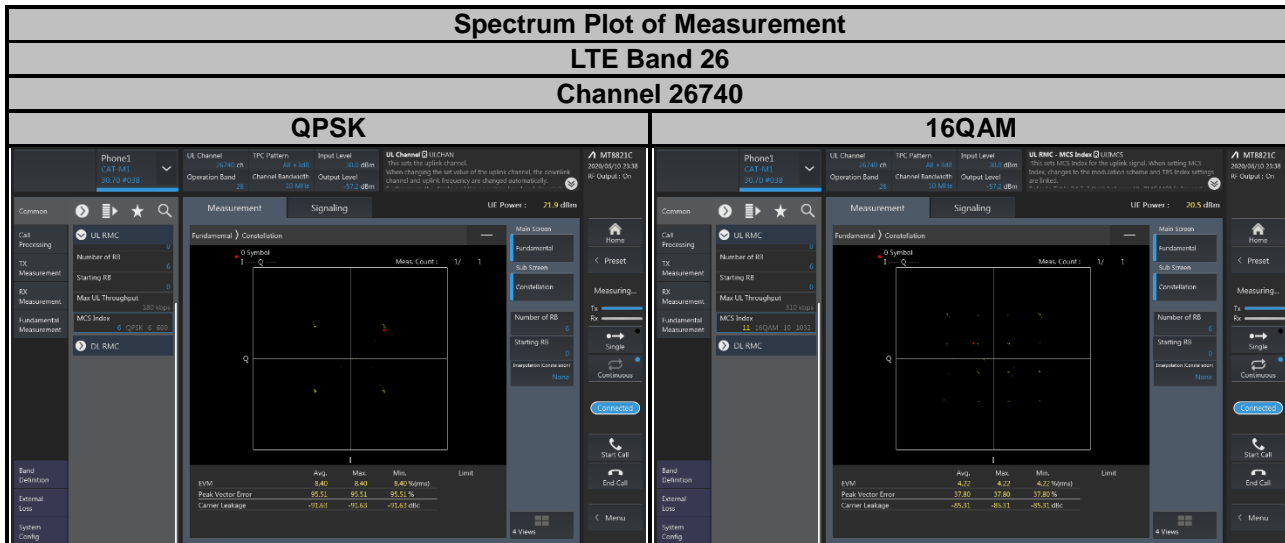

NB-IoT

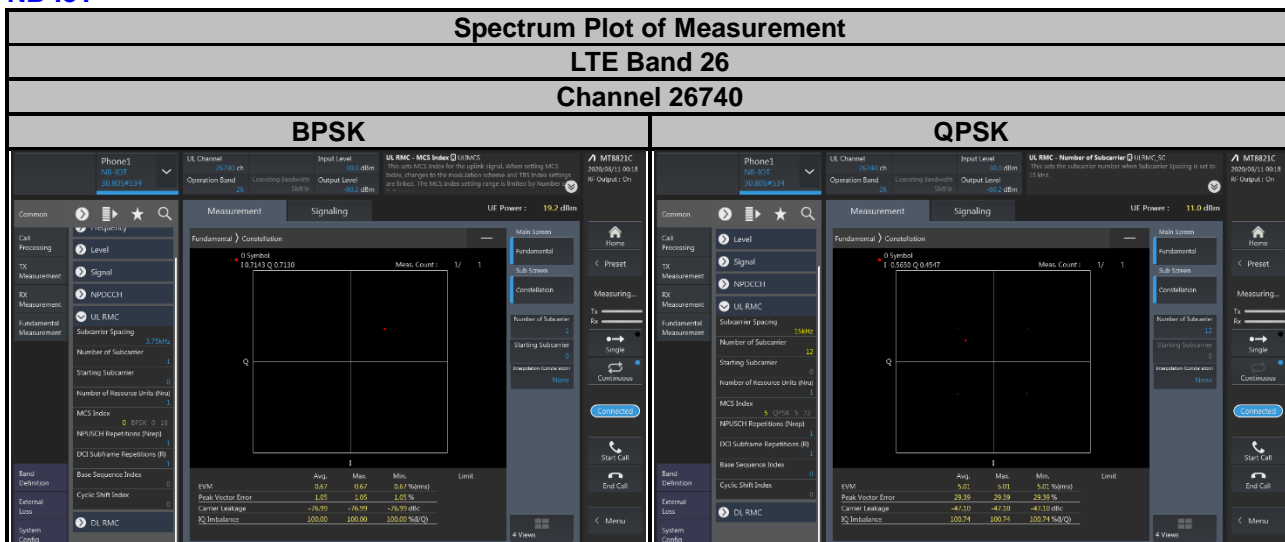

4.3 Frequency Stability Measurement

4.3.1 Limits of Frequency Stability Measurement

LTE Band 26

1.5 ppm is for base and fixed station. 2.5 ppm is for mobile station.

4.3.2 Test Procedure

- Device is placed at the oven room. The oven room could control the temperatures and humidity. Power warm up is at least 15 min and power applied should perform before recording frequency error.
- EUT is connected the external power supply to control the DC input power. The test voltage range is from minimum to maximum working voltage. Each step shall be record the frequency error rate.
- The temperature range step is 10 degrees in this test items. All temperature levels shall be hold the ± 0.5 °C during the measurement testing. The each temperature step shall be at least 0.5 hours, consider the EUT could be test under the stability condition.

NOTE: The frequency error was recorded frequency error from the communication simulator.

4.3.3 Test Setup

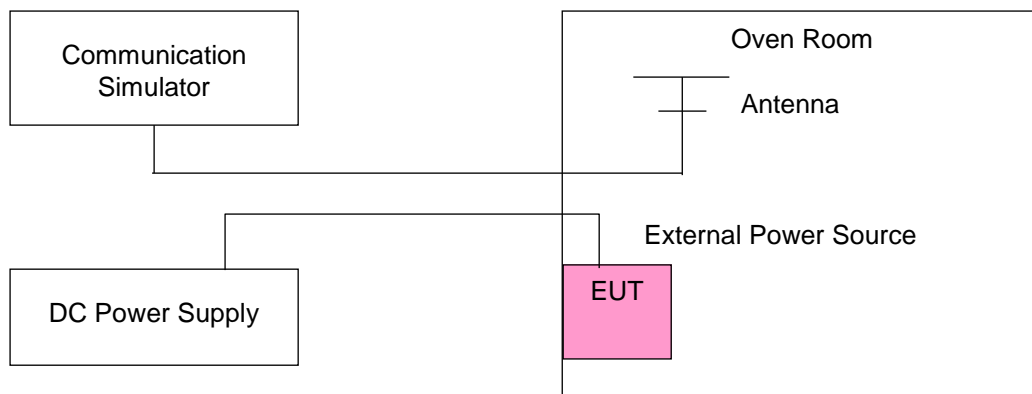

4.3.4 Test Results

Cat-M1

Frequency Error vs. Voltage

Voltage (Volts)	LTE Band 26				Limit (ppm)
	Channel Bandwidth: 1.4 MHz				
	Low Channel		High Channel		
	Frequency (MHz)	Frequency Error (ppm)	Frequency (MHz)	Frequency Error (ppm)	
10.2	814.700002	0.002	823.300000	0.004	2.5
12	814.700003	0.003	823.300000	0.002	2.5
13.8	814.700002	0.002	823.300000	0.005	2.5

Note: The fixture defined the normal working voltage of the adapter is from 10.2 Vdc to 13.8 Vdc.

Frequency Error vs. Temperature

Temp. (°C)	LTE Band 26				Limit (ppm)
	Channel Bandwidth: 1.4 MHz				
	Low Channel		High Channel		
	Frequency (MHz)	Frequency Error (ppm)	Frequency (MHz)	Frequency Error (ppm)	
-30	814.700001	0.002	823.300000	0.002	2.5
-20	814.700002	0.003	823.300000	0.005	2.5
-10	814.700002	0.003	823.300000	0.004	2.5
0	814.700002	0.002	823.300000	0.005	2.5
10	814.700002	0.003	823.300000	0.004	2.5
20	814.699999	-0.002	823.300000	-0.004	2.5
30	814.699997	-0.004	823.300000	-0.002	2.5
40	814.699998	-0.002	823.300000	-0.003	2.5
50	814.699998	-0.002	823.300000	-0.004	2.5
60	814.699997	-0.004	823.300000	-0.003	2.5
70	814.699998	-0.002	823.300000	-0.004	2.5
80	814.699999	-0.001	823.300000	-0.004	2.5
85	814.699998	-0.003	823.300000	-0.002	2.5

Frequency Error vs. Voltage

Voltage (Volts)	LTE Band 26				Limit (ppm)
	Channel Bandwidth: 3 MHz				
	Low Channel		High Channel		
	Frequency (MHz)	Frequency Error (ppm)	Frequency (MHz)	Frequency Error (ppm)	
10.2	815.500004	0.005	822.500000	0.003	2.5
12	815.500003	0.004	822.500000	0.005	2.5
13.8	815.500004	0.005	822.500000	0.003	2.5

Note: The fixture defined the normal working voltage of the adapter is from 10.2 Vdc to 13.8 Vdc.

Frequency Error vs. Temperature

Temp. (°C)	LTE Band 26				Limit (ppm)
	Channel Bandwidth: 3 MHz				
	Low Channel		High Channel		
	Frequency (MHz)	Frequency Error (ppm)	Frequency (MHz)	Frequency Error (ppm)	
-30	815.500001	0.002	822.500000	0.003	2.5
-20	815.500001	0.001	822.500000	0.004	2.5
-10	815.500002	0.003	822.500000	0.002	2.5
0	815.500003	0.004	822.500000	0.004	2.5
10	815.500003	0.003	822.500000	0.001	2.5
20	815.499997	-0.004	822.500000	-0.004	2.5
30	815.499996	-0.004	822.500000	-0.002	2.5
40	815.499996	-0.004	822.500000	-0.003	2.5
50	815.499998	-0.003	822.500000	-0.002	2.5
60	815.499998	-0.003	822.500000	-0.001	2.5
70	815.499997	-0.004	822.500000	-0.005	2.5
80	815.499996	-0.005	822.500000	-0.002	2.5
85	815.499997	-0.004	822.500000	-0.005	2.5

Frequency Error vs. Voltage

Voltage (Volts)	LTE Band 26				Limit (ppm)
	Channel Bandwidth: 5 MHz				
	Low Channel		High Channel		
	Frequency (MHz)	Frequency Error (ppm)	Frequency (MHz)	Frequency Error (ppm)	
10.2	816.500003	0.004	821.500000	0.002	2.5
12	816.500004	0.005	821.500000	0.003	2.5
13.8	816.500003	0.003	821.500000	0.003	2.5

Note: The fixture defined the normal working voltage of the adapter is from 10.2 Vdc to 13.8 Vdc.

Frequency Error vs. Temperature

Temp. (°C)	LTE Band 26				Limit (ppm)
	Channel Bandwidth: 5 MHz				
	Low Channel		High Channel		
	Frequency (MHz)	Frequency Error (ppm)	Frequency (MHz)	Frequency Error (ppm)	
-30	816.500002	0.002	821.500000	0.003	2.5
-20	816.500003	0.003	821.500000	0.003	2.5
-10	816.500003	0.004	821.500000	0.004	2.5
0	816.500002	0.002	821.500000	0.001	2.5
10	816.500001	0.002	821.500000	0.003	2.5
20	816.499999	-0.002	821.500000	-0.005	2.5
30	816.499997	-0.004	821.500000	-0.003	2.5
40	816.499999	-0.001	821.500000	-0.004	2.5
50	816.499998	-0.002	821.500000	-0.003	2.5
60	816.499996	-0.005	821.500000	-0.003	2.5
70	816.499998	-0.003	821.500000	-0.003	2.5
80	816.499998	-0.002	821.500000	-0.001	2.5
85	816.499997	-0.004	821.500000	-0.002	2.5

Frequency Error vs. Voltage

Voltage (Volts)	LTE Band 26		Limit (ppm)
	Channel Bandwidth: 10 MHz		
	Frequency (MHz)	Frequency Error (ppm)	
10.2	819.000004	0.005	2.5
12	819.000003	0.004	2.5
13.8	819.000002	0.003	2.5

Note: The fixture defined the normal working voltage of the adapter is from 10.2 Vdc to 13.8 Vdc.

Frequency Error vs. Temperature

Temp. (°C)	LTE Band 26		Limit (ppm)
	Channel Bandwidth: 10 MHz		
	Frequency (MHz)	Frequency Error (ppm)	
-30	819.000002	0.002	2.5
-20	819.000003	0.004	2.5
-10	819.000004	0.005	2.5
0	819.000003	0.003	2.5
10	819.000002	0.002	2.5
20	818.999997	-0.004	2.5
30	818.999997	-0.004	2.5
40	818.999996	-0.005	2.5
50	818.999999	-0.001	2.5
60	818.999997	-0.003	2.5
70	818.999996	-0.005	2.5
80	818.999998	-0.003	2.5
85	818.999997	-0.003	2.5

NB-IoT

Frequency Error vs. Voltage

Voltage (Volts)	LTE Band 26				Limit (ppm)
	Low Channel		High Channel		
	Frequency (MHz)	Frequency Error (ppm)	Frequency (MHz)	Frequency Error (ppm)	
10.2	814.200002	0.002	823.800002	0.002	2.5
12	814.200001	0.002	823.800003	0.003	2.5
13.8	814.200003	0.003	823.800001	0.002	2.5

Note: The fixture defined the normal working voltage of the adapter is from 10.2 Vdc to 13.8 Vdc.

Frequency Error vs. Temperature

Temp. (°C)	LTE Band 26				Limit (ppm)
	Low Channel		High Channel		
	Frequency (MHz)	Frequency Error (ppm)	Frequency (MHz)	Frequency Error (ppm)	
-30	814.200004	0.005	823.800001	0.002	2.5
-20	814.200001	0.001	823.800003	0.003	2.5
-10	814.200002	0.002	823.800001	0.002	2.5
0	814.200002	0.002	823.800003	0.003	2.5
10	814.200001	0.001	823.800001	0.001	2.5
20	814.199998	-0.003	823.799997	-0.004	2.5
30	814.199998	-0.002	823.799998	-0.003	2.5
40	814.199999	-0.002	823.799997	-0.004	2.5
50	814.199997	-0.004	823.799997	-0.004	2.5
60	814.199998	-0.003	823.799998	-0.002	2.5
70	814.199998	-0.002	823.799999	-0.002	2.5
80	814.199998	-0.002	823.799999	-0.001	2.5
85	814.199998	-0.003	823.799998	-0.002	2.5

4.4 Occupied Bandwidth Measurement

4.4.1 Limits of Occupied Bandwidth Measurement

The width of a frequency band such that, below the lower and above the upper frequency limits, the mean powers emitted are each equal to a specified percentage 0.5 %of the total mean power of a given emission.

4.4.2 Test Procedure

The EUT makes a call to the communication simulator. All measurements were done at low, middle and high operational frequency range. The communication simulator station system controlled a EUT to export maximum output power under transmission mode and specific channel frequency. Use OBW measurement function of Spectrum analyzer to measure 99 % occupied bandwidth.

4.4.3 Test Setup

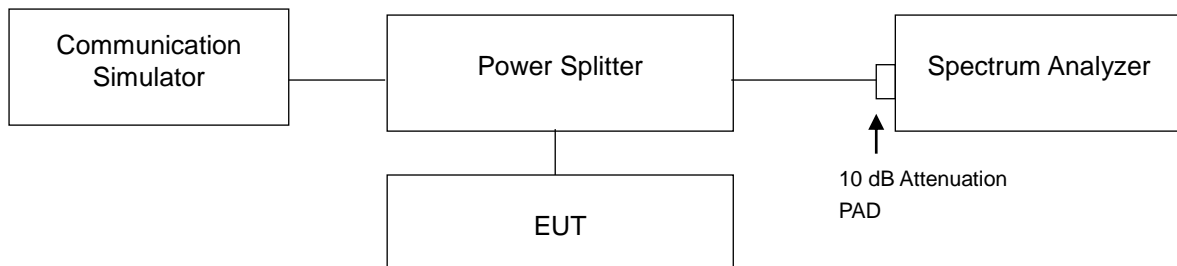

4.4.4 Test Results

Cat-M1

LTE Band 26					
Channel Bandwidth: 1.4 MHz					
Channel	Frequency (MHz)	99 % Occupied Bandwidth (MHz)		26 dB Bandwidth (MHz)	
		QPSK	16QAM	QPSK	16QAM
26697	814.7	1.0868	1.0869	1.256	1.260
26740	819.0	1.0921	1.0860	1.273	1.266
26783	823.3	1.0925	1.0877	1.273	1.272
Channel Bandwidth: 3 MHz					
Channel	Frequency (MHz)	99 % Occupied Bandwidth (MHz)		26 dB Bandwidth (MHz)	
		QPSK	16QAM	QPSK	16QAM
26705	815.5	1.0882	1.0773	1.276	1.267
26740	819.0	1.0910	1.0778	1.277	1.268
26775	822.5	1.0861	1.0770	1.263	1.270

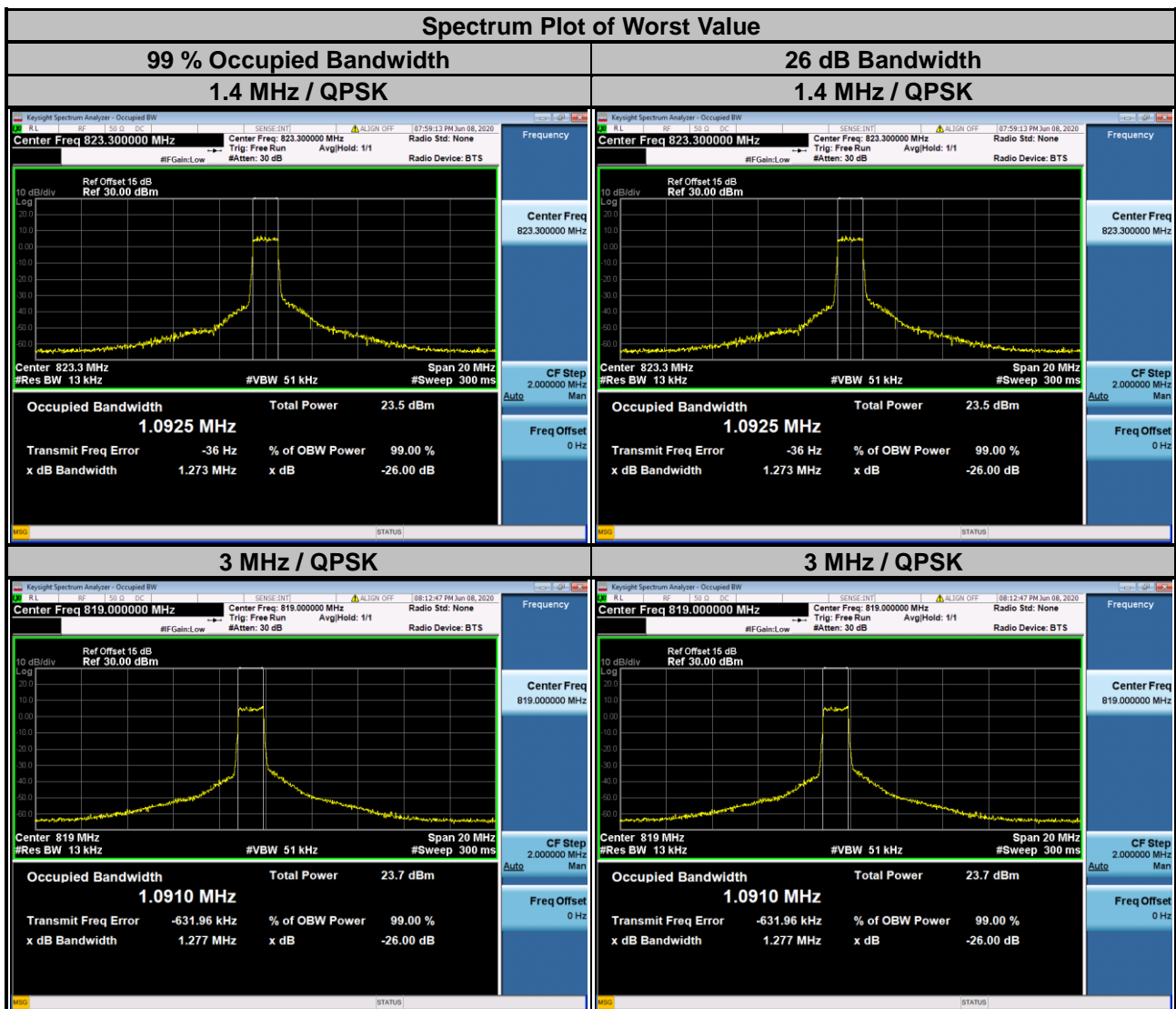

LTE Band 26					
Channel Bandwidth: 5 MHz					
Channel	Frequency (MHz)	99 % Occupied Bandwidth (MHz)		26 dB Bandwidth (MHz)	
		QPSK	16QAM	QPSK	16QAM
26715	816.5	1.0770	1.0884	1.264	1.291
26740	819.0	1.0871	1.0863	1.296	1.273
26765	821.5	1.0839	1.0854	1.263	1.299

Channel Bandwidth: 10 MHz					
Channel	Frequency (MHz)	99 % Occupied Bandwidth (MHz)		26 dB Bandwidth (MHz)	
		QPSK	16QAM	QPSK	16QAM
26740	819.0	1.0905	1.0879	1.271	1.272

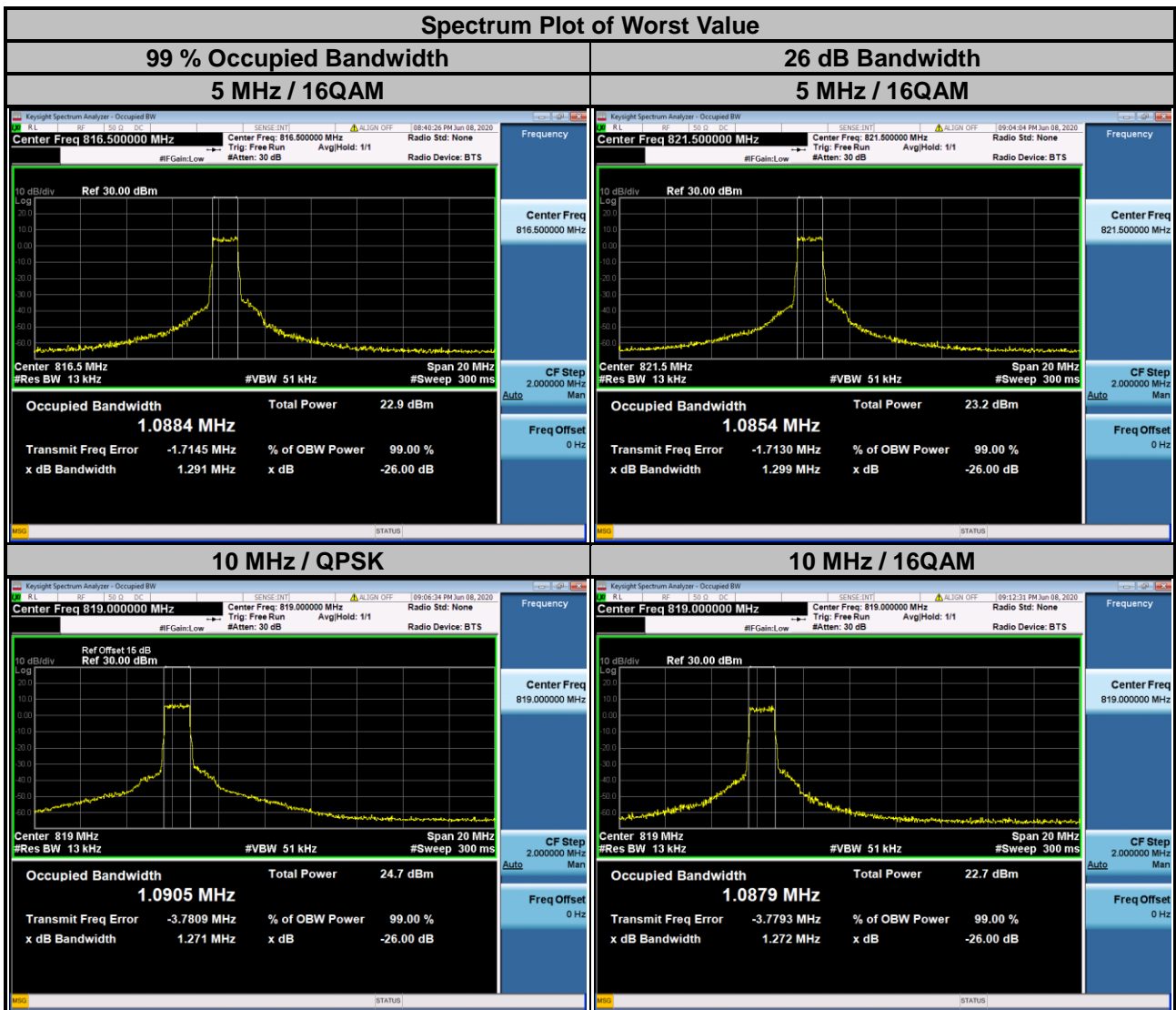

NB-IoT

LTE Band 26						
Channel	Frequency (MHz)	Modulation	N _{tones}	Sub-carrier Spacing (kHz)	99 % Occupied Bandwidth (kHz)	26 dB Bandwidth (kHz)
26692	814.2	BPSK	1@0	3.75	39.22	29.23
		BPSK	1@0	15	96.893	125.9
		QPSK	1@0	3.75	35.494	29.09
		QPSK	1@0	15	97.013	111.7
		QPSK	12@0	15	184.16	262.30
26740	819	BPSK	1@0	3.75	57.87	38.47
		BPSK	1@0	15	99.876	110.5
		QPSK	1@0	3.75	54.086	41.25
		QPSK	1@0	15	98.402	126.0
		QPSK	12@0	15	191.99	265.00
26788	823.8	BPSK	1@47	3.75	58.74	36.36
		BPSK	1@0	15	97.860	122.3
		QPSK	1@0	3.75	59.033	41.55
		QPSK	1@0	15	108.46	128.2
		QPSK	12@0	15	188.00	265.30

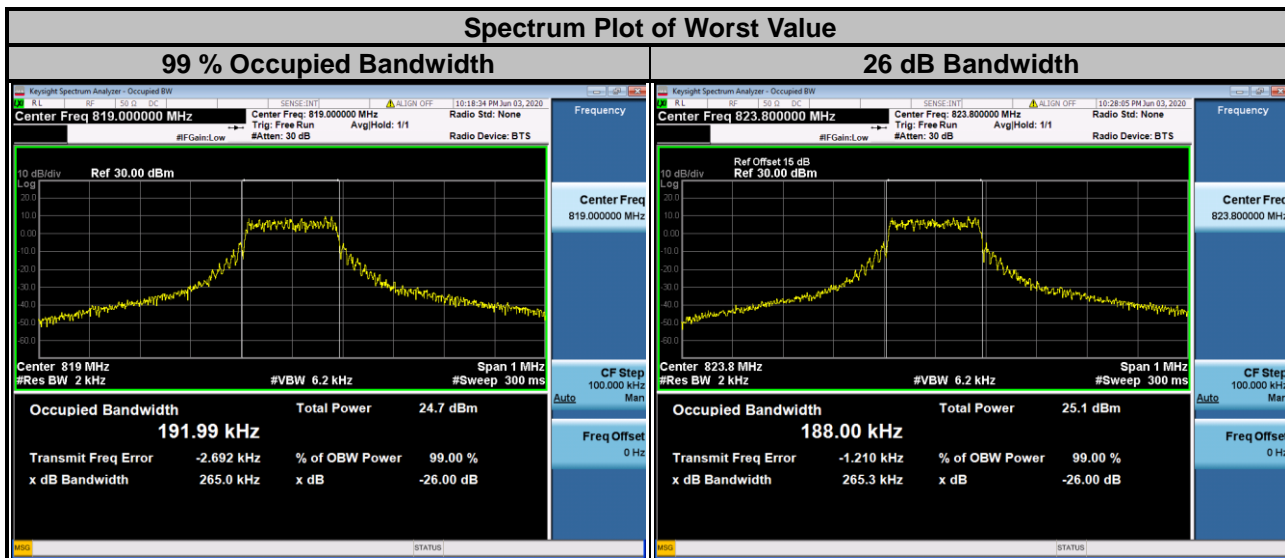

4.5 Emission Mask Measurement

4.5.1 Limits of Emission Mask Measurement

LTE Band 26

According to FCC part 90.691 shall be tested the emission mask. For any frequency removed from the EA licensee's frequency block by up to and including 37.5 kHz, the power of any emission shall be attenuated below the transmitter power (P) in watts by at least $116 \text{ Log}_{10}(f/6.1)$ decibels or $50 + 10\text{Log}_{10}(P)$ decibels or 80 decibels, whichever is the lesser attenuation, where f is the frequency removed from the center of the outer channel in the block in kilohertz and where f is greater than 12.5 kHz.

For any frequency removed from the EA licensee's frequency block greater than 37.5 kHz, the power of any emission shall be attenuated below the transmitter power (P) in watts by at least $43 + 10\text{Log}_{10}(P)$ decibels or 80 decibels, whichever is the lesser attenuation, where f is the frequency removed from the center of the outer channel in the block in kilohertz and where f is greater than 37.5 kHz.

For §90.691(a), RBW=300 Hz for offset less than 37.5 kHz from channel edge and RBW=100 kHz for offsets greater than 37.5 kHz is allowed.

4.5.2 Test Setup

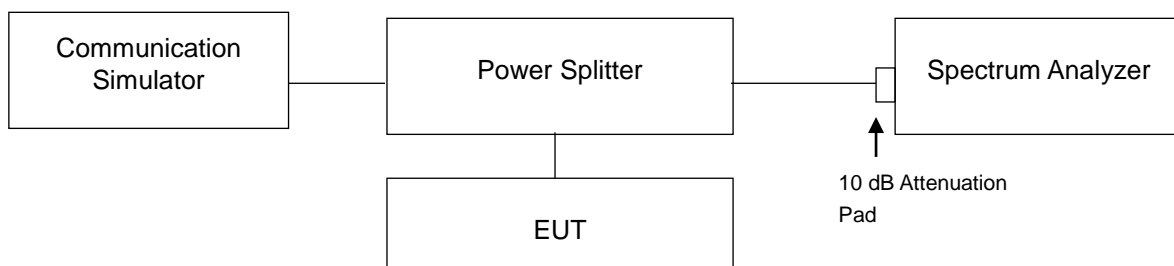

4.5.3 Test Procedures

- The measurement used the power splitter via EUT RF power connector between simulation base station and spectrum analyzer.
- Record the test plot.

4.5.4 Test Results

Cat-M1

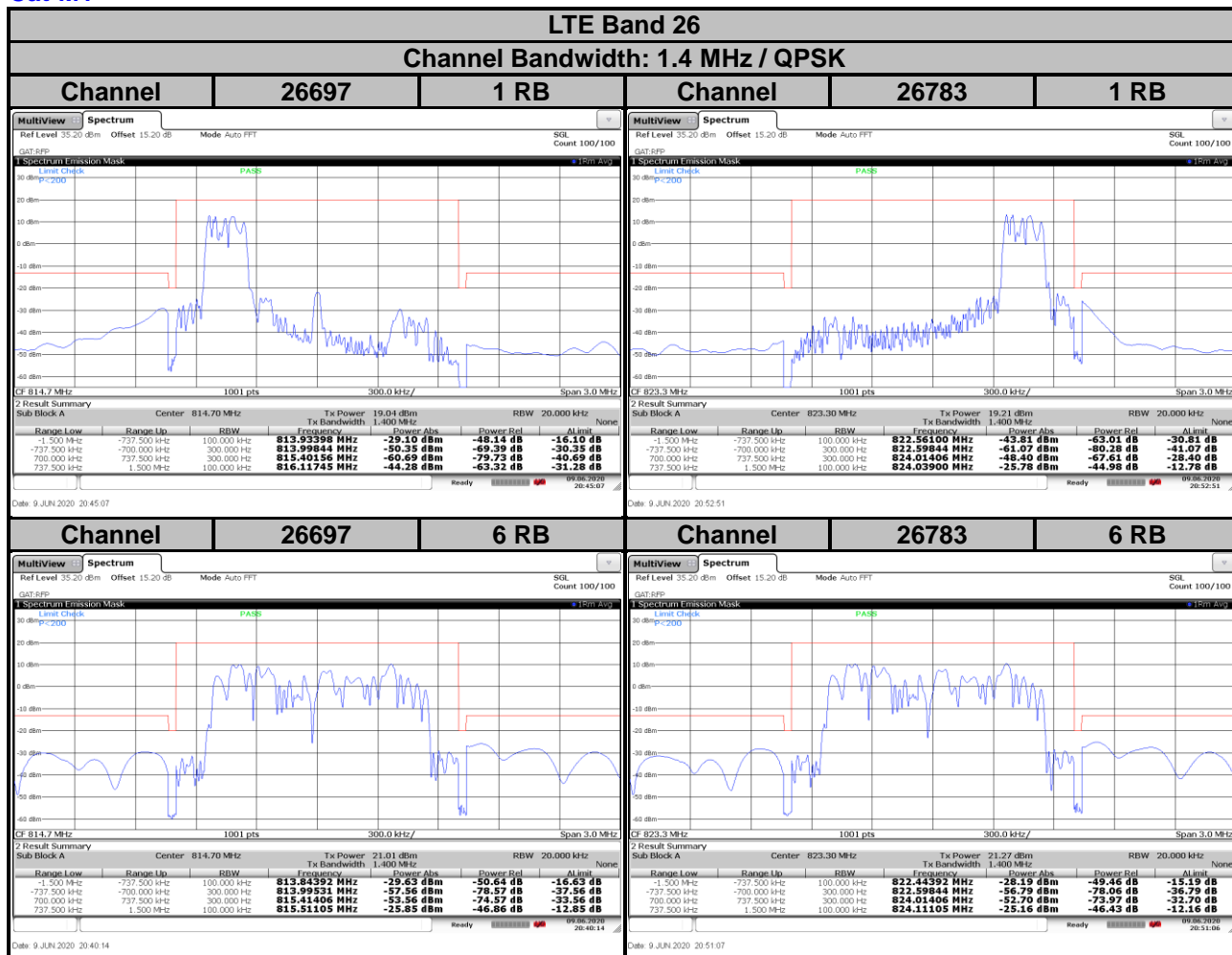

LTE Band 26

Channel Bandwidth: 1.4 MHz / 16QAM

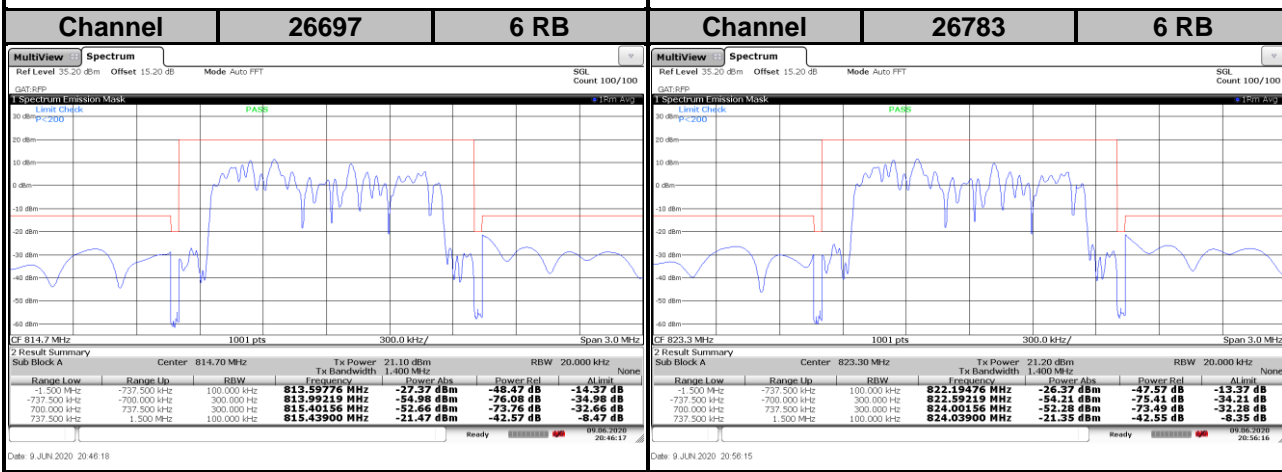
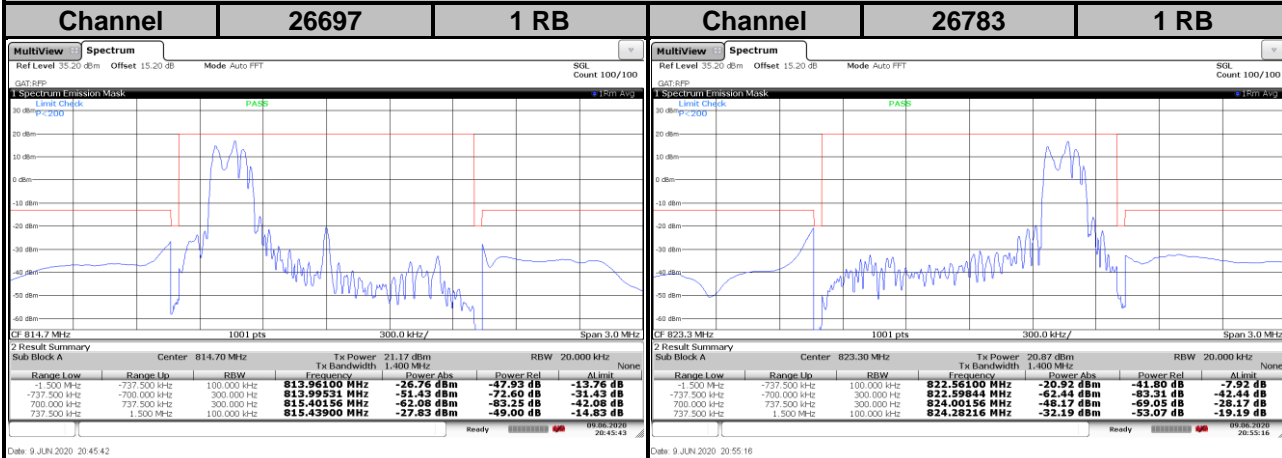

LTE Band 26

Channel Bandwidth: 3 MHz / QPSK

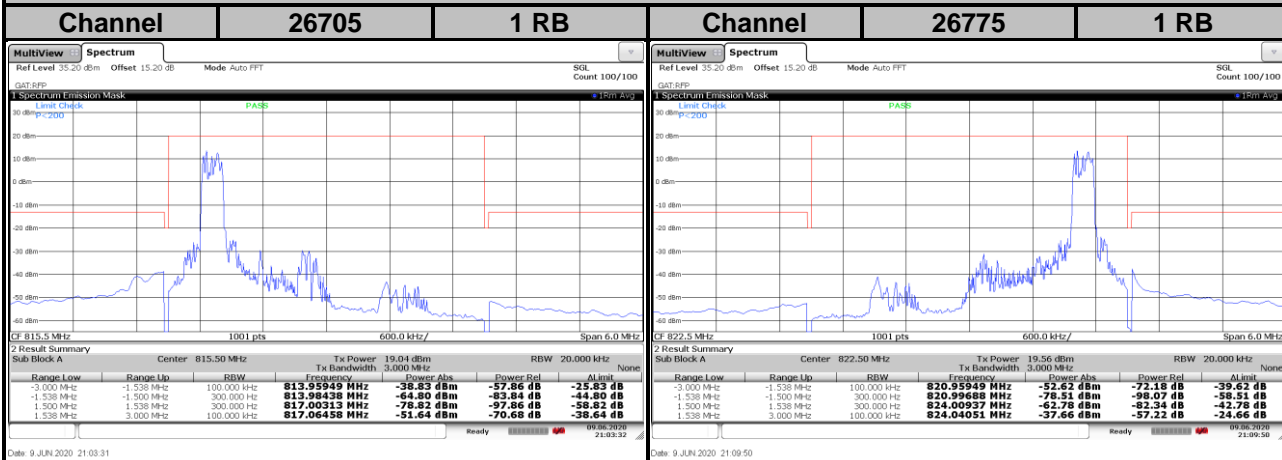

Date: 9 JUN 2020 21:03:31

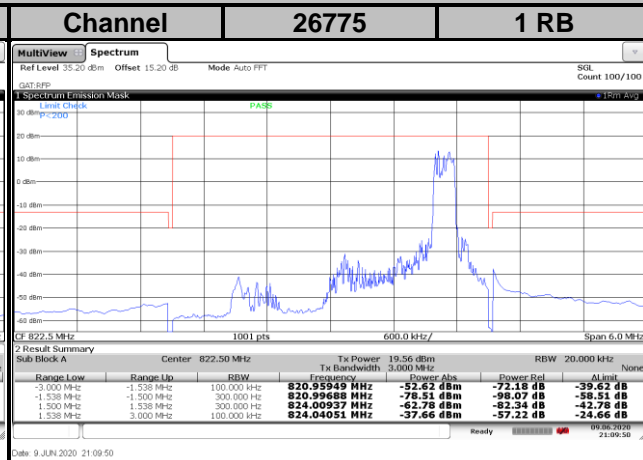

Date: 9 JUN 2020 21:09:50

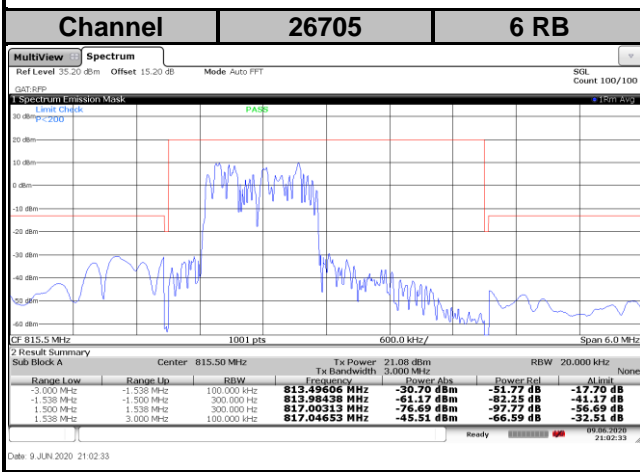

Date: 9 JUN 2020 21:02:33

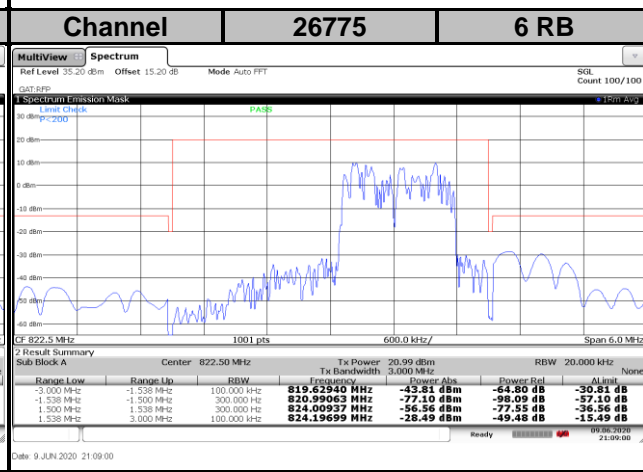

Date: 9 JUN 2020 21:09:00

LTE Band 26

Channel Bandwidth: 3 MHz / 16QAM

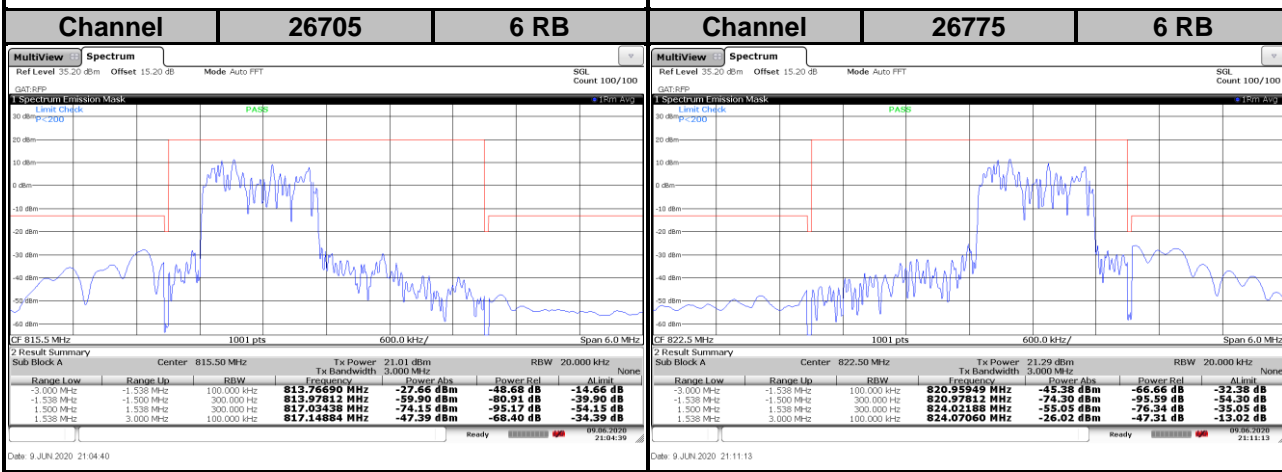
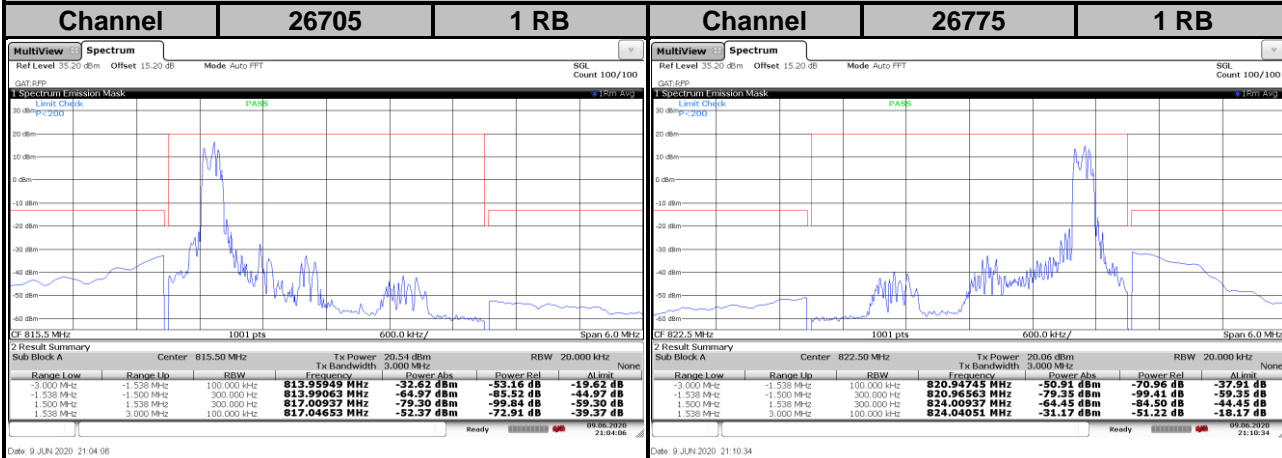

LTE Band 26

Channel Bandwidth: 5 MHz / QPSK

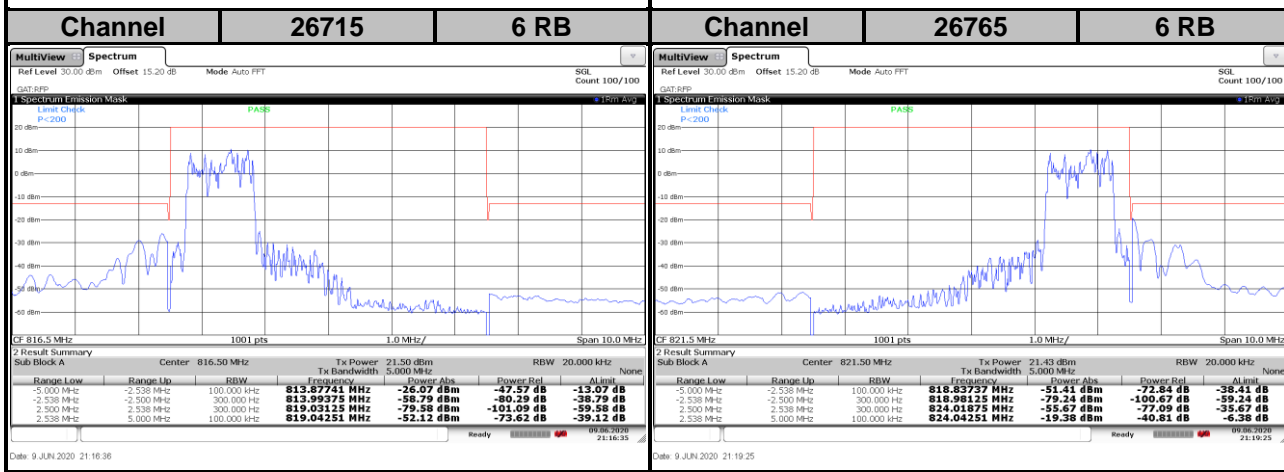
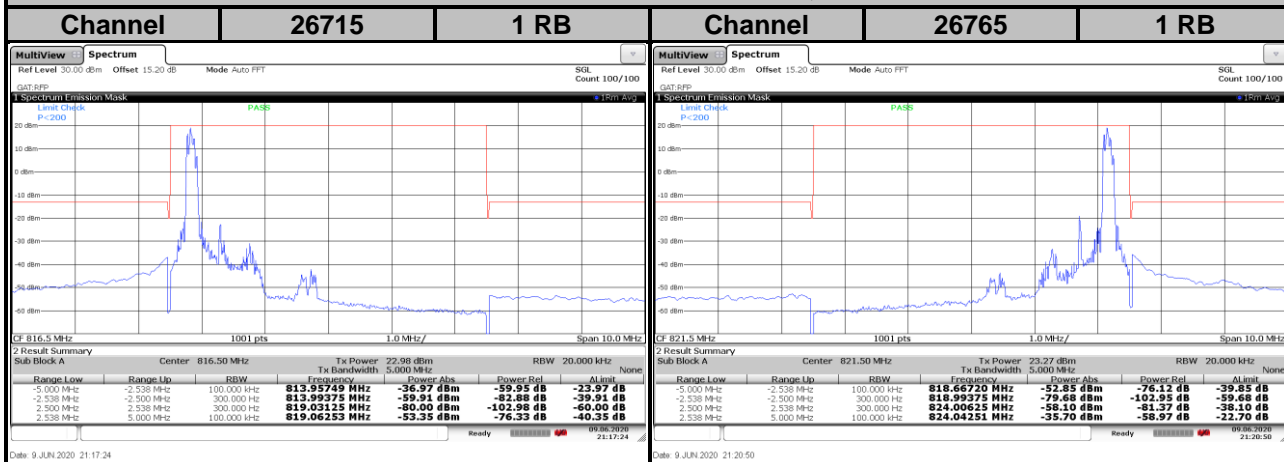

LTE Band 26

Channel Bandwidth: 5 MHz / 16QAM

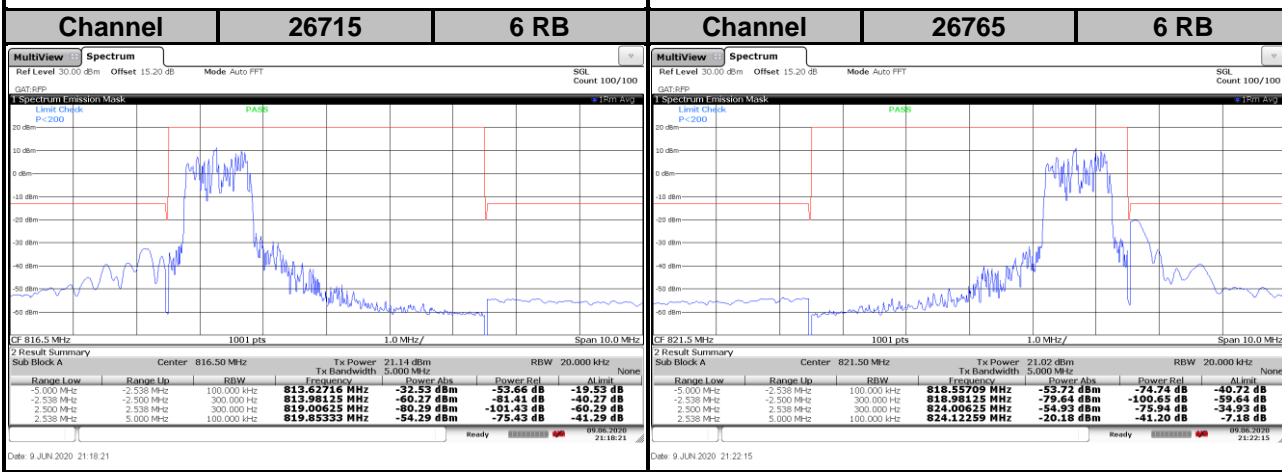
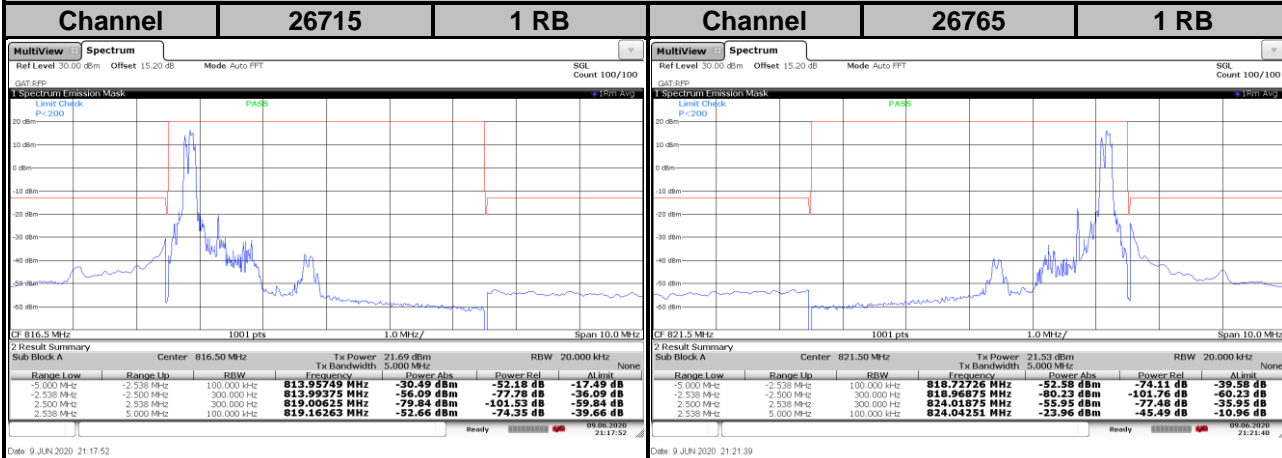

NB-IoT

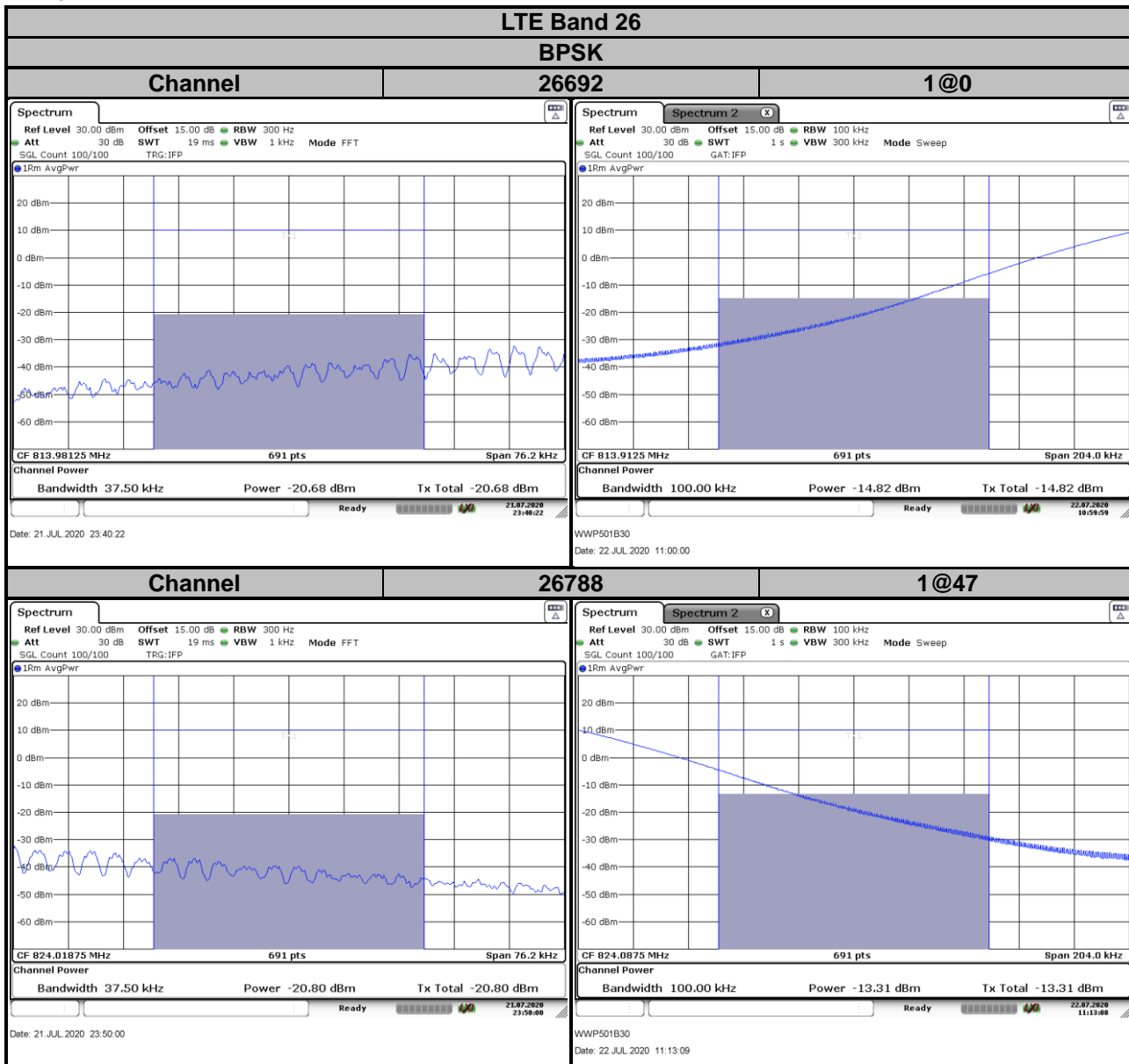

QPSK

Channel	26692	1@0
----------------	--------------	------------

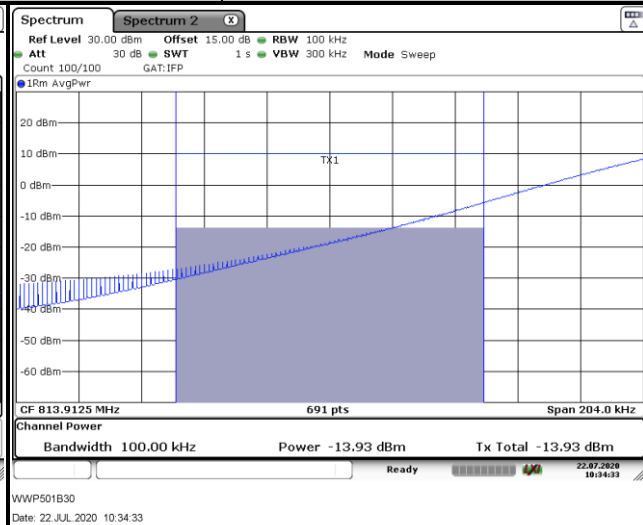
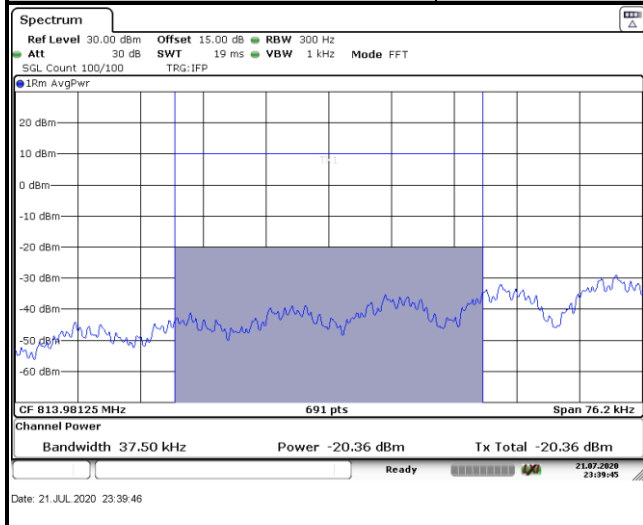

Channel	26788	1@11
----------------	--------------	-------------

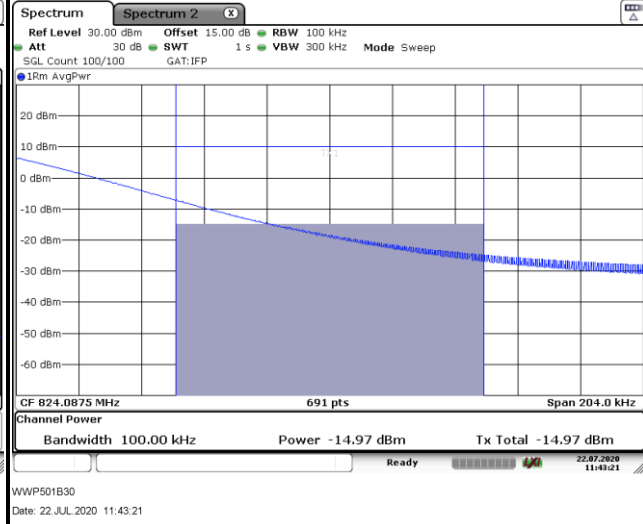
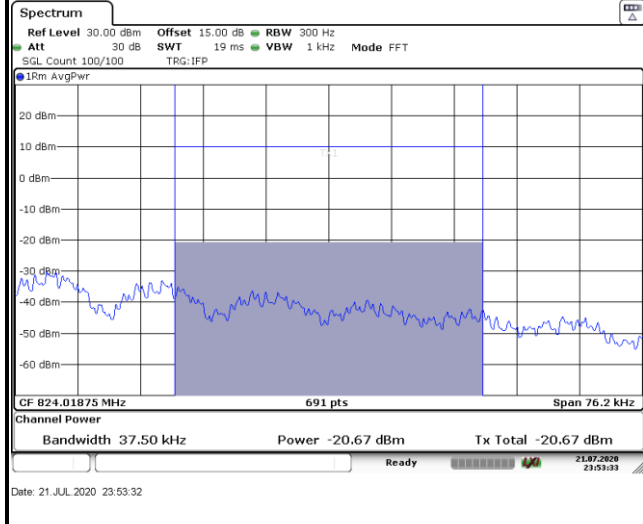

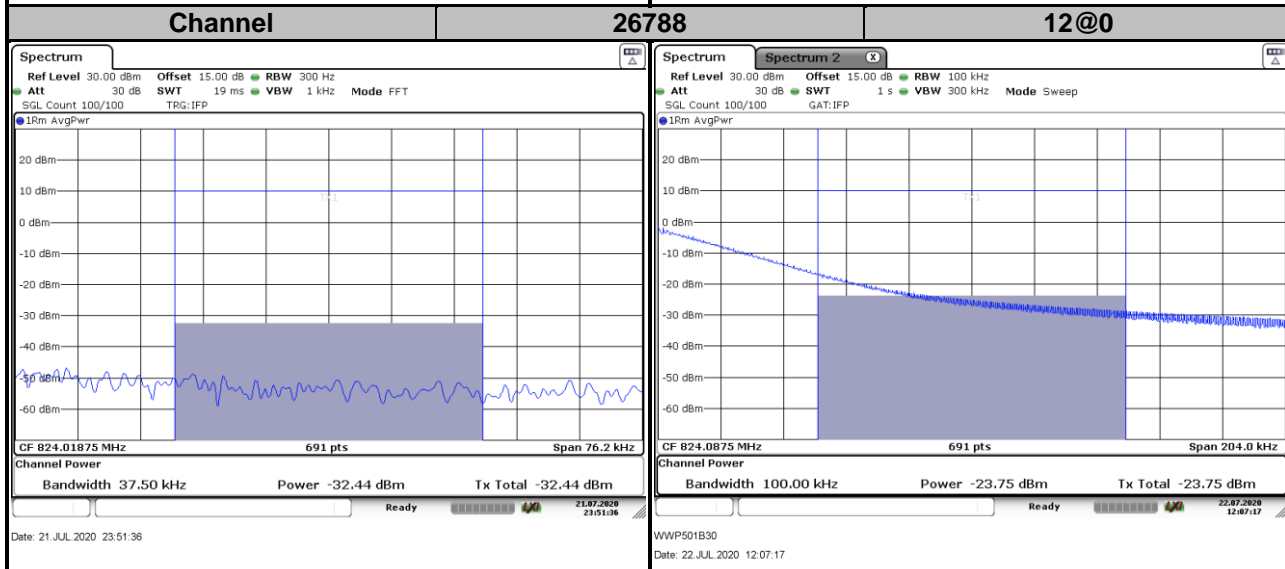
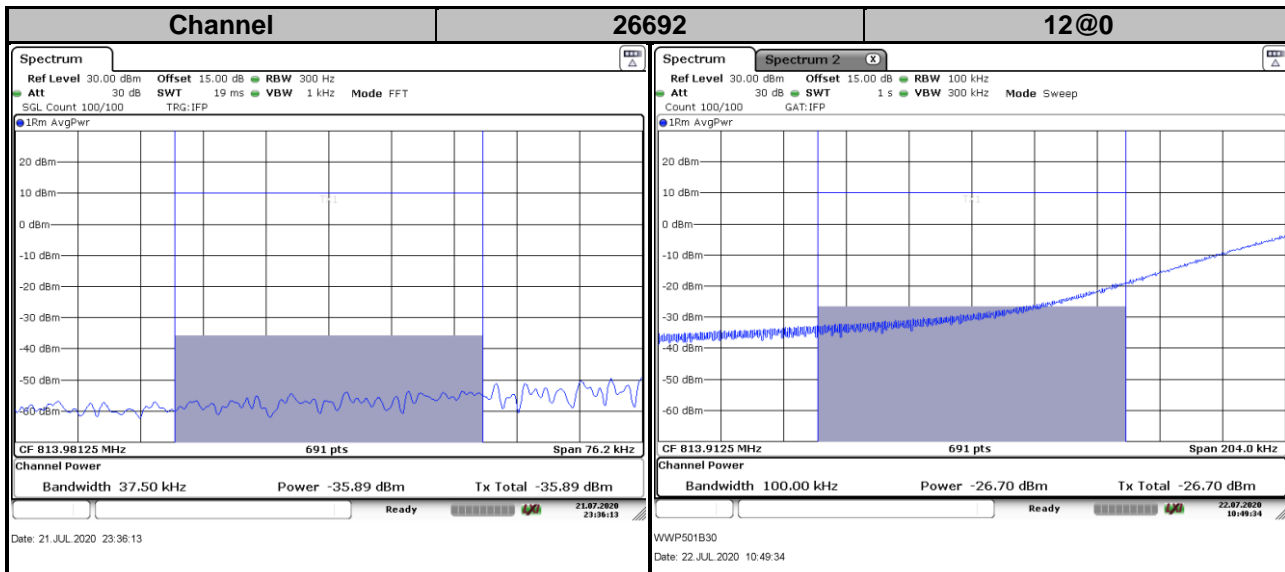

4.6 Conducted Spurious Emissions

4.6.1 Limits of Conducted Spurious Emissions Measurement

The power of any emission outside a licensee's frequency block shall be attenuated below the transmitter power (P) by at least $43 + 10 \log_{10}(P)$ dB. The limit of emission is equal to -13 dBm.

4.6.2 Test Setup

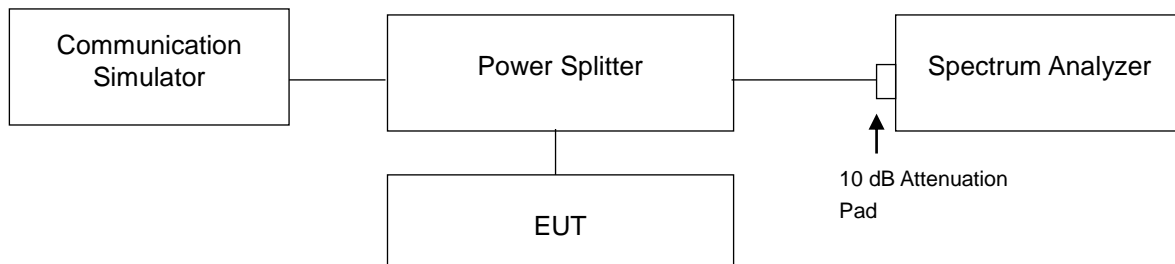

4.6.3 Test Procedure

- The EUT makes a phone call to the communication simulator. All measurements were done at low, middle and high operational frequency range.
- Measuring frequency range is from 9 kHz to 1 GHz. 10 dB attenuation pad is connected with spectrum. RBW = 100 kHz and VBW = 300 kHz are used for conducted emission measurement.
- Measuring frequency range is from 1 GHz to 9 GHz. 10 dB attenuation pad is connected with spectrum. RBW = 1 MHz and VBW = 3 MHz are used for conducted emission measurement.

4.6.4 Test Results

Cat-M1

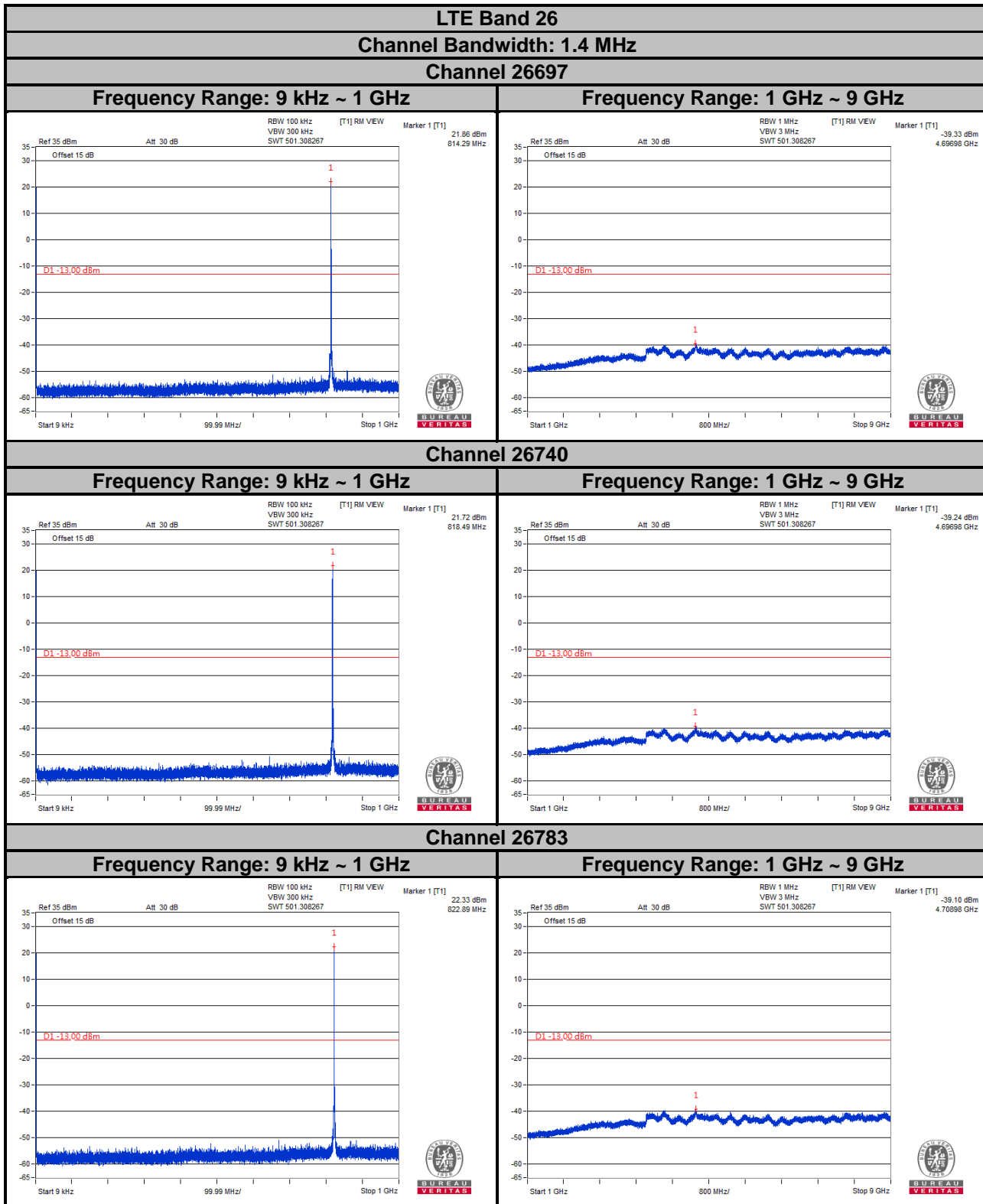

Note: The signal over the limit in 9 kHz is from spectrum analyzer.

LTE Band 26
Channel Bandwidth: 3 MHz

Channel 26705

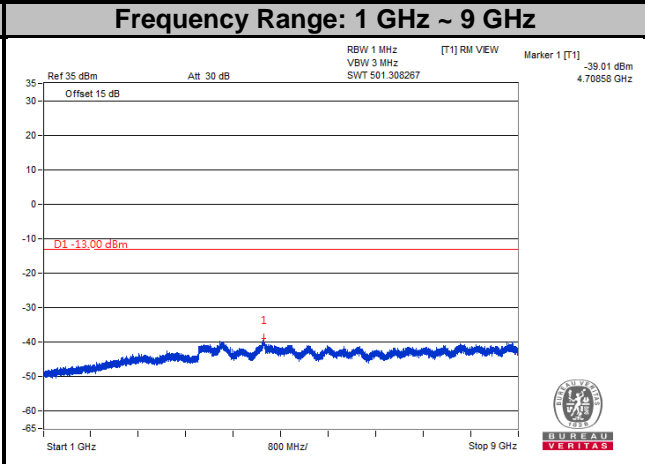
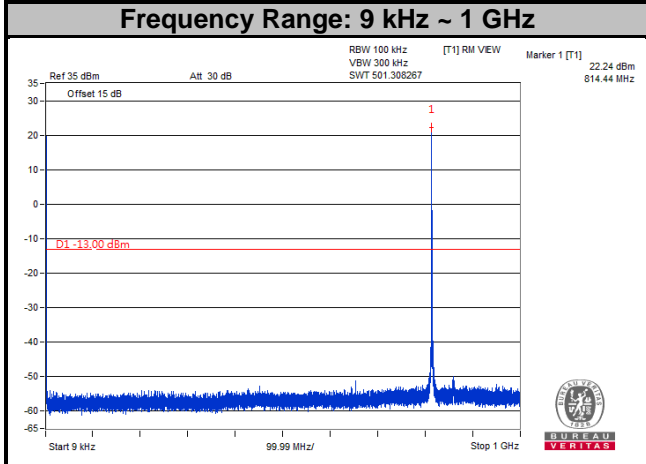

Channel 26740

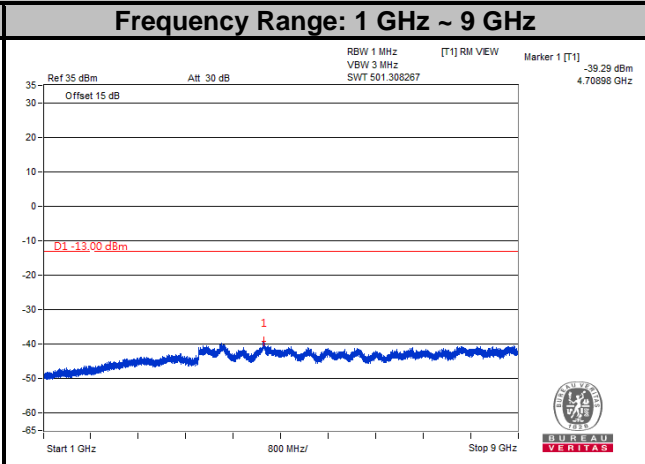
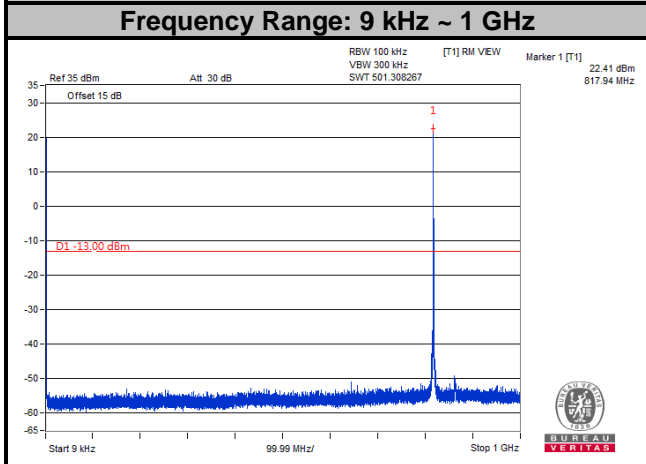

Channel 26775

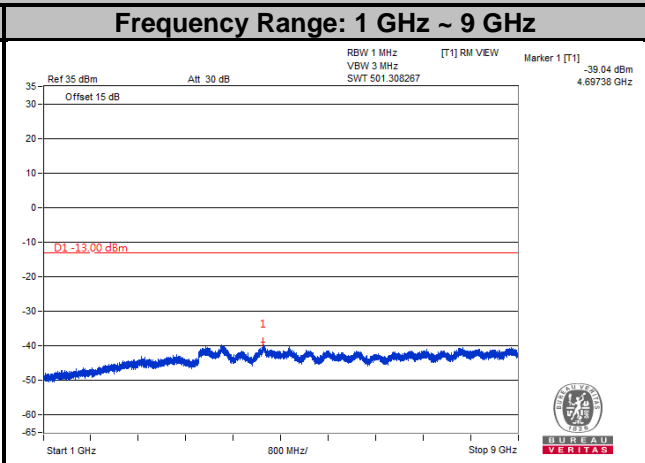
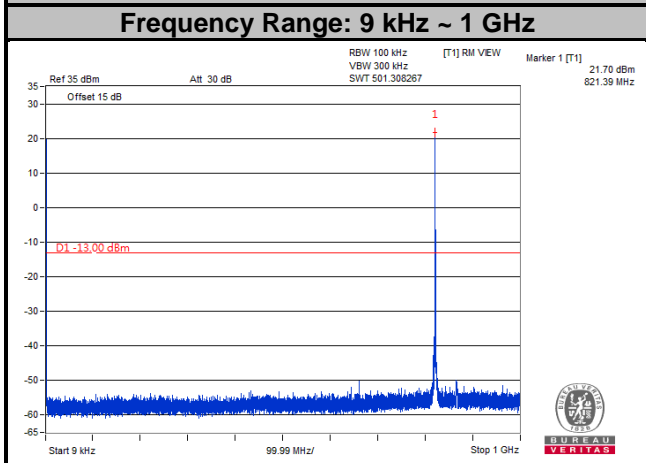

Note: The signal over the limit in 9 kHz is from spectrum analyzer.

LTE Band 26
Channel Bandwidth: 5 MHz

Channel 26715

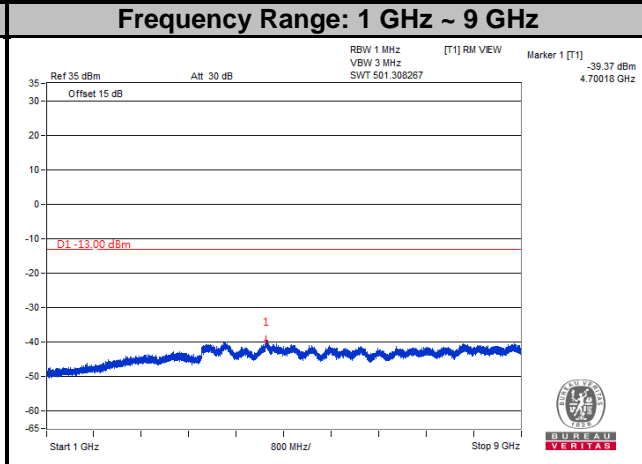
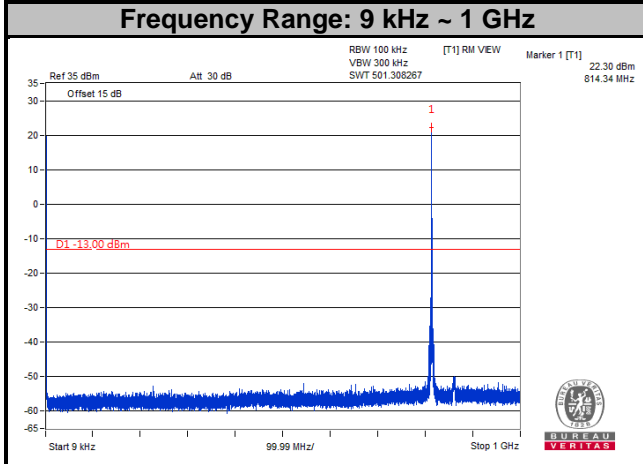

Channel 26740

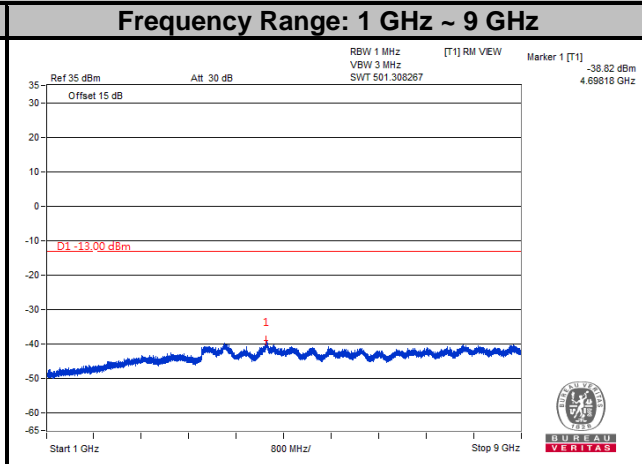
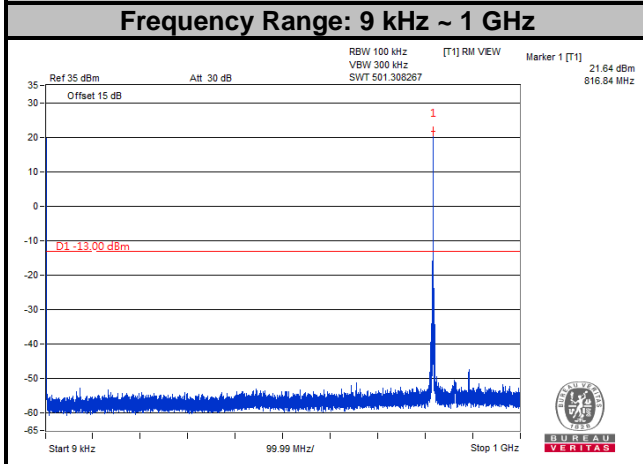

Channel 26765

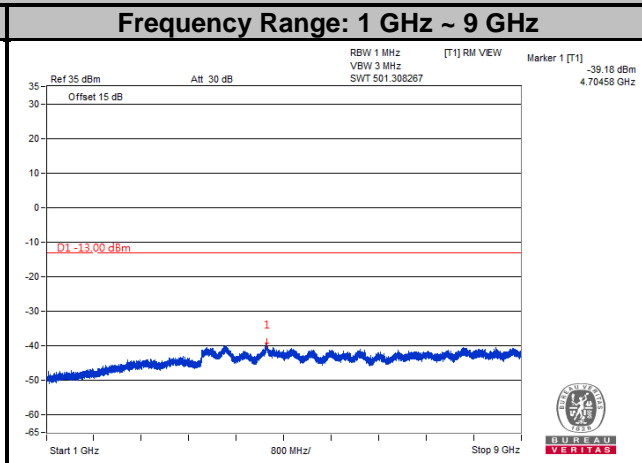
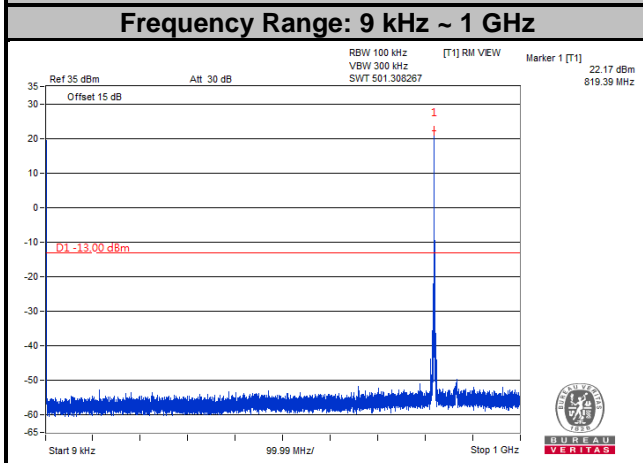

Note: The signal over the limit in 9 kHz is from spectrum analyzer.

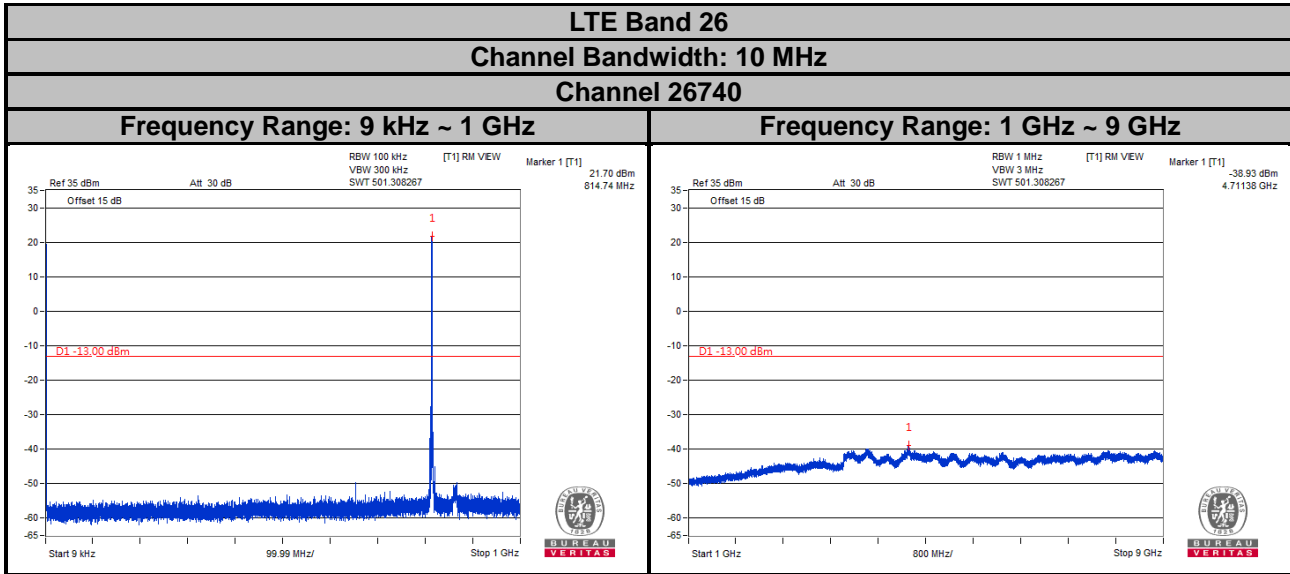

Note: The signal over the limit in 9 kHz is from spectrum analyzer.

NB-IoT

LTE Band 26
Channel 26692

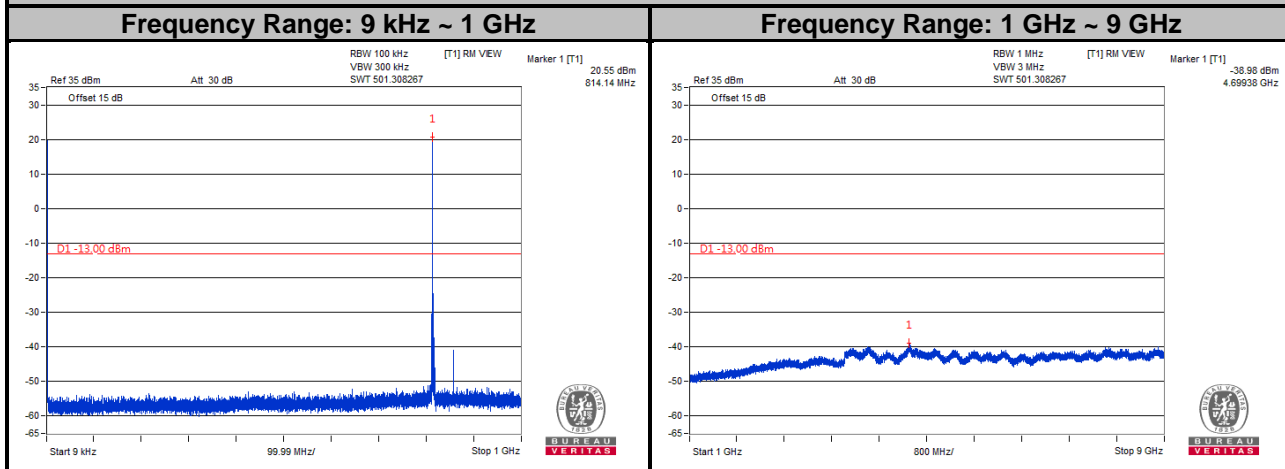

Channel 26740

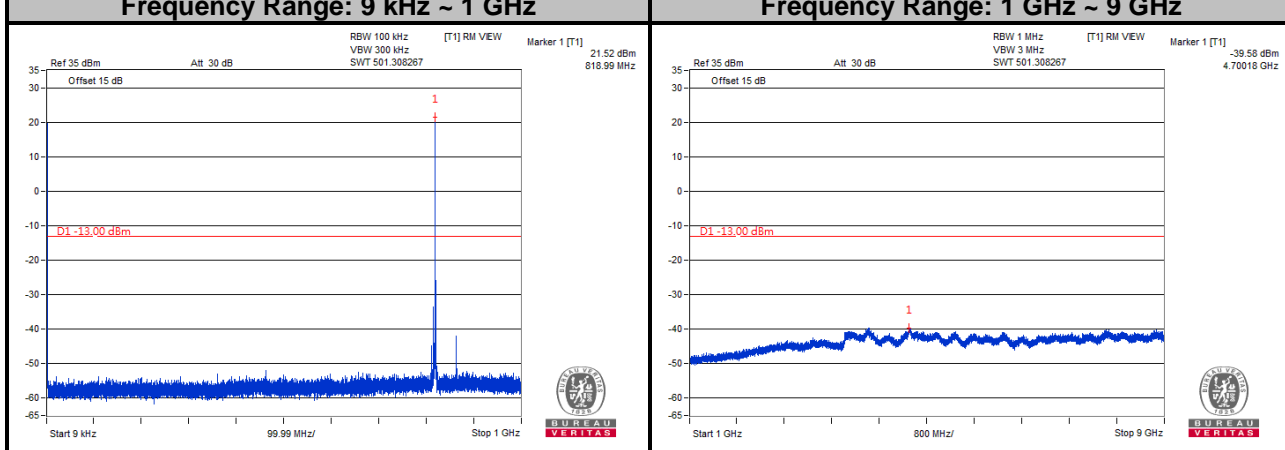

Channel 26788

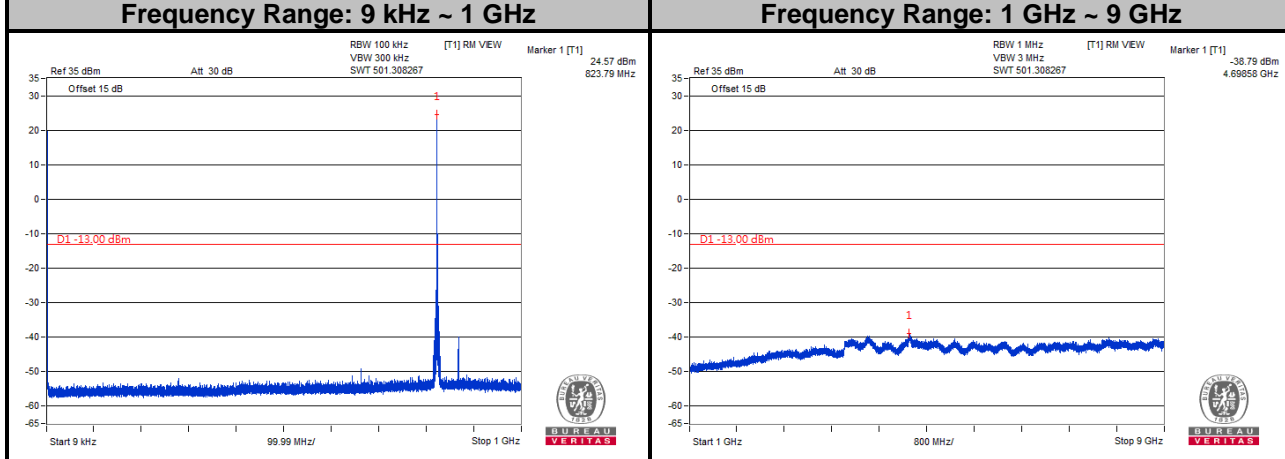

Note: The signal over the limit in 9 kHz is from spectrum analyzer.

4.7 Radiated Emission Measurement

4.7.1 Limits of Radiated Emission Measurement

The power of any emission outside a licensee's frequency block shall be attenuated below the transmitter power (P) by at least $43 + 10 \log (P)$ dB. The limit of emission is equal to -13 dBm.

4.7.2 Test Procedure

- a. Substitution method is used for E.I.R.P measurement. In the semi-anechoic chamber, EUT placed on the 0.8 m (below or equal 1 GHz) and/or 1.5 m (above 1 GHz) height of Turn Table, rotated the table around 360 degrees to search the maximum radiation power and receiver antenna shall be rotated vertical and horizontal polarization and moved height from 1 m to 4 m to find the maximum polar radiated power. The "Read Value" is the spectrum reading the maximum power value.
- b. The substitution horn antenna is substituted for EUT at the same position and signals generator export the CW signal to the substitution antenna via a TX cable. Rotated the Turn Table and moved receiving antenna to find the maximum radiation power. Adjust output power level of S.G to get a Value of spectrum reading equal to "Read Value" of step a. Record the power level of S.G.
- c. $EIRP = \text{Output power level of S.G} - \text{TX cable loss} + \text{Antenna gain of substitution horn}$.
- d. E.R.P power can be calculated form E.I.R.P power by subtracting the gain of dipole, $E.R.P \text{ power} = E.I.P.R \text{ power} - 2.15 \text{ dB}$.

Note: The resolution bandwidth of spectrum analyzer is 1 MHz and the video bandwidth is 3 MHz.

4.7.3 Deviation from Test Standard

No deviation.

4.7.4 Test Setup

<Radiated Emission below or equal 1 GHz>

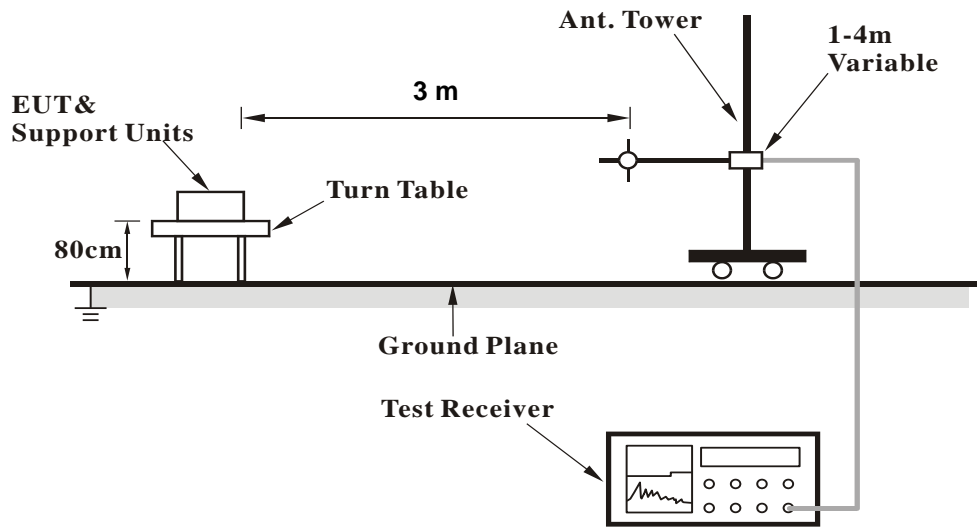

<Radiated Emission above 1 GHz>

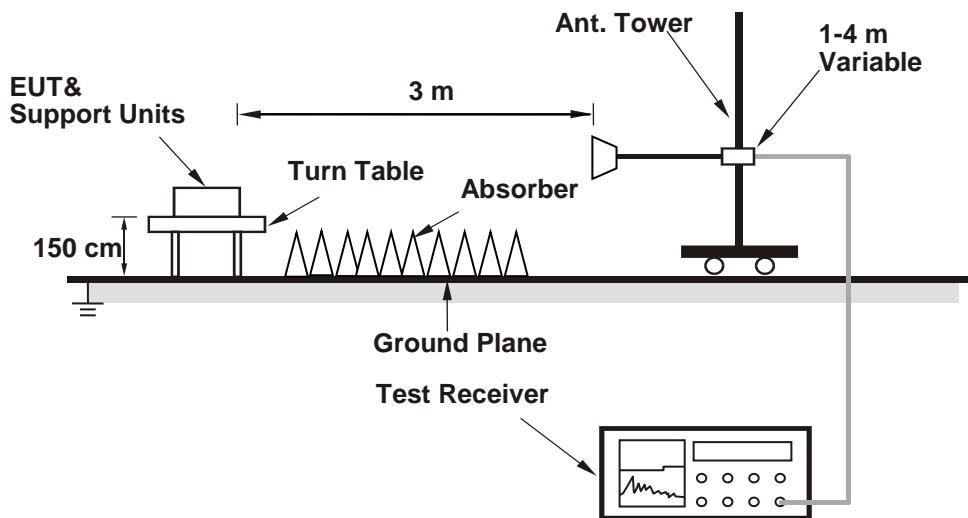

For the actual test configuration, please refer to the attached file (Test Setup Photo).

4.7.5 Test Results

Cat-M1

LTE Band 26

Channel Bandwidth: 1.4 MHz / QPSK

Low Channel



Bureau Veritas Consumer Products Services Ltd., Taoyuan Branch

A D T

Data: 3

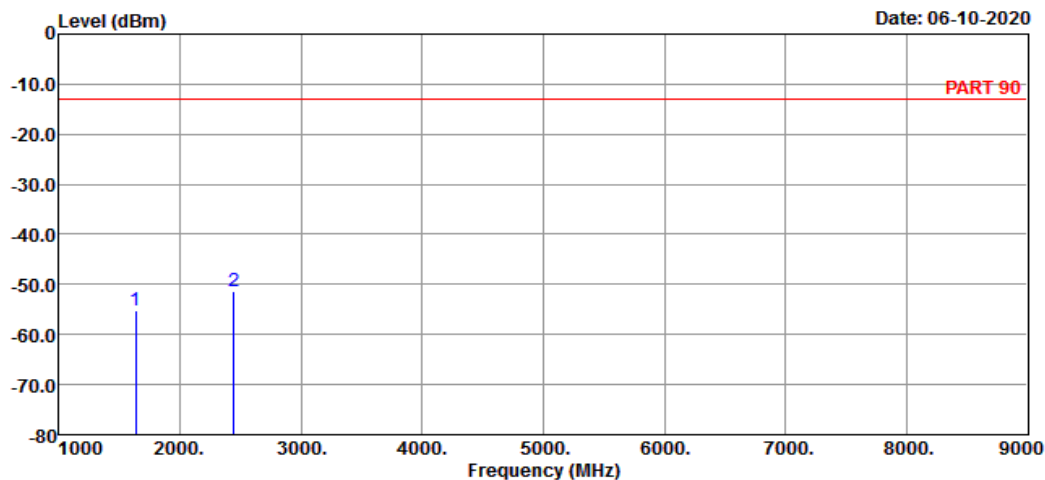

Site : 966 Chamber 5
 Condition: PART 90 HORIZONTAL
 Remak : Cat-M1 Band 26 QPSK_1.4M Link_L-CH
 Tested by: Jisyong Wang

	Freq	Level	Read Level	Limit	Line	Factor	Over Limit	Remark
	MHz	dBm	dBm	dBm		dB	dB	
1	1629.40	-55.16	-41.54	-13.00	-13.62	-42.16	Peak	
2 pp	2444.10	-51.23	-41.27	-13.00	-9.96	-38.23	Peak	



Bureau Veritas Consumer Products Services Ltd., Taoyuan Branch

A D T

Data: 4

Date: 06-10-2020

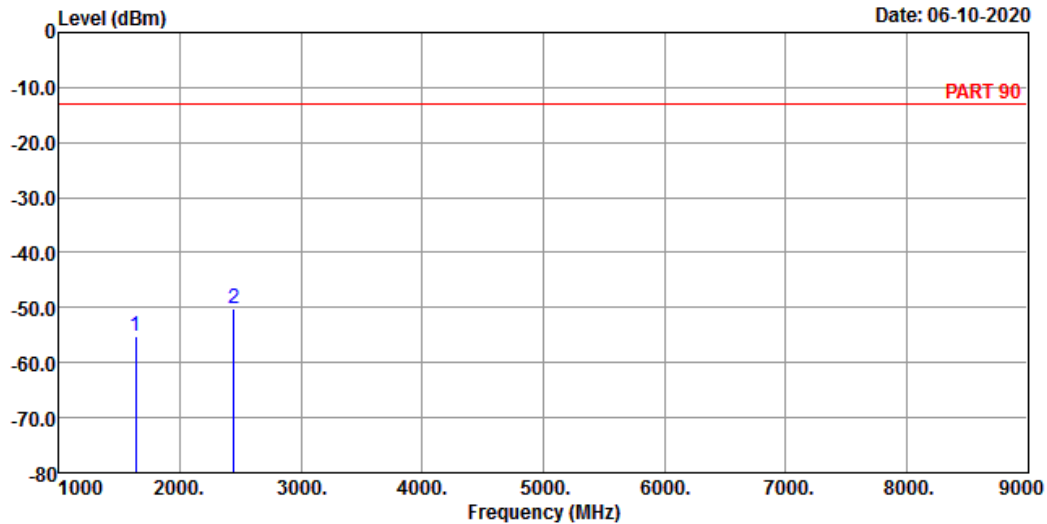

Site : 966 Chamber 5
 Condition: PART 90 VERTICAL
 Remak : Cat-M1 Band 26 QPSK_1.4M Link_L-CH
 Tested by: Jisyong Wang

	Freq	Level	Read Level	Limit	Line Factor	Over Limit	Remark
	MHz	dBm	dBm	dBm	dB	dB	
1	1629.40	-55.16	-41.54	-13.00	-13.62	-42.16	Peak
2	pp 2444.10	-50.23	-40.27	-13.00	-9.96	-37.23	Peak

Middle Channel



Bureau Veritas Consumer Products Services Ltd., Taoyuan Branch

A D T

Data: 3

Date: 06-10-2020

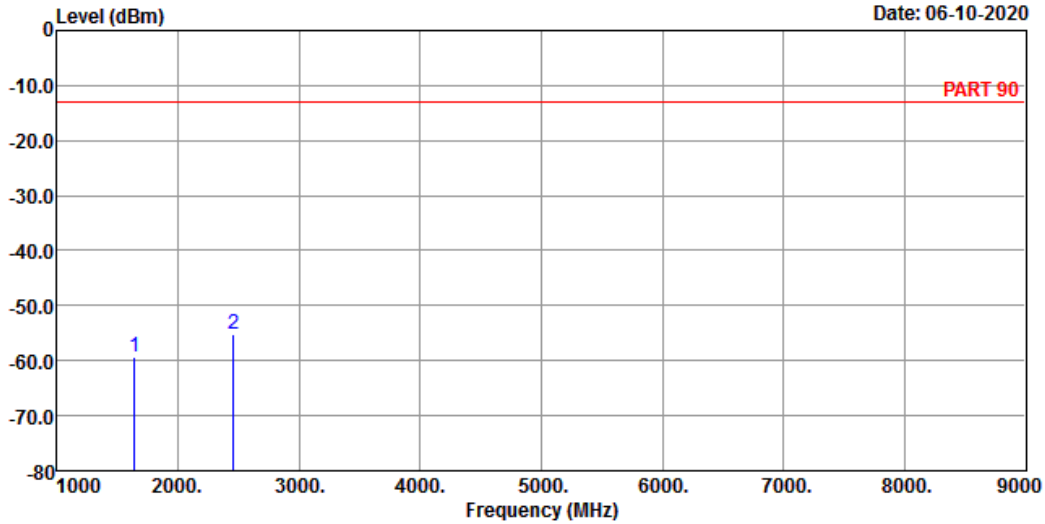

Site : 966 Chamber 5
 Condition: PART 90 HORIZONTAL
 Remak : Cat-M1 Band 26 QPSK_1.4M Link_M-CH
 Tested by: Jisyong Wang

	Freq	Level	Read Level	Limit	Line Factor	Over Limit	Remark
	MHz	dBm	dBm	dBm	dB	dB	
1	1638.00	-59.23	-45.55	-13.00	-13.68	-46.23	Peak
2 pp	2457.00	-55.11	-45.12	-13.00	-9.99	-42.11	Peak



Bureau Veritas Consumer Products Services Ltd., Taoyuan Branch

A D T

Data: 4

Date: 06-10-2020

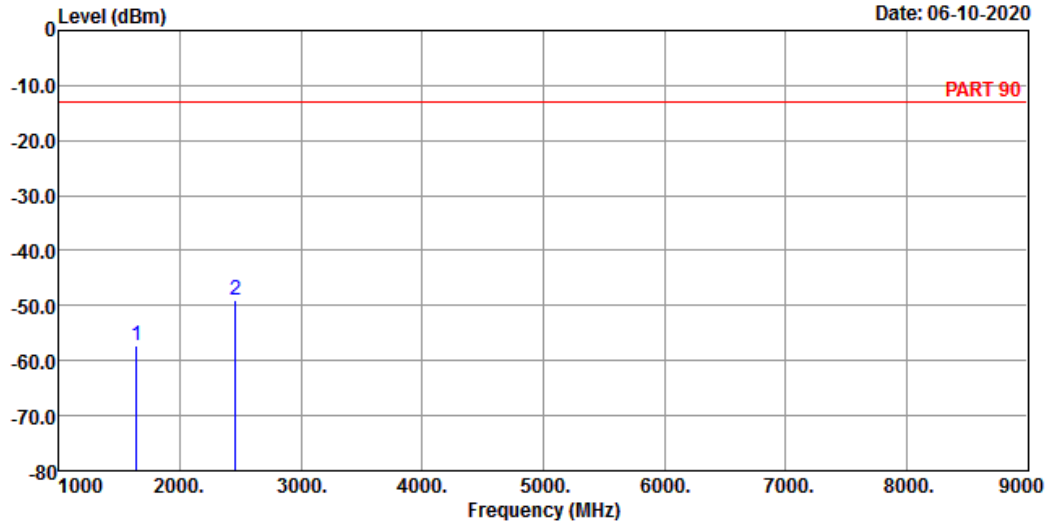

Site : 966 Chamber 5
 Condition: PART 90 VERTICAL
 Remak : Cat-M1 Band 26 QPSK_1.4M Link_M-CH
 Tested by: Jisyong Wang

	Freq	Level	Read Level	Limit	Line Factor	Over Limit	Remark
	MHz	dBm	dBm	dBm	dB	dB	
1	1638.00	-57.26	-43.58	-13.00	-13.68	-44.26	Peak
2	pp 2457.00	-49.13	-39.14	-13.00	-9.99	-36.13	Peak

High Channel



Bureau Veritas Consumer Products Services Ltd., Taoyuan Branch

A D T

Data: 3

Date: 06-10-2020

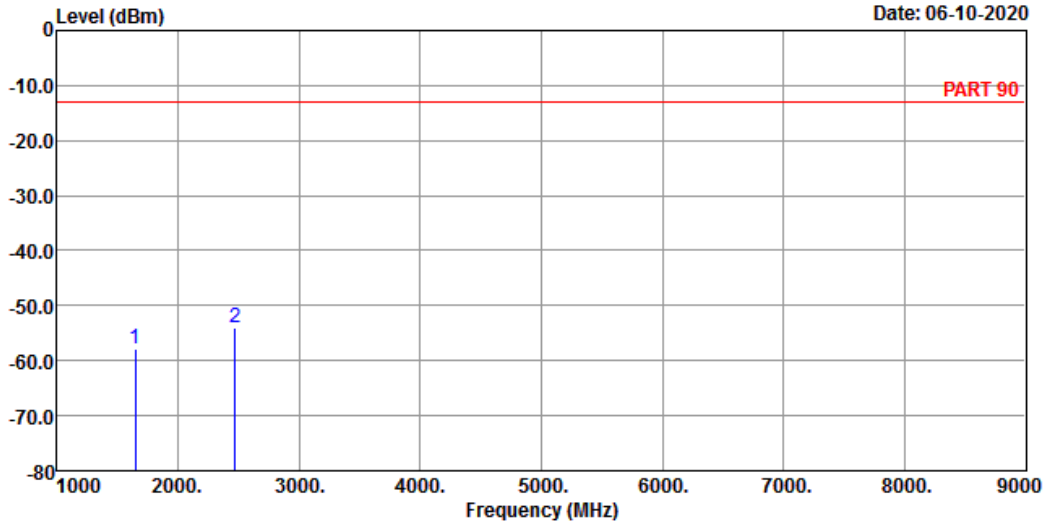

Site : 966 Chamber 5
 Condition: PART 90 HORIZONTAL
 Remak : Cat-M1 Band 26 QPSK_1.4M Link_H-CH
 Tested by: Jisyong Wang

	Freq	Level	Read Level	Limit	Line Factor	Over Limit	Remark
	MHz	dBm	dBm	dBm	dB	dB	
1	1646.60	-57.85	-44.14	-13.00	-13.71	-44.85	Peak
2 pp	2469.90	-53.98	-43.96	-13.00	-10.02	-40.98	Peak



Bureau Veritas Consumer Products Services Ltd., Taoyuan Branch

A D T

Data: 4

Date: 06-10-2020

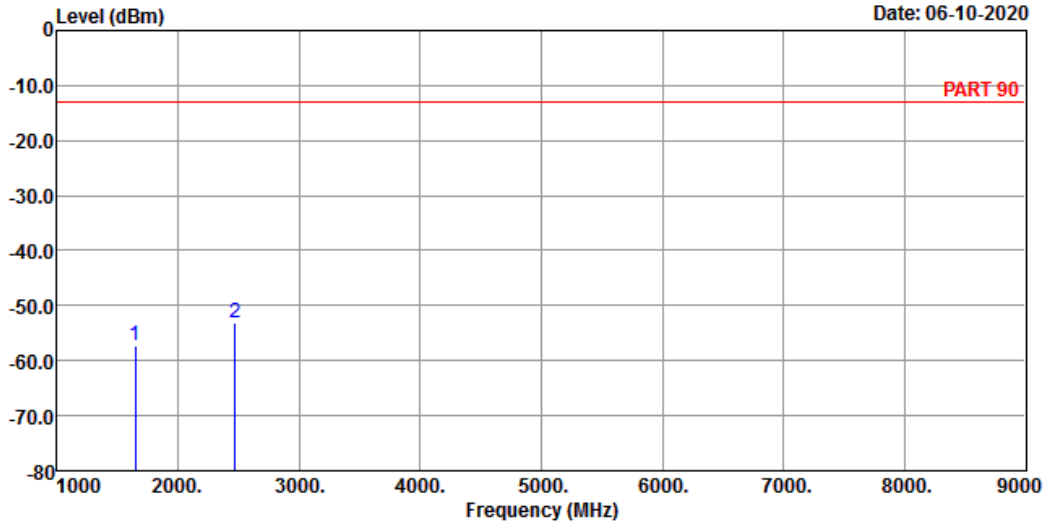

Site : 966 Chamber 5
 Condition: PART 90 VERTICAL
 Remak : Cat-M1 Band 26 QPSK_1.4M Link_H-CH
 Tested by: Jisyong Wang

	Freq	Level	Read Level	Limit	Line Factor	Over Limit	Remark
	MHz	dBm	dBm	dBm	dB	dB	
1	1646.60	-57.23	-43.52	-13.00	-13.71	-44.23	Peak
2	pp 2469.90	-53.16	-43.14	-13.00	-10.02	-40.16	Peak

Channel Bandwidth: 5 MHz / QPSK
Low Channel



Bureau Veritas Consumer Products Services Ltd., Taoyuan Branch

A D T

Data: 3

Date: 06-10-2020

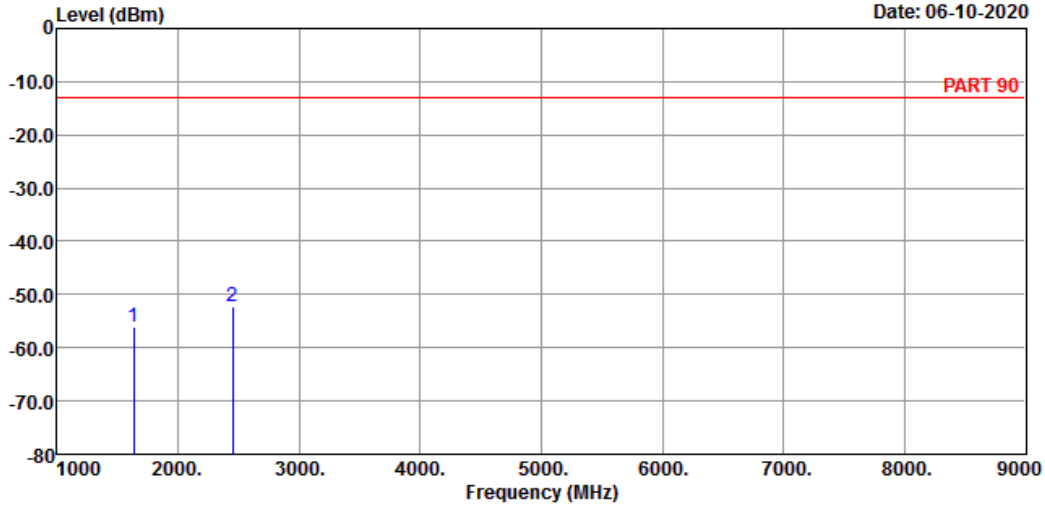

Site : 966 Chamber 5
Condition: PART 90 HORIZONTAL
Remak : Cat-M1 Band 26 QPSK_5M Link_L-CH
Tested by: Jisyong Wang

	Freq	Level	Read Level	Limit	Line Factor	Over Limit	Remark
	MHz	dBm	dBm	dBm	dB	dB	
1	1633.00	-55.99	-42.34	-13.00	-13.65	-42.99	Peak
2 pp	2449.50	-52.13	-42.15	-13.00	-9.98	-39.13	Peak



Bureau Veritas Consumer Products Services Ltd., Taoyuan Branch

A D T

Data: 4

Date: 06-10-2020

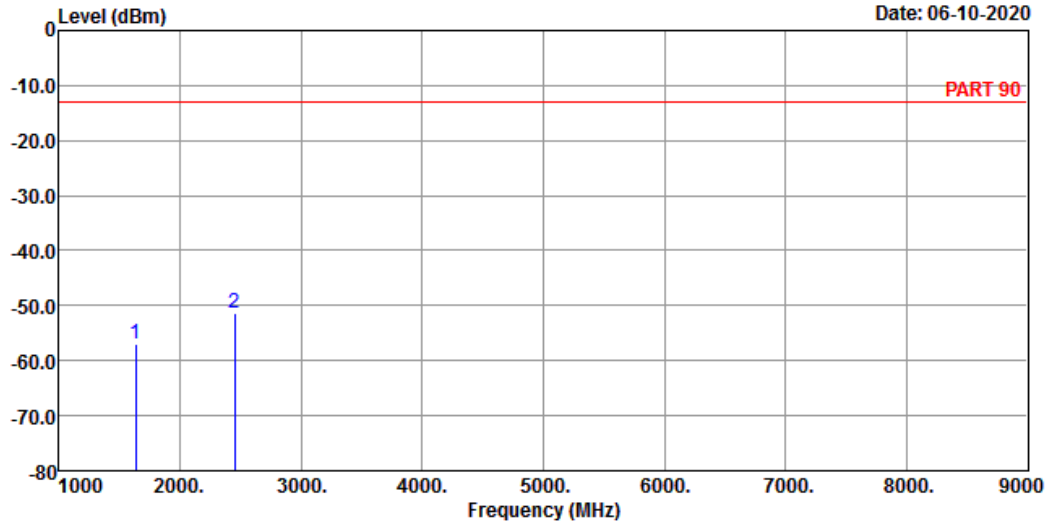

Site : 966 Chamber 5
 Condition: PART 90 VERTICAL
 Remak : Cat-M1 Band 26 QPSK_5M Link_L-CH
 Tested by: Jisyong Wang

	Freq	Level	Read Level	Limit	Line Factor	Over Limit	Remark
	MHz	dBm	dBm	dBm	dB	dB	
1	1633.00	-56.85	-43.20	-13.00	-13.65	-43.85	Peak
2	pp 2449.50	-51.26	-41.28	-13.00	-9.98	-38.26	Peak

Middle Channel



Bureau Veritas Consumer Products Services Ltd., Taoyuan Branch

A D T

Data: 3

Date: 06-10-2020

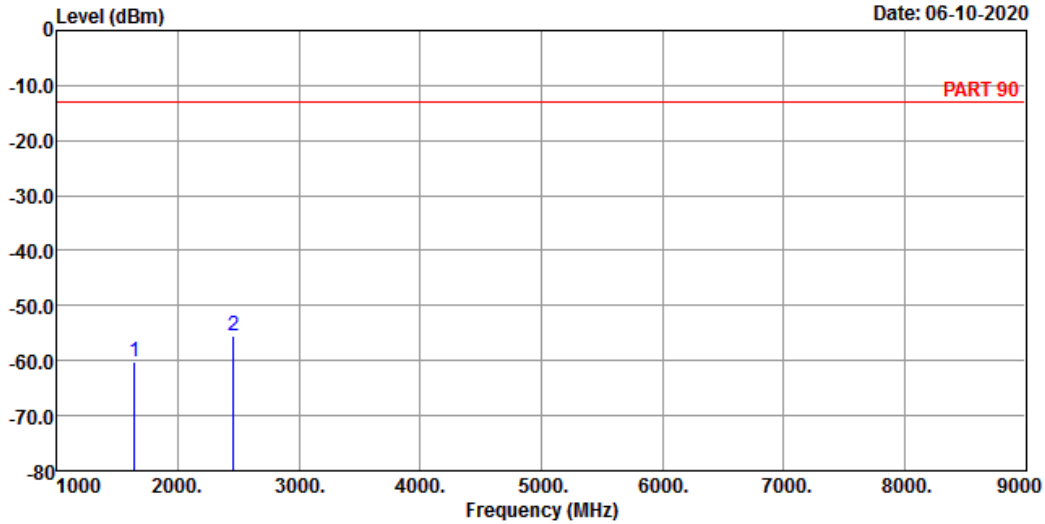

Site : 966 Chamber 5
 Condition: PART 90 HORIZONTAL
 Remak : Cat-M1 Band 26 QPSK_5M Link_M-CH
 Tested by: Jisyong Wang

	Freq	Level	Read Level	Limit	Line Factor	Over Limit	Remark
	MHz	dBm	dBm	dBm	dB	dB	
1	1638.00	-60.13	-46.45	-13.00	-13.68	-47.13	Peak
2 pp	2457.00	-55.56	-45.57	-13.00	-9.99	-42.56	Peak



Bureau Veritas Consumer Products Services Ltd., Taoyuan Branch

A D T

Data: 4

Date: 06-10-2020

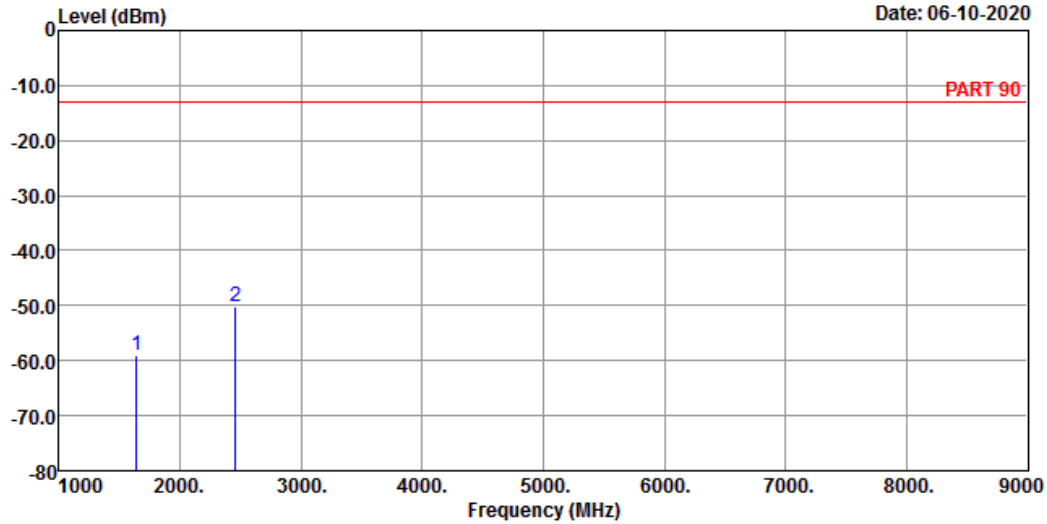

Site : 966 Chamber 5
 Condition: PART 90 VERTICAL
 Remak : Cat-M1 Band 26 QPSK_5M Link_M-CH
 Tested by: Jisyong Wang

	Freq	Level	Read Level	Limit	Line Factor	Over Limit	Remark
	MHz	dBm	dBm	dBm	dB	dB	
1	1638.00	-58.95	-45.27	-13.00	-13.68	-45.95	Peak
2	2457.00	-50.26	-40.27	-13.00	-9.99	-37.26	Peak

High Channel



Bureau Veritas Consumer Products Services Ltd., Taoyuan Branch

A D T

Data: 3

Date: 06-10-2020

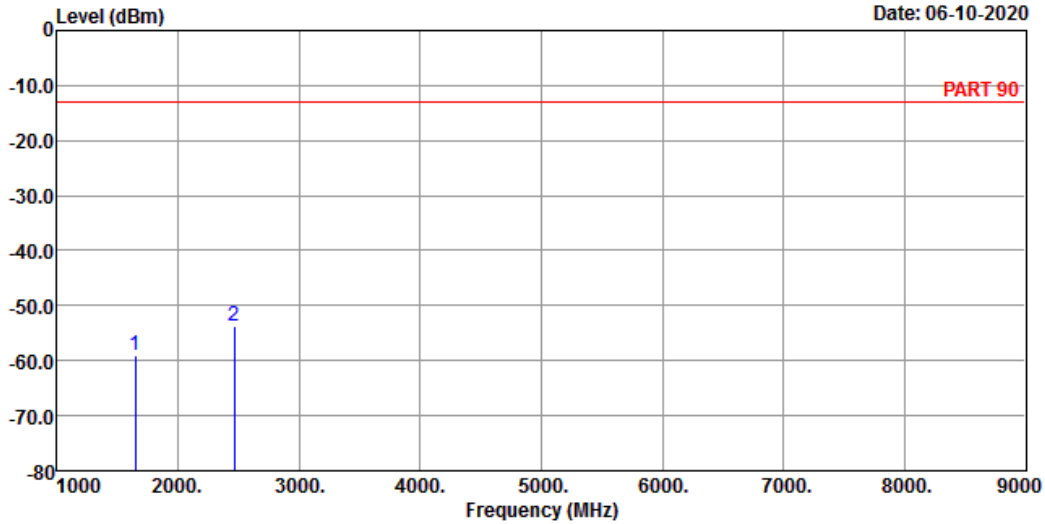

Site : 966 Chamber 5
 Condition: PART 90 HORIZONTAL
 Remak : Cat-M1 Band 26 QPSK_5M Link_H-CH
 Tested by: Jisyong Wang

	Freq	Level	Read Level	Limit	Line Factor	Over Limit	Remark
	MHz	dBm	dBm	dBm	dB	dB	
1	1643.00	-58.99	-45.28	-13.00	-13.71	-45.99	Peak
2 pp	2464.50	-53.62	-43.61	-13.00	-10.01	-40.62	Peak



Bureau Veritas Consumer Products Services Ltd., Taoyuan Branch

A D T

Data: 4

Date: 06-10-2020

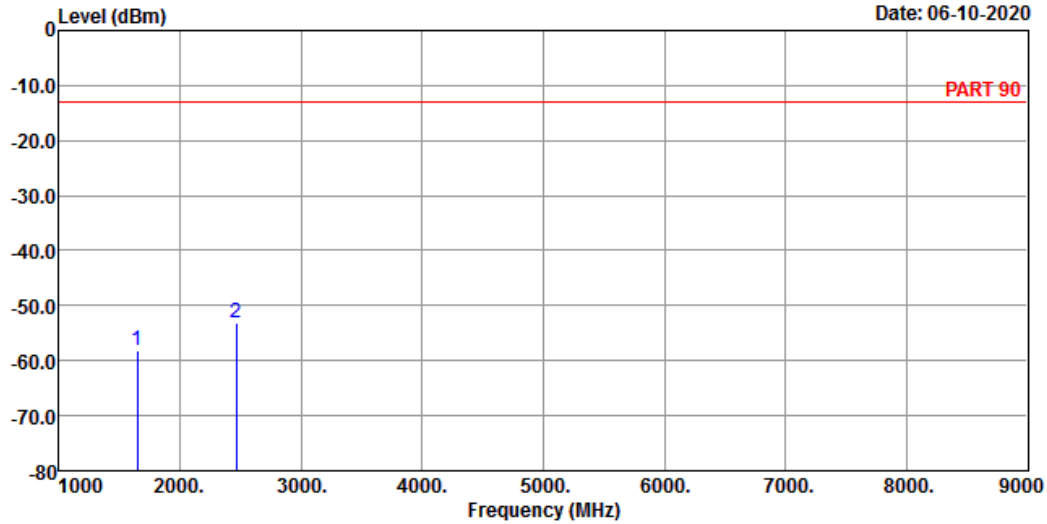

Site : 966 Chamber 5
 Condition: PART 90 VERTICAL
 Remak : Cat-M1 Band 26 QPSK_5M Link_H-CH
 Tested by: Jisyong Wang

	Freq	Level	Read Level	Limit	Line Factor	Over Limit	Remark
	MHz	dBm	dBm	dBm	dB	dB	
1	1643.00	-58.13	-44.42	-13.00	-13.71	-45.13	Peak
2	pp 2464.50	-53.26	-43.25	-13.00	-10.01	-40.26	Peak

Channel Bandwidth: 10 MHz / QPSK
Middle Channel



Bureau Veritas Consumer Products Services Ltd., Taoyuan Branch

A D T

Data: 5

Date: 06-10-2020

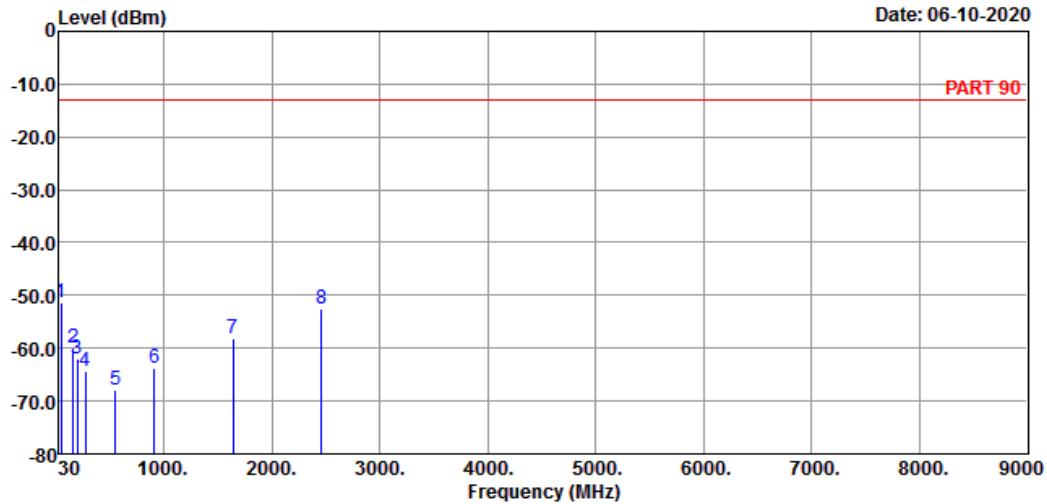

Site : 966 Chamber 5
Condition: PART 90 HORIZONTAL
Remak : Cat-M1 Band 26 QPSK_10M Link_M-CH
Tested by: Jisyong Wang

	Freq	Level	Read	Limit	Over		
	MHz	dBm	Level	Line	Factor	Limit	Remark
			dBm	dBm	dB	dB	
1	pp	44.55	-51.39	-49.40	-13.00	-1.99	-38.39 Peak
2		160.95	-59.87	-54.96	-13.00	-4.91	-46.87 Peak
3		197.81	-62.12	-54.29	-13.00	-7.83	-49.12 Peak
4		273.47	-64.25	-57.78	-13.00	-6.47	-51.25 Peak
5		547.98	-68.01	-65.09	-13.00	-2.92	-55.01 Peak
6		907.85	-63.68	-64.44	-13.00	0.76	-50.68 Peak
7		1638.00	-58.11	-44.43	-13.00	-13.68	-45.11 Peak
8		2457.00	-52.52	-42.53	-13.00	-9.99	-39.52 Peak



Bureau Veritas Consumer Products Services Ltd., Taoyuan Branch

A D T

Data: 6

Date: 06-10-2020

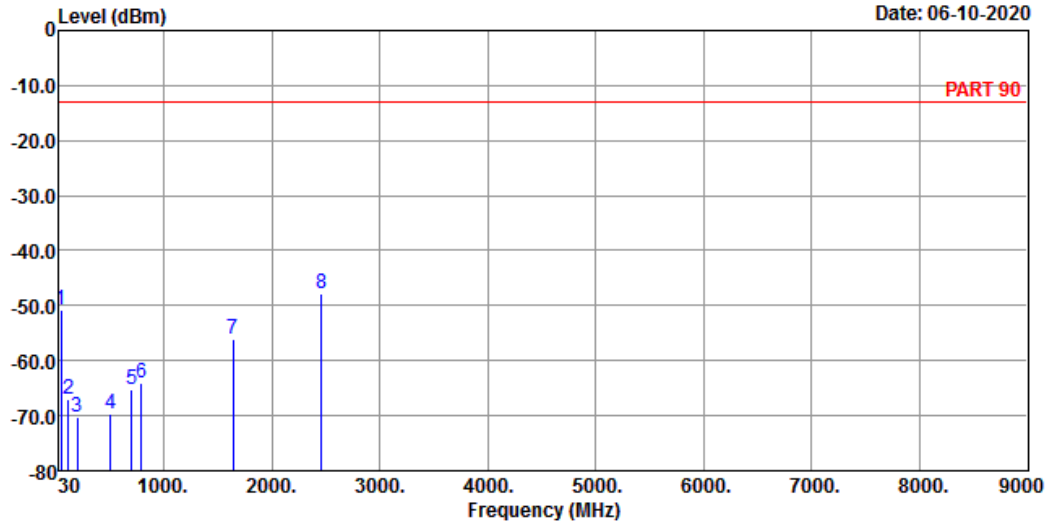

Site : 966 Chamber 5
 Condition: PART 90 VERTICAL
 Remak : Cat-M1 Band 26 QPSK_10M Link_M-CH
 Tested by: Jisyong Wang

	Freq	Level	Read Level	Limit	Line Factor	Over Limit	Remark
	MHz	dBm	dBm	dBm	dB	dB	
1	44.55	-50.64	-48.65	-13.00	-1.99	-37.64	Peak
2	112.45	-67.14	-56.94	-13.00	-10.20	-54.14	Peak
3	193.93	-70.35	-62.89	-13.00	-7.46	-57.35	Peak
4	508.21	-69.72	-65.39	-13.00	-4.33	-56.72	Peak
5	700.27	-65.11	-65.01	-13.00	-0.10	-52.11	Peak
6	793.39	-63.94	-64.69	-13.00	0.75	-50.94	Peak
7	1638.00	-56.11	-42.43	-13.00	-13.68	-43.11	Peak
8 pp	2457.00	-47.92	-37.93	-13.00	-9.99	-34.92	Peak

NB-IoT
 LTE Band 26
 Low Channel



Bureau Veritas Consumer Products Services Ltd., Taoyuan Branch

A D T

Data: 3

Date: 2020-06-07

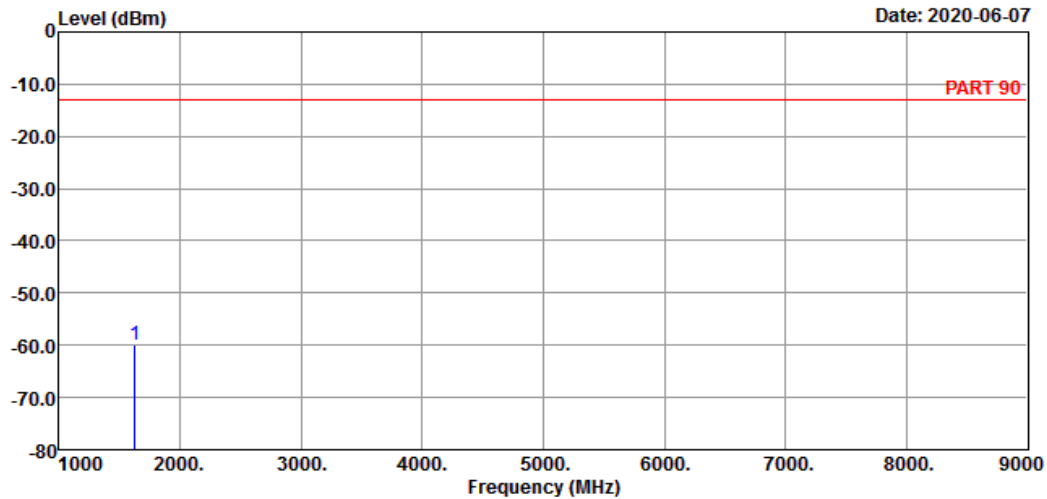

Site : 966 Chamber 5
 Condition: PART 90 HORIZONTAL
 Remak : NB-IOT Band 26 Stand-alone_Link_L-Ch
 Tested by: Jisyong Wang

Freq	Level	Read Level	Limit	Line Factor	Over Limit	Remark
MHz	dBm	dBm	dBm	dB	dB	
1 pp 1628.40	-59.85	-45.06	-13.00	-14.79	-46.85	Peak



Bureau Veritas Consumer Products Services Ltd., Taoyuan Branch

A D T

Data: 4

Date: 2020-06-07

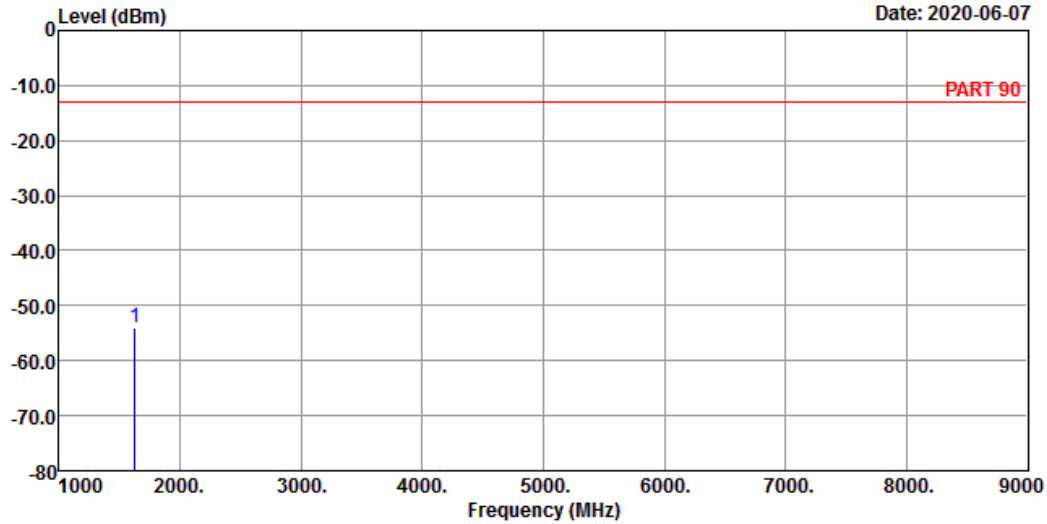

Site : 966 Chamber 5
 Condition: PART 90 VERTICAL
 Remak : NB-IOT Band 26 Stand-alone_Link_L-Ch
 Tested by: Jisyong Wang

Freq	Level	Read Level	Limit	Line Factor	Over Limit	Remark
MHz	dBm	dBm	dBm	dB	dB	
1 pp 1628.40	-53.95	-39.16	-13.00	-14.79	-40.95	Peak

Middle Channel



Bureau Veritas Consumer Products Services Ltd., Taoyuan Branch

A D T

Data: 3

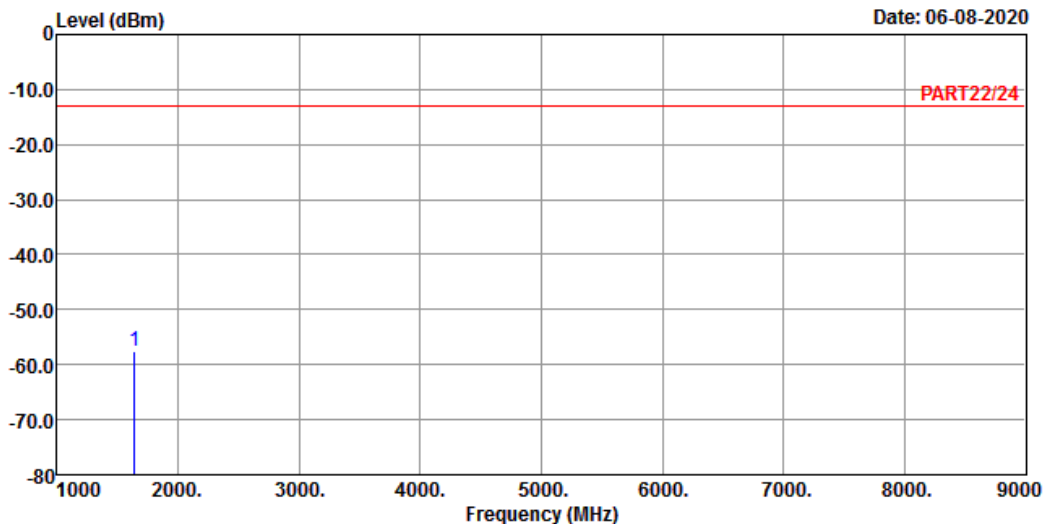

Site : 966 Chamber 5
 Condition: PART22/24 HORIZONTAL
 Remak : NB-IOT Band 26 Stand-alone_Link_M-Ch
 Tested by: Jisyong Wang

Freq	Level	Read Level	Limit	Line Factor	Over Limit	Remark
MHz	dBm	dBm	dBm	dB	dB	

1 pp 1638.00 -57.52 -43.84 -13.00 -13.68 -44.52 Peak



Bureau Veritas Consumer Products Services Ltd., Taoyuan Branch

A D T

Data: 4

Date: 06-08-2020

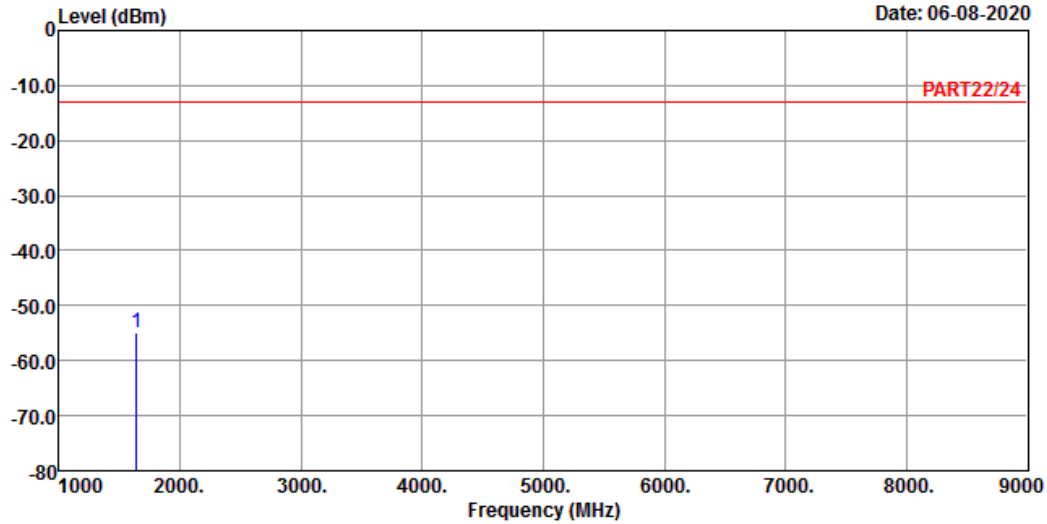

Site : 966 Chamber 5
 Condition: PART22/24 VERTICAL
 Remak : NB-IOT Band 26 Stand-alone_Link_M-Ch
 Tested by: Jisyong Wang

Freq	Level	Read Level	Limit	Line Factor	Over Limit	Remark
MHz	dBm	dBm	dBm	dB	dB	
1 pp 1638.00	-54.99	-41.31	-13.00	-13.68	-41.99	Peak

High Channel



Bureau Veritas Consumer Products Services Ltd., Taoyuan Branch

A D T

Data: 5

Date: 06-08-2020

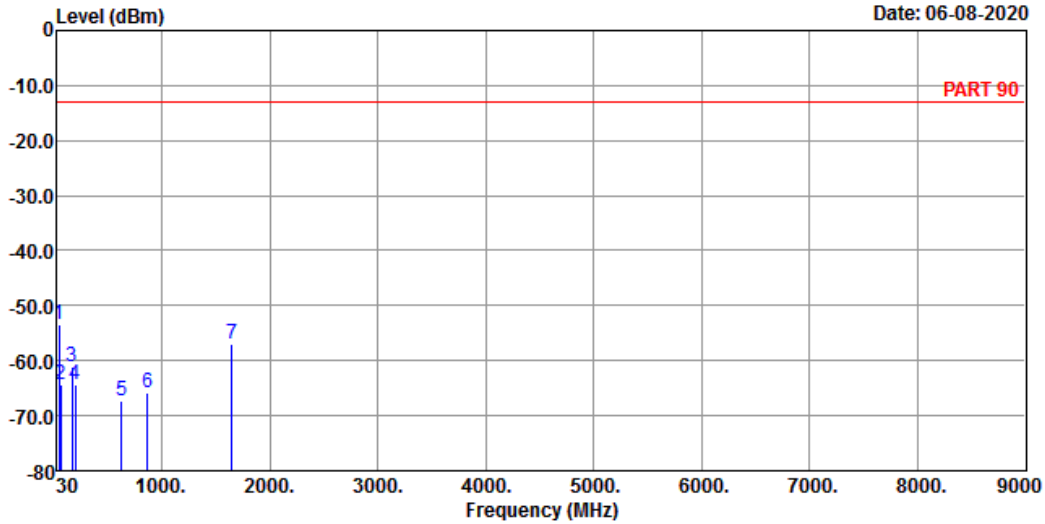

Site : 966 Chamber 5
 Condition: PART 90 HORIZONTAL
 Remak : NB-IOT Band 26 Stand-alone_Link_H-Ch
 Tested by: Jisyong Wang

	Read	Limit	Over					
Freq	Level	Level	Line	Factor	Limit	Remark		
MHz	dBm	dBm	dBm	dB	dB			
1 pp	43.58	-53.33	-51.86	-13.00	-1.47	-40.33	Peak	
2	59.10	-64.49	-57.09	-13.00	-7.40	-51.49	Peak	
3	163.86	-61.17	-56.05	-13.00	-5.12	-48.17	Peak	
4	196.84	-64.43	-56.69	-13.00	-7.74	-51.43	Peak	
5	627.52	-67.24	-66.41	-13.00	-0.83	-54.24	Peak	
6	867.11	-65.70	-66.09	-13.00	0.39	-52.70	Peak	
7	1647.60	-57.11	-42.38	-13.00	-14.73	-44.11	Peak	



Bureau Veritas Consumer Products Services Ltd., Taoyuan Branch

A D T

Data: 6

Date: 06-08-2020

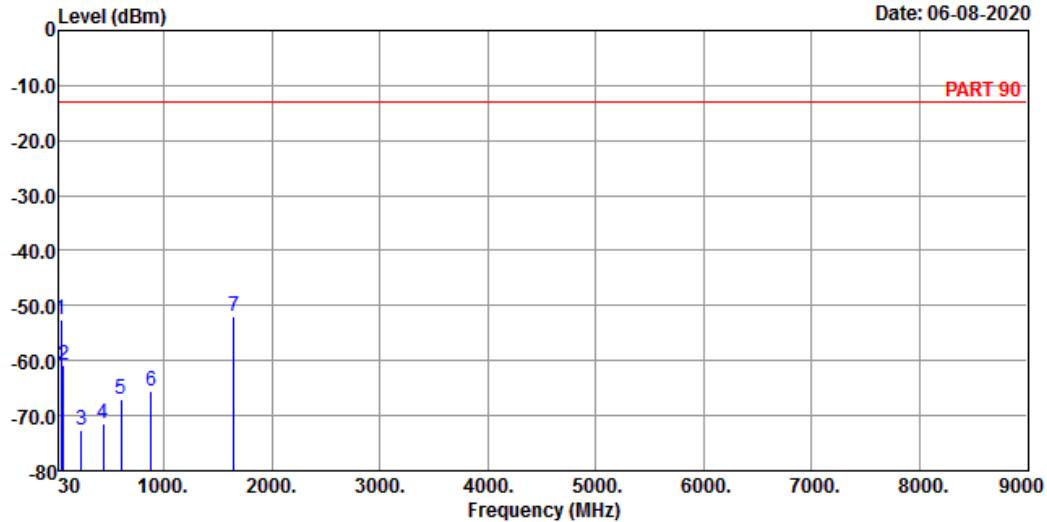

Site : 966 Chamber 5
 Condition: PART 90 VERTICAL
 Remak : NB-IOT Band 26 Stand-alone_Link_H-Ch
 Tested by: Jisyong Wang

	Freq	Level	Read Level	Limit	Line Factor	Over Limit	Remark
	MHz	dBm	dBm	dBm	dB	dB	
1	43.58	-52.61	-51.14	-13.00	-1.47	-39.61	Peak
2	69.77	-60.84	-52.44	-13.00	-8.40	-47.84	Peak
3	233.70	-72.66	-66.00	-13.00	-6.66	-59.66	Peak
4	439.34	-71.39	-65.76	-13.00	-5.63	-58.39	Peak
5	605.21	-66.90	-66.13	-13.00	-0.77	-53.90	Peak
6	884.57	-65.59	-66.08	-13.00	0.49	-52.59	Peak
7 pp	1647.60	-52.03	-37.30	-13.00	-14.73	-39.03	Peak

5 Pictures of Test Arrangements

Please refer to the attached file (Test Setup Photo).

Appendix – Information of the Testing Laboratories

We, Bureau Veritas Consumer Products Services (H.K.) Ltd., Taoyuan Branch, were founded in 1988 to provide our best service in EMC, Radio, Telecom and Safety consultation. Our laboratories are FCC recognized accredited test firms and accredited according to ISO/IEC 17025.

If you have any comments, please feel free to contact us at the following:

Lin Kou EMC/RF Lab

Tel: 886-2-26052180

Fax: 886-2-26051924

Hsin Chu EMC/RF/Telecom Lab

Tel: 886-3-6668565

Fax: 886-3-6668323

Hwa Ya EMC/RF/Safety Lab

Tel: 886-3-3183232

Fax: 886-3-3270892

Email: service.adt@tw.bureauveritas.com

Web Site: www.bureauveritas-adt.com

The address and road map of all our labs can be found in our web site also.

--- END ---