RF Test Report

Test in accordance with
Federal Communications Commission(FCC)
CFR TITLE 47, Parts 2, 22, 24
&
Industry Canada (IC), RSS-GEN, 132,133

Product Name : HL6528X
Model No. : HL6528-G2.8V
FCC ID : N7NHL6528G28V
IC : 2417C-HL6528G28V

Applicant : Sierra Wireless Inc.
Address : 13811 Wireless way Richmond, BC, V6V 3A4
Canada

Date of Receipt : 2014-02-23
Test Date : 2014-02-25~2014-04-29
Issued Date : 2014-04-30
Report No. : UL05420131227FCC/IC010-2
Report Version : V1.0

Notes:

The test results only relate to these samples which have been tested.
Partly using this report will not be admitted unless been allowed by Unilab.
Unilab is only responsible for the complete report with the reported stamp of Unilab.

Test Report Certification

Issued Date : 2014-04-30
Report No. : UL05420131227FCC/IC010-2

Product Name : HL6528X
Applicant : Sierra Wireless Inc.
Address : 13811 Wireless way Richmond, BC, V6V 3A4 Canada
Manufacturer : Sierra Wireless Inc.
Address : 13811 Wireless way Richmond, BC, V6V 3A4 Canada
Model No. : HL6528-G2.8V
EUT Voltage : MIN: 3.3V, NOR: 3.7V, MAX: 4.5V
Brand Name : Sierrawireless
FCC ID: N7NHL6528G28V
IC: 2417C-HL6528G28V
Applicable Standard : NSI/TIA-603-D-2010; FCC CFR Title 47 Part 2;
FCC CFR Title 47 Part 22 Subpart H;
FCC CFR Title 47 Part24 Subpart E;
RSS-GEN Issue2;
Industry Canada RSS-132, Issue3;
Industry Canada RSS-133, Issue6;
Test Result : Complied
Performed Location : Unilab (Shanghai) Co., Ltd.
FCC 2.948 register number is 714465
IC register number is 11025A-1
No. 1350, Lianxi Rd. Pudong New District, Shanghai, China
TEL: +86-21-50275125 FAX: +86-21-50277862

Documented By : Andy Wei
(Technical Engineer: Andy Wei)

Reviewed By : Forest Cao
(Senior Engineer: Forest Cao)

Approved By : Eva Wang
(Supervisor: Eva Wang)

TABLE OF CONTENTS

SUMMARY OF TEST RESULT	4
1. General Information	5
1.1. EUT Description	5
1.2. Mode of Operation	7
1.3. Tested System Details	9
1.4. Configuration of Tested System.....	9
1.5. EUT Exercise Software	8
2. Technical Test.....	9
2.1. Test Environment	9
3. Peak Output Power	10
3.2. Test Setup	10
3.3. Limit	11
3.4. Test Procedure	12
3.5. Uncertainty	12
3.6. Test Result	13
4. Occupied Bandwidth	16
4.1. Test Equipment	16
4.2. Test Setup	16
4.3. Limit	17
4.4. Test Procedure	17
4.5. Uncertainty	17
4.6. Test Result	18
5. Spurious Emission At Antenna Terminals (+/- 1MHz)	26
5.1. Test Equipment	26
5.2. Test Setup	26
5.3. Limit	27
5.4. Test Procedure	27
5.5. Uncertainty	27
5.6. Test Result	28
6. Spurious Emission.....	32
6.1. Test Equipment	32
6.2. Test Setup	33
6.3. Limit	34
6.4. Test Procedure	34
6.5. Uncertainty	35
6.6. Test Result	36
7. Frequency Stability Under Temperature & Voltage Variations.....	45
7.1. Test Equipment	45
7.2. Test Setup	45
7.3. Limit	45
7.4. Test Procedure	46
7.5. Uncertainty	46
7.6. Test Result	47
8. Attachment.....	72

SUMMARY OF TEST RESULT

Report Section	SPECIFICATION		Description	Limit	Result
	FCC CFR 47	IC			
3	part2.1046	N/A	Conducted Output Power	N/A	PASS
3	part 22.913(a)(2)	RSS-132, 5.4	Effective Radiated Power	<7 Watts	PASS
3	part 24.232(c)	RSS-133, 6.4	Equivalent Isotropic Radiated Power	<2 Watts	PASS
4	part 2.1049 part 22.917(a) part 24.238(a)	RSS-GEN, 4.6	Occupied Bandwidth	N/A	PASS
5	part 2.1051 part 22.917(a) part 24.238(a)	RSS-132, 5.5 RSS-133, 6.5	Band Edge Measurement	<43+10lg(P[Watts])	PASS
6	part 2.1051 part 22.917(a) part 24.238(a)	RSS-GEN, 4.9 RSS-132, 5.5 RSS-133, 6.5	Conducted Spurious Emission	<43+10lg(P[Watts])	PASS
6	part 2.1053 part 22.917(a) part 24.238(a)	RSS-GEN, 4.9 RSS-132, 5.5 RSS-133, 6.5	Field Strength of Spurious Radiation	<43+10lg(P[Watts])	PASS
7	part 2.1055 part 22.355 part 24.235	RSS-132, 5.3 RSS-133, 6.3	Frequency Stability for Temperature & Voltage	<2.5 ppm	PASS

1.General Information

1.1. EUT Description

Product Name:	HL6528X
Model Name:	HL6528-G2.8V
Hardware Version:	1.0
Software Version:	HL6N,001.00
RF Exposure Environment:	Uncontrolled
GSM/GPRS	
Support Band:	GSM850/PCS1900
GPRS Class:	10
Tx Frequency Range:	GSM 850: 824.2MHz to 848.8MHz PCS 1900: 1850.2MHz to 1909.8MHz
Rx Frequency Range:	GSM 850: 869.2MHz to 893.8MHz PCS 1900: 1930.2MHz to 1989.8MHz
Type of modulation:	GSM/GPRS: GMSK
Antenna Type:	External
Antenna Peak Gain:	GSM 850: 1dBi PCS 1900: 2 dBi

1.2. Mode of Operation

Unilab has verified the construction and function in typical operation. EUT is inlink mode with base station emulator at maximum power level. All the test modes were carried out with the EUT in normal operation, which was shown in this test report and defined as:

Test Mode		
Band	Radiated TCs	Conducted TCs
GSM 850	GSM Link GPRS 8 Link	GSM Link GPRS 8 Link
GSM1900	GSM Link GPRS 8 Link	GSM Link GPRS 8 Link

Note:

1. Regards to the frequency band operation: the lowest, middle and highest frequency of channel were selected to perform the test, then shown on this report.
2. The maximum power levels are GSM for GMSK link, GPRS multi-slot class 8 mode for GMSK link.
3. For the ERP/EIRP and radiated emission test, every axis (X, Y, Z) was verified, and show the worst (Z axis) result on this report.
4. This device is a composite device in accordance with Part 15 Subpart B regulations. The report number is UL05420131227FCC/IC010-2.

The conducted power table is as follows:

Conducted Power (Unit: dBm)						
Band	GSM 850			GSM 1900		
Channel	128	189	251	512	661	810
Frequency	824.2	836.4	848.8	1850.2	1880	1909.8
GSM	33.22	33.27	33.28	29.15	28.92	28.75
GPRS 8	33.16	33.17	33.19	29.13	28.82	28.66
GPRS 10	32.83	32.86	32.68	28.92	28.80	28.62

1.3. Tested System Details

The types for all equipments, plus descriptions of all cables used in the tested system (including inserted cards) are:

Product	Manufacturer	Model	Serial No.	Power Cord
1 Agilent8960	Agilent	E5515C	GB46581718	N/A

1.4. Configuration of Tested System

Connection Diagram

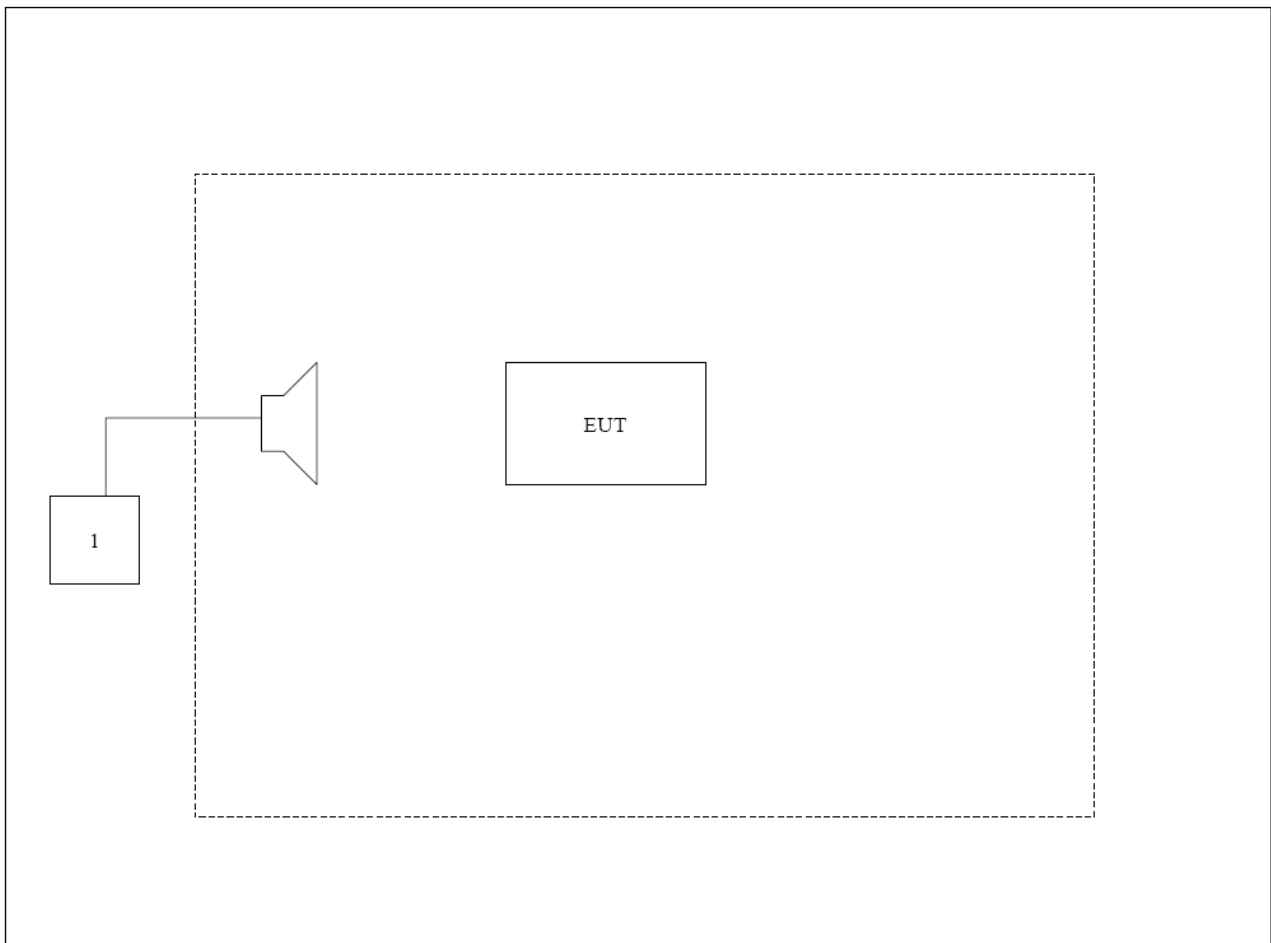

1.5. EUT Exercise Software

1	Setup the EUT and simulators as shown on above.
2	Turn on the power of all equipment.
3	EUT Communicate with E5515C, then select channel to test.

2. Technical Test

2.1. Test Environment

Items	Required (IEC 68-1)	Actual
Temperature (°C)	15-35	25
Humidity (%RH)	25-75	45
Barometric pressure (mbar)	860-1060	950-1000

3. Peak Output Power

3.1. Test Equipment

Instrument	Manufacturer	Model	Serial No.	Cali. Due Date
Spectrum Analyzer	Agilent	N9038A	MY51210142	2014.07.27
Radio Communication Tester	Agilent	E5515C	GB46581718	2014.10.24
Signal Generator	Agilent	N5183A	MY50140938	2014.10.07
Preamplifier	CEM	EM30180	3008A0245	2015.02.28
DC Power Supply	Agilent	6612C	MY43002989	2015.03.03
Bilog Antenna	Schwarzbeck	VULB9160	9160-3316	2014.07.19
VHF-UHF-Biconical Antenna	Schwarzbeck	VUBA9117	9117-263	2014.07.19
Broad-Band Horn Antenna	Schwarzbeck	BBHA9120D	9120D-942	2014.07.19
Broad-Band Horn Antenna	Schwarzbeck	BBHA9120D	9120D-943	2014.07.19

3.2. Test Setup

Conducted Power Measurement:

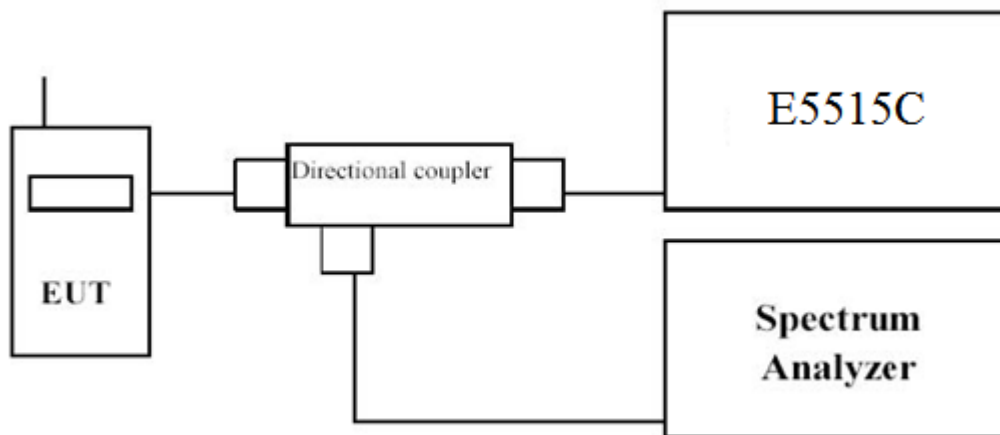

Radiated Spurious Measurement: below 1GHz

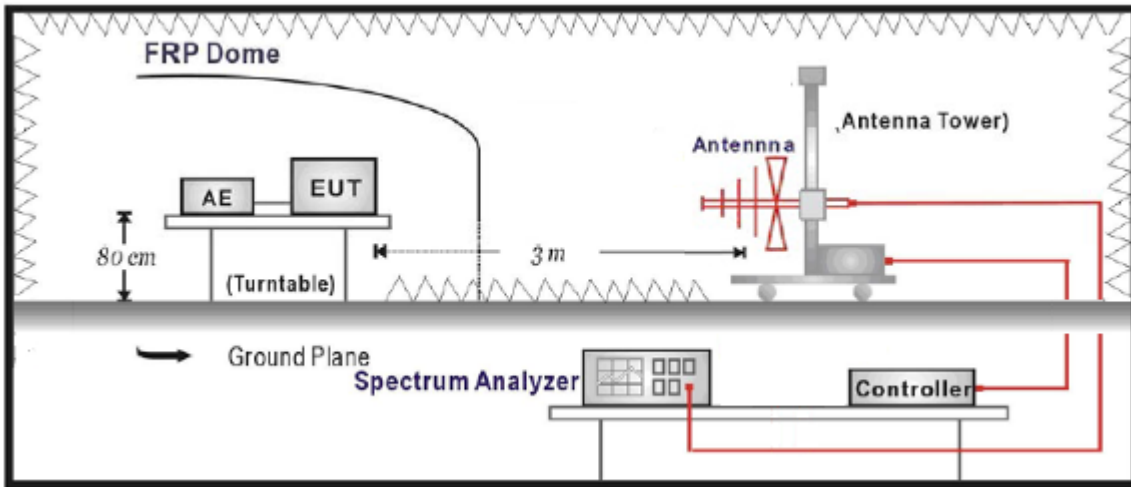

Radiated Spurious Measurement: above 1GHz

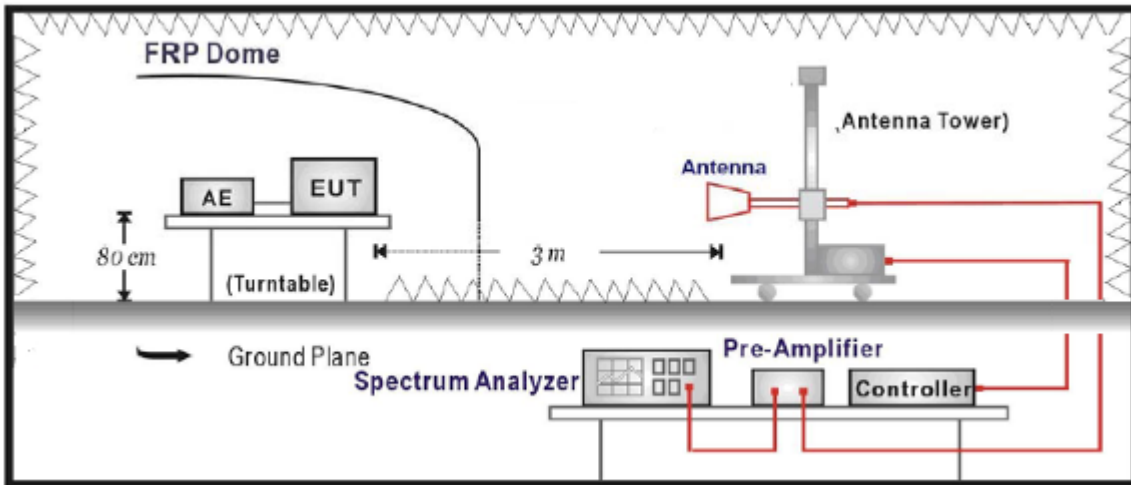

3.3. Limit

For FCC Part 22.913(a)(2):

The ERP of mobile transmitters and auxiliary test transmitters must not exceed 7 Watts.

For FCC Part 24.232(c):

The EIRP of mobile transmitters and auxiliary test transmitters must not exceed 2 Watts.

3.4. Test Procedure

Conducted Power Measurement:

- a. Place the EUT on a bench and set it in transmitting mode.
- b. Connect a low loss RF cable from the antenna port to a spectrum analyzer and E5515C by a Directional Couple.
- c. EUT Communicate with E5515C, then selects a channel for testing.
- d. Add a correction factor to the display of spectrum, and then test.

Radiated Power Measurement:

- a. The EUT shall be placed at the specified height on a support, and in the position closest to normal use as declared by provider.
- b. The test antenna shall be oriented initially for vertical polarization and shall be chosen to correspond to the frequency of the transmitter
- c. The output of the test antenna shall be connected to the measuring receiver.
- d. The transmitter shall be switched on and the measuring receiver shall be tuned to the frequency of the transmitter under test.
- e. The test antenna shall be raised and lowered through the specified range of height until a maximum signal level is detected by the measuring receiver.
- f. The transmitter shall then be rotated through 360° in the horizontal plane, until the maximum signal level is detected by the measuring receiver.
- g. The test antenna shall be raised and lowered again through the specified range of height until a maximum signal level is detected by the measuring receiver.
- h. The maximum signal level detected by the measuring receiver shall be noted.
- i. The transmitter shall be replaced by a substitution antenna.
- j. The substitution antenna shall be orientated for vertical polarization and the length of the substitution antenna shall be adjusted to correspond to the frequency of the transmitter.
- k. The substitution antenna shall be connected to a calibrated signal generator.
- l. If necessary, the input attenuator setting of the measuring receiver shall be adjusted in order to increase the sensitivity of the measuring receiver.
- m. The test antenna shall be raised and lowered through the specified range of height to ensure that the maximum signal is received.
- n. The input signal to the substitution antenna shall be adjusted to the level that produces a level detected by the measuring receiver, that is equal to the level noted while the transmitter radiated power was measured, corrected for the change of input attenuator setting of the measuring receiver.
- o. The measurement shall be repeated with the test antenna and the substitution antenna orientated for horizontal polarization.
- p. The measure of the effective radiated power is the larger of the two levels recorded at the input to the substitution antenna, corrected for gain of the substitution antenna if necessary.
- q. Test site anechoic chamber refer to ANSI C63.4: 2009.

3.5. Uncertainty

The measurement uncertainty is defined as for Conducted Power Measurement ± 1.1 dB,
for Radiated Power Measurement ± 3.1 dB

3.6. Test Result

The following table shows the conducted power measured:

Table 1

GSM850				
Modes	Channel	Frequency (MHz)	Conducted Power (dBm)	Conducted Power (W)
GSM850 (GSM)	128(Low)	824.2	33.22	2.10
	189(Mid)	836.4	33.27	2.12
	251(High)	848.8	33.28	2.13
GSM850 (GPRS 8)	128(Low)	824.2	33.16	2.07
	189(Mid)	836.4	33.17	2.07
	251(High)	848.8	33.19	2.08

Table 2

GSM1900				
Modes	Channel	Frequency (MHz)	Conducted Power (dBm)	Conducted Power (W)
GSM1900 (GSM)	512(Low)	1850.2	29.15	0.82
	661(Mid)	1880.0	28.92	0.78
	810(High)	1909.8	28.75	0.75
GSM1900 (GPRS 8)	512(Low)	1850.2	29.13	0.82
	661(Mid)	1880.0	28.82	0.76
	810(High)	1909.8	28.66	0.73

The following table shows the Radiated power measured :

GSM850 (GSM Link)

Frequency (MHz)	Ant. Pol. (H/V)	SG Reading (dBm)	Cable Loss (dB)	Gain (dBd)	ERP (dBm)	ERP (W)
Low Channel 128 (824.20MHz)						
824.2	H	35.44	3.81	-2.99	28.64	0.73
824.2	V	36.59	3.81	-2.99	29.79	0.95
Middle Channel 189 (836.40MHz)						
836.4	H	34.72	3.96	-3.04	27.72	0.59
836.4	V	35.86	3.96	-3.04	28.86	0.76
High Channel 251 (848.80MHz)						
848.8	H	35.21	3.98	-3.10	28.13	0.65
848.8	V	36.15	3.98	-3.10	29.07	0.80

GSM850 (GPRS 8 Link)

Frequency (MHz)	Ant. Pol. (H/V)	SG Reading (dBm)	Cable Loss (dB)	Gain (dBd)	ERP (dBm)	ERP (W)
Low Channel 128 (824.20MHz)						
824.2	H	35.18	3.83	-2.99	28.36	0.68
824.2	V	35.82	3.83	-2.99	29.00	0.79
Middle Channel 189 (836.40MHz)						
836.4	H	34.28	3.96	-3.04	27.28	0.53
836.4	V	35.65	3.96	-3.04	28.65	0.73
High Channel 251 (848.80MHz)						
848.8	H	35.15	3.97	-3.10	28.08	0.64
848.8	V	35.87	3.97	-3.10	28.80	0.75

GSM1900 (GSM Link)

Frequency (MHz)	Ant. Pol. (H/V)	SG Reading (dBm)	Cable Loss (dB)	Gain (dBi)	EIRP (dBm)	EIRP (W)
Low Channel 512(1850.20MHz)						
1850.2	H	23.15	6.26	10.40	27.29	0.53
1850.2	V	23.72	6.26	10.40	27.86	0.48
Middle Channel 661 (1880.00MHz)						
1880.0	H	24.10	6.19	10.43	28.34	0.68
1880.0	V	23.85	6.19	10.43	28.07	0.64
High Channel 810 (1909.80MHz)						
1909.8	H	23.83	6.15	10.44	28.12	0.64
1909.8	V	22.95	6.15	10.44	27.24	0.52

GSM1900 (GPRS 8 Link)

Frequency (MHz)	Ant. Pol. (H/V)	SG Reading (dBm)	Cable Loss (dB)	Gain (dBi)	EIRP (dBm)	EIRP (W)
Low Channel 512(1850.20MHz)						
1850.2	H	23.15	6.26	10.40	27.29	0.53
1850.2	V	22.80	6.26	10.40	26.94	0.49
Middle Channel 661 (1880.00MHz)						
1880.0	H	22.86	6.19	10.43	27.10	0.51
1880.0	V	22.67	6.19	10.43	26.91	0.49
High Channel 810 (1909.80MHz)						
1909.8	H	23.77	6.15	10.44	28.06	0.63
1909.8	V	23.40	6.15	10.44	27.69	0.58

4. Occupied Bandwidth

4.1. Test Equipment

Occupied Bandwidth

Instrument	Manufacturer	Model	Serial No	Cal. Date
Radio Communication Tester	Agilent	E5515C	GB46581718	2014.10.24
Spectrum Analyzer	Agilent	N9038A	MY51210142	2014.07.27
DC Power Supply	Agilent	6612C	MY43002989	2015.03.03

4.2. Test Setup

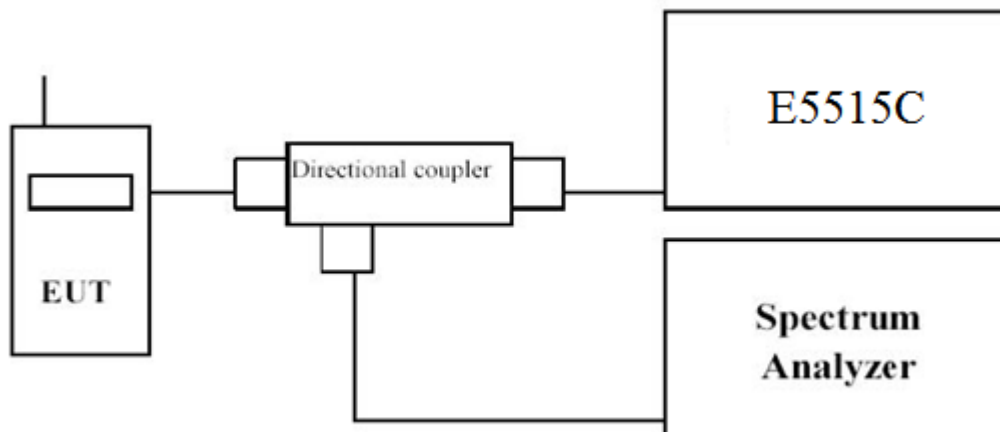

4.3. Limit

N/A

4.4. Test Procedure

Using Occupied Bandwidth measurement function of spectrum analyzer, and setting as follows:
For GSM850/1900 test --- RBW = 3 kHz and VBW = 10 kHz

4.5. Uncertainty

The measurement uncertainty is defined as ± 10 Hz

4.6. Test Result

GSM850 (GSM Link)

Channel No.	Frequency (MHz)	-26dB Occupied Bandwidth (kHz)	99% Occupied Bandwidth (kHz)
128	824.20	347.2	295.9
189	836.40	351.1	290.8
251	848.80	349.3	293.1

GSM850 (GSM Link), Channel 128

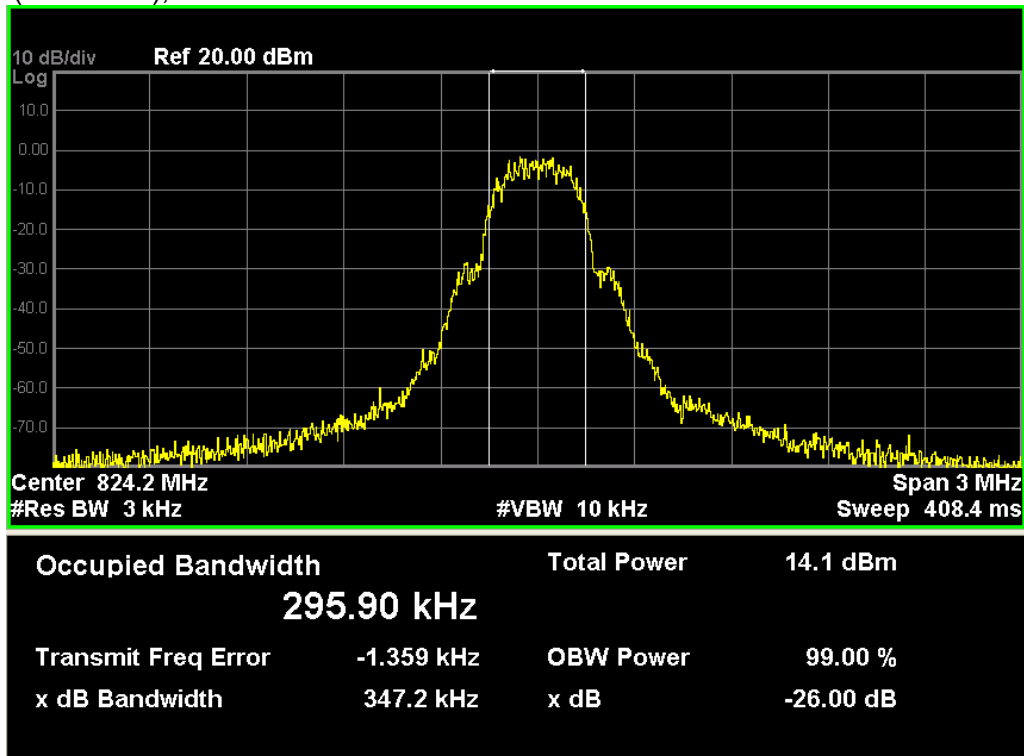

GSM850 (GSM Link), Channel 189

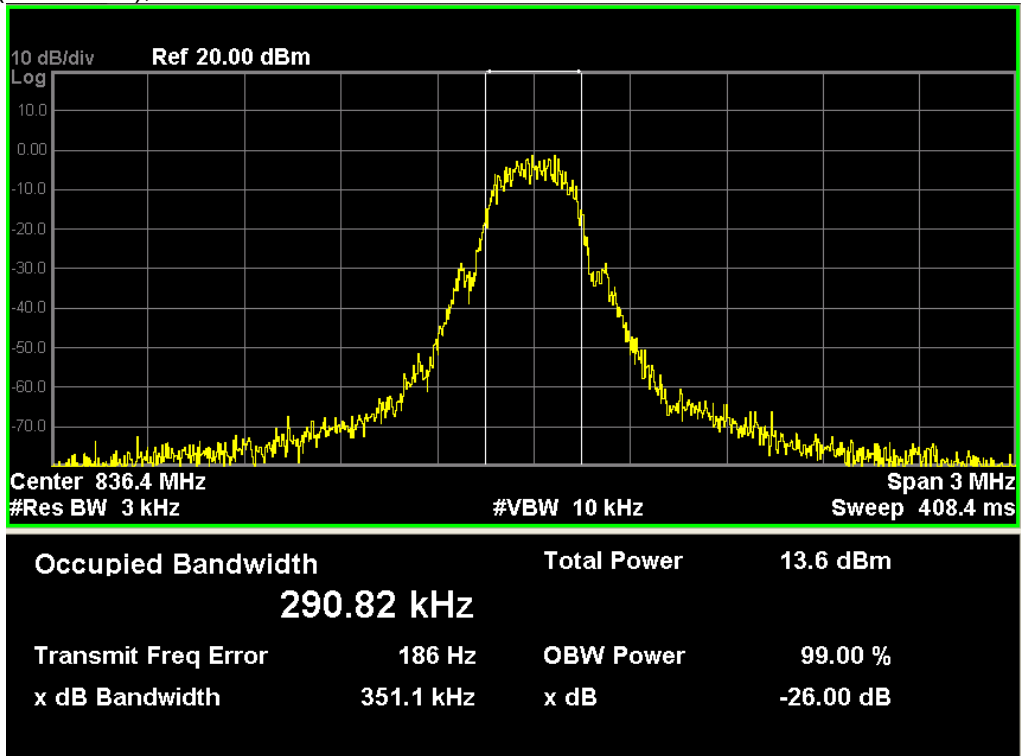

GSM850 (GSM Link), Channel 251

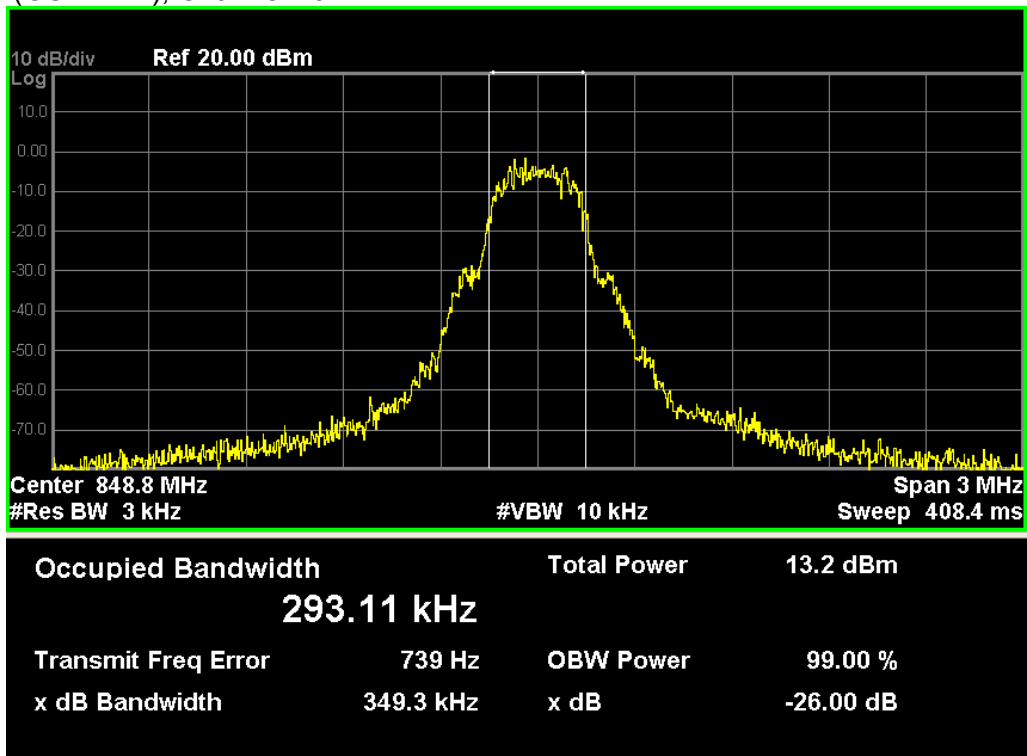

GSM850 (GPRS 8 Link)

Channel No.	Frequency (MHz)	-26dB Occupied Bandwidth (kHz)	99% Occupied Bandwidth (kHz)
128	824.20	400.7	296.3
189	836.40	391.8	287.7
251	848.80	345.8	291.2

GSM850 (GPRS 8 Link), Channel 128

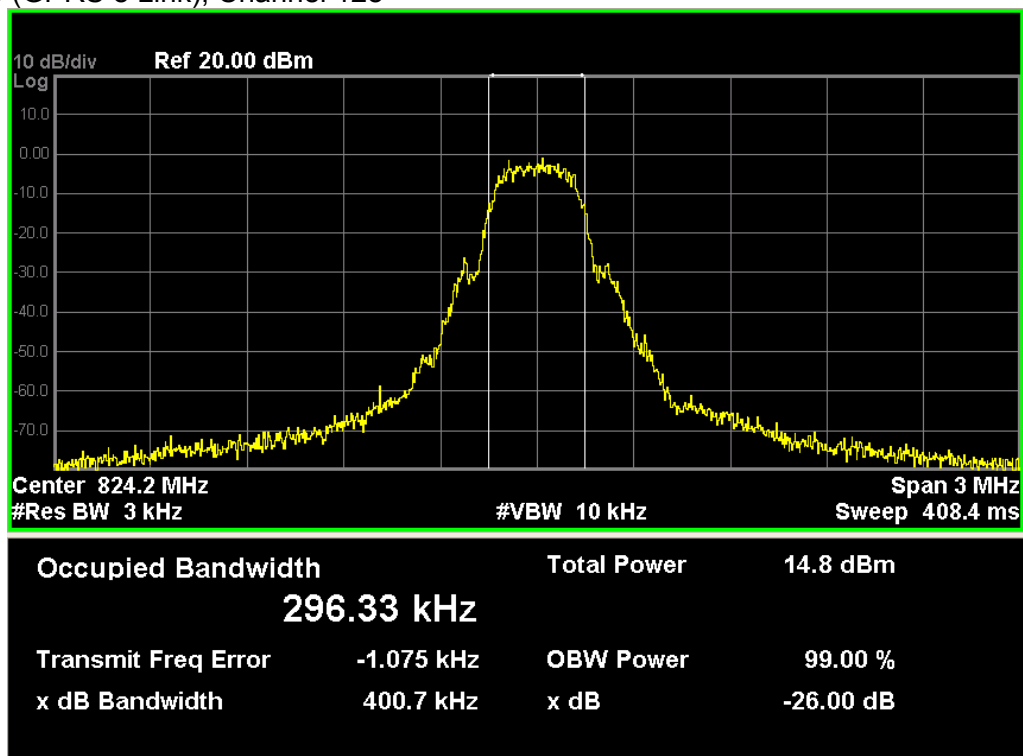

GSM850 (GPRS 8 Link), Channel 189

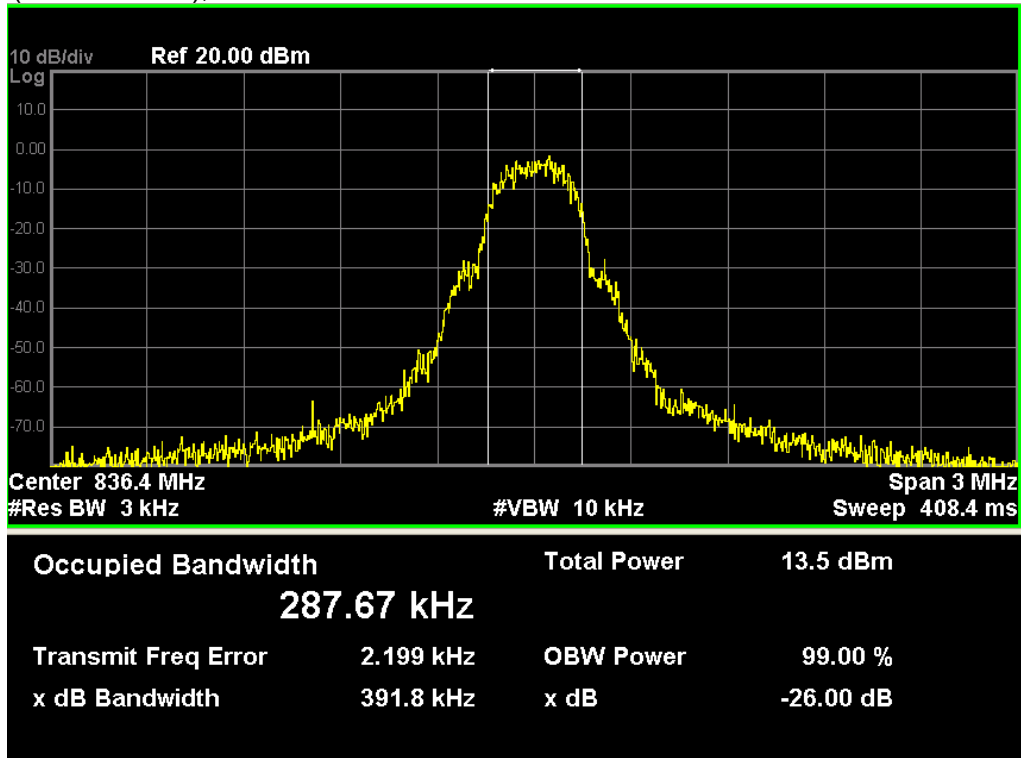

GSM850 (GPRS 8 Link), Channel 251

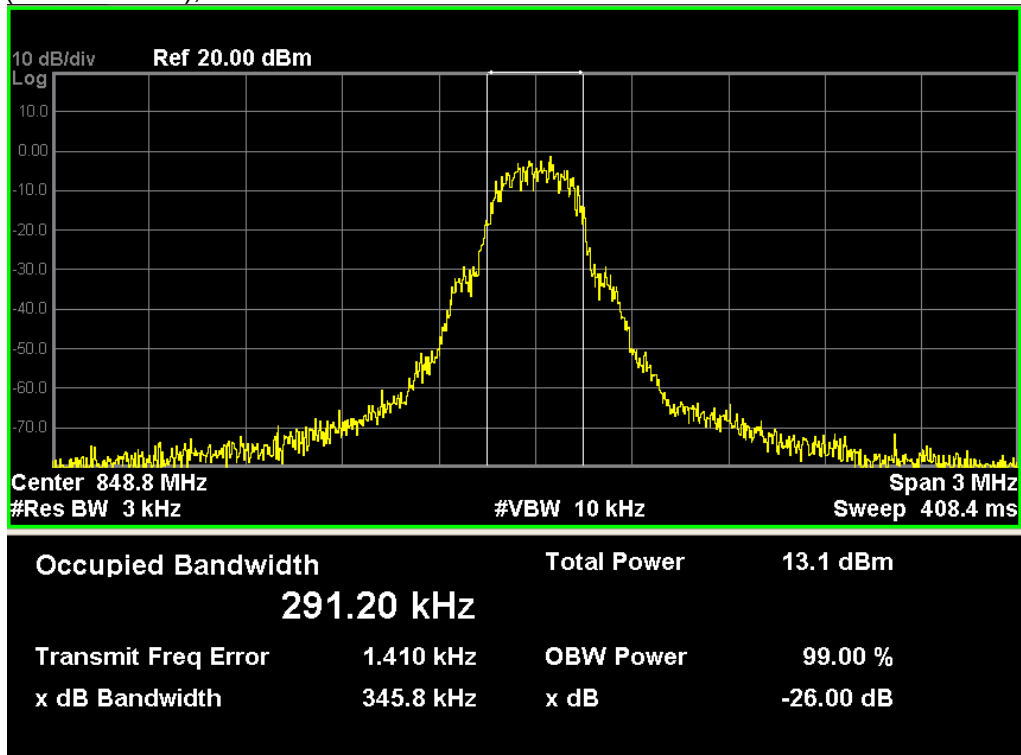

GSM 1900 (GSM Link)

Channel No.	Frequency (MHz)	-26dB Occupied Bandwidth (kHz)	99% Occupied Bandwidth (kHz)
512	1850.20	327.0	272.4
661	1880.00	343.2	273.8
810	1909.80	335.5	271.7

GSM1900 (GSM Link), Channel 512

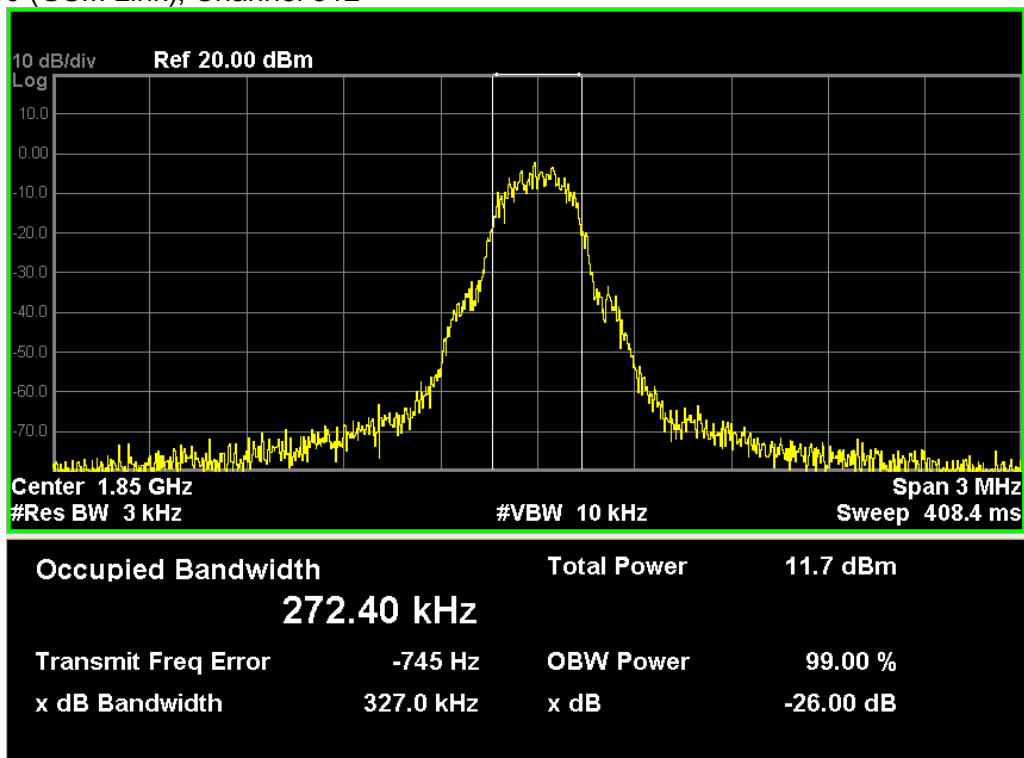

GSM1900 (GSM Link), Channel 661

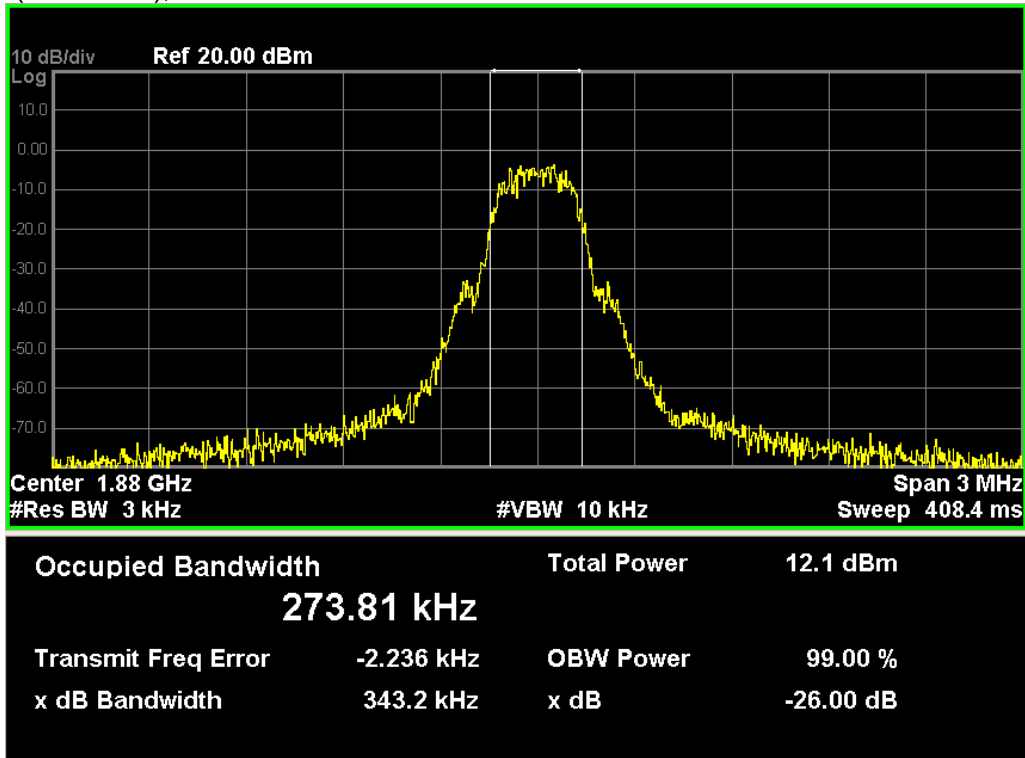

GSM1900 (GSM Link), Channel 810

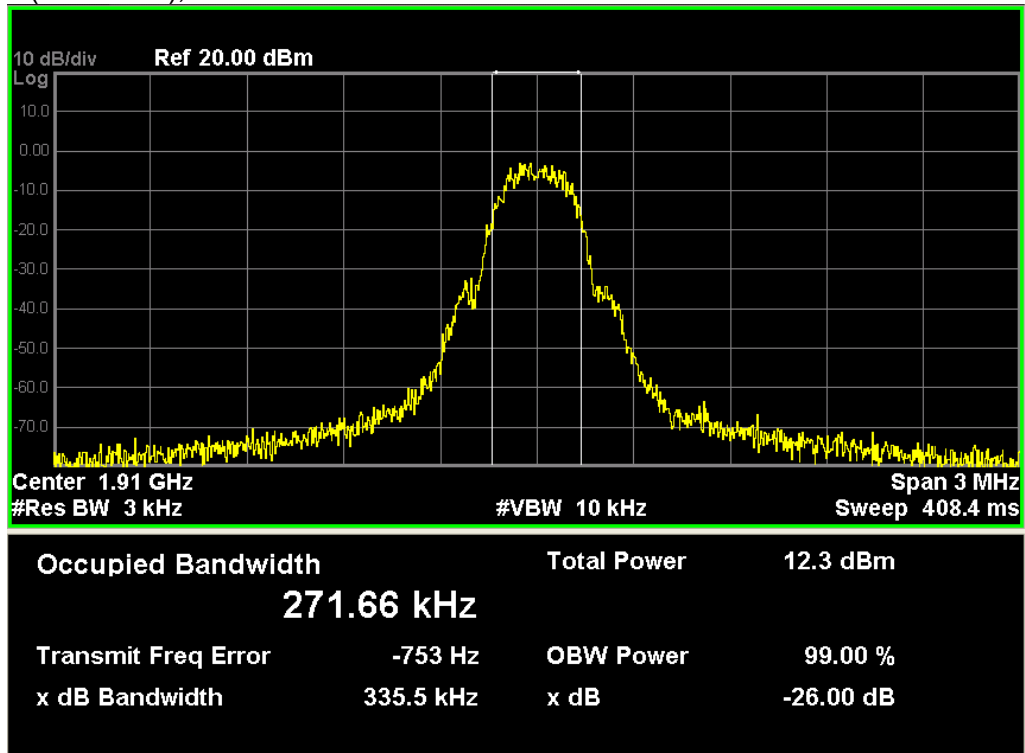

GSM1900 (GPRS 8 Link)

Channel No.	Frequency (MHz)	-26dB Occupied Bandwidth (kHz)	99% Occupied Bandwidth (kHz)
512	1850.20	342.2	278.7
661	1880.00	328.5	269.7
810	1909.80	331.6	273.8

GSM1900 (GPRS 8 Link), Channel 512

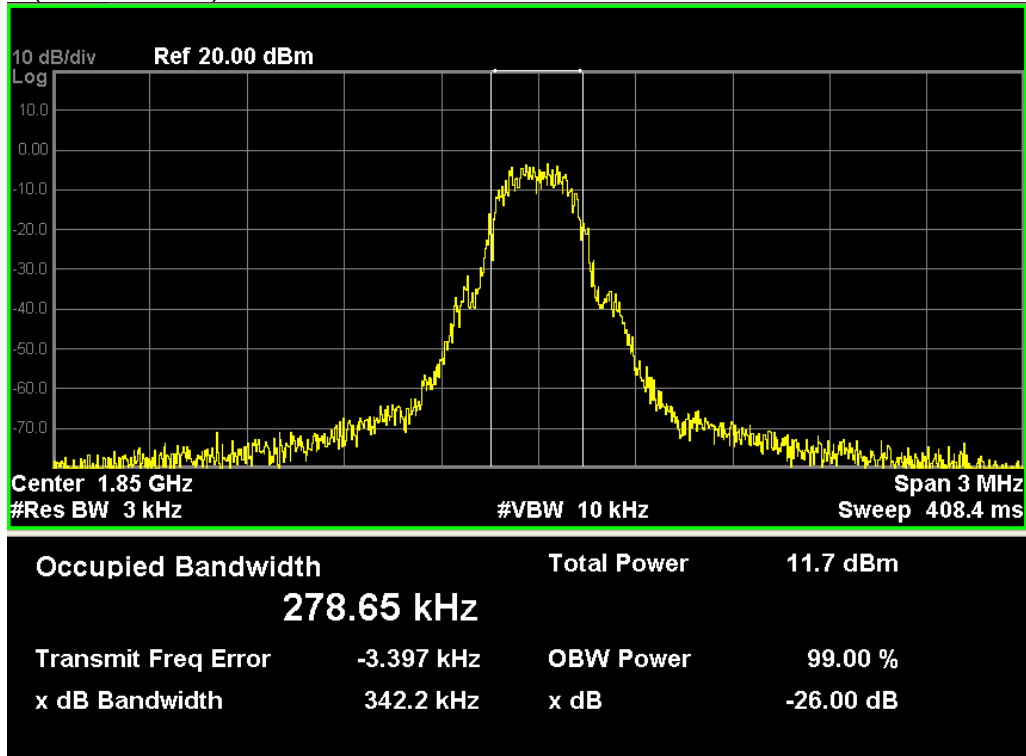

GSM1900 (GPRS 8 Link), Channel 661

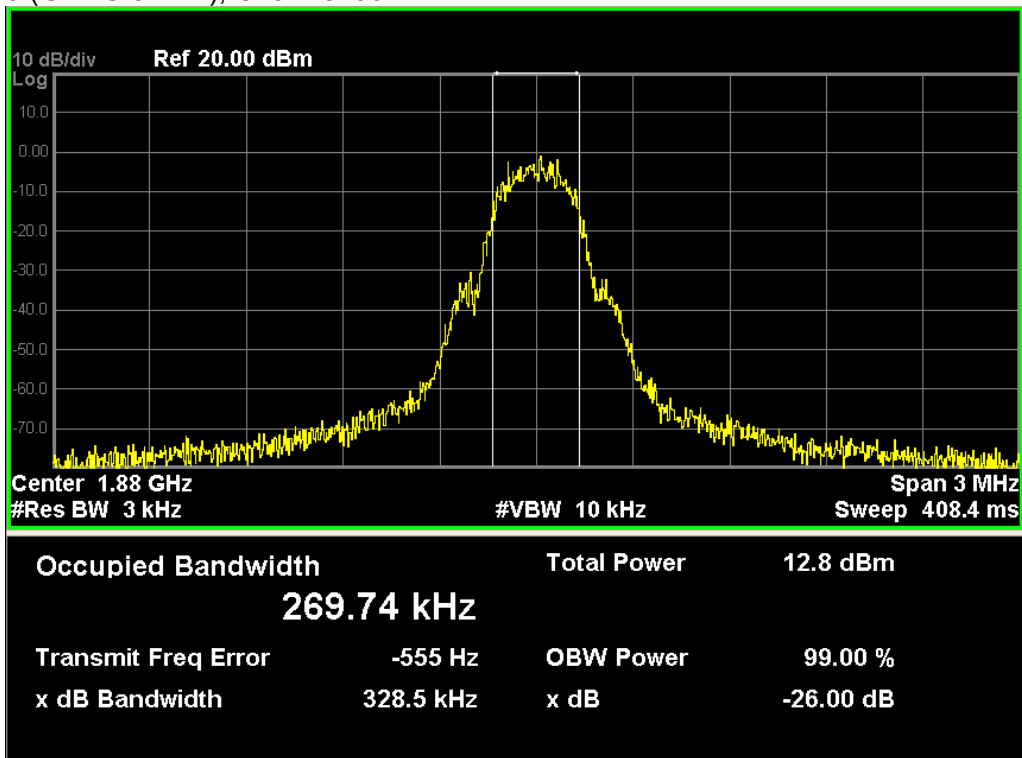

GSM1900 (GPRS 8 Link), Channel 810

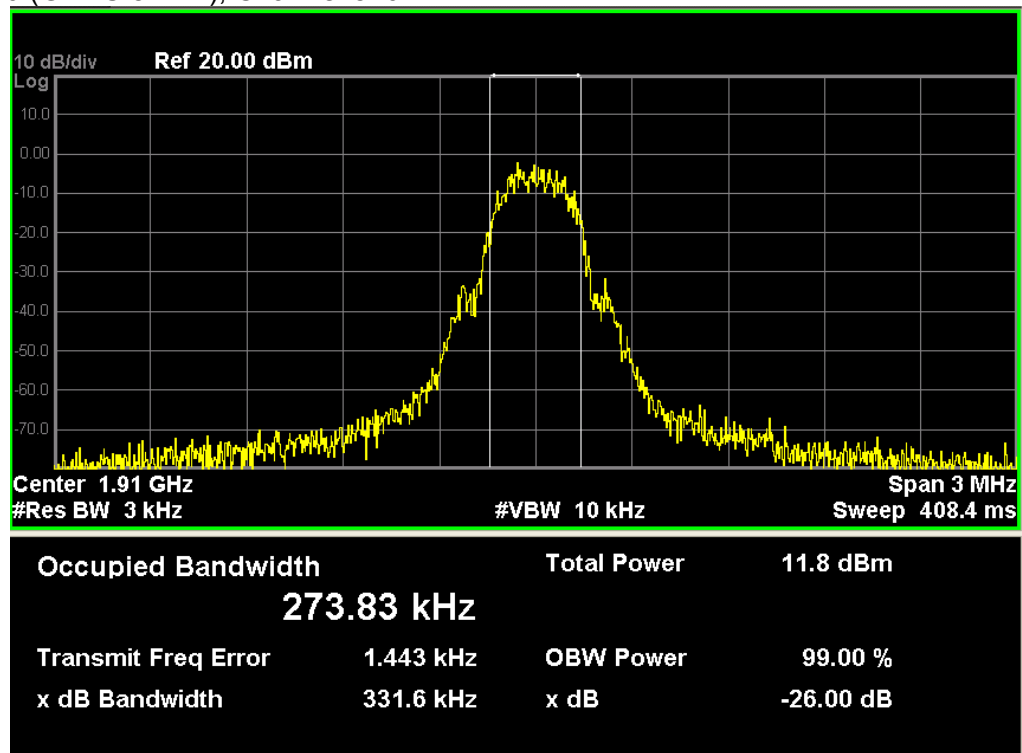

5. Spurious Emission At Antenna Terminals (+/- 1MHz)

5.1. Test Equipment

Instrument	Manufacturer	Model	Serial No	Cal. Date
Radio Communication Tester	Agilent	E5515C	GB46581718	2014.10.24
Spectrum Analyzer	Agilent	N9038A	MY51210142	2014.07.27
DC Power Supply	Agilent	6612C	MY43002989	2015.03.03

5.2. Test Setup

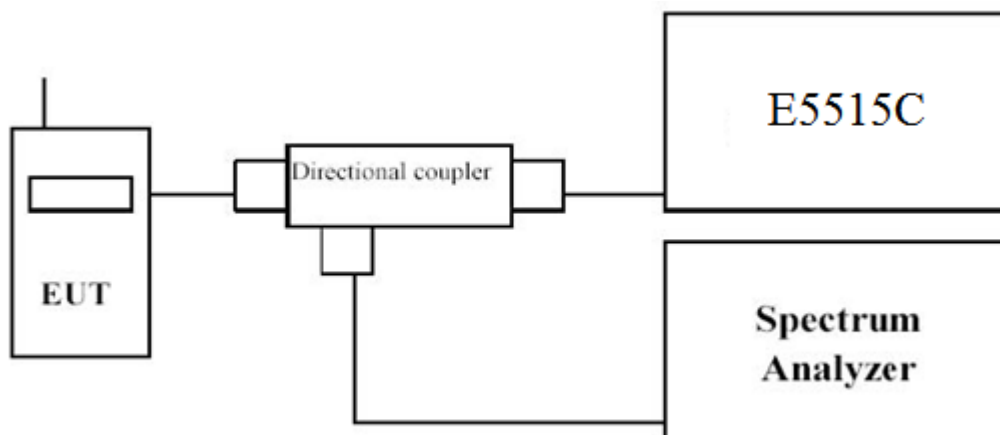

5.3. Limit

The power of any emission outside of the authorized operating frequency ranges must be attenuated below the transmitting power (P) by a factor of at least $43 + 10\log(P)$ dB.

5.4. Test Procedure

In the 1MHz bands immediately outside and adjacent to the frequency block a resolution bandwidth of at least one percent of the emission bandwidth of the fundamental emission of the transmitter may be employed to measure the out of band Emissions.

5.5. Uncertainty

The measurement uncertainty is defined as ± 1.2 dB.

5.6. Test Result

GSM850 (GSM Link), Channel 128

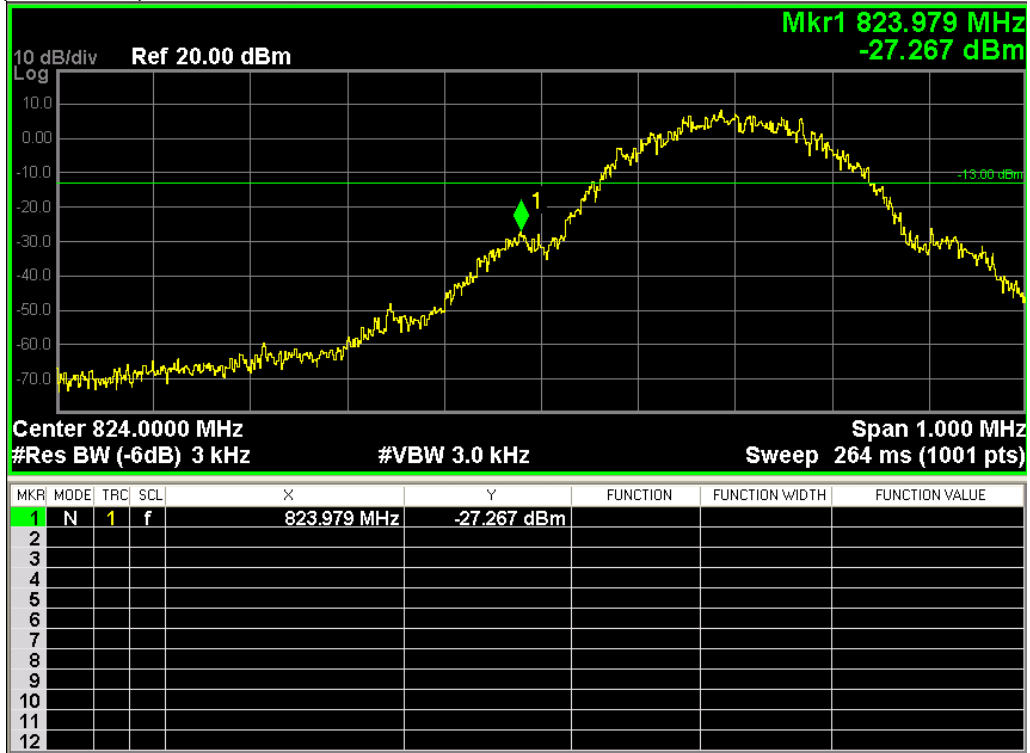

GSM850 (GSM Link), Channel 251

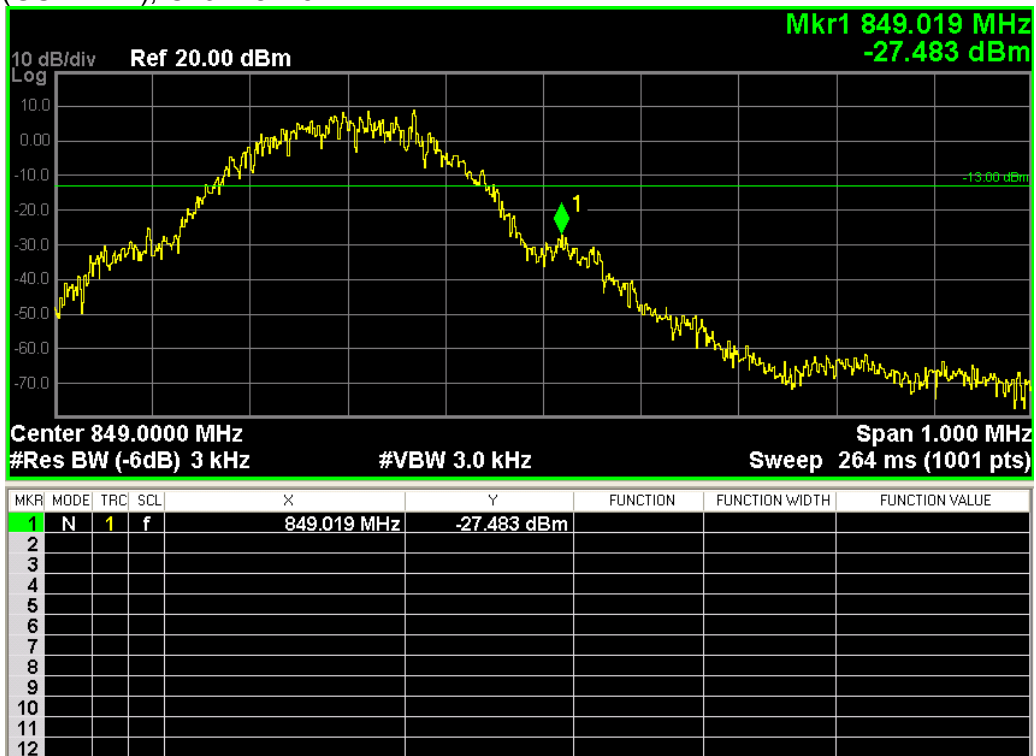

GSM850 (GPRS 8 Link), Channel 128

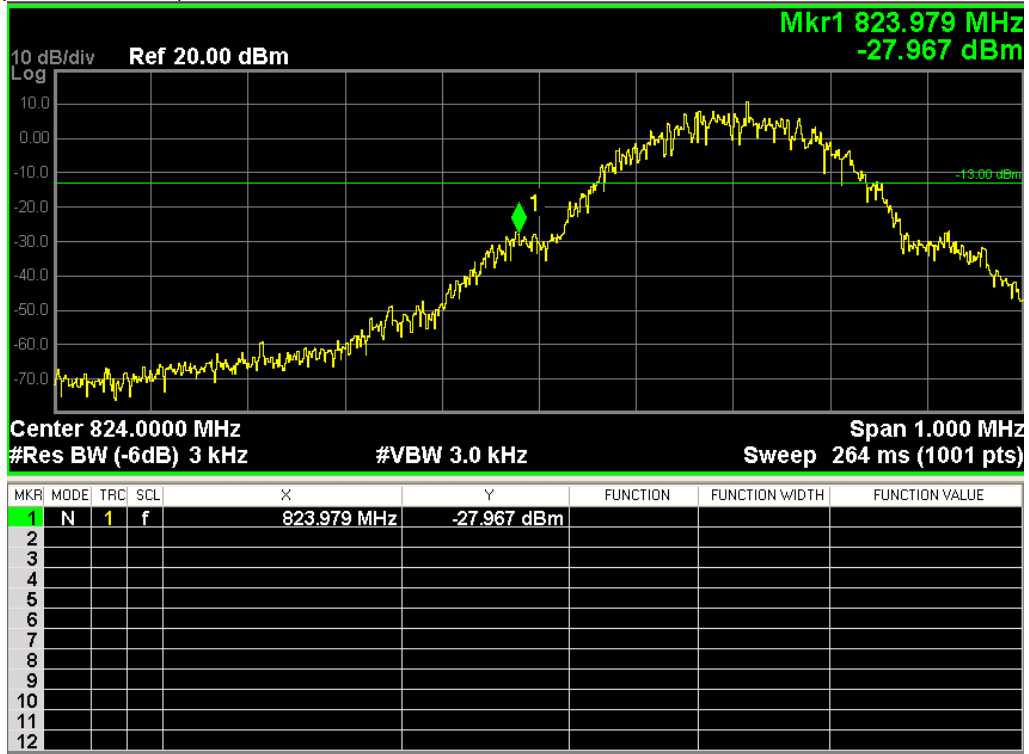

GSM850 (GPRS 8 Link), Channel 251

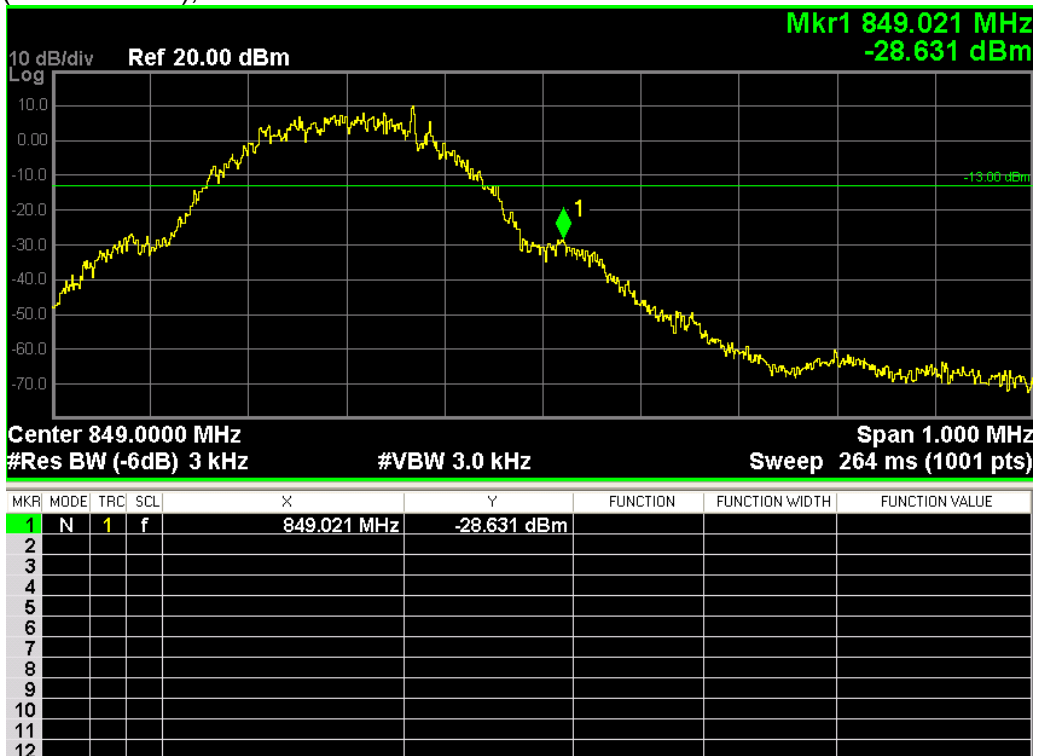

GSM 1900 (GSM Link), Channel 512

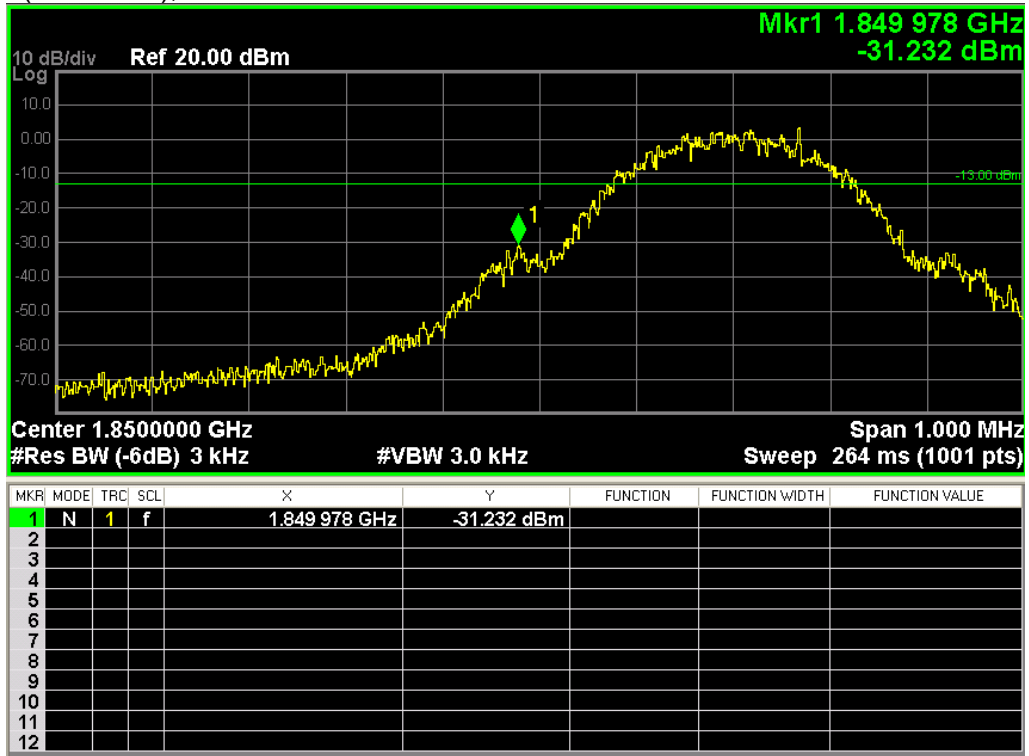

GSM 1900 (GSM Link), Channel 810

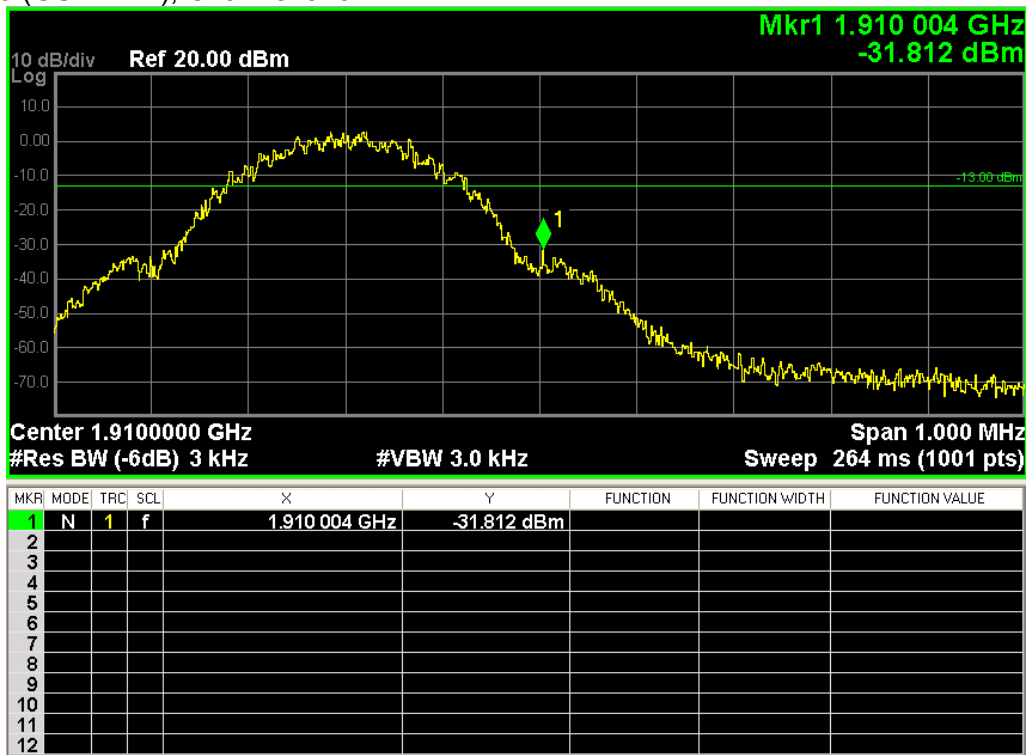

GSM1900 (GPRS 8 Link), Channel 512

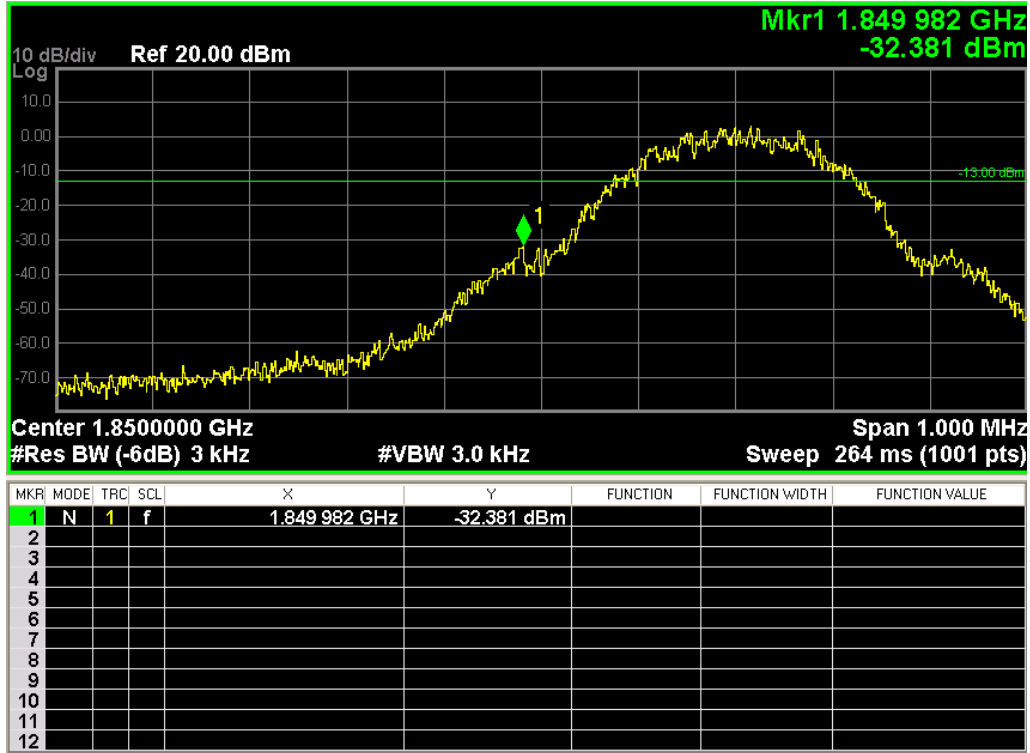

GSM1900 (GPRS 8 Link), Channel 810

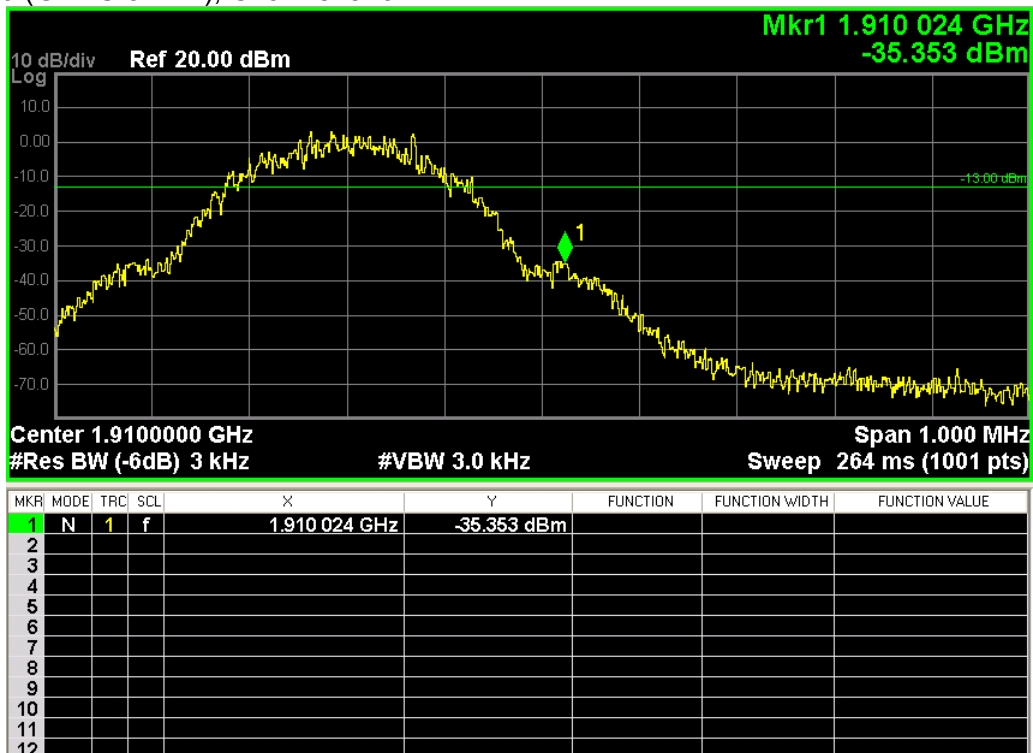

6. Spurious Emission

6.1. Test Equipment

Instrument	Manufacturer	Model	Serial No.	Cali. Due Date
Spectrum Analyzer	Agilent	N9038A	MY51210142	2014.07.27
Radio Communication Tester	Agilent	E5515C	GB46581718	2014.10.24
Signal Generator	Agilent	N5183A	MY50140938	2014.10.07
Preamplifier	CEM	EM30180	3008A0245	2015.02.28
DC Power Supply	Agilent	6612C	MY43002989	2015.03.03
Loop Antenna	Schwarzbeck	FMZB1519	1519-020	2014.03.27
Bilog Antenna	Schwarzbeck	VULB9160	9160-3316	2014.07.19
VHF-UHF-Biconical Antenna	Schwarzbeck	VUBA9117	9117-263	2014.07.19
Broad-Band Horn Antenna	Schwarzbeck	BBHA9120D	9120D-942	2014.07.19
Broad-Band Horn Antenna	Schwarzbeck	BBHA9120D	9120D-943	2014.07.19

6.2. Test Setup

Conducted Spurious Emission Measurement:

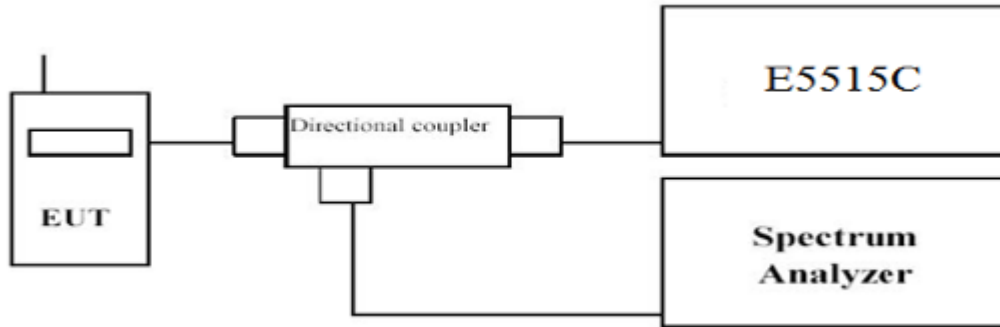

Radiated Spurious Measurement: below 30MHz

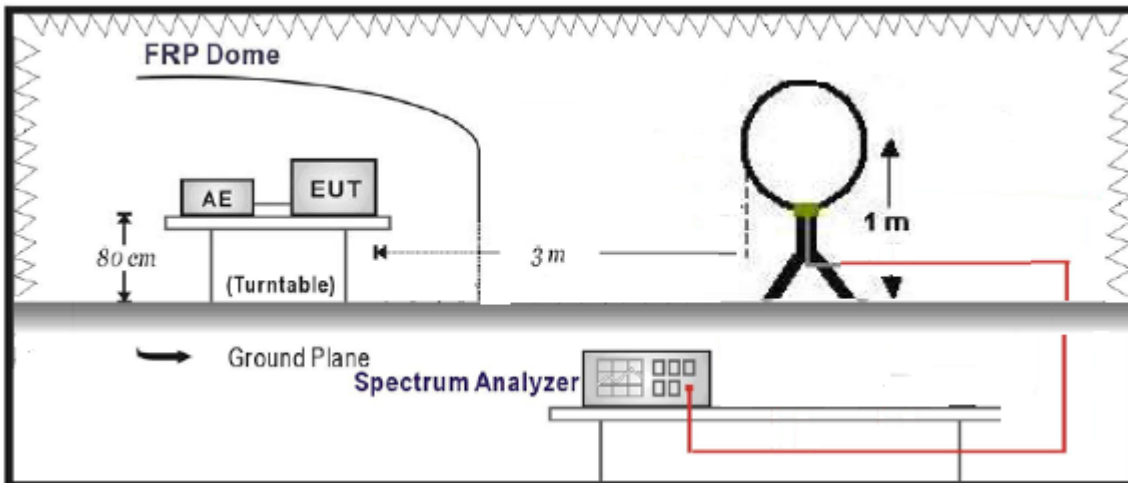

Radiated Spurious Measurement: 30MHz to 1GHz

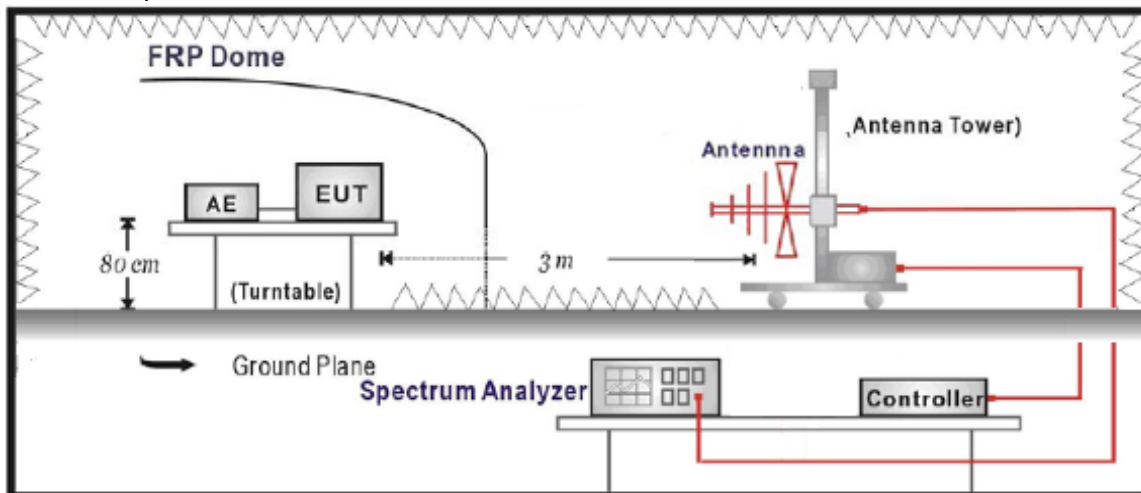

Radiated Spurious Measurement: above 1GHz

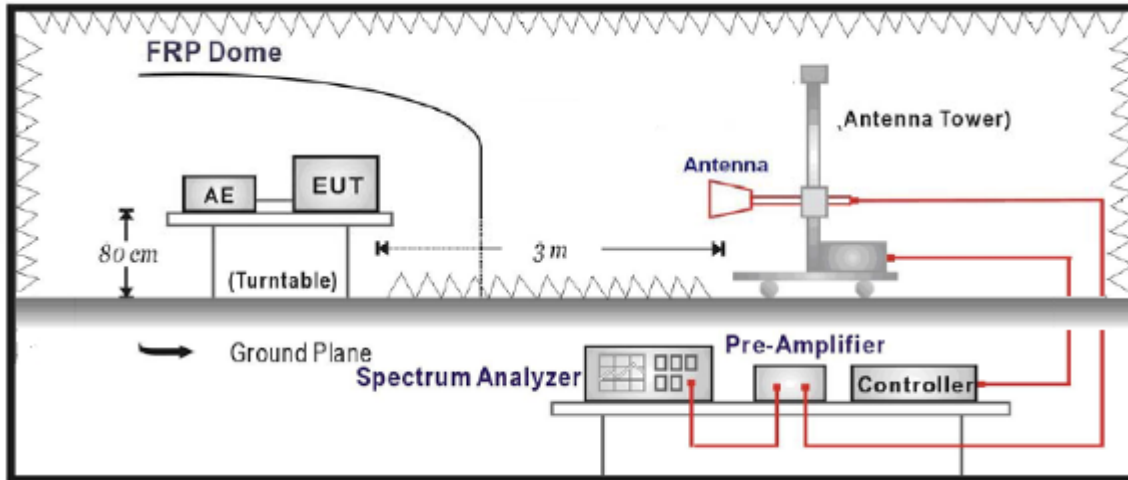

6.3. Limit

The power of any emission outside of the authorized operating frequency ranges must be attenuated below the transmitting power (P) by a factor of at least $43 + 10\log(P)$ dB.

6.4. Test Procedure

Conducted Spurious Measurement:

- Place the EUT on a bench and set it in transmitting mode.
- Connect a low loss RF cable from the antenna port to a spectrum analyzer and E5515C by a Directional Couple.
- EUT Communicate with E5515C, then select a channel for testing.
- Add a correction factor to the display of spectrum, and then test.
- The resolution bandwidth of the spectrum analyzer was set at 1 MHz, sufficient scans were taken to show the out of band Emission if any up to 10th harmonic.

Radiated Spurious Measurement:

- The EUT shall be placed at the specified height on a support, and in the position closest to normal use as declared by provider.
- The test antenna shall be oriented initially for vertical polarization and shall be chosen to correspond to the frequency of the transmitter
- The output of the test antenna shall be connected to the measuring receiver. The transmitter shall be switched on and the measuring receiver shall be tuned to the frequency of the transmitter under test.
- The test antenna shall be raised and lowered through the specified range of height until a maximum signal level is detected by the measuring receiver.
- The transmitter shall then be rotated through 360° in the horizontal plane, until the maximum

-
- signal level is detected by the measuring receiver.
- f. The test antenna shall be raised and lowered again through the specified range of height until a maximum signal level is detected by the measuring receiver.
 - h. The maximum signal level detected by the measuring receiver shall be noted.
 - i. The transmitter shall be replaced by a substitution antenna.
 - j. The substitution antenna shall be orientated for vertical polarization and the length of the substitution antenna shall be adjusted to correspond to the frequency of the transmitter.
 - k. The substitution antenna shall be connected to a calibrated signal generator.
 - l. If necessary, the input attenuator setting of the measuring receiver shall be adjusted in order to increase the sensitivity of the measuring receiver.
 - m. The test antenna shall be raised and lowered through the specified range of height to ensure that the maximum signal is received.
 - n. The input signal to the substitution antenna shall be adjusted to the level that produces a level detected by the measuring receiver, that is equal to the level noted while the transmitter radiated power was measured, corrected for the change of input attenuator setting of the measuring receiver.
 - o. The measurement shall be repeated with the test antenna and the substitution antenna orientated for horizontal polarization.
 - p. The measure of the effective radiated power is the larger of the two levels recorded at the input to the substitution antenna, corrected for gain of the substitution antenna if necessary.
 - q. The frequency range was checked up to 10th harmonic.
 - r. Test site anechoic chamber refer to ANSI C63.4: 2009

6.5. Uncertainty

The measurement uncertainty is defined as 3.2 dB for Radiated Power Measurement.

6.6. Test Result

Conducted Spurious Measurement:

GSM850 (GSM Link), Channel 189

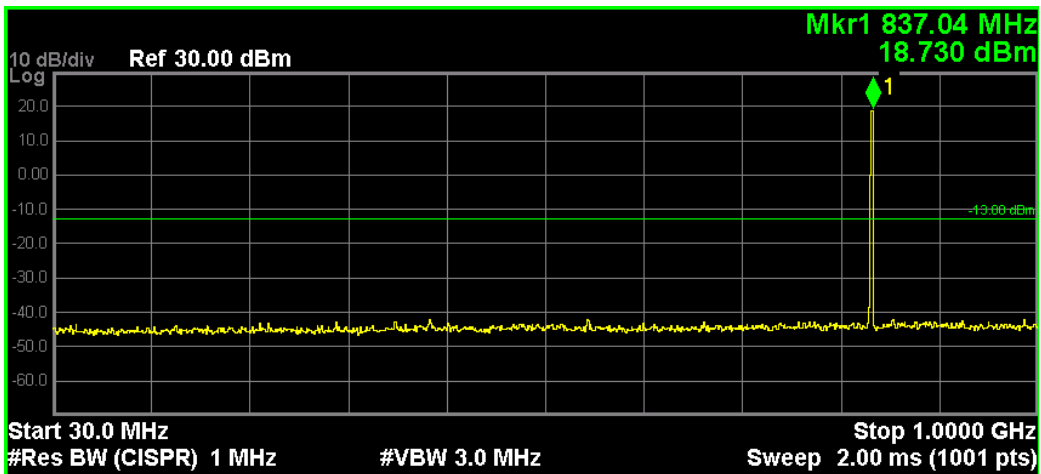
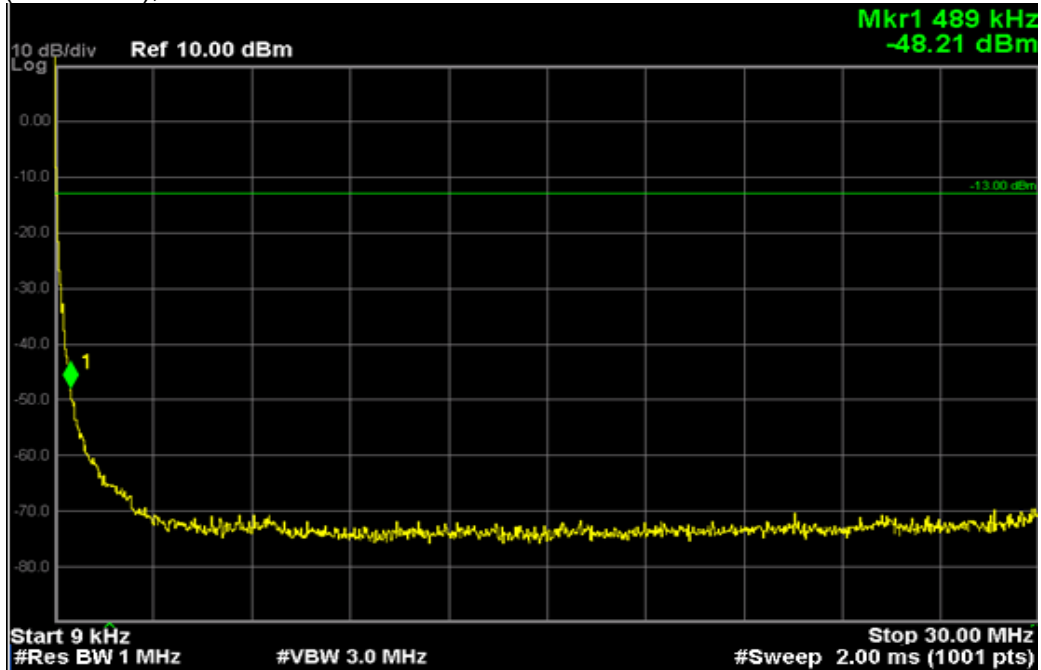

MKR	MODE	TRC	SCL	X	Y	FUNCTION	FUNCTION WIDTH	FUNCTION VALUE
1	N	1	f	837.04 MHz	18.730 dBm			
2								
3								
4								
5								
6								
7								
8								
9								
10								
11								
12								

Note: The signal at point 1 is carrier

GSM850 (GPRS 8 Link), Channel 189

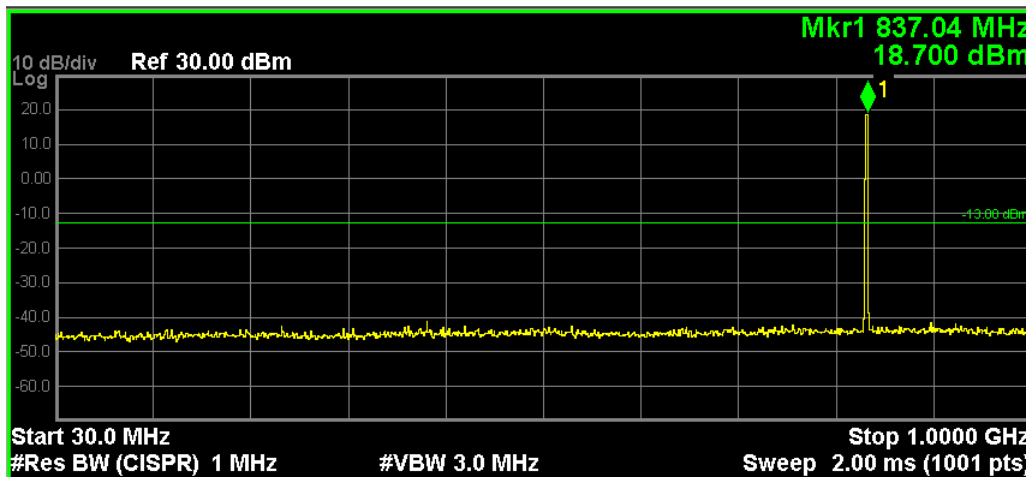
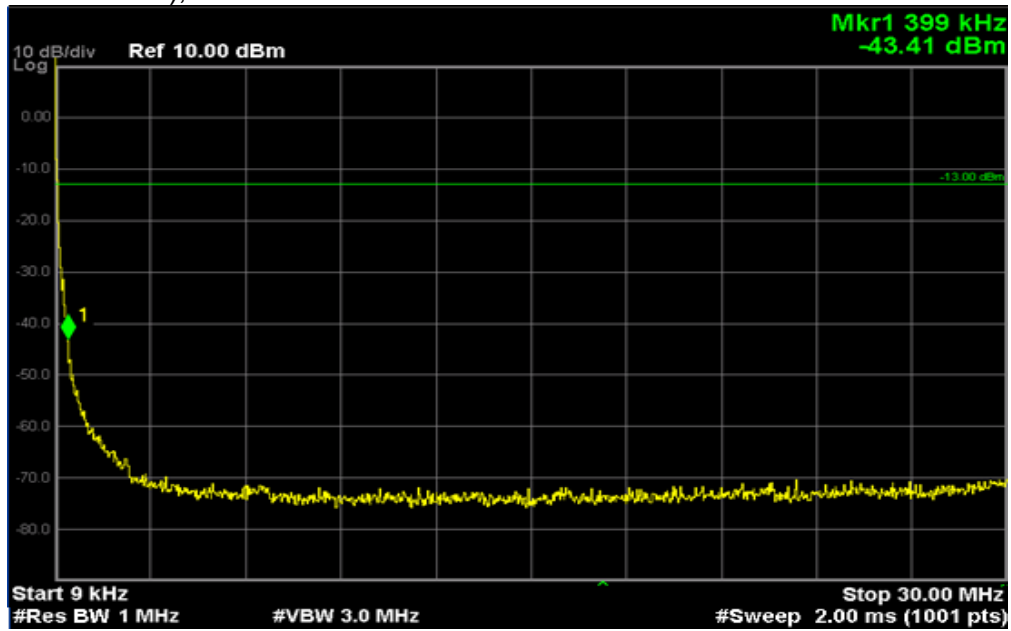

MKR	MODE	TRC	SCL	X	Y	FUNCTION	FUNCTION WIDTH	FUNCTION VALUE
1	N	1	f	837.04 MHz	18.700 dBm			
2								
3								
4								
5								
6								
7								
8								
9								
10								
11								
12								

Note: The signal at point 1 is carrier

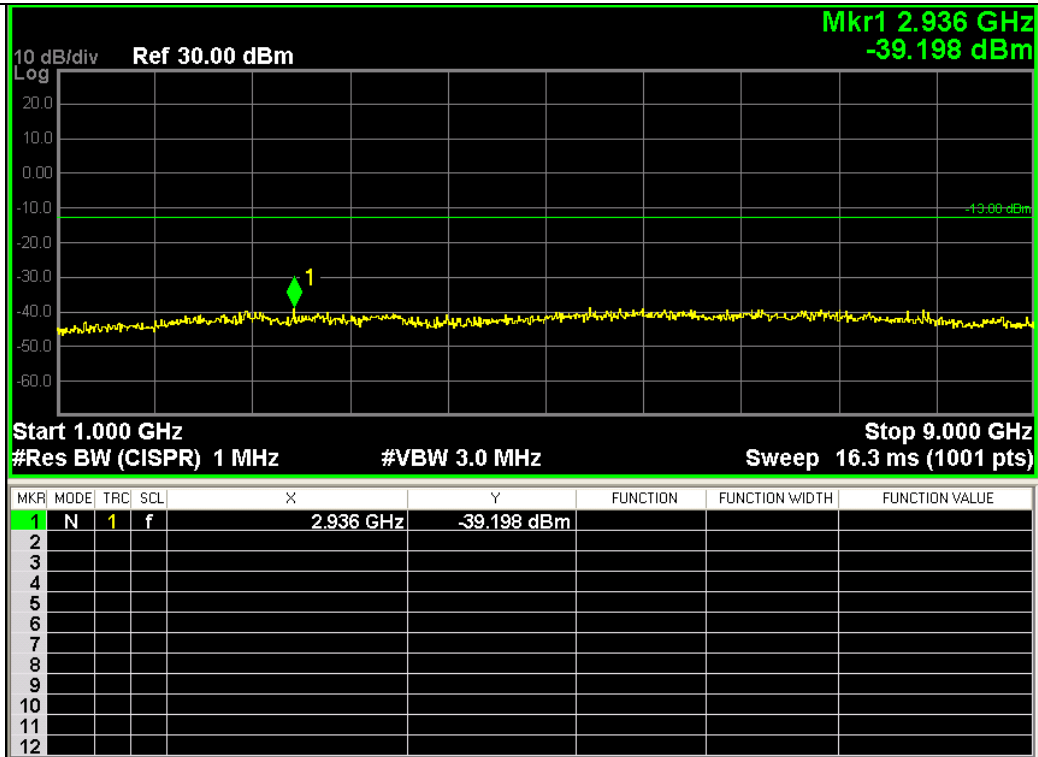

GSM 1900 (GSM Link), Channel 661

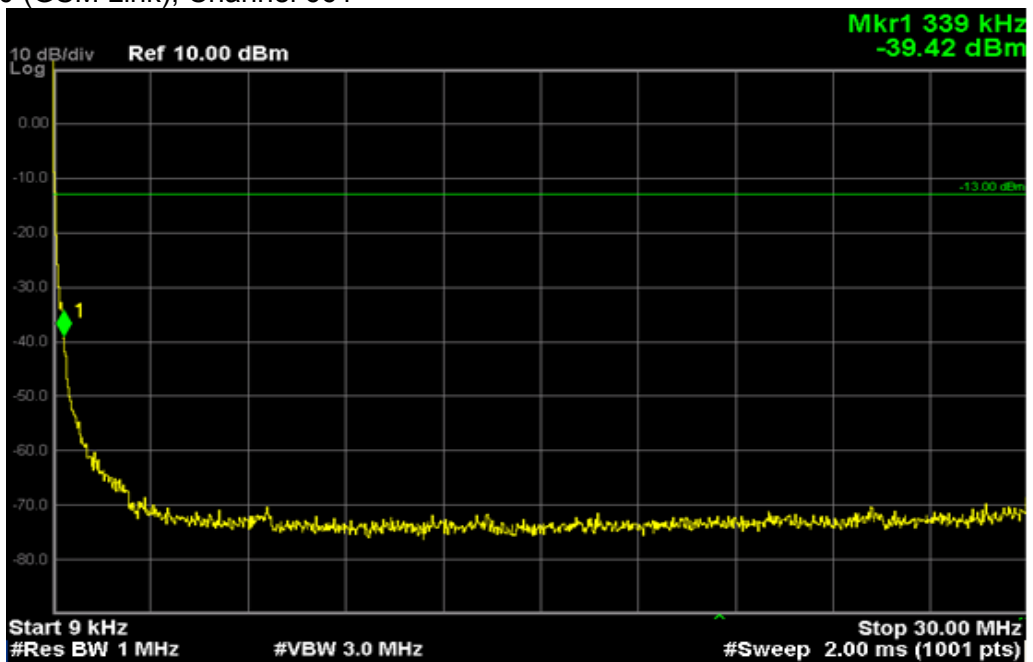

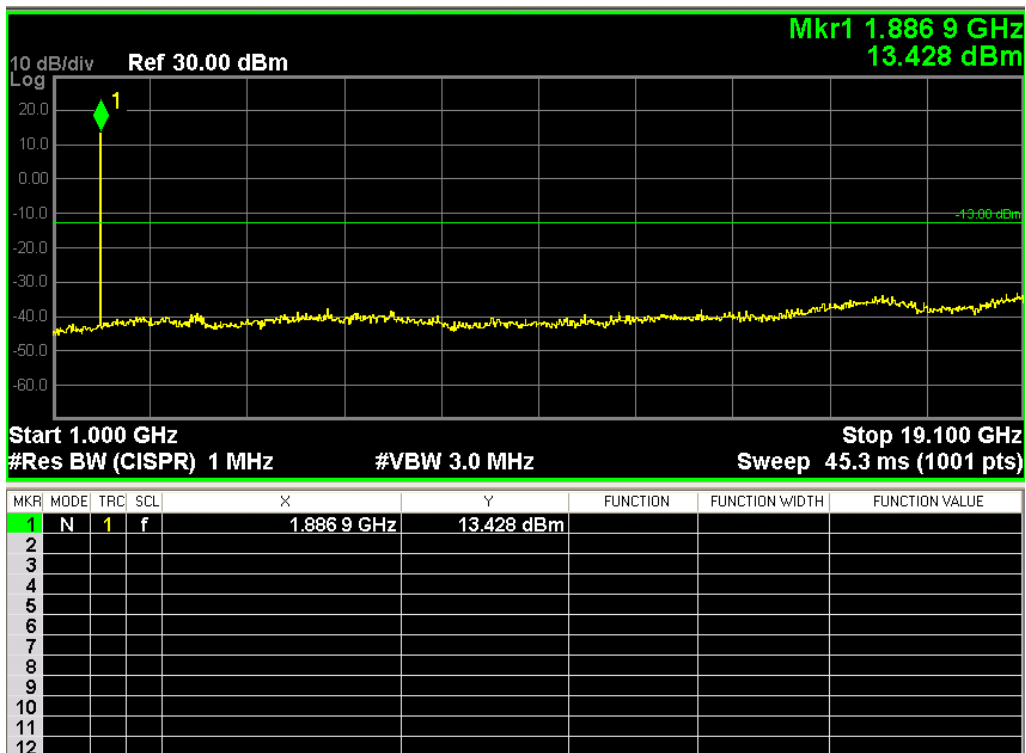
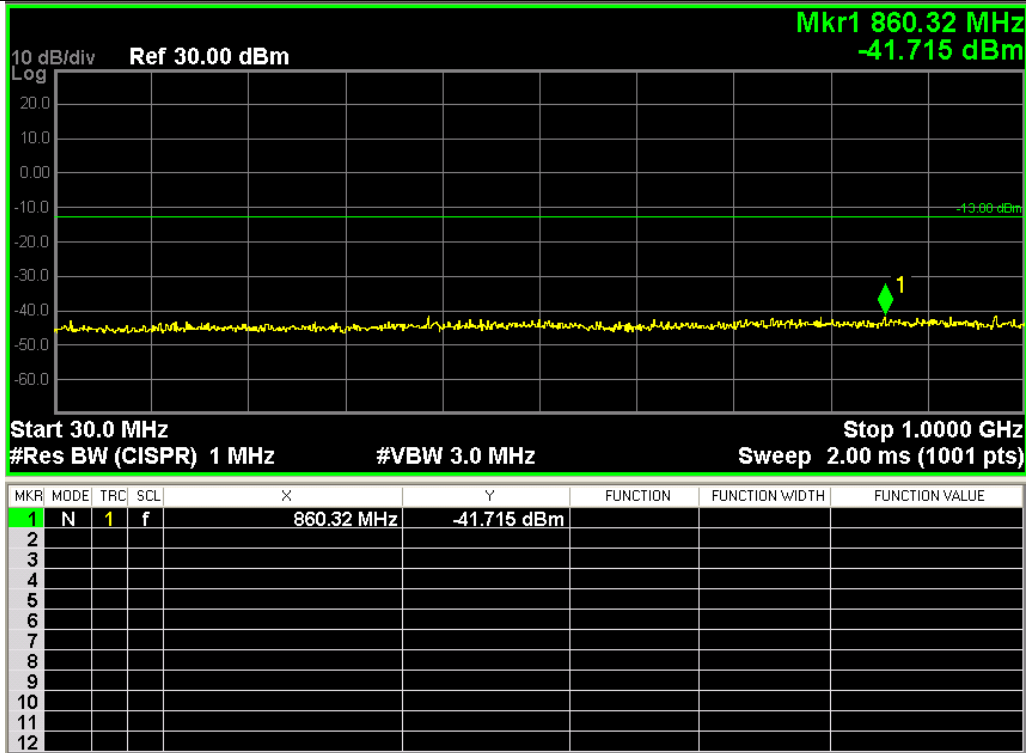

Note: The signal at point 1 is carrier

GSM 1900 (GPRS 8 Link), Channel 661:

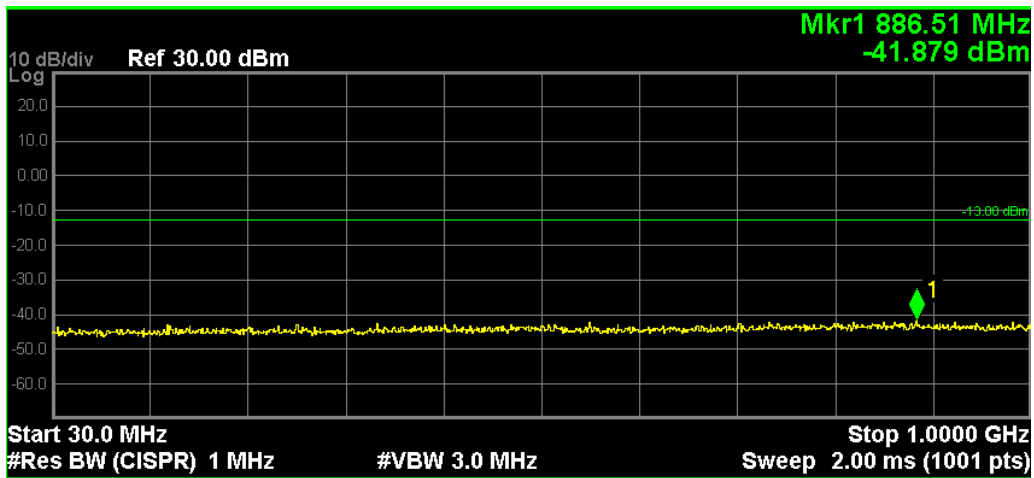
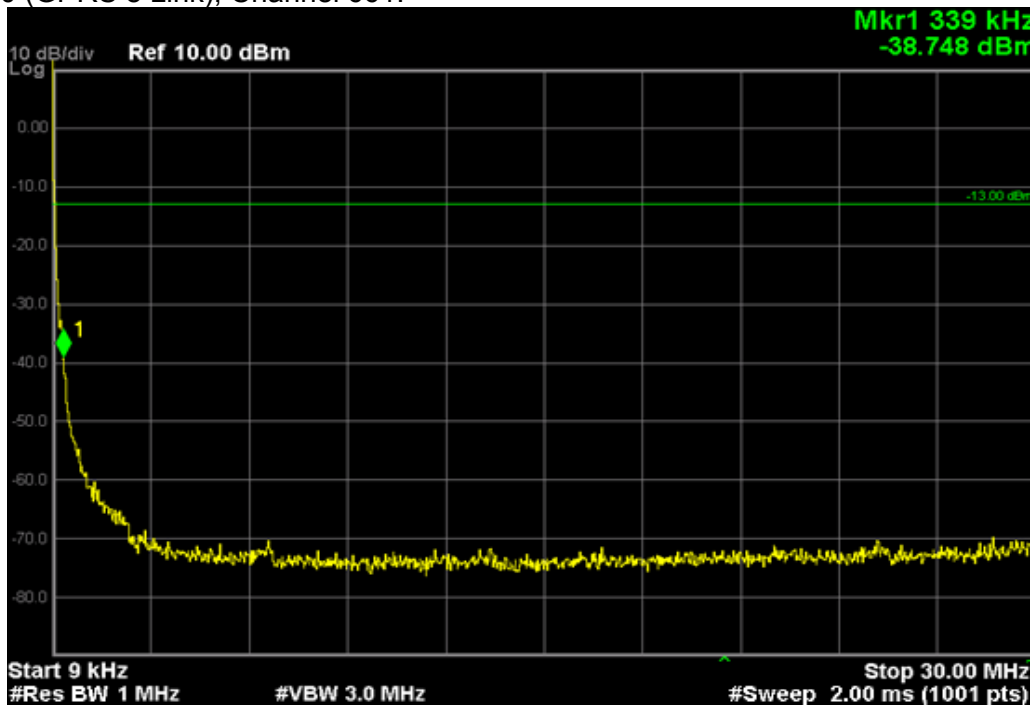

MKR	MODE	TRC	SCL	X	Y	FUNCTION	FUNCTION WIDTH	FUNCTION VALUE
1	N	1	f	886.51 MHz	-41.879 dBm			
2								
3								
4								
5								
6								
7								
8								
9								
10								
11								
12								

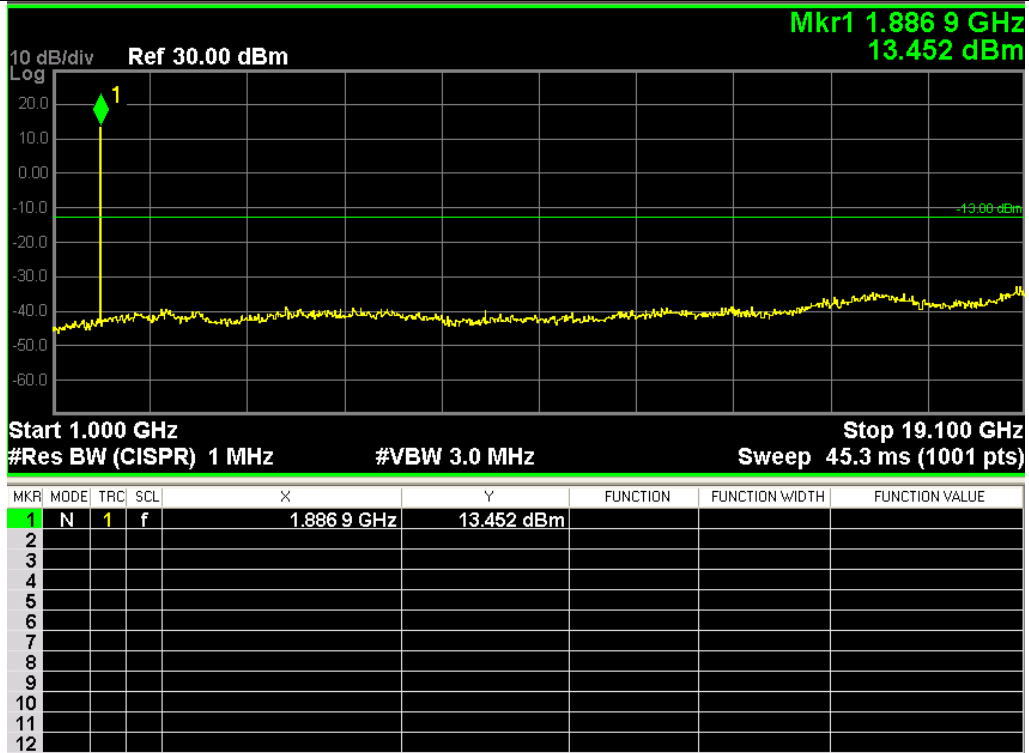

Note: The signal at point 1 is carrier

Radiated Spurious Measurement:

9KHz to 30MHz

The low frequency, which started from 9KHz to 30MHz, was pre-scanned and the result which was 20dB lower than the limit line, and that was not reported per 2.1057 (c).

Above 30MHz

GSM850 (GSM Link), 30MHz to 1GHz

Frequency (MHz)	Ant. Pol. (H/V)	SG Reading (dBm)	Cable Loss (dB)	Gain (dBd)	ERP (dBm)	Limit (dBm)	Margin (dB)
Middle Channel 189 (836.40MHz)							
125.2	H	-60.25	1.24	-2.20	-63.69	-13.00	-50.69
838.5	H	-72.56	4.27	3.86	-72.97	-13.00	-59.97
125.2	V	-59.53	1.24	-2.20	-62.97	-13.00	-49.97
838.5	V	-73.47	4.27	3.86	-73.88	-13.00	-60.88

GSM850 (GSM Link), Above 1GHz

Frequency (MHz)	Ant. Pol. (H/V)	SG Reading (dBm)	Cable Loss (dB)	Gain (dBd)	ERP (dBm)	Limit (dBm)	Margin (dB)
Middle Channel 189 (836.40MHz)							
1623.1	H	-51.23	5.93	7.10	-50.06	-13.00	-37.06
3240.4	H	-49.15	7.82	10.13	-46.84	-13.00	-33.84
1623.1	V	-49.64	5.93	7.10	-48.47	-13.00	-35.47
3240.4	V	-49.50	7.82	10.13	-47.19	-13.00	-34.19

GSM850 (GPRS 8 Link), 30MHz to 1GHz

Frequency (MHz)	Ant. Pol. (H/V)	SG Reading (dBm)	Cable Loss (dB)	Gain (dBd)	ERP (dBm)	Limit (dBm)	Margin (dB)
Middle Channel 189 (836.40MHz)							
45.3	H	-64.12	0.73	-3.03	-67.88	-13.00	-54.88
962.5	H	-67.20	4.50	3.94	-67.76	-13.00	-54.76
45.3	V	-63.62	0.73	-3.03	-67.38	-13.00	-54.38
962.5	V	-69.17	4.50	3.94	-69.73	-13.00	-56.73

GSM850 (GPRS 8 Link), Above 1GHz

Frequency (MHz)	Ant. Pol. (H/V)	SG Reading (dBm)	Cable Loss (dB)	Gain (dBd)	ERP (dBm)	Limit (dBm)	Margin (dB)
Middle Channel 189 (836.40MHz)							
1626.30	H	-51.54	5.93	7.11	-50.36	-13.00	-37.36
3250.32	H	-49.35	7.84	10.15	-47.04	-13.00	-34.04
1626.30	V	-49.42	5.93	7.11	-48.24	-13.00	-35.24
3250.32	V	-48.74	7.84	10.15	-46.43	-13.00	-33.43

GSM 1900 (GSM Link), 30MHz to 1GHz

Frequency (MHz)	Ant. Pol. (H/V)	SG Reading (dBm)	Cable Loss (dB)	Gain (dBi)	EIRP (dBm)	Limit (dBm)	Margin (dB)
Middle Channel 661 (1880.00MHz)							
41.52	H	-66.50	0.72	-3.57	-70.79	-13.00	-57.79
41.52	V	-60.31	0.72	-3.57	-64.60	-13.00	-51.60

GSM 1900 (GSM Link), Above 1GHz

Frequency (MHz)	Ant. Pol. (H/V)	SG Reading (dBm)	Cable Loss (dB)	Gain (dBi)	EIRP (dBm)	Limit (dBm)	Margin (dB)
Middle Channel 661 (1880.00MHz)							
1315.24	H	-51.25	5.28	4.71	-51.82	-13.00	-38.82
2134.12	H	-48.32	7.17	9.10	-46.39	-13.00	-33.39
1315.24	V	-49.10	5.28	4.70	-49.90	-13.00	-36.90
2134.12	V	-47.21	7.17	9.14	-45.24	-13.00	-32.24

GSM1900 (GPRS 8 Link), 30MHz to 1GHz

Frequency (MHz)	Ant. Pol. (H/V)	SG Reading (dBm)	Cable Loss (dB)	Gain (dBi)	EIRP (dBm)	Limit (dBm)	Margin (dB)
Middle Channel 661 (1880.00MHz)							
86.30	H	-66.34	1.25	-2.21	-69.80	-13.00	-56.80
86.30	V	-68.16	1.25	-2.21	-71.62	-13.00	-58.62

GSM1900 (GPRS 8 Link), Above 1GHz

Frequency (MHz)	Ant. Pol. (H/V)	SG Reading (dBm)	Cable Loss (dB)	Gain (dBi)	EIRP (dBm)	Limit (dBm)	Margin (dB)
Middle Channel 661 (1880.00MHz)							
1320.42	H	-51.12	5.20	4.74	-51.58	-13.00	-38.58
2138.30	H	-47.72	7.12	9.05	-45.79	-13.00	-32.79
1320.42	V	-49.30	5.28	4.74	-49.84	-13.00	-36.84
2138.30	V	-47.45	7.12	9.05	-45.52	-13.00	-32.52

7. Frequency Stability Under Temperature & Voltage Variations

7.1. Test Equipment

Instrument	Manufacturer	Model	Serial No.	Cali. Due Date
Spectrum Analyzer	Agilent	N9038A	MY51210142	2014.07.27
Radio Communication Tester	Agilent	E5515C	GB46581718	2014.10.24
DC Power Supply	Agilent	6612C	MY43002989	2015.03.03
DC Power Supply	ITECH	IT5612	01600210661201014	2014.11.15
Temperature Chamber	WEISS	DU/20/40	58226017340050	2014.12.03

7.2. Test Setup

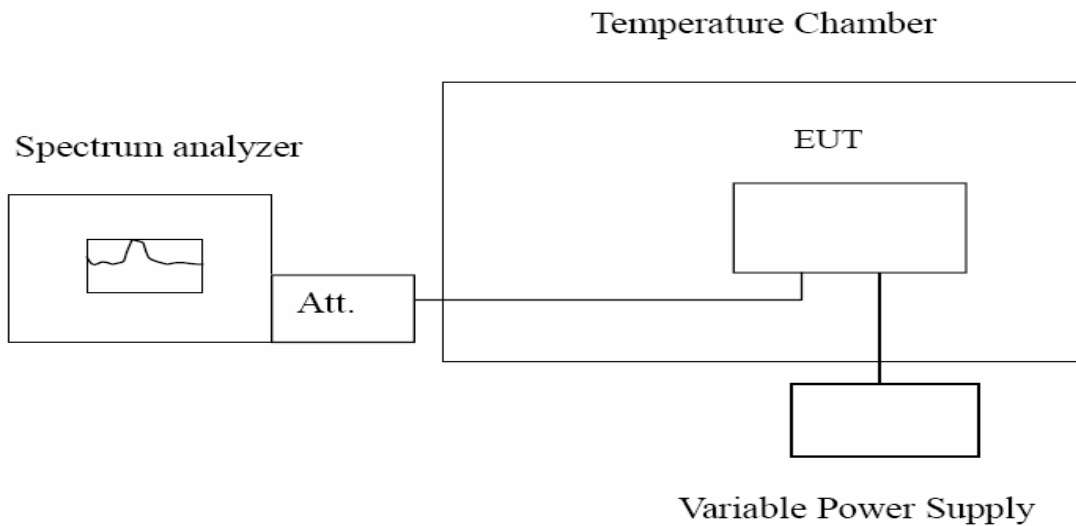

7.3. Limit

The frequency stability shall be sufficient to ensure that the fundamental emission stays within the authorized frequency block.

Limit	< 2.5 ppm
-------	-----------

7.4. Test Procedure

Frequency Stability Under Temperature Variations:

The equipment under test was connected to an external AC or DC power supply and input rated voltage. RF output was connected to a frequency counter or spectrum analyzer via feed through attenuators. The EUT was placed inside the temperature chamber. Set the spectrum analyzer RBW low enough to obtain the desired frequency resolution and measure

EUT 20°C operating frequency as reference frequency. Turn EUT off and set the chamber temperature to -30°C. After the temperature stabilized for approximately 30 minutes recorded the frequency. Repeat step measure with 10°C increased per stage until the highest temperature of +50°C reached.

Frequency Stability Under Voltage Variations:

Set chamber temperature to 20°C. Use a variable AC power supply / DC power source to power the EUT and set the voltage to rated voltage. Set the spectrum analyzer RBW low enough to obtain the desired frequency resolution and recorded the frequency.

Reduce the input voltage to specify extreme voltage variation ($\pm 15\%$) and endpoint, record the maximum frequency change.

7.5. Uncertainty

The measurement uncertainty is defined as ± 10 Hz.

7.6. Test Result

GSM850 (GSM Link):

Frequency Stability under Temperature

Temperature Interval (°C)	Test Frequency (MHz)	Deviation (Hz)	Limit(Hz)	Result
-20	836.40	-21.12	±2091	PASS
-10	836.40	-24.64	±2091	
0	836.40	-16.35	±2091	
10	836.40	-16.35	±2091	
20	836.40	-17.50	±2091	
30	836.40	-27.22	±2091	
40	836.40	-24.16	±2091	
50	836.40	-30.15	±2091	

Frequency Stability under Voltage

DC Voltage (V)	Test Frequency (MHz)	Deviation (Hz)	Limit(Hz)	Result
3.3	836.40	-18.56	±2091	PASS
3.7	836.40	-30.78	±2091	
4.3	836.40	-23.60	±2091	

Notes: the manufacture declared that the EUT could work between voltages 3.3V~4.5V, and this EUT could normally work under the condition from -20°C to 55°C, otherwise this EUT will shut down and not transmit.

GSM850 (GPRS 8 Link):

Frequency Stability under Temperature

Temperature Interval (°C)	Test Frequency (MHz)	Deviation (Hz)	Limit(Hz)	Result
-20	836.40	-18.20	±2091	PASS
-10	836.40	-14.16	±2091	
0	836.40	-20.25	±2091	
10	836.40	-31.22	±2091	
20	836.40	-27.26	±2091	
30	836.40	-24.55	±2091	
40	836.40	-27.55	±2091	
50	836.40	-31.21	±2091	

Frequency Stability under Voltage

DC Voltage (V)	Test Frequency (MHz)	Deviation (Hz)	Limit(Hz)	Result
3.3	836.40	-17.55	±2091	PASS
3.7	836.40	-15.30	±2091	
4.3	836.40	-20.22	±2091	

Notes: the manufacture declared that the EUT could work between voltages 3.3V~4.5V, and this EUT could normally work under the condition from -20°C to 55°C, otherwise this EUT will shut down and not transmit.

GSM 1900 (GSM Link):

Frequency Stability under Temperature

Temperature Interval (°C)	Test Frequency (MHz)	Deviation (Hz)	Limit(Hz)	Result
-20	1880.00	-25.62	±4700	PASS
-10	1880.00	-20.16	±4700	
0	1880.00	-17.56	±4700	
10	1880.00	-30.25	±4700	
20	1880.00	-35.32	±4700	
30	1880.00	-19.63	±4700	
40	1880.00	-24.59	±4700	
50	1880.00	-32.59	±4700	

Frequency Stability under Voltage

DC Voltage (V)	Test Frequency (MHz)	Deviation (Hz)	Limit(Hz)	Result
3.3	1880.00	-23.55	±4700	PASS
3.7	1880.00	-22.15	±4700	
4.3	1880.00	-30.22	±4700	

Notes: the manufacture declared that the EUT could work between voltages 3.3V~4.5V, and this EUT could normally work under the condition from -20°C to 55°C, otherwise this EUT will shut down and not transmit.

GSM1900 (GPRS 8 Link):

Frequency Stability under Temperature

Temperature Interval (°C)	Test Frequency (MHz)	Deviation (Hz)	Limit(Hz)	Result
-20	1880.00	-20.04	±4700	PASS
-10	1880.00	-17.20	±4700	
0	1880.00	-28.53	±4700	
10	1880.00	-30.20	±4700	
20	1880.00	-16.52	±4700	
30	1880.00	-34.15	±4700	
40	1880.00	-35.30	±4700	
50	1880.00	-21.32	±4700	

Frequency Stability under Voltage

DC Voltage (V)	Test Frequency (MHz)	Deviation (Hz)	Limit(Hz)	Result
3.3	1880.00	-32.64	±4700	PASS
3.7	1880.00	-20.56	±4700	
4.3	1880.00	-15.23	±4700	

Notes: the manufacture declared that the EUT could work between voltages 3.3V~4.5V, and this EUT could normally work under the condition from -20°C to 55°C, otherwise this EUT will shut down and not transmit.

8.Attachment

PHOTOGRAPHS OF TEST SETUP

Please refer to the file named “N7NHL6528-G2.8V _RF Setup Photos”.

PHOTOGRAPHS OF EUT

Please refer to two files named “N7NHL6528-G2.8V _EUT External Photos” and
“N7NHL6528-G2.8V _EUT Internal Photos”

----End of the report----