



FCC RADIO TEST REPORT

FCC ID : N7NEM91
Equipment : Wireless Module
Brand Name : AirPrime
Model Name : EM9190
Applicant : Sierra Wireless, Inc.
13811 Wireless Way, Richmond, BC, Canada
V6A 3A4
Manufacturer : Sierra Wireless, Inc.
13811 Wireless Way, Richmond, BC, Canada
V6A 3A4
Standard : 47 CFR Part 2, 96

The product was received on Mar. 27, 2020 and testing was started from Apr. 06, 2020 and completed on Apr. 27, 2020. We, SPORTON INTERNATIONAL INC. EMC & Wireless Communications Laboratory, would like to declare that the tested sample has been evaluated in accordance with the test procedures given in ANSI / TIA-603-E and has been in compliance with the applicable technical standards.

The report must not be used by the client to claim product certification, approval, or endorsement by TAF or any agency of government.

The test results in this report apply exclusively to the tested model / sample. Without written approval of SPORTON INTERNATIONAL INC. EMC & Wireless Communications Laboratory, the test report shall not be reproduced except in full.

Louis Wu

Approved by: Louis Wu

SPORTON INTERNATIONAL INC. EMC & Wireless Communications Laboratory

No. 52, Huaya 1st Rd., Guishan Dist., Taoyuan City, Taiwan (R.O.C.)



Table of Contents

History of this test report.....	3
Summary of Test Result.....	4
1 General Description	5
1.1 Product Feature of Equipment Under Test	5
1.2 Modification of EUT	5
1.3 Testing Location	6
1.4 Applied Standards	6
2 Test Configuration of Equipment Under Test	7
2.1 Test Mode.....	7
2.2 Connection Diagram of Test System	8
2.3 Support Unit used in test configuration	8
2.4 Measurement Results Explanation Example	9
2.5 Frequency List of Low/Middle/High Channels.....	9
3 Conducted Test Items.....	10
3.1 Measuring Instruments.....	10
3.2 Conducted Output Power	11
3.3 Peak-to-Average Ratio	12
3.4 EIRP	13
3.5 Occupied Bandwidth	14
3.6 Conducted Band Edge	15
3.7 Conducted Spurious Emission	16
3.8 Frequency Stability.....	17
4 Radiated Test Items	18
4.1 Measuring Instruments.....	18
4.2 Test Setup	18
4.3 Test Result of Radiated Test.....	19
4.4 Radiated Spurious Emission	20
5 List of Measuring Equipment.....	21
6 Uncertainty of Evaluation.....	22
Appendix A. Test Results of Conducted Test	
Appendix B. Test Results of EIRP and Radiated Test	



Summary of Test Result

Report Clause	Ref Std. Clause	Test Items	Result (PASS/FAIL)	Remark
3.2	§2.1046	Conducted Output Power	Reporting only	-
3.3	§96.41	Peak-to-Average Ratio	Pass	
3.4	§96.41	Effective Isotropic Radiated Power	Pass	-
3.5	§2.1049 §96.41	Occupied Bandwidth	Reporting only	-
3.6	§2.1051 §96.41	Conducted Band Edge Measurement	Pass	-
3.7	§2.1051 §96.41	Conducted Spurious Emission	Pass	
3.8	§2.1055	Frequency Stability for Temperature & Voltage	Pass	-
4.4	§2.1051 §96.41	Radiated Spurious Emission	Pass	Under limit 4.04 dB at 7128.000 MHz

Declaration of Conformity:

The test results with all measurement uncertainty excluded are presented in accordance with the regulation limits or requirements declared by manufacturers.

Comments and Explanations:

The declared of product specification for EUT presented in the report are provided by the manufacturer, and the manufacturer takes all the responsibilities for the accuracy of product specification.

Reviewed by: Wii Chang

Report Producer: Tina Chuang



1 General Description

1.1 Product Feature of Equipment Under Test

WCDMA/LTE

Product Specification subjective to this standard	
Antenna Type	WWAN: Fixed External Antenna

1.2 Modification of EUT

No modifications are made to the EUT during all test items.



1.3 Testing Location

Test Site	SPORTON INTERNATIONAL INC. EMC & Wireless Communications Laboratory
Test Site Location	No.52, Huaya 1st Rd., Guishan Dist., Taoyuan City, Taiwan (R.O.C.) TEL: +886-3-327-3456 FAX: +886-3-328-4978
Test Site No.	Sporton Site No. TH05-HY
Test Engineer	George Chen
Temperature	22 ~ 25°C
Relative Humidity	56 ~ 58%

Note: The test site complies with ANSI C63.4 2014 requirement.

Test Site	SPORTON INTERNATIONAL INC. EMC & Wireless Communications Laboratory
Test Site Location	No.58, Aly. 75, Ln. 564, Wenhua 3rd, Rd., Guishan Dist., Taoyuan City, Taiwan (R.O.C.) TEL: +886-3-327-0868 FAX: +886-3-327-0855
Test Site No.	Sporton Site No. 03CH12-HY
Test Engineer	Jack Cheng ,Lance Chiang ,and Chuan Chu
Temperature	22 ~ 26°C
Relative Humidity	58 ~ 62%

Note: The test site complies with ANSI C63.4 2014 requirement.

FCC Designation No.: TW1190 and TW0007

1.4 Applied Standards

According to the specifications of the manufacturer, the EUT must comply with the requirements of the following standards:

- ♦ ANSI C63.26-2015
- ♦ ANSI / TIA-603-E
- ♦ 47 CFR Part 2, 96
- ♦ FCC KDB 971168 D01 Power Meas. License Digital Systems v03r01
- ♦ FCC KDB 940660 D01 Part 96 CBRS Eqpt v01
- ♦ FCC KDB 412172 D01 Determining ERP and EIRP v01r01
- ♦ FCC KDB 414788 D01 Radiated Test Site v01r01

Remark: All test items were verified and recorded according to the standards and without any deviation during the test.



2 Test Configuration of Equipment Under Test

2.1 Test Mode

Antenna port conducted and radiated test items listed below are performed according to KDB 971168 D01 Power Meas. License Digital Systems v03r01 with maximum output power.

For radiated measurement, pre-scanned in two degrees Horizontal / Vertical. The worst cases (Vertical) were recorded in this report.

Test Items	Band	Bandwidth (MHz)						Modulation				RB #			Test Channel			
		1.4	3	5	10	15	20	QPSK	16QAM	64QAM	256QAM	1	Half	Full	L	M	H	
Max. Output Power	48	-	-	v	v	v	v	v	v	v	v	v	v	v	v	v	v	v
26dB and 99% Bandwidth	48	-	-	v	v	v	v	v	v	v	v			v	v	v	v	
Conducted Band Edge	48	-	-	v	v	v	v	v	v	v	v	v		v	v		v	
Peak-to-Average Ratio	48	-	-				v	v	v	v	v	v		v	v	v	v	
Conducted Spurious Emission	48	-	-	v	v	v	v	v	v	v	v	v		v	v	v	v	
E.R.P / E.I.R.P	48	-	-	v	v	v	v	v	v	v	v	v			v	v	v	
Frequency Stability	48	-	-		v			v				v				v		
Radiated Spurious Emission	48	Worst Case													v	v	v	
Remark	1. The mark "v " means that this configuration is chosen for testing 2. The mark "- " means that this bandwidth is not supported. 3. The device is investigated from 30MHz to 10 times of fundamental signal for radiated spurious emission test under different RB size/offset and modulations in exploratory test. Subsequently, only the worst case emissions are reported																	

2.2 Connection Diagram of Test System

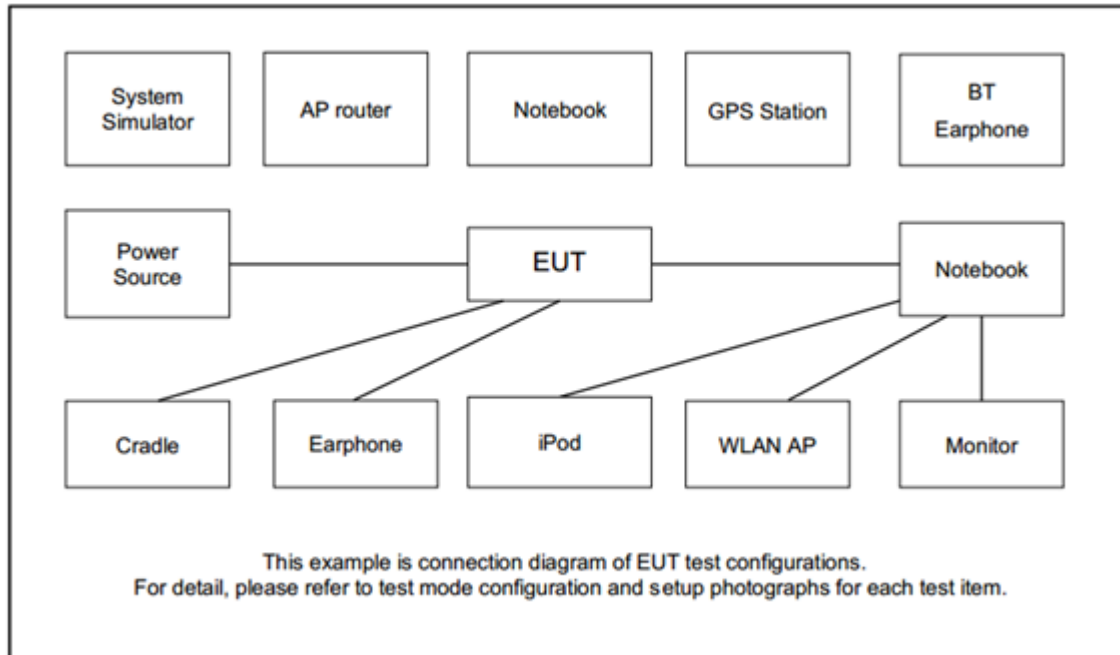

2.3 Support Unit used in test configuration

Item	Equipment	Trade Name	Model No.	FCC ID	Data Cable	Power Cord
1.	System Simulator	Anritsu	MT8821C	N/A	N/A	Unshielded, 1.8 m
2.	Power Supply	GW INSTEK	GPE-2323	N/A	N/A	N/A



2.4 Measurement Results Explanation Example

For all conducted test items:

The offset level is set in the spectrum analyzer to compensate the RF cable loss and attenuator factor between EUT conducted output port and spectrum analyzer. With the offset compensation, the spectrum analyzer reading level is exactly the EUT RF output level.

The spectrum analyzer offset is derived from RF cable loss and attenuator factor.

$$\text{Offset} = \text{RF cable loss} + \text{attenuator factor}.$$

Following shows an offset computation example with cable loss 4.2 dB and 10dB attenuator.

Example :

$$\begin{aligned} \text{Offset(dB)} &= \text{RF cable loss(dB)} + \text{attenuator factor(dB)}. \\ &= 4.2 + 10 = 14.2 \text{ (dB)} \end{aligned}$$

2.5 Frequency List of Low/Middle/High Channels

LTE Band 48 Channel and Frequency List				
BW [MHz]	Channel/Frequency(MHz)	Lowest	Middle	Highest
20	Channel	55340	55990	56640
	Frequency	3560.0	3625.0	3690.0
15	Channel	55315	55990	56665
	Frequency	3557.5	3625.0	3692.5
10	Channel	55290	55990	56690
	Frequency	3555.0	3625.0	3695.0
5	Channel	55265	55990	56715
	Frequency	3552.5	3625.0	3697.5

3 Conducted Test Items

3.1 Measuring Instruments

See list of measuring instruments of this test report.

3.1.1 Test Setup

3.1.2 Conducted Output Power

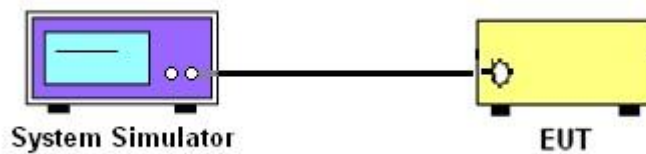

3.1.3 EIRP, Peak-to-Average Ratio, Occupied Bandwidth, Conducted Band-Edge and Conducted Spurious Emission

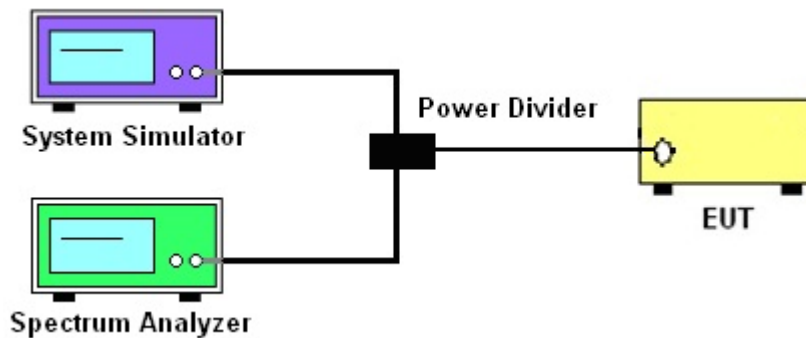

3.1.4 Frequency Stability

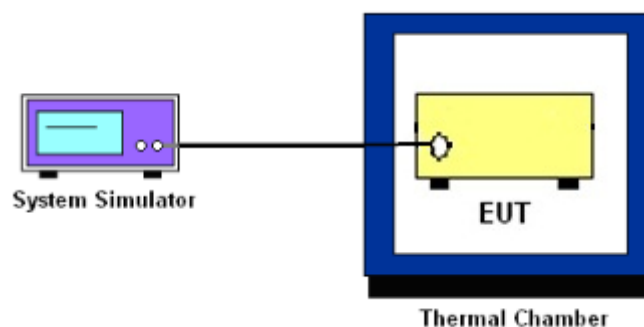

3.1.5 Test Result of Conducted Test

Please refer to Appendix A.



3.2 Conducted Output Power

3.2.1 Description of the Conducted Output Power Measurement

A system simulator was used to establish communication with the EUT. Its parameters were set to force the EUT transmitting at maximum output power. The measured power in the radio frequency on the transmitter output terminals shall be reported.

3.2.2 Test Procedures

1. The transmitter output port was connected to the system simulator.
2. Set EUT at maximum power through the system simulator.
3. Select lowest, middle, and highest channels for each band and different modulation.
4. Measure and record the power level from the system simulator.



3.3 Peak-to-Average Ratio

3.3.1 Description of the PAR Measurement

Power Complementary Cumulative Distribution Function (CCDF) curves provide a means for characterizing the power peaks of a digitally modulated signal on a statistical basis. A CCDF curve depicts the probability of the peak signal amplitude exceeding the average power level. Most contemporary measurement instrumentation include the capability to produce CCDF curves for an input signal provided that the instrument's resolution bandwidth can be set wide enough to accommodate the entire input signal bandwidth. In measuring transmissions in this band using an average power technique, the peak-to-average ratio (PAR) of the transmission may not exceed 13 dB.

3.3.2 Test Procedures

The testing follows ANSI C63.26-2015 Section 5.2.6

1. The EUT was connected to spectrum and system simulator via a power divider.
2. Set the CCDF (Complementary Cumulative Distribution Function) option in spectrum analyzer.
3. The highest RF powers were measured and recorded the maximum PAPR level associated with a probability of 0.1 %.
4. Record the deviation as Peak to Average Ratio



3.4 EIRP

3.4.1 Description of the EIRP Measurement

The EIRP of mobile transmitters must not exceed 23 dBm /10 megahertz for LTE Band 42 and Band 43, and Band 48.

The testing follows ANSI C63.26-2015 Section 5.2.5.5

According to KDB 412172 D01 Power Approach,

$EIRP = P_T + G_T - L_C$, where

P_T = transmitter output power in dBm

G_T = gain of the transmitting antenna in dBi

L_C = signal attenuation in the connecting cable between the transmitter and antenna in dB



3.5 Occupied Bandwidth

3.5.1 Description of Occupied Bandwidth Measurement

The occupied bandwidth is the width of a frequency band such that, below the lower and above the upper frequency limits, the mean powers emitted are each equal to a specified percentage 0.5% of the total mean transmitted power.

The 26 dB emission bandwidth is defined as the frequency range between two points, one above and one below the carrier frequency, at which the spectral density of the emission is attenuated 26 dB below the maximum in-band spectral density of the modulated signal. Spectral density (power per unit bandwidth) is to be measured with a detector of resolution bandwidth equal to approximately 1.0% of the emission bandwidth.

3.5.2 Test Procedures

The testing follows ANSI C63.26-2015 Section 5.4.3 (26dB) and Section 5.4.4 (99OB)

1. The EUT was connected to spectrum analyzer and system simulator via a power divider.
2. The spectrum analyzer center frequency is set to the nominal EUT channel center frequency. The span range for the spectrum analyzer shall be between two and five times the anticipated OBW.
3. The nominal resolution bandwidth (RBW) shall be in the range of 1 to 5 % of the anticipated OBW, and the VBW shall be at least 3 times the RBW.
4. Set the detection mode to peak, and the trace mode to max hold.
5. Determine the reference value: Set the EUT to transmit a modulated signal. Allow the trace to stabilize. Set the spectrum analyzer marker to the highest level of the displayed trace.
(this is the reference value)
6. Determine the “-26 dB down amplitude” as equal to (Reference Value – X).
7. Place two markers, one at the lowest and the other at the highest frequency of the envelope of the spectral display such that each marker is at or slightly below the “-X dB down amplitude” determined in step 6. If a marker is below this “-X dB down amplitude” value it shall be placed as close as possible to this value. The OBW is the positive frequency difference between the two markers.
8. Use the 99 % power bandwidth function of the spectrum analyzer and report the measured bandwidth.



3.6 Conducted Band Edge

3.6.1 Description of Conducted Band Edge Measurement

The power of any emission outside outside the fundamental emission (whether in or outside of the authorized band) shall not exceed -13 dBm/MHz. Compliance with this provision is based on the use of measurement instrumentation employing a resolution bandwidth of 1 MHz or less, but at least one percent of the emission bandwidth of the fundamental emission of the transmitter, provided the measured energy is integrated over a 1 MHz bandwidth.

3.6.2 Test Procedures

The testing follows FCC KDB 971168 D01 v03r01 Section 6.1.

1. The EUT was connected to spectrum analyzer and system simulator via a power divider.
2. The band edges of low and high channels for the highest RF powers were measured.
3. Set RBW \geq 1% EBW in the 1MHz band immediately outside and adjacent to the band edge.
4. Beyond the 1 MHz band from the band edge, RBW=1MHz was used
5. Set spectrum analyzer with RMS detector.
6. The RF fundamental frequency should be excluded against the limit line in the operating frequency band.
7. The conducted power of any emission outside the fundamental emission (whether in or outside of the authorized band) shall not exceed -13 dBm/MHz within 0-10 megahertz above the upper SAS-assigned channel edge and within 0-10 megahertz below the lower SAS-assigned channel edge. At all frequencies greater than 10 megahertz above the upper SAS assigned channel edge and less than 10 MHz below the lower SAS assigned channel edge, the conducted power of any emission shall not exceed -25 dBm/MHz



3.7 Conducted Spurious Emission

3.7.1 Description of Conducted Spurious Emission Measurement

96.41 (e)(2)

The conducted power of any emissions below 3530 MHz or above 3720 MHz shall not exceed -40dBm/MHz.

3.7.2 Test Procedures

The testing follows FCC KDB 971168 D01 v03r01 Section 6.1.

1. The EUT was connected to spectrum analyzer and system simulator via a power divider.
2. The RF output of EUT was connected to the spectrum analyzer by RF cable and attenuator. The path loss was compensated to the results for each measurement.
3. The middle channel for the highest RF power within the transmitting frequency was measured.
4. The conducted spurious emission for the whole frequency range was taken.
5. Make the measurement with the spectrum analyzer's RBW = 1MHz, VBW = 3MHz.
6. Set spectrum analyzer with RMS detector.
7. Taking the record of maximum spurious emission.
8. The RF fundamental frequency should be excluded against the limit line in the operating frequency band.
9. The limit line is -40dBm/MHz.



3.8 Frequency Stability

3.8.1 Description of Frequency Stability Measurement

The frequency stability shall be measured by variation of ambient temperature and variation of primary supply voltage to ensure that the fundamental emission stays within the authorized frequency block. The frequency stability of the transmitter shall be maintained within $\pm 0.00025\%$ ($\pm 2.5\text{ppm}$) of the center frequency

3.8.2 Test Procedures for Temperature Variation

The testing follows FCC KDB 971168 D01 v03r01 Section 9.0.

1. The EUT was set up in the thermal chamber and connected with the system simulator.
2. With power OFF, the temperature was decreased to -30°C and the EUT was stabilized before testing. Power was applied and the maximum change in frequency was recorded within one minute.
3. With power OFF, the temperature was raised in 10°C step up to 50°C . The EUT was stabilized at each step for at least half an hour. Power was applied and the maximum frequency change was recorded within one minute.

3.8.3 Test Procedures for Voltage Variation

The testing follows FCC KDB 971168 D01 v03r01 Section 9.0.

1. The EUT was placed in a temperature chamber at $25\pm 5^{\circ}\text{C}$ and connected with the system simulator.
2. The power supply voltage to the EUT was varied from 85% to 115% of the nominal value measured at the input to the EUT.
3. The variation in frequency was measured for the worst case.

4 Radiated Test Items

4.1 Measuring Instruments

See list of measuring instruments of this test report.

4.2 Test Setup

For radiated emissions below 30MHz

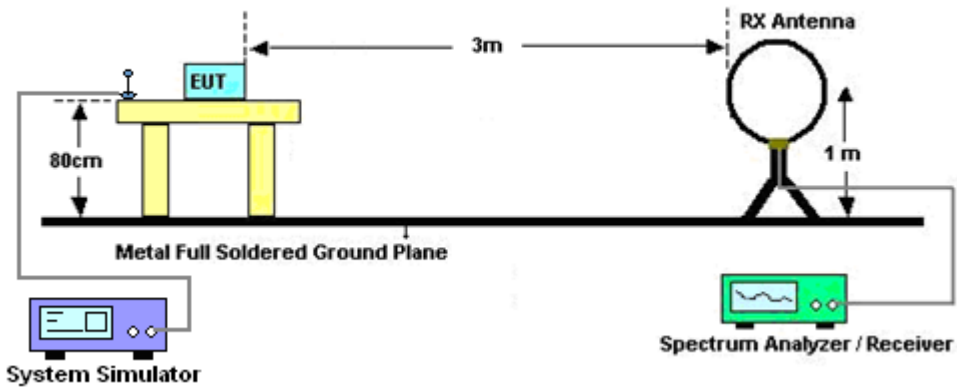

For radiated emissions from 30MHz to 1GHz

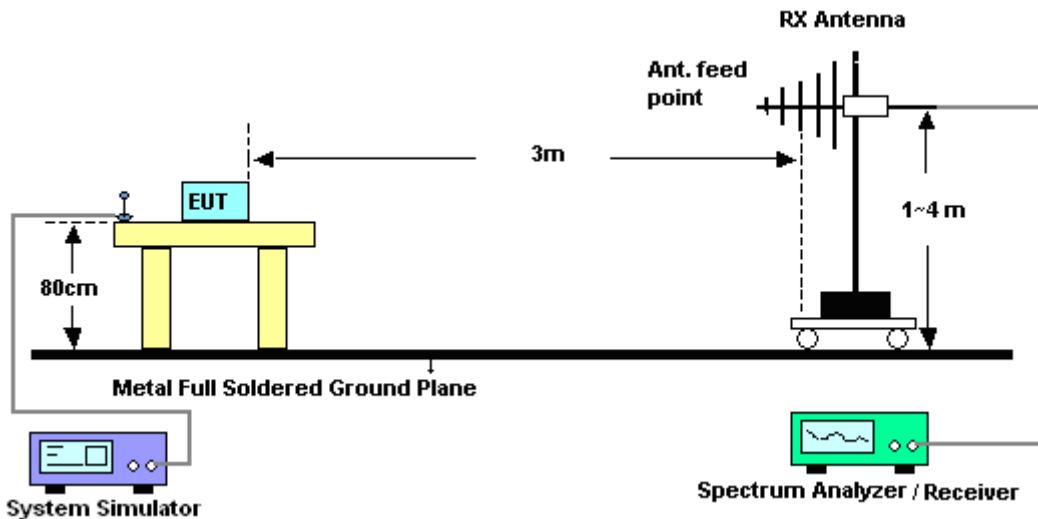

For radiated emissions above 1GHz

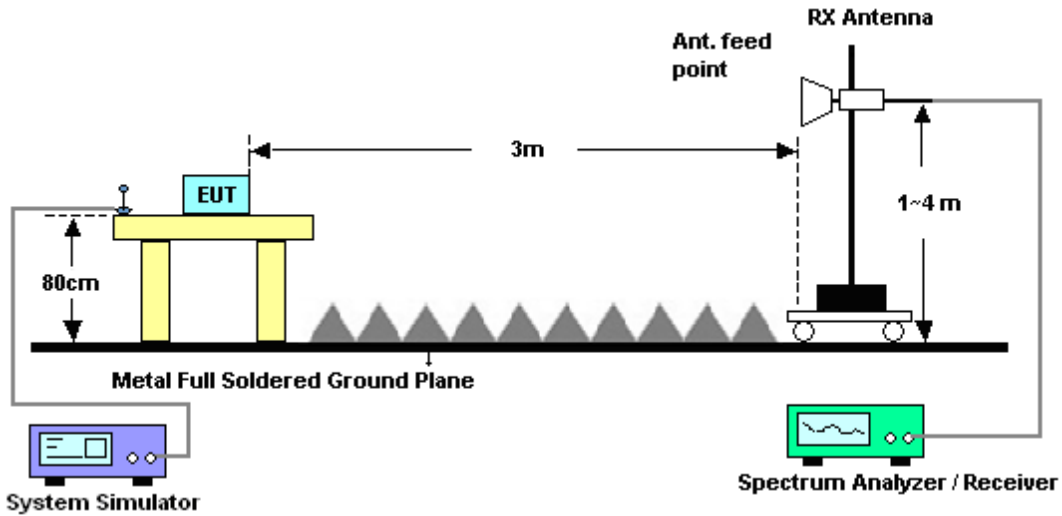

For radiated emissions above 18GHz

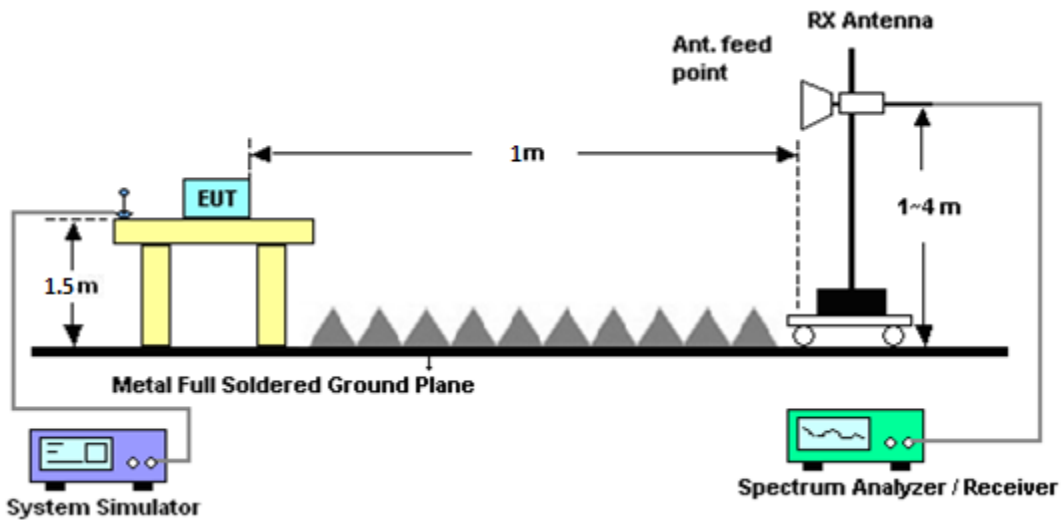

4.3 Test Result of Radiated Test

Please refer to Appendix B.

Note:

The low frequency, which started from 9 kHz to 30MHz, was pre-scanned and the result which was 20dB lower than the limit line was not reported.

There is a comparison data of both open-field test site and alternative test site - semi-Anechoic chamber according to 414788 D01 Radiated Test Site v01r01, and the result came out very similar.



4.4 Radiated Spurious Emission

4.4.1 Description of Radiated Spurious Emission Measurement

The radiated spurious emission was measured by substitution method according to ANSI / TIA-603-E. The power of any emission outside of the authorized operating frequency ranges must be attenuated below the transmitter power (P) by a factor of at least -40dBm / MHz. The spectrum is scanned from 30 MHz up to a frequency including its 10th harmonic.

4.4.2 Test Procedures

The testing follows FCC KDB 971168 D01 v03r01 Section 7 and ANSI / TIA-603-E Section 2.2.12.

1. The EUT was placed on a turntable with 0.8 meter height for frequency below 1GHz and 1.5 meter height for frequency above 1GHz respectively above ground.
2. The EUT was set 3 meters from the receiving antenna mounted on the antenna tower.
3. The table was rotated 360 degrees to determine the position of the highest spurious emission.
4. The height of the receiving antenna is varied between 1m to 4m to search the maximum spurious emission for both horizontal and vertical polarizations.
5. During the measurement, the system simulator parameters were set to force the EUT transmitting at maximum output power.
6. Make the measurement with the spectrum analyzer's RBW = 1MHz, VBW = 3MHz, taking the record of maximum spurious emission.
7. A horn antenna was substituted in place of the EUT and was driven by a signal generator. Tune the output power of signal generator to the same emission level with EUT maximum spurious emission.
EIRP (dBm) = S.G. Power – Tx Cable Loss + Tx Antenna Gain
ERP (dBm) = EIRP - 2.15
8. The RF fundamental frequency should be excluded against the limit line in the operating frequency band.
The limit line is -40dBm/MHz



5 List of Measuring Equipment

Instrument	Manufacturer	Model No.	Serial No.	Characteristics	Calibration Date	Test Date	Due Date	Remark
LTE Base Station	Anritsu	MT8821C	626200253 41	-	Oct. 24, 2019	Apr. 06, 2020~ Apr. 27, 2020	Oct. 23, 2020	Conducted (TH05-HY)
Spectrum Analyzer	Rohde & Schwarz	FSV40	101397	10Hz~40GHz	Nov. 15, 2019	Apr. 06, 2020~ Apr. 27, 2020	Nov. 14, 2020	Conducted (TH05-HY)
Temperature Chamber	ESPEC	SH-641	92013720	-40°C~90°C	Sep. 02, 2019	Apr. 06, 2020~ Apr. 27, 2020	Sep. 01, 2020	Conducted (TH05-HY)
Programmable Power Supply	GW Instek	PSS-2005	EL890094	1V~20V 0.5A~5A	Oct. 09, 2019	Apr. 06, 2020~ Apr. 27, 2020	Oct. 08, 2020	Conducted (TH05-HY)
Coupler	Warison	20dB 25W SMA Directional Coupler	#A	1-18GHz	Jan. 13, 2020	Apr. 06, 2020~ Apr. 27, 2020	Jan. 12, 2021	Conducted (TH05-HY)
Loop Antenna	Rohde & Schwarz	HFH2-Z2	100315	9 kHz~30 MHz	Dec. 26, 2019	Apr. 10, 2020~ Apr. 11, 2020	Dec. 25, 2020	Radiation (03CH12-HY)
Bilog Antenna	TESEQ	CBL 6111D & 00800N1D01 N-06	41912 & 05	30MHz~1GHz	Oct. 12, 2019	Apr. 10, 2020~ Apr. 11, 2020	Oct. 11, 2020	Radiation (03CH12-HY)
Horn Antenna	SCHWARZBE CK	BBHA 9120D	9120D-132 8	1GHz ~ 18GHz	Nov. 14, 2019	Apr. 10, 2020~ Apr. 11, 2020	Nov. 13, 2020	Radiation (03CH12-HY)
Horn Antenna	SCHWARZBE CK	BBHA 9120D	9120D-152 2	1GHz ~ 18GHz	Sep. 19, 2019	Apr. 10, 2020~ Apr. 11, 2020	Sep. 18, 2020	Radiation (03CH12-HY)
SHF-EHF Horn Antenna	SCHWARZBE CK	BBHA 9170	BBHA9170 584	18GHz ~ 40GHz	Dec. 10, 2019	Apr. 10, 2020~ Apr. 11, 2020	Dec. 09, 2020	Radiation (03CH12-HY)
Preamplifier	COM-POWER	PA-103	161075	10MHz~1GHz	Mar. 25, 2020	Apr. 10, 2020~ Apr. 11, 2020	Mar. 24, 2021	Radiation (03CH12-HY)
Preamplifier	MITEQ	AMF-7D-0010 1800-30-10P	1590074	1GHz~18GHz	May 20, 2019	Apr. 10, 2020~ Apr. 11, 2020	May 19, 2020	Radiation (03CH12-HY)
Preamplifier	EMEC	EM18G40G	060715	18GHz ~ 40GHz	Dec. 13, 2019	Apr. 10, 2020~ Apr. 11, 2020	Dec. 12, 2020	Radiation (03CH12-HY)
Preamplifier	Agilent	8449B	3008A023 75	1GHz~26.5GHz	May 27, 2019	Apr. 10, 2020~ Apr. 11, 2020	May 26, 2020	Radiation (03CH12-HY)
Spectrum Analyzer	Agilent	N9010A	MY534701 18	10Hz~44GHz	Apr. 18, 2019	Apr. 10, 2020~ Apr. 11, 2020	Apr. 17, 2020	Radiation (03CH13-HY)
Signal Generator	Rohde & Schwarz	SMF100A	101107	100kHz~40GHz	Aug. 27, 2019	Apr. 10, 2020~ Apr. 11, 2020	Aug. 26, 2020	Radiation (03CH12-HY)
Hygrometer	TECPEL	DTM-303B	TP161243	N/A	May 11, 2019	Apr. 10, 2020~ Apr. 11, 2020	May 10, 2020	Radiation (03CH12-HY)
RF Cable	HUBER + SUHNER	SUCOFLEX 126E	0058/126E	30M-18G	Dec. 12, 2019	Apr. 10, 2020~ Apr. 11, 2020	Dec. 11, 2020	Radiation (03CH12-HY)
RF Cable	HUBER + SUHNER	SUCOFLEX 102	505134/2	30M~40GHz	Feb. 25, 2019	Apr. 10, 2020~ Apr. 11, 2020	Feb. 24, 2021	Radiation (03CH12-HY)
RF Cable	HUBER + SUHNER	SUCOFLEX 102	800740/2	30M~40GHz	Feb. 25, 2019	Apr. 10, 2020~ Apr. 11, 2020	Feb. 24, 2021	Radiation (03CH12-HY)
Base Station	Anritsu	MT8821C	620143281 6	GSM / GPRS /WCDMA / LTE FDD/TDD with 44) /LTE-3CC DLCA,2CC ULCA	May 05, 2019	Apr. 10, 2020~ Apr. 11, 2020	May 04, 2020	Radiation (03CH12-HY)
Controller	EMEC	EM1000	N/A	Control Turn table & Ant Mast	N/A	Apr. 10, 2020~ Apr. 11, 2020	N/A	Radiation (03CH12-HY)
Antenna Mast	EMEC	AM-BS-4500- B	N/A	1m~4m	N/A	Apr. 10, 2020~ Apr. 11, 2020	N/A	Radiation (03CH12-HY)
Turn Table	EMEC	TT2000	N/A	0~360 Degree	N/A	Apr. 10, 2020~ Apr. 11, 2020	N/A	Radiation (03CH12-HY)
Software	Audix	E3 6.2009-8-24	RK-00098 9	N/A	N/A	Apr. 10, 2020~ Apr. 11, 2020	N/A	Radiation (03CH12-HY)



6 Uncertainty of Evaluation

Uncertainty of Radiated Emission Measurement (30 MHz ~ 1000 MHz)

Measuring Uncertainty for a Level of Confidence of 95% ($U = 2Uc(y)$)	3.24
---	------

Uncertainty of Radiated Emission Measurement (1 GHz ~ 18 GHz)

Measuring Uncertainty for a Level of Confidence of 95% ($U = 2Uc(y)$)	3.62
---	------

Uncertainty of Radiated Emission Measurement (18 GHz ~ 40 GHz)

Measuring Uncertainty for a Level of Confidence of 95% ($U = 2Uc(y)$)	4.06
---	------



Appendix A. Test Results of Conducted Test

Conducted Output Power(Average power)

LTE Band 48 Maximum Average Power [dBm]						
BW [MHz]	RB Size	RB Offset	Mod	Lowest	Middle	Highest
20	1	0	QPSK	22.22	22.54	22.33
20	1	49		22.15	22.43	22.13
20	1	99		22.29	22.52	22.17
20	50	0		21.04	21.29	21.10
20	50	24		21.08	21.29	21.09
20	50	50		21.07	21.26	20.94
20	100	0		21.09	21.28	21.08
20	1	0	16-QAM	22.23	22.51	22.27
20	1	49		22.14	22.43	22.14
20	1	99		22.29	22.53	22.19
20	50	0		21.08	21.27	21.10
20	50	24		21.07	21.29	21.07
20	50	50		21.08	21.30	20.96
20	100	0		21.06	21.31	21.08
20	1	0	64-QAM	21.02	21.29	21.12
20	1	49		21.00	21.24	20.94
20	1	99		21.07	21.31	20.96
20	50	0		20.14	20.31	20.13
20	50	24		20.10	20.33	20.11
20	50	50		20.12	20.33	20.01
20	100	0		20.09	20.31	20.08
20	1	0	256-QAM	18.01	18.29	18.13
20	1	49		17.95	18.27	17.99
20	1	99		18.05	18.26	17.96
20	50	0		18.18	18.41	18.21
20	50	24		18.20	18.41	18.20
20	50	50		18.18	18.41	18.08
20	100	0		18.13	18.37	18.15



LTE Band 48 Maximum Average Power [dBm]						
BW [MHz]	RB Size	RB Offset	Mod	Lowest	Middle	Highest
15	1	0	QPSK	22.88	23.16	22.92
15	1	37		22.87	23.15	22.86
15	1	74		22.97	23.26	22.89
15	36	0		22.03	22.25	22.06
15	36	20		22.00	22.23	22.01
15	36	39		22.03	22.22	21.98
15	75	0		22.01	22.24	22.01
15	1	0	16-QAM	22.20	22.48	22.25
15	1	37		22.15	22.46	22.09
15	1	74		22.25	22.52	22.23
15	36	0		21.03	21.26	21.07
15	36	20		21.04	21.25	21.04
15	36	39		21.06	21.25	21.02
15	75	0		21.03	21.27	21.02
15	1	0	64-QAM	20.97	21.20	21.05
15	1	37		20.98	21.23	20.91
15	1	74		21.09	21.31	21.00
15	36	0		20.08	20.29	20.08
15	36	20		20.04	20.26	20.01
15	36	39		20.05	20.27	20.04
15	75	0		20.08	20.34	20.09
15	1	0	256-QAM	17.93	18.24	18.08
15	1	37		17.94	18.28	17.94
15	1	74		18.05	18.33	17.99
15	36	0		18.11	18.34	18.16
15	36	20		18.12	18.35	18.09
15	36	39		18.09	18.34	18.11
15	75	0		18.10	18.32	18.14



LTE Band 48 Maximum Average Power [dBm]						
BW [MHz]	RB Size	RB Offset	Mod	Lowest	Middle	Highest
10	1	0	QPSK	22.36	22.73	22.36
10	1	25		22.32	22.60	22.24
10	1	49		22.35	22.67	22.38
10	25	0		21.13	21.29	21.15
10	25	12		21.16	21.37	21.12
10	25	25		21.10	21.31	21.09
10	50	0		21.13	21.37	21.11
10	1	0	16-QAM	22.47	22.70	22.40
10	1	25		22.30	22.60	22.27
10	1	49		22.42	22.75	22.35
10	25	0		21.02	21.24	20.99
10	25	12		21.06	21.30	21.07
10	25	25		21.06	21.28	21.01
10	50	0		21.16	21.37	21.16
10	1	0	64-QAM	21.29	21.47	21.27
10	1	25		21.16	21.42	21.09
10	1	49		21.28	21.49	21.17
10	25	0		20.19	20.40	20.21
10	25	12		20.20	20.45	20.19
10	25	25		20.20	20.41	20.18
10	50	0		20.17	20.41	20.14
10	1	0	256-QAM	18.12	18.30	18.10
10	1	25		18.01	18.28	18.06
10	1	49		18.07	18.29	18.09
10	25	0		18.20	18.40	18.19
10	25	12		18.15	18.39	18.16
10	25	25		18.18	18.38	18.12
10	50	0		18.17	18.44	18.17



LTE Band 48 Maximum Average Power [dBm]						
BW [MHz]	RB Size	RB Offset	Mod	Lowest	Middle	Highest
5	1	0	QPSK	22.32	22.60	22.32
5	1	12		22.33	22.67	22.34
5	1	24		22.32	22.62	22.29
5	12	0		21.12	21.34	21.10
5	12	7		21.07	21.33	21.08
5	12	13		21.07	21.31	21.07
5	25	0		21.17	21.42	21.14
5	1	0	16-QAM	22.36	22.57	22.31
5	1	12		22.22	22.52	22.18
5	1	24		22.36	22.58	22.33
5	12	0		21.09	21.35	21.12
5	12	7		21.14	21.36	21.11
5	12	13		21.12	21.36	21.11
5	25	0		21.06	21.30	21.05
5	1	0	64-QAM	21.24	21.44	21.14
5	1	12		21.09	21.40	21.11
5	1	24		21.22	21.46	21.19
5	12	0		20.14	20.36	20.14
5	12	7		20.13	20.41	20.13
5	12	13		20.15	20.37	20.11
5	25	0		20.20	20.49	20.24
5	1	0	256-QAM	18.19	18.40	18.11
5	1	12		18.07	18.40	18.02
5	1	24		18.15	18.40	18.14
5	12	0		18.25	18.52	18.22
5	12	7		18.21	18.49	18.21
5	12	13		18.22	18.49	18.21
5	25	0		18.17	18.44	18.17



LTE Band 48

Peak-to-Average Ratio

Mode	LTE Band 48 / 20MHz				
Mod.	QPSK		16QAM		Limit: 13dB
RB Size	1RB	Full RB	1RB	Full RB	Result
Lowest CH	3.74	4.90	4.81	5.86	PASS
Middle CH	3.77	4.84	4.67	5.86	
Highest CH	3.74	4.87	4.78	5.83	
Mode	LTE Band 48 / 20MHz				
Mod.	64QAM		256QAM		Limit: 13dB
RB Size	1RB	Full RB	1RB	Full RB	Result
Lowest CH	7.28	6.49	7.45	6.52	PASS
Middle CH	6.87	6.58	7.25	6.58	
Highest CH	6.84	6.58	6.93	6.61	



LTE Band 48 / 20MHz / QPSK

Lowest Channel / 1RB

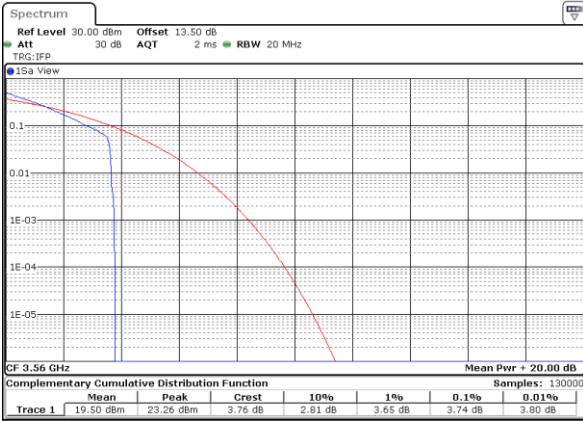

Date: 13.APR.2020 12:57:54

Lowest Channel / Full RB

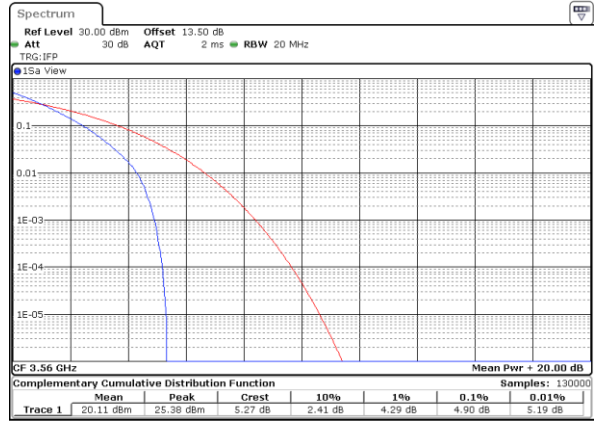

Date: 13.APR.2020 12:58:15

Middle Channel / 1RB

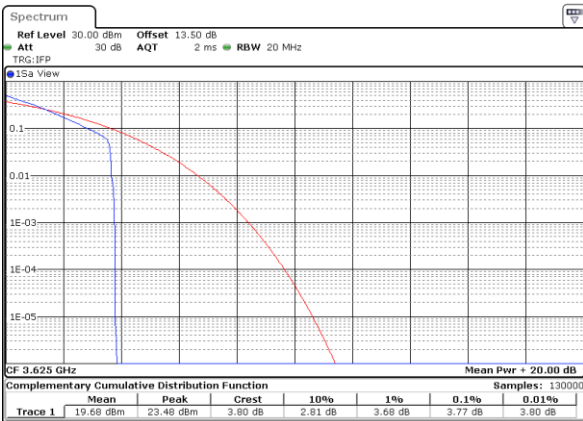

Date: 13.APR.2020 12:58:08

Middle Channel / Full RB

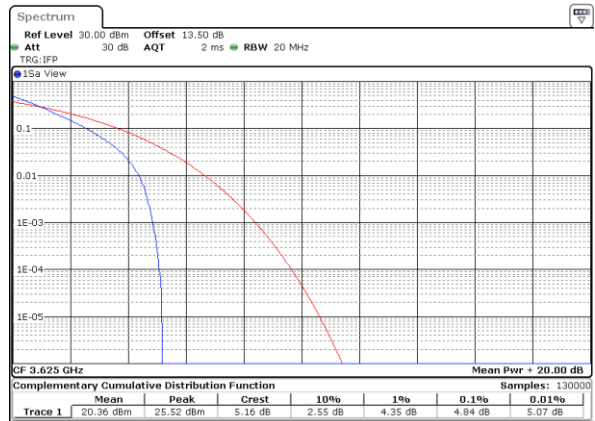

Date: 13.APR.2020 12:58:59

Highest Channel / 1RB



Date: 13.APR.2020 12:59:25

Highest Channel / Full RB

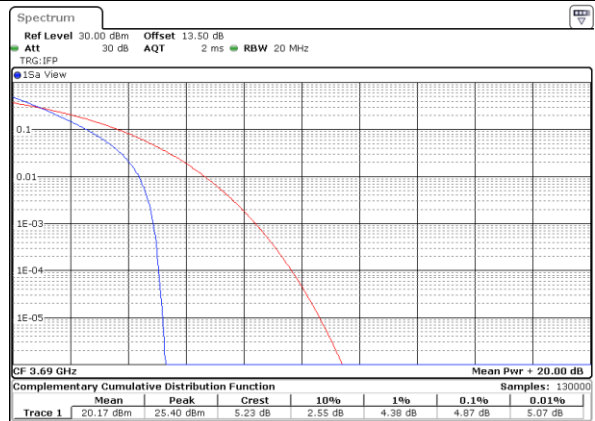

Date: 13.APR.2020 12:59:47



LTE Band 48 / 20MHz / 16QAM

Lowest Channel / 1RB

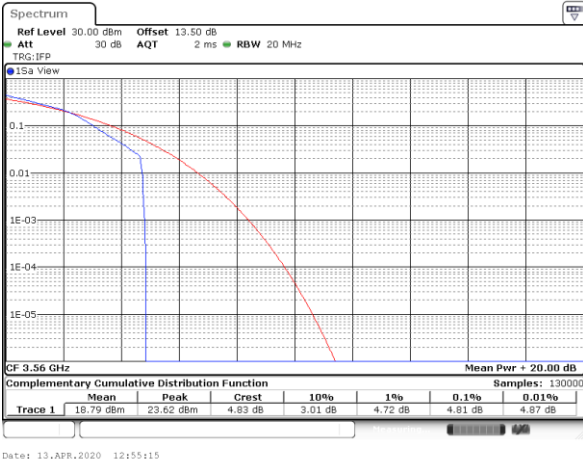

Date: 13.APR.2020 12:55:15

Lowest Channel / Full RB

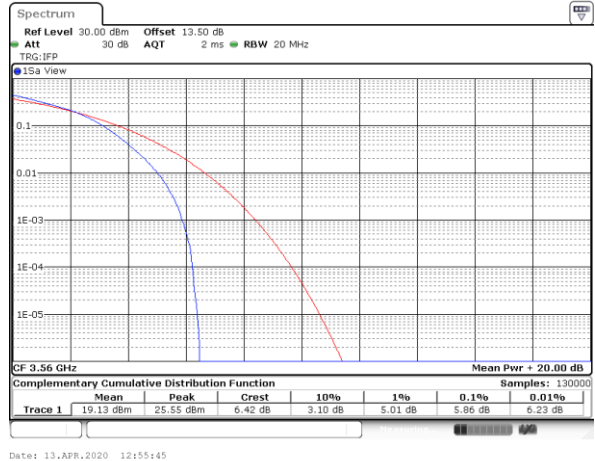

Date: 13.APR.2020 12:55:45

Middle Channel / 1RB

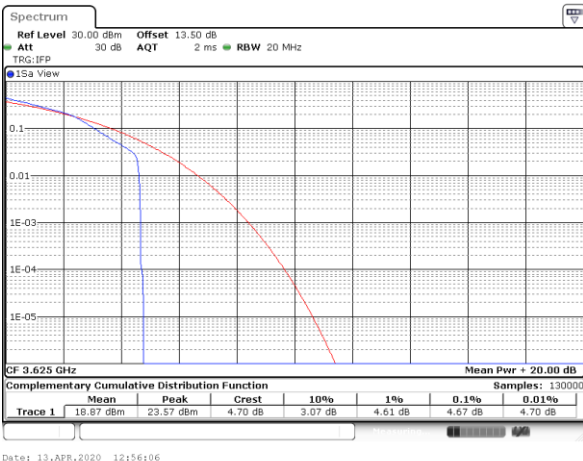

Date: 13.APR.2020 12:56:06

Middle Channel / Full RB

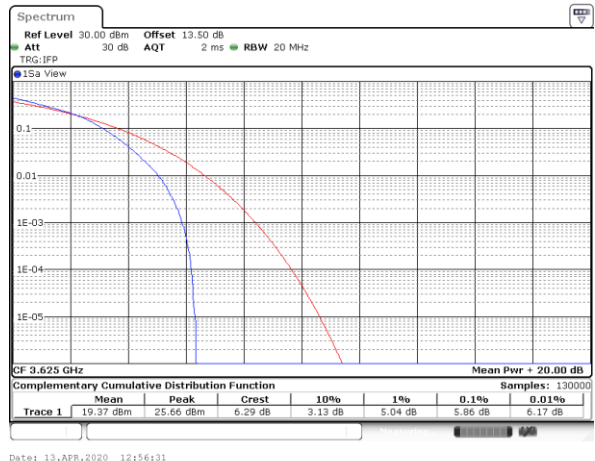

Date: 13.APR.2020 12:56:31

Highest Channel / 1RB

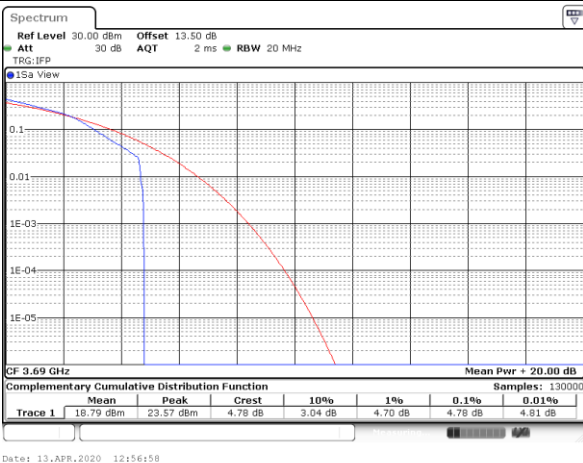

Date: 13.APR.2020 12:56:58

Highest Channel / Full RB

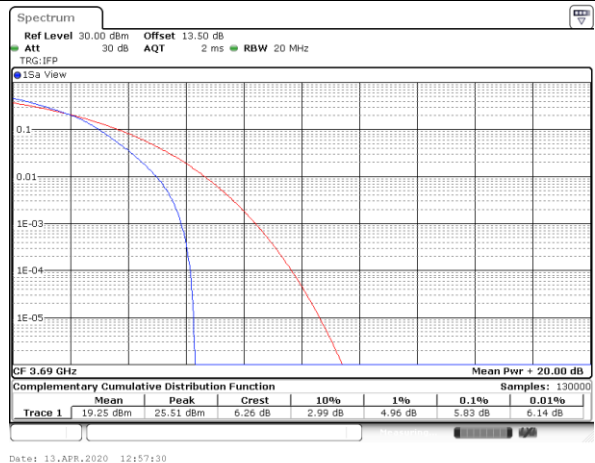

Date: 13.APR.2020 12:57:30



LTE Band 48 / 20MHz / 64QAM

Lowest Channel / 1RB



Date: 13.APR.2020 12:53:01

Lowest Channel / Full RB

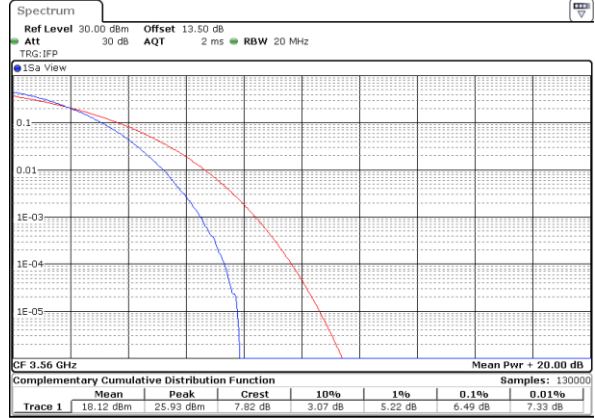

Date: 13.APR.2020 12:53:23

Middle Channel / 1RB

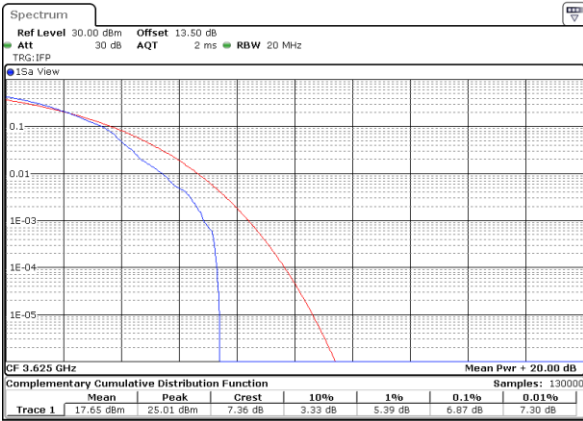

Date: 13.APR.2020 12:53:44

Middle Channel / Full RB

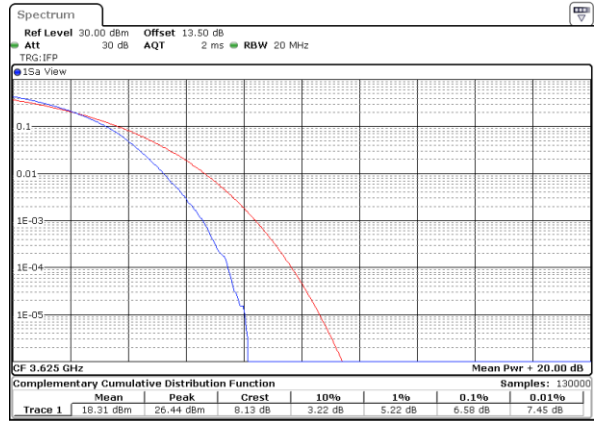

Date: 13.APR.2020 12:54:05

Highest Channel / 1RB

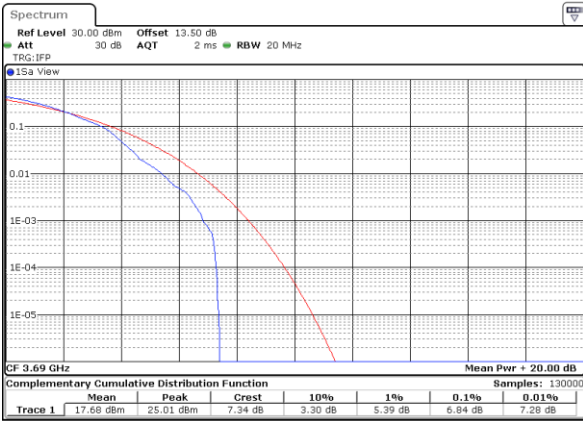

Date: 13.APR.2020 12:54:29

Highest Channel / Full RB

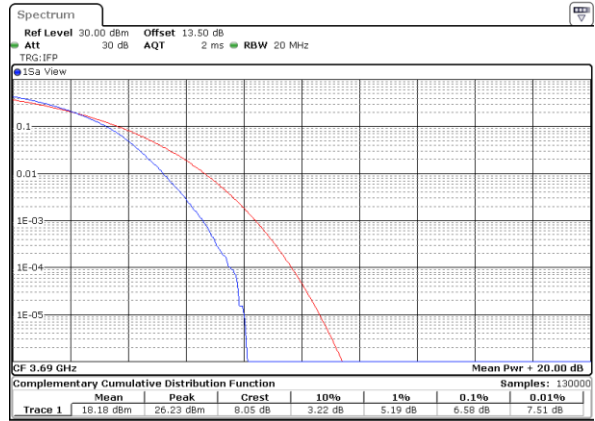

Date: 13.APR.2020 12:54:50



LTE Band 48 / 20MHz / 256QAM

Lowest Channel / 1RB

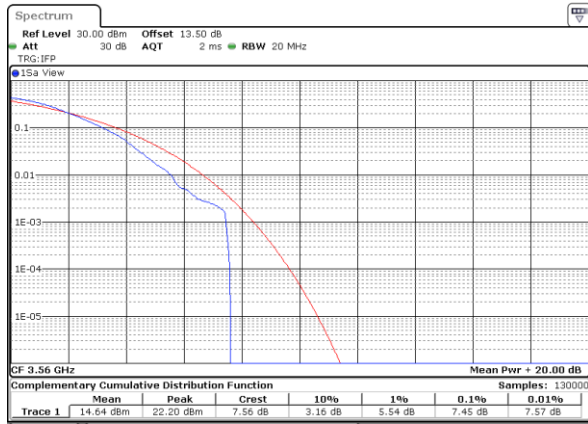

Date: 13.APR.2020 13:36:51

Lowest Channel / Full RB

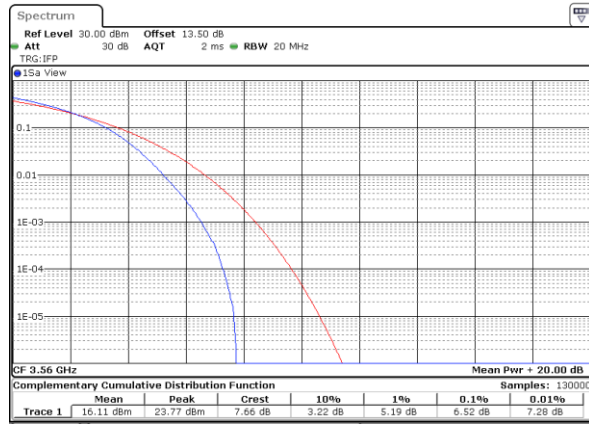

Date: 13.APR.2020 13:36:24

Middle Channel / 1RB

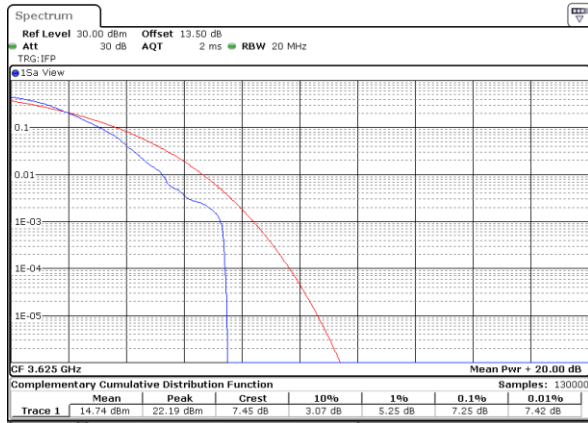

Date: 13.APR.2020 13:42:06

Middle Channel / Full RB

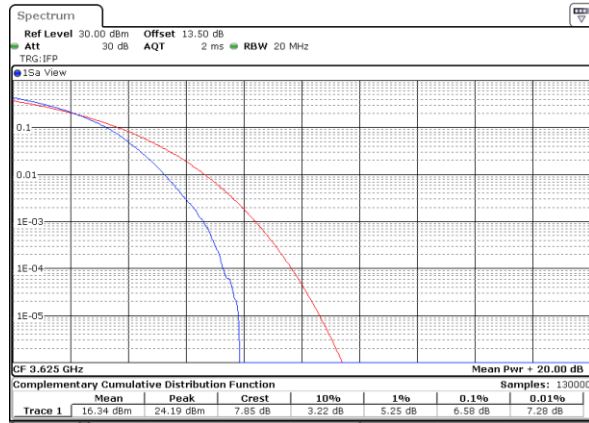

Date: 13.APR.2020 13:42:35

Highest Channel / 1RB



Date: 13.APR.2020 13:24:17

Highest Channel / Full RB



Date: 13.APR.2020 13:25:11



ACLR

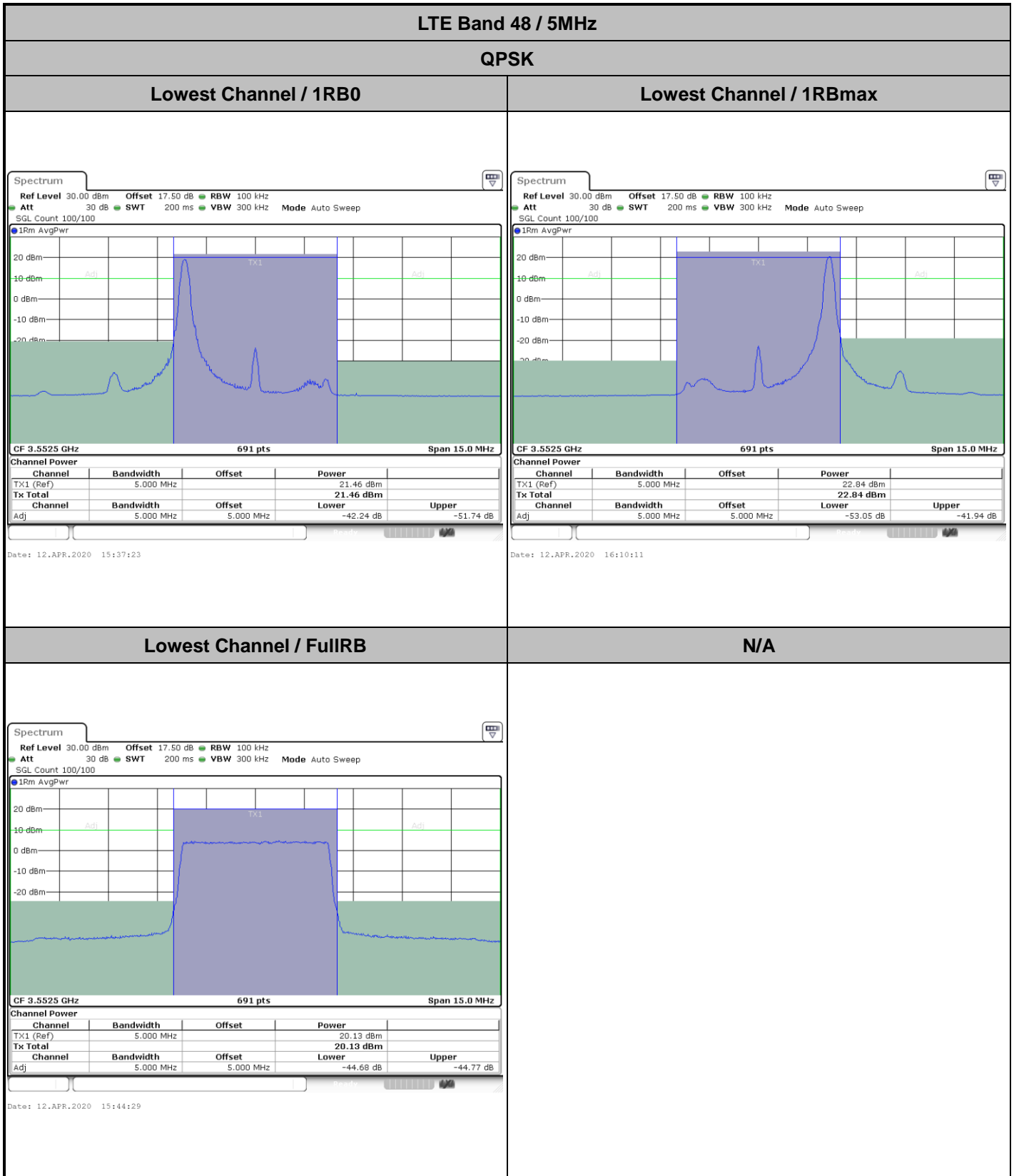



LTE Band 48 / 5MHz

QPSK

Middle Channel / 1RB0

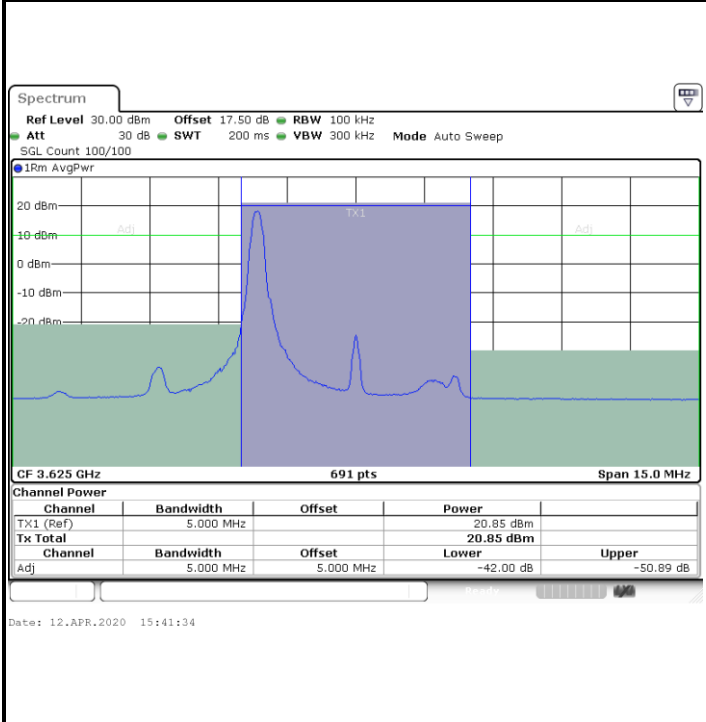

Middle Channel / 1RBmax

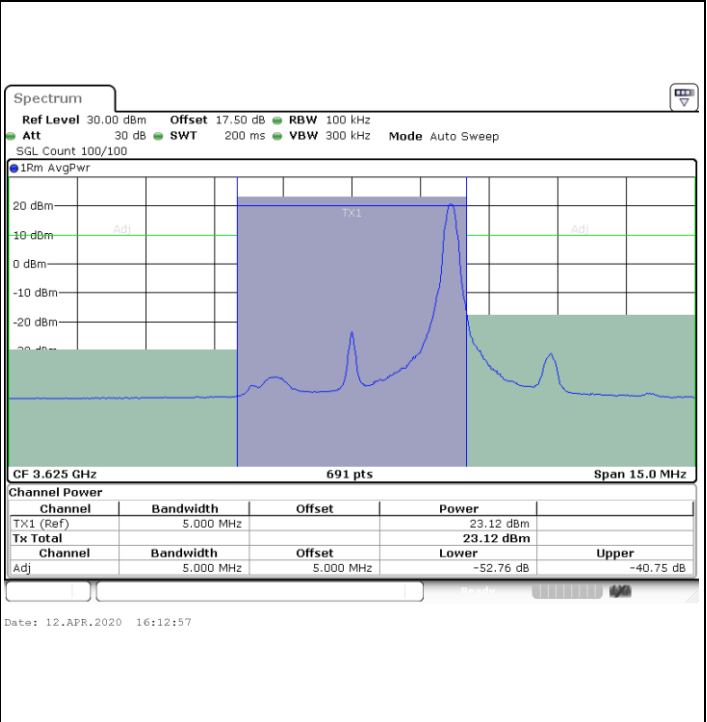

Middle Channel / FullRB

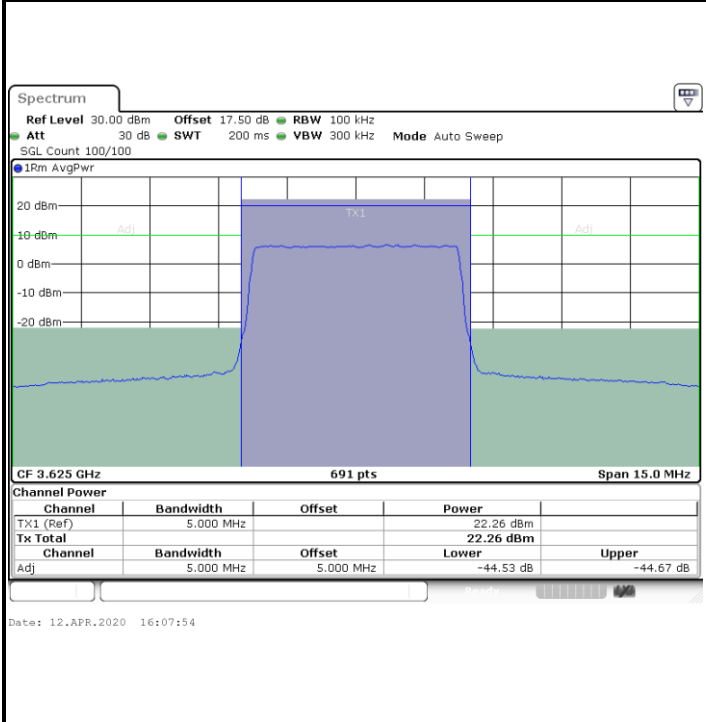

N/A

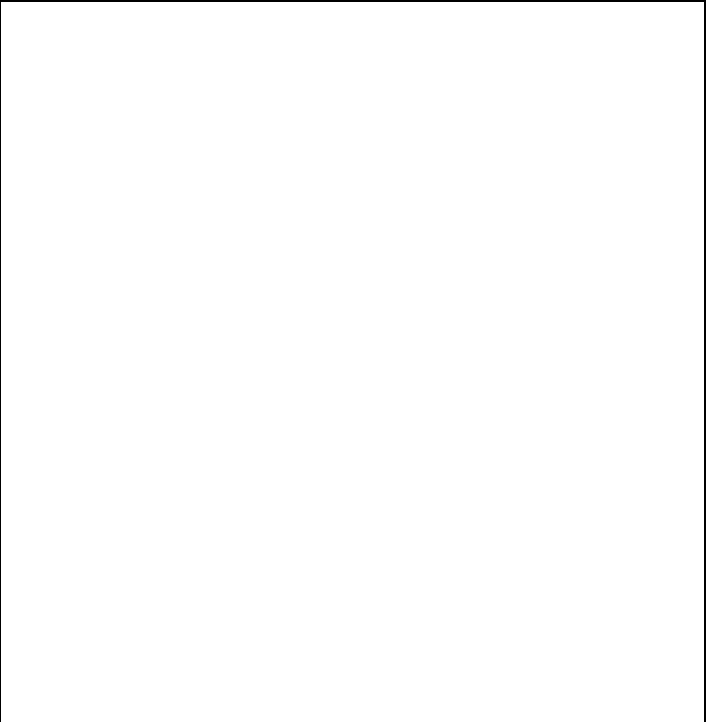



LTE Band 48 / 5MHz

QPSK

Highest Channel / 1RB0

Highest Channel / 1RBmax

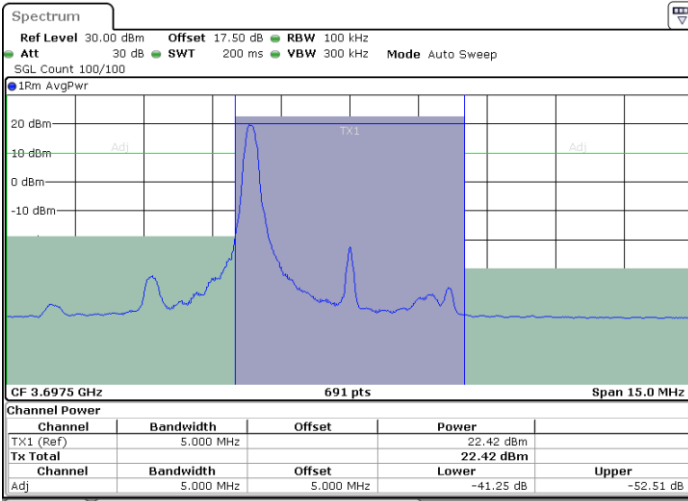

Date: 12.APR.2020 15:42:46

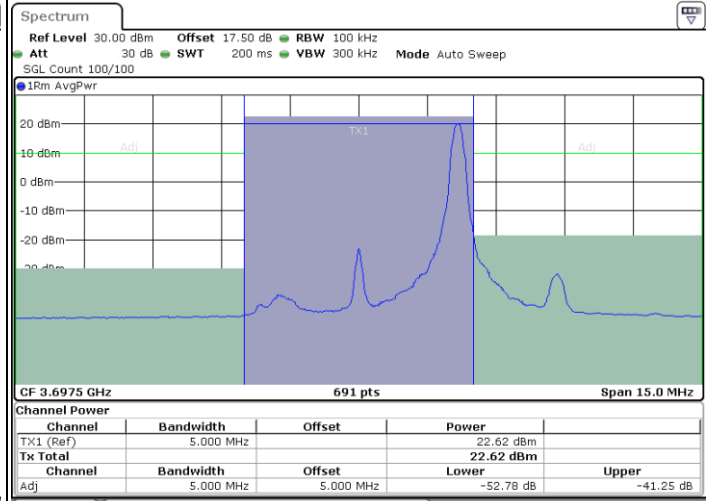

Date: 12.APR.2020 16:13:31

Highest Channel / FullIRB

N/A

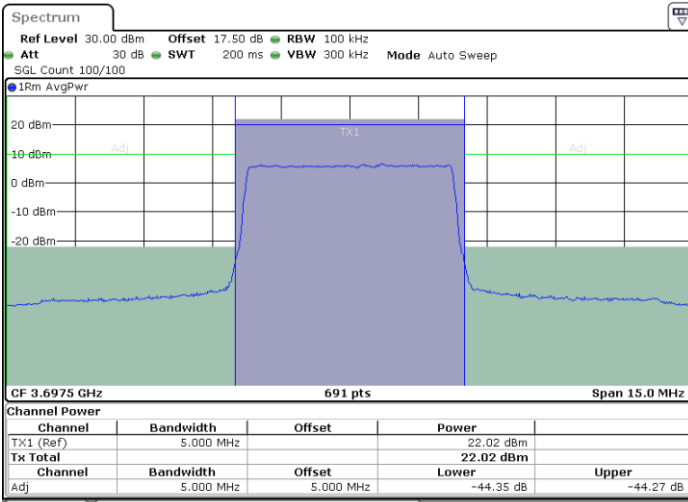

Date: 12.APR.2020 16:08:28



LTE Band 48 / 10MHz

QPSK

Lowest Channel / 1RB0

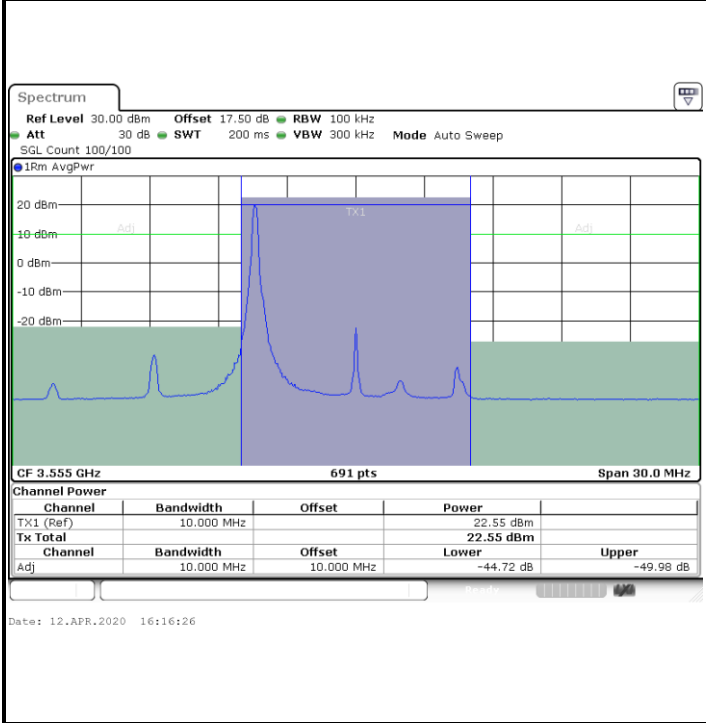

Lowest Channel / 1RBmax

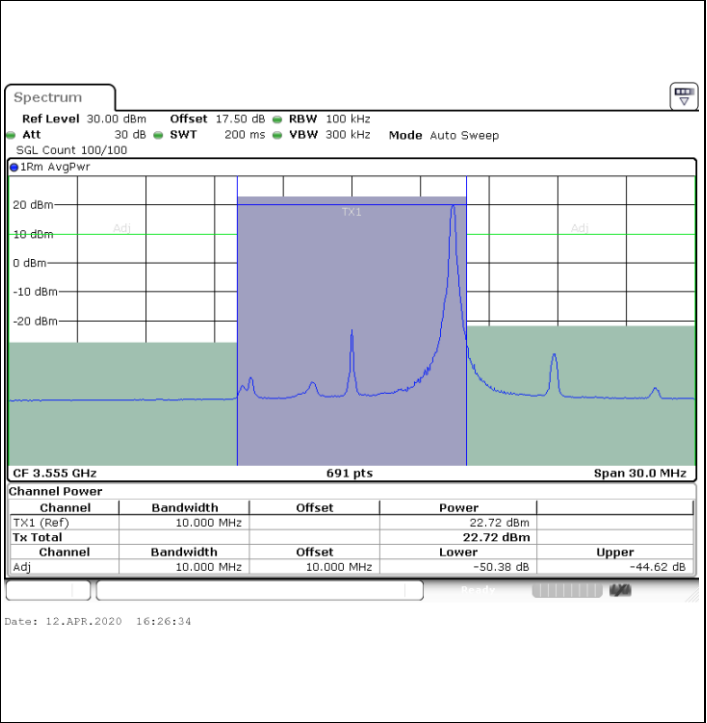

Lowest Channel / FullIRB

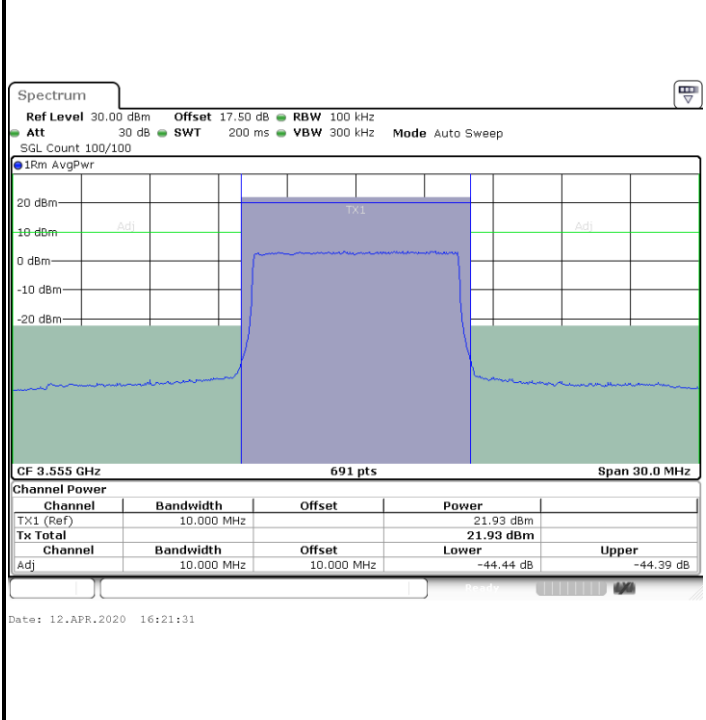

N/A



LTE Band 48 / 10MHz

QPSK

MiddleChannel / 1RB0

Middle Channel / 1RBmax

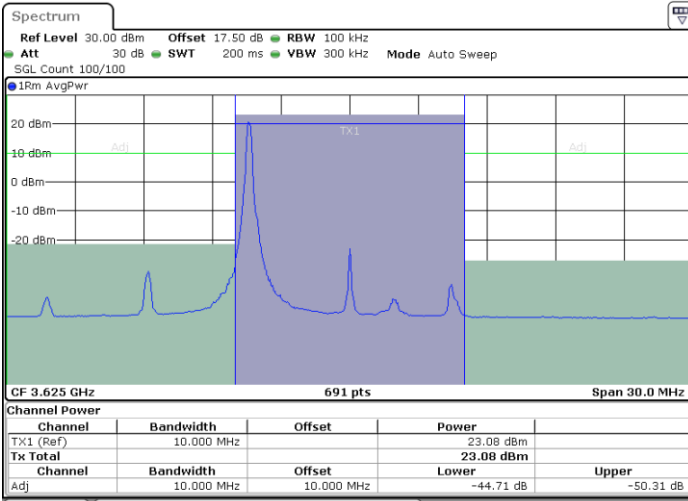

Date: 12.APR.2020 16:16:59

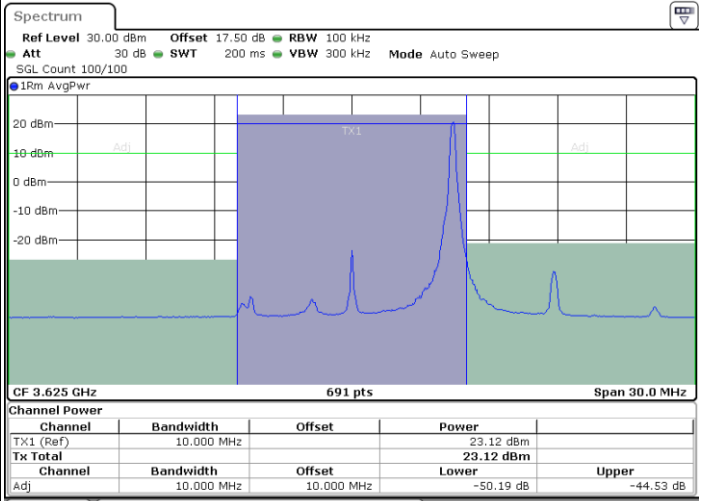

Date: 12.APR.2020 16:27:08

Middle Channel / FullIRB

N/A

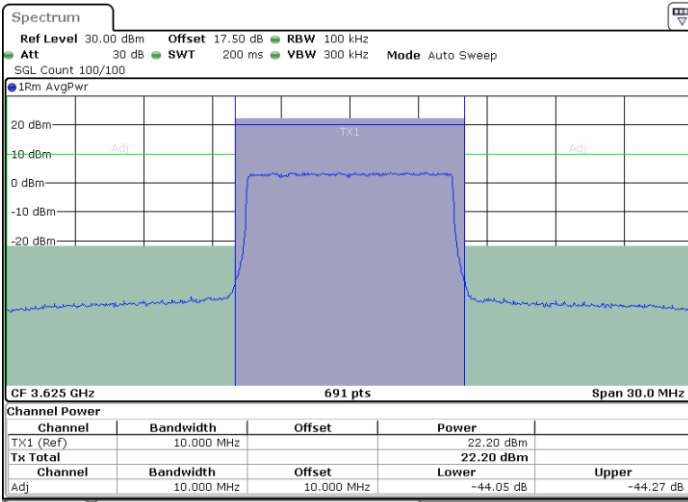

Date: 12.APR.2020 16:22:04



LTE Band 48 / 10MHz

QPSK

Highest Channel / 1RB0

Highest Channel / 1RBmax

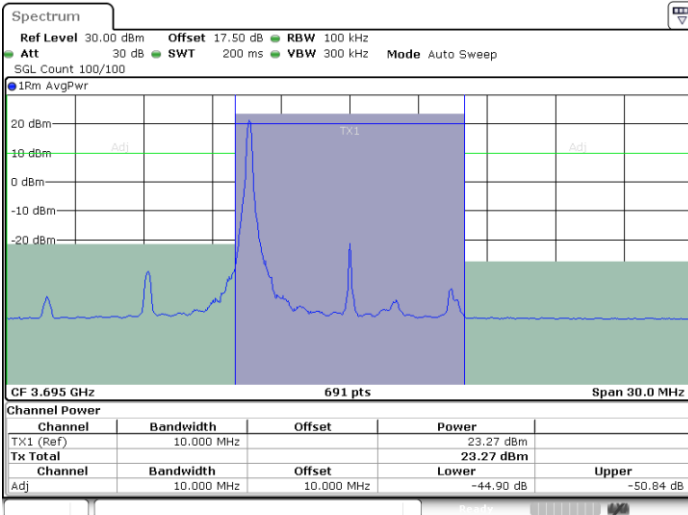

Date: 12.APR.2020 16:19:49

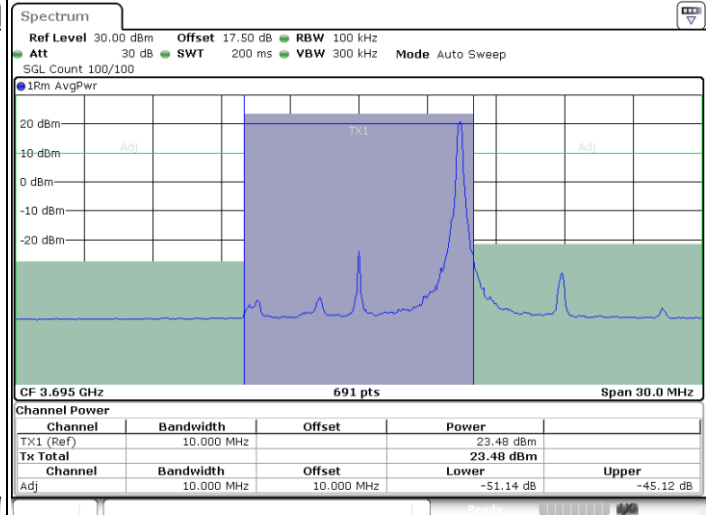

Date: 12.APR.2020 16:29:56

Highest Channel / FullIRB

N/A

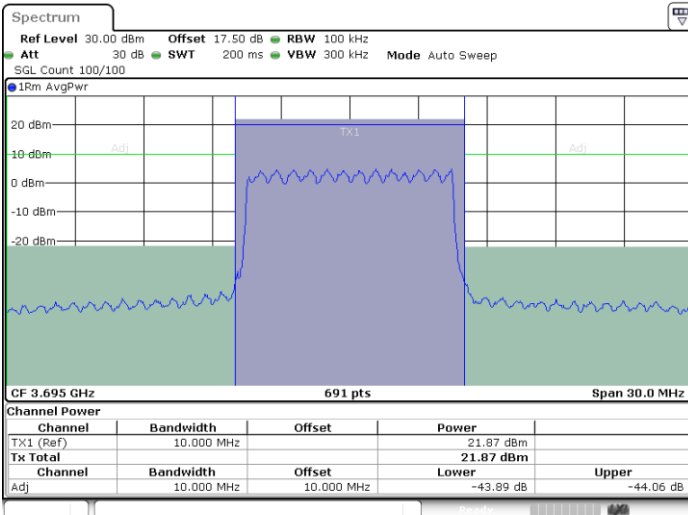

Date: 12.APR.2020 16:24:53



LTE Band 48 / 15MHz

QPSK

Lowest Channel / 1RB0

Lowest Channel / 1RBmax

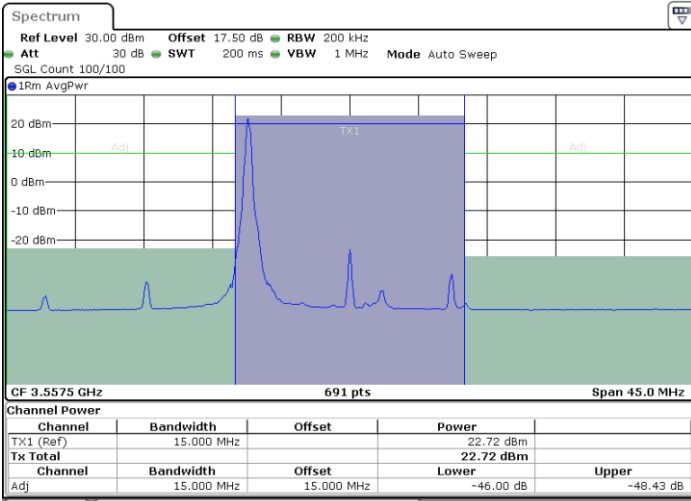

Date: 12.APR.2020 16:30:31

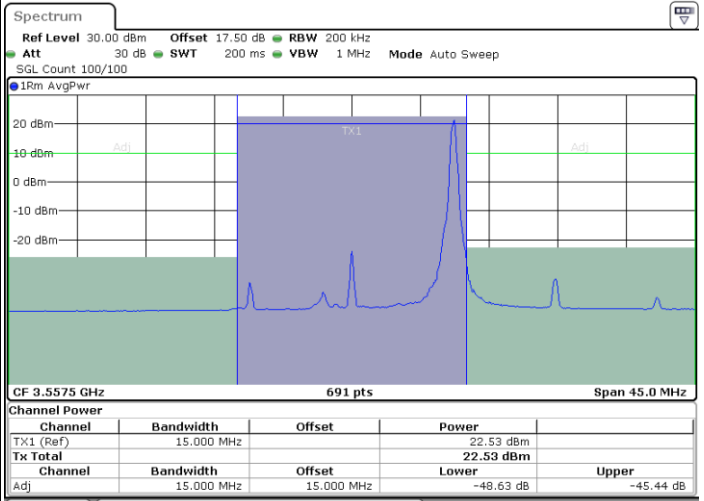

Date: 12.APR.2020 16:40:36

Lowest Channel / FullRB

N/A

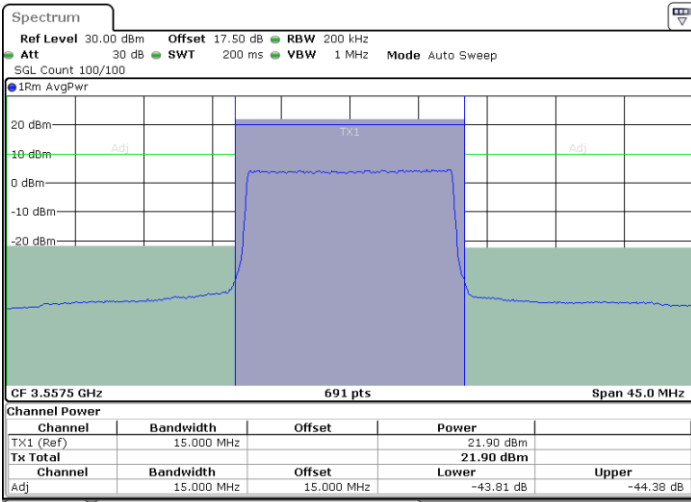

Date: 12.APR.2020 16:35:34



LTE Band 48 / 15MHz

QPSK

Middle Channel / 1RB0

Middle Channel / 1RBmax

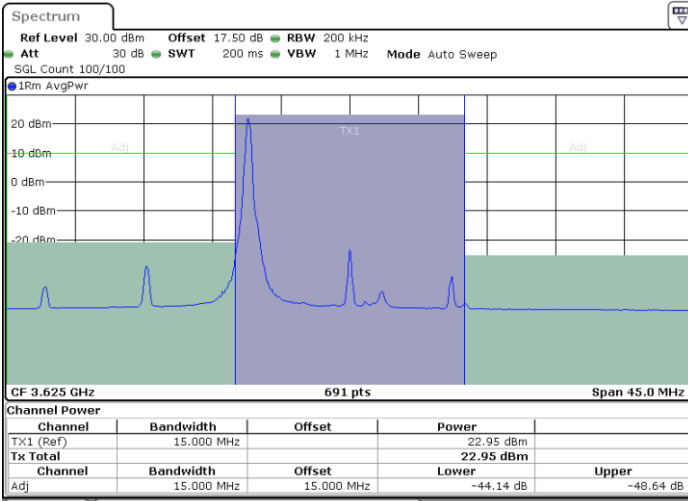

Date: 12.APR.2020 16:33:18

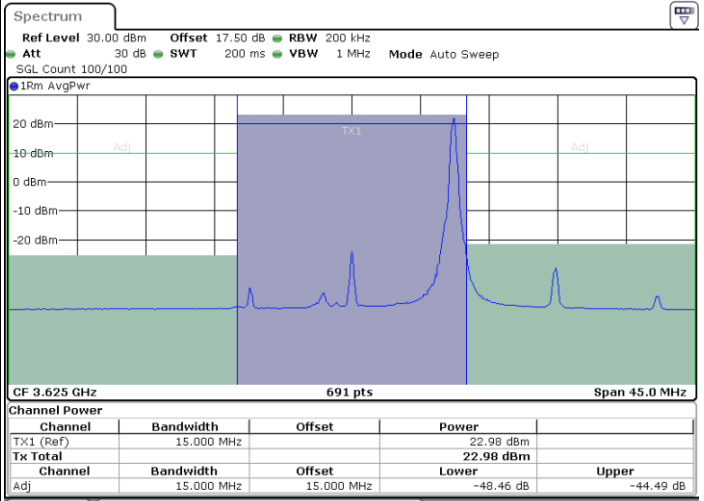

Date: 12.APR.2020 16:43:22

Middle Channel / FullRB

N/A

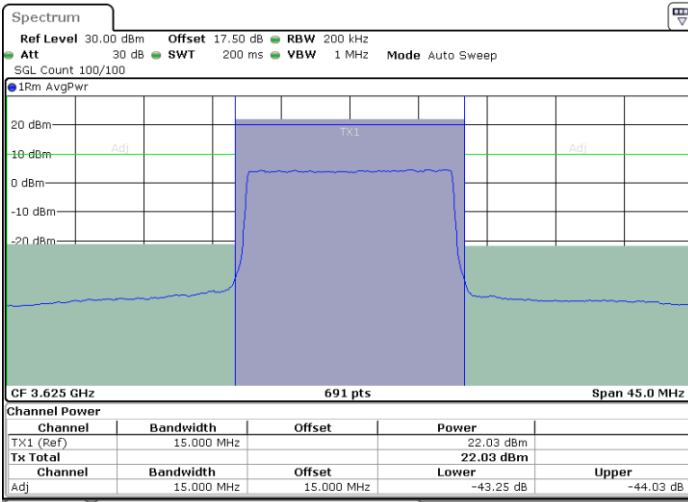

Date: 12.APR.2020 16:38:20



LTE Band 48 / 15MHz

QPSK

Highest Channel / 1RB0

Highest Channel / 1RBmax

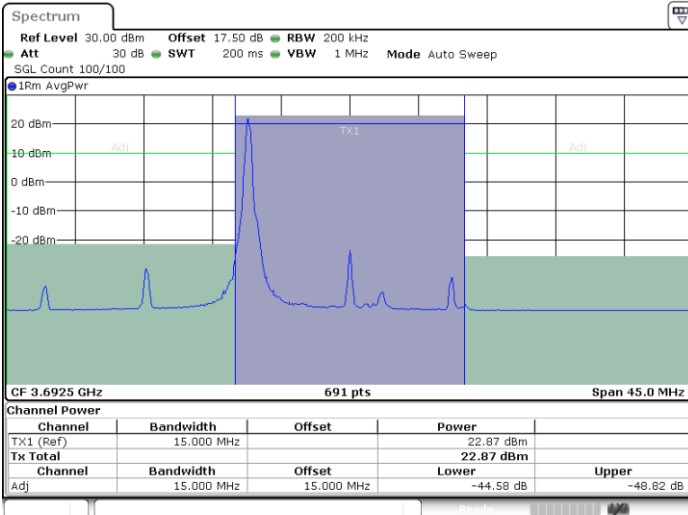

Date: 12.APR.2020 16:33:51

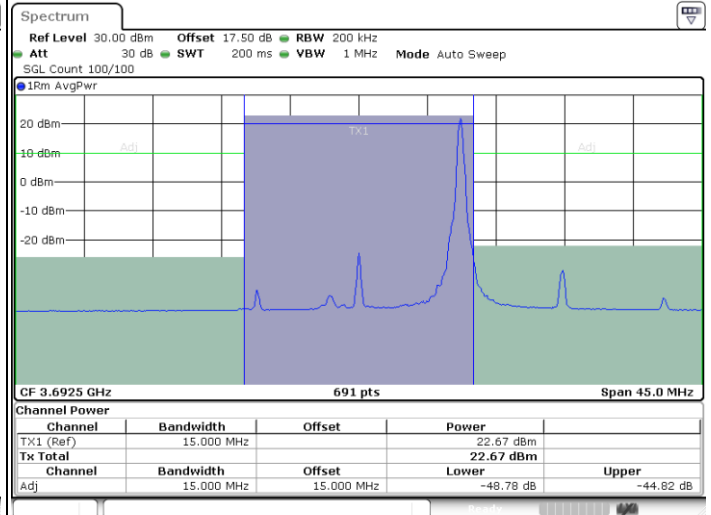

Date: 12.APR.2020 16:43:55

Highest Channel / FullRB

N/A

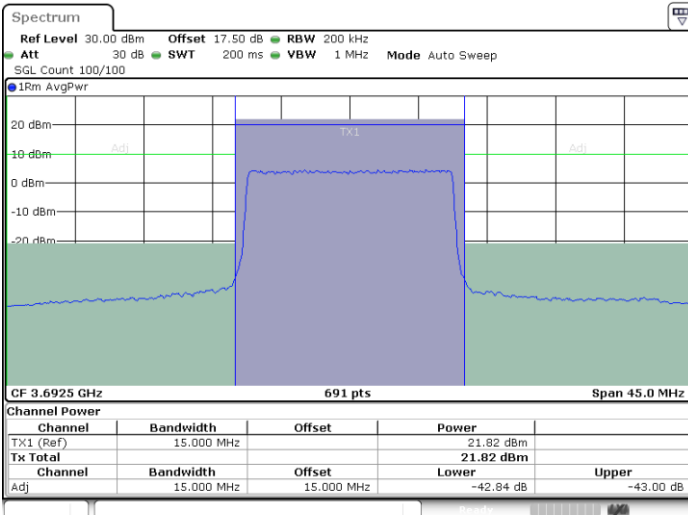

Date: 12.APR.2020 16:38:54



LTE Band 48 / 20MHz

QPSK

Lowest Channel / 1RB0

Lowest Channel / 1RBmax

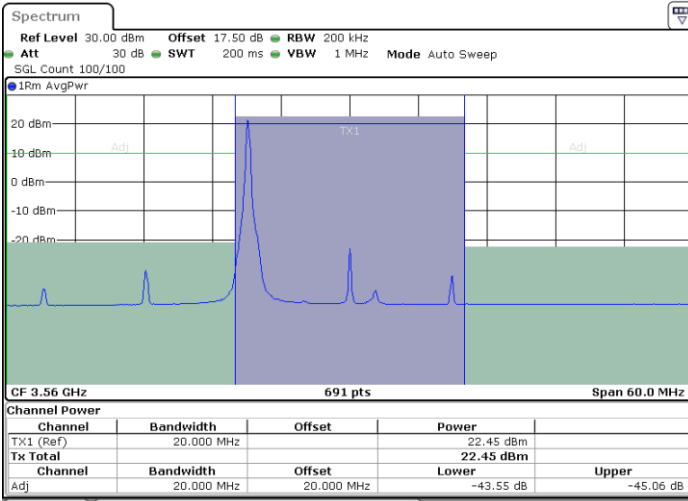

Date: 12.APR.2020 16:51:36

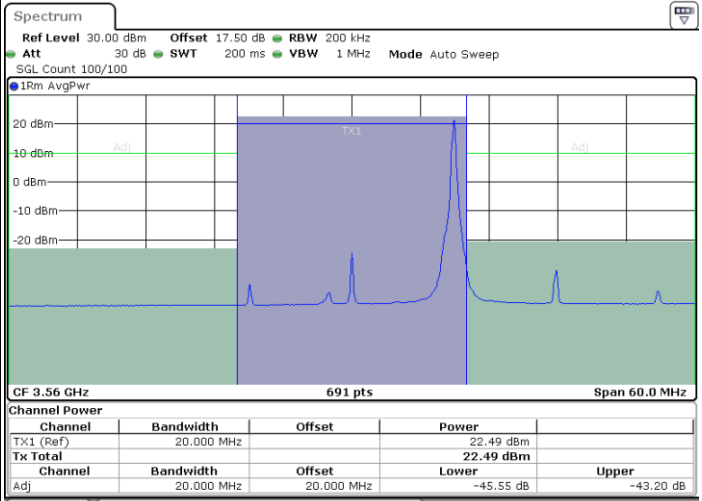

Date: 12.APR.2020 16:56:28

Lowest Channel / FullIRB

N/A

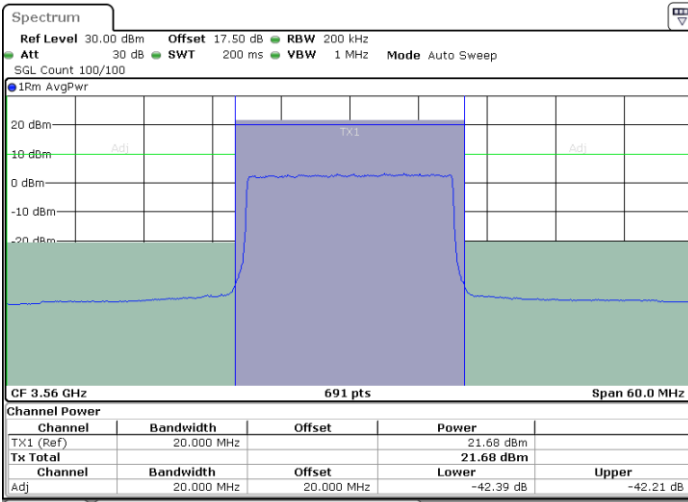

Date: 12.APR.2020 16:46:43



LTE Band 48 / 20MHz

QPSK

Middle Channel / 1RB0

Middle Channel / 1RBmax

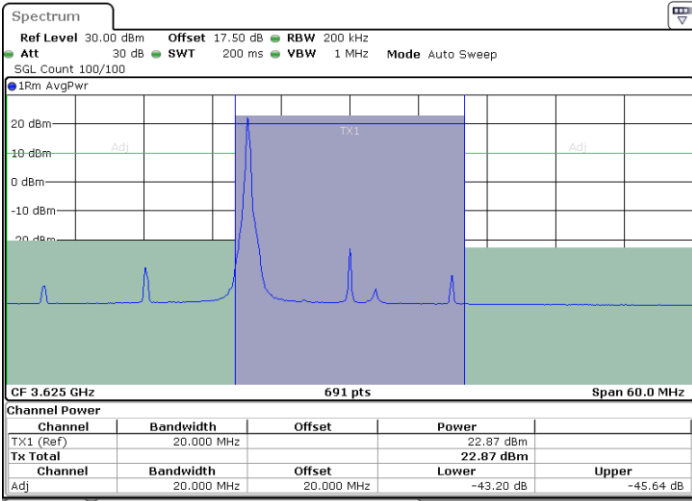

Date: 12.APR.2020 16:52:08

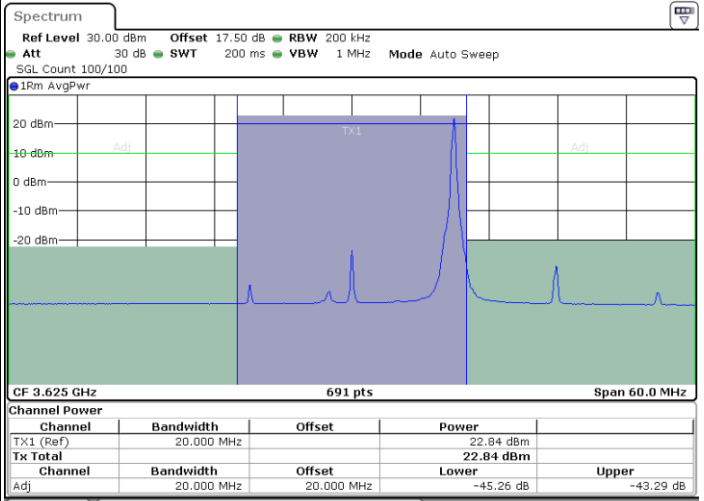

Date: 12.APR.2020 16:57:01

Middle Channel / FullRB

N/A

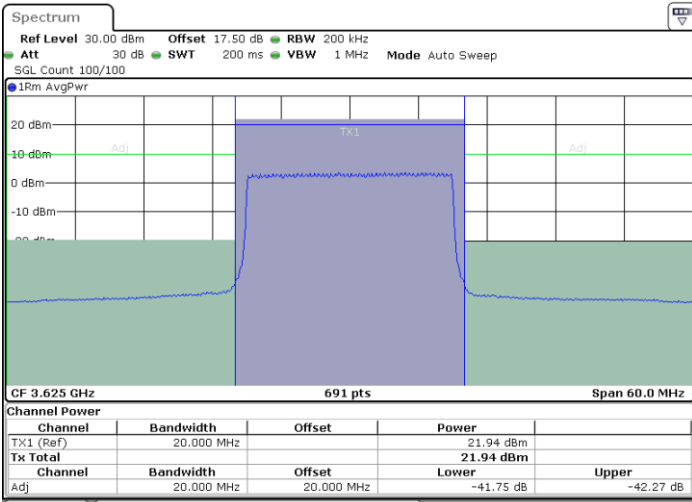

Date: 12.APR.2020 16:47:16



LTE Band 48 / 20MHz

QPSK

Highest Channel / 1RB0

Highest Channel / 1RBmax

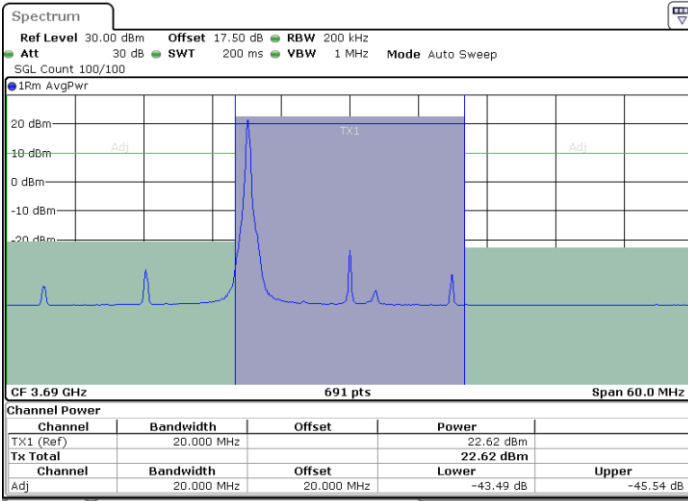

Date: 12.APR.2020 16:54:50

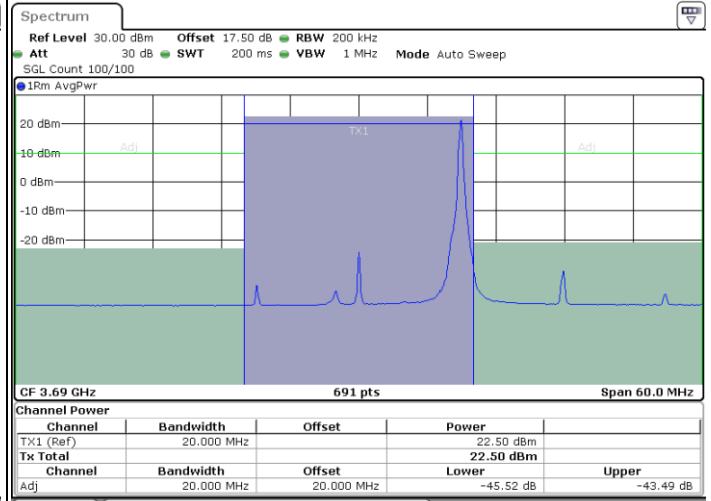

Date: 12.APR.2020 16:59:42

Highest Channel / FullIRB

N/A

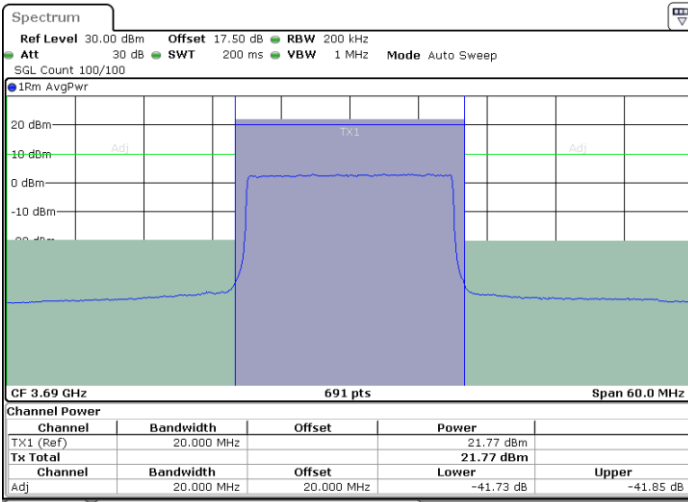

Date: 12.APR.2020 16:49:58



LTE Band 48 / 5MHz

16QAM

Lowest Channel / 1RB0

Lowest Channel / 1RBmax

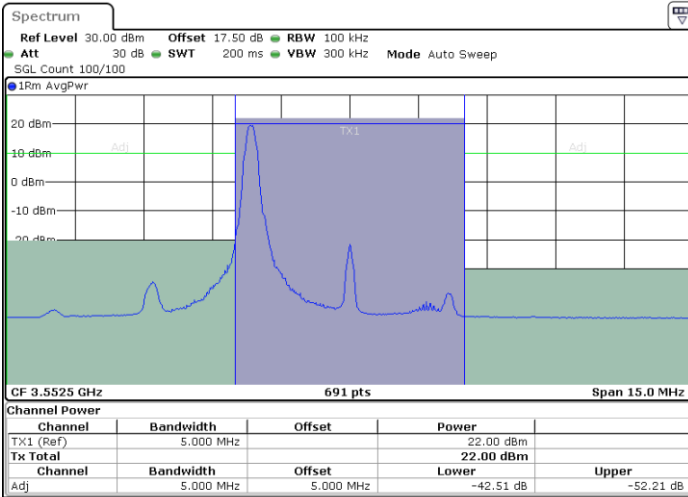

Date: 12.APR.2020 15:39:23

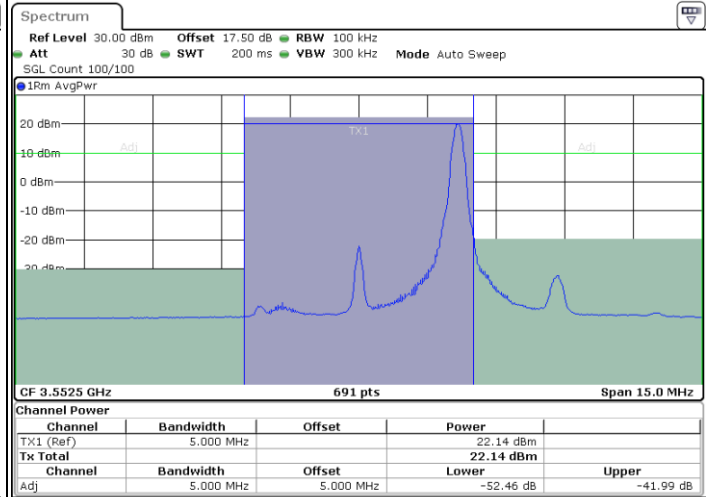

Date: 12.APR.2020 16:10:44

Lowest Channel / FullIRB

N/A

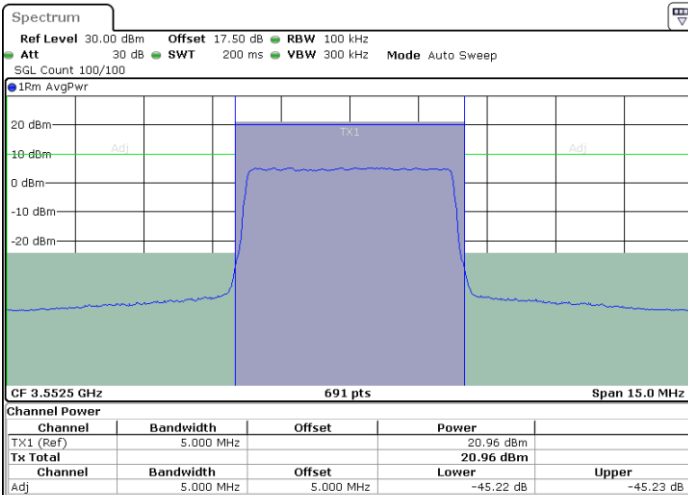

Date: 12.APR.2020 16:05:41



LTE Band 48 / 5MHz

16QAM

Middle Channel / 1RB0

Middle Channel / 1RBmax

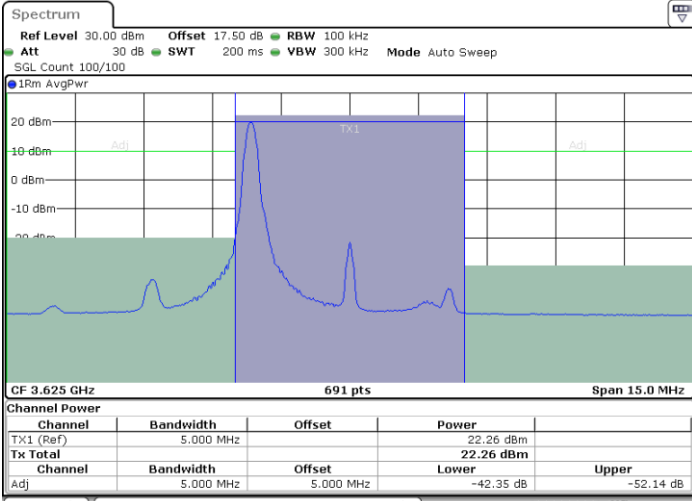

Date: 12.APR.2020 15:41:02

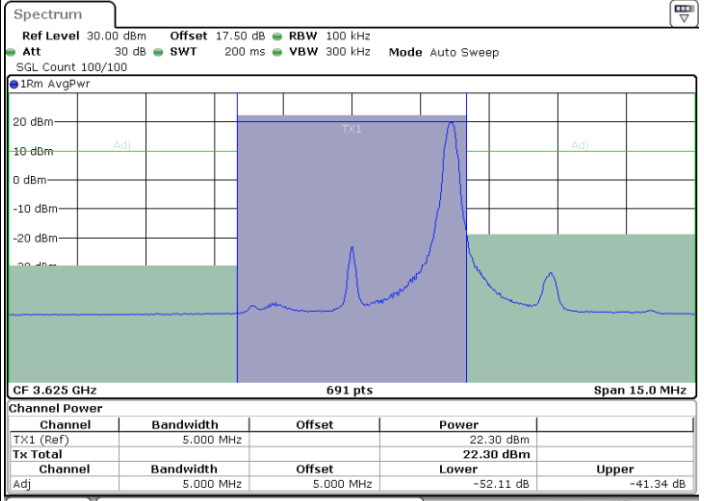

Date: 12.APR.2020 16:12:24

Middle Channel / FullRB

N/A

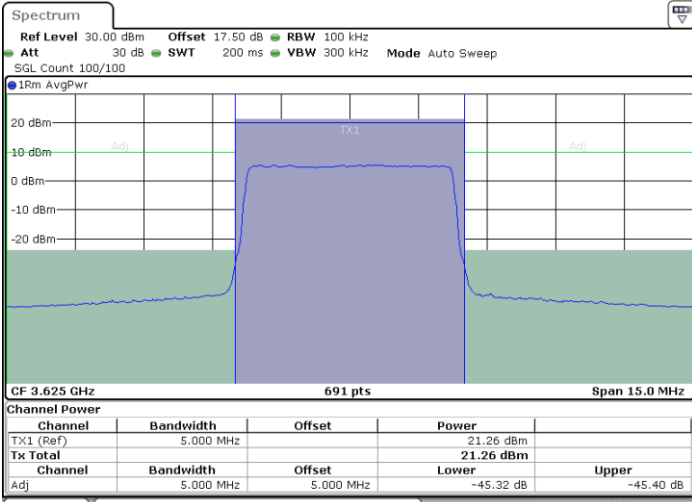

Date: 12.APR.2020 16:07:21



LTE Band 48 / 5MHz

16QAM

Highest Channel / 1RB0

Highest Channel / 1RBmax

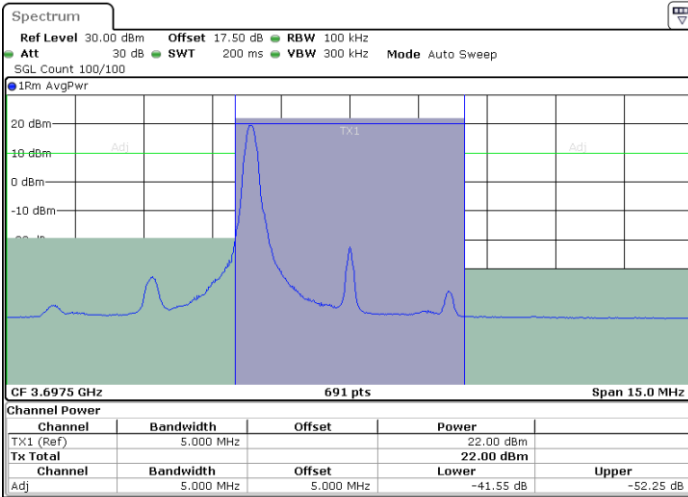

Date: 12.APR.2020 15:43:20

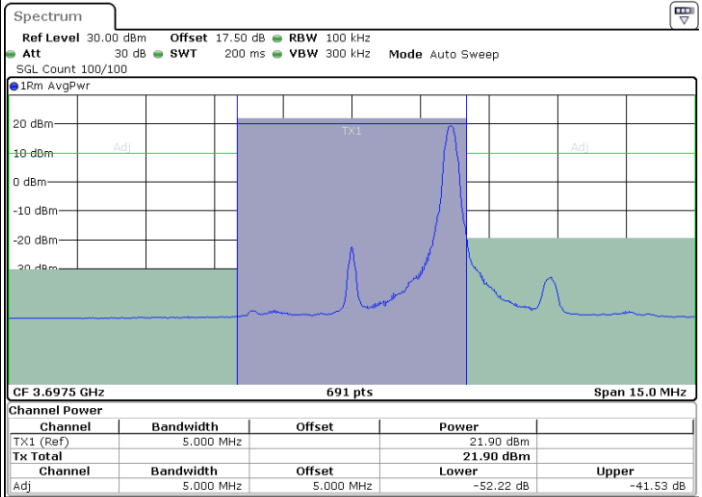

Date: 12.APR.2020 16:14:05

Highest Channel / FullIRB

N/A

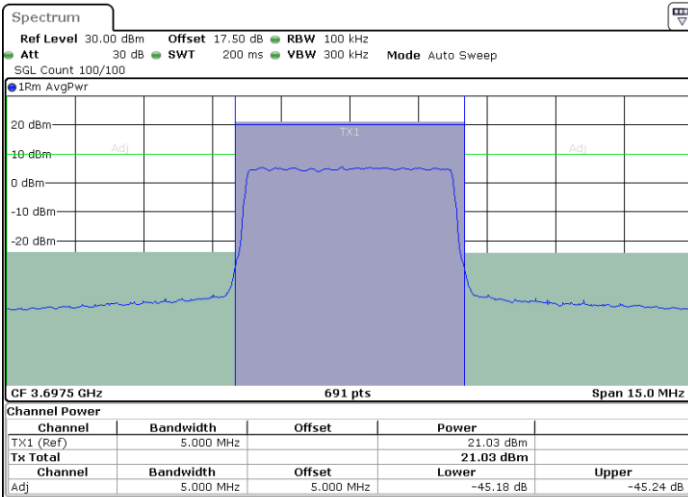

Date: 12.APR.2020 16:09:03



LTE Band 48 / 10MHz

16QAM

Lowest Channel / 1RB0

Lowest Channel / 1RBmax

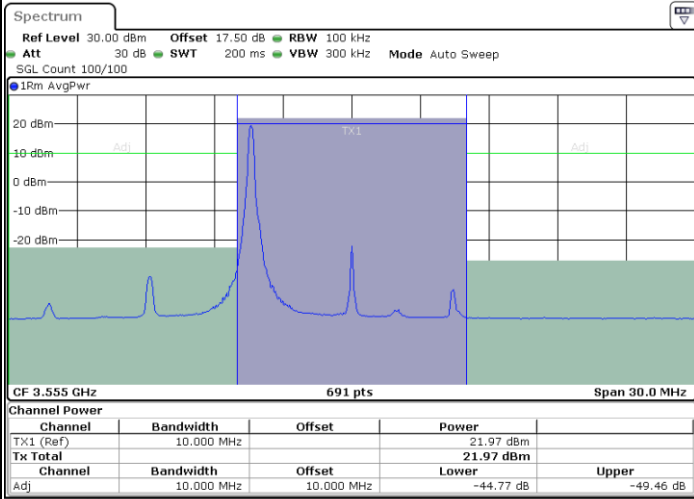

Date: 12.APR.2020 16:15:52

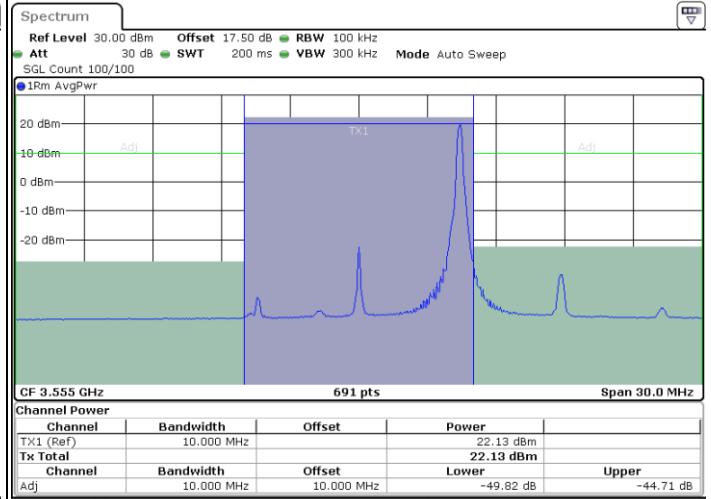

Date: 12.APR.2020 16:26:01

Lowest Channel / FullIRB

N/A

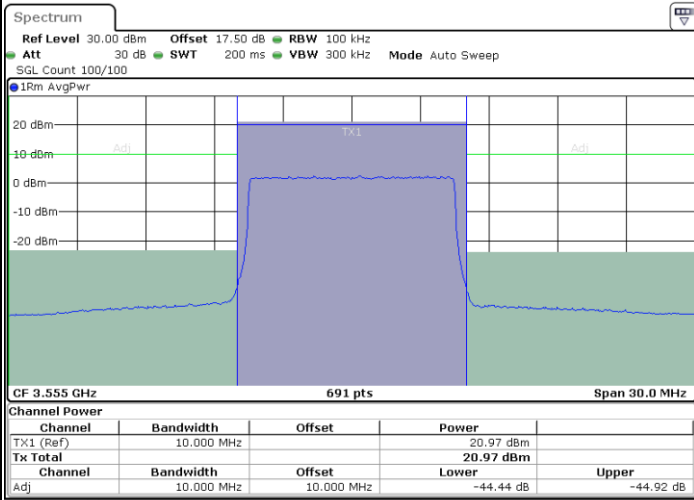

Date: 12.APR.2020 16:20:57



LTE Band 48 / 10MHz

16QAM

MiddleChannel / 1RB0

Middle Channel / 1RBmax

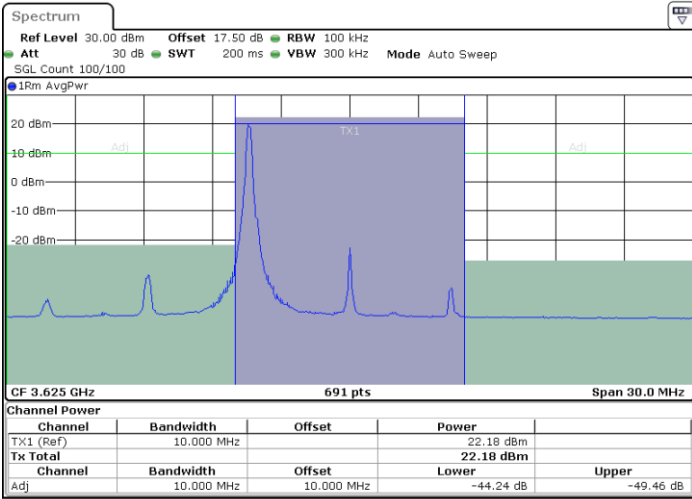

Date: 12.APR.2020 16:17:33

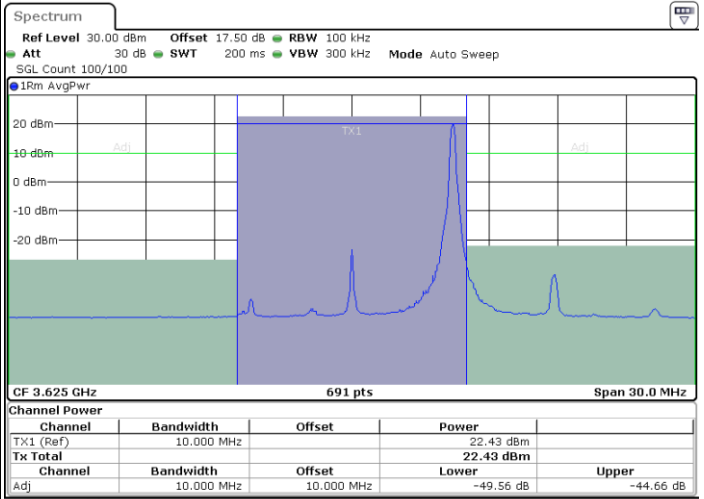

Date: 12.APR.2020 16:27:41

Middle Channel / FullIRB

N/A

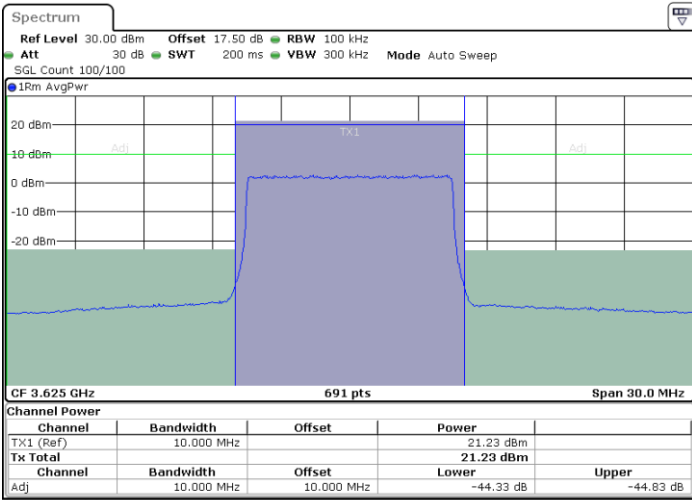

Date: 12.APR.2020 16:22:37



LTE Band 48 / 10MHz

16QAM

Highest Channel / 1RB0

Highest Channel / 1RBmax

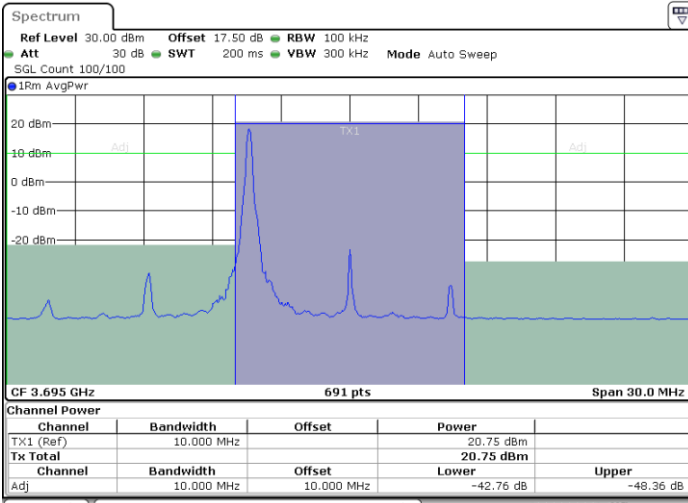

Date: 12.APR.2020 16:19:15

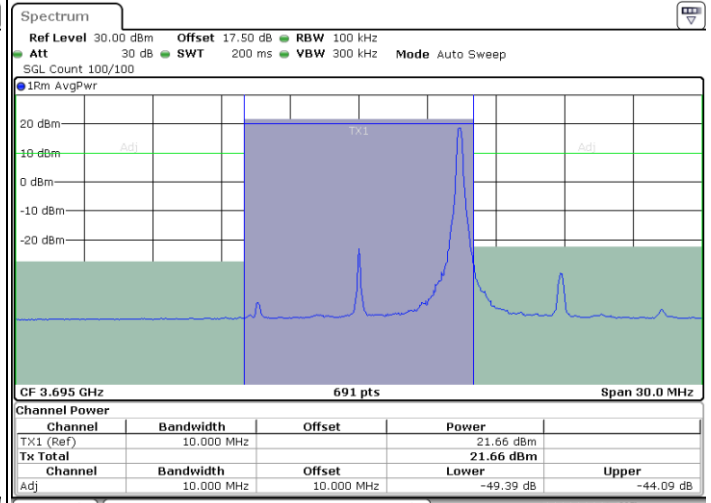

Date: 12.APR.2020 16:29:22

Highest Channel / FullIRB

N/A

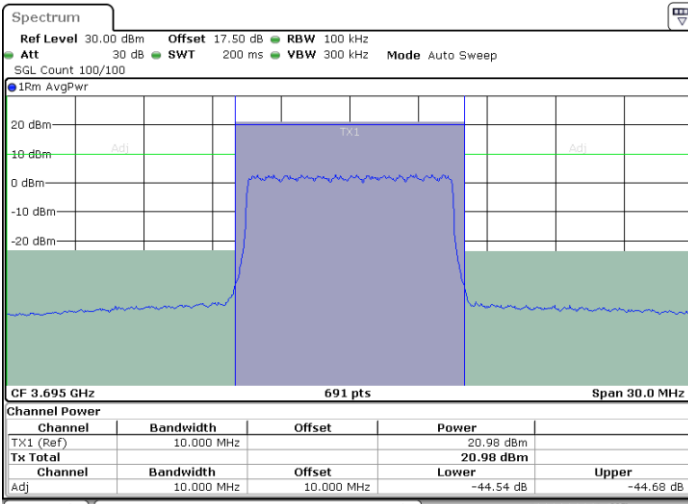

Date: 12.APR.2020 16:24:19



LTE Band 48 / 15MHz

16QAM

Lowest Channel / 1RB0

Lowest Channel / 1RBmax

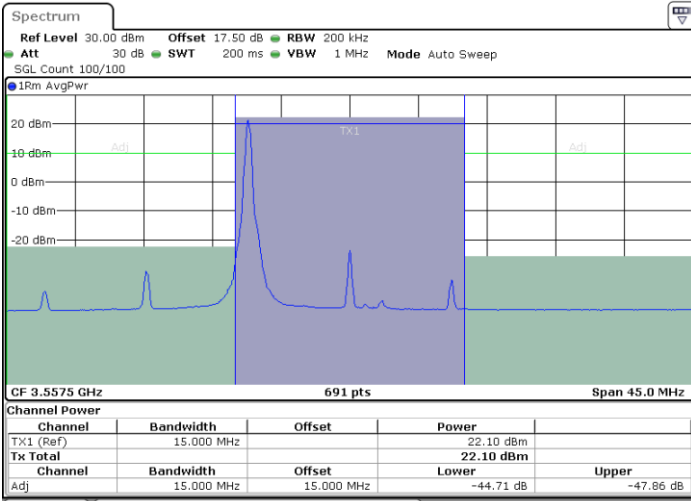

Date: 12.APR.2020 16:31:05

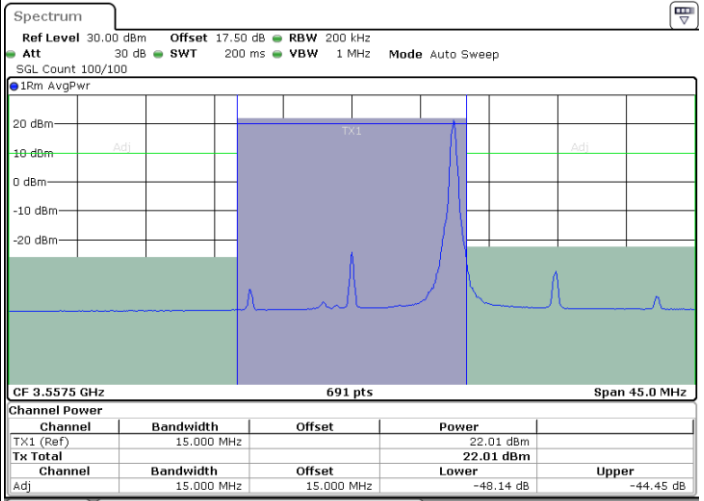

Date: 12.APR.2020 16:41:09

Lowest Channel / FullIRB

N/A

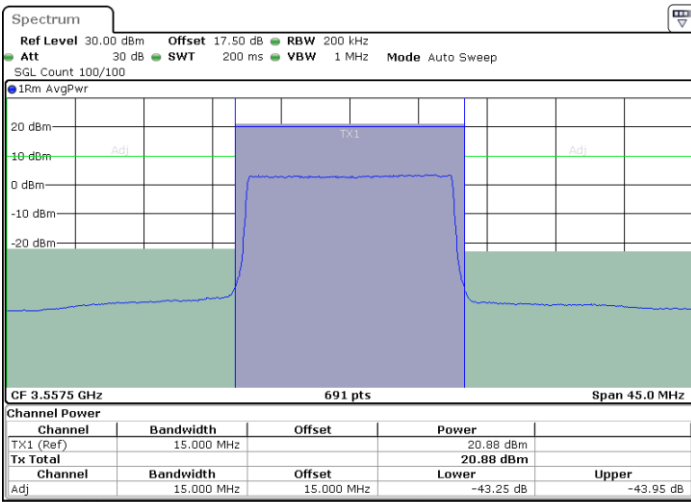

Date: 12.APR.2020 16:36:08



LTE Band 48 / 15MHz

16QAM

Middle Channel / 1RB0

Middle Channel / 1RBmax

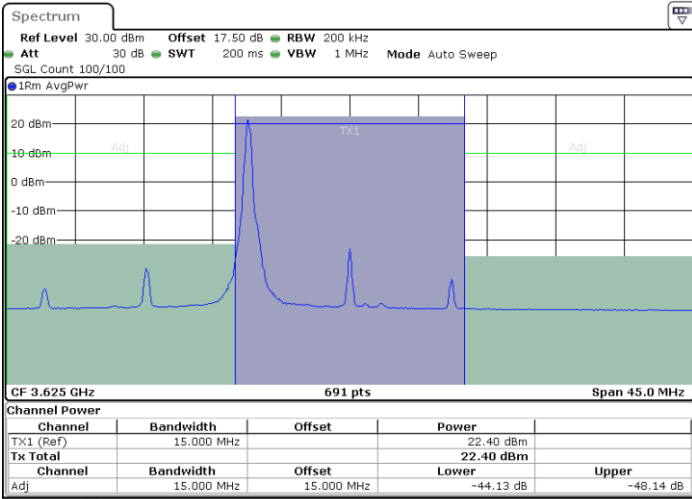

Date: 12.APR.2020 16:32:45

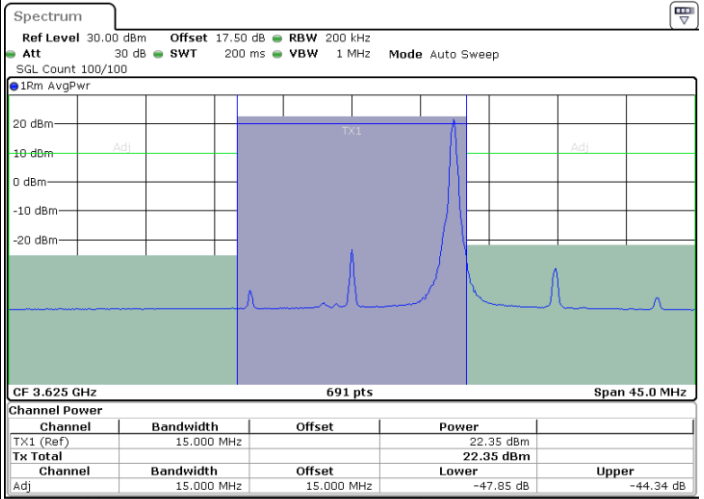

Date: 12.APR.2020 16:42:49

Middle Channel / FullRB

N/A

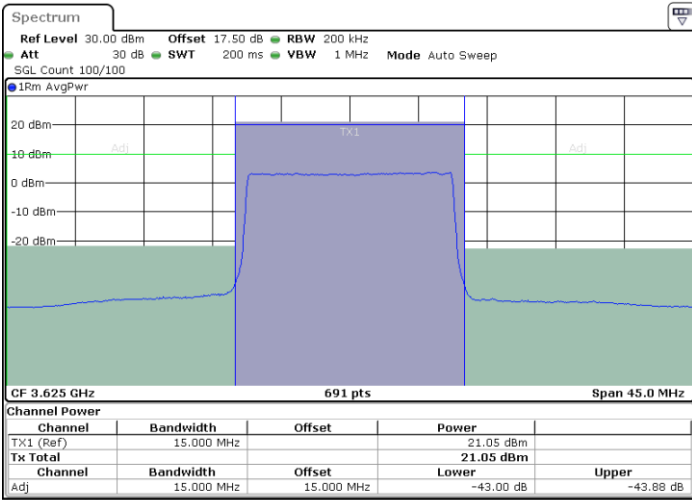

Date: 12.APR.2020 16:37:47



LTE Band 48 / 15MHz

16QAM

Highest Channel / 1RB0

Highest Channel / 1RBmax

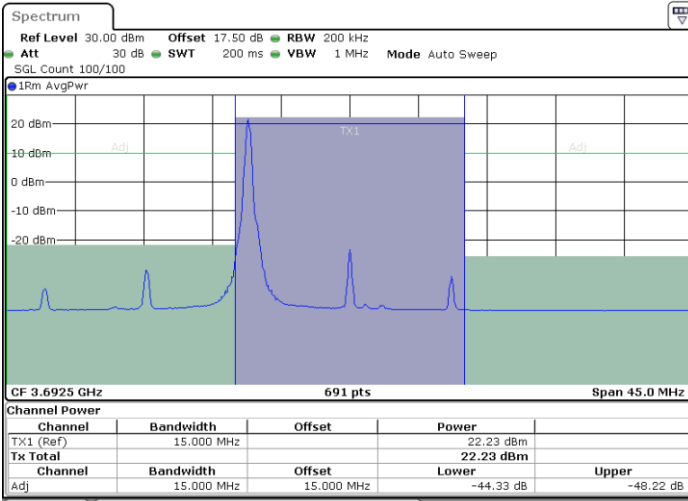

Date: 12.APR.2020 16:34:26

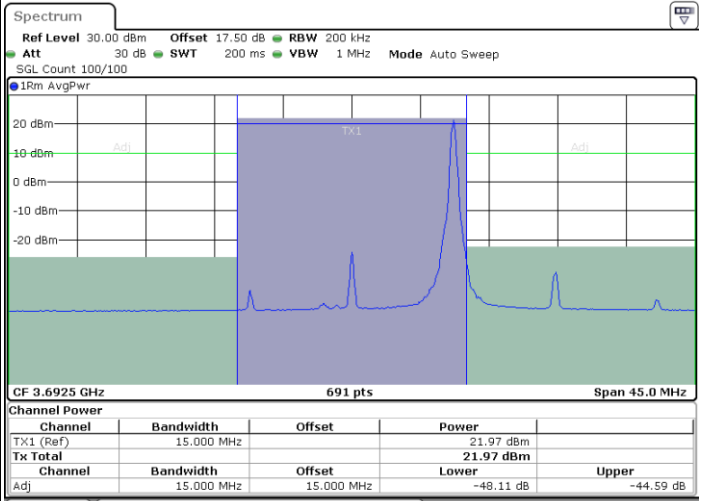

Date: 12.APR.2020 16:44:30

Highest Channel / FullIRB

N/A

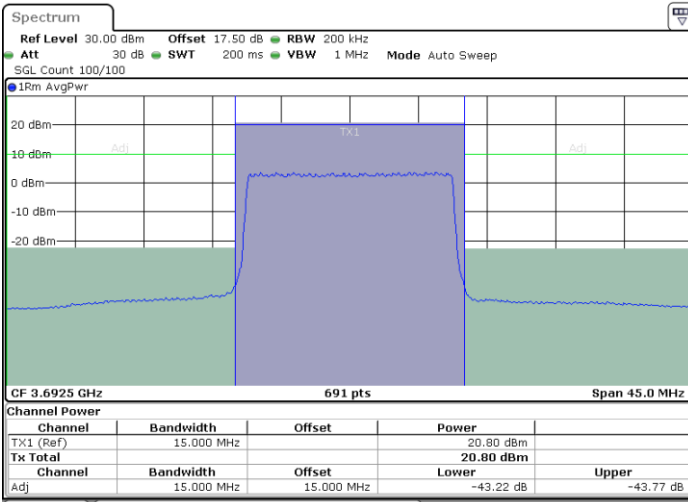

Date: 12.APR.2020 16:39:28



LTE Band 48 / 20MHz

16QAM

Lowest Channel / 1RB0

Lowest Channel / 1RBmax

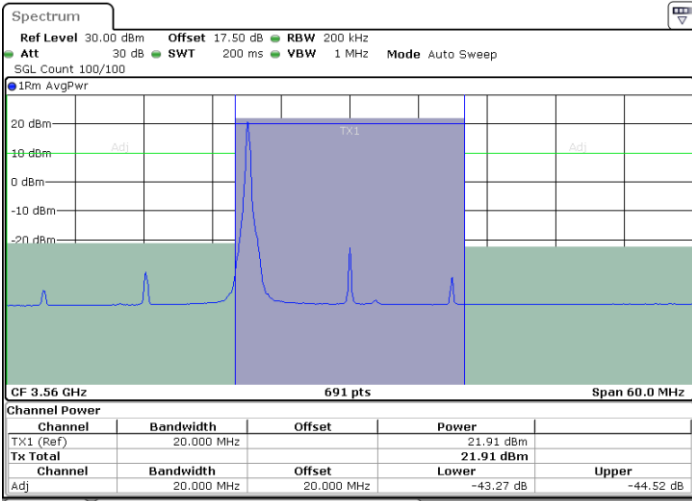

Date: 12.APR.2020 16:51:03

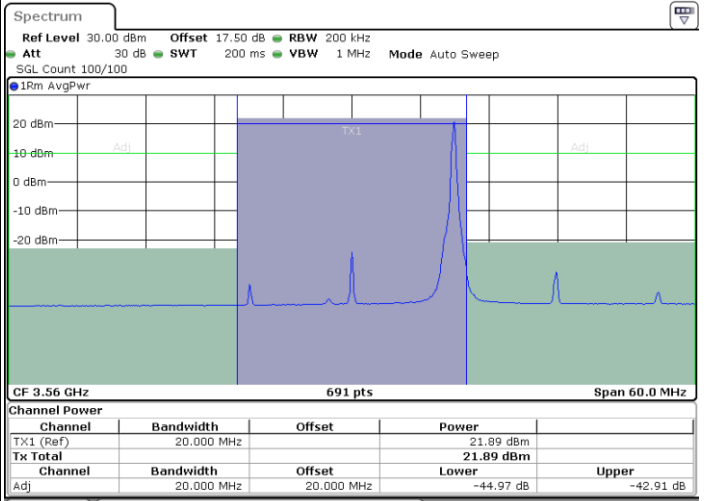

Date: 12.APR.2020 16:55:56

Lowest Channel / FullIRB

N/A

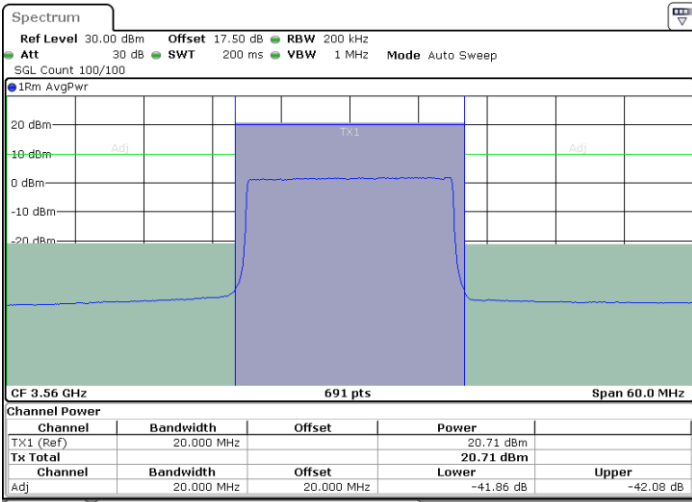

Date: 12.APR.2020 16:46:11



LTE Band 48 / 20MHz

16QAM

Middle Channel / 1RB0

Middle Channel / 1RBmax

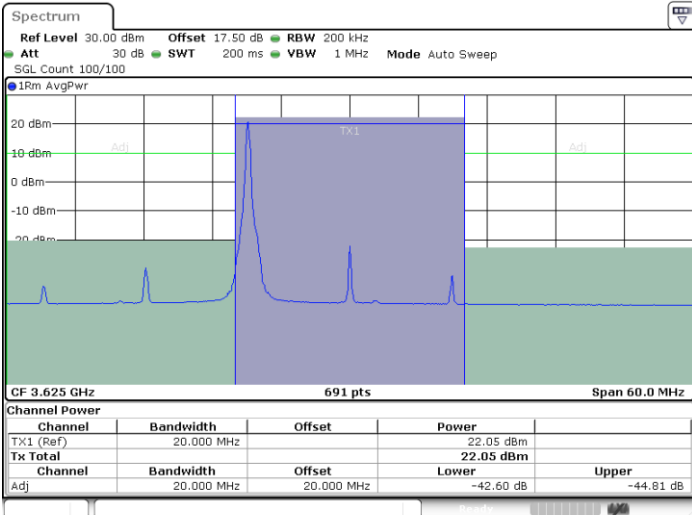

Date: 12.APR.2020 16:52:40

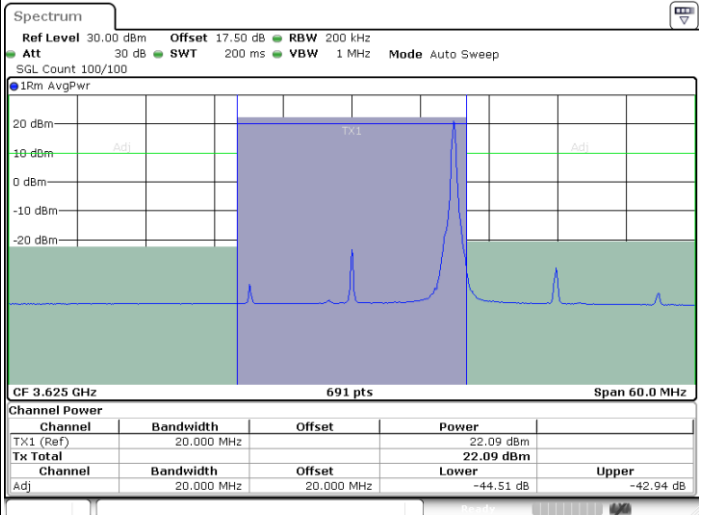

Date: 12.APR.2020 16:57:33

Middle Channel / FullIRB

N/A

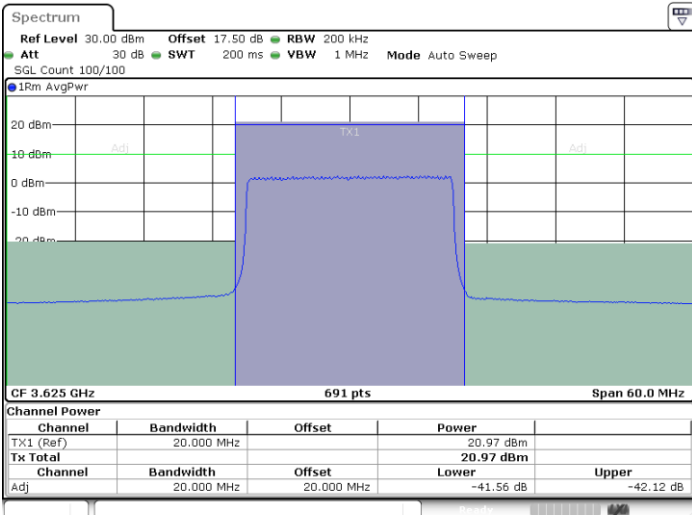

Date: 12.APR.2020 16:47:48



LTE Band 48 / 20MHz

16QAM

Highest Channel / 1RB0

Highest Channel / 1RBmax

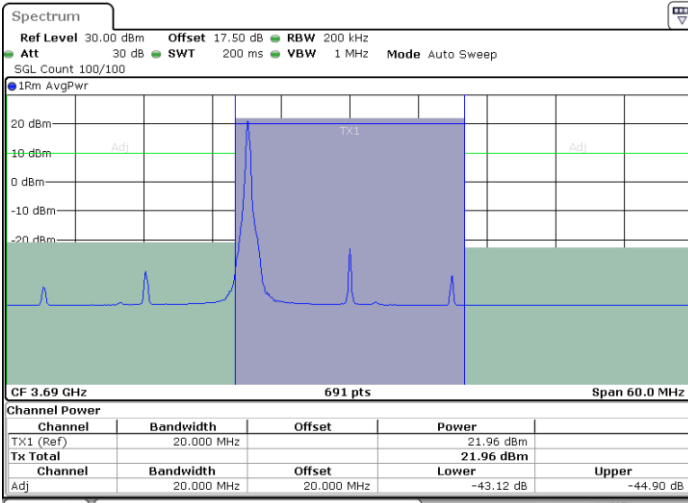

Date: 12.APR.2020 16:54:18

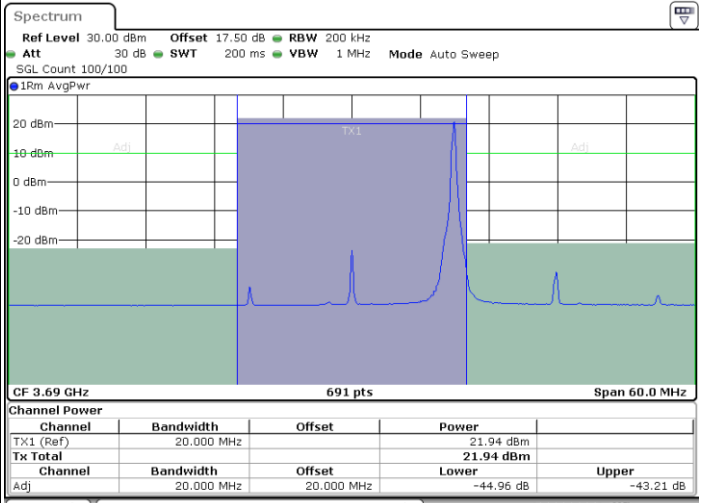

Date: 12.APR.2020 16:59:10

Highest Channel / FullIRB

N/A

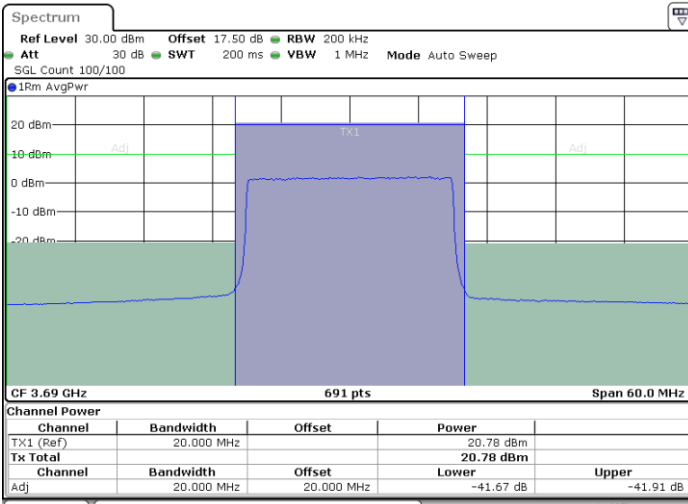

Date: 12.APR.2020 16:49:25



LTE Band 48 / 5MHz

64QAM

Lowest Channel / 1RB0

Lowest Channel / 1RBmax

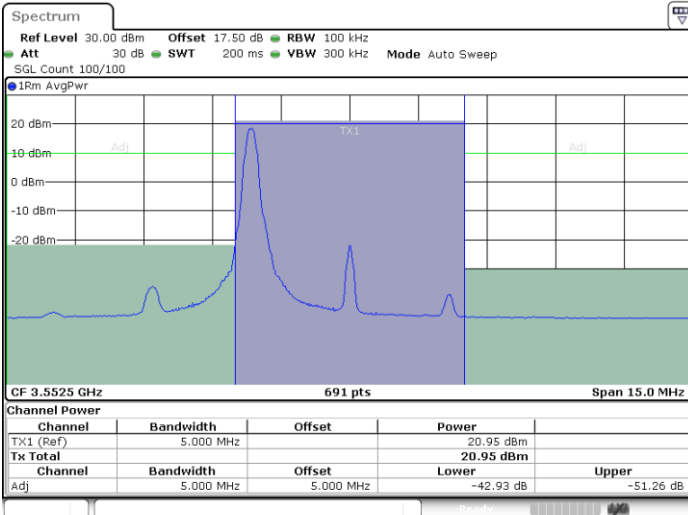

Date: 12.APR.2020 15:39:57

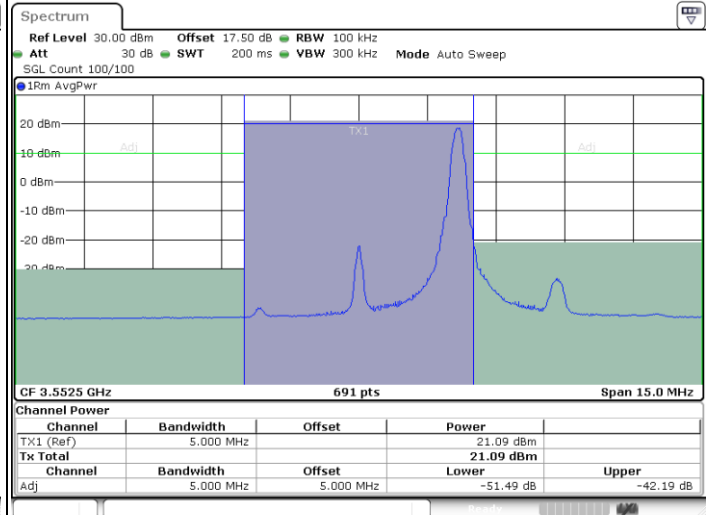

Date: 12.APR.2020 16:11:18

Lowest Channel / FullIRB

N/A

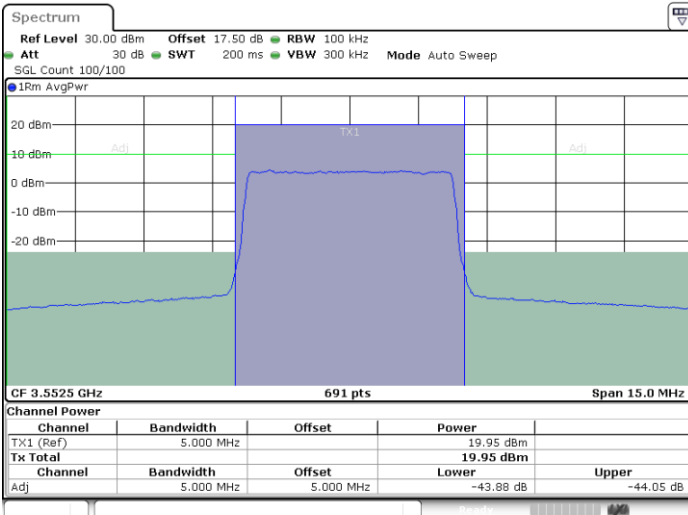

Date: 12.APR.2020 16:06:15



LTE Band 48 / 5MHz

64QAM

Middle Channel / 1RB0

Middle Channel / 1RBmax

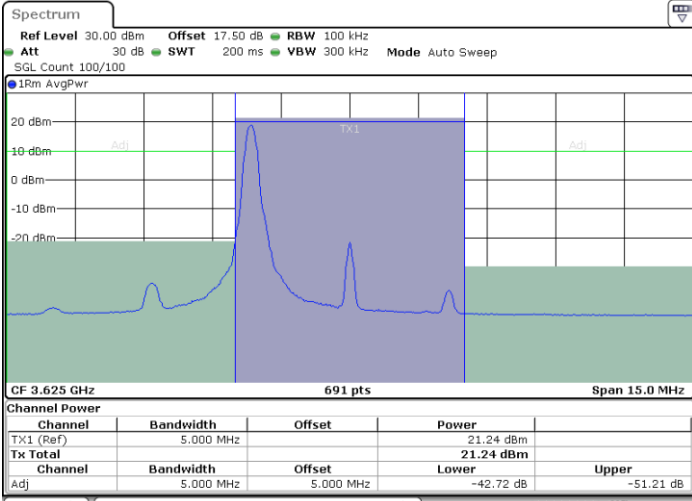

Date: 12.APR.2020 15:40:29

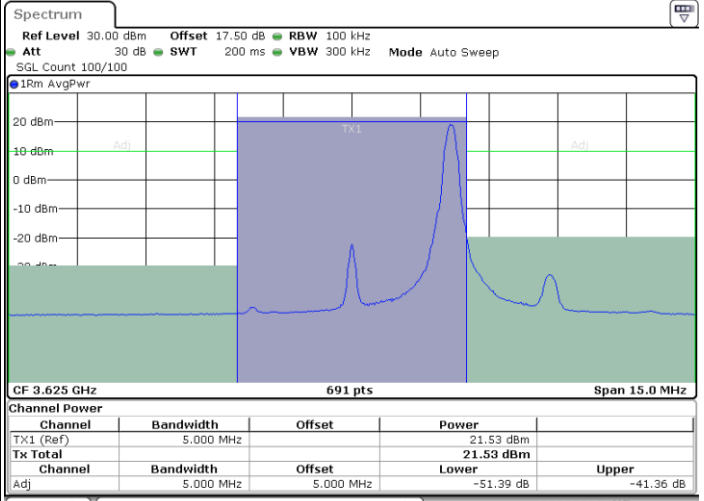

Date: 12.APR.2020 16:11:51

Middle Channel / FullRB

N/A

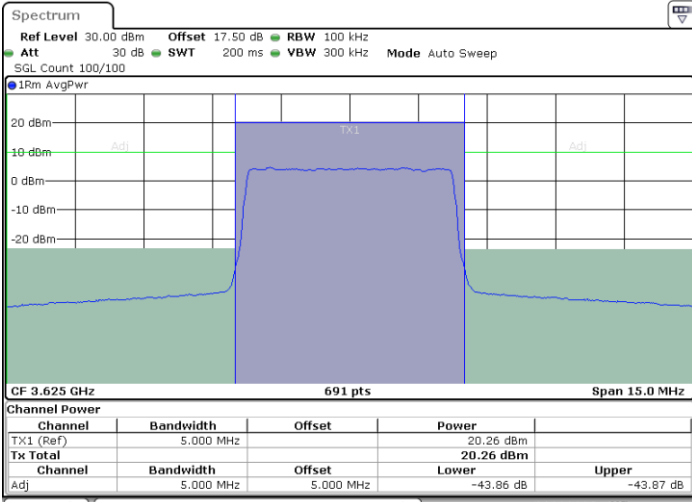

Date: 12.APR.2020 16:06:48



LTE Band 48 / 5MHz

64QAM

Highest Channel / 1RB0

Highest Channel / 1RBmax

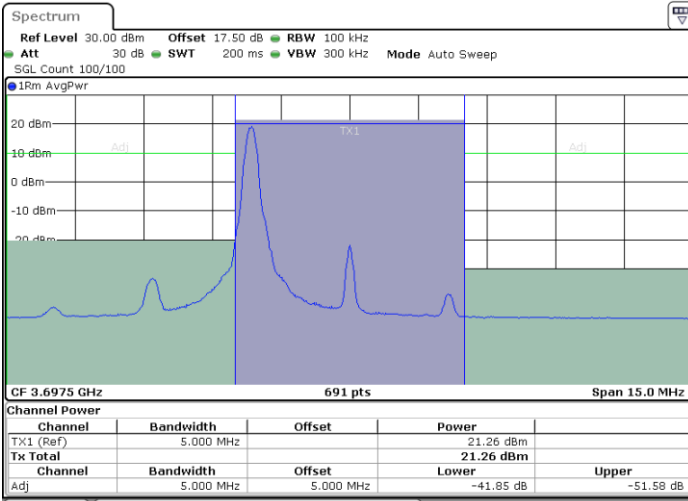

Date: 12.APR.2020 15:43:56

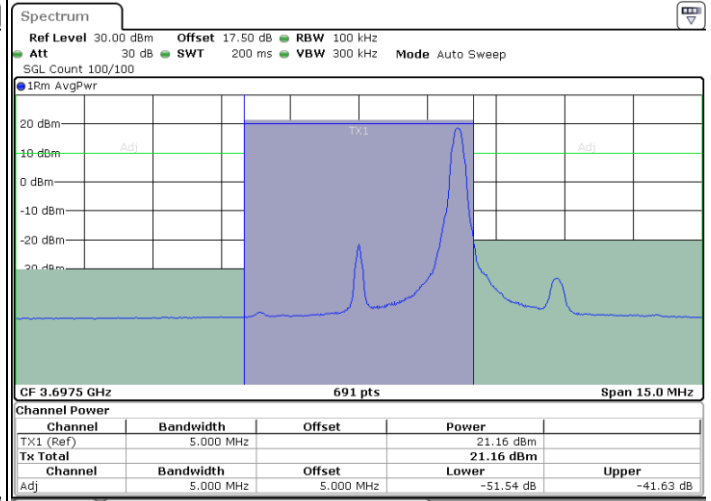

Date: 12.APR.2020 16:14:40

Highest Channel / FullIRB

N/A

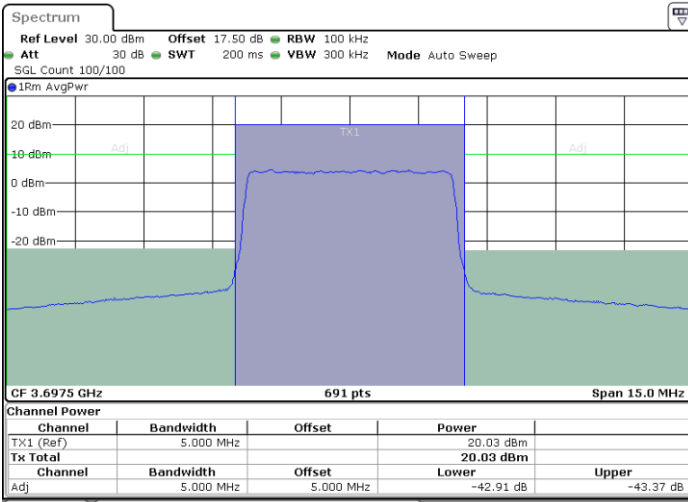

Date: 12.APR.2020 16:09:37