



FCC RADIO TEST REPORT

FCC ID : N7NEM75T
Equipment : Radio Module
Brand Name : AirPrime
Model Name : EM7590
Applicant : Sierra Wireless, Inc.
13811 Wireless Way, Richmond, BC V6V 3A4 Canada
Manufacturer : Sierra Wireless, Inc.
13811 Wireless Way, Richmond, BC V6V 3A4 Canada
Standard : FCC 47 CFR Part 2, 22(H), 24(E), 27

The product was received on Apr. 25, 2022 and testing was performed from Apr. 27, 2022 to Jul. 21, 2022. We, Sporton International Inc. EMC & Wireless Communications Laboratory, would like to declare that the tested sample has been evaluated in accordance with the test procedures given in ANSI / TIA-603-E and has been in compliance with the applicable technical standards.

The test results in this report apply exclusively to the tested model / sample. Without written approval from Sporton International Inc. EMC & Wireless Communications Laboratory, the test report shall not be reproduced except in full.

Louis Wu

Approved by: Louis Wu

Sporton International Inc. EMC & Wireless Communications Laboratory

No. 52, Huaya 1st Rd., Guishan Dist., Taoyuan City 333, Taiwan (R.O.C.)



Table of Contents

History of this test report	3
Summary of Test Result	4
1 General Description	5
1.1 Product Feature of Equipment Under Test	5
1.2 Modification of EUT	5
1.3 Testing Location	5
1.4 Applicable Standards	5
2 Test Configuration of Equipment Under Test	6
2.1 Test Mode	6
2.2 Connection Diagram of Test System	10
2.3 Support Unit used in test configuration and system	11
2.4 Measurement Results Explanation Example	11
2.5 Frequency List of Low/Middle/High Channels	12
3 Conducted Test Items	21
3.1 Measuring Instruments	21
3.2 Conducted Output Power	22
3.3 Peak-to-Average Ratio	23
3.4 Occupied Bandwidth	24
3.5 Conducted Band Edge	25
3.6 Conducted Spurious Emission	27
3.7 Frequency Stability.....	28
4 Radiated Test Items	29
4.1 Measuring Instruments	29
4.2 Radiated Spurious Emission Measurement	31
5 List of Measuring Equipment	32
6 Uncertainty of Evaluation	34
Appendix A. Test Results of Conducted Test	
Appendix B. Test Results of Radiated Test	
Appendix C. Test Setup Photographs	



History of this test report

Report No.	Version	Description	Issue Date
FG242018B	01	Initial issue of report	Aug. 09, 2022



Summary of Test Result

Report Clause	Ref Std. Clause	Test Items	Result (PASS/FAIL)	Remark
3.2	§2.1046	Conducted Output Power	Reporting only	-
3.3	§24.232 (d) §27.50 (d)(5)	Peak-to-Average Ratio	Pass	-
3.4	§2.1049	Occupied Bandwidth	Reporting only	-
3.5	§2.1051 §22.917 (a) §24.238 (a) §27.53 (c)(2)(4) §27.53 (g) §27.53 (h)	Conducted Band Edge Measurement (Band 2) (Band 4) (Band 5) (Band 12) (Band 13) (Band 25) (Band 26) (Band 66) (Band 71)	Pass	-
	§2.1051 §27.53 (m)(4)	Conducted Band Edge Measurement (Band 7) (Band 41)		
3.6	§2.1051 §22.917 (a) §24.238 (a) §27.53 (c)(2) §27.53 (g) §27.53 (h)	Conducted Spurious Emission (Band 2) (Band 4) (Band 5) (Band 12) (Band 13) (Band 25) (Band 26) (Band 66) (Band 71)	Pass	-
	§2.1051 §27.53 (m)(4)	Conducted Spurious Emission (Band 7) (Band 41)		
3.7	§2.1055 §22.355 §24.235 §27.54	Frequency Stability Temperature & Voltage	Pass	-
4.2	§2.1053 §22.917 (a) §24.238 (a) §27.53 (c)(2) §27.53 (f) §27.53 (g) §27.53 (h)	Radiated Spurious Emission (Band 2) (Band 4) (Band 5) (Band 12) (Band 13) (Band 25) (Band 26) (Band 66) (Band 71)	Pass	22.02 dB under the limit at 1564.000 MHz
	§2.1051 §27.53 (m)(4)	Radiated Spurious Emission (Band 7) (Band 41)		

Declaration of Conformity:

- The test results (PASS/FAIL) with all measurement uncertainty excluded are presented in accordance with the regulation limits or requirements declared by manufacturers.
It's means measurement values may risk exceeding the limit of regulation standards, if measurement uncertainty is include in test results.
- The measurement uncertainty please refer to report "Uncertainty of Evaluation".

Comments and Explanations:

The product specifications of the EUT presented in the report are declared by the manufacturer who shall take full responsibility for the authenticity.

Reviewed by: Avis Chuang**Report Producer: Lucy Wu**



1 General Description

1.1 Product Feature of Equipment Under Test

WCDMA/LTE, and GNSS.

Remark:

1. The EUT's information above is declared by manufacturer. Please refer to Comments and Explanations in report summary.
2. Maximum allow antenna Gain : refer MPE Report FA242018.

1.2 Modification of EUT

No modifications are made to the EUT during all test items.

1.3 Testing Location

Test Site	Sporton International Inc. EMC & Wireless Communications Laboratory	
Test Site Location	No.52, Huaya 1st Rd., Guishan Dist., Taoyuan City 333, Taiwan (R.O.C.) TEL: +886-3-327-3456 FAX: +886-3-328-4978	
Test Site No.	Sporton Site No.	
	TH03-HY	03CH07-HY
Test Engineer	George Chen	Jesse Wang, Stan Hsieh and Ken Wu
Temperature (°C)	22.8~24.3	23.6~25.7
Relative Humidity (%)	51.8~56.4	56.3~62.5

Note: The test site complies with ANSI C63.4 2014 requirement.

FCC Designation No.: TW1190

1.4 Applicable Standards

According to the specifications of the manufacturer, the EUT must comply with the requirements of the following standards:

- ♦ ANSI C63.26-2015
- ♦ ANSI / TIA-603-E
- ♦ FCC 47 CFR Part 2, 22(H), 24(E), 27
- ♦ FCC KDB 971168 D01 Power Meas. License Digital Systems v03r01
- ♦ FCC KDB 414788 D01 Radiated Test Site v01r01.

Remark:

1. All test items were verified and recorded according to the standards and without any deviation during the test.
2. The TAF code is not including all the FCC KDB listed without accreditation.



2 Test Configuration of Equipment Under Test

2.1 Test Mode

Antenna port conducted and radiated test items listed below are performed according to KDB 971168 D01 Power Meas. License Digital Systems v03r01 with maximum output power.

For radiated measurement, the measured emission level of the EUT was maximized by rotating the EUT on a turntable, adjusting the orientation of the EUT and EUT antenna in two angle (Ant. Horizontal and Ant. Vertical), and adjusting the measurement antenna orientation, following C63.26 exploratory test procedures and find Ant. Horizontal for LTE Band 7C; Ant. Horizontal for LTE Band 5B, 7, 12, 13, 25, 26, 41, 41C, 66, 71 as worst plane.

Test Items	Band	Bandwidth (MHz)						Modulation				RB #			Test Channel		
		1.4	3	5	10	15	20	QPSK	16QAM	64QAM	256QAM	1	Half	Full	L	M	H
Max. Output Power	2	v	v	v	v	v	v	v	v	v	-	v	v	v	v	v	v
	4	v	v	v	v	v	v	v	v	v	-	v	v	v	v	v	v
	5	v	v	v	v	-	-	v	v	v	-	v	v	v	v	v	v
	7	-	-	v	v	v	v	v	v	v	-	v	v	v	v	v	v
	12	v	v	v	v	-	-	v	v	v	-	v	v	v	v	v	v
	13	-	-	v	v	-	-	v	v	v	-	v	v	v	v	v	v
	25	v	v	v	v	v	v	v	v	v	-	v	v	v	v	v	v
	26	v	v	v	v	v	-	v	v	v	-	v	v	v	v	v	v
	41	-	-	v	v	v	v	v	v	v	-	v	v	v	v	v	v
	66	v	v	v	v	v	v	v	v	v	-	v	v	v	v	v	v
71	-	-	v	v	v	v	v	v	v	-	v	v	v	v	v	v	
Peak-to-Average Ratio	2	Covered by Band 25															
	4	Covered by Band 66															
	5	Covered by Band 26															
	7	-	-				v	v	v	v	-			v		v	
	12				v	-	-	v	v	v	-			v		v	
	13	-	-		v	-	-	v	v	v	-			v		v	
	25						v	v	v	v	-			v		v	
	26					v	-	v	v	v	-			v		v	
	41	-	-				v	v	v	v	-			v		v	
	66						v	v	v	v	-			v		v	
71						v	v	v	v	-			v		v		



Test Items	Band	Bandwidth (MHz)						Modulation				RB #			Test Channel			
		1.4	3	5	10	15	20	QPSK	16QAM	64QAM	256QAM	1	Half	Full	L	M	H	
26dB and 99% Bandwidth	2	Covered by Band 25																
	4	Covered by Band 66																
	5	Covered by Band 26																
	7	-	-	v	v	v	v	v	v	v	v	-			v		v	
	12	v	v	v	v	-	-	v	v	v	-			v		v		
	13	-	-	v	v	-	-	v	v	v	-			v		v		
	25	v	v	v	v	v	v	v	v	v	-			v		v		
	26	v	v	v	v	v	-	v	v	v	-			v		v		
	41	-	-	v	v	v	v	v	v	v	-			v		v		
	66	v	v	v	v	v	v	v	v	v	-			v		v		
71	-	-	v	v	v	v	v	v	v	-			v		v			
Conducted Band Edge	2	Covered by Band 25																
	4	Covered by Band 66																
	5	Covered by Band 26																
	7	-	-	v	v	v	v	v	v	v	-	v		v	v		v	
	12	v	v	v	v	-	-	v	v	v	-	v		v	v		v	
	13	-	-	v	v	-	-	v	v	v	-	v		v	v		v	
	25	v	v	v	v	v	v	v	v	v	-	v		v	v		v	
	26	v	v	v	v	v	-	v	v	v	-	v		v	v		v	
	41	-	-	v	v	v	v	v	v	v	-	v		v	v		v	
	66	v	v	v	v	v	v	v	v	v	-	v		v	v		v	
71	-	-	v	v	v	v	v	v	v	-	v		v	v		v		



Test Items	Band	Bandwidth (MHz)						Modulation				RB #			Test Channel		
		1.4	3	5	10	15	20	QPSK	16QAM	64QAM	256QAM	1	Half	Full	L	M	H
Conducted Spurious Emission	2	Covered by Band 25															
	4	Covered by Band 66															
	5	Covered by Band 26															
	7	-	-	v	v	v	v	v			-	v			v	v	v
	12	v	v	v	v	-	-	v			-	v			v	v	v
	13	-	-	v	v	-	-	v			-	v			v	v	v
	25	v	v	v	v	v	v	v			-	v			v	v	v
	26	v	v	v	v	v	-	v			-	v			v	v	v
	41	-	-	v	v	v	v	v			-	v			v	v	v
	66	v	v	v	v	v	v	v			-	v			v	v	v
	71	-	-	v	v	v	v	v			-	v			v	v	v
Frequency Stability	2	Covered by Band 25															
	4	Covered by Band 66															
	5	Covered by Band 26															
	7	-	-		v			v			-			v		v	
	12				v	-	-	v			-			v		v	
	13	-	-		v	-	-	v			-			v		v	
	25				v			v			-			v		v	
	26				v		-	v			-			v		v	
	41	-	-		v			v			-			v		v	
	66				v			v			-			v		v	
	71	-	-		v			v			-			v		v	



Test Items	Band	Bandwidth (MHz)					Modulation				RB #			Test Channel		
		1.4	3	5	10	15	20	QPSK	16QAM	64QAM	256QAM	1	Half	Full	L	M
Radiated Spurious Emission	2	Covered by Band 25														
	4	Covered by Band 66														
	5	Covered by Band 26														
	7	Worst Case												v	v	v
	12	Worst Case												v	v	v
	13	Worst Case												v	v	v
	25	Worst Case												v	v	v
	26	Worst Case												v	v	v
	41	Worst Case												v	v	v
	66	Worst Case												v	v	v
71	Worst Case												v	v	v	
Remark	1. The mark "v" means that this configuration is chosen for testing 2. The mark "-" means that this bandwidth is not supported. 3. The device is investigated from 30MHz to 10 times of fundamental signal for radiated spurious emission test under different RB size/offset and modulations in exploratory test. Subsequently, only the worst case emissions are reported. 4. Wider operating range bandwidth covers narrower one when the power is higher or the same. 5. One representative bandwidth is selected to perform PAR and frequency stability.															

Test Items	Band	Bandwidth (MHz)					Modulation				RB #			Test Channel		
		3+5	5+3	5+10	10+5	10+10	QPSK	16QAM	64QAM	256QAM	1	Half	Full	L	M	H
Max. Output Power	5_CA	-	-	v	v	v	v	v	v	-	v		v	v	v	v
26dB and 99% Bandwidth	5_CA	-	-	v	v	v	v	v	v	-			v		v	
Conducted Band Edge	5_CA	-	-	v	v	v	v	v	v	-	v		v			v
Conducted Spurious Emission	5_CA	-	-	v	v	v	v			-	v			v	v	v
Radiated Spurious Emission	5_CA	Worst Case												v	v	v
Remark	1. The mark "v" means that this configuration is chosen for testing 2. The mark "-" means that this bandwidth is not supported. 3. The device is investigated from 30MHz to 10 times of fundamental signal for radiated spurious emission test under different RB size/offset and modulations in exploratory test. Subsequently, only the worst case emissions are reported.															

Test Items	Band	Bandwidth (MHz)										Modulation				RB #			Test Channel			
		20+20	20+15	15+20	20+10	10+20	20+5	5+20	15+15	15+10	10+15	QPSK	16QAM	64QAM	256QAM	1	Half	Full	L	M	H	
Max. Output Power	7_CA	v	v	v	v	v	-	-	v	v	-	v	v	v	-	v		v	v	v	v	v
	41_CA	v	v	v	v	v	v	v	v	v	v	v	v	v	-	v		v	v	v	v	v
26dB and 99% Bandwidth	7_CA	v	v	v	v	v	-	-	v	v	-	v	v	v	-			v	v			v
	41_CA	v	v	v	v	v	v	v	v	v	v	v	v	v	-			v	v			v
Conducted Band Edge	7_CA	v	v	v	v	v	-	-	v	v	-	v	v	v	-	v		v	v			v
	41_CA	v	v	v	v	v	v	v	v	v	v	v	v	v	-	v		v	v			v
Conducted Spurious Emission	7_CA	v	v	v	v	v	-	-	v	v	-	v			-	v				v	v	v
	41_CA	v	v	v	v	v	v	v	v	v	v	v			-	v				v	v	v
Radiated Spurious Emission	7_CA	Worst Case																	v	v	v	
	41_CA	Worst Case																	v	v	v	
Remark	1. The mark "v" means that this configuration is chosen for testing 2. The mark "-" means that this bandwidth is not supported. 3. The device is investigated from 30MHz to 10 times of fundamental signal for radiated spurious emission test under different RB size/offset and modulations in exploratory test. Subsequently, only the worst case emissions are reported.																					

2.2 Connection Diagram of Test System

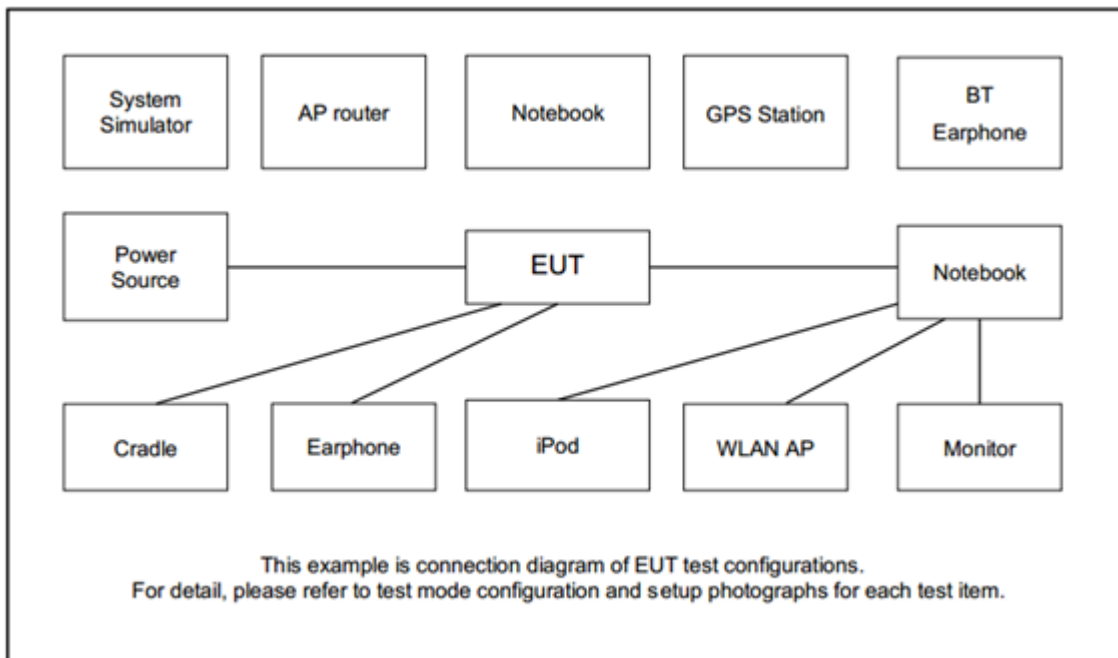



2.3 Support Unit used in test configuration and system

Item	Equipment	Brand Name	Model No.	FCC ID	Data Cable	Power Cord
1.	Antenna	PulseLarsen Antennas	SPDA24617/3900	N/A	N/A	N/A
2.	System Simulator	Anritsu	MT8820C	N/A	N/A	Unshielded, 1.8 m
3.	Fixture	Sierra Wireless	EM DevKit	N/A	N/A	N/A

2.4 Measurement Results Explanation Example

For all conducted test items:

The offset level is set in the spectrum analyzer to compensate the RF cable loss and attenuator factor between EUT conducted output port and spectrum analyzer. With the offset compensation, the spectrum analyzer reading level is exactly the EUT RF output level.

The spectrum analyzer offset is derived from RF cable loss and attenuator factor.

$$\text{Offset} = \text{RF cable loss} + \text{attenuator factor}.$$

Following shows an offset computation example with cable loss 4.2 dB and 10dB attenuator.

Example :

$$\begin{aligned} \text{Offset(dB)} &= \text{RF cable loss(dB)} + \text{attenuator factor(dB)}. \\ &= 4.2 + 10 = 14.2 \text{ (dB)} \end{aligned}$$



2.5 Frequency List of Low/Middle/High Channels

LTE Band 2 Channel and Frequency List				
BW [MHz]	Channel/Frequency(MHz)	Lowest	Middle	Highest
20	Channel	18700	18900	19100
	Frequency	1860	1880	1900
15	Channel	18675	18900	19125
	Frequency	1857.5	1880	1902.5
10	Channel	18650	18900	19150
	Frequency	1855	1880	1905
5	Channel	18625	18900	19175
	Frequency	1852.5	1880	1907.5
3	Channel	18615	18900	19185
	Frequency	1851.5	1880	1908.5
1.4	Channel	18607	18900	19193
	Frequency	1850.7	1880	1909.3

LTE Band 4 Channel and Frequency List				
BW [MHz]	Channel/Frequency(MHz)	Lowest	Middle	Highest
20	Channel	20050	20175	20300
	Frequency	1720	1732.5	1745
15	Channel	20025	20175	20325
	Frequency	1717.5	1732.5	1747.5
10	Channel	20000	20175	20350
	Frequency	1715	1732.5	1750
5	Channel	19975	20175	20375
	Frequency	1712.5	1732.5	1752.5
3	Channel	19965	20175	20385
	Frequency	1711.5	1732.5	1753.5
1.4	Channel	19957	20175	20393
	Frequency	1710.7	1732.5	1754.3



LTE Band 5 Channel and Frequency List				
BW [MHz]	Channel/Frequency(MHz)	Lowest	Middle	Highest
10	Channel	20450	20525	20600
	Frequency	829	836.5	844
5	Channel	20425	20525	20625
	Frequency	826.5	836.5	846.5
3	Channel	20415	20525	20635
	Frequency	825.5	836.5	847.5
1.4	Channel	20407	20525	20643
	Frequency	824.7	836.5	848.3

LTE Band 7 Channel and Frequency List				
BW [MHz]	Channel/Frequency(MHz)	Lowest	Middle	Highest
20	Channel	20850	21100	21350
	Frequency	2510	2535	2560
15	Channel	20825	21100	21375
	Frequency	2507.5	2535	2562.5
10	Channel	20800	21100	21400
	Frequency	2505	2535	2565
5	Channel	20775	21100	21425
	Frequency	2502.5	2535	2567.5

LTE Band 12 Channel and Frequency List				
BW [MHz]	Channel/Frequency(MHz)	Lowest	Middle	Highest
10	Channel	23060	23095	23130
	Frequency	704	707.5	711
5	Channel	23035	23095	23155
	Frequency	701.5	707.5	713.5
3	Channel	23025	23095	23165
	Frequency	700.5	707.5	714.5
1.4	Channel	23017	23095	23173
	Frequency	699.7	707.5	715.3



LTE Band 13 Channel and Frequency List				
BW [MHz]	Channel/Frequency(MHz)	Lowest	Middle	Highest
10	Channel	-	23230	-
	Frequency	-	782	-
5	Channel	23205	23230	23255
	Frequency	779.5	782	784.5

LTE Band 25 Channel and Frequency List				
BW [MHz]	Channel/Frequency(MHz)	Lowest	Middle	Highest
20	Channel	26140	26340	26590
	Frequency	1860	1880	1905
15	Channel	26115	26340	26615
	Frequency	1857.5	1880	1907.5
10	Channel	26090	26340	26640
	Frequency	1855	1880	1910
5	Channel	26065	26340	26665
	Frequency	1852.5	1880	1912.5
3	Channel	26055	26340	26675
	Frequency	1851.5	1880	1913.5
1.4	Channel	26047	26340	26683
	Frequency	1850.7	1880	1914.3



LTE Band 26 Channel and Frequency List				
BW [MHz]	Channel/Frequency(MHz)	Lowest	Middle	Highest
15	Channel	26865	26915	26965
	Frequency	831.5	836.5	841.5
10	Channel	26840	26915	26990
	Frequency	829.0	836.5	844.0
5	Channel	26815	26915	27015
	Frequency	826.5	836.5	846.5
3	Channel	26805	26915	27025
	Frequency	825.5	836.5	847.5
1.4	Channel	26797	26915	27033
	Frequency	824.7	836.5	848.3

LTE Band 41 Channel and Frequency List				
BW [MHz]	Channel/Frequency(MHz)	Lowest	Middle	Highest
20	Channel	39750	40620	41490
	Frequency	2506.0	2593.0	2680.0
15	Channel	39725	40620	41515
	Frequency	2503.5	2593.0	2682.5
10	Channel	39700	40620	41540
	Frequency	2501.0	2593.0	2685.0
5	Channel	39675	40620	41565
	Frequency	2498.5	2593.0	2687.5



LTE Band 66 Channel and Frequency List				
BW [MHz]	Channel/Frequency(MHz)	Lowest	Middle	Highest
20	Channel	132072	132322	132572
	Frequency	1720	1745	1770
15	Channel	132047	132322	132597
	Frequency	1717.5	1745	1772.5
10	Channel	132022	132322	132622
	Frequency	1715	1745	1775
5	Channel	131997	132322	132647
	Frequency	1712.5	1745	1777.5
3	Channel	131987	132322	132657
	Frequency	1711.5	1745	1778.5
1.4	Channel	131979	132322	132665
	Frequency	1710.7	1745	1779.3

LTE Band 71 Channel and Frequency List				
BW [MHz]	Channel/Frequency(MHz)	Lowest	Middle	Highest
20	Channel	133222	133297	133372
	Frequency	673.0	680.5	688.0
15	Channel	133197	133297	133397
	Frequency	670.5	680.5	690.5
10	Channel	133172	133297	133422
	Frequency	668.0	680.5	693.0
5	Channel	133147	133297	133447
	Frequency	665.5	680.5	695.5



LTE Band 5B Channel and Frequency List_CA					
BW [MHz]	Channel/Frequency(MHz)		Lowest	Middle	Highest
5 + 10	PCC	Channel	20428	20478	20528
		Frequency	826.8	831.8	836.8
	SCC	Channel	20500	20550	20600
		Frequency	834.0	839.0	844.0
10 + 5	PCC	Channel	20450	20500	20550
		Frequency	829.0	834.0	839.0
	SCC	Channel	20522	20572	20622
		Frequency	836.2	841.2	846.2
10 + 10	PCC	Channel	20450	20476	20501
		Frequency	829.0	831.6	834.1
	SCC	Channel	20549	20575	20600
		Frequency	838.9	841.5	844.0



LTE Band 7C Channel and Frequency List_CA					
BW [MHz]	Channel/Frequency(MHz)		Lowest	Middle	Highest
20 + 20	PCC	Channel	20850	21001	21152
		Frequency	2510.0	2525.1	2540.2
	SCC	Channel	21048	21199	21350
		Frequency	2529.8	2544.9	2560.0
20 + 15	PCC	Channel	20850	21026	21201
		Frequency	2510.0	2527.6	2545.1
	SCC	Channel	21021	21197	21372
		Frequency	2527.1	2544.7	2562.2
15 + 20	PCC	Channel	20828	21003	21179
		Frequency	2507.8	2525.3	2542.9
	SCC	Channel	20999	21174	21350
		Frequency	2524.9	2542.4	2560.0
20 + 10	PCC	Channel	20850	21051	21251
		Frequency	2510.0	2530.1	2550.1
	SCC	Channel	20994	21195	21395
		Frequency	2524.4	2544.5	2564.5
10 + 20	PCC	Channel	20805	21006	21206
		Frequency	2505.5	2525.6	2545.6
	SCC	Channel	20949	21150	21350
		Frequency	2519.9	2540.0	2560.0
15 + 15	PCC	Channel	20825	21025	21225
		Frequency	2507.5	2527.5	2547.5
	SCC	Channel	20975	21175	21375
		Frequency	2522.5	2542.5	2562.5
15 + 10	PCC	Channel	20825	21051	21277
		Frequency	2507.5	2530.1	2552.7
	SCC	Channel	20945	21171	21397
		Frequency	2519.5	2542.1	2564.7



LTE Band 41C Channel and Frequency List_CA					
BW [MHz]	Channel/Frequency(MHz)		Lowest	Middle	Highest
20 + 20	PCC	Channel	39750	40521	41292
		Frequency	2506.0	2583.1	2660.2
	SCC	Channel	39948	40719	41490
		Frequency	2525.8	2602.9	2680.0
20 + 15	PCC	Channel	39750	40546	41341
		Frequency	2506.0	2585.6	2665.1
	SCC	Channel	39921	40717	41512
		Frequency	2523.1	2602.7	2682.2
15 + 20	PCC	Channel	39728	40523	41319
		Frequency	2503.8	2593.3	2662.9
	SCC	Channel	39899	40694	41490
		Frequency	2520.9	2600.4	2680.0
20 + 10	PCC	Channel	39750	40571	41391
		Frequency	2506.0	2588.1	2670.1
	SCC	Channel	39894	40715	41535
		Frequency	2520.4	2602.5	2684.5
10 + 20	PCC	Channel	39705	40526	41346
		Frequency	2501.5	2583.6	2665.6
	SCC	Channel	39849	40670	41490
		Frequency	2515.9	2598.0	2680.0



LTE Band 41C Channel and Frequency List_CA					
20 + 5	PCC	Channel	39750	40595	41440
		Frequency	2506.0	2590.5	2675.0
	SCC	Channel	39867	40712	41557
		Frequency	2517.7	2602.2	2686.7
5 + 20	PCC	Channel	39683	40528	41373
		Frequency	2499.3	2583.8	2668.3
	SCC	Channel	39800	40645	41490
		Frequency	2511.0	2595.5	2680.0
15 + 15	PCC	Channel	39725	40545	41365
		Frequency	2503.5	2585.5	2667.5
	SCC	Channel	39875	40695	41515
		Frequency	2518.5	2600.5	2682.5
10 + 15	PCC	Channel	39703	40549	41395
		Frequency	2501.3	2585.9	2670.5
	SCC	Channel	39823	40669	41515
		Frequency	2513.3	2597.9	2682.5
15 + 10	PCC	Channel	39725	40571	41417
		Frequency	2503.5	2588.1	2672.7
	SCC	Channel	39845	40691	41537
		Frequency	2515.5	2600.1	2684.7

3 Conducted Test Items

3.1 Measuring Instruments

See list of measuring instruments of this test report.

3.1.1 Test Setup

3.1.2 Conducted Output Power

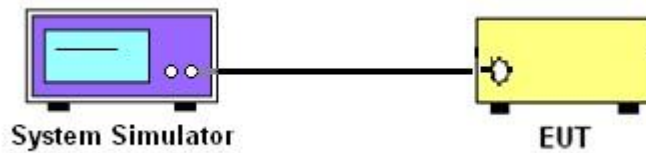

3.1.3 Peak-to-Average Ratio, Occupied Bandwidth, Conducted Band-Edge and Conducted Spurious Emission

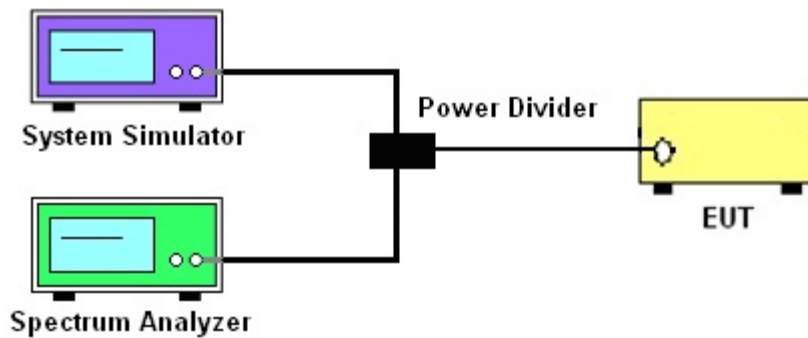

3.1.4 Frequency Stability

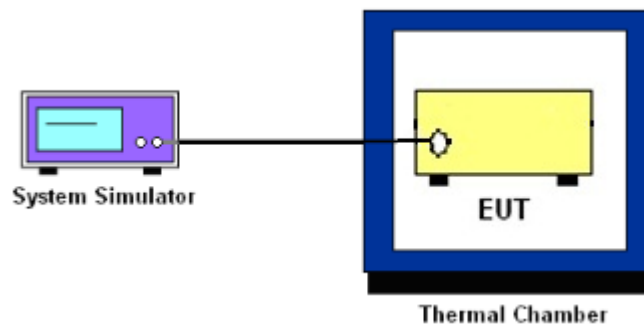

3.1.5 Test Result of Conducted Test

Please refer to Appendix A.



3.2 Conducted Output Power

3.2.1 Description of the Conducted Output Power Measurement

A system simulator was used to establish communication with the EUT. Its parameters were set to force the EUT transmitting at maximum output power. The measured power in the radio frequency on the transmitter output terminals shall be reported.

3.2.2 Test Procedures

1. The transmitter output port was connected to the system simulator.
2. Set EUT at maximum power through the system simulator.
3. Select lowest, middle, and highest channels for each band and different modulation.
4. Measure and record the power level from the system simulator.



3.3 Peak-to-Average Ratio

3.3.1 Description of the PAR Measurement

Power Complementary Cumulative Distribution Function (CCDF) curves provide a means for characterizing the power peaks of a digitally modulated signal on a statistical basis. A CCDF curve depicts the probability of the peak signal amplitude exceeding the average power level. Most contemporary measurement instrumentation include the capability to produce CCDF curves for an input signal provided that the instrument's resolution bandwidth can be set wide enough to accommodate the entire input signal bandwidth. In measuring transmissions in this band using an average power technique, the peak-to-average ratio (PAR) of the transmission may not exceed 13 dB.

3.3.2 Test Procedures

The testing follows ANSI C63.26-2015 Section 5.2.6

1. The EUT was connected to spectrum and system simulator via a power divider.
2. Set the CCDF (Complementary Cumulative Distribution Function) option in spectrum analyzer.
3. The highest RF powers were measured and recorded the maximum PAPR level associated with a probability of 0.1 %.
4. Record the deviation as Peak to Average Ratio.



3.4 Occupied Bandwidth

3.4.1 Description of Occupied Bandwidth Measurement

The occupied bandwidth is the width of a frequency band such that, below the lower and above the upper frequency limits, the mean powers emitted are each equal to a specified percentage 0.5% of the total mean transmitted power.

The 26 dB emission bandwidth is defined as the frequency range between two points, one above and one below the carrier frequency, at which the spectral density of the emission is attenuated 26 dB below the maximum in-band spectral density of the modulated signal. Spectral density (power per unit bandwidth) is to be measured with a detector of resolution bandwidth equal to approximately 1.0% of the emission bandwidth.

3.4.2 Test Procedures

The testing follows ANSI C63.26-2015 Section 5.4.3 (26dB) and Section 5.4.4 (99OB)

1. The EUT was connected to spectrum analyzer and system simulator via a power divider.
2. The spectrum analyzer center frequency is set to the nominal EUT channel center frequency. The span range for the spectrum analyzer shall be between two and five times the anticipated OBW.
3. The nominal resolution bandwidth (RBW) shall be in the range of 1 to 5 % of the anticipated OBW, and the VBW shall be at least 3 times the RBW.
4. Set the detection mode to peak, and the trace mode to max hold.
5. Determine the reference value: Set the EUT to transmit a modulated signal. Allow the trace to stabilize. Set the spectrum analyzer marker to the highest level of the displayed trace.
(this is the reference value)
6. Determine the “-26 dB down amplitude” as equal to (Reference Value – X).
7. Place two markers, one at the lowest and the other at the highest frequency of the envelope of the spectral display such that each marker is at or slightly below the “-X dB down amplitude” determined in step 6. If a marker is below this “-X dB down amplitude” value it shall be placed as close as possible to this value. The OBW is the positive frequency difference between the two markers.
8. Use the 99 % power bandwidth function of the spectrum analyzer and report the measured bandwidth.



3.5 Conducted Band Edge

3.5.1 Description of Conducted Band Edge Measurement

22.917(a)

For operations in the 824 – 849 MHz band, the FCC limit is $43 + 10\log_{10}(P[\text{Watts}])$ dB below the transmitter power $P(\text{Watts})$ in a 100kHz bandwidth. However, in the 1MHz bands immediately outside and adjacent to the licensee's frequency block, a resolution bandwidth of at least one percent of the emission bandwidth of the fundamental emission of the transmitter may be employed.

24.238 (a)

For operations in the 1850-1910 and 1930-1990 MHz band, the FCC limit is $43 + 10\log_{10}(P[\text{Watts}])$ dB below the transmitter power $P(\text{Watts})$ in a 1MHz bandwidth. However, in the 1 MHz bands immediately outside and adjacent to the frequency block a resolution bandwidth of at least one percent of the emission bandwidth of the fundamental emission of the transmitter may be employed.

27.53 (c)

For operations in the 776-788 MHz band, the FCC limit is $43 + 10\log_{10}(P[\text{Watts}])$ dB below the transmitter power $P(\text{Watts})$ in a 100 kHz bandwidth. However, in the 100 kHz bands immediately outside and adjacent to the frequency block, a resolution bandwidth of at least 30 kHz may be employed. In addition, the power of any unwanted emissions in any 6.25 kHz bandwidth for all frequencies between 763-775 MHz and 793-806 MHz shall be attenuated below the transmitter power, P (dBW), by at least $65 + 10 \log_{10} p(\text{watts})$, dB, for mobile and portable equipment.

27.53 (g)

For operations in the 600MHz band and 698-746 MHz band, the FCC limit is $43 + 10\log_{10}(P[\text{Watts}])$ dB below the transmitter power $P(\text{Watts})$ in a 100 kHz bandwidth. However, in the 100 kilohertz bands immediately outside and adjacent to a licensee's frequency block, a resolution bandwidth of at least 30 kHz may be employed.

27.53 (h)

For operations in the 1710 – 1755 MHz band, 1755-1780 MHz, the FCC limit is $43 + 10\log_{10}(P[\text{Watts}])$ dB below the transmitter power $P(\text{Watts})$ in a 1 MHz bandwidth. However, in the 1MHz bands immediately outside and adjacent to the licensee's frequency block, a resolution bandwidth of at least one percent of the emission bandwidth of the fundamental emission of the transmitter may be employed.



27.53(m)(4)

For mobile digital stations, the attenuation factor shall be not less than $40 + 10 \log (P)$ dB on all frequencies between the channel edge and 5 megahertz from the channel edge, $43 + 10 \log (P)$ dB on all frequencies between 5 megahertz and X megahertz from the channel edge, and $55 + 10 \log (P)$ dB on all frequencies more than X megahertz from the channel edge, where X is the greater of 6 megahertz or the actual emission bandwidth as defined in paragraph (m)(6) of this section. In addition, the attenuation factor shall not be less that $43 + 10 \log (P)$ dB on all frequencies between 2490.5 MHz and 2496 MHz and $55 + 10 \log (P)$ dB at or below 2490.5 MHz. Mobile Satellite Service licensees operating on frequencies below 2495 MHz may also submit a documented interference complaint against BRS licensees operating on channel BRS Channel 1 on the same terms and conditions as adjacent channel BRS or EBS licensees.

3.5.2 Test Procedures

The testing follows FCC KDB 971168 D01 v03r01 Section 6.1.

1. The EUT was connected to spectrum analyzer and system simulator via a power divider.
2. The band edges of low and high channels for the highest RF powers were measured.
3. Set RBW $\geq 1\%$ EBW in the 1MHz band immediately outside and adjacent to the band edge.
4. Beyond the 1 MHz band from the band edge, RBW=1MHz was used.
5. Set spectrum analyzer with RMS detector.
6. The RF fundamental frequency should be excluded against the limit line in the operating frequency band.
7. Checked that all the results comply with the emission limit line.

The limit line is derived from $43 + 10\log(P)$ dB below the transmitter power P(Watts)

For LTE Band 7, 41

The other 40 dB, and 55 dB have additionally applied same calculation above.



3.6 Conducted Spurious Emission

3.6.1 Description of Conducted Spurious Emission Measurement

The power of any emission outside of the authorized operating frequency ranges must be lower than the transmitter power (P) by a factor of at least $43 + 10 \log (P)$ dB.

For LTE Band 7, 41

The power of any emission outside of the authorized operating frequency ranges must be lower than the transmitter power (P) by a factor of at least $55 + 10 \log (P)$ dB.

It is measured by means of a calibrated spectrum analyzer and scanned from 30 MHz up to a frequency including its 10th harmonic.

3.6.2 Test Procedures

The testing follows FCC KDB 971168 D01 v03r01 Section 6.1.

1. The EUT was connected to spectrum analyzer and system simulator via a power divider.
2. The RF output of EUT was connected to the spectrum analyzer by RF cable and attenuator.
The path loss was compensated to the results for each measurement.
3. The middle channel for the highest RF power within the transmitting frequency was measured.
4. The conducted spurious emission for the whole frequency range was taken.
5. Make the measurement with the spectrum analyzer's RBW = 1MHz, VBW = 3MHz.
6. Set spectrum analyzer with RMS detector.
7. Taking the record of maximum spurious emission.
8. The RF fundamental frequency should be excluded against the limit line in the operating frequency band.
9. The limit line is derived from $43 + 10\log(P)$ dB below the transmitter power P(Watts)
For LTE Band 7, 41
The limit line is derived from $55 + 10\log(P)$ dB below the transmitter power P(Watts)



3.7 Frequency Stability

3.7.1 Description of Frequency Stability Measurement

22.355

The frequency stability shall be measured by variation of ambient temperature and variation of primary supply voltage to ensure that the fundamental emission stays within the authorized frequency block. The frequency stability of the transmitter shall be maintained within $\pm 0.00025\%$ ($\pm 2.5\text{ppm}$) of the center frequency.

24.235 & 27.54

The frequency stability shall be sufficient to ensure that the fundamental emission stays within the authorized frequency block.

3.7.2 Test Procedures for Temperature Variation

The testing follows FCC KDB 971168 D01 v03r01 Section 9.0.

1. The EUT was set up in the thermal chamber and connected with the system simulator.
2. With power OFF, the temperature was decreased to -30°C and the EUT was stabilized before testing. Power was applied and the maximum change in frequency was recorded within one minute.
3. With power OFF, the temperature was raised in 10°C step up to 50°C . The EUT was stabilized at each step for at least half an hour. Power was applied and the maximum frequency change was recorded within one minute.

3.7.3 Test Procedures for Voltage Variation

The testing follows FCC KDB 971168 D01 v03r01 Section 9.0.

1. The EUT was placed in a temperature chamber at $20\pm 5^{\circ}\text{C}$ and connected with the system simulator.
2. The power supply voltage to the EUT was varied from 85% to 115% of the nominal value measured at the input to the EUT.
3. The variation in frequency was measured for the worst case.

4 Radiated Test Items

4.1 Measuring Instruments

See list of measuring instruments of this test report.

4.1.1 Test Setup

For radiated test below 30MHz

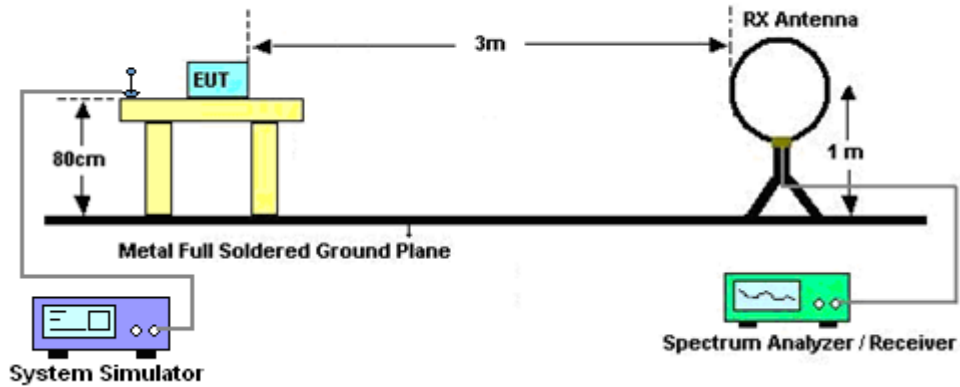

For radiated test from 30MHz to 1GHz

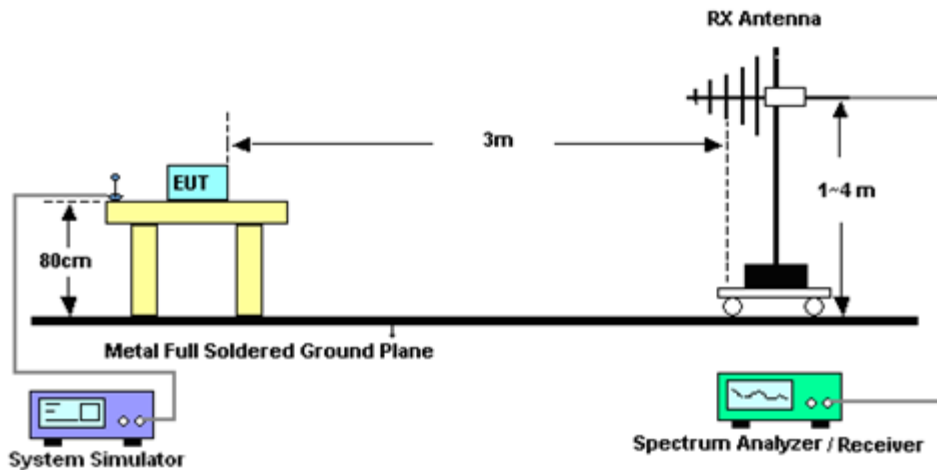

For radiated test from 1GHz to 18GHz

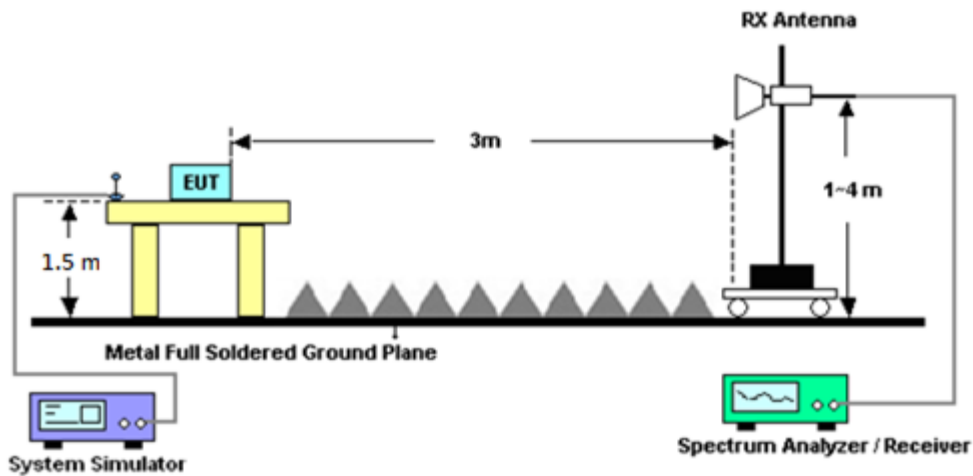

For radiated test above 18GHz

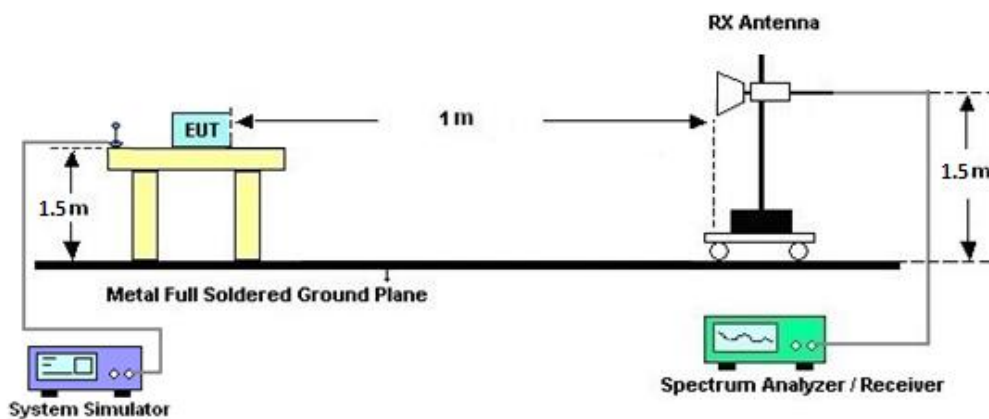

4.1.2 Test Result of Radiated Test

Please refer to Appendix B.

Note:

The low frequency, which started from 9 kHz to 30MHz, was pre-scanned and the result which was 20dB lower than the limit line was not reported.

There is adequate comparison measurement of both open-field test site and alternative test site - semi-Anechoic chamber according to 414788 D01 Radiated Test Site v01r01, and the result came out very similar.



4.2 Radiated Spurious Emission Measurement

4.2.1 Description of Radiated Spurious Emission Measurement

The radiated spurious emission was measured by substitution method according to ANSI / TIA-603-E. The power of any emission outside of the authorized operating frequency ranges must be attenuated below the transmitter power (P) by a factor of at least $43 + 10 \log (P)$ dB.

For LTE Band 7, 41

The power of any emission outside of the authorized operating frequency ranges must be attenuated below the transmitter power (P) by a factor of at least $55 + 10 \log (P)$ dB.

For LTE Band 13

For operations in the 746-758 MHz, 775-788 MHz, and 805-806 MHz bands, emissions in the band 1559-1610 MHz shall be limited to -70 dBW/MHz equivalent isotropically radiated power (EIRP) for wideband signals, and -80 dBW EIRP for discrete emissions of less than 700 Hz bandwidth.

The spectrum is scanned from 30 MHz up to a frequency including its 10th harmonic.

4.2.2 Test Procedures

The testing follows FCC KDB 971168 D01 v03r01 Section 7 and ANSI / TIA-603-E Section 2.2.12.

1. The EUT was placed on a turntable with 0.8 meter for frequency below 1GHz and 1.5 meter for frequency above 1GHz respectively above ground.
2. The EUT was set 3 meters from the receiving antenna, which was mounted on the antenna tower.
3. The table was rotated 360 degrees to determine the position of the highest spurious emission.
4. The height of the receiving antenna is varied between one meter and four meters to search the maximum spurious emission for both horizontal and vertical polarizations.
5. Make the measurement with the spectrum analyzer's RBW = 1MHz, VBW = 3MHz, taking the record of maximum spurious emission.
6. A horn antenna was substituted in place of the EUT and was driven by a signal generator.
7. Tune the output power of signal generator to the same emission level with EUT maximum spurious emission.
8. Taking the record of output power at antenna port.
9. Repeat step 7 to step 8 for another polarization.
10. The RF fundamental frequency should be excluded against the limit line in the operating frequency band.

The limit line is derived from $43 + 10\log(P)$ dB below the transmitter power P(Watts)

For LTE Band 7, 41

The limit line is derived from $55 + 10\log(P)$ dB below the transmitter power P(Watts)



5 List of Measuring Equipment

Instrument	Brand Name	Model No.	Serial No.	Characteristics	Calibration Date	Test Date	Due Date	Remark
Bilog Antenna	TESEQ	CBL 6111D & 00800N1D01N-06	35419 & 03	30MHz~1GHz	Apr. 24, 2022	May 04, 2022~ May 11, 2022	Apr. 23, 2023	Radiation (03CH07-HY)
Double Ridge Horn Antenna	ESCO	3117	00075962	1GHz ~ 18GHz	Dec. 03, 2021	May 04, 2022~ May 11, 2022	Dec. 02, 2022	Radiation (03CH07-HY)
Loop Antenna	Rohde & Schwarz	HFH2-Z2	100315	9 kHz~30 MHz	Jan. 07, 2022	May 04, 2022~ May 11, 2022	Jan. 06, 2023	Radiation (03CH07-HY)
Preamplifier	MITEQ	AMF-7D-0010 1800-30-10P	1590075	1GHz~18GHz	Apr. 21, 2022	May 04, 2022~ May 11, 2022	Apr. 20, 2023	Radiation (03CH07-HY)
Preamplifier	COM-POWER	PA-103A	161241	10MHz~1GHz	Oct. 04, 2021	May 04, 2022~ May 11, 2022	Oct. 03, 2022	Radiation (03CH07-HY)
Preamplifier	Agilent	8449B	3008A02362	1GHz~26.5GHz	Oct. 04, 2021	May 04, 2022~ May 11, 2022	Oct. 03, 2022	Radiation (03CH07-HY)
Preamplifier	EMEC	EM18G40G	0600789	18-40GHz	Jul. 23, 2021	May 04, 2022~ May 11, 2022	Jul. 22, 2022	Radiation (03CH07-HY)
Spectrum Analyzer	Agilent	N9030A	MY52350276	3Hz~44GHz	Jul. 22, 2021	May 04, 2022~ May 11, 2022	Jul. 21, 2022	Radiation (03CH07-HY)
RF Cable	HUBER + SUHNER	SUCOFLEX 104	MY15682/4	30MHz to 18GHz	Feb. 23, 2022	May 04, 2022~ May 11, 2022	Feb. 22, 2023	Radiation (03CH07-HY)
RF Cable	HUBER + SUHNER	SUCOFLEX 104	MY24971/4	9kHz to 18GHz	Feb. 23, 2022	May 04, 2022~ May 11, 2022	Feb. 22, 2023	Radiation (03CH07-HY)
RF Cable	HUBER + SUHNER	SUCOFLEX 104	MY28655/4	9kHz to 18GHz	Feb. 23, 2022	May 04, 2022~ May 11, 2022	Feb. 22, 2023	Radiation (03CH07-HY)
RF Cable	HUBER + SUHNER	SUCOFLEX 126	532078/126E	30MHz~18GHz	Sep. 17, 2021	May 04, 2022~ May 11, 2022	Sep. 16, 2022	Radiation (03CH07-HY)
RF Cable	HUBER + SUHNER	SUCOFLEX 102	MY2858/2	18GHz~40GHz	Feb. 23, 2022	May 04, 2022~ May 11, 2022	Feb. 22, 2023	Radiation (03CH07-HY)
Controller	EMEC	EM1000	N/A	Control Ant Mast	N/A	May 04, 2022~ May 11, 2022	N/A	Radiation (03CH07-HY)
Controller	MF	MF-7802	N/A	Control Turn table	N/A	May 04, 2022~ May 11, 2022	N/A	Radiation (03CH07-HY)
Antenna Mast	EMEC	AM-BS-4500E	N/A	Boresight mast 1M~4M	N/A	May 04, 2022~ May 11, 2022	N/A	Radiation (03CH07-HY)
Turn Table	ChainTek	Chaintek 3000	N/A	0~360 Degree	N/A	May 04, 2022~ May 11, 2022	N/A	Radiation (03CH07-HY)
Software	Audix	E3	N/A	N/A	N/A	May 04, 2022~ May 11, 2022	N/A	Radiation (03CH07-HY)
USB Data Logger	TECPEL	TR-32	HE17XB2495	N/A	Mar. 07, 2022	May 04, 2022~ May 11, 2022	Mar. 06, 2023	Radiation (03CH07-HY)
Horn Antenna	EMCO	3117	00143261	1GHz~18GHz	Feb. 11, 2022	May 04, 2022~ May 11, 2022	Feb. 10, 2023	Radiation (03CH07-HY)
SHF-EHF Horn Antenna	SCHWARZBECK	BBHA 9170	BBHA9170251	18GHz~40GHz	Nov. 30, 2021	May 04, 2022~ May 11, 2022	Nov. 29, 2022	Radiation (03CH07-HY)
Signal Generator	Rohde & Schwarz	SMF100A	101107	100kHz~40GHz	Dec. 08, 2021	May 04, 2022~ May 11, 2022	Dec. 07, 2022	Radiation (03CH07-HY)



Instrument	Brand Name	Model No.	Serial No.	Characteristics	Calibration Date	Test Date	Due Date	Remark
Radio Communication Analyzer	Anritsu	MT8821C	6262025280	LTE FDD/TDD LTE-2CC DLCA/ULCA	Oct. 29, 2021	Apr. 27, 2022~ Jul. 21, 2022	Oct. 28, 2022	Conducted (TH03-HY)
Spectrum Analyzer	Rohde & Schwarz	FSV40	101908	10Hz~40GHz	Oct. 01, 2021	Apr. 27, 2022~ Jul. 21, 2022	Sep. 30, 2022	Conducted (TH03-HY)
Thermal Chamber	ESPEC	SH-641	92013720	-40°C ~90°C	Sep. 09, 2021	Apr. 27, 2022~ Jul. 21, 2022	Sep. 08, 2022	Conducted (TH03-HY)
DC Power Supply	GW Instek	GPP-2323	GES906037	0V~64V : 0A~6A	Jan. 06, 2022	Apr. 27, 2022~ Jul. 21, 2022	Jan. 05, 2023	Conducted (TH03-HY)
Coupler	Warison	20dB 25W SMA Directional Coupler	#B	1-18GHz	Jan. 07, 2022	Apr. 27, 2022~ Jul. 21, 2022	Jan. 06, 2023	Conducted (TH03-HY)



6 Uncertainty of Evaluation

Uncertainty of Radiated Emission Measurement (30 MHz ~ 1000 MHz)

Measuring Uncertainty for a Level of Confidence of 95% ($U = 2Uc(y)$)	3.16 dB
---	---------

Uncertainty of Radiated Emission Measurement (1 GHz ~ 18 GHz)

Measuring Uncertainty for a Level of Confidence of 95% ($U = 2Uc(y)$)	3.71 dB
---	---------

Uncertainty of Radiated Emission Measurement (18 GHz ~ 40 GHz)

Measuring Uncertainty for a Level of Confidence of 95% ($U = 2Uc(y)$)	4.16 dB
---	---------



Appendix A. Test Results of Conducted Test

Conducted Output Power(Average power)

LTE Band 2 Maximum Average Power [dBm]								
BW [MHz]	RB Size	RB Offset	Mod	Lowest	Middle	Highest	Maximum Output Power (dBm)	Maximum Output Power (W)
20	1	0	QPSK	23.41	23.41	23.62	23.62	0.2301
20	1	49		23.49	23.45	23.61		
20	1	99		23.29	23.43	23.61		
20	50	0		22.51	22.49	22.52		
20	50	24		22.46	22.45	22.55		
20	50	50		22.38	22.40	22.57		
20	100	0		22.46	22.47	22.52		
20	1	0	16-QAM	22.84	22.81	22.99	22.99	0.1991
20	1	49		22.89	22.90	22.94		
20	1	99		22.68	22.91	22.99		
20	50	0		21.60	21.57	21.61		
20	50	24		21.58	21.60	21.64		
20	50	50		21.49	21.49	21.65		
20	100	0		21.53	21.52	21.63		
20	1	0	64-QAM	21.74	21.71	21.86	21.97	0.1574
20	1	49		21.78	21.74	21.93		
20	1	99		21.57	21.72	21.97		
20	50	0		20.61	20.60	20.62		
20	50	24		20.57	20.56	20.62		
20	50	50		20.45	20.45	20.65		
20	100	0		20.55	20.58	20.60		



LTE Band 2 Maximum Average Power [dBm]								
BW [MHz]	RB Size	RB Offset	Mod	Lowest	Middle	Highest	Maximum Output Power (dBm)	Maximum Output Power (W)
15	1	0	QPSK	23.39	23.33	23.57	23.61	0.2296
15	1	37		23.46	23.43	23.61		
15	1	74		23.27	23.39	23.55		
15	36	0		22.42	22.46	22.42		
15	36	20		22.36	22.40	22.51		
15	36	39		22.35	22.39	22.52		
15	75	0		22.36	22.46	22.48		
15	1	0	16-QAM	22.74	22.79	22.97	22.97	0.1982
15	1	37		22.85	22.81	22.87		
15	1	74		22.59	22.88	22.92		
15	36	0		21.57	21.50	21.58		
15	36	20		21.58	21.59	21.63		
15	36	39		21.43	21.49	21.64		
15	75	0		21.46	21.48	21.61		
15	1	0	64-QAM	21.64	21.66	21.86	21.97	0.1574
15	1	37		21.75	21.71	21.93		
15	1	74		21.50	21.68	21.97		
15	36	0		20.55	20.57	20.62		
15	36	20		20.49	20.54	20.59		
15	36	39		20.42	20.36	20.55		
15	75	0		20.54	20.48	20.55		



LTE Band 2 Maximum Average Power [dBm]								
BW [MHz]	RB Size	RB Offset	Mod	Lowest	Middle	Highest	Maximum Output Power (dBm)	Maximum Output Power (W)
10	1	0	QPSK	23.33	23.23	23.49	23.55	0.2265
10	1	25		23.40	23.38	23.53		
10	1	49		23.18	23.37	23.55		
10	25	0		22.37	22.36	22.41		
10	25	12		22.36	22.31	22.42		
10	25	25		22.32	22.38	22.52		
10	50	0		22.33	22.44	22.46		
10	1	0	16-QAM	22.74	22.73	22.97	22.97	0.1982
10	1	25		22.80	22.79	22.84		
10	1	49		22.50	22.83	22.83		
10	25	0		21.55	21.44	21.58		
10	25	12		21.53	21.58	21.53		
10	25	25		21.35	21.47	21.57		
10	50	0		21.36	21.42	21.54		
10	1	0	64-QAM	21.60	21.63	21.76	21.88	0.1542
10	1	25		21.70	21.70	21.83		
10	1	49		21.46	21.63	21.88		
10	25	0		20.46	20.54	20.59		
10	25	12		20.44	20.51	20.53		
10	25	25		20.36	20.27	20.53		
10	50	0		20.45	20.38	20.48		



LTE Band 2 Maximum Average Power [dBm]								
BW [MHz]	RB Size	RB Offset	Mod	Lowest	Middle	Highest	Maximum Output Power (dBm)	Maximum Output Power (W)
5	1	0	QPSK	23.23	23.22	23.45	23.50	0.2239
5	1	12		23.36	23.35	23.44		
5	1	24		23.16	23.31	23.50		
5	12	0		22.28	22.32	22.41		
5	12	7		22.31	22.23	22.35		
5	12	13		22.32	22.30	22.47		
5	25	0		22.30	22.36	22.46		
5	1	0	16-QAM	22.70	22.65	22.91	22.91	0.1954
5	1	12		22.72	22.76	22.77		
5	1	24		22.48	22.75	22.73		
5	12	0		21.55	21.36	21.51		
5	12	7		21.52	21.48	21.45		
5	12	13		21.28	21.46	21.49		
5	25	0		21.31	21.34	21.44		
5	1	0	64-QAM	21.55	21.63	21.70	21.84	0.1528
5	1	12		21.63	21.68	21.81		
5	1	24		21.40	21.55	21.84		
5	12	0		20.37	20.46	20.59		
5	12	7		20.35	20.51	20.44		
5	12	13		20.36	20.23	20.49		
5	25	0		20.36	20.38	20.42		



LTE Band 2 Maximum Average Power [dBm]								
BW [MHz]	RB Size	RB Offset	Mod	Lowest	Middle	Highest	Maximum Output Power (dBm)	Maximum Output Power (W)
3	1	0	QPSK	23.14	23.13	23.39	23.48	0.2228
3	1	8		23.36	23.34	23.42		
3	1	14		23.10	23.23	23.48		
3	8	0		22.23	22.26	22.38		
3	8	4		22.23	22.14	22.35		
3	8	7		22.32	22.20	22.38		
3	15	0		22.27	22.28	22.46		
3	1	0	16-QAM	22.70	22.62	22.84	22.84	0.1923
3	1	8		22.67	22.67	22.74		
3	1	14		22.39	22.69	22.67		
3	8	0		21.53	21.35	21.42		
3	8	4		21.48	21.42	21.36		
3	8	7		21.27	21.45	21.44		
3	15	0		21.31	21.24	21.40		
3	1	0	64-QAM	21.48	21.54	21.60	21.75	0.1496
3	1	8		21.53	21.67	21.75		
3	1	14		21.34	21.47	21.75		
3	8	0		20.35	20.42	20.59		
3	8	4		20.31	20.47	20.39		
3	8	7		20.33	20.16	20.45		
3	15	0		20.33	20.30	20.41		



LTE Band 2 Maximum Average Power [dBm]								
BW [MHz]	RB Size	RB Offset	Mod	Lowest	Middle	Highest	Maximum Output Power (dBm)	Maximum Output Power (W)
1.4	1	0	QPSK	23.04	23.07	23.37	23.39	0.2183
1.4	1	3		23.33	23.25	23.34		
1.4	1	5		23.00	23.23	23.39		
1.4	3	0		22.17	22.20	22.33		
1.4	3	1		22.15	22.06	22.32		
1.4	3	3		22.30	22.13	22.38		
1.4	6	0		21.26	21.27	21.41		
1.4	1	0	16-QAM	22.62	22.55	22.75	22.75	0.1884
1.4	1	3		22.67	22.67	22.73		
1.4	1	5		22.35	22.61	22.63		
1.4	3	0		21.46	21.29	21.42		
1.4	3	1		21.44	21.37	21.30		
1.4	3	3		21.20	21.36	21.38		
1.4	6	0		20.29	20.14	20.30		
1.4	1	0	64-QAM	21.42	21.54	21.52	21.74	0.1493
1.4	1	3		21.44	21.65	21.74		
1.4	1	5		21.24	21.45	21.65		
1.4	3	0		20.27	20.32	20.51		
1.4	3	1		20.27	20.43	20.39		
1.4	3	3		20.25	20.15	20.42		
1.4	6	0		19.27	19.26	19.41		



LTE Band 25 Maximum Average Power [dBm]								
BW [MHz]	RB Size	RB Offset	Mod	Lowest	Middle	Highest	Maximum Output Power (dBm)	Maximum Output Power (W)
20	1	0	QPSK	23.45	23.43	23.55	23.63	0.2307
20	1	49		23.44	23.53	23.60		
20	1	99		23.27	23.43	23.63		
20	50	0		22.48	22.49	22.53		
20	50	24		22.48	22.50	22.58		
20	50	50		22.47	22.37	22.54		
20	100	0		22.50	22.49	22.50		
20	1	0	16-QAM	22.93	22.84	22.94	22.99	0.1991
20	1	49		22.96	22.99	22.89		
20	1	99		22.71	22.86	22.96		
20	50	0		21.62	21.60	21.61		
20	50	24		21.66	21.57	21.63		
20	50	50		21.53	21.48	21.70		
20	100	0		21.57	21.55	21.60		
20	1	0	64-QAM	21.77	21.72	21.82	21.96	0.1570
20	1	49		21.84	21.81	21.96		
20	1	99		21.61	21.76	21.94		
20	50	0		20.65	20.59	20.62		
20	50	24		20.60	20.57	20.65		
20	50	50		20.54	20.48	20.67		
20	100	0		20.60	20.54	20.63		



LTE Band 25 Maximum Average Power [dBm]								
BW [MHz]	RB Size	RB Offset	Mod	Lowest	Middle	Highest	Maximum Output Power (dBm)	Maximum Output Power (W)
15	1	0	QPSK	23.44	23.40	23.53	23.57	0.2275
15	1	37		23.43	23.53	23.57		
15	1	74		23.22	23.36	23.56		
15	36	0		22.38	22.39	22.50		
15	36	20		22.46	22.41	22.58		
15	36	39		22.44	22.37	22.48		
15	75	0		22.43	22.44	22.50		
15	1	0	16-QAM	22.85	22.84	22.93	22.94	0.1968
15	1	37		22.88	22.94	22.84		
15	1	74		22.64	22.81	22.88		
15	36	0		21.59	21.50	21.61		
15	36	20		21.59	21.55	21.56		
15	36	39		21.45	21.47	21.68		
15	75	0		21.50	21.52	21.51		
15	1	0	64-QAM	21.68	21.65	21.80	21.93	0.1560
15	1	37		21.74	21.74	21.93		
15	1	74		21.51	21.76	21.85		
15	36	0		20.57	20.54	20.61		
15	36	20		20.55	20.52	20.63		
15	36	39		20.52	20.43	20.66		
15	75	0		20.53	20.45	20.60		



LTE Band 25 Maximum Average Power [dBm]								
BW [MHz]	RB Size	RB Offset	Mod	Lowest	Middle	Highest	Maximum Output Power (dBm)	Maximum Output Power (W)
10	1	0	QPSK	23.34	23.40	23.46	23.56	0.2270
10	1	25		23.40	23.53	23.56		
10	1	49		23.15	23.31	23.46		
10	25	0		22.30	22.31	22.48		
10	25	12		22.46	22.38	22.49		
10	25	25		22.37	22.28	22.43		
10	50	0		22.34	22.44	22.44		
10	1	0	16-QAM	22.76	22.78	22.87	22.87	0.1936
10	1	25		22.84	22.85	22.78		
10	1	49		22.57	22.75	22.81		
10	25	0		21.57	21.42	21.60		
10	25	12		21.51	21.53	21.53		
10	25	25		21.44	21.39	21.68		
10	50	0		21.46	21.51	21.43		
10	1	0	64-QAM	21.59	21.63	21.73	21.88	0.1542
10	1	25		21.64	21.64	21.88		
10	1	49		21.48	21.70	21.81		
10	25	0		20.50	20.49	20.59		
10	25	12		20.52	20.52	20.57		
10	25	25		20.45	20.35	20.64		
10	50	0		20.48	20.41	20.54		



LTE Band 25 Maximum Average Power [dBm]								
BW [MHz]	RB Size	RB Offset	Mod	Lowest	Middle	Highest	Maximum Output Power (dBm)	Maximum Output Power (W)
5	1	0	QPSK	23.30	23.35	23.46	23.53	0.2254
5	1	12		23.31	23.53	23.52		
5	1	24		23.13	23.27	23.37		
5	12	0		22.24	22.21	22.44		
5	12	7		22.46	22.29	22.43		
5	12	13		22.28	22.28	22.39		
5	25	0		22.32	22.34	22.34		
5	1	0	16-QAM	22.68	22.71	22.78	22.79	0.1901
5	1	12		22.79	22.76	22.76		
5	1	24		22.56	22.73	22.72		
5	12	0		21.51	21.38	21.55		
5	12	7		21.43	21.43	21.47		
5	12	13		21.40	21.38	21.65		
5	25	0		21.37	21.51	21.41		
5	1	0	64-QAM	21.56	21.58	21.72	21.83	0.1524
5	1	12		21.59	21.64	21.83		
5	1	24		21.43	21.62	21.76		
5	12	0		20.41	20.47	20.54		
5	12	7		20.48	20.50	20.51		
5	12	13		20.43	20.33	20.58		
5	25	0		20.39	20.38	20.44		



LTE Band 25 Maximum Average Power [dBm]								
BW [MHz]	RB Size	RB Offset	Mod	Lowest	Middle	Highest	Maximum Output Power (dBm)	Maximum Output Power (W)
3	1	0	QPSK	23.23	23.35	23.36	23.44	0.2208
3	1	8		23.28	23.44	23.42		
3	1	14		23.11	23.23	23.35		
3	8	0		22.18	22.14	22.37		
3	8	4		22.42	22.23	22.36		
3	8	7		22.27	22.19	22.32		
3	15	0		22.29	22.33	22.27		
3	1	0	16-QAM	22.66	22.70	22.70	22.74	0.1879
3	1	8		22.73	22.74	22.70		
3	1	14		22.46	22.65	22.71		
3	8	0		21.48	21.30	21.47		
3	8	4		21.42	21.43	21.37		
3	8	7		21.32	21.31	21.65		
3	15	0		21.33	21.49	21.33		
3	1	0	64-QAM	21.53	21.55	21.70	21.80	0.1514
3	1	8		21.52	21.57	21.80		
3	1	14		21.36	21.54	21.73		
3	8	0		20.38	20.46	20.44		
3	8	4		20.42	20.50	20.51		
3	8	7		20.36	20.26	20.48		
3	15	0		20.32	20.34	20.39		



LTE Band 25 Maximum Average Power [dBm]								
BW [MHz]	RB Size	RB Offset	Mod	Lowest	Middle	Highest	Maximum Output Power (dBm)	Maximum Output Power (W)
1.4	1	0	QPSK	23.15	23.32	23.27	23.43	0.2203
1.4	1	3		23.21	23.43	23.40		
1.4	1	5		23.08	23.17	23.29		
1.4	3	0		22.14	22.11	22.37		
1.4	3	1		22.33	22.16	22.36		
1.4	3	3		22.26	22.11	22.23		
1.4	6	0		21.22	21.25	21.27		
1.4	1	0	16-QAM	22.63	22.70	22.60	22.72	0.1871
1.4	1	3		22.71	22.72	22.70		
1.4	1	5		22.43	22.61	22.64		
1.4	3	0		21.44	21.20	21.47		
1.4	3	1		21.34	21.35	21.37		
1.4	3	3		21.32	21.23	21.63		
1.4	6	0		20.24	20.41	20.27		
1.4	1	0	64-QAM	21.46	21.45	21.65	21.77	0.1503
1.4	1	3		21.43	21.54	21.77		
1.4	1	5		21.36	21.52	21.64		
1.4	3	0		20.32	20.44	20.42		
1.4	3	1		20.32	20.45	20.47		
1.4	3	3		20.30	20.22	20.38		
1.4	6	0		19.26	19.30	19.35		



LTE Band 4 Maximum Average Power [dBm]								
BW [MHz]	RB Size	RB Offset	Mod	Lowest	Middle	Highest	Maximum Output Power (dBm)	Maximum Output Power (W)
20	1	0	QPSK	23.69	23.76	23.75	23.80	0.2399
20	1	49		23.76	23.80	23.77		
20	1	99		23.73	23.77	23.72		
20	50	0		22.81	22.82	22.75		
20	50	24		22.83	22.87	22.82		
20	50	50		22.88	22.70	22.75		
20	100	0		22.82	22.75	22.81		
20	1	0	16-QAM	22.97	22.95	22.97	22.99	0.1991
20	1	49		22.91	22.97	22.94		
20	1	99		22.99	22.94	22.97		
20	50	0		21.90	21.86	21.79		
20	50	24		21.87	21.85	21.88		
20	50	50		21.93	21.78	21.79		
20	100	0		21.86	21.82	21.84		
20	1	0	64-QAM	21.95	21.93	21.95	21.98	0.1578
20	1	49		21.93	21.96	21.98		
20	1	99		21.96	21.90	21.93		
20	50	0		20.88	20.86	20.82		
20	50	24		20.88	20.85	20.86		
20	50	50		20.91	20.75	20.79		
20	100	0		20.85	20.81	20.83		



LTE Band 4 Maximum Average Power [dBm]								
BW [MHz]	RB Size	RB Offset	Mod	Lowest	Middle	Highest	Maximum Output Power (dBm)	Maximum Output Power (W)
15	1	0	QPSK	23.59	23.76	23.74	23.78	0.2388
15	1	37		23.68	23.78	23.74		
15	1	74		23.65	23.67	23.62		
15	36	0		22.76	22.74	22.75		
15	36	20		22.73	22.82	22.74		
15	36	39		22.81	22.68	22.67		
15	75	0		22.74	22.68	22.79		
15	1	0	16-QAM	22.87	22.88	22.97	22.97	0.1982
15	1	37		22.83	22.87	22.85		
15	1	74		22.97	22.86	22.97		
15	36	0		21.90	21.82	21.70		
15	36	20		21.83	21.82	21.81		
15	36	39		21.86	21.68	21.79		
15	75	0		21.85	21.77	21.80		
15	1	0	64-QAM	21.88	21.85	21.89	21.96	0.1570
15	1	37		21.83	21.96	21.95		
15	1	74		21.86	21.85	21.84		
15	36	0		20.86	20.86	20.73		
15	36	20		20.83	20.82	20.82		
15	36	39		20.84	20.71	20.78		
15	75	0		20.76	20.79	20.74		



LTE Band 4 Maximum Average Power [dBm]								
BW [MHz]	RB Size	RB Offset	Mod	Lowest	Middle	Highest	Maximum Output Power (dBm)	Maximum Output Power (W)
10	1	0	QPSK	23.54	23.69	23.74	23.74	0.2366
10	1	25		23.67	23.71	23.74		
10	1	49		23.65	23.66	23.54		
10	25	0		22.70	22.64	22.75		
10	25	12		22.71	22.82	22.70		
10	25	25		22.77	22.62	22.59		
10	50	0		22.74	22.67	22.75		
10	1	0	16-QAM	22.84	22.79	22.97	22.97	0.1982
10	1	25		22.75	22.82	22.75		
10	1	49		22.94	22.78	22.91		
10	25	0		21.89	21.78	21.61		
10	25	12		21.83	21.76	21.72		
10	25	25		21.85	21.65	21.71		
10	50	0		21.79	21.70	21.77		
10	1	0	64-QAM	21.88	21.78	21.89	21.96	0.1570
10	1	25		21.81	21.96	21.95		
10	1	49		21.85	21.79	21.80		
10	25	0		20.76	20.86	20.64		
10	25	12		20.80	20.72	20.78		
10	25	25		20.77	20.70	20.72		
10	50	0		20.73	20.73	20.65		



LTE Band 4 Maximum Average Power [dBm]								
BW [MHz]	RB Size	RB Offset	Mod	Lowest	Middle	Highest	Maximum Output Power (dBm)	Maximum Output Power (W)
5	1	0	QPSK	23.46	23.69	23.67	23.70	0.2344
5	1	12		23.61	23.70	23.65		
5	1	24		23.57	23.60	23.47		
5	12	0		22.64	22.60	22.69		
5	12	7		22.65	22.76	22.64		
5	12	13		22.75	22.54	22.53		
5	25	0		22.67	22.65	22.67		
5	1	0	16-QAM	22.74	22.75	22.92	22.92	0.1959
5	1	12		22.71	22.75	22.71		
5	1	24		22.87	22.74	22.81		
5	12	0		21.89	21.70	21.58		
5	12	7		21.78	21.76	21.71		
5	12	13		21.82	21.65	21.62		
5	25	0		21.79	21.69	21.67		
5	1	0	64-QAM	21.84	21.69	21.81	21.95	0.1567
5	1	12		21.71	21.95	21.90		
5	1	24		21.79	21.75	21.72		
5	12	0		20.75	20.82	20.64		
5	12	7		20.71	20.66	20.69		
5	12	13		20.76	20.67	20.70		
5	25	0		20.71	20.65	20.62		



LTE Band 4 Maximum Average Power [dBm]								
BW [MHz]	RB Size	RB Offset	Mod	Lowest	Middle	Highest	Maximum Output Power (dBm)	Maximum Output Power (W)
3	1	0	QPSK	23.37	23.66	23.60	23.66	0.2323
3	1	8		23.56	23.62	23.65		
3	1	14		23.55	23.53	23.47		
3	8	0		22.61	22.51	22.67		
3	8	4		22.59	22.70	22.57		
3	8	7		22.67	22.53	22.50		
3	15	0		22.60	22.62	22.60		
3	1	0	16-QAM	22.69	22.69	22.89	22.89	0.1945
3	1	8		22.71	22.67	22.66		
3	1	14		22.87	22.64	22.73		
3	8	0		21.84	21.60	21.54		
3	8	4		21.78	21.71	21.70		
3	8	7		21.72	21.62	21.59		
3	15	0		21.79	21.62	21.64		
3	1	0	64-QAM	21.81	21.66	21.81	21.87	0.1538
3	1	8		21.66	21.87	21.84		
3	1	14		21.78	21.65	21.62		
3	8	0		20.70	20.81	20.62		
3	8	4		20.69	20.60	20.68		
3	8	7		20.69	20.58	20.61		
3	15	0		20.68	20.61	20.54		



LTE Band 4 Maximum Average Power [dBm]								
BW [MHz]	RB Size	RB Offset	Mod	Lowest	Middle	Highest	Maximum Output Power (dBm)	Maximum Output Power (W)
1.4	1	0	QPSK	23.34	23.63	23.59	23.63	0.2307
1.4	1	3		23.54	23.55	23.61		
1.4	1	5		23.52	23.49	23.45		
1.4	3	0		22.51	22.49	22.61		
1.4	3	1		22.50	22.69	22.51		
1.4	3	3		22.59	22.43	22.48		
1.4	6	0		21.54	21.53	21.59		
1.4	1	0	16-QAM	22.61	22.64	22.81	22.81	0.1910
1.4	1	3		22.67	22.65	22.56		
1.4	1	5		22.78	22.56	22.69		
1.4	3	0		21.80	21.54	21.51		
1.4	3	1		21.78	21.71	21.70		
1.4	3	3		21.64	21.61	21.59		
1.4	6	0		20.77	20.57	20.58		
1.4	1	0	64-QAM	21.79	21.66	21.71	21.85	0.1531
1.4	1	3		21.56	21.85	21.83		
1.4	1	5		21.77	21.56	21.57		
1.4	3	0		20.70	20.71	20.53		
1.4	3	1		20.68	20.50	20.63		
1.4	3	3		20.69	20.58	20.60		
1.4	6	0		19.61	19.58	19.45		



LTE Band 5 Maximum Average Power [dBm]								
BW [MHz]	RB Size	RB Offset	Mod	Lowest	Middle	Highest	Maximum Output Power (dBm)	Maximum Output Power (W)
10	1	0	QPSK	23.77	23.68	23.56	23.77	0.2382
10	1	25		23.74	23.62	23.58		
10	1	49		23.66	23.53	23.51		
10	25	0		22.86	22.76	22.65		
10	25	12		22.84	22.74	22.73		
10	25	25		22.79	22.72	22.67		
10	50	0		22.85	22.76	22.66		
10	1	0	16-QAM	22.94	22.91	22.75	22.94	0.1968
10	1	25		22.92	22.81	22.83		
10	1	49		22.91	22.76	22.58		
10	25	0		21.86	21.71	21.61		
10	25	12		21.88	21.73	21.70		
10	25	25		21.81	21.65	21.63		
10	50	0		21.82	21.71	21.60		
10	1	0	64-QAM	22.00	21.88	21.74	22.00	0.1585
10	1	25		21.95	21.79	21.76		
10	1	49		21.87	21.68	21.55		
10	25	0		20.90	20.78	20.65		
10	25	12		20.84	20.73	20.73		
10	25	25		20.78	20.65	20.63		
10	50	0		20.85	20.71	20.60		



LTE Band 5 Maximum Average Power [dBm]								
BW [MHz]	RB Size	RB Offset	Mod	Lowest	Middle	Highest	Maximum Output Power (dBm)	Maximum Output Power (W)
5	1	0	QPSK	23.76	23.61	23.53	23.76	0.2377
5	1	12		23.71	23.61	23.48		
5	1	24		23.63	23.50	23.49		
5	12	0		22.83	22.71	22.62		
5	12	7		22.83	22.70	22.66		
5	12	13		22.71	22.68	22.66		
5	25	0		22.79	22.69	22.63		
5	1	0	16-QAM	22.92	22.85	22.72	22.92	0.1959
5	1	12		22.89	22.78	22.83		
5	1	24		22.84	22.73	22.55		
5	12	0		21.85	21.63	21.54		
5	12	7		21.80	21.72	21.66		
5	12	13		21.73	21.61	21.63		
5	25	0		21.77	21.62	21.60		
5	1	0	64-QAM	22.00	21.84	21.74	22.00	0.1585
5	1	12		21.91	21.77	21.74		
5	1	24		21.83	21.62	21.53		
5	12	0		20.84	20.69	20.59		
5	12	7		20.75	20.67	20.68		
5	12	13		20.72	20.57	20.60		
5	25	0		20.81	20.65	20.55		



LTE Band 5 Maximum Average Power [dBm]								
BW [MHz]	RB Size	RB Offset	Mod	Lowest	Middle	Highest	Maximum Output Power (dBm)	Maximum Output Power (W)
3	1	0	QPSK	23.69	23.55	23.46	23.69	0.2339
3	1	8		23.69	23.52	23.43		
3	1	14		23.61	23.49	23.41		
3	8	0		22.83	22.63	22.53		
3	8	4		22.76	22.67	22.63		
3	8	7		22.66	22.60	22.61		
3	15	0		22.71	22.67	22.54		
3	1	0	16-QAM	22.82	22.83	22.72	22.83	0.1919
3	1	8		22.80	22.69	22.73		
3	1	14		22.77	22.69	22.45		
3	8	0		21.81	21.60	21.53		
3	8	4		21.80	21.65	21.65		
3	8	7		21.68	21.51	21.63		
3	15	0		21.70	21.62	21.57		
3	1	0	64-QAM	21.92	21.76	21.67	21.92	0.1556
3	1	8		21.86	21.77	21.73		
3	1	14		21.79	21.61	21.44		
3	8	0		20.76	20.66	20.54		
3	8	4		20.70	20.59	20.59		
3	8	7		20.64	20.57	20.51		
3	15	0		20.74	20.64	20.48		



LTE Band 5 Maximum Average Power [dBm]								
BW [MHz]	RB Size	RB Offset	Mod	Lowest	Middle	Highest	Maximum Output Power (dBm)	Maximum Output Power (W)
1.4	1	0	QPSK	23.61	23.52	23.37	23.61	0.2296
1.4	1	3		23.60	23.47	23.43		
1.4	1	5		23.59	23.41	23.37		
1.4	3	0		22.81	22.62	22.43		
1.4	3	1		22.67	22.62	22.55		
1.4	3	3		22.59	22.56	22.53		
1.4	6	0		21.65	21.67	21.47		
1.4	1	0	16-QAM	22.79	22.74	22.64	22.79	0.1901
1.4	1	3		22.74	22.60	22.72		
1.4	1	5		22.71	22.63	22.45		
1.4	3	0		21.78	21.58	21.52		
1.4	3	1		21.79	21.59	21.61		
1.4	3	3		21.63	21.43	21.62		
1.4	6	0		20.62	20.54	20.47		
1.4	1	0	64-QAM	21.82	21.68	21.61	21.85	0.1531
1.4	1	3		21.85	21.67	21.68		
1.4	1	5		21.72	21.54	21.42		
1.4	3	0		20.66	20.62	20.52		
1.4	3	1		20.66	20.49	20.50		
1.4	3	3		20.57	20.47	20.47		
1.4	6	0		19.68	19.64	19.38		



LTE Band 7 Maximum Average Power [dBm]								
BW [MHz]	RB Size	RB Offset	Mod	Lowest	Middle	Highest	Maximum Output Power (dBm)	Maximum Output Power (W)
20	1	0	QPSK	23.61	23.95	23.92	23.98	0.2500
20	1	49		23.77	23.92	23.94		
20	1	99		23.97	23.85	23.98		
20	50	0		22.80	22.91	22.98		
20	50	24		22.92	22.85	22.91		
20	50	50		22.94	22.97	22.91		
20	100	0		22.90	22.88	22.98		
20	1	0	16-QAM	23.00	22.90	22.82	23.00	0.1995
20	1	49		22.95	22.95	22.86		
20	1	99		22.94	22.97	22.92		
20	50	0		21.88	21.86	21.83		
20	50	24		21.95	21.86	21.93		
20	50	50		21.97	21.94	21.77		
20	100	0		21.93	21.98	21.87		
20	1	0	64-QAM	21.93	21.97	21.88	21.98	0.1578
20	1	49		21.98	21.87	21.91		
20	1	99		21.85	21.68	21.83		
20	50	0		20.88	20.74	20.88		
20	50	24		20.81	20.87	20.99		
20	50	50		20.95	20.91	20.77		
20	100	0		20.92	20.77	20.84		



LTE Band 7 Maximum Average Power [dBm]								
BW [MHz]	RB Size	RB Offset	Mod	Lowest	Middle	Highest	Maximum Output Power (dBm)	Maximum Output Power (W)
15	1	0	QPSK	23.61	23.93	23.85	23.93	0.2472
15	1	37		23.76	23.90	23.92		
15	1	74		23.93	23.85	23.92		
15	36	0		22.76	22.87	22.97		
15	36	20		22.88	22.85	22.81		
15	36	39		22.92	22.88	22.86		
15	75	0		22.89	22.87	22.89		
15	1	0	16-QAM	22.99	22.90	22.73	22.99	0.1991
15	1	37		22.87	22.93	22.79		
15	1	74		22.89	22.92	22.87		
15	36	0		21.87	21.83	21.76		
15	36	20		21.90	21.83	21.87		
15	36	39		21.92	21.84	21.77		
15	75	0		21.91	21.93	21.80		
15	1	0	64-QAM	21.86	21.97	21.81	21.97	0.1574
15	1	37		21.92	21.87	21.82		
15	1	74		21.85	21.59	21.82		
15	36	0		20.79	20.74	20.82		
15	36	20		20.74	20.82	20.93		
15	36	39		20.87	20.84	20.76		
15	75	0		20.85	20.68	20.77		



LTE Band 7 Maximum Average Power [dBm]								
BW [MHz]	RB Size	RB Offset	Mod	Lowest	Middle	Highest	Maximum Output Power (dBm)	Maximum Output Power (W)
10	1	0	QPSK	23.52	23.85	23.85	23.93	0.2472
10	1	25		23.66	23.80	23.83		
10	1	49		23.93	23.76	23.86		
10	25	0		22.69	22.84	22.96		
10	25	12		22.84	22.75	22.74		
10	25	25		22.87	22.84	22.80		
10	50	0		22.89	22.83	22.80		
10	1	0	16-QAM	22.90	22.86	22.70	22.92	0.1959
10	1	25		22.83	22.92	22.69		
10	1	49		22.84	22.88	22.82		
10	25	0		21.87	21.74	21.74		
10	25	12		21.90	21.78	21.79		
10	25	25		21.91	21.83	21.68		
10	50	0		21.82	21.84	21.75		
10	1	0	64-QAM	21.79	21.96	21.73	21.96	0.1570
10	1	25		21.84	21.78	21.76		
10	1	49		21.80	21.52	21.78		
10	25	0		20.71	20.67	20.75		
10	25	12		20.67	20.77	20.93		
10	25	25		20.80	20.75	20.69		
10	50	0		20.84	20.65	20.68		



LTE Band 7 Maximum Average Power [dBm]								
BW [MHz]	RB Size	RB Offset	Mod	Lowest	Middle	Highest	Maximum Output Power (dBm)	Maximum Output Power (W)
5	1	0	QPSK	23.44	23.76	23.81	23.92	0.2466
5	1	12		23.59	23.80	23.78		
5	1	24		23.92	23.70	23.80		
5	12	0		22.60	22.82	22.86		
5	12	7		22.82	22.65	22.64		
5	12	13		22.87	22.80	22.78		
5	25	0		22.85	22.80	22.79		
5	1	0	16-QAM	22.88	22.78	22.70	22.92	0.1959
5	1	12		22.83	22.92	22.65		
5	1	24		22.75	22.87	22.75		
5	12	0		21.78	21.64	21.73		
5	12	7		21.89	21.68	21.78		
5	12	13		21.88	21.81	21.65		
5	25	0		21.75	21.74	21.65		
5	1	0	64-QAM	21.75	21.95	21.72	21.95	0.1567
5	1	12		21.74	21.73	21.68		
5	1	24		21.75	21.49	21.74		
5	12	0		20.64	20.66	20.74		
5	12	7		20.58	20.77	20.85		
5	12	13		20.75	20.68	20.67		
5	25	0		20.74	20.55	20.58		



LTE Band 12 Maximum Average Power [dBm]								
BW [MHz]	RB Size	RB Offset	Mod	Lowest	Middle	Highest	Maximum Output Power (dBm)	Maximum Output Power (W)
10	1	0	QPSK	23.36	23.31	23.20	23.36	0.2168
10	1	25		23.27	23.22	23.17		
10	1	49		23.22	23.16	23.10		
10	25	0		22.37	22.31	22.29		
10	25	12		22.40	22.35	22.28		
10	25	25		22.34	22.28	22.27		
10	50	0		22.39	22.32	22.27		
10	1	0	16-QAM	22.51	22.47	22.49	22.52	0.1786
10	1	25		22.47	22.52	22.37		
10	1	49		22.51	22.33	22.28		
10	25	0		21.31	21.33	21.27		
10	25	12		21.35	21.36	21.29		
10	25	25		21.35	21.27	21.20		
10	50	0		21.36	21.29	21.28		
10	1	0	64-QAM	21.49	21.44	21.37	21.49	0.1409
10	1	25		21.39	21.41	21.29		
10	1	49		21.47	21.33	21.21		
10	25	0		20.31	20.28	20.25		
10	25	12		20.39	20.31	20.25		
10	25	25		20.32	20.27	20.20		
10	50	0		20.33	20.33	20.24		



LTE Band 12 Maximum Average Power [dBm]								
BW [MHz]	RB Size	RB Offset	Mod	Lowest	Middle	Highest	Maximum Output Power (dBm)	Maximum Output Power (W)
5	1	0	QPSK	23.31	23.24	23.18	23.31	0.2143
5	1	12		23.24	23.15	23.15		
5	1	24		23.17	23.10	23.07		
5	12	0		22.31	22.24	22.26		
5	12	7		22.34	22.33	22.28		
5	12	13		22.24	22.19	22.22		
5	25	0		22.34	22.27	22.24		
5	1	0	16-QAM	22.46	22.41	22.48	22.51	0.1782
5	1	12		22.45	22.51	22.36		
5	1	24		22.43	22.24	22.18		
5	12	0		21.31	21.29	21.18		
5	12	7		21.29	21.29	21.20		
5	12	13		21.26	21.19	21.14		
5	25	0		21.30	21.29	21.23		
5	1	0	64-QAM	21.43	21.38	21.27	21.45	0.1396
5	1	12		21.35	21.40	21.23		
5	1	24		21.45	21.30	21.17		
5	12	0		20.24	20.21	20.20		
5	12	7		20.37	20.30	20.22		
5	12	13		20.23	20.20	20.10		
5	25	0		20.26	20.29	20.20		



LTE Band 12 Maximum Average Power [dBm]								
BW [MHz]	RB Size	RB Offset	Mod	Lowest	Middle	Highest	Maximum Output Power (dBm)	Maximum Output Power (W)
3	1	0	QPSK	23.31	23.21	23.08	23.31	0.2143
3	1	8		23.19	23.08	23.05		
3	1	14		23.10	23.07	23.05		
3	8	0		22.25	22.14	22.23		
3	8	4		22.29	22.23	22.23		
3	8	7		22.16	22.13	22.13		
3	15	0		22.28	22.23	22.18		
3	1	0	16-QAM	22.44	22.34	22.41	22.46	0.1762
3	1	8		22.41	22.46	22.26		
3	1	14		22.41	22.20	22.12		
3	8	0		21.31	21.21	21.15		
3	8	4		21.19	21.28	21.15		
3	8	7		21.17	21.10	21.06		
3	15	0		21.20	21.26	21.14		
3	1	0	64-QAM	21.43	21.35	21.24	21.43	0.1390
3	1	8		21.25	21.31	21.21		
3	1	14		21.35	21.24	21.09		
3	8	0		20.23	20.19	20.10		
3	8	4		20.32	20.25	20.14		
3	8	7		20.15	20.14	20.04		
3	15	0		20.22	20.20	20.11		



LTE Band 12 Maximum Average Power [dBm]								
BW [MHz]	RB Size	RB Offset	Mod	Lowest	Middle	Highest	Maximum Output Power (dBm)	Maximum Output Power (W)
1.4	1	0	QPSK	23.29	23.21	22.99	23.29	0.2133
1.4	1	3		23.14	23.07	23.00		
1.4	1	5		23.02	22.99	23.04		
1.4	3	0		22.23	22.06	22.16		
1.4	3	1		22.25	22.22	22.19		
1.4	3	3		22.11	22.11	22.05		
1.4	6	0		21.29	21.20	21.16		
1.4	1	0	16-QAM	22.39	22.28	22.32	22.43	0.1750
1.4	1	3		22.32	22.43	22.24		
1.4	1	5		22.32	22.18	22.11		
1.4	3	0		21.24	21.18	21.06		
1.4	3	1		21.10	21.19	21.13		
1.4	3	3		21.17	21.10	21.03		
1.4	6	0		20.18	20.23	20.10		
1.4	1	0	64-QAM	21.33	21.33	21.20	21.33	0.1358
1.4	1	3		21.25	21.29	21.12		
1.4	1	5		21.27	21.18	21.01		
1.4	3	0		20.15	20.09	20.03		
1.4	3	1		20.25	20.23	20.07		
1.4	3	3		20.07	20.05	20.02		
1.4	6	0		19.20	19.13	19.03		



LTE Band 13 Maximum Average Power [dBm]								
BW [MHz]	RB Size	RB Offset	Mod	Lowest	Middle	Highest	Maximum Output Power (dBm)	Maximum Output Power (W)
10	1	0	QPSK		23.27		23.44	0.2208
10	1	25			23.44			
10	1	49			23.44			
10	25	0			22.52			
10	25	12			22.57			
10	25	25			22.51			
10	50	0			22.59			
10	1	0	16-QAM	-	22.39	-	22.61	0.1824
10	1	25			22.48			
10	1	49			22.61			
10	25	0			21.43			
10	25	12			21.50			
10	25	25			21.44			
10	50	0			21.50			
10	1	0	64-QAM		21.35		21.59	0.1442
10	1	25			21.50			
10	1	49			21.59			
10	25	0			20.44			
10	25	12			20.53			
10	25	25			20.45			
10	50	0			20.53			



LTE Band 13 Maximum Average Power [dBm]								
BW [MHz]	RB Size	RB Offset	Mod	Lowest	Middle	Highest	Maximum Output Power (dBm)	Maximum Output Power (W)
5	1	0	QPSK	23.15	23.21	23.17	23.38	0.2178
5	1	12		23.27	23.35	23.30		
5	1	24		23.25	23.38	23.35		
5	12	0		22.43	22.52	22.46		
5	12	7		22.41	22.54	22.42		
5	12	13		22.35	22.43	22.31		
5	25	0		22.42	22.51	22.48		
5	1	0	16-QAM	22.23	22.30	22.25	22.55	0.1799
5	1	12		22.29	22.38	22.26		
5	1	24		22.48	22.55	22.53		
5	12	0		21.28	21.42	21.32		
5	12	7		21.44	21.50	21.39		
5	12	13		21.21	21.34	21.28		
5	25	0		21.38	21.48	21.42		
5	1	0	64-QAM	21.30	21.35	21.25	21.59	0.1442
5	1	12		21.37	21.44	21.39		
5	1	24		21.49	21.59	21.56		
5	12	0		20.24	20.34	20.28		
5	12	7		20.36	20.50	20.44		
5	12	13		20.24	20.38	20.26		
5	25	0		20.37	20.44	20.38		



LTE Band 26 Maximum Average Power [dBm]								
BW [MHz]	RB Size	RB Offset	Mod	Lowest	Middle	Highest	Maximum Output Power (dBm)	Maximum Output Power (W)
15	1	0	QPSK	23.69	23.88	23.63	23.88	0.2443
15	1	37		23.72	23.70	23.55		
15	1	74		23.58	23.72	23.38		
15	36	0		22.83	22.94	22.70		
15	36	20		22.83	22.88	22.68		
15	36	39		22.77	23.05	22.60		
15	75	0		22.81	22.79	22.66		
15	1	0	16-QAM	22.97	22.79	22.89	23.16	0.2070
15	1	37		22.99	23.16	22.78		
15	1	74		22.78	22.77	22.49		
15	36	0		21.82	21.73	21.66		
15	36	20		21.85	21.81	21.67		
15	36	39		21.72	22.12	21.57		
15	75	0		21.78	22.05	21.64		
15	1	0	64-QAM	21.89	21.87	21.82	22.05	0.1603
15	1	37		21.91	21.82	21.71		
15	1	74		21.75	22.05	21.48		
15	36	0		20.87	20.77	20.74		
15	36	20		20.86	20.95	20.68		
15	36	39		20.79	21.10	20.64		
15	75	0		20.82	20.75	20.63		



LTE Band 26 Maximum Average Power [dBm]								
BW [MHz]	RB Size	RB Offset	Mod	Lowest	Middle	Highest	Maximum Output Power (dBm)	Maximum Output Power (W)
10	1	0	QPSK	23.74	23.67	23.57	23.83	0.2415
10	1	25		23.83	23.62	23.47		
10	1	49		23.73	23.64	23.33		
10	25	0		22.98	22.76	22.62		
10	25	12		22.85	22.75	22.66		
10	25	25		22.88	22.72	22.51		
10	50	0		22.91	22.69	22.61		
10	1	0	16-QAM	22.96	23.00	22.79	23.00	0.1995
10	1	25		22.94	22.94	22.69		
10	1	49		22.91	22.69	22.43		
10	25	0		21.79	21.71	21.60		
10	25	12		21.88	21.81	21.60		
10	25	25		21.86	21.72	21.56		
10	50	0		21.66	21.72	21.57		
10	1	0	64-QAM	21.93	21.83	21.79	22.03	0.1596
10	1	25		21.81	21.87	21.66		
10	1	49		22.03	21.69	21.40		
10	25	0		20.75	20.96	20.73		
10	25	12		21.00	20.86	20.63		
10	25	25		20.79	20.87	20.63		
10	50	0		20.88	20.85	20.57		



LTE Band 26 Maximum Average Power [dBm]								
BW [MHz]	RB Size	RB Offset	Mod	Lowest	Middle	Highest	Maximum Output Power (dBm)	Maximum Output Power (W)
5	1	0	QPSK	23.65	23.49	23.48	23.71	0.2350
5	1	12		23.71	23.64	23.41		
5	1	24		23.70	23.54	23.32		
5	12	0		22.74	22.60	22.54		
5	12	7		22.78	22.87	22.61		
5	12	13		22.77	22.62	22.51		
5	25	0		22.88	22.67	22.59		
5	1	0	16-QAM	22.83	22.92	22.72	22.99	0.1991
5	1	12		22.87	22.99	22.68		
5	1	24		22.70	22.74	22.39		
5	12	0		21.83	21.72	21.52		
5	12	7		21.77	21.71	21.53		
5	12	13		21.83	21.63	21.53		
5	25	0		21.67	21.73	21.54		
5	1	0	64-QAM	21.79	21.82	21.75	21.97	0.1574
5	1	12		21.81	21.83	21.61		
5	1	24		21.97	21.65	21.38		
5	12	0		20.74	20.69	20.63		
5	12	7		20.77	20.68	20.62		
5	12	13		20.87	20.74	20.53		
5	25	0		20.78	20.70	20.52		



LTE Band 26 Maximum Average Power [dBm]								
BW [MHz]	RB Size	RB Offset	Mod	Lowest	Middle	Highest	Maximum Output Power (dBm)	Maximum Output Power (W)
3	1	0	QPSK	23.47	23.57	23.42	23.64	0.2312
3	1	8		23.57	23.64	23.41		
3	1	14		23.53	23.57	23.26		
3	8	0		22.71	22.47	22.44		
3	8	4		22.65	22.69	22.51		
3	8	7		22.85	22.56	22.42		
3	15	0		22.82	22.55	22.50		
3	1	0	16-QAM	22.76	22.79	22.72	22.88	0.1941
3	1	8		22.73	22.88	22.58		
3	1	14		22.84	22.57	22.32		
3	8	0		21.67	21.63	21.50		
3	8	4		21.74	21.68	21.48		
3	8	7		21.67	21.53	21.53		
3	15	0		21.63	21.72	21.47		
3	1	0	64-QAM	21.67	21.76	21.69	21.92	0.1556
3	1	8		21.80	21.79	21.53		
3	1	14		21.92	21.54	21.30		
3	8	0		20.60	20.70	20.53		
3	8	4		20.89	20.69	20.55		
3	8	7		20.88	20.71	20.52		
3	15	0		20.76	20.60	20.49		



LTE Band 26 Maximum Average Power [dBm]								
BW [MHz]	RB Size	RB Offset	Mod	Lowest	Middle	Highest	Maximum Output Power (dBm)	Maximum Output Power (W)
1.4	1	0	QPSK	23.53	23.55	23.32	23.66	0.2323
1.4	1	3		23.66	23.61	23.35		
1.4	1	5		23.64	23.47	23.17		
1.4	3	0		22.65	22.56	22.44		
1.4	3	1		22.68	22.76	22.45		
1.4	3	3		22.89	22.55	22.34		
1.4	6	0		21.83	21.59	21.48		
1.4	1	0	16-QAM	22.62	22.84	22.69	22.84	0.1923
1.4	1	3		22.69	22.77	22.56		
1.4	1	5		22.75	22.44	22.27		
1.4	3	0		21.73	21.58	21.40		
1.4	3	1		21.68	21.65	21.39		
1.4	3	3		21.80	21.62	21.47		
1.4	6	0		20.75	20.49	20.38		
1.4	1	0	64-QAM	21.67	21.71	21.60	21.78	0.1507
1.4	1	3		21.78	21.78	21.51		
1.4	1	5		21.76	21.38	21.20		
1.4	3	0		20.68	20.74	20.51		
1.4	3	1		20.89	20.70	20.48		
1.4	3	3		20.86	20.68	20.45		
1.4	6	0		19.59	19.65	19.41		



LTE Band 41 Maximum Average Power [dBm]								
BW [MHz]	RB Size	RB Offset	Mod	Lowest	Middle	Highest	Maximum Output Power (dBm)	Maximum Output Power (W)
20	1	0	QPSK	23.20	23.30	22.81	23.32	0.2148
20	1	49		23.17	23.24	22.76		
20	1	99		23.28	23.32	22.87		
20	50	0		22.25	22.12	21.68		
20	50	24		22.25	22.11	21.72		
20	50	50		22.23	22.11	21.68		
20	100	0		22.22	22.10	21.65		
20	1	0	16-QAM	22.33	22.61	22.00	22.61	0.1824
20	1	49		22.39	22.33	22.15		
20	1	99		22.44	22.54	21.98		
20	50	0		21.31	21.28	20.84		
20	50	24		21.33	21.30	20.82		
20	50	50		21.33	21.27	20.84		
20	100	0		21.31	21.23	20.80		
20	1	0	64-QAM	21.14	21.20	20.77	21.20	0.1318
20	1	49		21.10	21.17	20.73		
20	1	99		21.15	21.18	20.73		
20	50	0		20.31	20.22	19.85		
20	50	24		20.29	20.25	19.88		
20	50	50		20.33	20.24	19.87		
20	100	0		20.33	20.20	19.86		



LTE Band 41 Maximum Average Power [dBm]								
BW [MHz]	RB Size	RB Offset	Mod	Lowest	Middle	Highest	Maximum Output Power (dBm)	Maximum Output Power (W)
15	1	0	QPSK	23.13	23.22	22.76	23.26	0.2118
15	1	37		23.13	23.20	22.74		
15	1	74		23.26	23.23	22.84		
15	36	0		22.24	22.05	21.66		
15	36	20		22.21	22.03	21.65		
15	36	39		22.14	22.08	21.58		
15	75	0		22.13	22.07	21.60		
15	1	0	16-QAM	22.29	22.51	21.90	22.51	0.1782
15	1	37		22.37	22.32	22.06		
15	1	74		22.44	22.51	21.91		
15	36	0		21.23	21.18	20.83		
15	36	20		21.31	21.26	20.77		
15	36	39		21.24	21.20	20.75		
15	75	0		21.31	21.18	20.78		
15	1	0	64-QAM	21.11	21.17	20.69	21.17	0.1309
15	1	37		21.08	21.11	20.64		
15	1	74		21.11	21.17	20.72		
15	36	0		20.24	20.18	19.78		
15	36	20		20.20	20.15	19.88		
15	36	39		20.33	20.20	19.86		
15	75	0		20.25	20.10	19.82		



LTE Band 41 Maximum Average Power [dBm]								
BW [MHz]	RB Size	RB Offset	Mod	Lowest	Middle	Highest	Maximum Output Power (dBm)	Maximum Output Power (W)
10	1	0	QPSK	23.07	23.22	22.71	23.22	0.2099
10	1	25		23.06	23.14	22.69		
10	1	49		23.19	23.20	22.81		
10	25	0		22.16	22.00	21.62		
10	25	12		22.18	22.00	21.58		
10	25	25		22.06	22.06	21.52		
10	50	0		22.11	22.07	21.59		
10	1	0	16-QAM	22.22	22.44	21.83	22.44	0.1754
10	1	25		22.34	22.32	22.02		
10	1	49		22.37	22.41	21.89		
10	25	0		21.20	21.08	20.75		
10	25	12		21.21	21.16	20.77		
10	25	25		21.15	21.10	20.75		
10	50	0		21.30	21.16	20.76		
10	1	0	64-QAM	21.05	21.07	20.67	21.15	0.1303
10	1	25		21.03	21.06	20.58		
10	1	49		21.02	21.15	20.68		
10	25	0		20.19	20.08	19.70		
10	25	12		20.19	20.05	19.79		
10	25	25		20.23	20.18	19.81		
10	50	0		20.19	20.02	19.75		



LTE Band 41 Maximum Average Power [dBm]								
BW [MHz]	RB Size	RB Offset	Mod	Lowest	Middle	Highest	Maximum Output Power (dBm)	Maximum Output Power (W)
5	1	0	QPSK	23.04	23.21	22.67	23.21	0.2094
5	1	12		22.98	23.13	22.66		
5	1	24		23.09	23.16	22.76		
5	12	0		22.12	21.99	21.60		
5	12	7		22.11	21.98	21.57		
5	12	13		22.03	22.06	21.49		
5	25	0		22.09	22.02	21.58		
5	1	0	16-QAM	22.19	22.38	21.80	22.38	0.1730
5	1	12		22.30	22.31	22.02		
5	1	24		22.28	22.35	21.83		
5	12	0		21.18	21.03	20.66		
5	12	7		21.17	21.15	20.69		
5	12	13		21.10	21.03	20.66		
5	25	0		21.25	21.13	20.75		
5	1	0	64-QAM	20.97	21.06	20.57	21.11	0.1291
5	1	12		21.03	20.98	20.57		
5	1	24		20.96	21.11	20.62		
5	12	0		20.15	20.06	19.67		
5	12	7		20.10	20.02	19.76		
5	12	13		20.17	20.16	19.72		
5	25	0		20.13	19.96	19.68		



LTE Band 66 Maximum Average Power [dBm]								
BW [MHz]	RB Size	RB Offset	Mod	Lowest	Middle	Highest	Maximum Output Power (dBm)	Maximum Output Power (W)
20	1	0	QPSK	23.89	23.88	23.91	23.93	0.2472
20	1	49		23.84	23.85	23.93		
20	1	99		23.84	23.78	23.81		
20	50	0		22.90	22.90	22.91		
20	50	24		23.00	22.85	22.90		
20	50	50		22.94	22.78	22.87		
20	100	0		22.98	22.83	22.85		
20	1	0	16-QAM	22.98	22.96	22.83	22.98	0.1986
20	1	49		22.83	22.93	22.97		
20	1	99		22.89	22.96	22.78		
20	50	0		21.85	21.95	21.96		
20	50	24		21.95	21.93	21.93		
20	50	50		22.00	21.84	21.95		
20	100	0		21.82	21.89	21.88		
20	1	0	64-QAM	21.72	21.71	21.84	21.94	0.1563
20	1	49		21.82	21.83	21.88		
20	1	99		21.94	21.93	21.92		
20	50	0		20.94	20.96	20.94		
20	50	24		20.92	20.93	20.92		
20	50	50		20.99	20.84	20.92		
20	100	0		20.81	20.89	20.90		



LTE Band 66 Maximum Average Power [dBm]								
BW [MHz]	RB Size	RB Offset	Mod	Lowest	Middle	Highest	Maximum Output Power (dBm)	Maximum Output Power (W)
15	1	0	QPSK	23.88	23.87	23.83	23.91	0.2460
15	1	37		23.77	23.75	23.91		
15	1	74		23.75	23.72	23.77		
15	36	0		22.88	22.89	22.90		
15	36	20		22.98	22.75	22.85		
15	36	39		22.94	22.77	22.79		
15	75	0		22.94	22.73	22.83		
15	1	0	16-QAM	22.88	22.96	22.76	22.96	0.1977
15	1	37		22.82	22.92	22.87		
15	1	74		22.83	22.90	22.77		
15	36	0		21.83	21.85	21.95		
15	36	20		21.92	21.85	21.88		
15	36	39		21.97	21.79	21.88		
15	75	0		21.72	21.84	21.79		
15	1	0	64-QAM	21.70	21.63	21.75	21.92	0.1556
15	1	37		21.74	21.74	21.82		
15	1	74		21.92	21.87	21.87		
15	36	0		20.93	20.94	20.88		
15	36	20		20.87	20.88	20.87		
15	36	39		20.91	20.80	20.92		
15	75	0		20.71	20.85	20.80		



LTE Band 66 Maximum Average Power [dBm]								
BW [MHz]	RB Size	RB Offset	Mod	Lowest	Middle	Highest	Maximum Output Power (dBm)	Maximum Output Power (W)
10	1	0	QPSK	23.81	23.82	23.80	23.84	0.2421
10	1	25		23.74	23.66	23.84		
10	1	49		23.73	23.63	23.71		
10	25	0		22.87	22.84	22.86		
10	25	12		22.89	22.71	22.85		
10	25	25		22.93	22.71	22.77		
10	50	0		22.86	22.73	22.74		
10	1	0	16-QAM	22.86	22.89	22.73	22.89	0.1945
10	1	25		22.80	22.82	22.81		
10	1	49		22.83	22.84	22.67		
10	25	0		21.79	21.81	21.86		
10	25	12		21.83	21.83	21.79		
10	25	25		21.87	21.79	21.86		
10	50	0		21.68	21.82	21.76		
10	1	0	64-QAM	21.67	21.57	21.73	21.87	0.1538
10	1	25		21.71	21.69	21.73		
10	1	49		21.83	21.87	21.78		
10	25	0		20.91	20.94	20.81		
10	25	12		20.85	20.82	20.81		
10	25	25		20.90	20.73	20.92		
10	50	0		20.63	20.84	20.70		



LTE Band 66 Maximum Average Power [dBm]								
BW [MHz]	RB Size	RB Offset	Mod	Lowest	Middle	Highest	Maximum Output Power (dBm)	Maximum Output Power (W)
5	1	0	QPSK	23.72	23.77	23.73	23.77	0.2382
5	1	12		23.71	23.56	23.74		
5	1	24		23.67	23.55	23.68		
5	12	0		22.77	22.74	22.84		
5	12	7		22.81	22.63	22.85		
5	12	13		22.88	22.67	22.76		
5	25	0		22.76	22.67	22.69		
5	1	0	16-QAM	22.77	22.89	22.63	22.89	0.1945
5	1	12		22.72	22.74	22.79		
5	1	24		22.77	22.84	22.65		
5	12	0		21.78	21.81	21.83		
5	12	7		21.77	21.79	21.78		
5	12	13		21.85	21.78	21.80		
5	25	0		21.58	21.78	21.72		
5	1	0	64-QAM	21.58	21.50	21.63	21.84	0.1528
5	1	12		21.62	21.66	21.67		
5	1	24		21.77	21.84	21.73		
5	12	0		20.87	20.86	20.72		
5	12	7		20.75	20.81	20.78		
5	12	13		20.80	20.71	20.87		
5	25	0		20.54	20.82	20.64		



LTE Band 66 Maximum Average Power [dBm]								
BW [MHz]	RB Size	RB Offset	Mod	Lowest	Middle	Highest	Maximum Output Power (dBm)	Maximum Output Power (W)
3	1	0	QPSK	23.68	23.69	23.71	23.71	0.2350
3	1	8		23.69	23.50	23.68		
3	1	14		23.57	23.47	23.68		
3	8	0		22.73	22.74	22.78		
3	8	4		22.81	22.57	22.83		
3	8	7		22.78	22.64	22.67		
3	15	0		22.76	22.62	22.60		
3	1	0	16-QAM	22.71	22.88	22.55	22.88	0.1941
3	1	8		22.65	22.69	22.69		
3	1	14		22.72	22.82	22.63		
3	8	0		21.77	21.79	21.73		
3	8	4		21.74	21.78	21.77		
3	8	7		21.80	21.71	21.73		
3	15	0		21.53	21.77	21.62		
3	1	0	64-QAM	21.51	21.50	21.61	21.84	0.1528
3	1	8		21.58	21.57	21.59		
3	1	14		21.71	21.84	21.71		
3	8	0		20.80	20.84	20.64		
3	8	4		20.69	20.78	20.76		
3	8	7		20.79	20.61	20.85		
3	15	0		20.44	20.72	20.61		



LTE Band 66 Maximum Average Power [dBm]								
BW [MHz]	RB Size	RB Offset	Mod	Lowest	Middle	Highest	Maximum Output Power (dBm)	Maximum Output Power (W)
1.4	1	0	QPSK	23.62	23.67	23.69	23.69	0.2339
1.4	1	3		23.62	23.48	23.60		
1.4	1	5		23.54	23.44	23.66		
1.4	3	0		22.63	22.69	22.72		
1.4	3	1		22.76	22.49	22.82		
1.4	3	3		22.73	22.57	22.62		
1.4	6	0		21.75	21.57	21.59		
1.4	1	0	16-QAM	22.61	22.81	22.55	22.81	0.1910
1.4	1	3		22.58	22.65	22.67		
1.4	1	5		22.70	22.73	22.59		
1.4	3	0		21.67	21.73	21.70		
1.4	3	1		21.70	21.73	21.67		
1.4	3	3		21.75	21.67	21.64		
1.4	6	0		20.48	20.73	20.52		
1.4	1	0	64-QAM	21.43	21.41	21.55	21.74	0.1493
1.4	1	3		21.58	21.49	21.49		
1.4	1	5		21.68	21.74	21.69		
1.4	3	0		20.73	20.84	20.54		
1.4	3	1		20.62	20.68	20.71		
1.4	3	3		20.70	20.59	20.84		
1.4	6	0		19.37	19.66	19.54		



LTE Band 71 Maximum Average Power [dBm]								
BW [MHz]	RB Size	RB Offset	Mod	Lowest	Middle	Highest	Maximum Output Power (dBm)	Maximum Output Power (W)
20	1	0	QPSK	22.58	22.94	23.07	23.45	0.2213
20	1	49		22.92	23.27	23.45		
20	1	99		23.17	23.42	23.45		
20	50	0		21.84	22.33	22.35		
20	50	24		22.02	22.29	22.40		
20	50	50		22.20	22.40	22.57		
20	100	0		22.09	22.25	22.40		
20	1	0	16-QAM	21.90	22.22	22.35	22.77	0.1892
20	1	49		22.31	22.56	22.77		
20	1	99		22.54	22.68	22.67		
20	50	0		20.95	21.32	21.36		
20	50	24		21.09	21.30	21.43		
20	50	50		21.22	21.40	21.55		
20	100	0		21.09	21.24	21.36		
20	1	0	64-QAM	20.87	21.15	21.26	21.65	0.1462
20	1	49		21.19	21.49	21.64		
20	1	99		21.50	21.65	21.63		
20	50	0		19.97	20.34	20.36		
20	50	24		20.11	20.28	20.41		
20	50	50		20.23	20.39	20.53		
20	100	0		20.09	20.22	20.37		



LTE Band 71 Maximum Average Power [dBm]								
BW [MHz]	RB Size	RB Offset	Mod	Lowest	Middle	Highest	Maximum Output Power (dBm)	Maximum Output Power (W)
15	1	0	QPSK	22.51	22.88	23.02	23.41	0.2193
15	1	37		22.88	23.23	23.36		
15	1	74		23.07	23.41	23.41		
15	36	0		21.82	22.30	22.28		
15	36	20		21.99	22.21	22.39		
15	36	39		22.18	22.34	22.56		
15	75	0		22.05	22.21	22.37		
15	1	0	16-QAM	21.81	22.16	22.32	22.67	0.1849
15	1	37		22.30	22.46	22.67		
15	1	74		22.46	22.64	22.64		
15	36	0		20.86	21.30	21.32		
15	36	20		21.03	21.25	21.34		
15	36	39		21.20	21.30	21.47		
15	75	0		21.02	21.15	21.36		
15	1	0	64-QAM	20.82	21.11	21.25	21.62	0.1452
15	1	37		21.12	21.46	21.55		
15	1	74		21.40	21.58	21.62		
15	36	0		19.93	20.32	20.33		
15	36	20		20.07	20.25	20.32		
15	36	39		20.15	20.31	20.52		
15	75	0		20.02	20.15	20.27		



LTE Band 71 Maximum Average Power [dBm]								
BW [MHz]	RB Size	RB Offset	Mod	Lowest	Middle	Highest	Maximum Output Power (dBm)	Maximum Output Power (W)
10	1	0	QPSK	22.43	22.79	23.02	23.41	0.2193
10	1	25		22.88	23.22	23.31		
10	1	49		23.05	23.41	23.41		
10	25	0		21.75	22.26	22.26		
10	25	12		21.89	22.16	22.30		
10	25	25		22.17	22.33	22.49		
10	50	0		21.96	22.15	22.28		
10	1	0	16-QAM	21.74	22.13	22.27	22.61	0.1824
10	1	25		22.23	22.41	22.61		
10	1	49		22.44	22.56	22.60		
10	25	0		20.81	21.20	21.22		
10	25	12		20.94	21.23	21.31		
10	25	25		21.12	21.29	21.43		
10	50	0		20.94	21.10	21.31		
10	1	0	64-QAM	20.80	21.01	21.16	21.55	0.1429
10	1	25		21.10	21.41	21.55		
10	1	49		21.35	21.55	21.54		
10	25	0		19.89	20.29	20.25		
10	25	12		20.01	20.20	20.31		
10	25	25		20.07	20.30	20.49		
10	50	0		20.01	20.05	20.17		



LTE Band 71 Maximum Average Power [dBm]								
BW [MHz]	RB Size	RB Offset	Mod	Lowest	Middle	Highest	Maximum Output Power (dBm)	Maximum Output Power (W)
5	1	0	QPSK	22.42	22.78	22.96	23.38	0.2178
5	1	12		22.86	23.22	23.28		
5	1	24		22.98	23.38	23.35		
5	12	0		21.66	22.19	22.22		
5	12	7		21.80	22.11	22.24		
5	12	13		22.17	22.27	22.46		
5	25	0		21.94	22.11	22.20		
5	1	0	16-QAM	21.74	22.08	22.20	22.60	0.1820
5	1	12		22.18	22.37	22.60		
5	1	24		22.35	22.47	22.56		
5	12	0		20.77	21.20	21.20		
5	12	7		20.84	21.22	21.27		
5	12	13		21.02	21.26	21.43		
5	25	0		20.85	21.00	21.21		
5	1	0	64-QAM	20.71	21.00	21.16	21.52	0.1419
5	1	12		21.02	21.37	21.52		
5	1	24		21.26	21.47	21.44		
5	12	0		19.80	20.25	20.23		
5	12	7		19.95	20.15	20.27		
5	12	13		20.01	20.20	20.42		
5	25	0		20.00	19.99	20.09		



LTE Band 5B_CA Maximum Average Power [dBm]										
BW [MHz]	PCC		SCC		Mod	Lowest	Middle	Highest	Maximum Output Power (dBm)	Maximum Output Power (W)
	RB Size	RB Offset	RB Size	RB Offset						
10+10	50	0	50	0	QPSK	22.02	21.92	21.95	23.81	0.2404
10+10	1	0	1	49		13.54	13.47	13.41		
10+10	1	49	1	0		23.81	23.79	23.69		
10+10	50	0	50	0	16-QAM	20.93	20.94	20.88	23.19	0.2084
10+10	1	0	1	49		13.84	13.65	13.71		
10+10	1	49	1	0		23.19	23.07	23.05		
10+10	50	0	50	0	64-QAM	20.91	20.89	20.91	21.05	0.1274
10+10	1	0	1	49		13.66	13.55	13.68		
10+10	1	49	1	0		21.05	21.02	20.92		
10+5	50	0	25	0	QPSK	21.99	22.01	21.86	23.92	0.2466
10+5	1	0	1	24		14.04	13.96	13.96		
10+5	1	49	1	0		23.86	23.92	23.77		
10+5	50	0	25	0	16-QAM	20.93	20.93	20.86	23.14	0.2061
10+5	1	0	1	24		14.30	14.39	14.08		
10+5	1	49	1	0		23.14	23.04	23.05		
10+5	50	0	25	0	64-QAM	20.93	20.90	20.82	21.20	0.1318
10+5	1	0	1	24		14.34	14.22	14.24		
10+5	1	49	1	0		21.20	20.77	20.91		
5+10	25	0	50	0	QPSK	21.98	21.98	21.94	23.90	0.2455
5+10	1	0	1	49		13.92	13.90	13.91		
5+10	1	24	1	0		23.90	23.81	23.66		
5+10	25	0	50	0	16-QAM	20.99	20.93	20.89	23.08	0.2032
5+10	1	0	1	49		14.43	14.23	14.16		
5+10	1	24	1	0		23.08	23.07	22.83		
5+10	25	0	50	0	64-QAM	20.93	20.90	20.95	21.10	0.1288
5+10	1	0	1	49		14.14	14.31	14.20		
5+10	1	24	1	0		20.94	21.10	21.02		



LTE Band 7C_CA Maximum Average Power [dBm]										
BW [MHz]	PCC		SCC		Mod	Lowest	Middle	Highest	Maximum Output Power (dBm)	Maximum Output Power (W)
	RB Size	RB Offset	RB Size	RB Offset						
20+20	100	0	100	0	QPSK	21.75	21.84	21.84	23.98	0.2500
20+20	1	0	1	99		13.85	13.66	13.66		
20+20	1	99	1	0		23.92	23.98	23.88		
20+20	100	0	100	0	16-QAM	20.84	20.90	20.98	23.38	0.2178
20+20	1	0	1	99		14.31	14.23	14.05		
20+20	1	99	1	0		23.01	23.38	23.21		
20+20	100	0	100	0	64-QAM	20.85	20.92	20.71	21.30	0.1349
20+20	1	0	1	99		14.03	14.01	14.06		
20+20	1	99	1	0		20.91	21.30	21.11		
20+15	100	0	75	0	QPSK	21.82	21.87	21.94	23.88	0.2443
20+15	1	0	1	74		14.09	13.88	14.10		
20+15	1	99	1	0		23.88	23.77	23.85		
20+15	100	0	75	0	16-QAM	20.85	20.92	20.97	23.49	0.2234
20+15	1	0	1	74		14.52	14.51	14.39		
20+15	1	99	1	0		23.32	23.49	23.28		
20+15	100	0	75	0	64-QAM	20.81	20.97	20.93	21.31	0.1352
20+15	1	0	1	74		14.25	14.08	14.22		
20+15	1	99	1	0		21.16	21.31	21.21		
15+20	75	0	100	0	QPSK	21.74	21.84	21.83	23.92	0.2466
15+20	1	0	1	99		14.13	14.04	13.86		
15+20	1	74	1	0		23.92	23.83	23.79		
15+20	75	0	100	0	16-QAM	20.73	20.91	20.97	23.35	0.2163
15+20	1	0	1	99		14.19	14.29	14.02		
15+20	1	74	1	0		22.98	23.35	23.09		
15+20	75	0	100	0	64-QAM	20.74	20.89	20.97	21.39	0.1377
15+20	1	0	1	99		14.21	14.21	14.26		
15+20	1	74	1	0		21.17	21.39	21.04		



LTE Band 7C_CA Maximum Average Power [dBm]										
BW [MHz]	PCC		SCC		Mod	Lowest	Middle	Highest	Maximum Output Power (dBm)	Maximum Output Power (W)
	RB Size	RB Offset	RB Size	RB Offset						
20+10	100	0	75	0	QPSK	21.73	21.86	21.84	23.95	0.2483
20+10	1	0	1	74		13.95	13.94	13.98		
20+10	1	99	1	0		23.93	23.95	23.55		
20+10	100	0	75	0	16-QAM	20.75	20.92	20.96	23.59	0.2286
20+10	1	0	1	74		14.08	14.10	13.93		
20+10	1	99	1	0		23.07	23.24	23.59		
20+10	100	0	75	0	64-QAM	20.79	21.02	20.94	21.41	0.1384
20+10	1	0	1	74		14.13	14.09	14.03		
20+10	1	99	1	0		21.14	21.41	21.09		
10+20	75	0	100	0	QPSK	21.68	21.86	21.88	23.71	0.2350
10+20	1	0	1	99		14.07	13.88	13.94		
10+20	1	74	1	0		23.58	23.64	23.71		
10+20	75	0	100	0	16-QAM	20.72	20.88	20.96	23.30	0.2138
10+20	1	0	1	99		14.29	14.13	14.23		
10+20	1	74	1	0		22.89	23.09	23.30		
10+20	75	0	100	0	64-QAM	20.74	20.90	20.93	21.11	0.1291
10+20	1	0	1	99		14.20	14.17	14.22		
10+20	1	74	1	0		20.99	21.08	21.11		
15+15	75	0	100	0	QPSK	21.68	21.93	21.91	23.98	0.2500
15+15	1	0	1	99		13.65	13.93	13.59		
15+15	1	74	1	0		23.82	23.93	23.98		
15+15	75	0	100	0	16-QAM	20.76	20.99	20.98	23.36	0.2168
15+15	1	0	1	99		13.76	14.01	13.82		
15+15	1	74	1	0		23.24	23.32	23.36		
15+15	75	0	100	0	64-QAM	20.79	20.98	21.00	21.19	0.1315
15+15	1	0	1	99		13.91	13.89	13.92		
15+15	1	74	1	0		21.19	21.18	21.12		
15+10	75	0	100	0	QPSK	20.74	21.15	22.02	23.83	0.2415
15+10	1	0	1	99		13.92	14.55	13.92		
15+10	1	74	1	0		23.73	23.83	23.60		
15+10	75	0	100	0	16-QAM	20.09	19.67	19.32	23.58	0.2280
15+10	1	0	1	99		14.34	14.80	14.52		
15+10	1	74	1	0		23.58	23.44	23.08		
15+10	75	0	100	0	64-QAM	19.72	20.48	20.35	21.19	0.1315
15+10	1	0	1	99		14.35	14.78	14.12		
15+10	1	74	1	0		21.13	21.19	20.99		



LTE Band 41C_CA Maximum Average Power [dBm]										
BW [MHz]	PCC		SCC		Mod	Lowest	Middle	Highest	Maximum Output Power (dBm)	Maximum Output Power (W)
	RB Size	RB Offset	RB Size	RB Offset						
20+20	100	0	100	0	QPSK	21.43	21.40	20.81	23.32	0.2148
20+20	1	0	1	99		14.88	14.91	14.45		
20+20	1	99	1	0		23.18	23.32	22.79		
20+20	100	0	100	0	16-QAM	20.47	20.46	19.88	23.00	0.1995
20+20	1	0	1	99		15.38	15.42	14.95		
20+20	1	99	1	0		22.93	23.00	22.41		
20+20	100	0	100	0	64-QAM	20.54	20.50	19.93	20.66	0.1164
20+20	1	0	1	99		15.03	15.03	14.56		
20+20	1	99	1	0		20.52	20.66	20.11		
20+15	100	0	75	0	QPSK	21.43	21.37	20.82	23.35	0.2163
20+15	1	0	1	74		14.92	14.91	14.29		
20+15	1	99	1	0		23.34	23.35	22.74		
20+15	100	0	75	0	16-QAM	20.44	20.43	19.85	23.03	0.2009
20+15	1	0	1	74		15.40	15.44	14.85		
20+15	1	99	1	0		22.93	23.03	22.40		
20+15	100	0	75	0	64-QAM	20.50	20.53	19.92	20.68	0.1169
20+15	1	0	1	74		15.05	15.09	14.43		
20+15	1	99	1	0		20.56	20.68	20.03		
15+20	75	0	100	0	QPSK	21.42	21.42	20.82	23.34	0.2158
15+20	1	0	1	99		14.90	14.82	14.28		
15+20	1	74	1	0		23.34	23.30	22.75		
15+20	75	0	100	0	16-QAM	20.44	20.45	19.87	22.95	0.1972
15+20	1	0	1	99		15.43	15.38	14.82		
15+20	1	74	1	0		22.92	22.95	22.42		
15+20	75	0	100	0	64-QAM	20.49	20.50	19.92	20.64	0.1159
15+20	1	0	1	99		15.05	15.00	14.42		
15+20	1	74	1	0		20.54	20.64	20.02		



LTE Band 41C_CA Maximum Average Power [dBm]										
BW [MHz]	PCC		SCC		Mod	Lowest	Middle	Highest	Maximum Output Power (dBm)	Maximum Output Power (W)
	RB Size	RB Offset	RB Size	RB Offset						
20+10	100	0	50	0	QPSK	21.41	21.38	20.81	23.42	0.2198
20+10	1	0	1	49		14.91	14.96	14.38		
20+10	1	99	1	0		23.42	23.31	22.81		
20+10	100	0	50	0	16-QAM	20.43	20.43	19.87	23.11	0.2046
20+10	1	0	1	49		15.42	15.48	14.90		
20+10	1	99	1	0		23.00	23.11	22.45		
20+10	100	0	50	0	64-QAM	20.49	20.49	19.93	20.73	0.1183
20+10	1	0	1	49		15.05	15.14	14.51		
20+10	1	99	1	0		20.63	20.73	20.12		
10+20	50	0	100	0	QPSK	21.44	21.42	20.82	23.35	0.2163
10+20	1	0	1	99		14.87	14.89	14.31		
10+20	1	49	1	0		23.35	23.34	22.76		
10+20	50	0	100	0	16-QAM	20.43	20.44	19.84	22.99	0.1991
10+20	1	0	1	99		15.38	15.40	14.79		
10+20	1	49	1	0		22.92	22.99	22.42		
10+20	50	0	100	0	64-QAM	20.50	20.53	19.91	20.65	0.1161
10+20	1	0	1	99		15.01	15.05	14.35		
10+20	1	49	1	0		20.54	20.65	20.07		
20+5	100	0	25	0	QPSK	21.49	21.34	21.51	23.08	0.2032
20+5	1	0	1	24		15.17	15.14	15.24		
20+5	1	99	1	0		22.89	23.03	23.08		
20+5	100	0	25	0	16-QAM	20.49	20.58	20.69	22.99	0.1991
20+5	1	0	1	24		15.74	15.62	15.78		
20+5	1	99	1	0		22.99	22.80	22.99		
20+5	100	0	25	0	64-QAM	20.67	20.85	20.87	20.87	0.1222
20+5	1	0	1	24		14.91	15.01	15.07		
20+5	1	99	1	0		20.75	20.62	20.81		



LTE Band 41C_CA Maximum Average Power [dBm]										
BW [MHz]	PCC		SCC		Mod	Lowest	Middle	Highest	Maximum Output Power (dBm)	Maximum Output Power (W)
	RB Size	RB Offset	RB Size	RB Offset						
5+20	25	0	100	0	QPSK	21.44	21.43	20.82	23.40	0.2188
5+20	1	0	1	99		14.87	14.86	14.27		
5+20	1	24	1	0		23.40	23.38	22.81		
5+20	25	0	100	0	16-QAM	20.49	20.53	19.92	23.00	0.1995
5+20	1	0	1	99		15.39	15.39	14.79		
5+20	1	24	1	0		22.93	23.00	22.47		
5+20	25	0	100	0	64-QAM	20.46	20.50	19.89	20.66	0.1164
5+20	1	0	1	99		15.02	15.05	14.41		
5+20	1	24	1	0		20.59	20.66	20.12		
15+10	75	0	50	0	QPSK	21.23	21.22	19.51	23.86	0.2432
15+10	1	0	1	49		15.61	15.22	14.87		
15+10	1	74	1	0		23.86	23.03	22.21		
15+10	75	0	50	0	16-QAM	20.35	20.60	19.65	23.05	0.2018
15+10	1	0	1	49		15.81	15.35	14.95		
15+10	1	74	1	0		22.63	23.05	21.71		
15+10	75	0	50	0	64-QAM	22.17	20.63	19.69	22.17	0.1648
15+10	1	0	1	49		14.88	14.95	14.97		
15+10	1	74	1	0		22.09	20.60	19.00		
10+15	50	0	75	0	QPSK	21.48	21.42	20.85	23.38	0.2178
10+15	1	0	1	74		14.89	14.89	14.31		
10+15	1	49	1	0		23.38	23.37	22.75		
10+15	50	0	75	0	16-QAM	20.47	20.47	19.87	23.01	0.2000
10+15	1	0	1	74		15.39	15.41	14.84		
10+15	1	49	1	0		22.96	23.01	22.43		
10+15	50	0	75	0	64-QAM	20.53	20.53	19.94	20.63	0.1156
10+15	1	0	1	74		15.02	15.05	14.43		
10+15	1	49	1	0		20.59	20.63	20.09		
15+15	75	0	75	0	QPSK	21.43	21.33	20.79	23.36	0.2168
15+15	1	0	1	74		14.86	14.79	14.32		
15+15	1	74	1	0		23.34	23.36	22.62		
15+15	75	0	75	0	16-QAM	20.47	20.49	19.87	23.04	0.2014
15+15	1	0	1	74		15.34	15.39	14.75		
15+15	1	74	1	0		22.91	23.04	22.41		
15+15	75	0	75	0	64-QAM	20.48	20.55	20.03	20.70	0.1175
15+15	1	0	1	74		14.99	15.02	14.37		
15+15	1	74	1	0		20.54	20.70	20.07		



LTE Band 5B

26dB Bandwidth

Mode	LTE Band 5B : 26dB BW(MHz)		
QPSK			
BW	3MHz+5MHz	5MHz+3MHz	5MHz+10MHz
Middle CH	-	-	14.48
BW	10MHz+5MHz	10MHz+10MHz	N/A
Middle CH	14.63	19.66	-

Mode	LTE Band 5B : 26dB BW(MHz)		
16QAM			
BW	3MHz+5MHz	5MHz+3MHz	5MHz+10MHz
Middle CH	-	-	14.57
BW	10MHz+5MHz	10MHz+10MHz	N/A
Middle CH	14.60	19.78	-

Mode	LTE Band 5B : 26dB BW(MHz)		
64QAM			
BW	3MHz+5MHz	5MHz+3MHz	5MHz+10MHz
Middle CH	-	-	14.57
BW	10MHz+5MHz	10MHz+10MHz	N/A
Middle CH	14.78	19.62	-



LTE Band 5B

QPSK

Middle Channel / 5MHz+10MHz

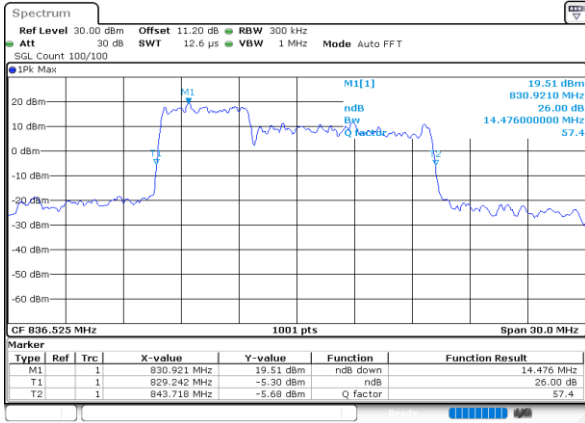

Middle Channel / 10MHz+5MHz

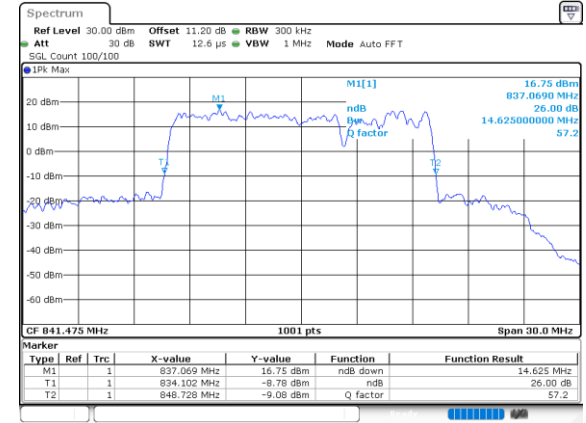

Middle Channel / 10MHz+10MHz

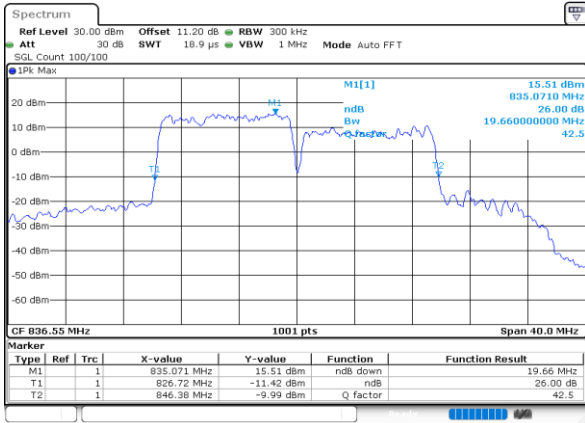

N/A



LTE Band 5B

16QAM

Middle Channel / 5MHz+10MHz

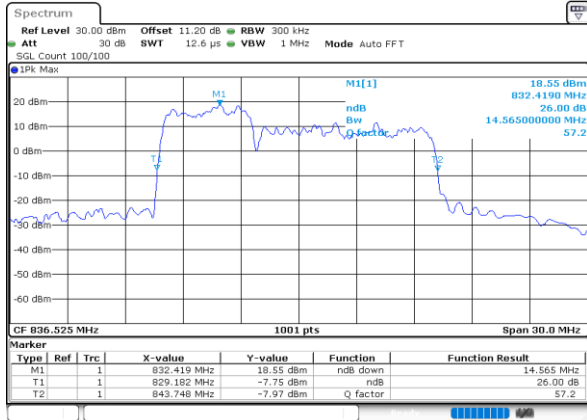

Date: 24.MAY.2022 20:22:19

Middle Channel / 10MHz+5MHz

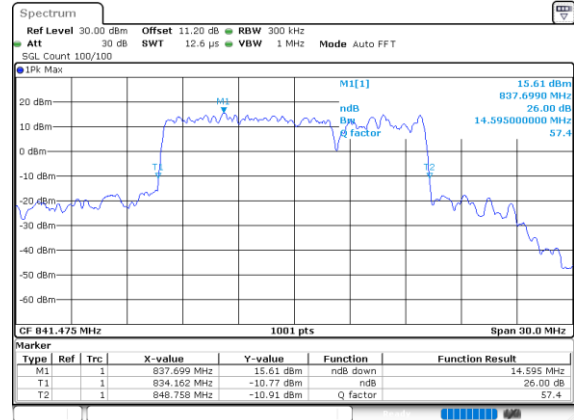

Date: 24.MAY.2022 20:54:00

Middle Channel / 10MHz+10MHz

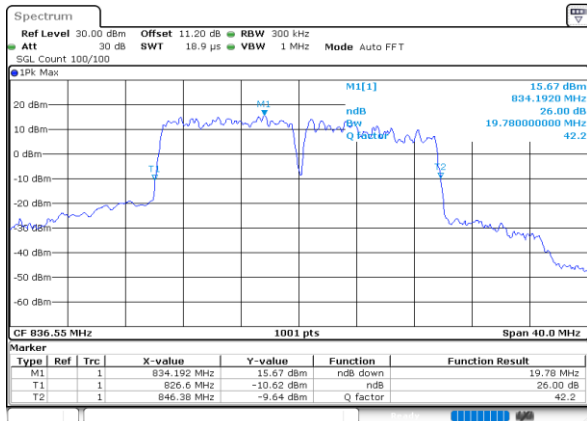

Date: 24.MAY.2022 22:20:00

N/A



LTE Band 5B

64QAM

Middle Channel / 5MHz+10MHz

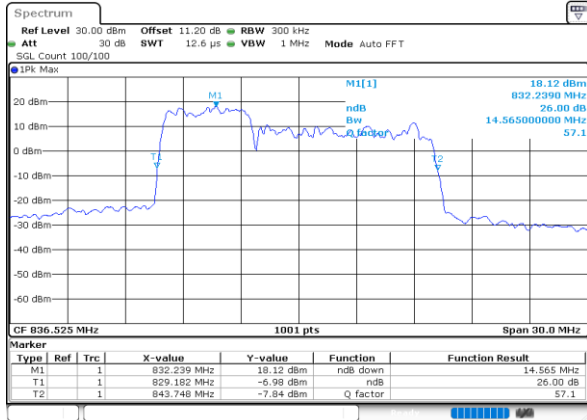

Date: 24.MAY.2022 20:22:57

Middle Channel / 10MHz+5MHz

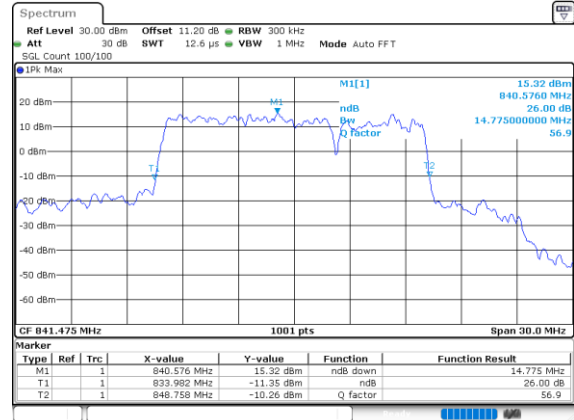

Date: 24.MAY.2022 20:53:21

Middle Channel / 10MHz+10MHz

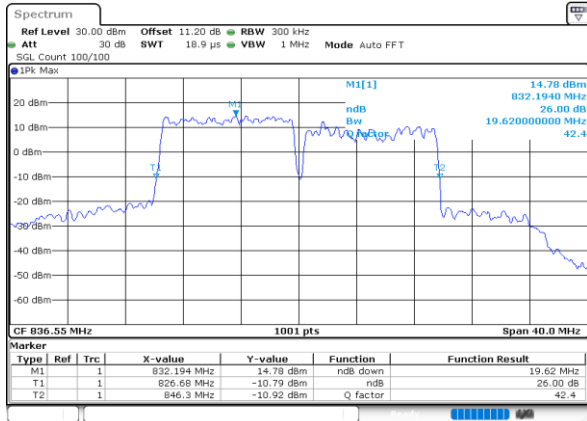

Date: 24.MAY.2022 22:31:57

N/A



Occupied Bandwidth

Mode	LTE Band 5B : 99%OBW(MHz)		
QPSK			
BW	3MHz+5MHz	5MHz+3MHz	5MHz+10MHz
Middle CH	-	-	13.67
BW	10MHz+5MHz	10MHz+10MHz	N/A
Middle CH	13.85	18.70	-

Mode	LTE Band 5B : 99%OBW(MHz)		
16QAM			
BW	3MHz+5MHz	5MHz+3MHz	5MHz+10MHz
Middle CH	-	-	13.85
BW	10MHz+5MHz	10MHz+10MHz	N/A
Middle CH	13.91	18.66	-

Mode	LTE Band 5B : 99%OBW(MHz)		
64QAM			
BW	3MHz+5MHz	5MHz+3MHz	5MHz+10MHz
Middle CH	-	-	13.82
BW	10MHz+5MHz	10MHz+10MHz	N/A
Middle CH	13.85	18.62	-



LTE Band 5B

QPSK

Middle Channel / 5MHz+10MHz

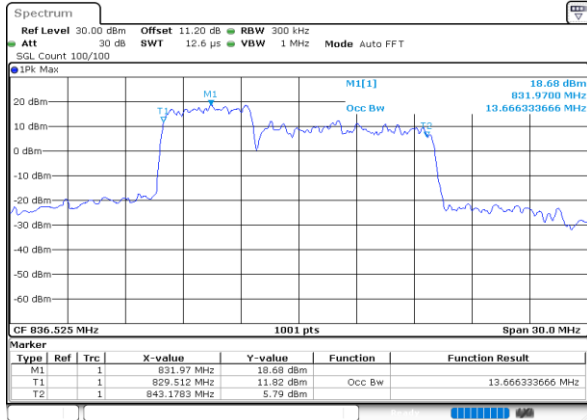

Date: 24.MAY.2022 20:19:46

Middle Channel / 10MHz+5MHz

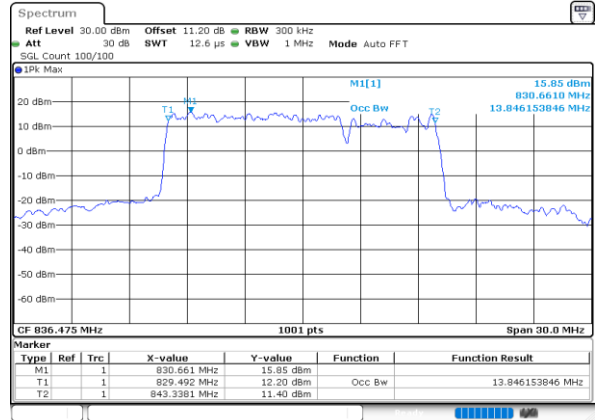

Date: 24.MAY.2022 21:22:17

Middle Channel / 10MHz+10MHz

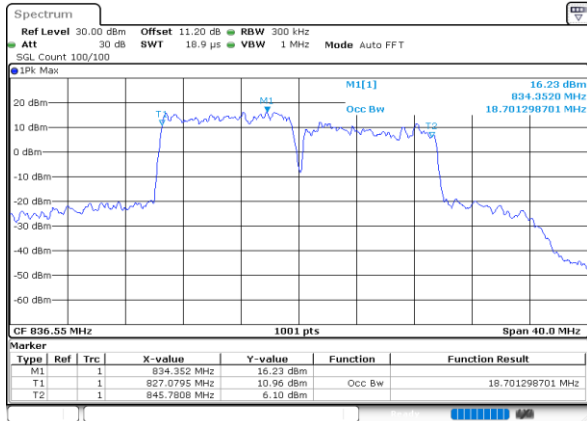

Date: 24.MAY.2022 22:17:49

N/A



LTE Band 5B

16QAM

Middle Channel / 5MHz+10MHz

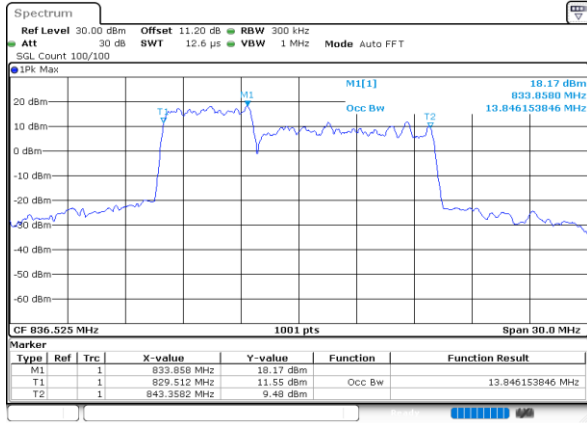

Middle Channel / 10MHz+5MHz

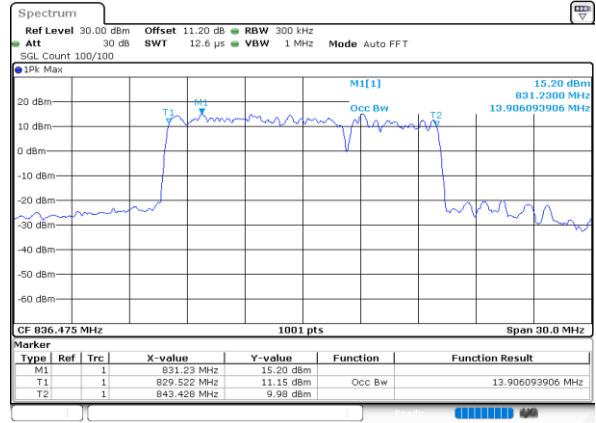

Middle Channel / 10MHz+10MHz

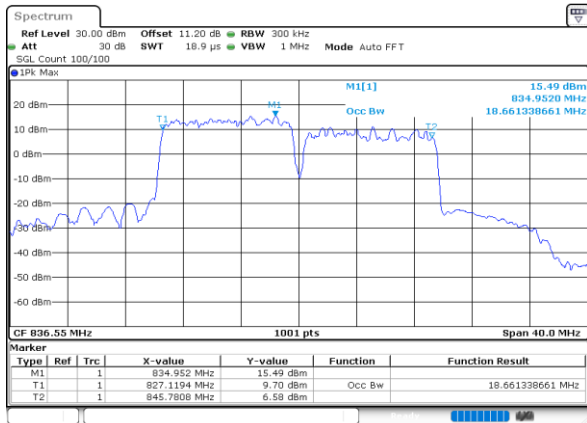

N/A



LTE Band 5B

64QAM

Middle Channel / 5MHz+10MHz

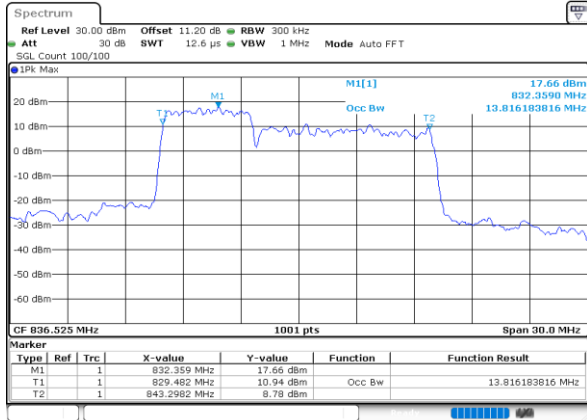

Date: 24.MAY.2022 20:21:02

Middle Channel / 10MHz+5MHz

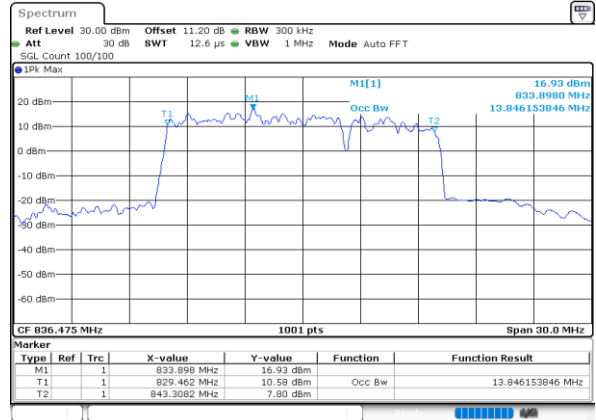

Date: 24.MAY.2022 21:23:33

Middle Channel / 10MHz+10MHz

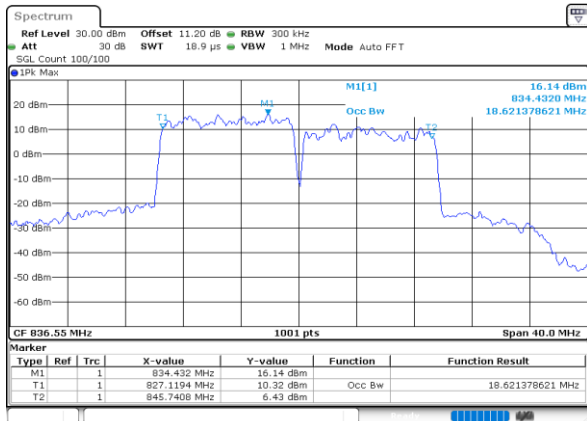

Date: 24.MAY.2022 22:18:54

N/A



Conducted Band Edge

LTE Band 5B / 5MHz+10MHz

QPSK

Lowest Band Edge / 1RB0 and 1RB49

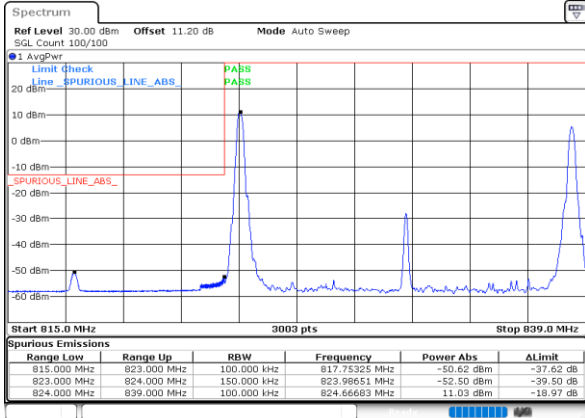

Date: 24.MAY.2022 20:05:53

Highest Band Edge / 1RB0 and 1RB49

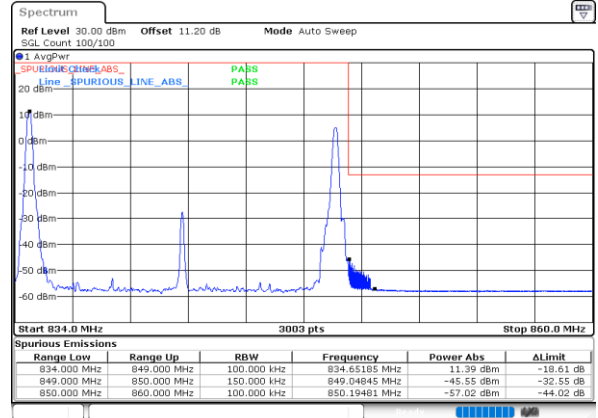

Date: 24.MAY.2022 19:43:32

Lowest Band Edge / 1RB24 and 1RB0

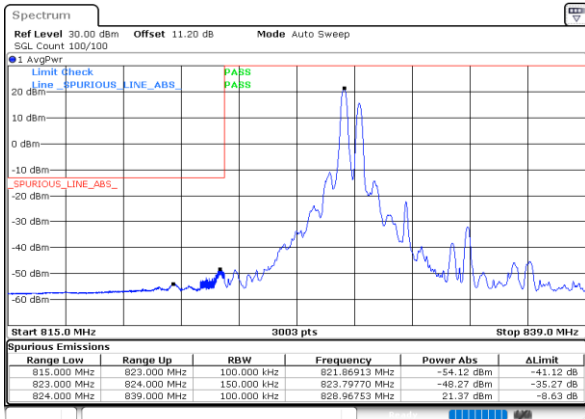

Date: 24.MAY.2022 20:07:02

Highest Band Edge / 1RB24 and 1RB0

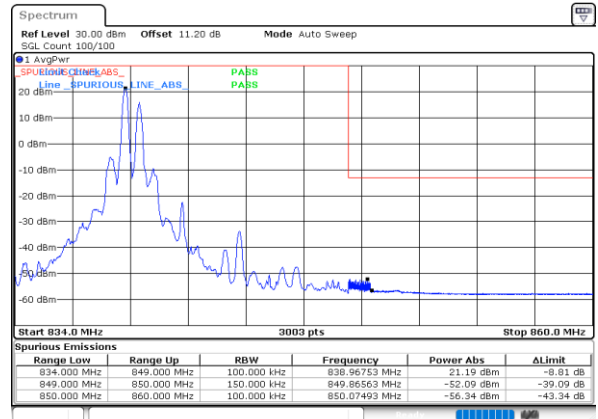

Date: 24.MAY.2022 19:49:13

Lowest Band Edge / Full RB

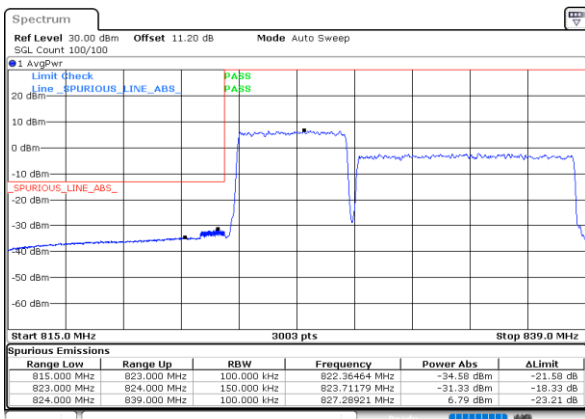

Date: 24.MAY.2022 20:09:11

Highest Band Edge / Full RB

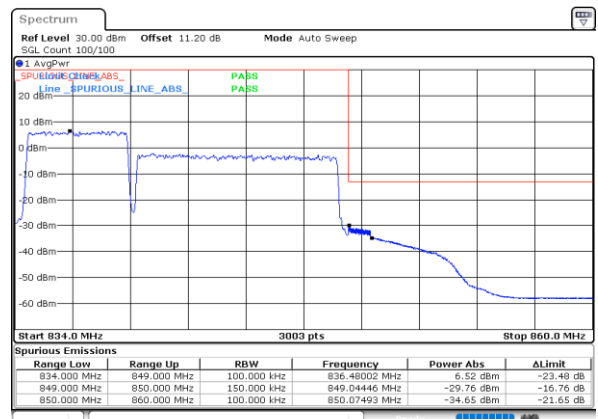

Date: 24.MAY.2022 19:42:24



LTE Band 5B / 10MHz+5MHz

QPSK

Lowest Band Edge / 1RB0 and 1RB24

Highest Band Edge / 1RB0 and 1RB24

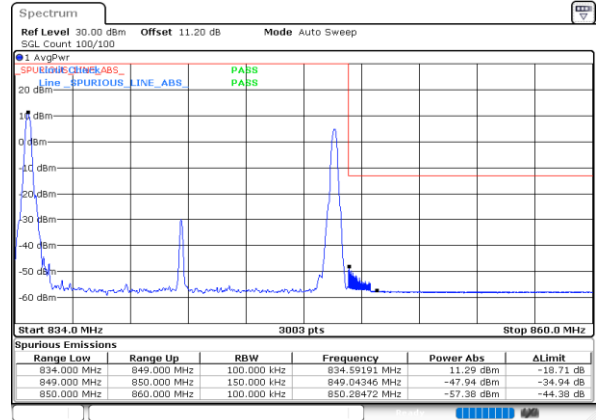
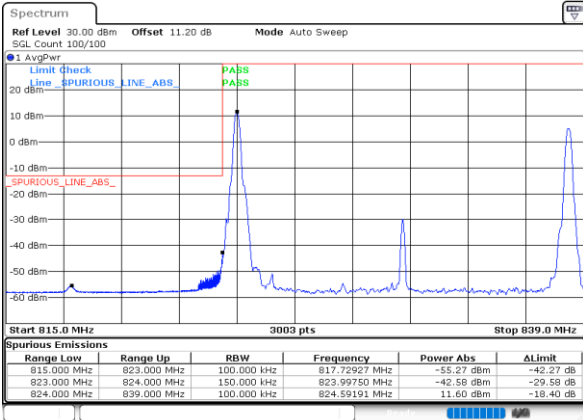

Lowest Band Edge / 1RB49 and 1RB0

Highest Band Edge / 1RB49 and 1RB0

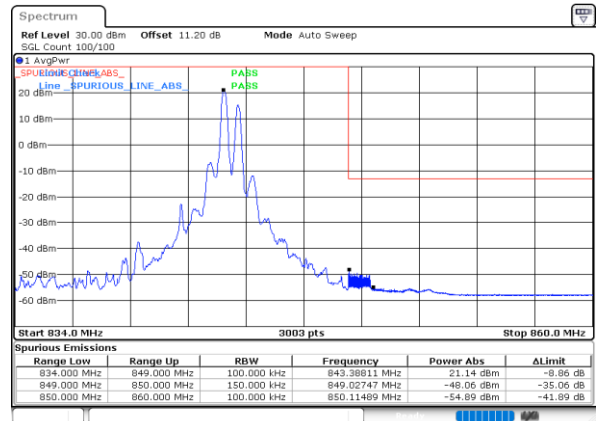
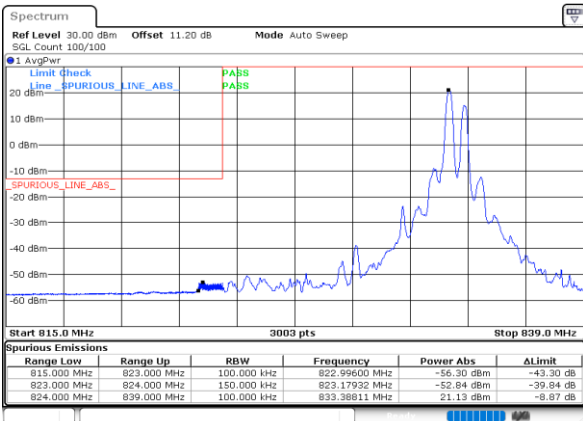

Lowest Band Edge / Full RB

Highest Band Edge / Full RB

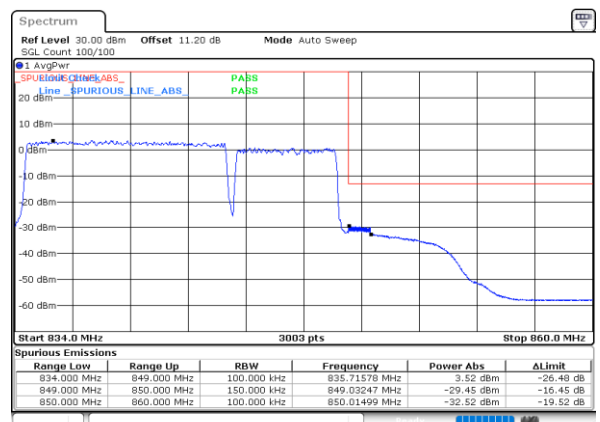
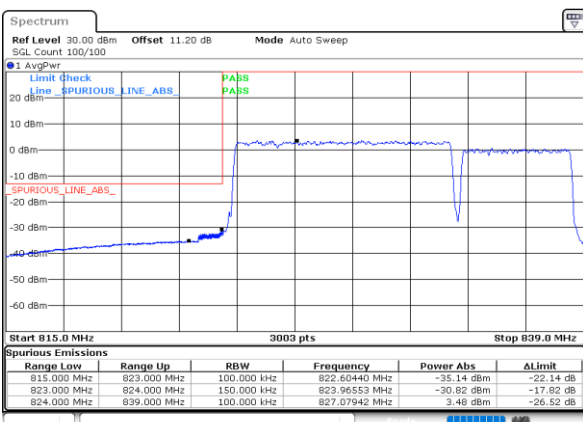



LTE Band 5B / 10MHz+10MHz

QPSK

Lowest Band Edge / 1RB0 and 1RB49

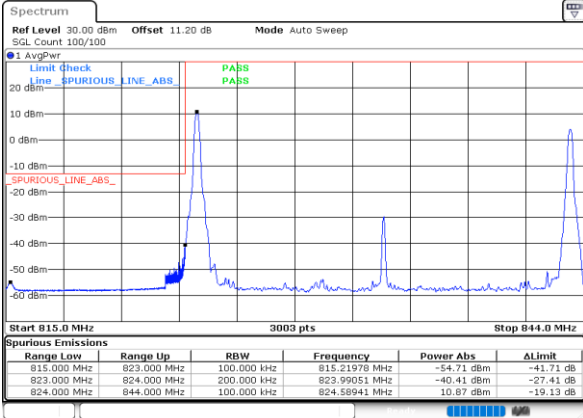

Date: 24.MAY.2022 21:59:07

Highest Band Edge / 1RB0 and 1RB49

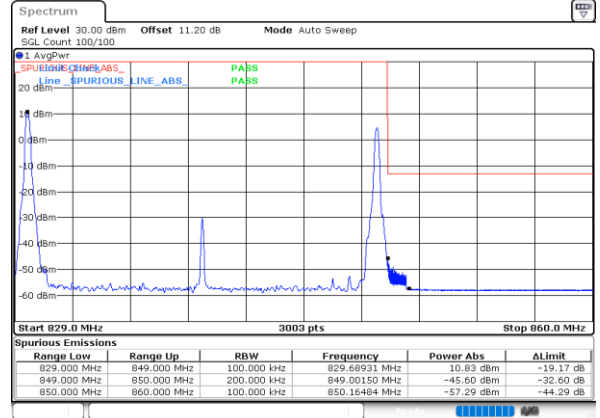

Date: 24.MAY.2022 21:55:14

Lowest Band Edge / 1RB49 and 1RB0

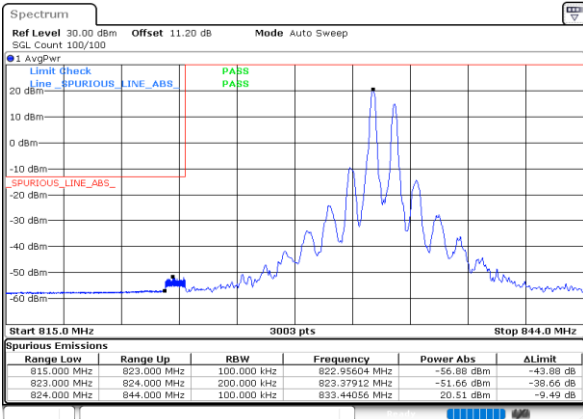

Date: 24.MAY.2022 22:00:10

Highest Band Edge / 1RB49 and 1RB0

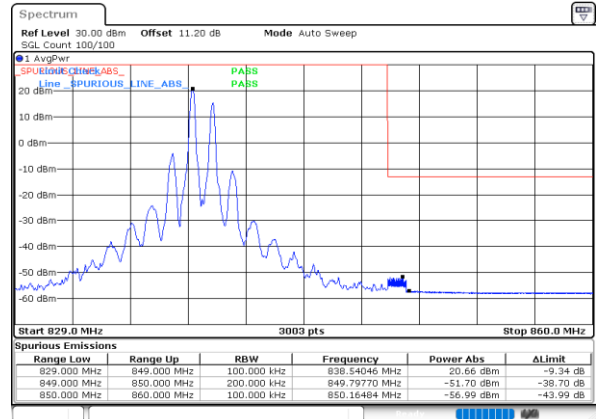

Date: 24.MAY.2022 21:40:30

Lowest Band Edge / Full RB

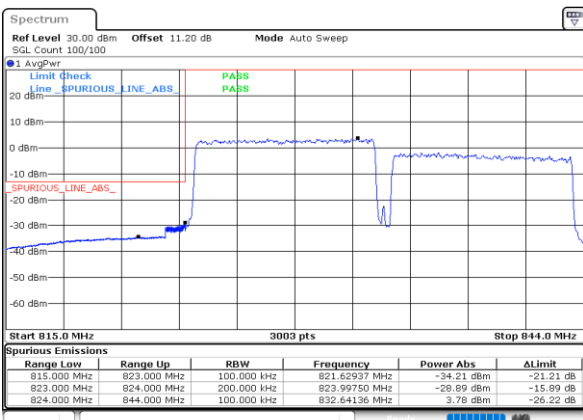

Date: 24.MAY.2022 21:53:50

Highest Band Edge / Full RB

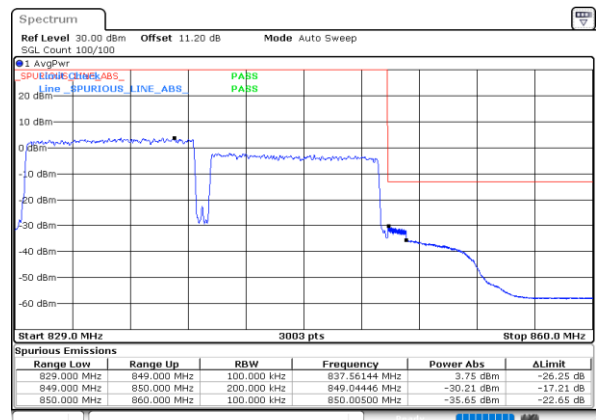

Date: 24.MAY.2022 21:34:11



LTE Band 5B / 5MHz+10MHz

16QAM

Lowest Band Edge / 1RB0 and 1RB49

Highest Band Edge / 1RB0 and 1RB49

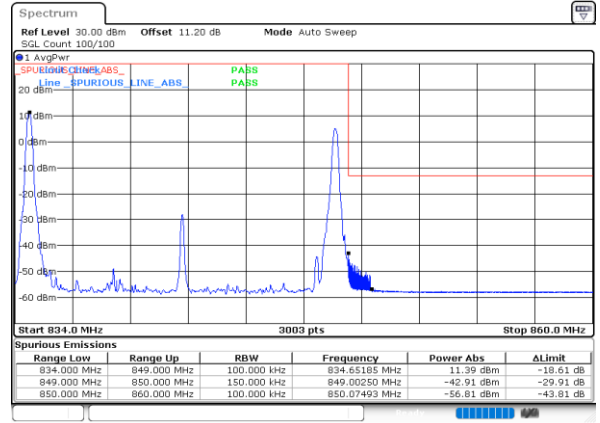
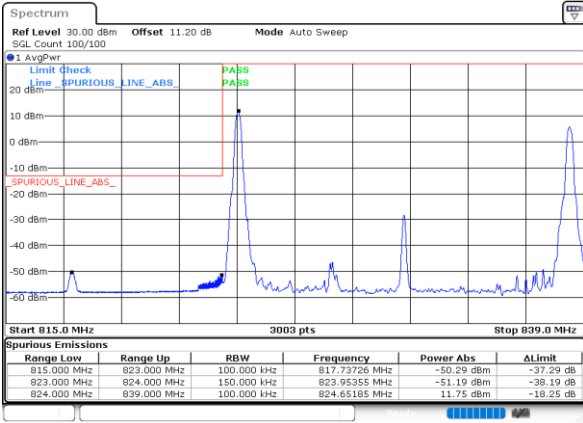

Lowest Band Edge / 1RB24 and 1RB0

Highest Band Edge / 1RB24 and 1RB0

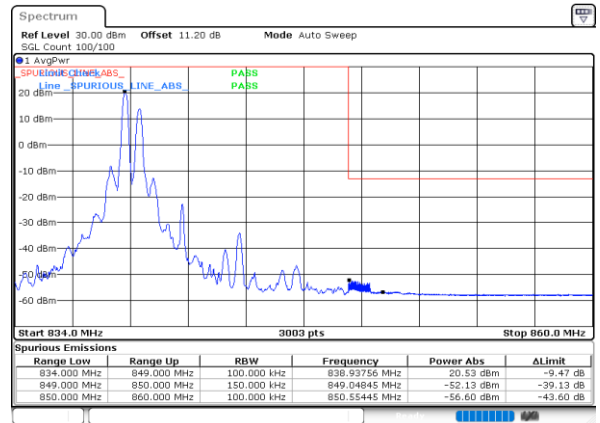
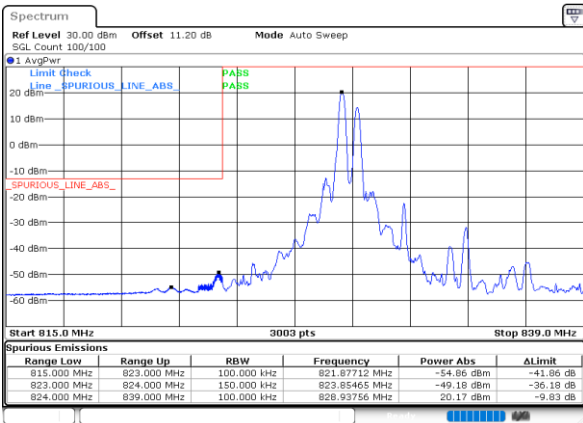

Lowest Band Edge / Full RB

Highest Band Edge / Full RB

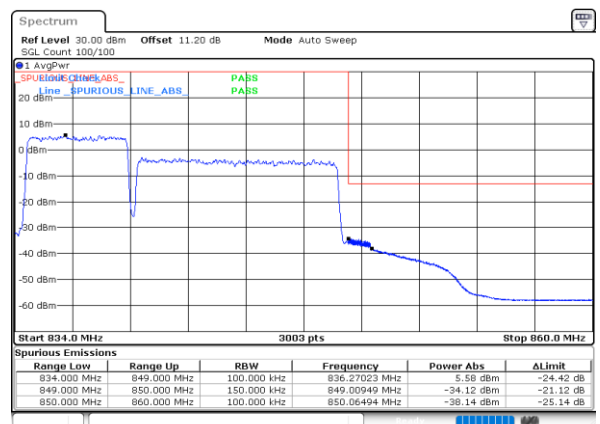
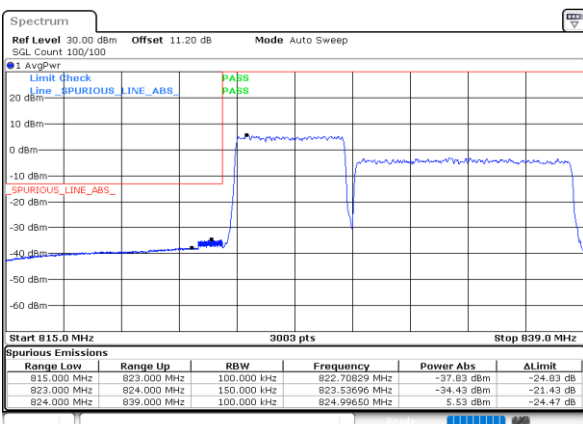



LTE Band 5B / 10MHz+5MHz

16QAM

Lowest Band Edge / 1RB0 and 1RB24

Highest Band Edge / 1RB0 and 1RB24

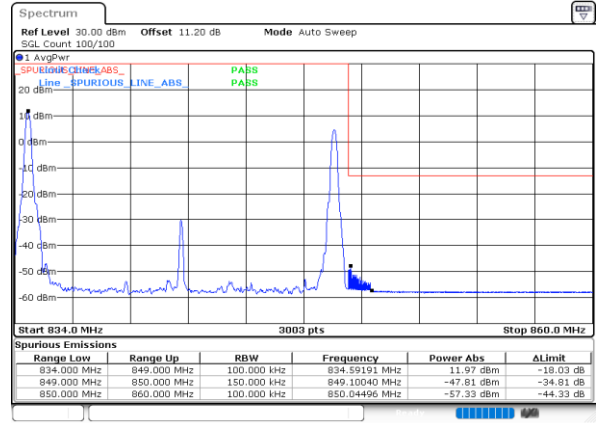
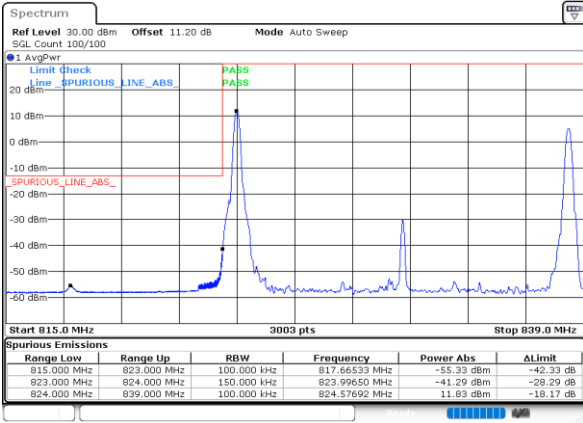

Lowest Band Edge / 1RB49 and 1RB0

Highest Band Edge / 1RB49 and 1RB0

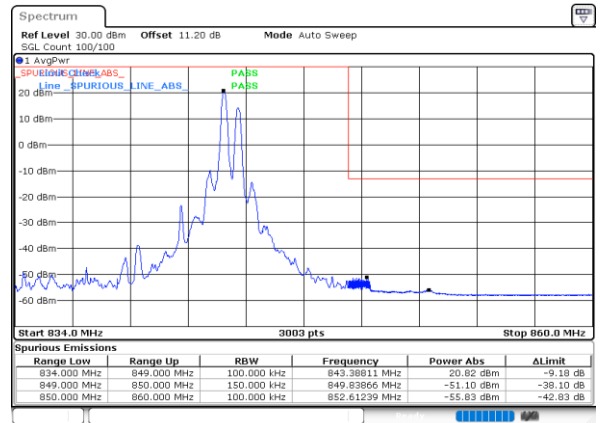
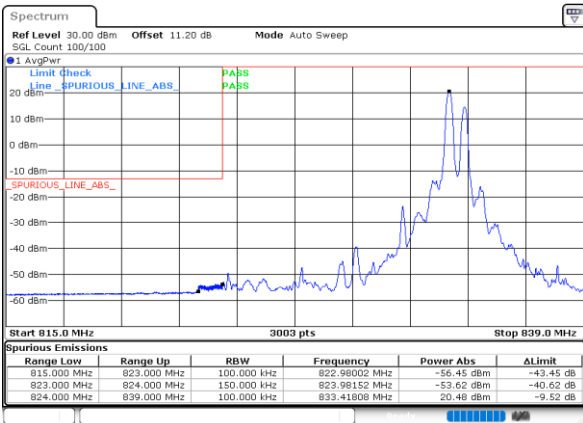

Lowest Band Edge / Full RB

Highest Band Edge / Full RB

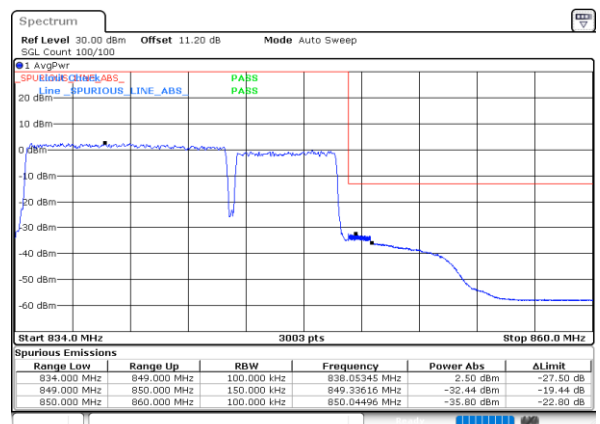
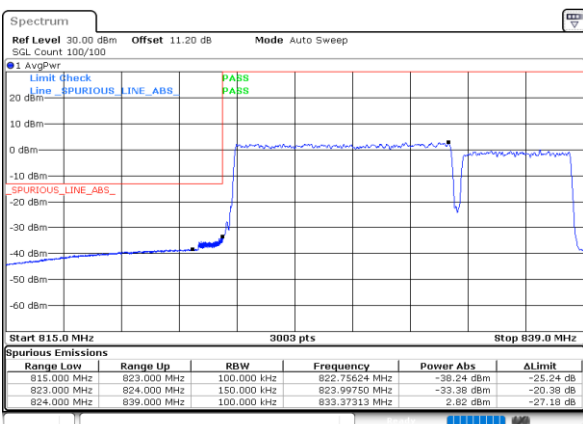



LTE Band 5B / 10MHz+10MHz

16QAM

Lowest Band Edge / 1RB0 and 1RB49

Highest Band Edge / 1RB0 and 1RB49

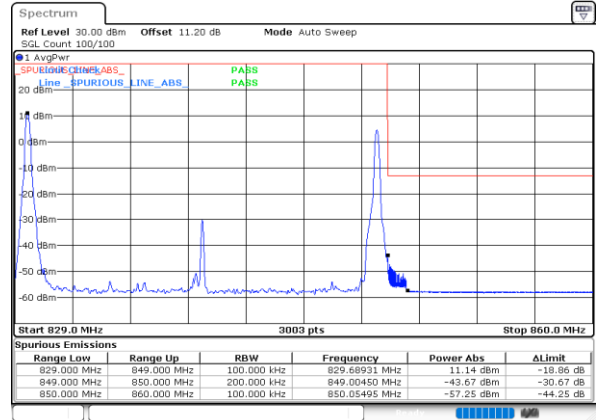
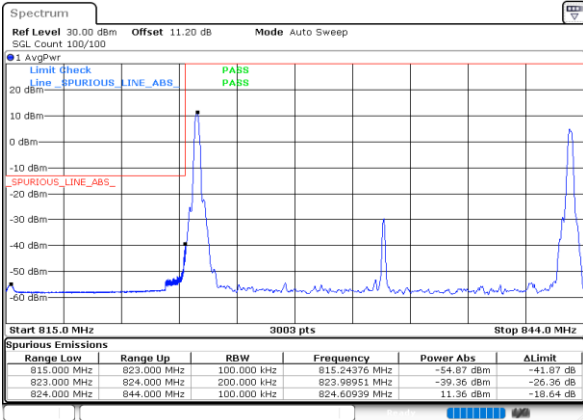

Date: 24.MAY.2022 21:58:04

Date: 24.MAY.2022 21:16:17

Lowest Band Edge / 1RB49 and 1RB0

Highest Band Edge / 1RB49 and 1RB0

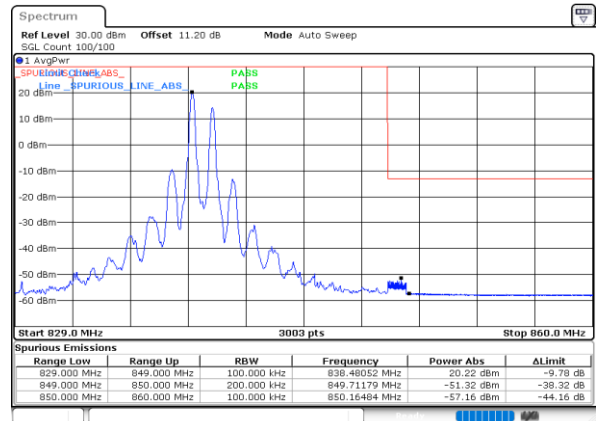
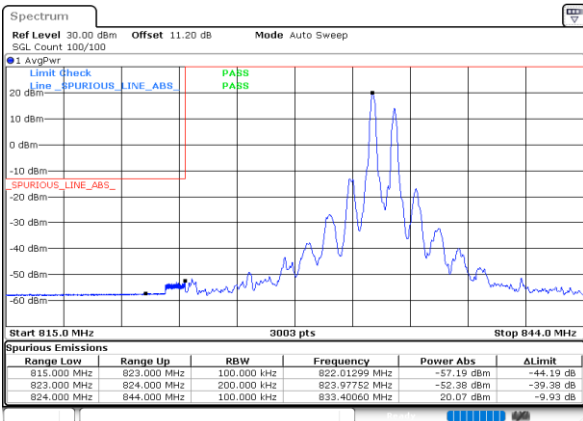

Date: 24.MAY.2022 22:01:13

Date: 24.MAY.2022 21:39:27

Lowest Band Edge / Full RB

Highest Band Edge / Full RB

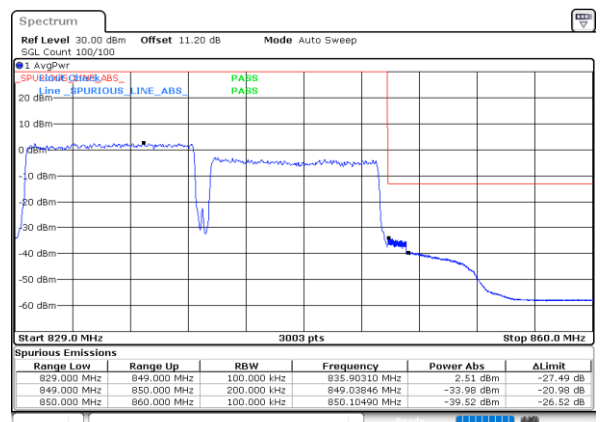
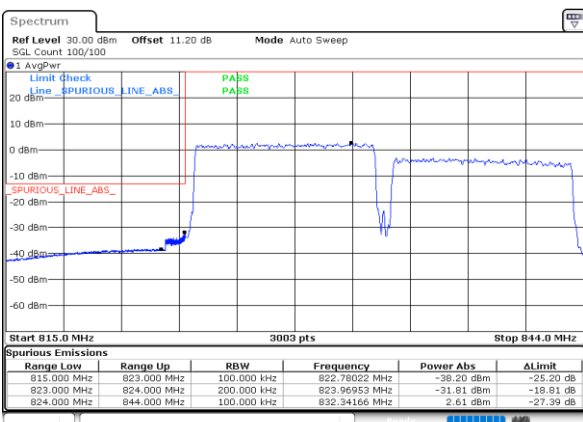

Date: 24.MAY.2022 21:54:53

Date: 24.MAY.2022 21:33:08



LTE Band 5B / 5MHz+10MHz

64QAM

Lowest Band Edge / 1RB0 and 1RB49

Highest Band Edge / 1RB0 and 1RB49

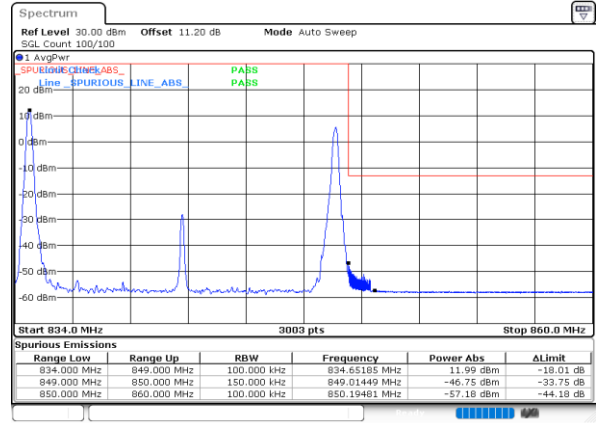
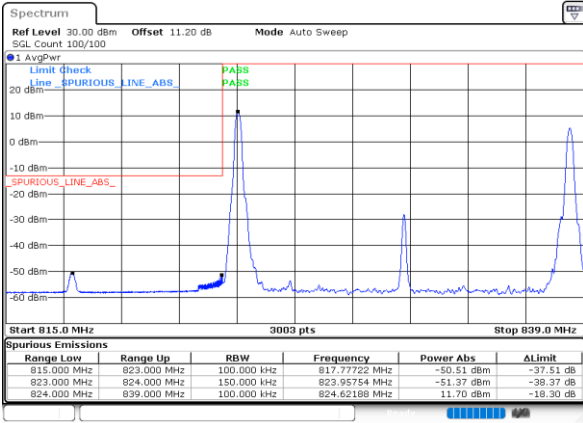

Lowest Band Edge / 1RB24 and 1RB0

Highest Band Edge / 1RB24 and 1RB0

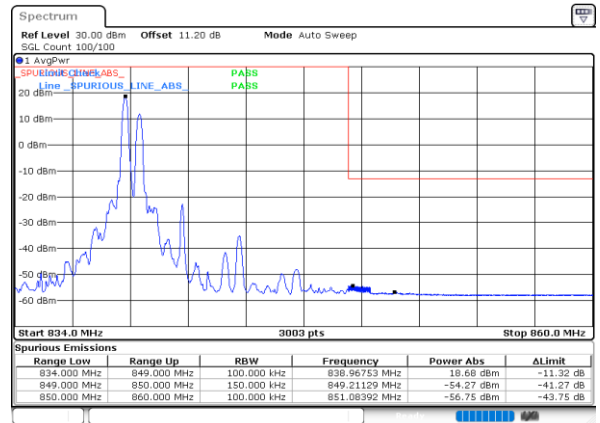
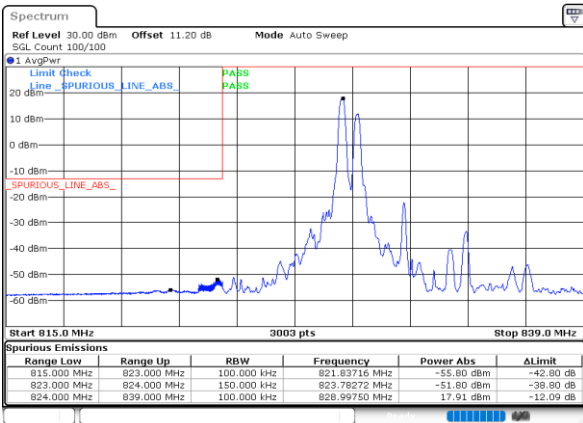

Lowest Band Edge / Full RB

Highest Band Edge / Full RB

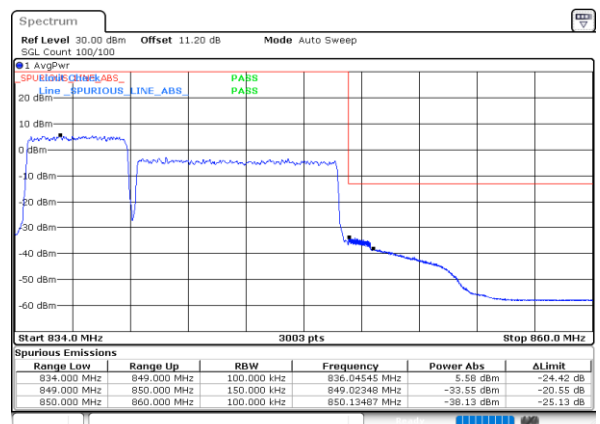
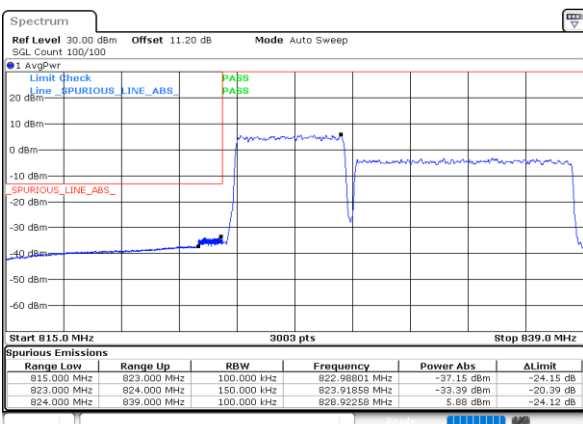



LTE Band 5B / 10MHz+5MHz

64QAM

Lowest Band Edge / 1RB0 and 1RB24

Highest Band Edge / 1RB0 and 1RB24

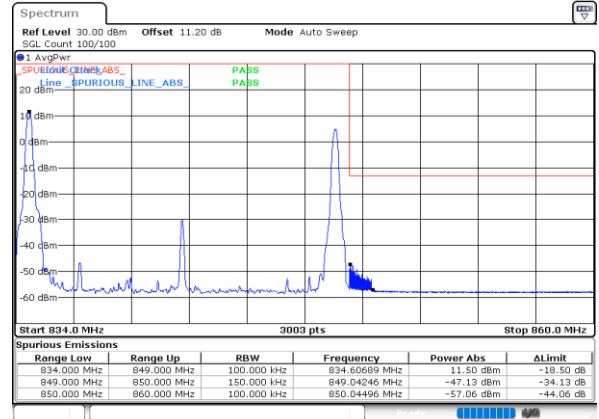
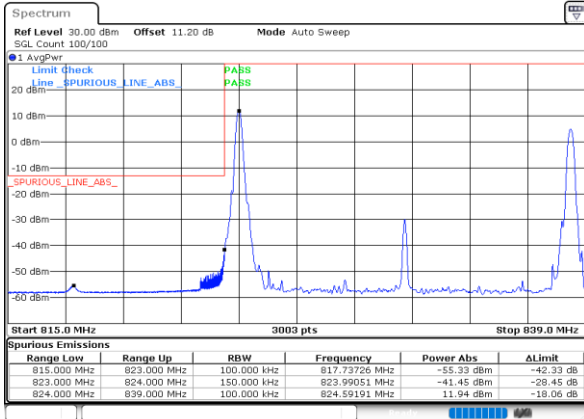

Lowest Band Edge / 1RB49 and 1RB0

Highest Band Edge / 1RB49 and 1RB0

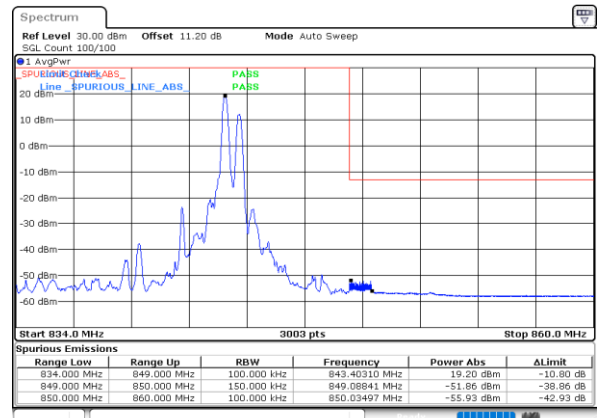
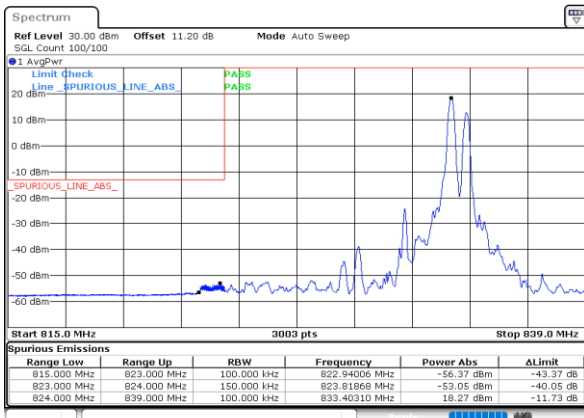

Lowest Band Edge / Full RB

Highest Band Edge / Full RB

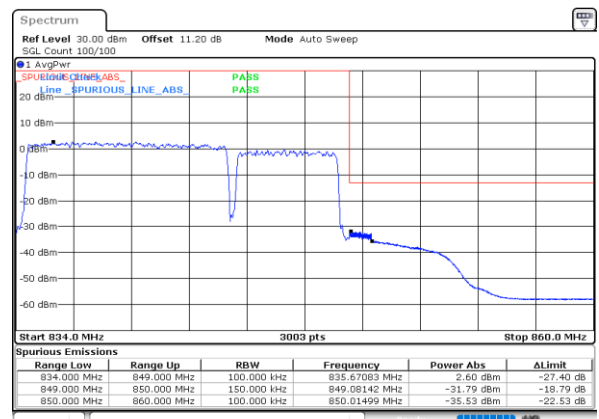
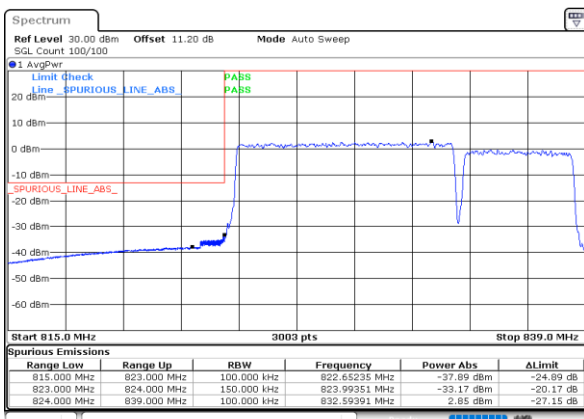



LTE Band 5B / 10MHz+10MHz

64QAM

Lowest Band Edge / 1RB0 and 1RB49

Highest Band Edge / 1RB0 and 1RB49

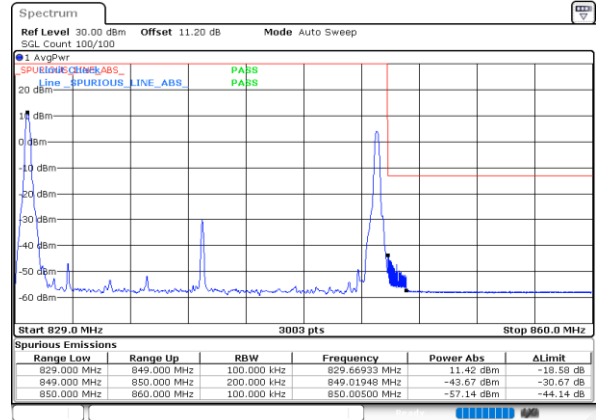
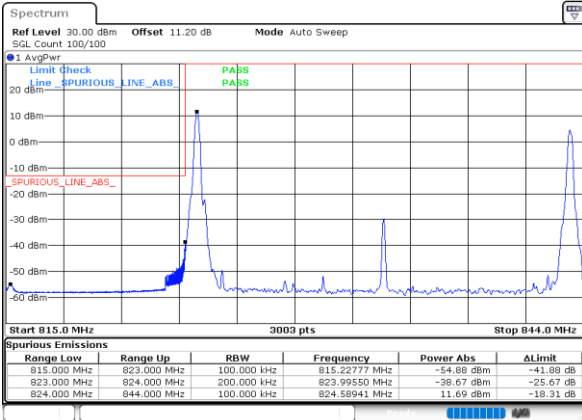

Lowest Band Edge / 1RB49 and 1RB0

Highest Band Edge / 1RB49 and 1RB0

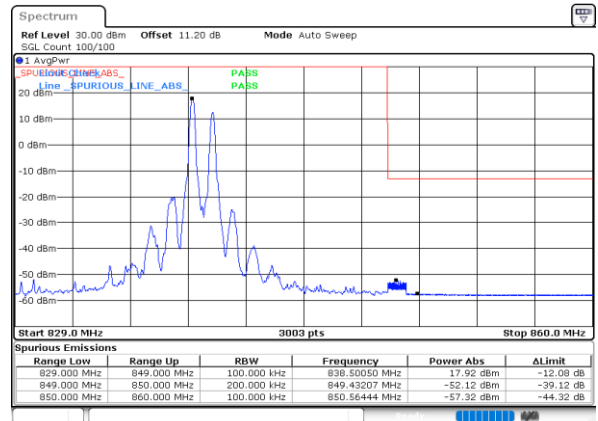
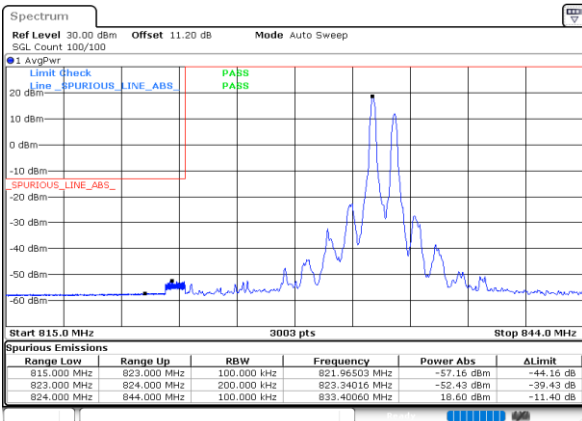

Lowest Band Edge / Full RB

Highest Band Edge / Full RB

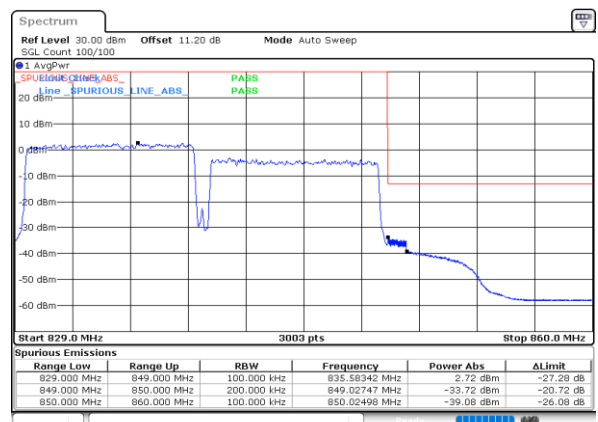
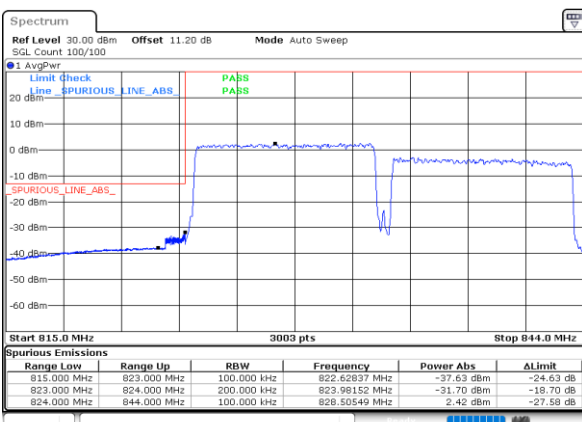



Conducted Spurious Emission

LTE Band 5B / 5MHz+10MHz

QPSK

Lowest Channel / 1RB0 and 1RB49

Lowest Channel / 1RB24 and 1RB0

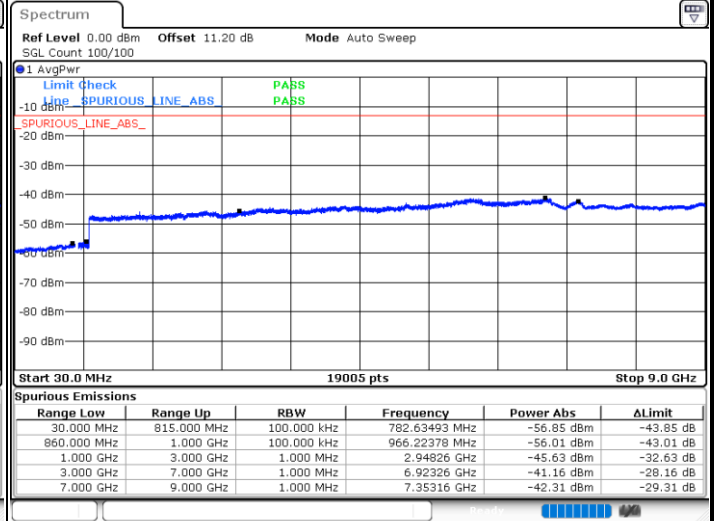
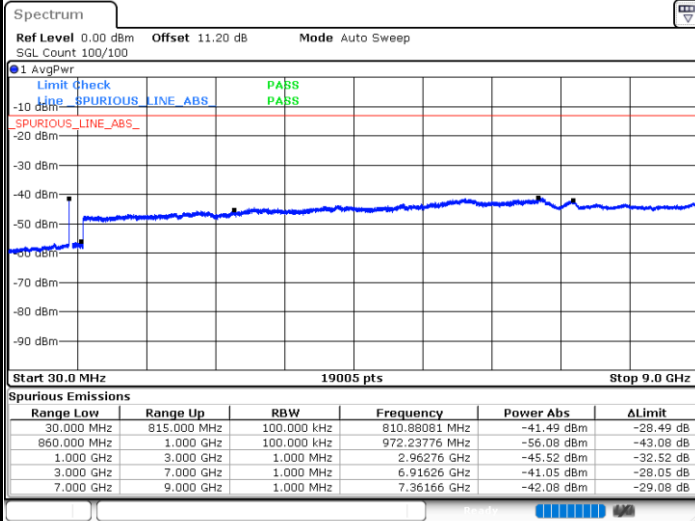

Middle Channel / 1RB0 and 1RB49

Middle Channel / 1RB24 and 1RB0

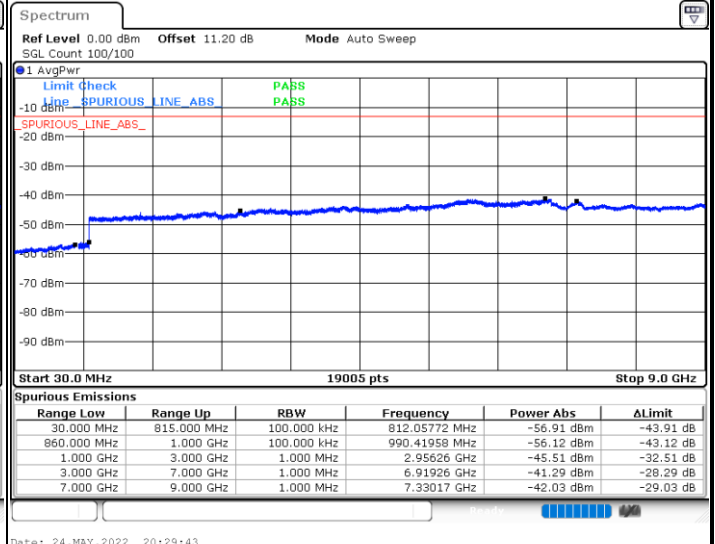
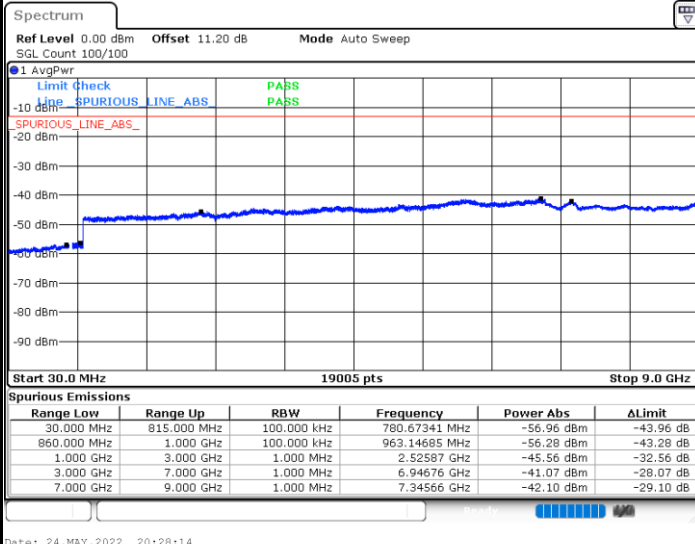



LTE Band 5B / 5MHz+10MHz

QPSK

Highest Channel / 1RB0 and 1RB49

Highest Channel / 1RB24 and 1RB0

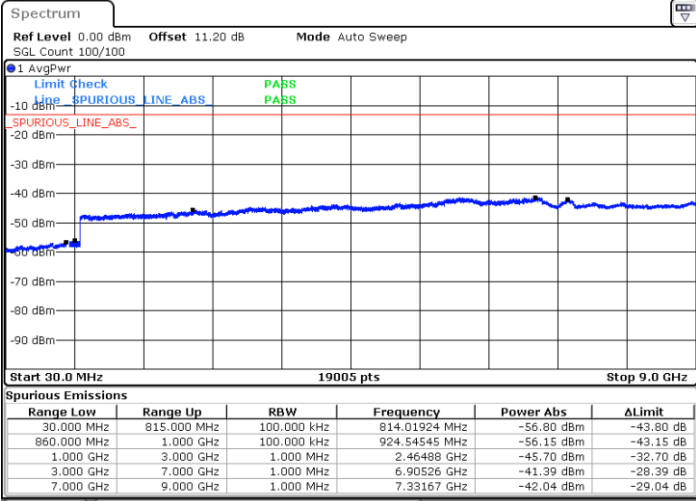

Date: 24.MAY.2022 19:52:07

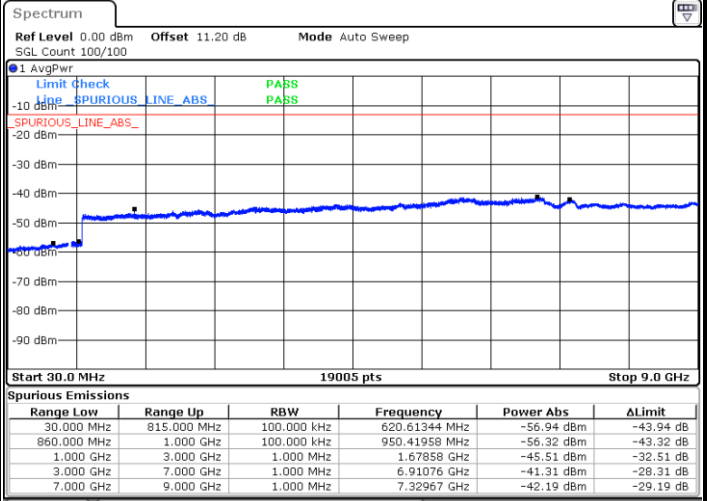

Date: 24.MAY.2022 19:50:40



LTE Band 5B / 10MHz+5MHz

QPSK

Lowest Channel / 1RB0 and 1RB24

Lowest Channel / 1RB49 and 1RB0

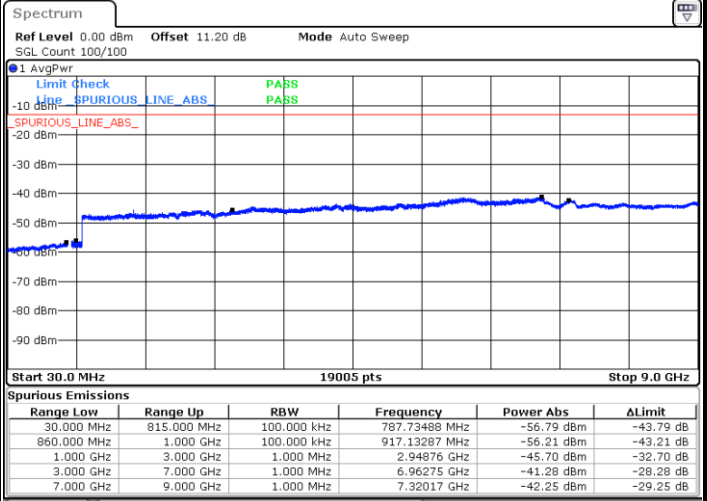
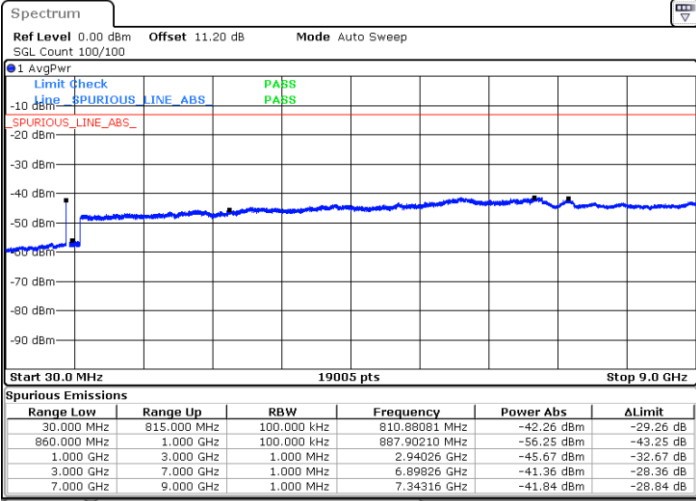

Date: 24.MAY.2022 21:12:49

Date: 24.MAY.2022 21:11:21

Middle Channel / 1RB0 and 1RB24

Middle Channel / 1RB49 and 1RB0

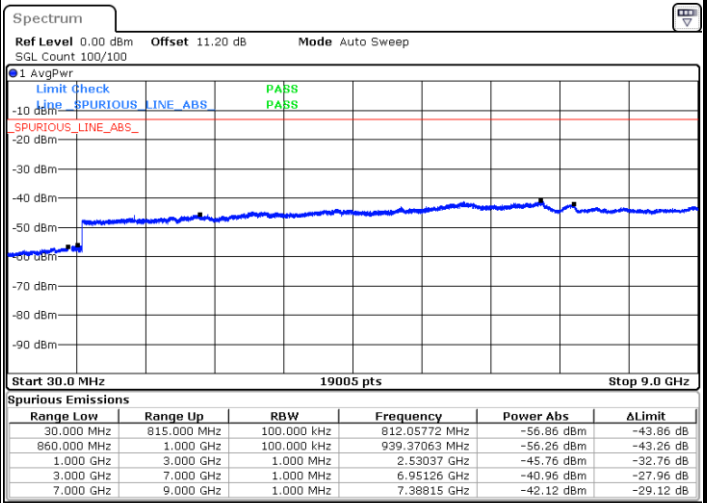
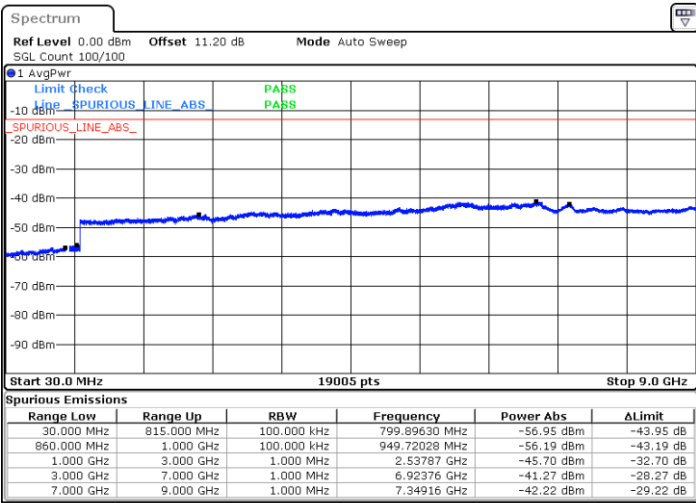

Date: 24.MAY.2022 21:20:09

Date: 24.MAY.2022 21:21:37



LTE Band 5B / 10MHz+5MHz

QPSK

Highest Channel / 1RB0 and 1RB24

Highest Channel / 1RB49 and 1RB0

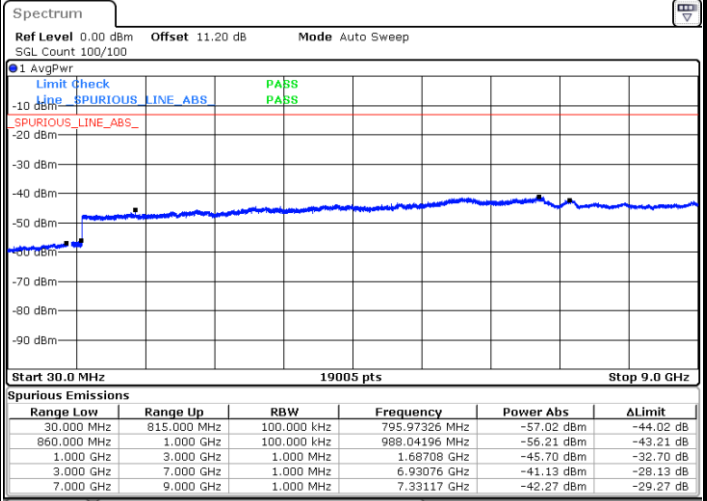
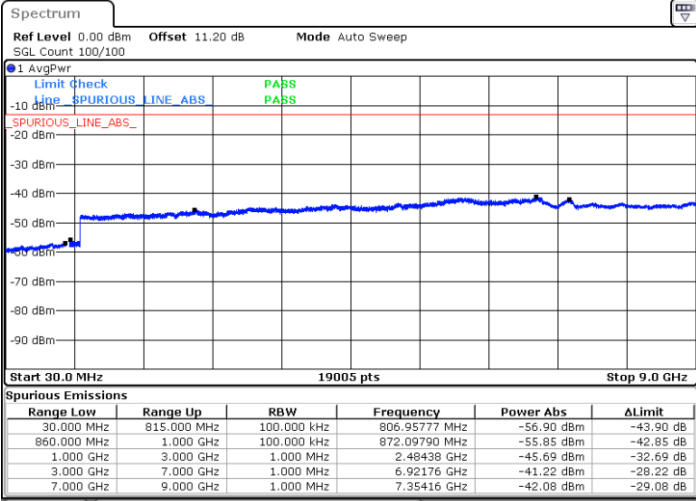

Date: 24.MAY.2022 20:50:47

Date: 24.MAY.2022 20:49:20



LTE Band 5B / 10MHz+10MHz

QPSK

Lowest Channel / 1RB0 and 1RB49

Lowest Channel / 1RB49 and 1RB0

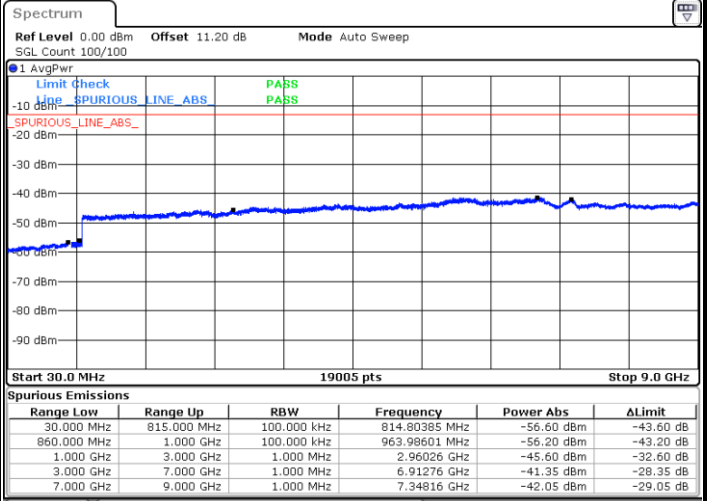
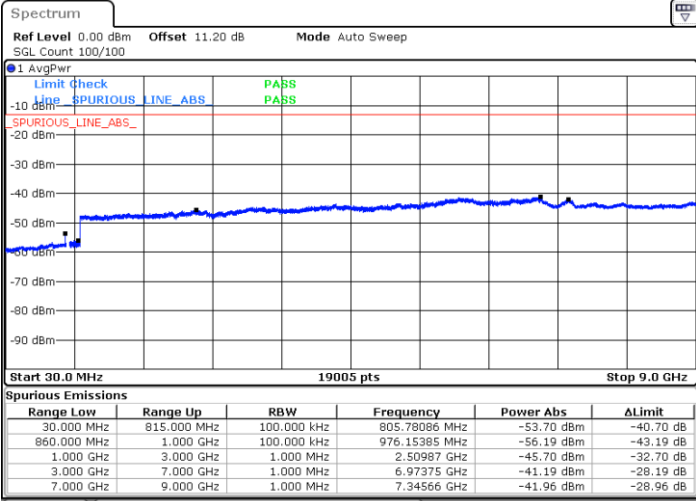

Date: 24.MAY.2022 22:05:02

Date: 24.MAY.2022 22:03:39

Middle Channel / 1RB0 and 1RB49

Middle Channel / 1RB49 and 1RB0

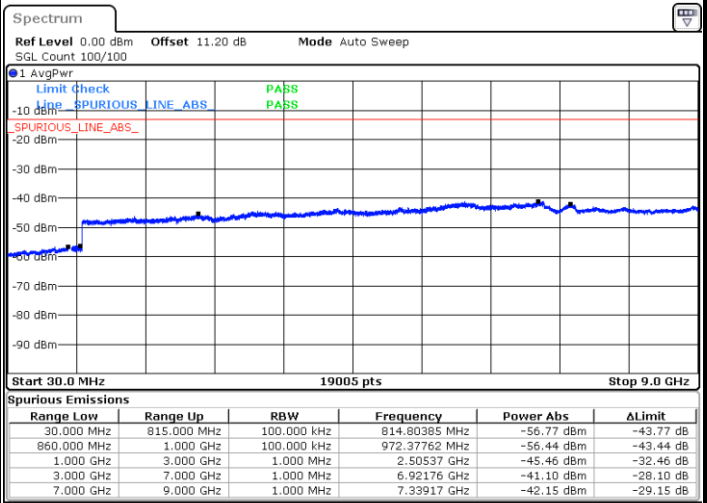
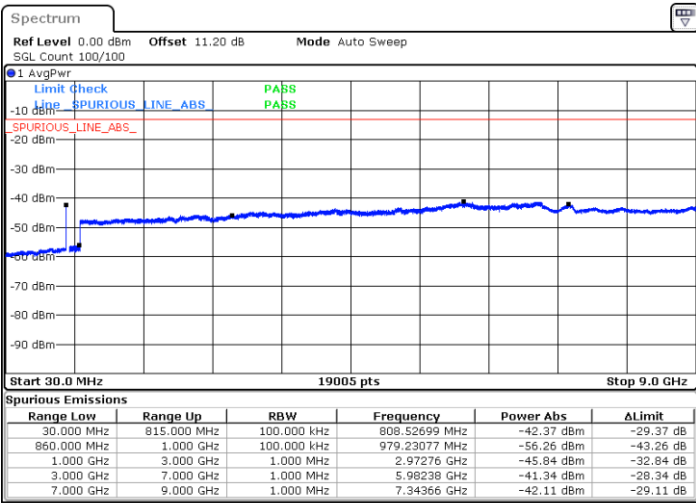

Date: 24.MAY.2022 22:15:52

Date: 24.MAY.2022 22:17:13



LTE Band 5B / 10MHz+10MHz

QPSK

Highest Channel / 1RB0 and 1RB49

Highest Channel / 1RB49 and 1RB0

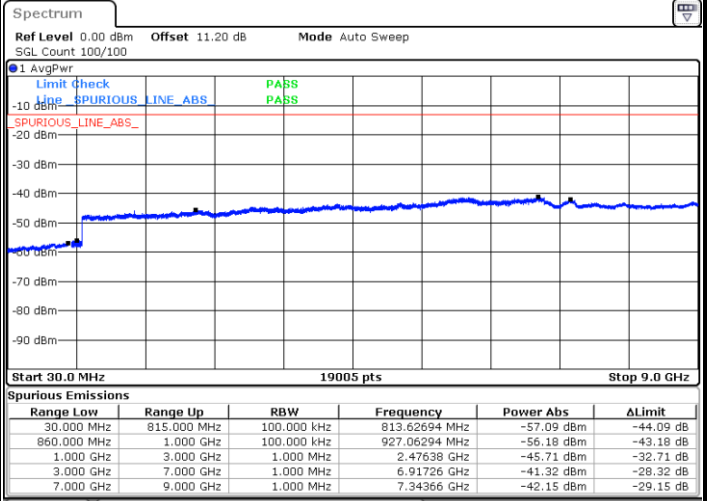
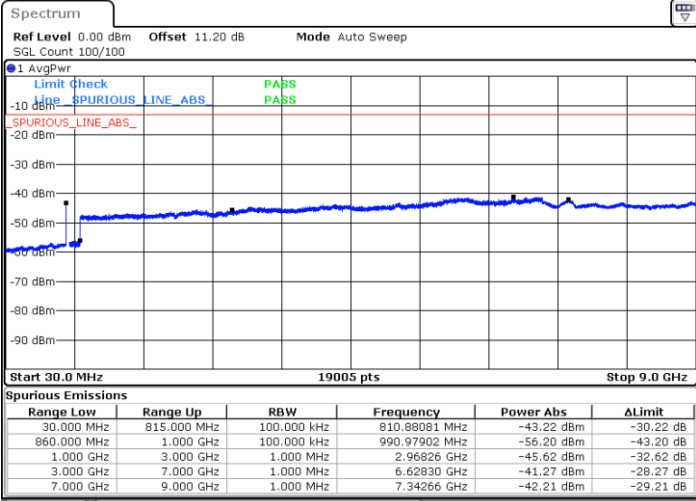

Date: 24.MAY.2022 21:43:15

Date: 24.MAY.2022 21:41:52



LTE Band 7

Peak-to-Average Ratio

Mode	LTE Band 7 / 20MHz				
Mod.	QPSK	16QAM	64QAM	256QAM	Limit: 13dB
RB Size	Full RB	Full RB	Full RB	Full RB	Result
Middle CH	5.48	6.55	6.49	-	PASS

LTE Band 7 / 20MHz / QPSK	LTE Band 7 / 20MHz / 16QAM
Middle Channel / Full RB	Middle Channel / Full RB

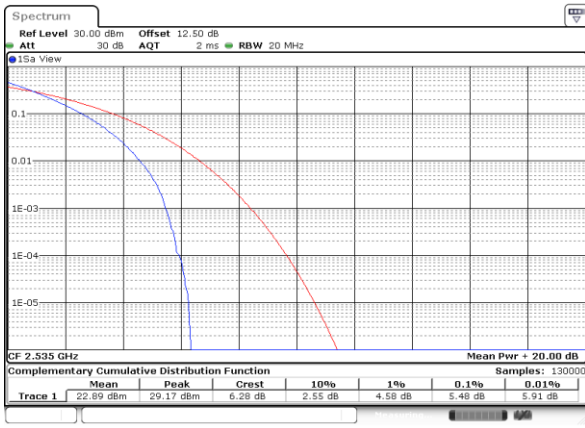

Date: 5.MAY.2022 12:23:07

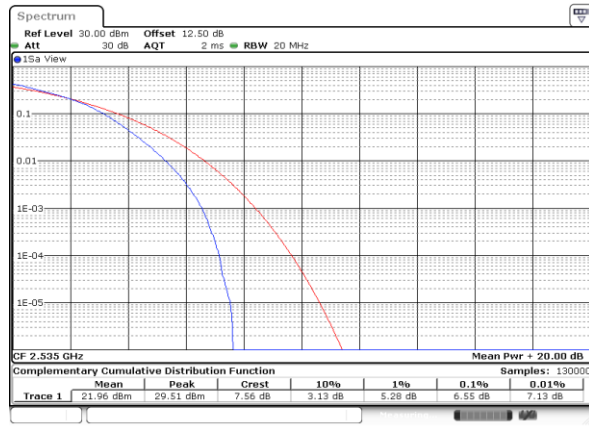

Date: 5.MAY.2022 12:22:41

LTE Band 7 / 20MHz / 64QAM
Middle Channel / Full RB

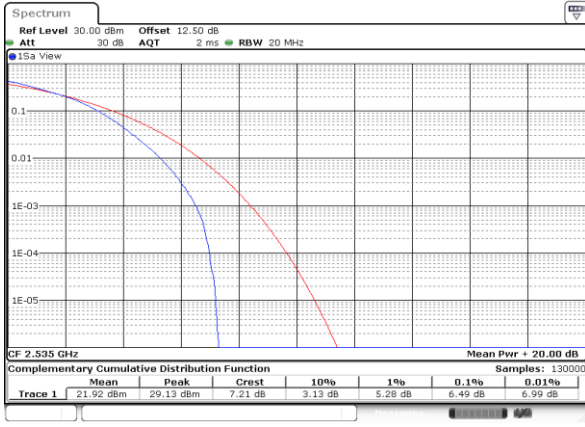

Date: 5.MAY.2022 12:23:32



26dB Bandwidth

Mode	LTE Band 7 : 26dB BW(MHz)											
BW	1.4MHz		3MHz		5MHz		10MHz		15MHz		20MHz	
Mod.	QPSK	16QAM	QPSK	16QAM	QPSK	16QAM	QPSK	16QAM	QPSK	16QAM	QPSK	16QAM
Middle CH	-	-	-	-	4.94	4.94	9.71	9.89	14.45	14.15	18.82	18.94
Mode	LTE Band 7 : 26dB BW(MHz)											
BW	1.4MHz		3MHz		5MHz		10MHz		15MHz		20MHz	
Mod.	64QAM	256QAM	64QAM	256QAM	64QAM	256QAM	64QAM	256QAM	64QAM	256QAM	64QAM	256QAM
Middle CH	-	-	-	-	4.92	-	9.75	-	14.45	-	18.98	-



LTE Band 7

Middle Channel / 5MHz / QPSK

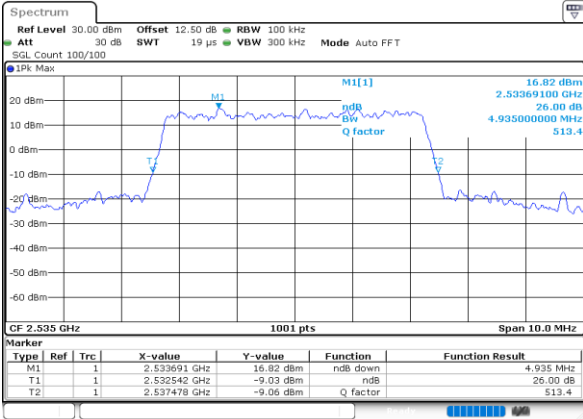

Date: 5.MAY.2022 11:19:15

Middle Channel / 5MHz / 16QAM

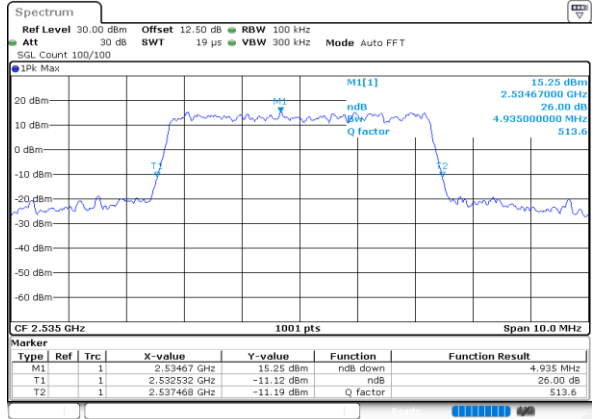

Date: 5.MAY.2022 11:19:38

Middle Channel / 10MHz / QPSK

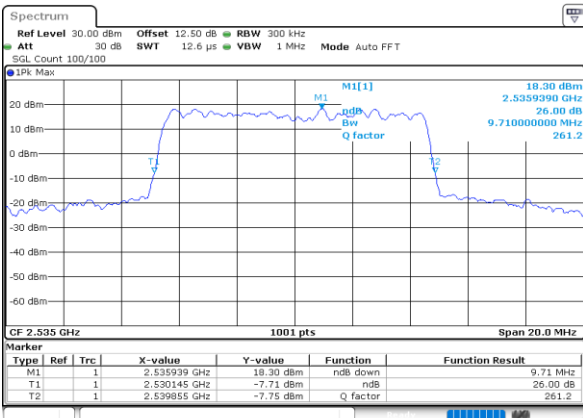

Date: 5.MAY.2022 11:13:11

Middle Channel / 10MHz / 16QAM

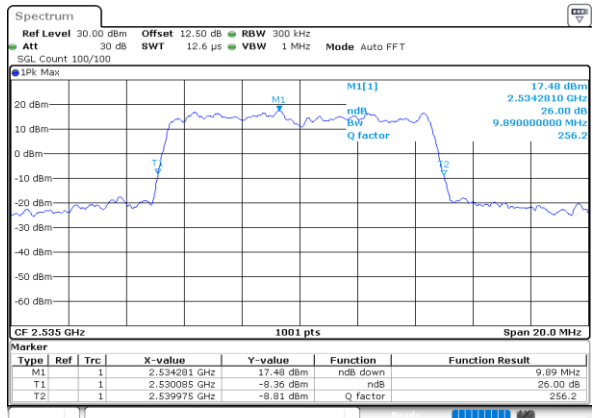

Date: 5.MAY.2022 11:13:55

Middle Channel / 15MHz / QPSK

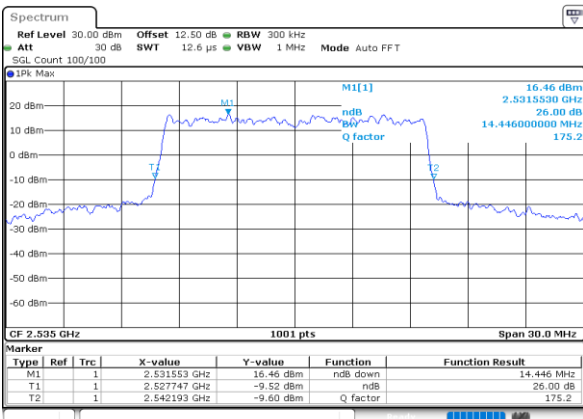

Date: 5.MAY.2022 11:53:50

Middle Channel / 15MHz / 16QAM

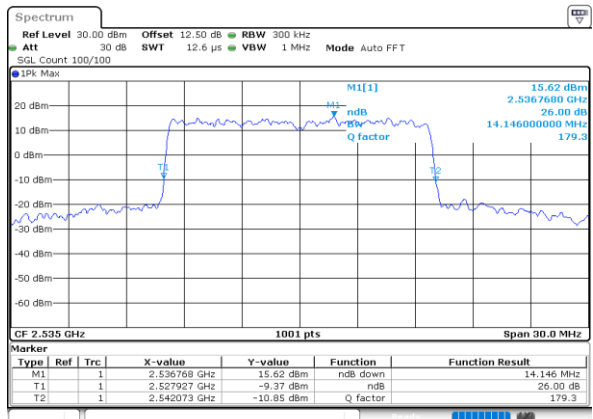

Date: 5.MAY.2022 11:54:14