



# FCC RADIO TEST REPORT

**FCC ID** : N7NEM75T  
**Equipment** : Radio Module  
**Brand Name** : AirPrime  
**Model Name** : EM7590  
**Applicant** : Sierra Wireless, Inc.  
13811 Wireless Way, Richmond, BC  
V6V 3A4 Canada  
**Manufacturer** : Sierra Wireless, Inc.  
13811 Wireless Way, Richmond, BC  
V6V 3A4 Canada  
**Standard** : FCC 47 CFR Part 2, 96

The product was received on Apr. 22, 2022 and testing was performed from Apr. 27, 2022 to Jul. 21, 2022. We, Sporton International Inc. EMC & Wireless Communications Laboratory, would like to declare that the tested sample has been evaluated in accordance with the test procedures given in ANSI / TIA-603-E and has been in compliance with the applicable technical standards.

The test results in this report apply exclusively to the tested model / sample. Without written approval of Sporton International Inc. EMC & Wireless Communications Laboratory, the test report shall not be reproduced except in full.

Approved by: Louis Wu

**Sporton International Inc. EMC & Wireless Communications Laboratory**

No. 52, Huaya 1st Rd., Guishan Dist., Taoyuan City 333, Taiwan (R.O.C.)



## Table of Contents

History of this test report.....	3
Summary of Test Result.....	4
<b>1 General Description .....</b>	<b>5</b>
1.1 Product Feature of Equipment Under Test .....	5
1.2 Modification of EUT .....	5
1.3 Testing Location .....	5
1.4 Applied Standards .....	6
<b>2 Test Configuration of Equipment Under Test .....</b>	<b>7</b>
2.1 Test Mode.....	7
2.2 Connection Diagram of Test System .....	8
2.3 Support Unit used in test configuration .....	9
2.4 Measurement Results Explanation Example .....	9
2.5 Frequency List of Low/Middle/High Channels.....	9
<b>3 Conducted Test Items.....</b>	<b>11</b>
3.1 Measuring Instruments.....	11
3.2 Conducted Output Power .....	12
3.3 Peak-to-Average Ratio .....	13
3.4 Occupied Bandwidth .....	14
3.5 Conducted Band Edge .....	15
3.6 Conducted Spurious Emission .....	16
3.7 Frequency Stability.....	17
<b>4 Radiated Test Items .....</b>	<b>18</b>
4.1 Measuring Instruments.....	18
4.2 Test Setup .....	18
4.3 Test Result of Radiated Test.....	19
4.4 Radiated Spurious Emission .....	20
<b>5 List of Measuring Equipment.....</b>	<b>21</b>
<b>6 Uncertainty of Evaluation.....</b>	<b>23</b>
<b>Appendix A. Test Results of Conducted Test</b>	
<b>Appendix B. Test Results of Radiated Test</b>	
<b>Appendix C. Test Setup Photographs</b>	



### History of this test report

Report No.	Version	Description	Issued Date
FG242018F	01	Initial issue of report	Aug. 09, 2022
FG242018F	02	Add the description of the measurement antenna orientation	Aug. 10, 2022



### Summary of Test Result

Report Clause	Ref Std. Clause	Test Items	Result (PASS/FAIL)	Remark
3.2	§2.1046	Conducted Output Power	Reporting only	-
3.3	§96.41	Peak-to-Average Ratio	Pass	
3.4	§2.1049 §96.41	Occupied Bandwidth	Reporting only	-
3.5	§2.1051 §96.41	Conducted Band Edge Measurement	Pass	-
3.6	§2.1051 §96.41	Conducted Spurious Emission	Pass	
3.7	§2.1055	Frequency Stability for Temperature & Voltage	Pass	-
4.4	§2.1051 §96.41	Radiated Spurious Emission	Pass	Under limit 1.57 dB at 7362.000 MHz

**Declaration of Conformity:**

1. The test results (PASS/FAIL) with all measurement uncertainty excluded are presented in accordance with the regulation limits or requirements declared by manufacturers. It's means measurement values may risk exceeding the limit of regulation standards, if measurement uncertainty is include in test results.
2. The measurement uncertainty please refer to this report "Uncertainty of Evaluation".

**Comments and Explanations:**

The product specifications of the EUT presented in the report are declared by the manufacturer who shall take full responsibility for the authenticity.

**Reviewed by: Avis Chuang**

**Report Producer: Clio Lo**



# 1 General Description

## 1.1 Product Feature of Equipment Under Test

WCDMA/LTE, and GNSS.

**Remark:**

1. The EUT's information above is declared by manufacturer. Please refer to Comments and Explanations in report summary.
2. Maximum allow antenna Gain : refer MPE Report FA242018.

## 1.2 Modification of EUT

No modifications are made to the EUT during all test items.

## 1.3 Testing Location

<b>Test Site</b>	Sporton International Inc. EMC & Wireless Communications Laboratory
<b>Test Site Location</b>	No.52, Huaya 1st Rd., Guishan Dist., Taoyuan City 333, Taiwan (R.O.C.) TEL: +886-3-327-3456 FAX: +886-3-328-4978
<b>Test Site No.</b>	<b>Sporton Site No.</b> TH03-HY
<b>Test Engineer</b>	George Chen
<b>Temperature (°C)</b>	22.8~24.3
<b>Relative Humidity (%)</b>	51.8~56.4

<b>Test Site</b>	Sporton International Inc. Wensan Laboratory
<b>Test Site Location</b>	No.58, Aly. 75, Ln. 564, Wenhua 3rd, Rd., Guishan Dist., Taoyuan City 333010, Taiwan (R.O.C.) TEL: +886-3-327-0868 FAX: +886-3-327-0855
<b>Test Site No.</b>	<b>Sporton Site No.</b> 03CH12-HY (TAF Code: 3786)
<b>Test Engineer</b>	Jack Cheng and Wilson Wu
<b>Temperature (°C)</b>	21.6~26.2
<b>Relative Humidity (%)</b>	56~68
<b>Remark</b>	The Radiated Spurious Emission test item subcontracted to Sporton International Inc. Wensan Laboratory.

**Note:** The test site complies with ANSI C63.4 2014 requirement.

FCC Designation No.: TW1190 and TW3786



## **1.4 Applied Standards**

According to the specifications of the manufacturer, the EUT must comply with the requirements of the following standards:

- ♦ ANSI C63.26-2015
- ♦ ANSI / TIA-603-E
- ♦ FCC 47 CFR Part 2, 96
- ♦ FCC KDB 971168 D01 Power Meas. License Digital Systems v03r01
- ♦ FCC KDB 940660 D01 Part 96 CBRS Eqpt v03
- ♦ FCC KDB 414788 D01 Radiated Test Site v01r01

**Remark:**

1. All test items were verified and recorded according to the standards and without any deviation during the test.
2. The TAF code is not including all the FCC KDB listed without accreditation.



## 2 Test Configuration of Equipment Under Test

### 2.1 Test Mode

Antenna port conducted and radiated test items listed below are performed according to KDB 971168 D01 Power Meas. License Digital Systems v03r01 with maximum output power.

For radiated measurement, the measured emission level of the EUT was maximized by rotating the EUT on a turntable, adjusting the orientation of the EUT and EUT antenna in two angle (Ant. Horizontal and Ant. Vertical), and adjusting the measurement antenna orientation, following C63.26 exploratory test procedures and find Ant. Vertical as worst plane.

Test Items	Band	Bandwidth (MHz)				Modulation			RB #			Test Channel		
		5	10	15	20	QPSK	16QAM	64QAM	1	Half	Full	L	M	H
Max. Output Power	48	v	v	v	v	v	v	v	v	v	v	v	v	v
26dB and 99% Bandwidth	48	v	v	v	v	v	v	v			v		v	
Conducted Band Edge	48	v	v	v	v	v	v	v	v		v	v	v	v
Peak-to-Average Ratio	48				v	v	v	v			v		v	
Conducted Spurious Emission	48	v	v	v	v	v			v			v	v	v
Frequency Stability	48		v			v			v				v	
Radiated Spurious Emission	48	Worst Case										v	v	v
Remark	<ol style="list-style-type: none"> <li>The mark "v " means that this configuration is chosen for testing</li> <li>The mark "- " means that this bandwidth is not supported.</li> <li>The device is investigated from 30MHz to 10 times of fundamental signal for radiated spurious emission test under different RB size/offset and modulations in exploratory test. Subsequently, only the worst case emissions are reported.</li> <li>One representative bandwidth is selected to perform PAR and frequency stability.</li> </ol>													

Test Items	Band	Bandwidth (MHz)										Modulation			RB #			Test Channel		
		20+20	20+15	15+20	20+10	10+20	20+5	5+20	15+15	15+10	10+15	QPSK	16QAM	64QAM	1	Half	Full	L	M	H
Max. Output Power	48_CA	v	v	v	v	v	v	v	-	-	-	v	v	v	v	v	v	v	v	v
26dB and 99% Bandwidth	48_CA	v	v	v	v	v	v	v	-	-	-	v	v	v			v			v
Conducted Band Edge	48_CA	v	v	v	v	v	v	v	-	-	-	v	v	v	v		v	v	v	v
Conducted Spurious Emission	48_CA	v	v	v	v	v	v	v	-	-	-	v			v			v	v	v
Remark	<ol style="list-style-type: none"> <li>The mark "v" means that this configuration is chosen for testing</li> <li>The mark "-" means that this bandwidth is not supported.</li> <li>The device is investigated from 30MHz to 10 times of fundamental signal for radiated spurious emission test under different RB size/offset and modulations in exploratory test. Subsequently, only the worst case emissions are reported.</li> </ol>																			

## 2.2 Connection Diagram of Test System

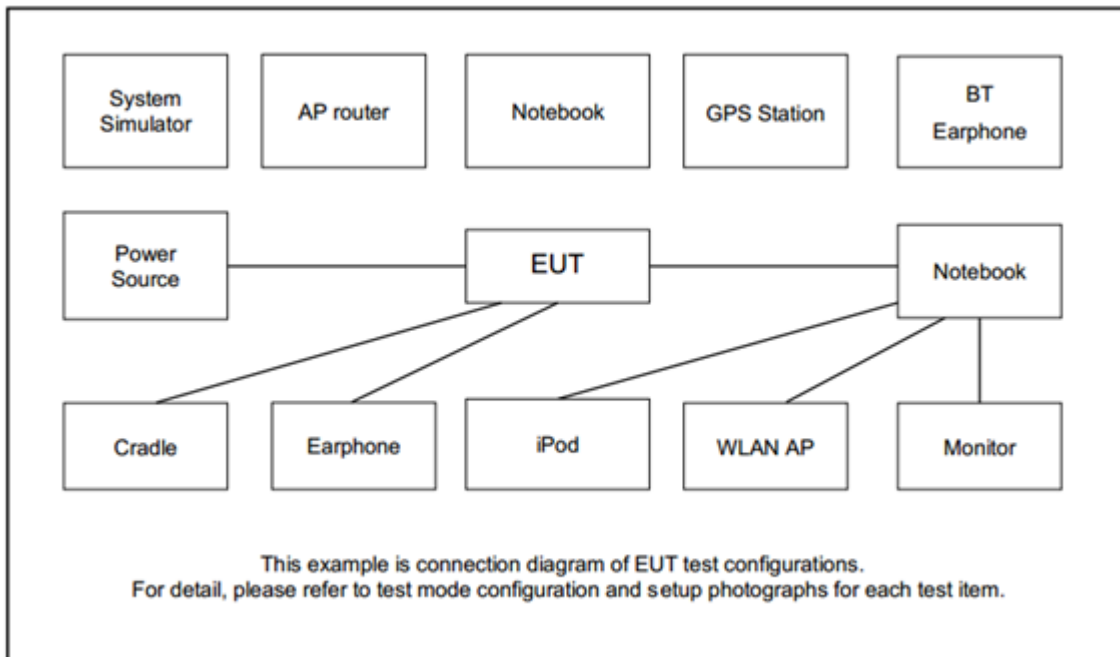





### 2.3 Support Unit used in test configuration

Item	Equipment	Brand Name	Model No.	FCC ID	Data Cable	Power Cord
1.	System Simulator	Anritsu	MT8821C	N/A	N/A	Unshielded, 1.8 m
2.	Antenna	PulseLarsen Antennas	SPDA24617/3900	N/A	N/A	N/A
3.	Fixture	Sierra Wireless	EM DevKit	N/A	N/A	N/A

### 2.4 Measurement Results Explanation Example

For all conducted test items:

The offset level is set in the spectrum analyzer to compensate the RF cable loss and attenuator factor between EUT conducted output port and spectrum analyzer. With the offset compensation, the spectrum analyzer reading level is exactly the EUT RF output level.

The spectrum analyzer offset is derived from RF cable loss and attenuator factor.

*Offset = RF cable loss + attenuator factor.*

Following shows an offset computation example with cable loss 4.2 dB and 10dB attenuator.

Example :

$$\begin{aligned}
 \text{Offset(dB)} &= \text{RF cable loss(dB)} + \text{attenuator factor(dB)} \\
 &= 4.2 + 10 = 14.2 \text{ (dB)}
 \end{aligned}$$

### 2.5 Frequency List of Low/Middle/High Channels

LTE Band 48 Channel and Frequency List				
BW [MHz]	Channel/Frequency(MHz)	Lowest	Middle	Highest
20	Channel	55340	55990	56640
	Frequency	3560.0	3625.0	3690.0
15	Channel	55315	55990	56665
	Frequency	3557.5	3625.0	3692.5
10	Channel	55290	55990	56690
	Frequency	3555.0	3625.0	3695.0
5	Channel	55265	55990	56715
	Frequency	3552.5	3625.0	3697.5



LTE Band 48C Channel and Frequency List_CA					
BW [MHz]	Channel/Frequency(MHz)		Lowest	Middle	Highest
20 + 20	PCC	Channel	55340	55891	56442
		Frequency	3560.0	3565.1	3570.2
	SCC	Channel	55538	56089	56640
		Frequency	3579.8	3634.9	3690
20 + 15	PCC	Channel	55340	55916	56491
		Frequency	3560.0	3617.6	3675.1
	SCC	Channel	55511	56087	56662
		Frequency	3577.1	3634.7	3692.2
15 + 20	PCC	Channel	55318	55893	56469
		Frequency	3557.8	3615.3	3672.9
	SCC	Channel	55489	56064	56640
		Frequency	3574.9	3632.4	3690
20 + 10	PCC	Channel	55340	55941	56541
		Frequency	3560	3620.1	3680.1
	SCC	Channel	55484	56085	56685
		Frequency	3574.4	3634.5	3694.5
10 + 20	PCC	Channel	55295	55896	56496
		Frequency	3555.5	3615.6	3675.6
	SCC	Channel	55439	56040	56640
		Frequency	3569.9	3630	3690
20 + 5	PCC	Channel	55340	55965	56590
		Frequency	3560	3622.5	3685
	SCC	Channel	55457	56082	56707
		Frequency	3571.7	3634.2	3696.7
5 + 20	PCC	Channel	55273	55898	56523
		Frequency	3553.3	3615.8	3678.3
	SCC	Channel	55390	56015	56640
		Frequency	3565	3627.5	3690

### 3 Conducted Test Items

#### 3.1 Measuring Instruments

See list of measuring instruments of this test report.

##### 3.1.1 Test Setup

##### 3.1.2 Conducted Output Power

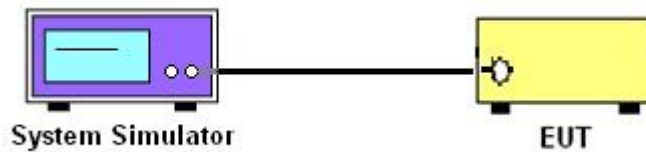

##### 3.1.3 Peak-to-Average Ratio, Occupied Bandwidth, Conducted Band Edge and Conducted Spurious Emission

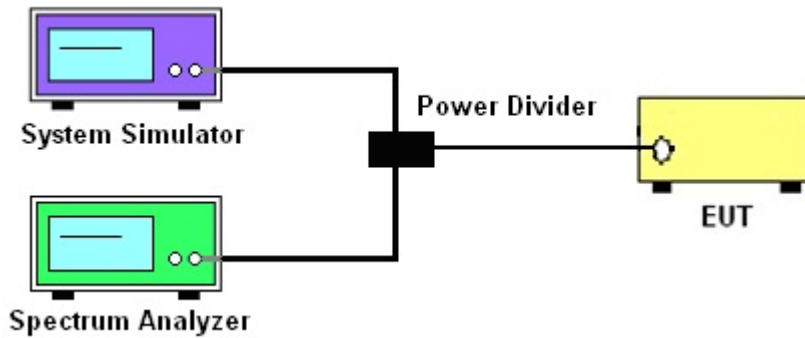

##### 3.1.4 Frequency Stability

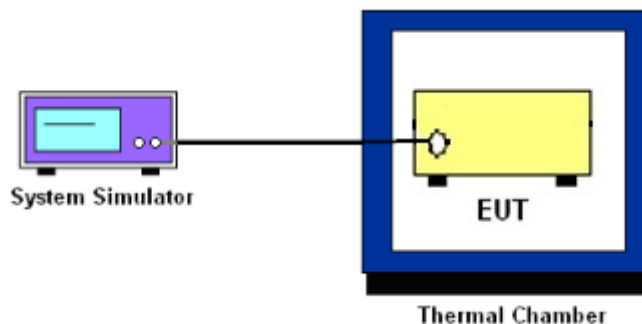

##### 3.1.5 Test Result of Conducted Test

Please refer to Appendix A.



## **3.2 Conducted Output Power**

### **3.2.1 Description of the Conducted Output Power Measurement**

A system simulator was used to establish communication with the EUT. Its parameters were set to force the EUT transmitting at maximum output power. The measured power in the radio frequency on the transmitter output terminals shall be reported.

### **3.2.2 Test Procedures**

1. The transmitter output port was connected to the system simulator.
2. Set EUT at maximum power through the system simulator.
3. Select lowest, middle, and highest channels for each band and different modulation.
4. Measure and record the power level from the system simulator.



### **3.3 Peak-to-Average Ratio**

#### **3.3.1 Description of the PAR Measurement**

Power Complementary Cumulative Distribution Function (CCDF) curves provide a means for characterizing the power peaks of a digitally modulated signal on a statistical basis. A CCDF curve depicts the probability of the peak signal amplitude exceeding the average power level. Most contemporary measurement instrumentation include the capability to produce CCDF curves for an input signal provided that the instrument's resolution bandwidth can be set wide enough to accommodate the entire input signal bandwidth. In measuring transmissions in this band using an average power technique, the peak-to-average ratio (PAR) of the transmission may not exceed 13 dB.

#### **3.3.2 Test Procedures**

The testing follows ANSI C63.26-2015 Section 5.2.6

1. The EUT was connected to spectrum and system simulator via a power divider.
2. Set the CCDF (Complementary Cumulative Distribution Function) option in spectrum analyzer.
3. The highest RF powers were measured and recorded the maximum PAPR level associated with a probability of 0.1 %.
4. Record the deviation as Peak to Average Ratio



## 3.4 Occupied Bandwidth

### 3.4.1 Description of Occupied Bandwidth Measurement

The occupied bandwidth is the width of a frequency band such that, below the lower and above the upper frequency limits, the mean powers emitted are each equal to a specified percentage 0.5% of the total mean transmitted power.

The 26 dB emission bandwidth is defined as the frequency range between two points, one above and one below the carrier frequency, at which the spectral density of the emission is attenuated 26 dB below the maximum in-band spectral density of the modulated signal. Spectral density (power per unit bandwidth) is to be measured with a detector of resolution bandwidth equal to approximately 1.0% of the emission bandwidth.

### 3.4.2 Test Procedures

The testing follows ANSI C63.26-2015 Section 5.4.3 (26dB) and Section 5.4.4 (99OB)

1. The EUT was connected to spectrum analyzer and system simulator via a power divider.
2. The spectrum analyzer center frequency is set to the nominal EUT channel center frequency. The span range for the spectrum analyzer shall be between two and five times the anticipated OBW.
3. The nominal resolution bandwidth (RBW) shall be in the range of 1 to 5 % of the anticipated OBW, and the VBW shall be at least 3 times the RBW.
4. Set the detection mode to peak, and the trace mode to max hold.
5. Determine the reference value: Set the EUT to transmit a modulated signal. Allow the trace to stabilize. Set the spectrum analyzer marker to the highest level of the displayed trace.  
(this is the reference value)
6. Determine the “-26 dB down amplitude” as equal to (Reference Value – X).
7. Place two markers, one at the lowest and the other at the highest frequency of the envelope of the spectral display such that each marker is at or slightly below the “-X dB down amplitude” determined in step 6. If a marker is below this “-X dB down amplitude” value it shall be placed as close as possible to this value. The OBW is the positive frequency difference between the two markers.
8. Use the 99 % power bandwidth function of the spectrum analyzer and report the measured bandwidth.



## 3.5 Conducted Band Edge

### 3.5.1 Description of Conducted Band Edge Measurement

The conducted power of any End User Device emission outside the fundamental emission (whether in or outside of the authorized band) shall not exceed  $-13$  dBm/MHz within 0 to B megahertz (where B is the bandwidth in megahertz of the assigned channel or multiple contiguous channels of the End User Device) above the upper CBSD-assigned channel edge and within 0 to B megahertz below the lower CBSD-assigned channel edge. At all frequencies greater than B megahertz above the upper CBSD assigned channel edge and less than B megahertz below the lower CBSD-assigned channel edge, the conducted power of any End User Device emission shall not exceed  $-25$  dBm/MHz. Notwithstanding the emission limits in this paragraph, the Adjacent Channel Leakage Ratio for End User Devices shall be at least 30 dB.

### 3.5.2 Test Procedures

The testing follows FCC KDB 971168 D01 v03r01 Section 6.1.

1. The EUT was connected to spectrum analyzer and system simulator via a power divider.
2. The band edges of low and high channels for the highest RF powers were measured.
3. Set RBW  $\geq$  1% EBW in the 1MHz band immediately outside and adjacent to the band edge.
4. Beyond the 1 MHz band from the band edge, RBW=1MHz was used
5. Set spectrum analyzer with RMS detector.
6. The RF fundamental frequency should be excluded against the limit line in the operating frequency band.

For Adjacent Channel Leakage Ratio (ACLR) measurement,

1. The Adjacent Channel Leakage Ratio (ACLR) is the ratio of the average power in the assigned aggregated channel bandwidth to the average power over the equivalent adjacent channel bandwidth.
2. The option ACLR of spectrum analyzer is used and measures the ACLR ratio by setting equivalent channel bandwidth.
3. The measured ACLR ratio shall be at least 30 dB.



## 3.6 Conducted Spurious Emission

### 3.6.1 Description of Conducted Spurious Emission Measurement

96.41 (e)(2)

The conducted power of any emissions below 3530 MHz or above 3720 MHz shall not exceed -40dBm/MHz.

### 3.6.2 Test Procedures

The testing follows FCC KDB 971168 D01 v03r01 Section 6.1.

1. The EUT was connected to spectrum analyzer and system simulator via a power divider.
2. The RF output of EUT was connected to the spectrum analyzer by RF cable and attenuator. The path loss was compensated to the results for each measurement.
3. The middle channel for the highest RF power within the transmitting frequency was measured.
4. The conducted spurious emission for the whole frequency range was taken.
5. Make the measurement with the spectrum analyzer's RBW = 1MHz, VBW = 3MHz.
6. Set spectrum analyzer with RMS detector.
7. Taking the record of maximum spurious emission.
8. The RF fundamental frequency should be excluded against the limit line in the operating frequency band.
9. The limit line is -40dBm/MHz.





## 3.7 Frequency Stability

### 3.7.1 Description of Frequency Stability Measurement

The frequency stability shall be measured by variation of ambient temperature and variation of primary supply voltage to ensure that the fundamental emission stays within the authorized frequency block. The frequency stability of the transmitter shall be maintained within  $\pm 0.00025\%$  ( $\pm 2.5\text{ppm}$ ) of the center frequency

### 3.7.2 Test Procedures for Temperature Variation

The testing follows FCC KDB 971168 D01 v03r01 Section 9.0.

1. The EUT was set up in the thermal chamber and connected with the system simulator.
2. With power OFF, the temperature was decreased to  $-30^{\circ}\text{C}$  and the EUT was stabilized before testing. Power was applied and the maximum change in frequency was recorded within one minute.
3. With power OFF, the temperature was raised in  $10^{\circ}\text{C}$  step up to  $50^{\circ}\text{C}$ . The EUT was stabilized at each step for at least half an hour. Power was applied and the maximum frequency change was recorded within one minute.

### 3.7.3 Test Procedures for Voltage Variation

The testing follows FCC KDB 971168 D01 v03r01 Section 9.0.

1. The EUT was placed in a temperature chamber at  $25\pm 5^{\circ}\text{C}$  and connected with the system simulator.
2. The power supply voltage to the EUT was varied from 85% to 115% of the nominal value measured at the input to the EUT.
3. The variation in frequency was measured for the worst case.

## 4 Radiated Test Items

### 4.1 Measuring Instruments

See list of measuring instruments of this test report.

### 4.2 Test Setup

For radiated emissions below 30MHz

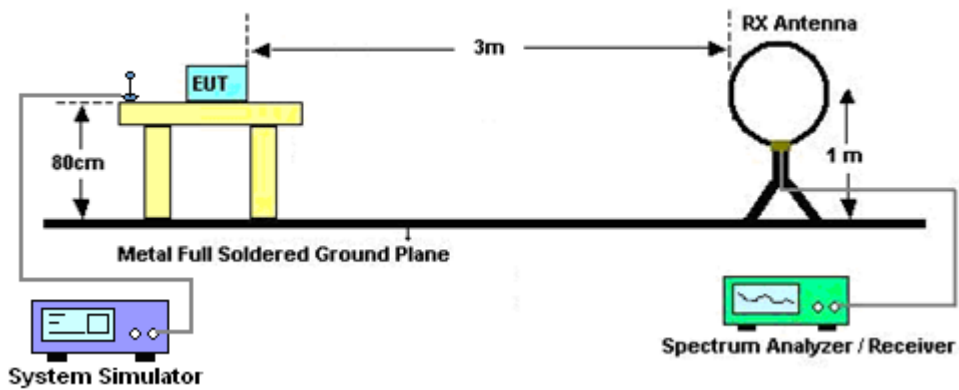

For radiated emissions from 30MHz to 1GHz

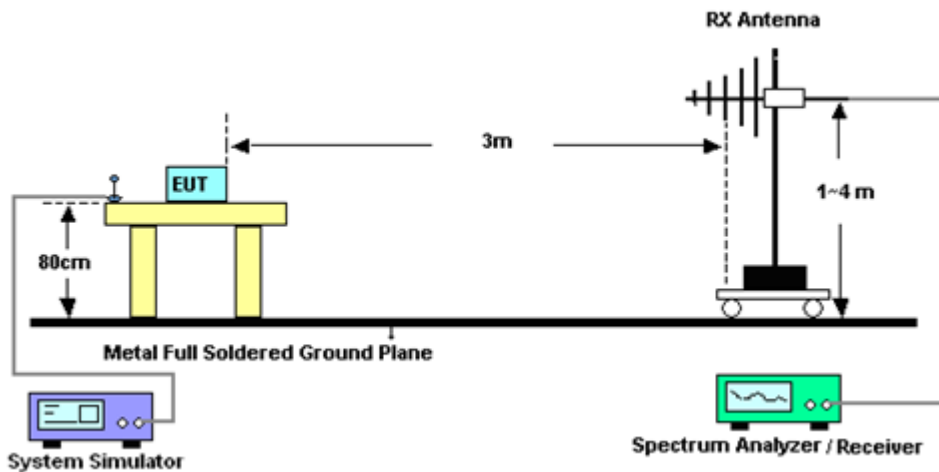

For radiated emissions from 1GHz to 18GHz

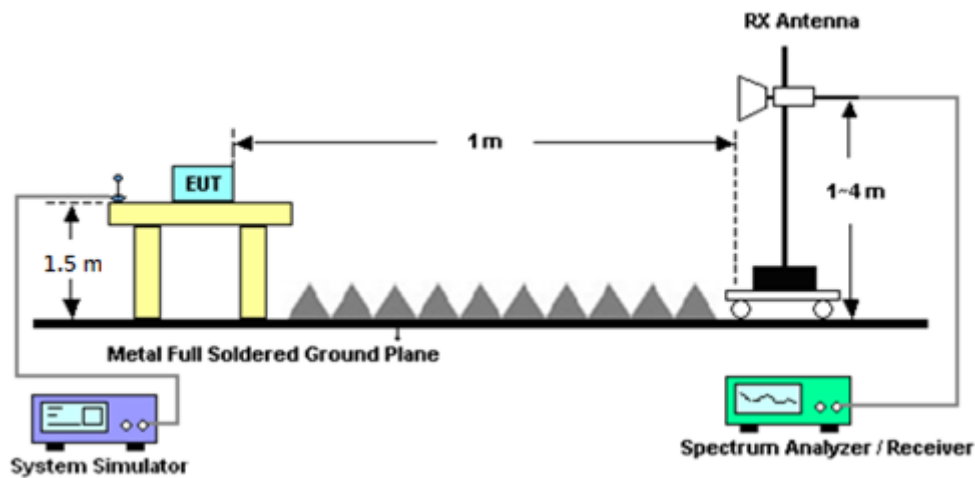

For radiated emissions above 18GHz

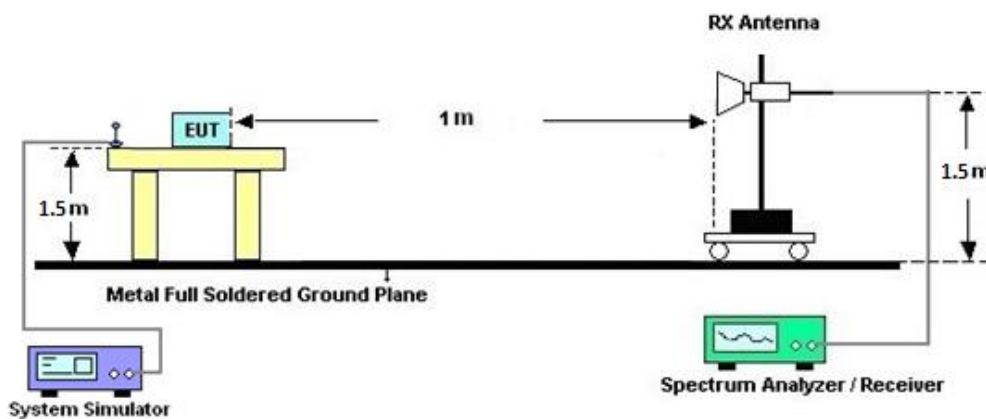

### 4.3 Test Result of Radiated Test

Please refer to Appendix B.

**Note:**

The low frequency, which started from 9 kHz to 30MHz, was pre-scanned and the result which was 20dB lower than the limit line was not reported.

There is adequate comparison measurement of both open-field test site and alternative test site - semi-Anechoic chamber according to 414788 D01 Radiated Test Site v01r01, and the result came out very similar.



## 4.4 Radiated Spurious Emission

### 4.4.1 Description of Radiated Spurious Emission Measurement

The radiated spurious emission was measured by substitution method according to ANSI / TIA-603-E. The power of any emission outside of the authorized operating frequency ranges must be attenuated below the transmitter power (P) by a factor of at least -40dBm / MHz .  
The spectrum is scanned from 30 MHz up to a frequency including its 10th harmonic.

### 4.4.2 Test Procedures

The testing follows FCC KDB 971168 D01 v03r01 Section 7 and ANSI / TIA-603-E Section 2.2.12.

1. The EUT was placed on a turntable with 0.8 meter height for frequency below 1GHz and 1.5 meter height for frequency above 1GHz respectively above ground.
2. The EUT was set 3 meters from the receiving antenna mounted on the antenna tower.
3. The table was rotated 360 degrees to determine the position of the highest spurious emission.
4. The height of the receiving antenna is varied between 1m to 4m to search the maximum spurious emission for both horizontal and vertical polarizations.
5. During the measurement, the system simulator parameters were set to force the EUT transmitting at maximum output power.
6. Make the measurement with the spectrum analyzer's RBW = 1MHz, VBW = 3MHz, taking the record of maximum spurious emission.
7. A horn antenna was substituted in place of the EUT and was driven by a signal generator. Tune the output power of signal generator to the same emission level with EUT maximum spurious emission.  
$$\text{EIRP (dBm)} = \text{S.G. Power} - \text{Tx Cable Loss} + \text{Tx Antenna Gain}$$
$$\text{ERP (dBm)} = \text{EIRP} - 2.15$$
8. The RF fundamental frequency should be excluded against the limit line in the operating frequency band.



## 5 List of Measuring Equipment

Instrument	Brand Name	Model No.	Serial No.	Characteristics	Calibration Date	Test Date	Due Date	Remark
Loop Antenna	Rohde & Schwarz	HFH2-Z2	100488	9 kHz~30 MHz	Sep. 07, 2021	May 04, 2022~ May 05, 2022	Sep. 06, 2022	Radiation (03CH12-HY)
Bilog Antenna	TESEQ	CBL 6111D & 00800N1D01N -06	37059 & 01	30MHz~1GHz	Oct. 09, 2021	May 04, 2022~ May 05, 2022	Oct. 08, 2022	Radiation (03CH12-HY)
Bilog Antenna	TESEQ	CBL 6111D & N-6-06	35414 & AT-N0602	30MHz~1GHz	Oct. 09, 2021	May 04, 2022~ May 05, 2022	Oct. 08, 2022	Radiation (03CH12-HY)
Horn Antenna	SCHWARZBE CK	BBHA 9120 D	9120D-1328	1GHz~18GHz	Dec. 03, 2021	May 04, 2022~ May 05, 2022	Dec. 02, 2022	Radiation (03CH12-HY)
Horn Antenna	SCHWARZBE CK	BBHA 9120 D	9120D-1212	1GHz~18GHz	May 18, 2021	May 04, 2022~ May 05, 2022	May 17, 2022	Radiation (03CH12-HY)
SHF-EHF Horn Antenna	SCHWARZBE CK	BBHA 9170	BBHA91702 51	18GHz~40GHz	Nov. 30, 2021	May 04, 2022~ May 05, 2022	Nov. 29, 2022	Radiation (03CH12-HY)
SHF-EHF Horn Antenna	SCHWARZBE CK	BBHA 9170	BBHA91705 76	18GHz~40GHz	May 21, 2021	May 04, 2022~ May 05, 2022	May 20, 2022	Radiation (03CH12-HY)
Preamplifier	COM-POWER	PA-103	161075	10MHz~1GHz	Mar. 23, 2022	May 04, 2022~ May 05, 2022	Mar. 22, 2023	Radiation (03CH12-HY)
Preamplifier	Aglient	8449B	3008A02375	1GHz~26.5GHz	May 25, 2021	May 04, 2022~ May 05, 2022	May 24, 2022	Radiation (03CH12-HY)
Preamplifier	E-INSTRUME NT TECH LTD.	ERA-100M-18 G-56-01-A70	EC1900270	1GHz-18GHz	Dec. 27, 2021	May 04, 2022~ May 05, 2022	Dec. 26, 2022	Radiation (03CH12-HY)
Preamplifier	EMEC	EM18G40G	060715	18GHz~40GHz	Dec. 24, 2021	May 04, 2022~ May 05, 2022	Dec. 23, 2022	Radiation (03CH12-HY)
Spectrum Analyzer	Keysight	N9010A	MY53470118	10Hz~44GHz	Jan. 12, 2022	May 04, 2022~ May 05, 2022	Jan. 11, 2023	Radiation (03CH12-HY)
RF Cable	HUBER + SUHNER	SUCOFLEX 104	MY9837/4PE	9kHz~30MHz	Mar. 10, 2022	May 04, 2022~ May 05, 2022	Mar. 09, 2023	Radiation (03CH12-HY)
RF Cable	HUBER + SUHNER	SUCOFLEX 126E	0058/126E	30MHz~18GHz	Dec. 10, 2021	May 04, 2022~ May 05, 2022	Dec. 09, 2022	Radiation (03CH12-HY)
RF Cable	HUBER + SUHNER	SUCOFLEX 102	505134/2	30MHz~40GHz	Feb. 21, 2022	May 04, 2022~ May 05, 2022	Feb. 20, 2023	Radiation (03CH12-HY)
RF Cable	HUBER + SUHNER	SUCOFLEX 102	803953/2	30MHz~40GHz	Mar. 08, 2022	May 04, 2022~ May 05, 2022	Mar. 07, 2023	Radiation (03CH12-HY)
Filter	Wainwright	WLKS1200-12 SS	SN2	1.2GHz Low Pass Filter	Mar. 16, 2022	May 04, 2022~ May 05, 2022	Mar. 15, 2023	Radiation (03CH12-HY)
Filter	Wainwright	WHKX8-5872. 5-6750-18000- 40ST	SN2	6.75GHz High Pass Filter	Mar. 16, 2022	May 04, 2022~ May 05, 2022	Mar. 15, 2023	Radiation (03CH12-HY)



Instrument	Brand Name	Model No.	Serial No.	Characteristics	Calibration Date	Test Date	Due Date	Remark
Hygrometer	TECPEL	DTM-303B	TP140349	N/A	Sep. 30, 2021	May 04, 2022~ May 05, 2022	Sep. 29, 2022	Radiation (03CH12-HY)
Controller	EMEC	EM1000	N/A	Control Turn table & Ant Mast	N/A	May 04, 2022~ May 05, 2022	N/A	Radiation (03CH12-HY)
Antenna Mast	EMEC	AM-BS-4500-B	N/A	1m~4m	N/A	May 04, 2022~ May 05, 2022	N/A	Radiation (03CH12-HY)
Turn Table	EMEC	TT2000	N/A	0~360 Degree	N/A	May 04, 2022~ May 05, 2022	N/A	Radiation (03CH12-HY)
Software	Audix	E3 6.2009-8-24	RK-000989	N/A	N/A	May 04, 2022~ May 05, 2022	N/A	Radiation (03CH12-HY)
Radio Communication Analyzer	Anritsu	MT8821C	6262025280	LTE FDD/TDD LTE-2CC DLCA/ULCA	Oct. 29, 2021	Apr. 27, 2022~ Jul. 21, 2022	Oct. 28, 2022	Conducted (TH03-HY)
Spectrum Analyzer	Rohde & Schwarz	FSV40	101908	10Hz~40GHz	Oct. 01, 2021	Apr. 27, 2022~ Jul. 21, 2022	Sep. 30, 2022	Conducted (TH03-HY)
Thermal Chamber	ESPEC	SH-641	92013720	-40°C ~90°C	Sep. 09, 2021	Apr. 27, 2022~ Jul. 21, 2022	Sep. 08, 2022	Conducted (TH03-HY)
DC Power Supply	GW Instek	GPP-2323	GES906037	0V~64V : 0A~6A	Jan. 06, 2022	Apr. 27, 2022~ Jul. 21, 2022	Jan. 05, 2023	Conducted (TH03-HY)
Coupler	Warison	20dB 25W SMA Directional Coupler	#B	1-18GHz	Jan. 07, 2022	Apr. 27, 2022~ Jul. 21, 2022	Jan. 06, 2023	Conducted (TH03-HY)



## 6 Uncertainty of Evaluation

### Uncertainty of Radiated Emission Measurement (30 MHz ~ 1000 MHz)

Measuring Uncertainty for a Level of Confidence of 95% ( $U = 2Uc(y)$ )	3.31 dB
---	---------

### Uncertainty of Radiated Emission Measurement (1 GHz ~ 18 GHz)

Measuring Uncertainty for a Level of Confidence of 95% ( $U = 2Uc(y)$ )	3.39 dB
---	---------

### Uncertainty of Radiated Emission Measurement (18 GHz ~ 40 GHz)

Measuring Uncertainty for a Level of Confidence of 95% ( $U = 2Uc(y)$ )	4.34 dB
---	---------



## Appendix A. Test Results of Conducted Test

### Conducted Output Power(Average power)

LTE Band 48 Maximum Average Power [dBm]								
BW [MHz]	RB Size	RB Offset	Mod	Lowest	Middle	Highest	Maximum Output Power (dBm)	Maximum Output Power (W)
20	1	0	QPSK	18.61	18.21	18.11	22.44	0.1754
20	1	49		22.44	22.24	22.40		
20	1	99		18.59	18.22	18.47		
20	50	0		21.59	21.32	21.24		
20	50	24		21.62	21.32	21.35		
20	50	50		21.63	21.32	21.33		
20	100	0		18.65	18.32	18.31		
20	1	0	16-QAM	17.98	17.46	17.56	21.92	0.1556
20	1	49		21.92	21.48	21.74		
20	1	99		17.97	17.70	17.73		
20	50	0		20.72	20.38	20.30		
20	50	24		20.80	20.40	20.40		
20	50	50		20.72	20.39	20.39		
20	100	0		17.75	17.40	17.46		
20	1	0	64-QAM	16.60	16.17	16.26	20.54	0.1132
20	1	49		20.54	20.18	20.20		
20	1	99		16.66	16.37	16.48		
20	50	0		19.59	19.37	19.27		
20	50	24		19.74	19.42	19.39		
20	50	50		19.77	19.43	19.49		
20	100	0		16.74	16.37	16.45		





LTE Band 48 Maximum Average Power [dBm]								
BW [MHz]	RB Size	RB Offset	Mod	Lowest	Middle	Highest	Maximum Output Power (dBm)	Maximum Output Power (W)
15	1	0	QPSK	18.55	18.26	18.25	22.88	0.1941
15	1	37		22.88	22.26	22.42		
15	1	74		18.75	18.50	18.43		
15	36	0		21.62	21.36	21.29		
15	36	20		21.63	21.36	21.38		
15	36	39		21.61	21.32	21.43		
15	75	0		19.60	19.30	19.37		
15	1	0	16-QAM	17.90	17.61	17.50	21.80	0.1514
15	1	37		21.80	21.73	21.43		
15	1	74		18.00	17.65	17.68		
15	36	0		20.66	20.35	20.27		
15	36	20		20.74	20.35	20.37		
15	36	39		20.73	20.32	20.44		
15	75	0		18.66	18.35	18.41		
15	1	0	64-QAM	16.61	16.21	16.19	20.74	0.1186
15	1	37		20.74	20.42	20.22		
15	1	74		16.70	16.43	16.44		
15	36	0		19.58	19.29	19.30		
15	36	20		19.72	19.43	19.42		
15	36	39		19.73	19.41	19.38		
15	75	0		17.66	17.33	17.37		



LTE Band 48 Maximum Average Power [dBm]								
BW [MHz]	RB Size	RB Offset	Mod	Lowest	Middle	Highest	Maximum Output Power (dBm)	Maximum Output Power (W)
10	1	0	QPSK	22.39	22.23	22.21	22.69	0.1858
10	1	25		22.68	22.18	22.13		
10	1	49		22.69	22.17	22.31		
10	25	0		21.55	21.19	21.44		
10	25	12		21.56	21.40	21.33		
10	25	25		21.70	21.43	21.44		
10	50	0		21.60	21.24	21.37		
10	1	0	16-QAM	22.03	21.51	21.54	22.03	0.1596
10	1	25		21.92	21.62	21.46		
10	1	49		21.93	21.61	21.53		
10	25	0		20.58	20.44	20.47		
10	25	12		20.70	20.45	20.36		
10	25	25		20.74	20.46	20.37		
10	50	0		20.67	20.30	20.33		
10	1	0	64-QAM	20.71	20.38	20.40	20.80	0.1202
10	1	25		20.65	20.39	20.37		
10	1	49		20.80	20.23	20.35		
10	25	0		19.69	19.42	19.43		
10	25	12		19.73	19.56	19.44		
10	25	25		19.88	19.36	19.45		
10	50	0		19.74	19.33	19.45		



LTE Band 48 Maximum Average Power [dBm]								
BW [MHz]	RB Size	RB Offset	Mod	Lowest	Middle	Highest	Maximum Output Power (dBm)	Maximum Output Power (W)
5	1	0	QPSK	22.41	22.30	22.12	22.62	0.1828
5	1	12		22.58	22.24	22.10		
5	1	24		22.62	22.16	22.18		
5	12	0		21.71	21.20	21.25		
5	12	7		21.58	21.27	21.31		
5	12	13		21.58	21.16	21.30		
5	25	0		21.52	21.22	21.25		
5	1	0	16-QAM	21.93	21.48	21.56	22.03	0.1596
5	1	12		22.03	21.48	21.53		
5	1	24		21.97	21.62	21.66		
5	12	0		20.56	20.24	20.28		
5	12	7		20.76	20.44	20.36		
5	12	13		20.75	20.32	20.34		
5	25	0		20.69	20.37	20.40		
5	1	0	64-QAM	20.63	20.38	20.23	20.67	0.1167
5	1	12		20.67	20.39	20.34		
5	1	24		20.66	20.36	20.40		
5	12	0		19.68	19.33	19.35		
5	12	7		19.78	19.42	19.53		
5	12	13		19.68	19.31	19.31		
5	25	0		19.84	19.37	19.38		



LTE Band 48C_CA Maximum Average Power [dBm]										
BW [MHz]	PCC		SCC		Mod	Lowest	Middle	Highest	Maximum Output Power (dBm)	Maximum Output Power (W)
	RB Size	RB Offset	RB Size	RB Offset						
20+20	100	0	100	0	QPSK	12.52	18.58	12.19	22.06	0.1607
20+20	1	0	1	99		5.49	11.77	5.17		
20+20	1	99	1	0		18.91	22.06	18.57		
20+20	100	0	100	0	16-QAM	12.54	18.67	12.25	22.54	0.1795
20+20	1	0	1	99		5.96	12.28	5.64		
20+20	1	99	1	0		19.34	22.54	19.16		
20+20	100	0	100	0	64-QAM	12.53	18.66	12.28	20.31	0.1074
20+20	1	0	1	99		5.68	11.95	5.33		
20+20	1	99	1	0		19.16	20.31	18.82		
20+15	100	0	75	0	QPSK	12.48	18.61	12.19	22.09	0.1618
20+15	1	0	1	74		5.44	11.68	5.13		
20+15	1	74	1	0		17.39	22.09	17.12		
20+15	100	0	75	0	16-QAM	12.51	18.66	12.24	22.64	0.1837
20+15	1	0	1	74		5.90	12.17	5.63		
20+15	1	74	1	0		17.89	22.64	17.60		
20+15	100	0	75	0	64-QAM	12.50	18.66	12.22	20.32	0.1076
20+15	1	0	1	74		5.56	11.87	5.31		
20+15	1	74	1	0		17.55	20.32	17.32		
15+20	75	0	100	0	QPSK	12.49	18.60	12.16	22.04	0.1600
15+20	1	0	1	99		5.47	11.62	5.11		
15+20	1	74	1	0		17.42	22.04	17.07		
15+20	75	0	100	0	16-QAM	12.48	18.66	12.19	22.60	0.1820
15+20	1	0	1	99		5.88	12.10	5.58		
15+20	1	74	1	0		17.89	22.60	17.55		
15+20	75	0	100	0	64-QAM	12.47	18.66	12.20	20.29	0.1069
15+20	1	0	1	99		5.59	11.81	5.28		
15+20	1	74	1	0		17.59	20.29	17.24		



LTE Band 48C_CA Maximum Average Power [dBm]										
BW [MHz]	PCC		SCC		Mod	Lowest	Middle	Highest	Maximum Output Power (dBm)	Maximum Output Power (W)
	RB Size	RB Offset	RB Size	RB Offset						
20+10	100	0	50	0	QPSK	12.47	18.63	12.16	21.69	0.1476
20+10	1	0	1	49		5.49	11.68	5.16		
20+10	1	99	1	0		17.48	21.69	17.19		
20+10	100	0	50	0	16-QAM	12.46	18.68	12.18	22.24	0.1675
20+10	1	0	1	49		6.06	12.14	5.60		
20+10	1	99	1	0		17.97	22.24	17.67		
20+10	100	0	50	0	64-QAM	12.45	18.67	12.18	20.43	0.1104
20+10	1	0	1	49		5.63	11.91	5.30		
20+10	1	99	1	0		17.67	20.43	17.61		
10+20	50	0	100	0	QPSK	12.48	18.58	12.17	21.62	0.1452
10+20	1	0	1	99		5.44	11.60	5.10		
10+20	1	49	1	0		17.43	21.62	17.12		
10+20	50	0	100	0	16-QAM	12.54	18.68	12.23	22.16	0.1644
10+20	1	0	1	99		5.93	12.13	5.61		
10+20	1	49	1	0		17.95	22.16	17.63		
10+20	50	0	100	0	64-QAM	12.51	18.64	12.21	20.32	0.1076
10+20	1	0	1	99		5.62	11.80	5.26		
10+20	1	49	1	0		17.60	20.32	17.29		
20+5	100	0	25	0	QPSK	12.27	18.58	12.26	21.72	0.1486
20+5	1	0	1	24		5.53	11.74	5.06		
20+5	1	99	1	0		17.61	21.72	17.19		
20+5	100	0	25	0	16-QAM	12.65	18.74	12.12	22.08	0.1614
20+5	1	0	1	24		5.97	12.21	5.60		
20+5	1	99	1	0		18.04	22.08	17.64		
20+5	100	0	25	0	64-QAM	12.30	18.82	12.26	20.37	0.1089
20+5	1	0	1	24		5.53	11.81	5.20		
20+5	1	99	1	0		17.80	20.37	17.76		



LTE Band 48C_CA Maximum Average Power [dBm]										
BW [MHz]	PCC		SCC		Mod	Lowest	Middle	Highest	Maximum Output Power (dBm)	Maximum Output Power (W)
	RB Size	RB Offset	RB Size	RB Offset						
5+20	25	0	100	0	QPSK	11.46	19.05	11.12	21.08	0.1282
5+20	1	0	1	99		5.47	11.63	5.11		
5+20	1	24	1	0		17.97	21.08	17.61		
5+20	25	0	100	0	16-QAM	11.49	19.12	11.12	21.68	0.1472
5+20	1	0	1	99		5.85	12.05	5.54		
5+20	1	24	1	0		18.47	21.68	18.12		
5+20	25	0	100	0	64-QAM	11.51	19.15	11.14	20.37	0.1089
5+20	1	0	1	99		5.56	11.79	5.27		
5+20	1	24	1	0		18.43	20.37	18.09		



## LTE Band 48

### Peak-to-Average Ratio

Mode	LTE Band 48 / 20MHz				
Mod.	QPSK	16QAM	64QAM	256QAM	Limit: 13dB
RB Size	Full RB	Full RB	Full RB	Full RB	Result
Middle CH	5.30	6.29	6.64	-	PASS

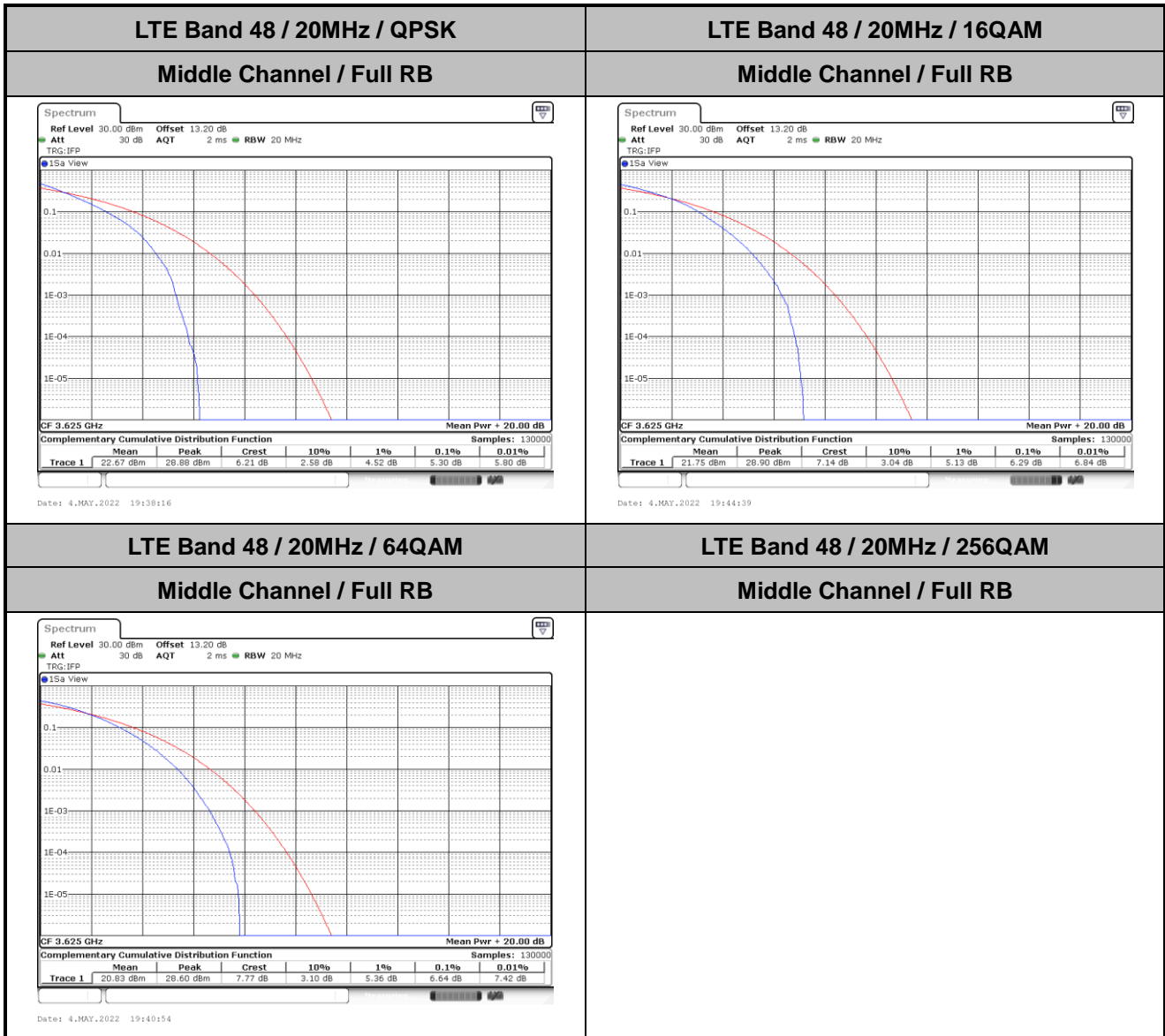





**26dB Bandwidth**

Mode	LTE Band 48 : 26dB BW(MHz)											
BW	1.4MHz		3MHz		5MHz		10MHz		15MHz		20MHz	
Mod.	QPSK	16QAM	QPSK	16QAM	QPSK	16QAM	QPSK	16QAM	QPSK	16QAM	QPSK	16QAM
Middle CH	-	-	-	-	4.86	4.86	9.69	9.67	14.12	14.42	18.82	18.78
Mode	LTE Band 48 : 26dB BW(MHz)											
BW	1.4MHz		3MHz		5MHz		10MHz		15MHz		20MHz	
Mod.	64QAM	256QAM	64QAM	256QAM	64QAM	256QAM	64QAM	256QAM	64QAM	256QAM	64QAM	256QAM
Middle CH	-	-	-	-	4.78	-	9.69	-	14.15	-	18.78	-



LTE Band 48

Middle Channel / 5MHz / QPSK

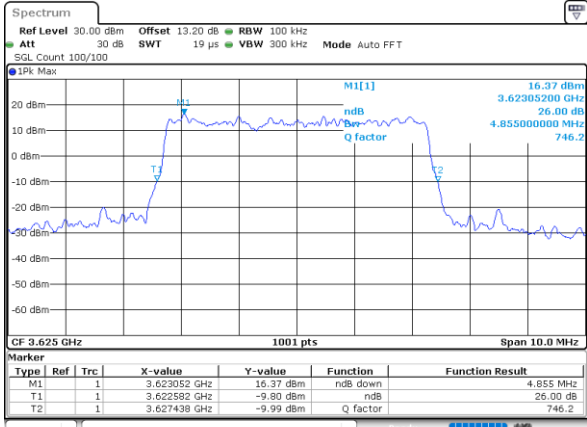

Date: 4.MAY.2022 19:22:22

Middle Channel / 5MHz / 16QAM

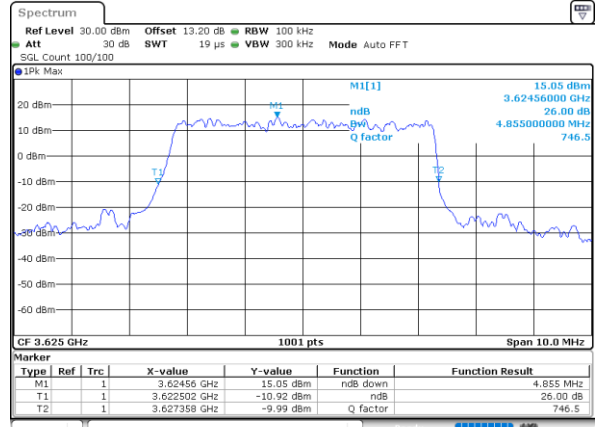

Date: 4.MAY.2022 19:22:50

Middle Channel / 10MHz / QPSK

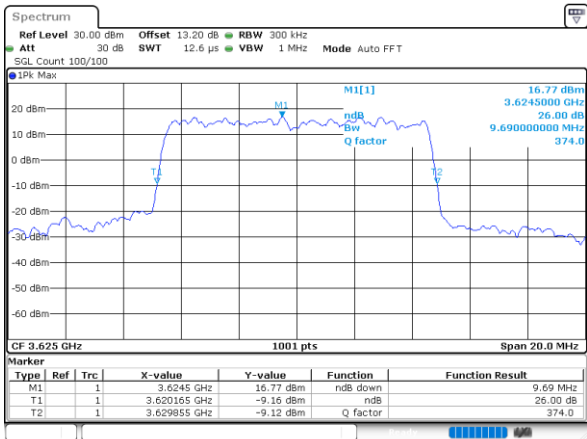

Date: 4.MAY.2022 19:24:23

Middle Channel / 10MHz / 16QAM

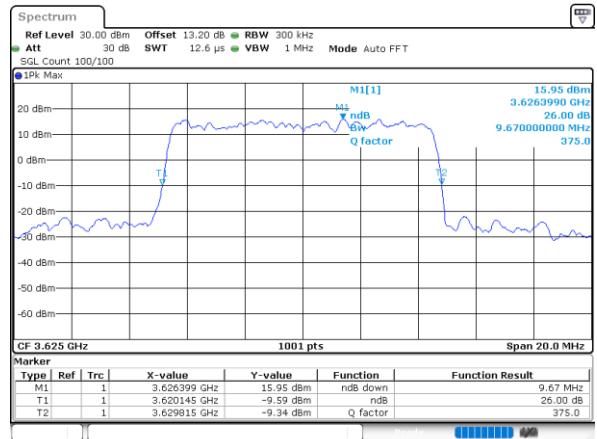

Date: 4.MAY.2022 19:24:51

Middle Channel / 15MHz / QPSK

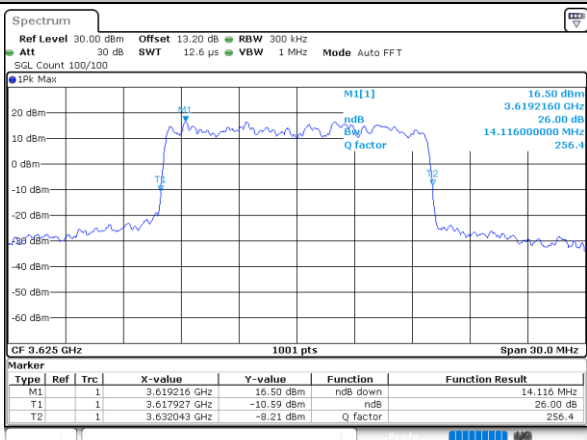

Date: 4.MAY.2022 19:26:24

Middle Channel / 15MHz / 16QAM

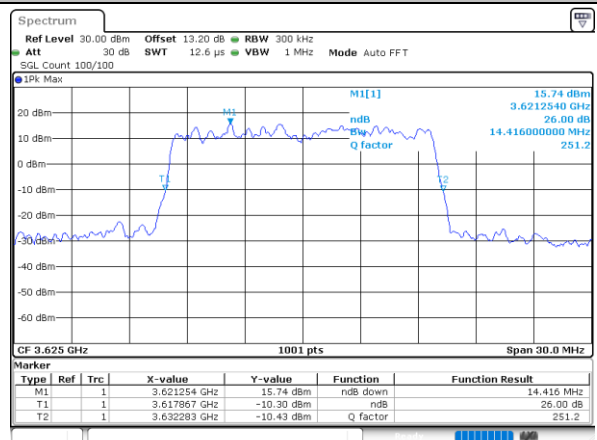

Date: 4.MAY.2022 19:26:52



LTE Band 48

Middle Channel / 20MHz / QPSK

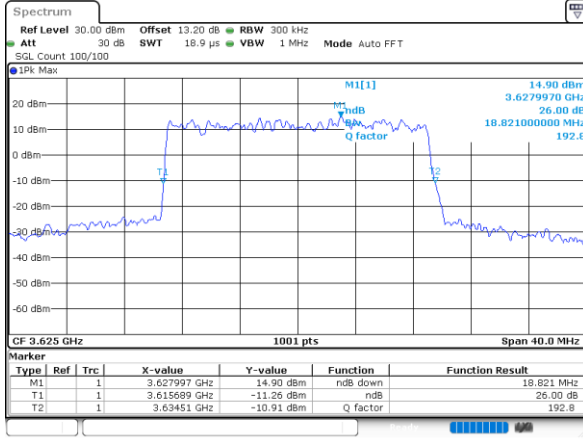

Date: 4.MAY.2022 19:28:24

Middle Channel / 20MHz / 16QAM

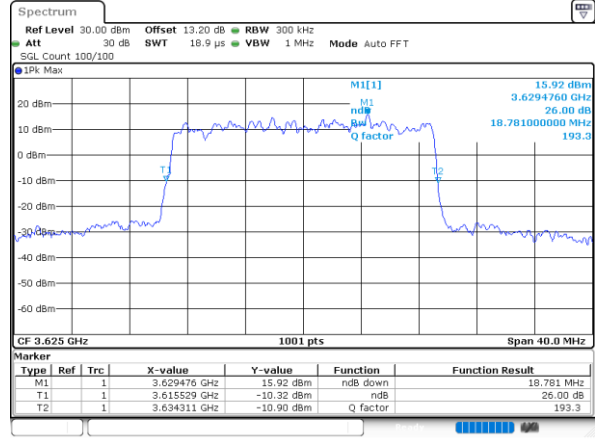

Date: 4.MAY.2022 19:28:53

Middle Channel / 5MHz / 64QAM

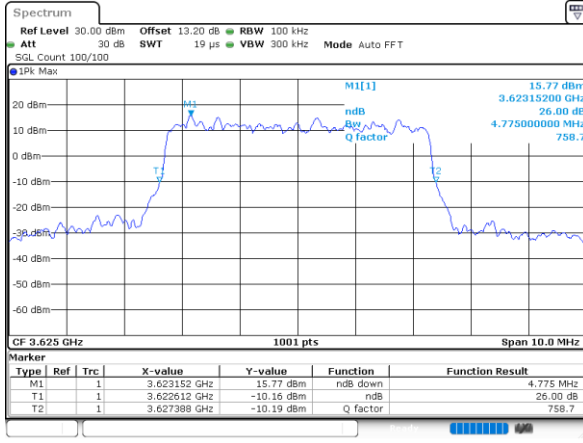

Date: 4.MAY.2022 19:29:42

Middle Channel / 10MHz / 64QAM

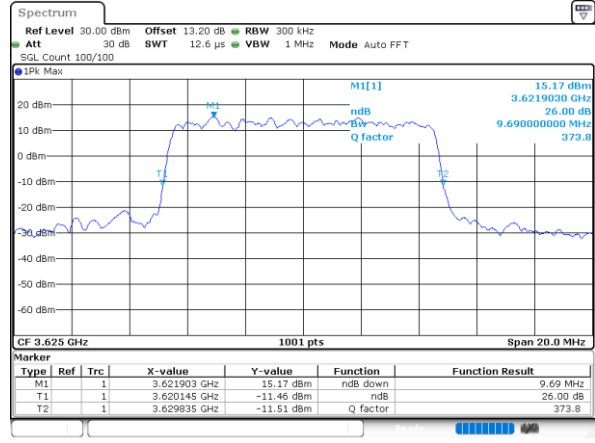

Date: 4.MAY.2022 19:30:30

Middle Channel / 15MHz / 64QAM

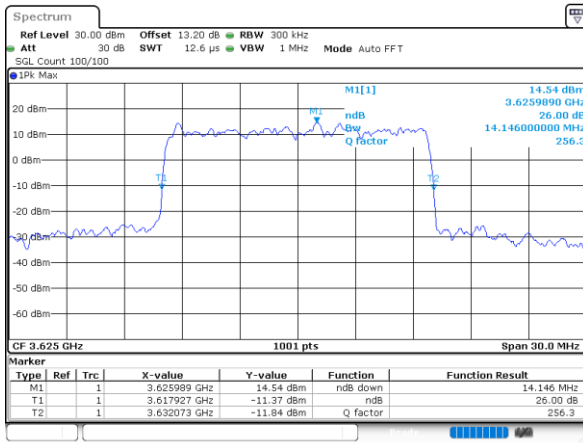

Date: 4.MAY.2022 19:31:19

Middle Channel / 20MHz / 64QAM

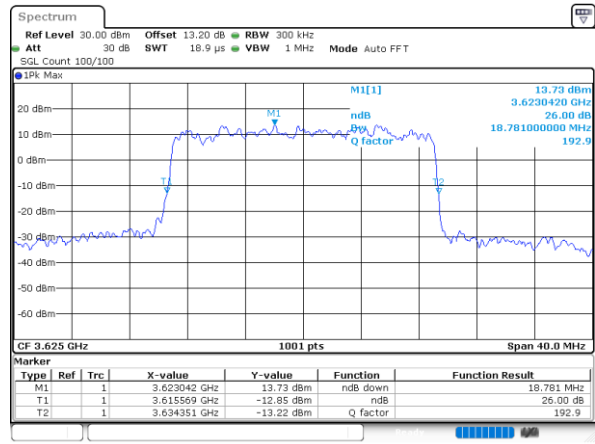

Date: 4.MAY.2022 19:32:07



Occupied Bandwidth

Mode	LTE Band 48 : 99%OBW(MHz)											
BW	1.4MHz		3MHz		5MHz		10MHz		15MHz		20MHz	
Mod.	QPSK	16QAM	QPSK	16QAM	QPSK	16QAM	QPSK	16QAM	QPSK	16QAM	QPSK	16QAM
Middle CH	-	-	-	-	4.51	4.49	9.03	8.99	13.43	13.43	17.98	17.74
Mode	LTE Band 48 : 99%OBW(MHz)											
BW	1.4MHz		3MHz		5MHz		10MHz		15MHz		20MHz	
Mod.	64QAM	256QAM	64QAM	256QAM	64QAM	256QAM	64QAM	256QAM	64QAM	256QAM	64QAM	256QAM
Middle CH	-	-	-	-	4.50	-	9.09	-	13.49	-	17.82	-



LTE Band 48

Middle Channel / 5MHz / QPSK

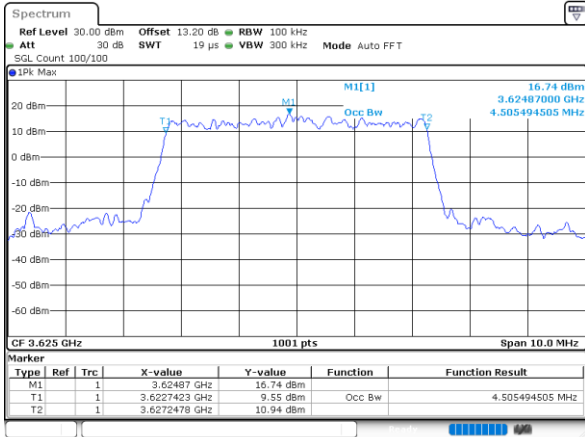

Date: 4.MAY.2022 19:21:24

Middle Channel / 5MHz / 16QAM

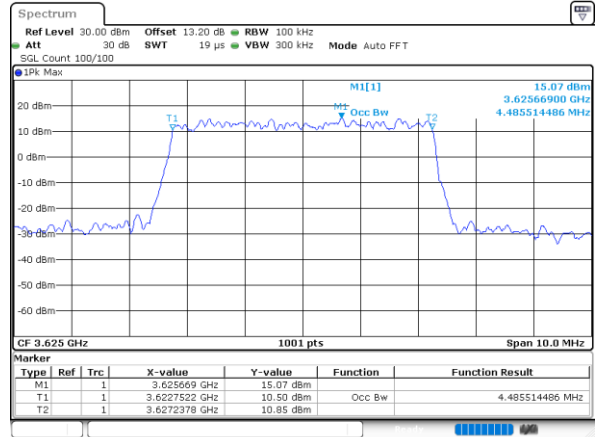

Date: 4.MAY.2022 19:21:53

Middle Channel / 10MHz / QPSK

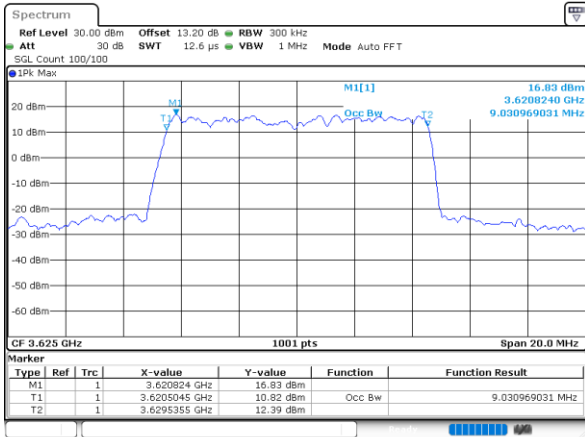

Date: 4.MAY.2022 19:22:15

Middle Channel / 10MHz / 16QAM

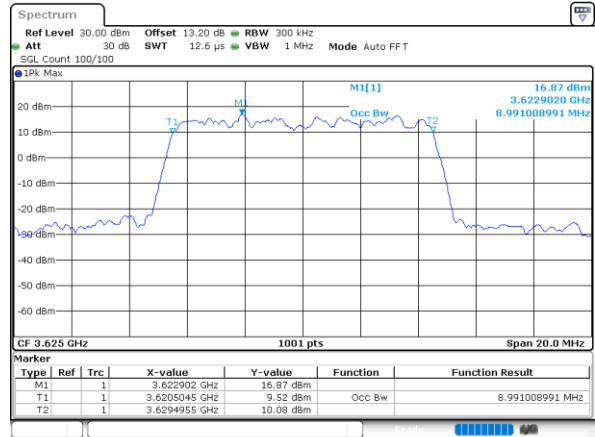

Date: 4.MAY.2022 19:22:14

Middle Channel / 15MHz / QPSK

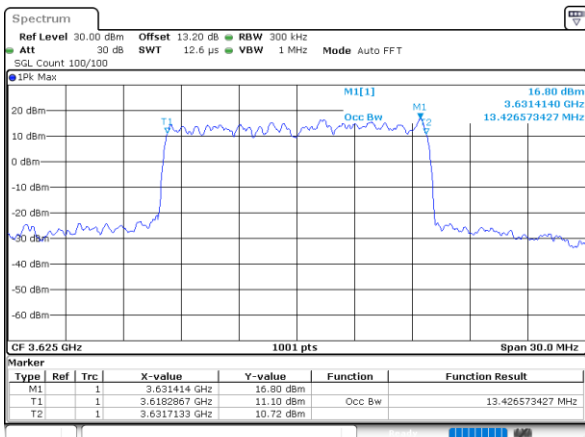

Date: 4.MAY.2022 19:25:16

Middle Channel / 15MHz / 16QAM

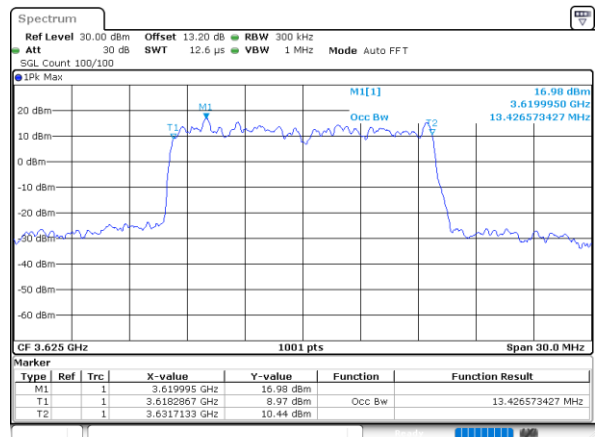

Date: 4.MAY.2022 19:25:55



LTE Band 48

Middle Channel / 20MHz / QPSK

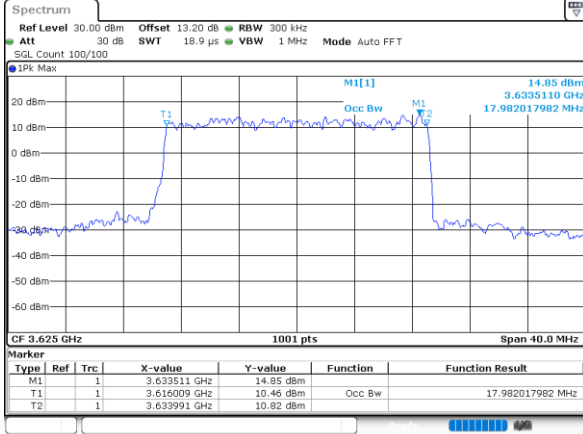

Date: 4.MAY.2022 19:27:27

Middle Channel / 20MHz / 16QAM

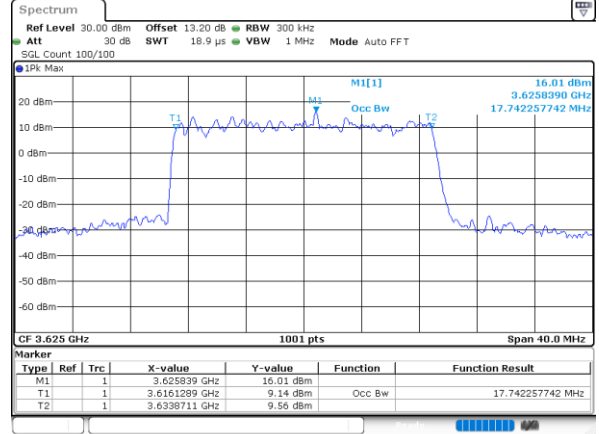

Date: 4.MAY.2022 19:27:56

Middle Channel / 5MHz / 64QAM

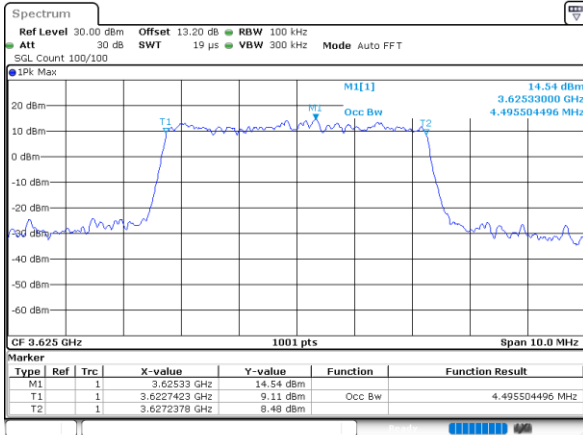

Date: 4.MAY.2022 19:29:28

Middle Channel / 10MHz / 64QAM

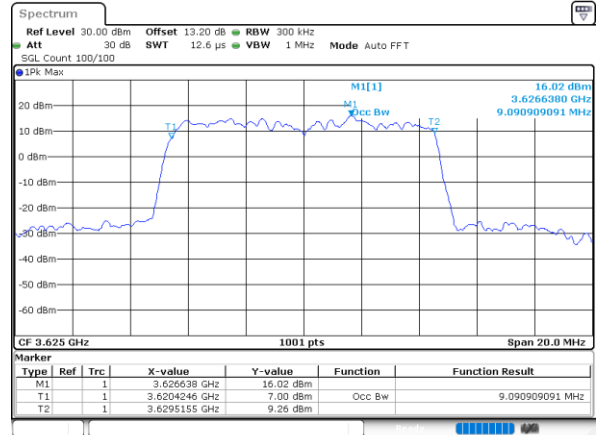

Date: 4.MAY.2022 19:30:16

Middle Channel / 15MHz / 64QAM

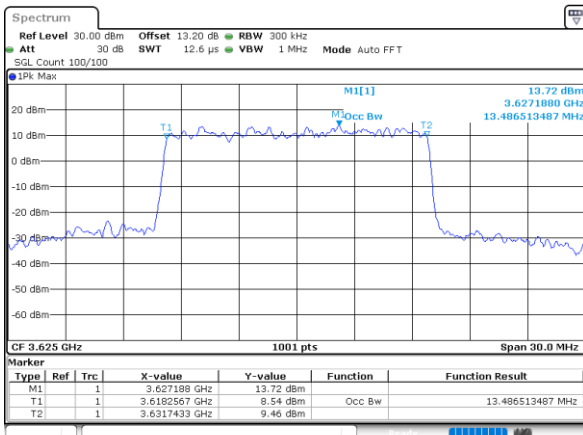

Date: 4.MAY.2022 19:31:05

Middle Channel / 20MHz / 64QAM

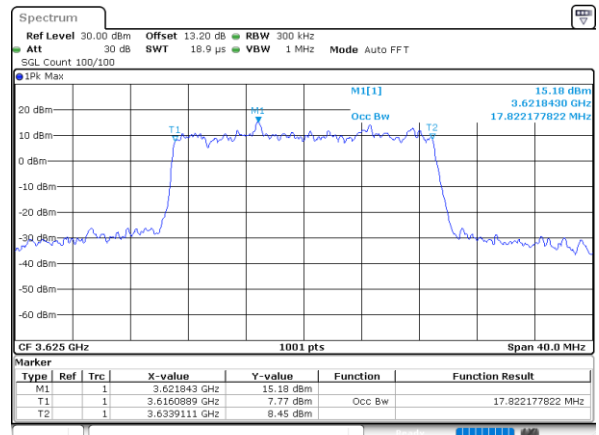

Date: 4.MAY.2022 19:31:53



**ACLR**

**LTE Band 48 / 5MHz**

**QPSK**

**Lowest Channel / 1RB0**

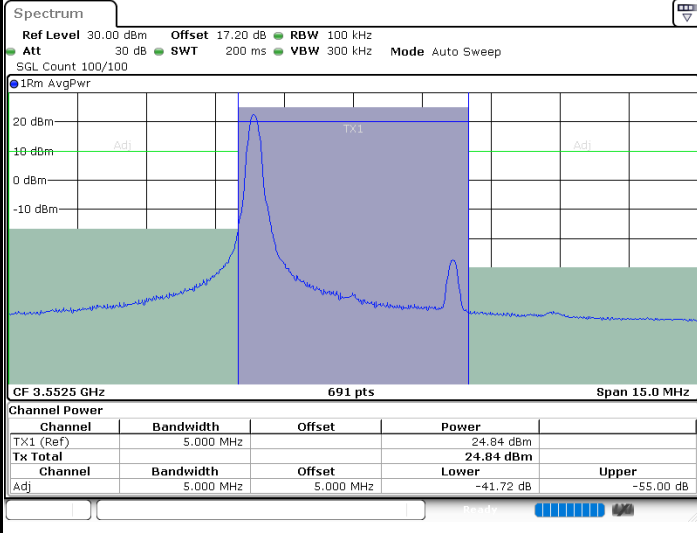

Date: 4.MAY.2022 21:31:42

**Lowest Channel / 1RBmax**

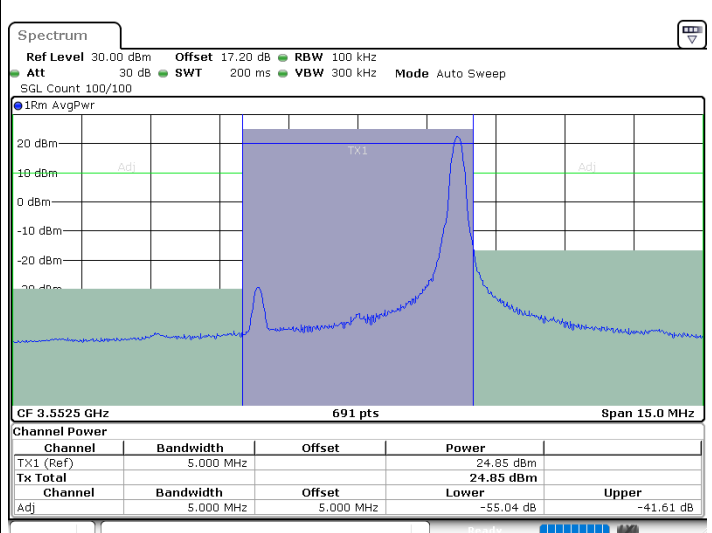

Date: 4.MAY.2022 21:45:54

**Lowest Channel / FullIRB**

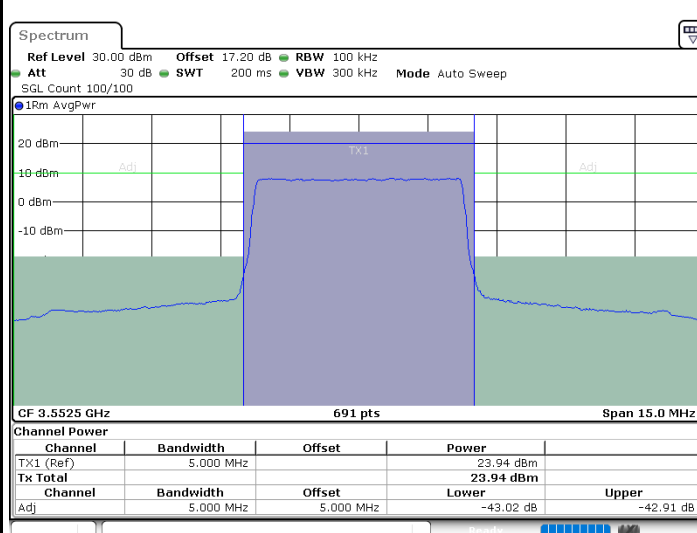

Date: 4.MAY.2022 21:38:48

**N/A**



LTE Band 48 / 5MHz

QPSK

Middle Channel / 1RB0

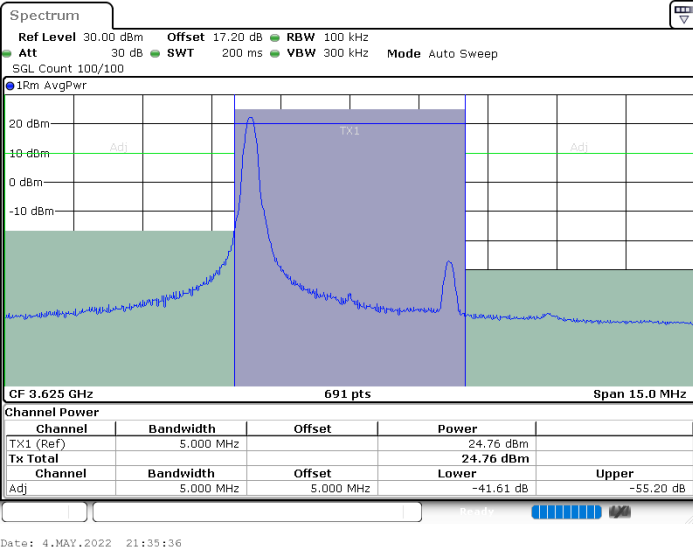

Middle Channel / 1RBmax

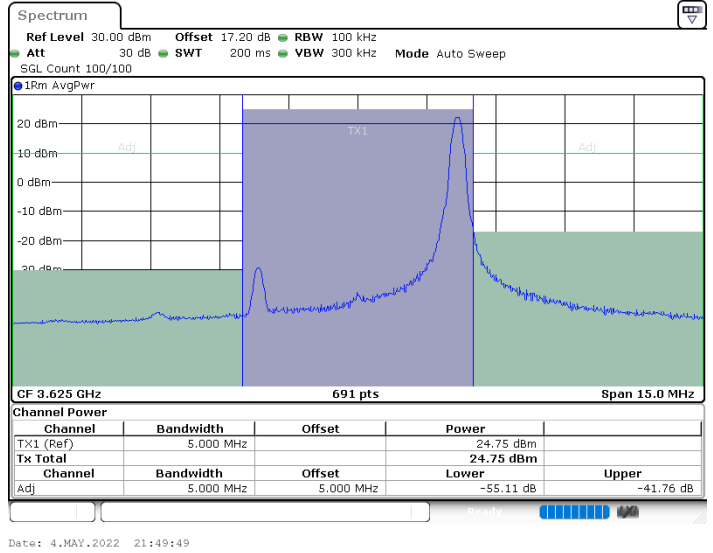

Middle Channel / FullRB

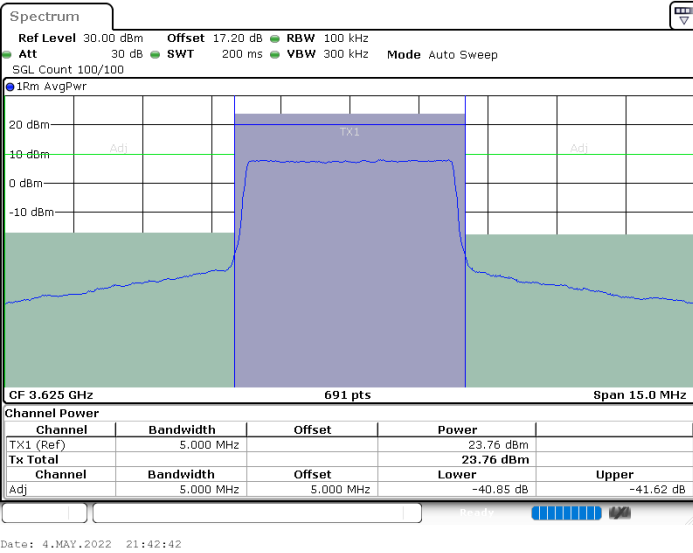

N/A





LTE Band 48 / 5MHz

QPSK

Highest Channel / 1RB0

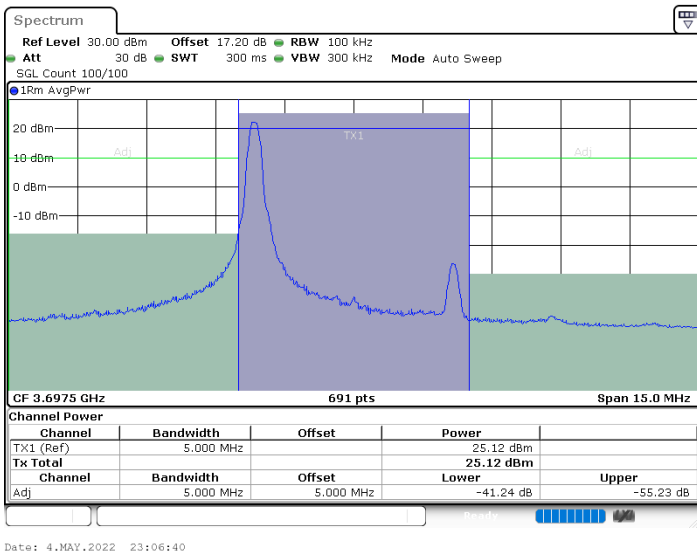

Highest Channel / 1RBmax

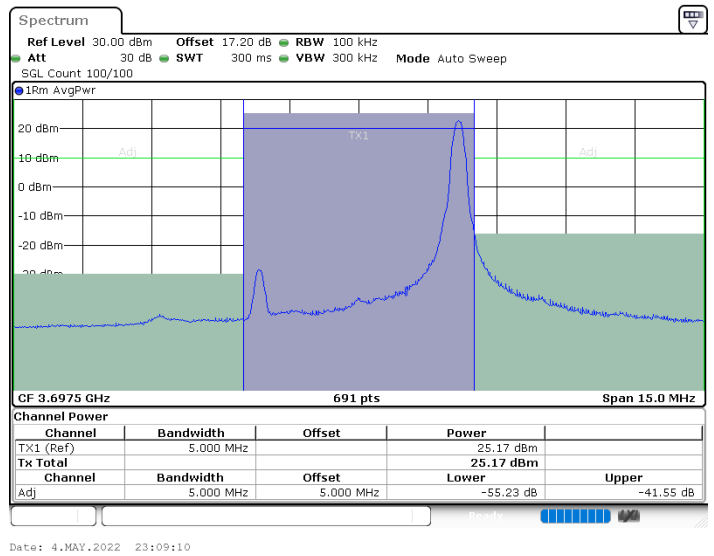

Highest Channel / FullRB

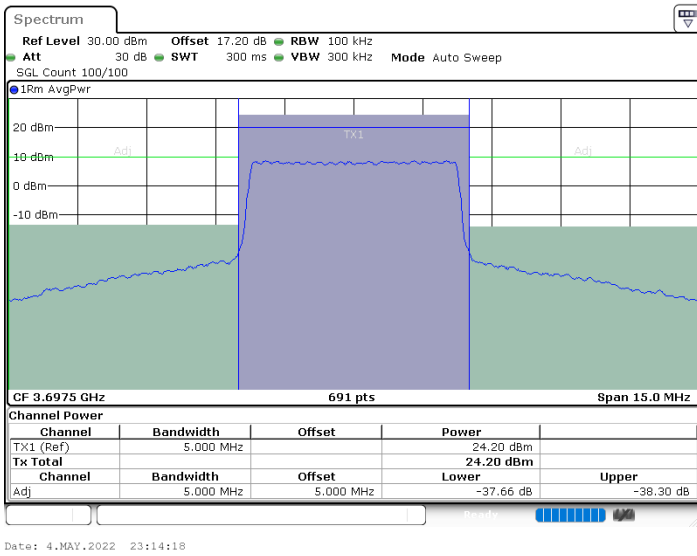

N/A



LTE Band 48 / 10MHz

QPSK

Lowest Channel / 1RB0

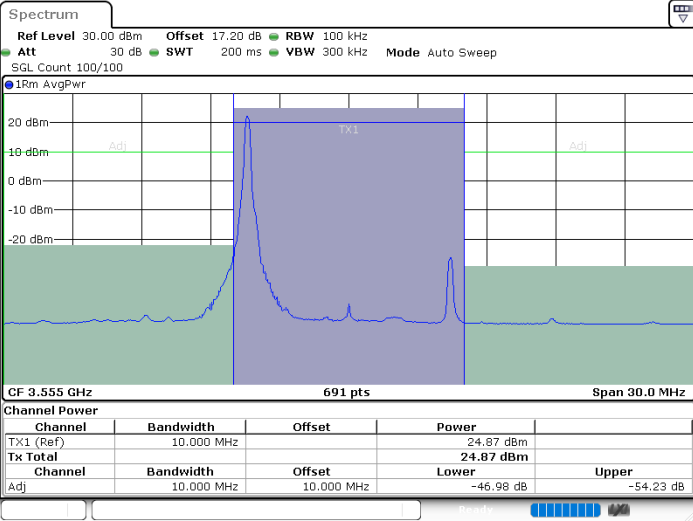

Date: 4.MAY.2022 21:54:42

Lowest Channel / 1RBmax

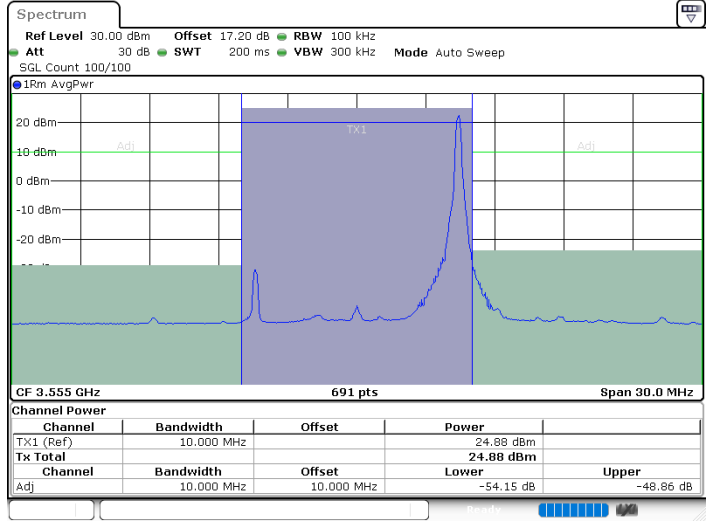

Date: 4.MAY.2022 22:09:01

Lowest Channel / FullRB

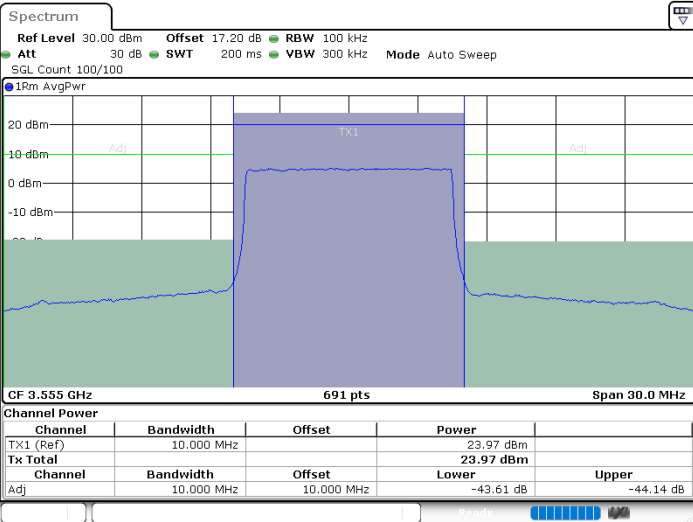

Date: 4.MAY.2022 22:01:51

N/A



LTE Band 48 / 10MHz

QPSK

MiddleChannel / 1RB0

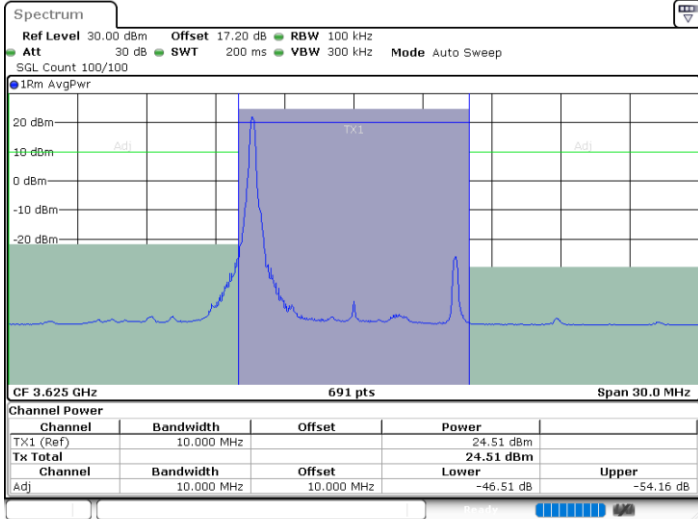

Middle Channel / 1RBmax

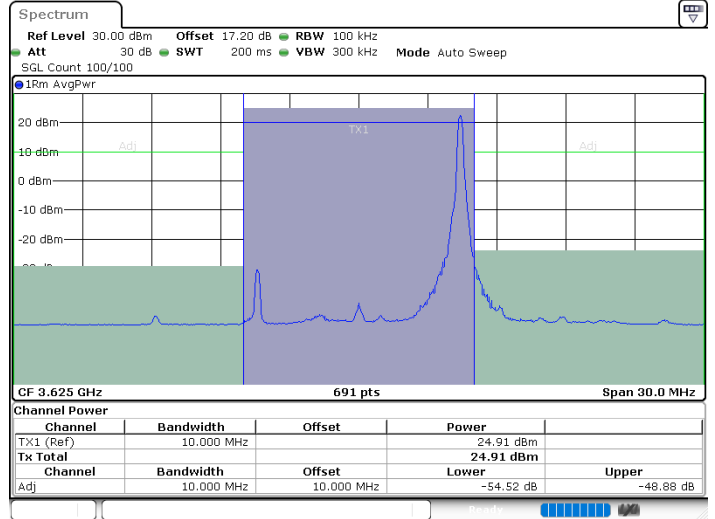

Middle Channel / FullRB

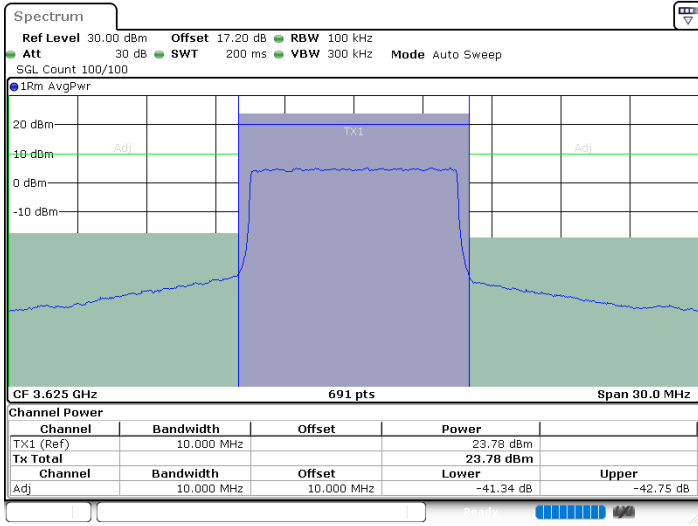

N/A



LTE Band 48 / 10MHz

QPSK

Highest Channel / 1RB0

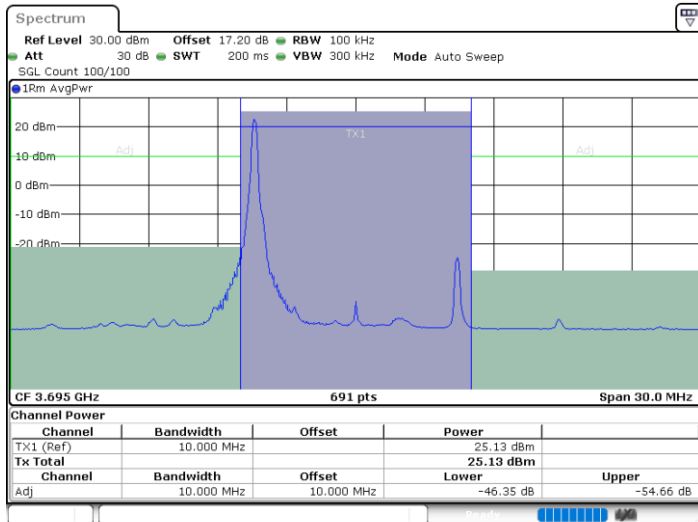

Date: 4.MAY.2022 21:59:28

Highest Channel / 1RBmax

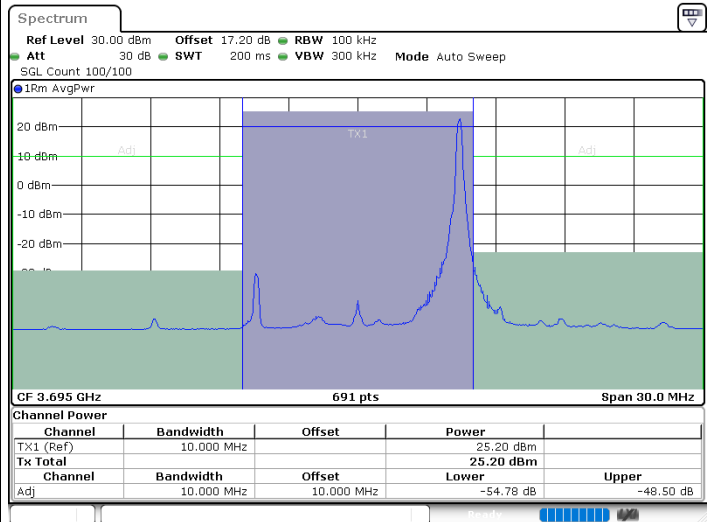

Date: 4.MAY.2022 22:13:48

Highest Channel / FullRB

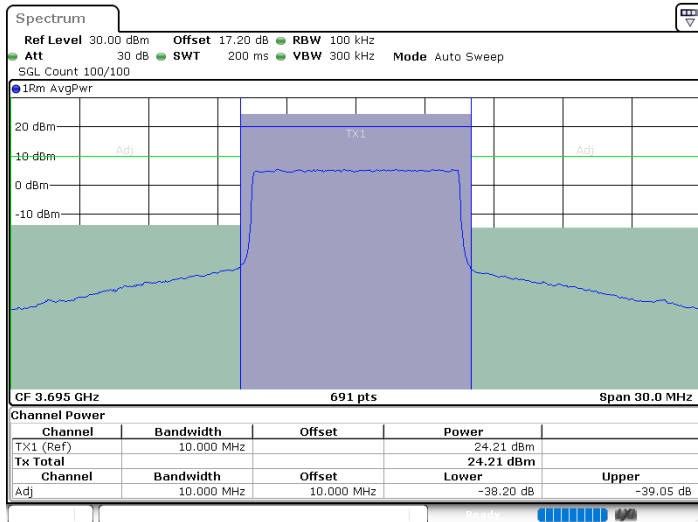

Date: 4.MAY.2022 22:06:38

N/A



LTE Band 48 / 15MHz

QPSK

Lowest Channel / 1RB0

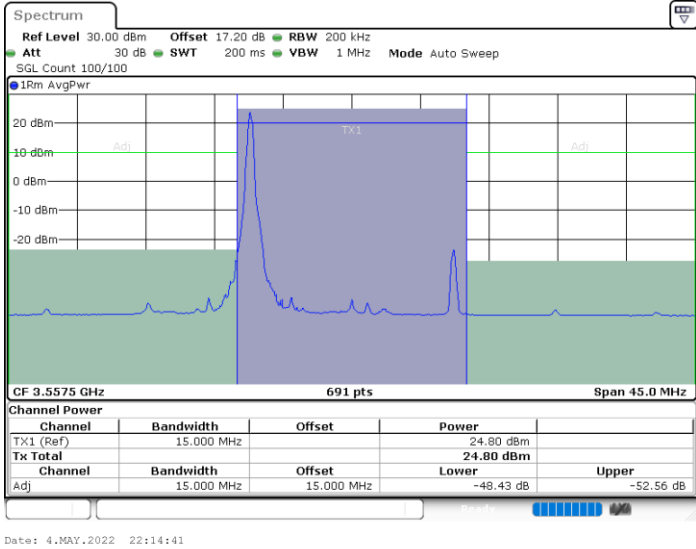

Lowest Channel / 1RBmax

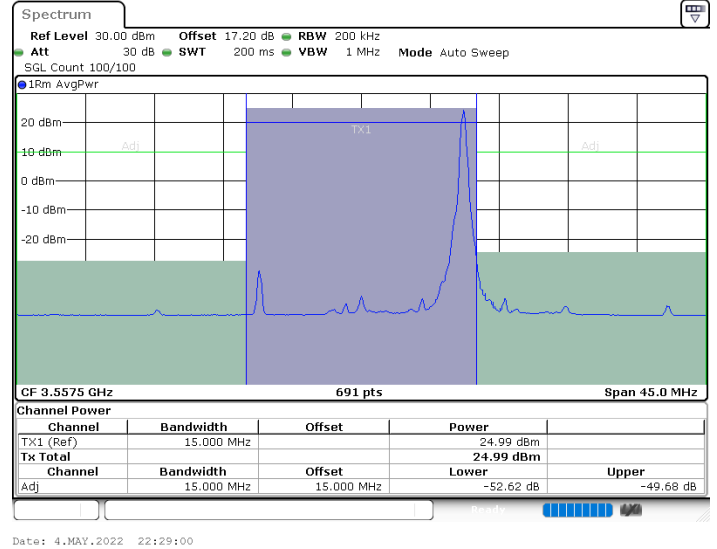

Lowest Channel / FullRB

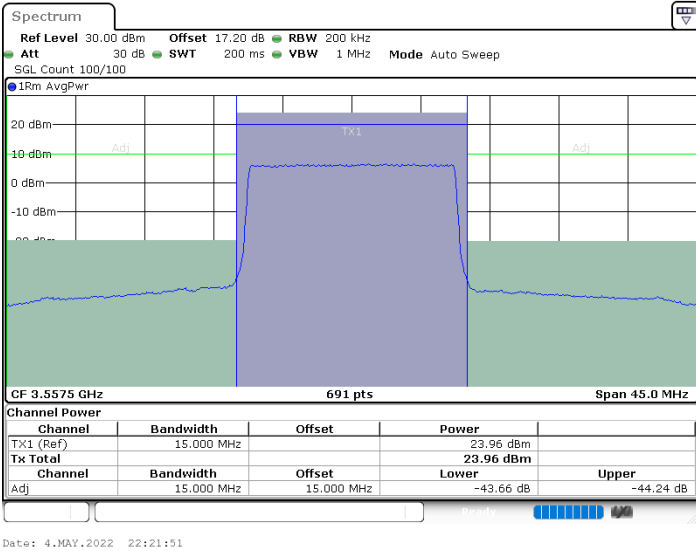

N/A



LTE Band 48 / 15MHz

QPSK

Middle Channel / 1RB0

Middle Channel / 1RBmax

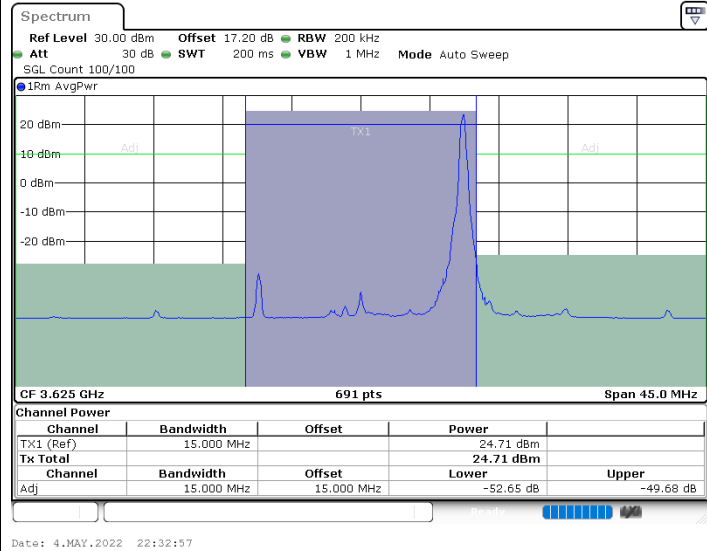
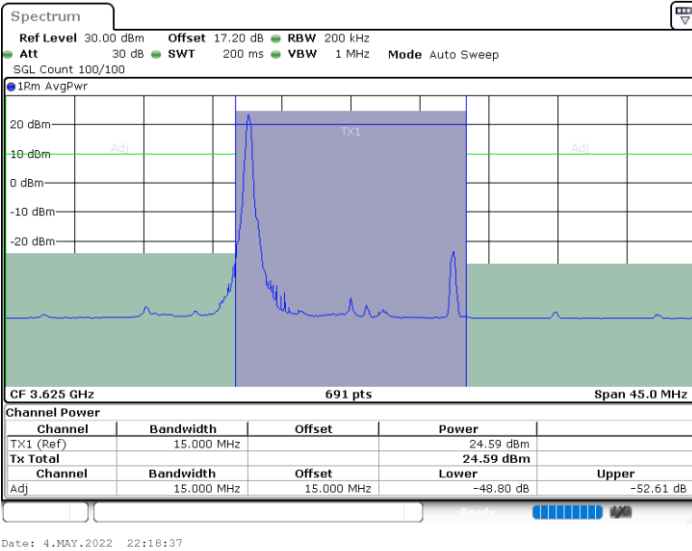

Middle Channel / FullIRB

N/A

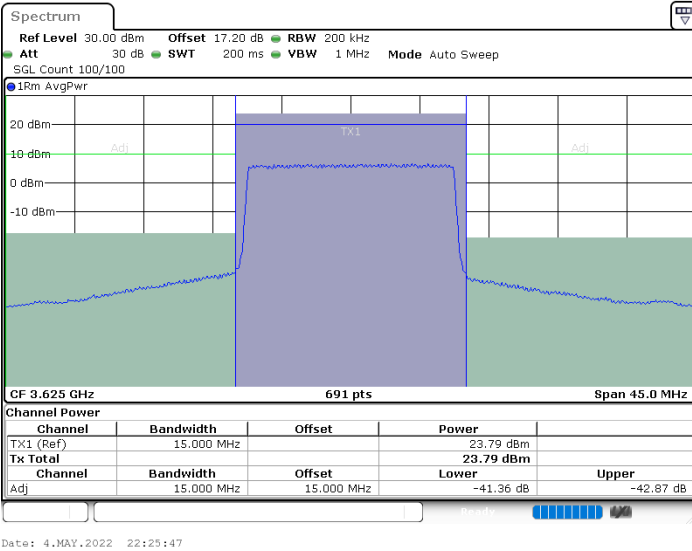



LTE Band 48 / 15MHz

QPSK

Highest Channel / 1RB0

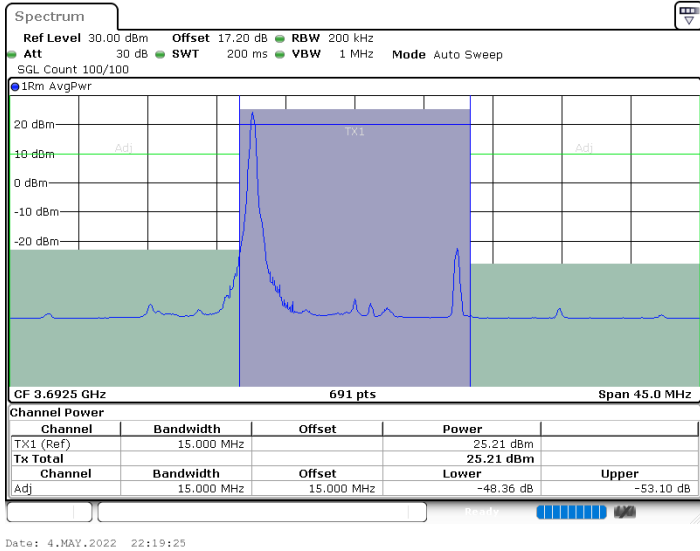

Highest Channel / 1RBmax

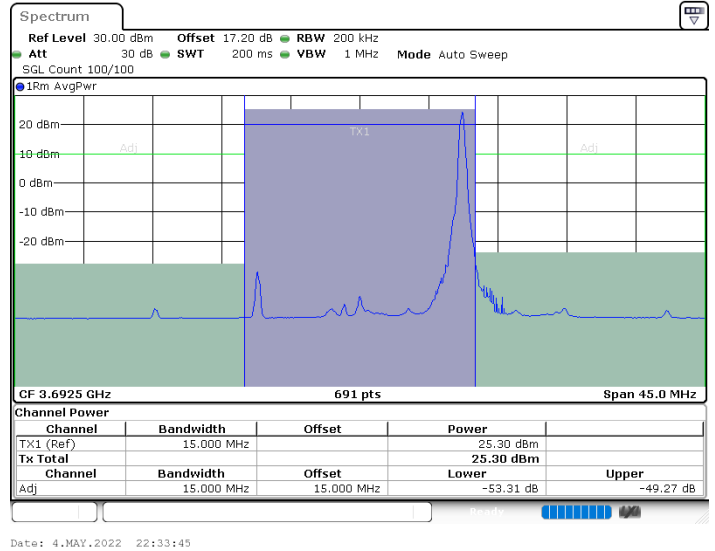

Highest Channel / FullRB

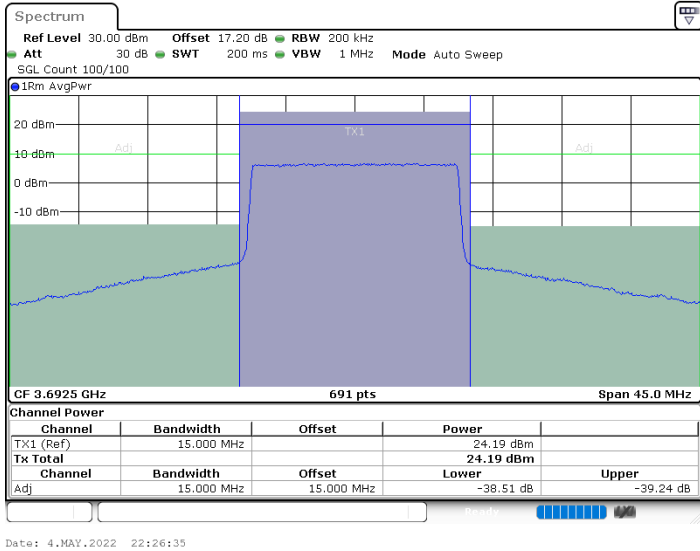

N/A



LTE Band 48 / 20MHz

QPSK

Lowest Channel / 1RB0

Lowest Channel / 1RBmax

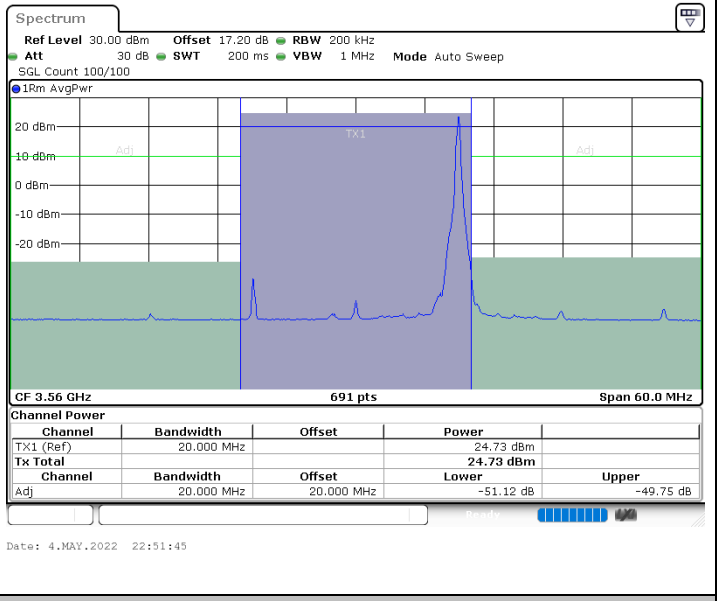
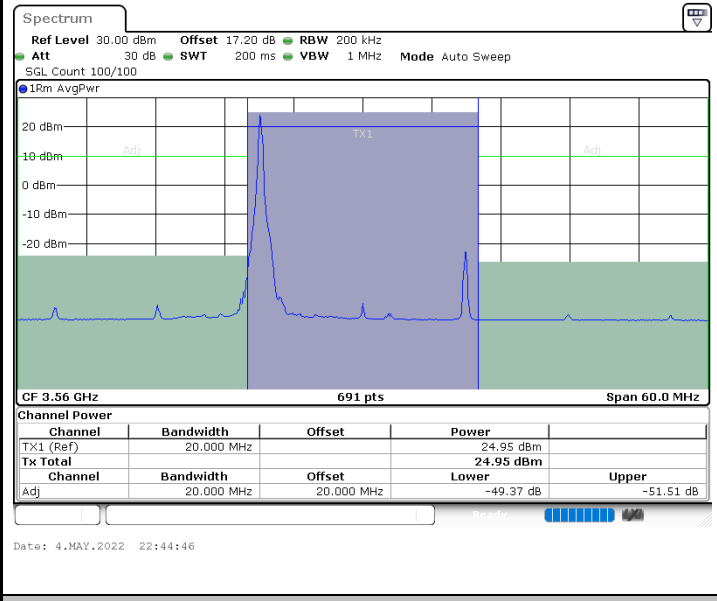

Lowest Channel / FullRB

N/A

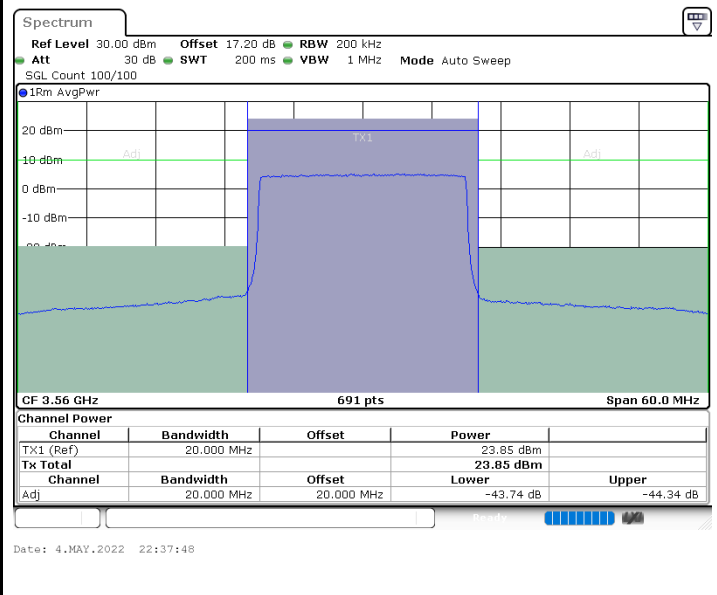





LTE Band 48 / 20MHz

QPSK

Middle Channel / 1RB0

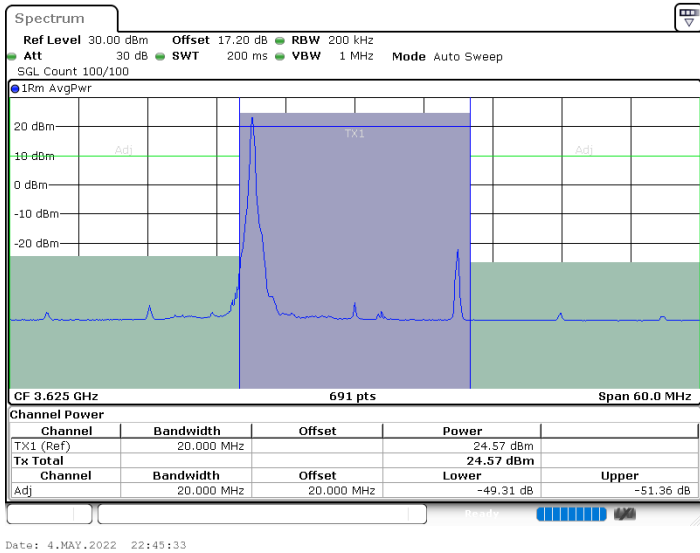

Middle Channel / 1RBmax

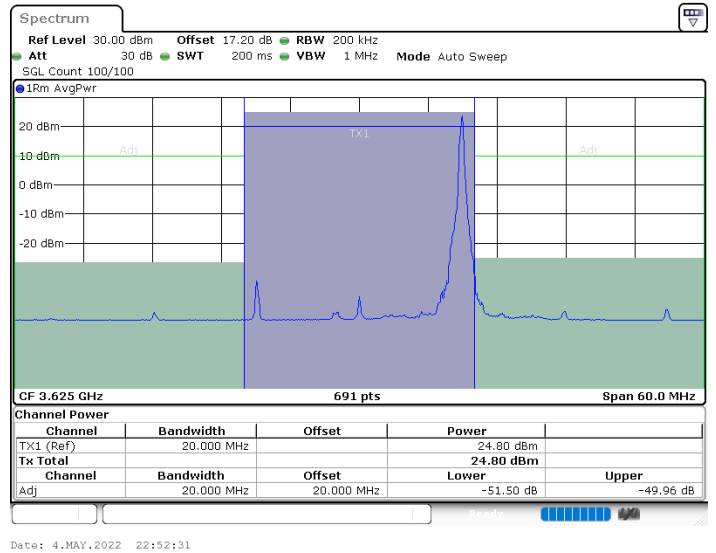

Middle Channel / FullIRB

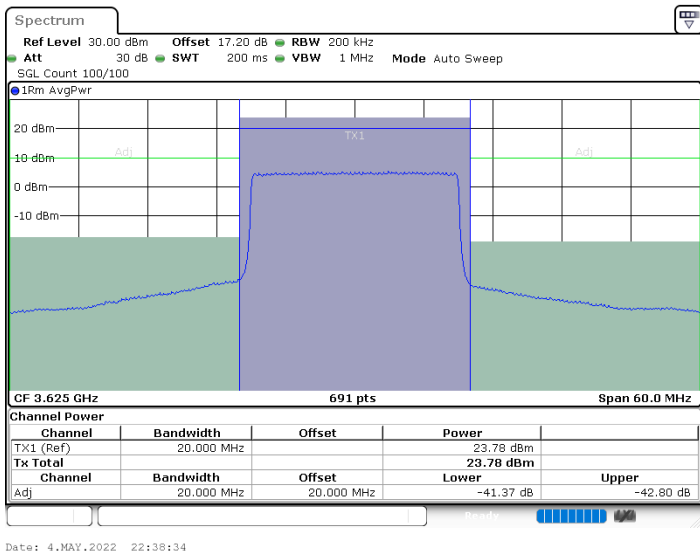

N/A



LTE Band 48 / 20MHz

QPSK

Highest Channel / 1RB0

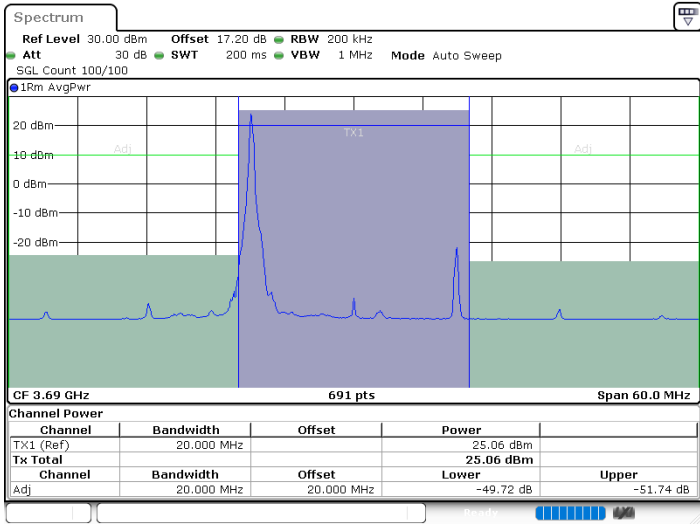

Highest Channel / 1RBmax

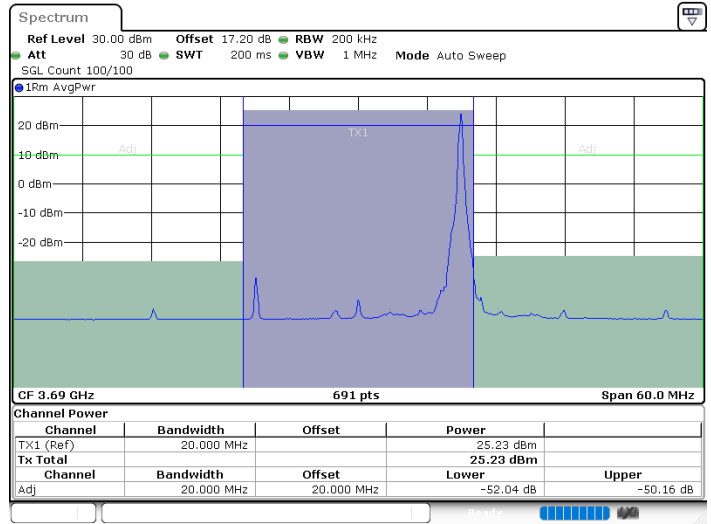

Highest Channel / FullRB

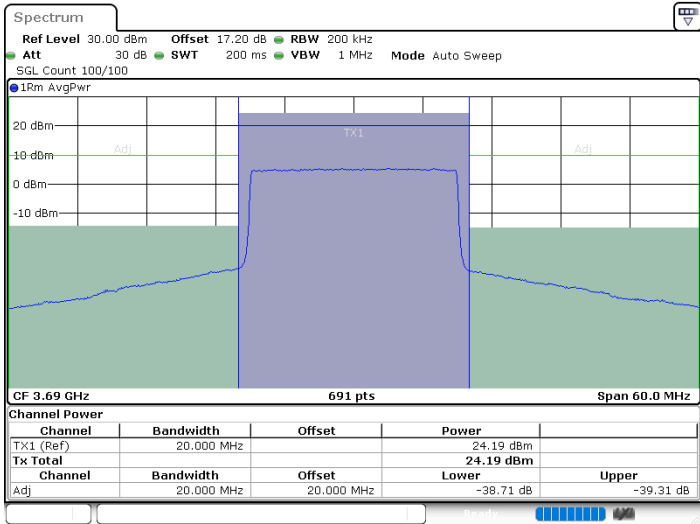

N/A



LTE Band 48 / 5MHz

16QAM

Lowest Channel / 1RB0

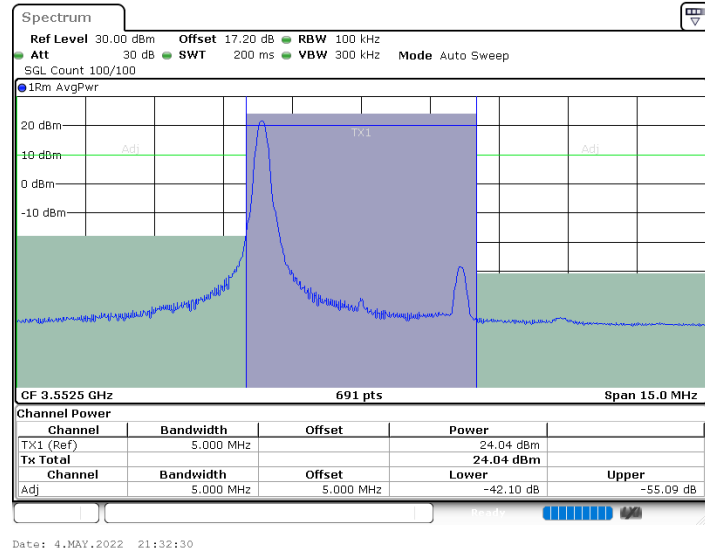

Lowest Channel / 1RBmax

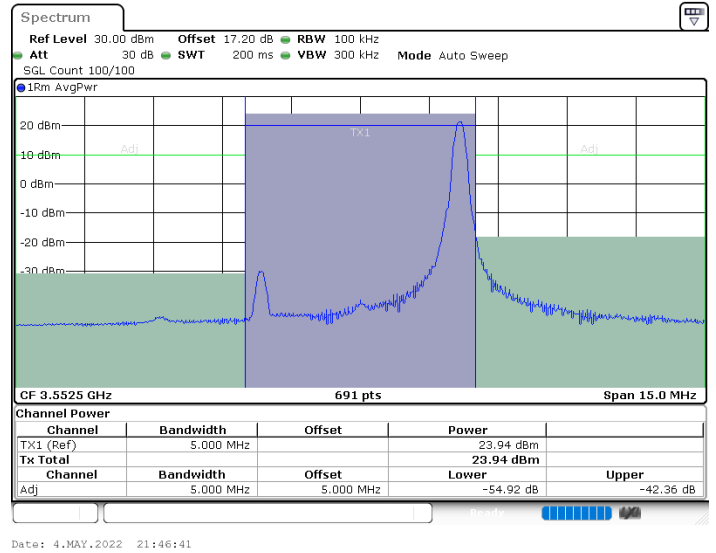

Lowest Channel / FullRB

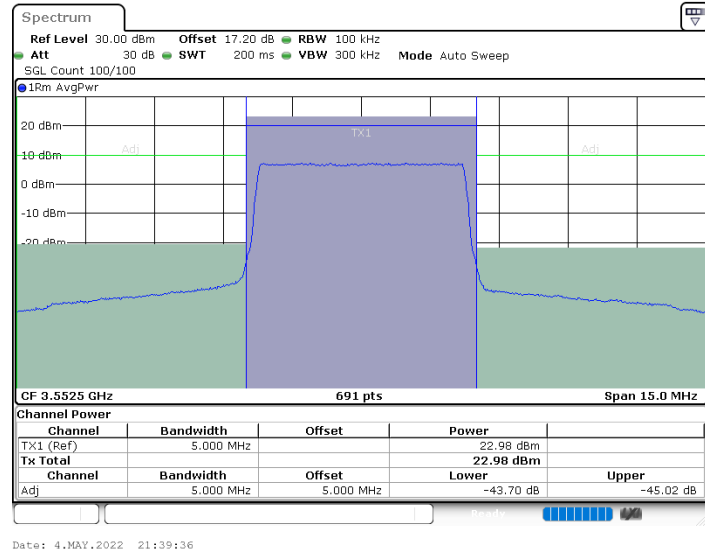

N/A



LTE Band 48 / 5MHz

16QAM

Middle Channel / 1RB0

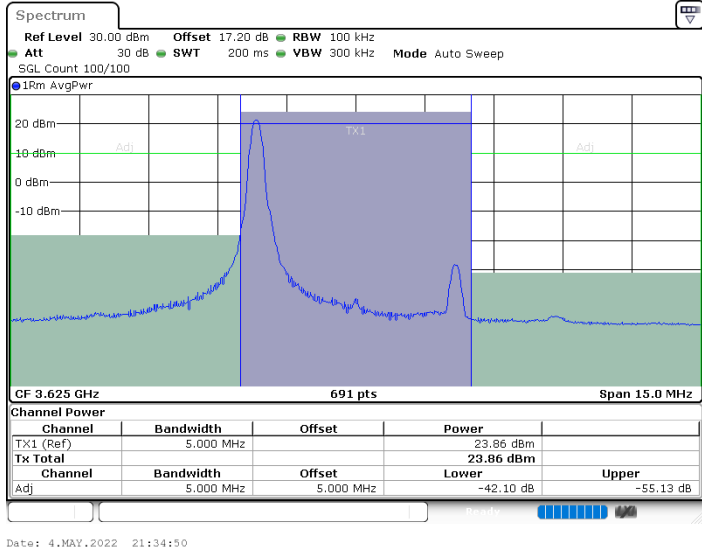

Middle Channel / 1RBmax

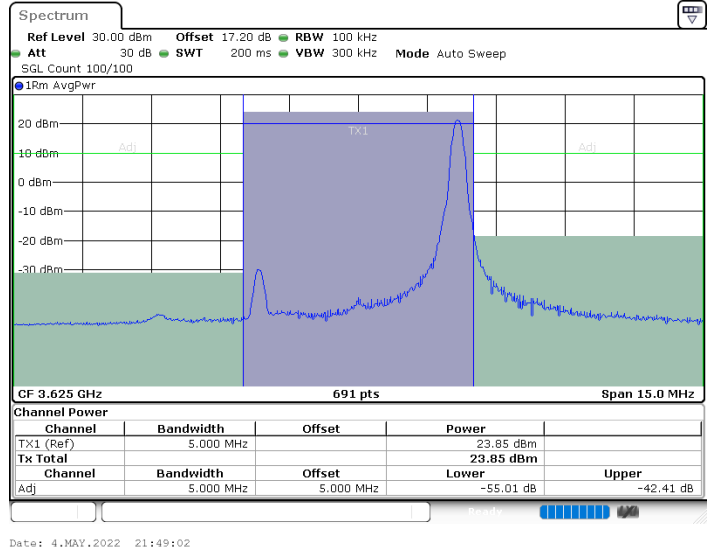

Middle Channel / FullRB

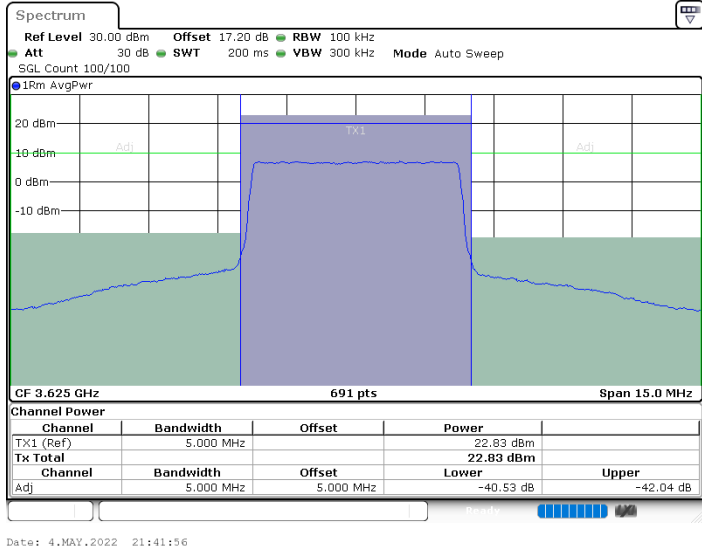

N/A



LTE Band 48 / 5MHz

16QAM

Highest Channel / 1RB0

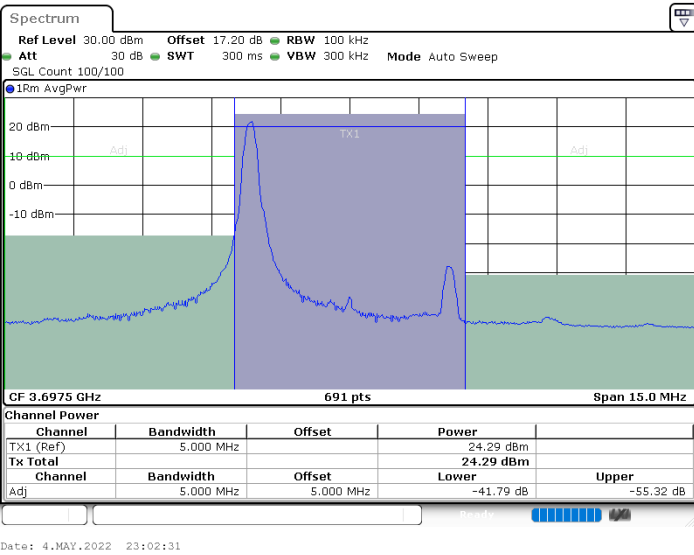

Highest Channel / 1RBmax

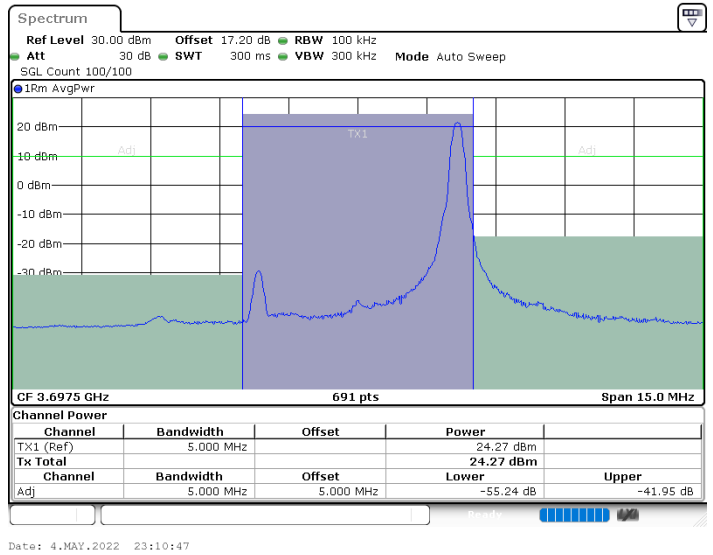

Highest Channel / FullRB

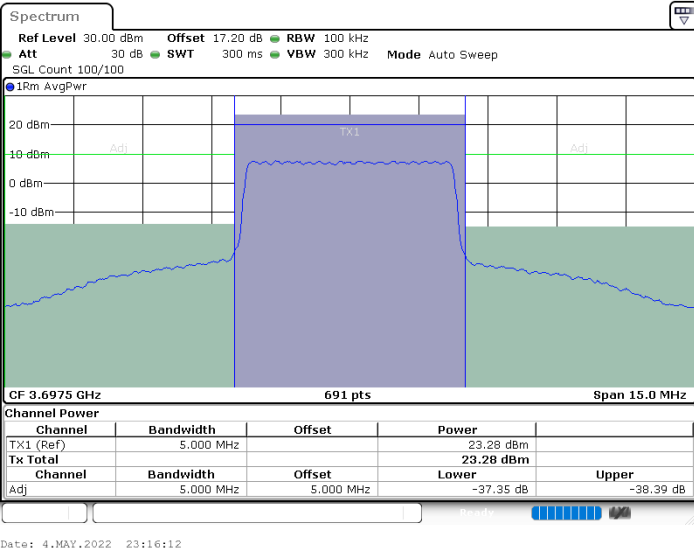

N/A



LTE Band 48 / 10MHz

16QAM

Lowest Channel / 1RB0

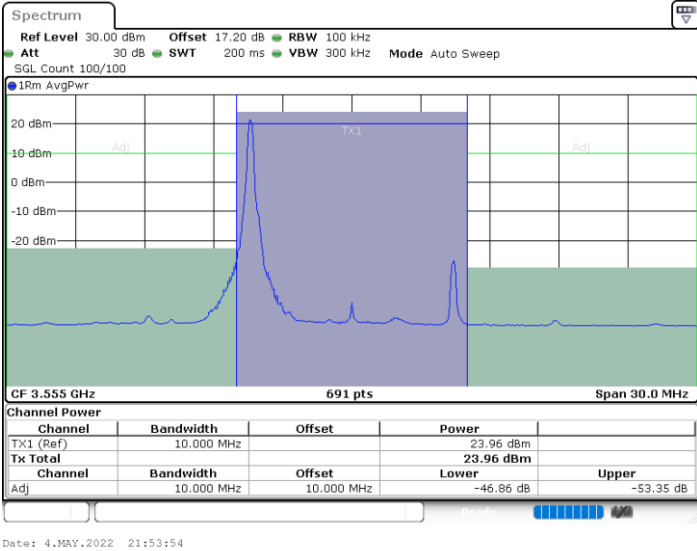

Lowest Channel / 1RBmax

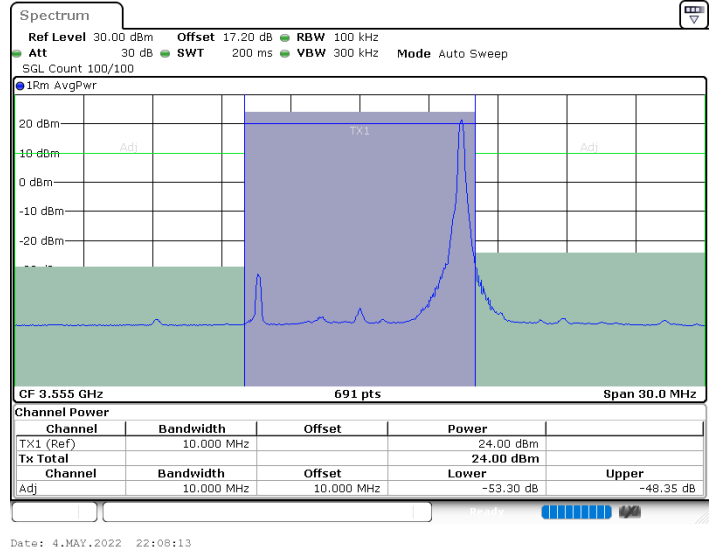

Lowest Channel / FullRB

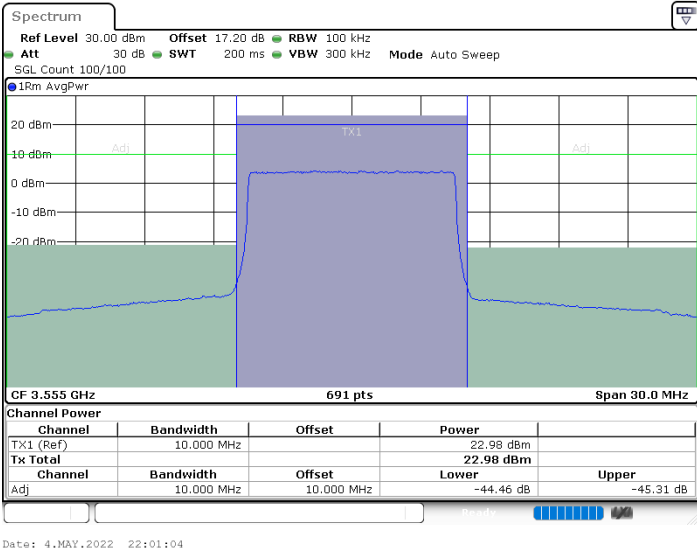

N/A



LTE Band 48 / 10MHz

16QAM

MiddleChannel / 1RB0

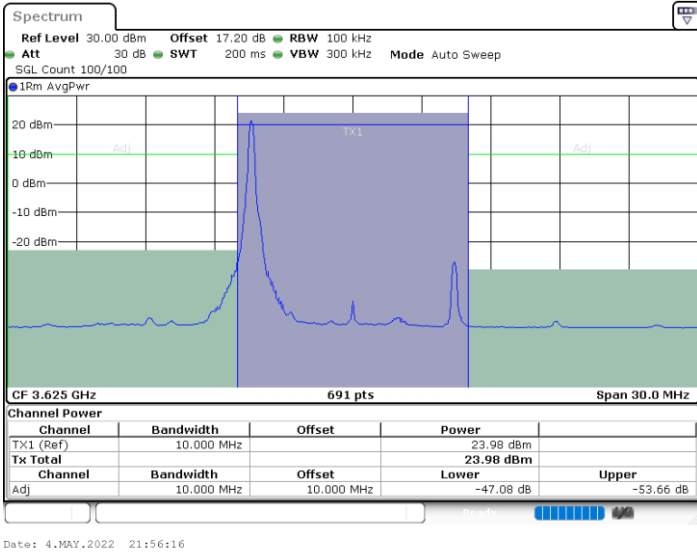

Middle Channel / 1RBmax

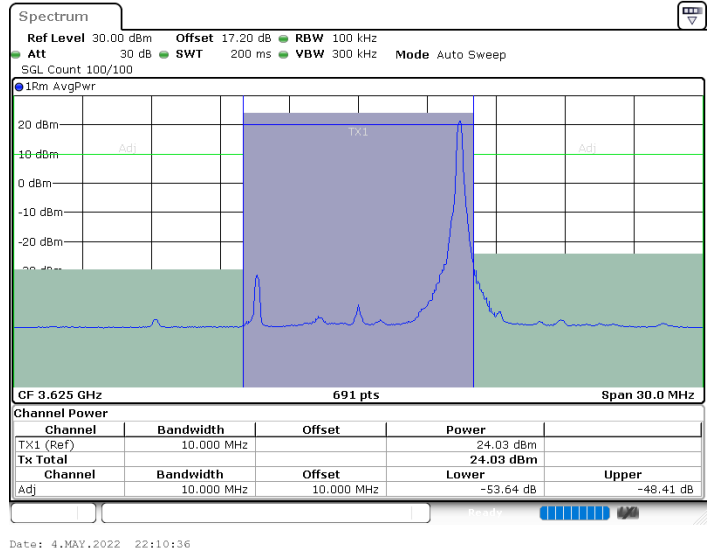

Middle Channel / FullRB

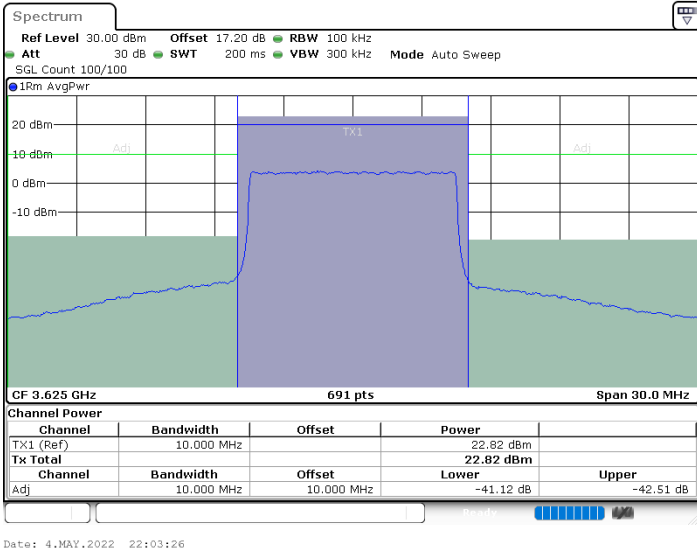

N/A



LTE Band 48 / 10MHz

16QAM

Highest Channel / 1RB0

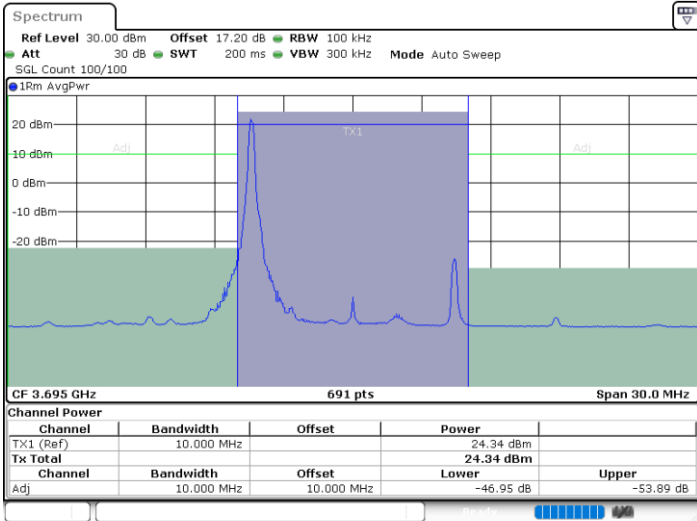

Highest Channel / 1RBmax

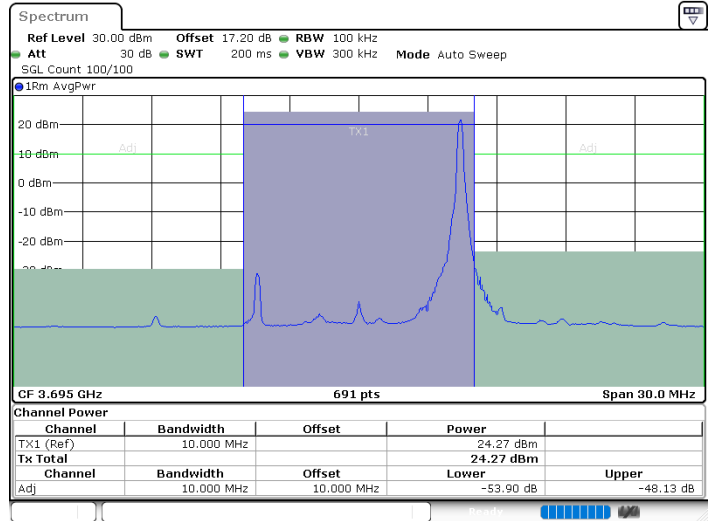

Highest Channel / FullRB

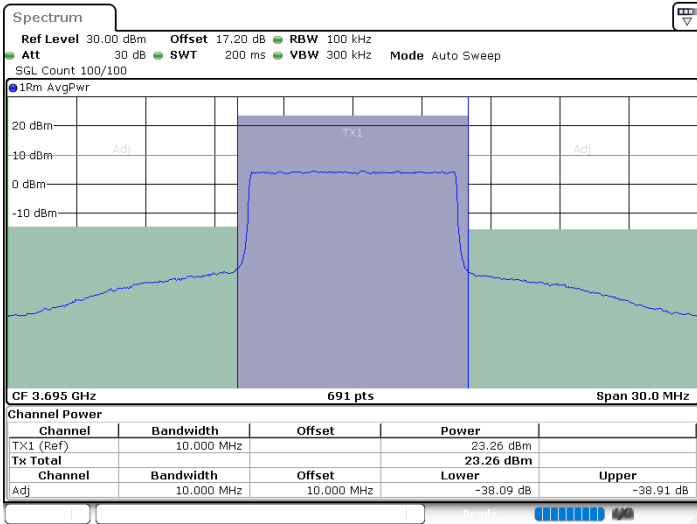

N/A





LTE Band 48 / 15MHz

16QAM

Lowest Channel / 1RB0

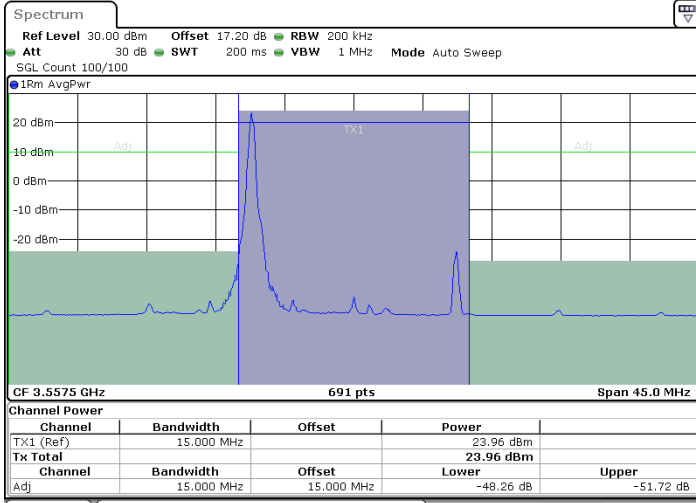

Date: 4.MAY.2022 22:15:29

Lowest Channel / 1RBmax

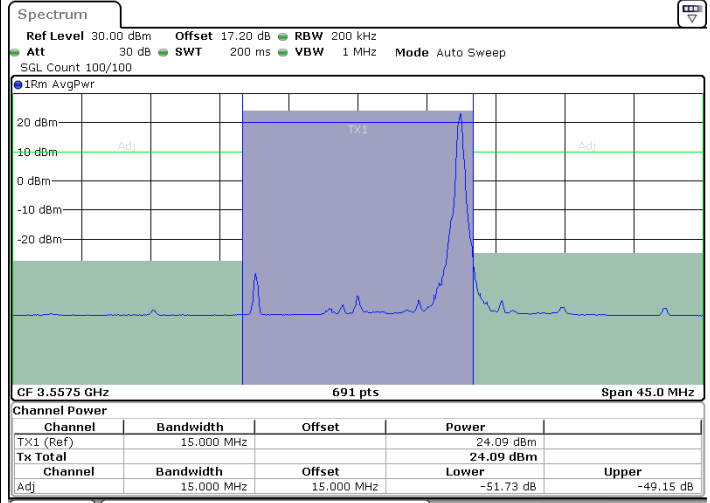

Date: 4.MAY.2022 22:29:48

Lowest Channel / FullRB

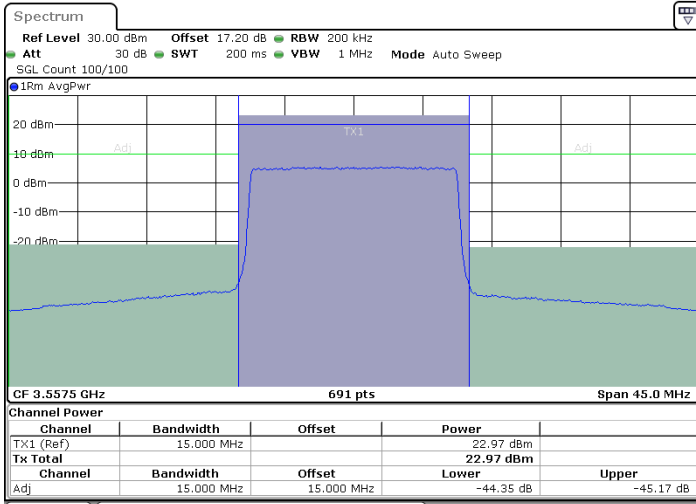

Date: 4.MAY.2022 22:22:38

N/A



LTE Band 48 / 15MHz

16QAM

Middle Channel / 1RB0

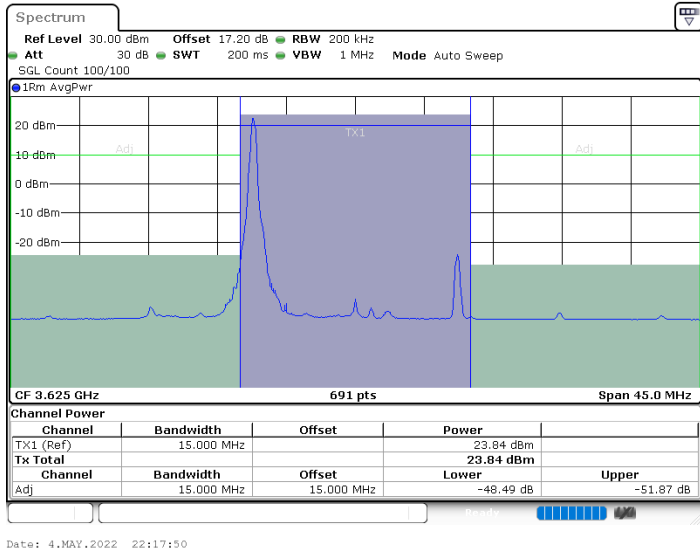

Middle Channel / 1RBmax

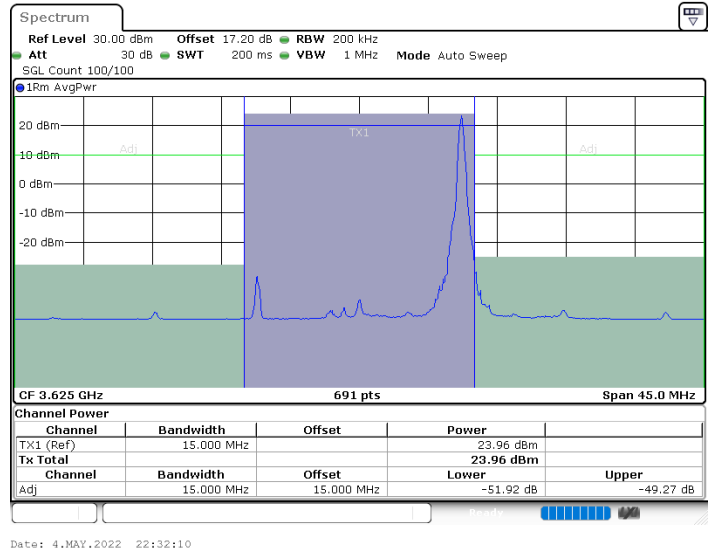

Middle Channel / FullRB

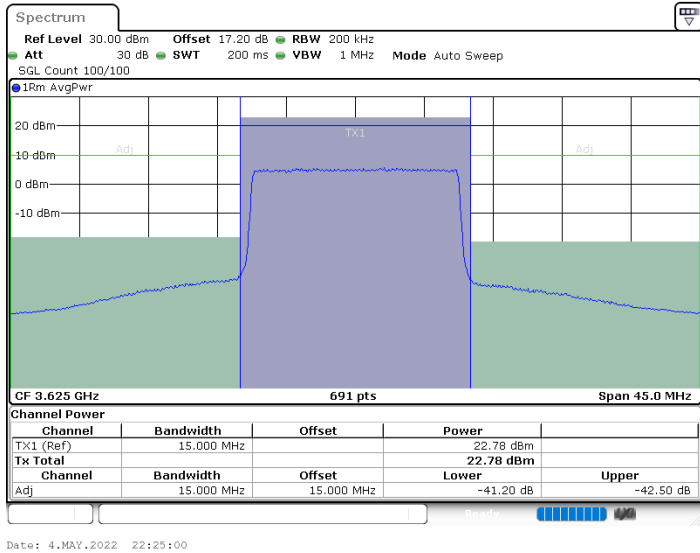

N/A



LTE Band 48 / 15MHz

16QAM

Highest Channel / 1RB0

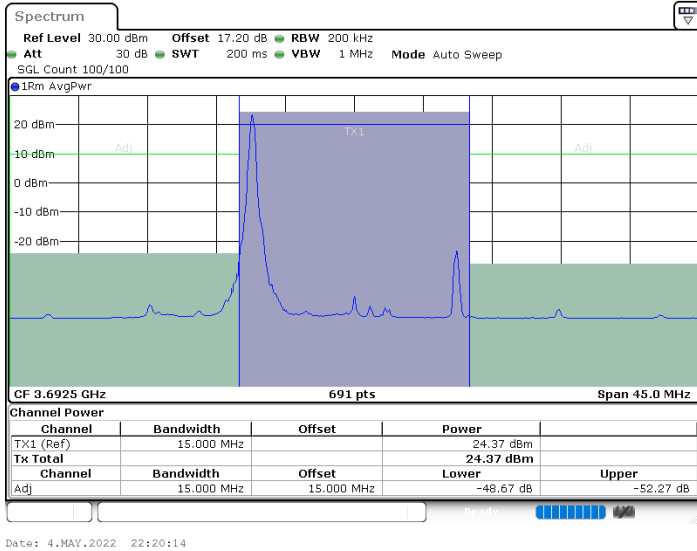

Highest Channel / 1RBmax

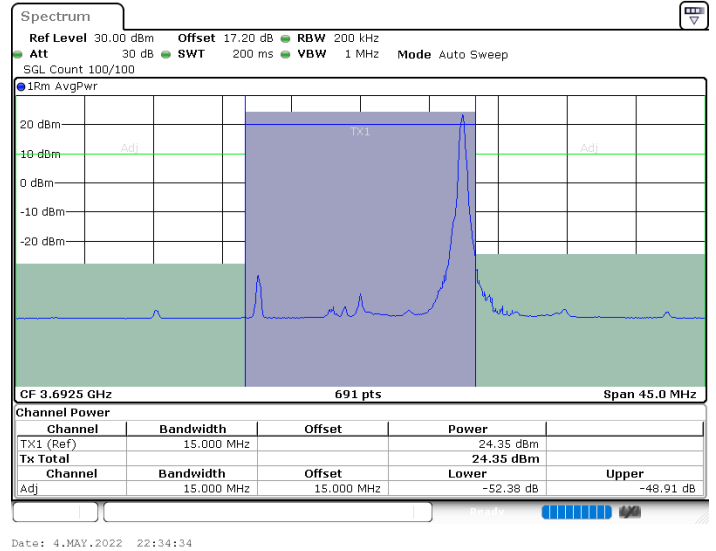

Highest Channel / FullRB

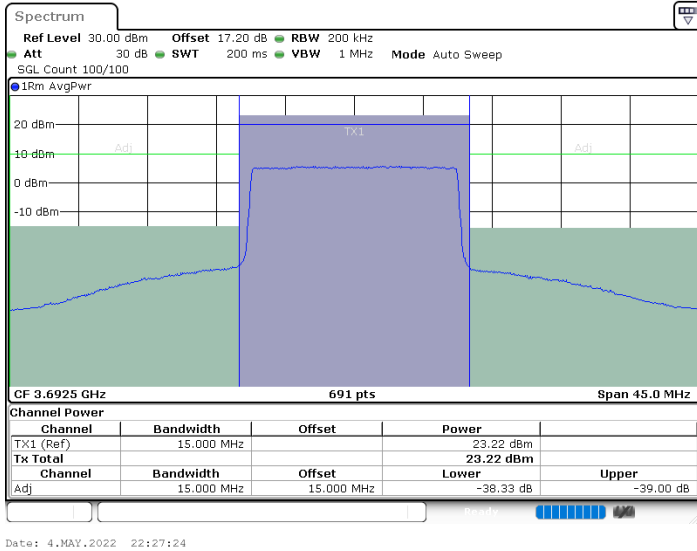

N/A



LTE Band 48 / 20MHz

16QAM

Lowest Channel / 1RB0

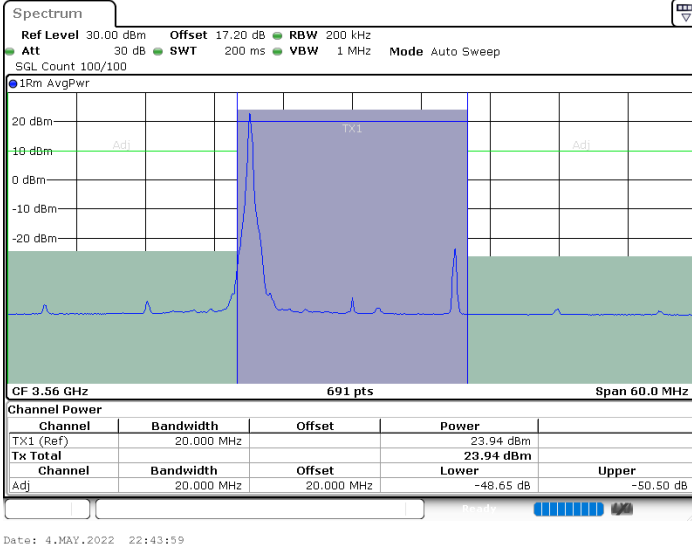

Lowest Channel / 1RBmax

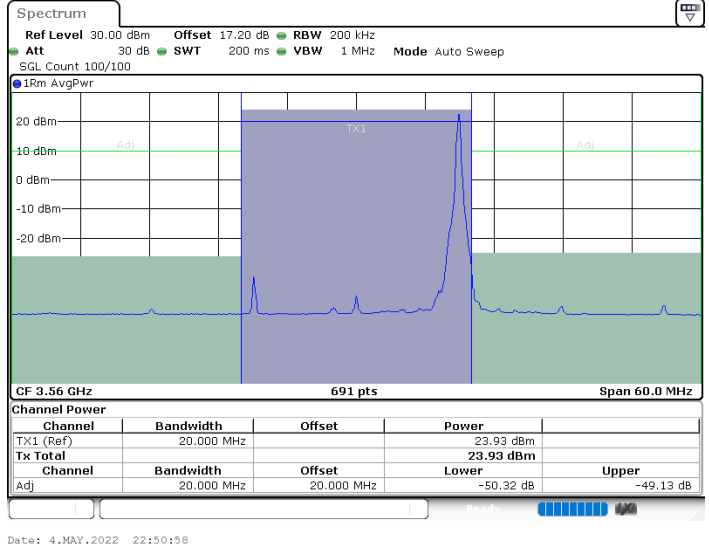

Lowest Channel / FullRB

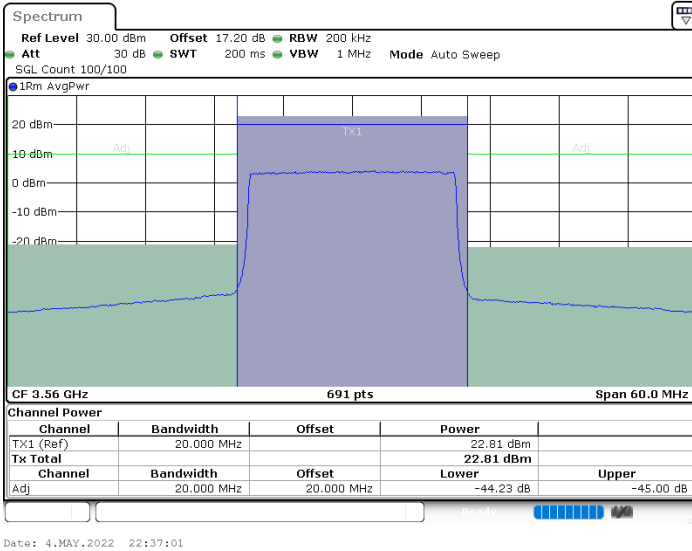

N/A



LTE Band 48 / 20MHz

16QAM

Middle Channel / 1RB0

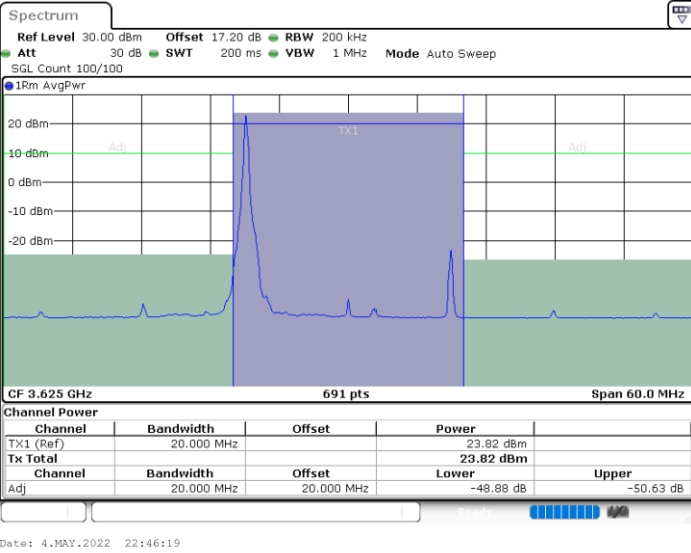

Middle Channel / 1RBmax

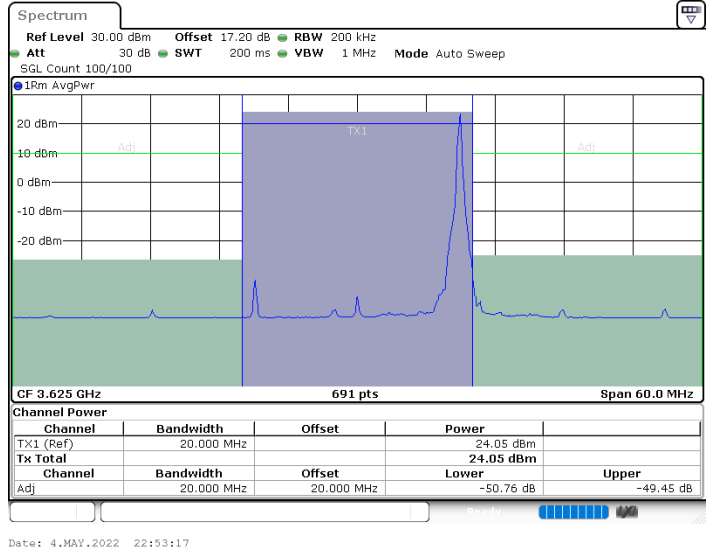

Middle Channel / FullRB

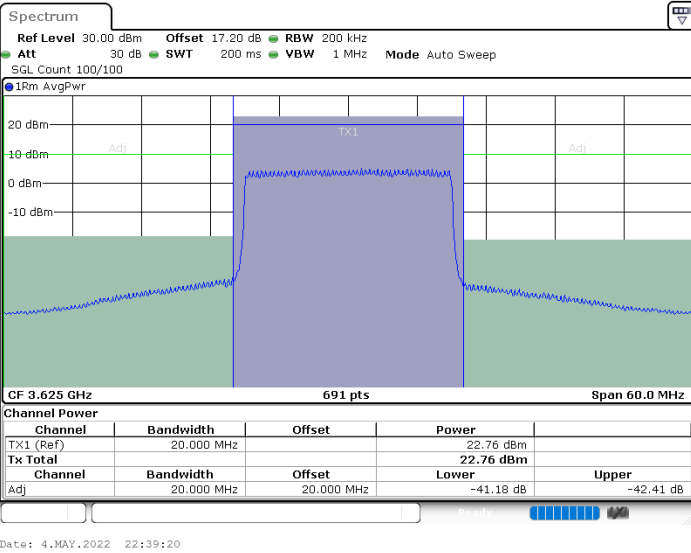

N/A



LTE Band 48 / 20MHz

16QAM

Highest Channel / 1RB0

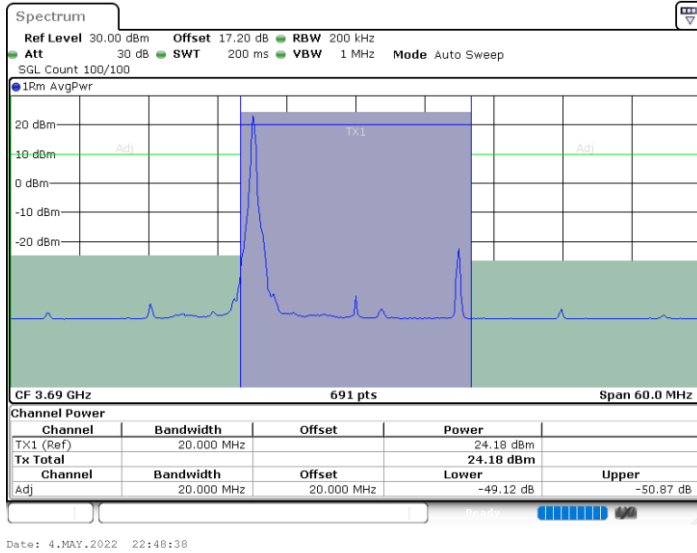

Highest Channel / 1RBmax

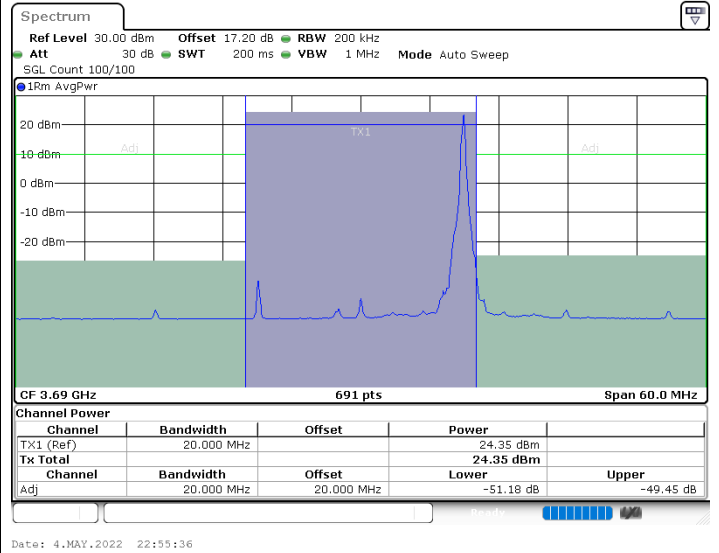

Highest Channel / FullIRB

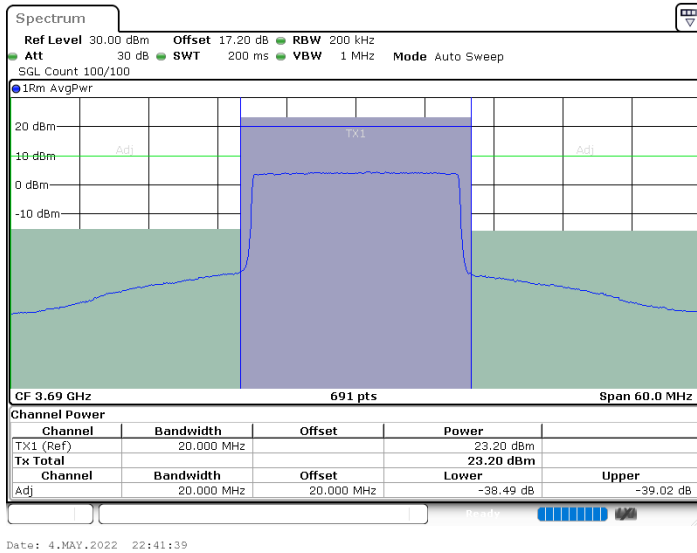

N/A



LTE Band 48 / 5MHz

64QAM

Lowest Channel / 1RB0

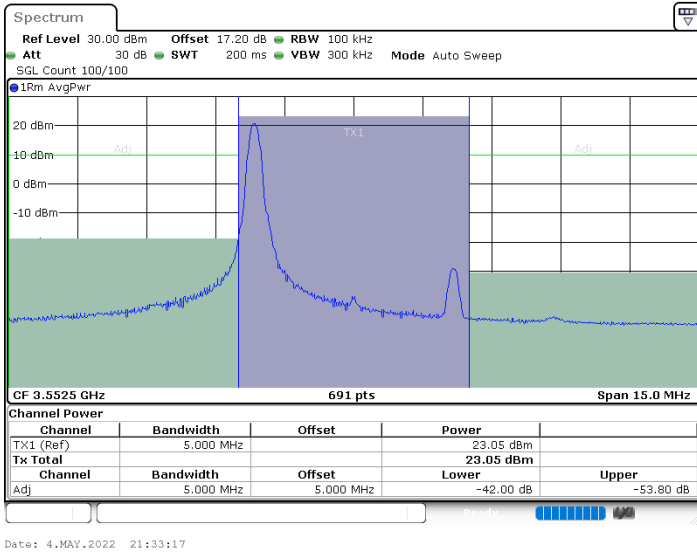

Lowest Channel / 1RBmax

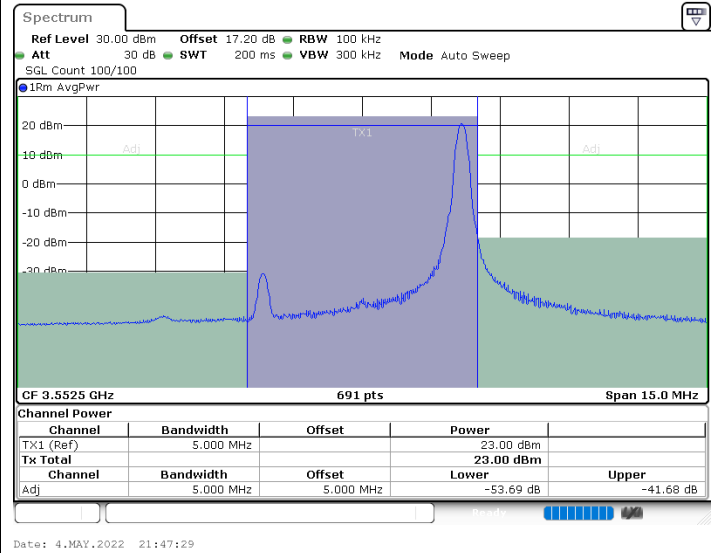

Lowest Channel / FullRB

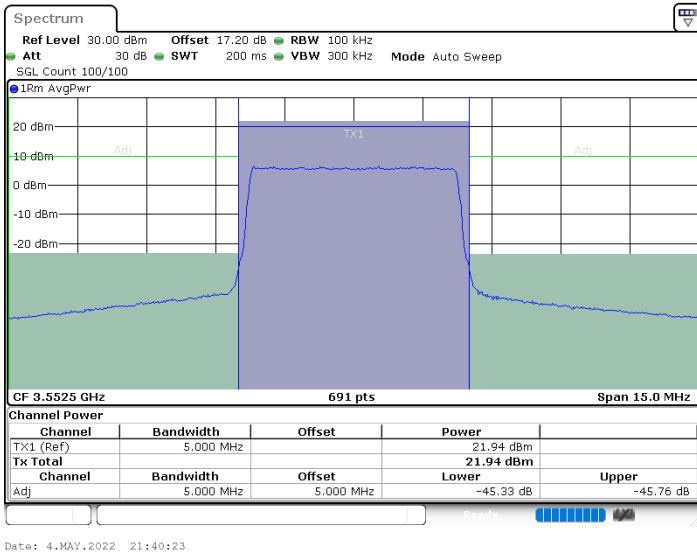

N/A



LTE Band 48 / 5MHz

64QAM

Middle Channel / 1RB0

Middle Channel / 1RBmax

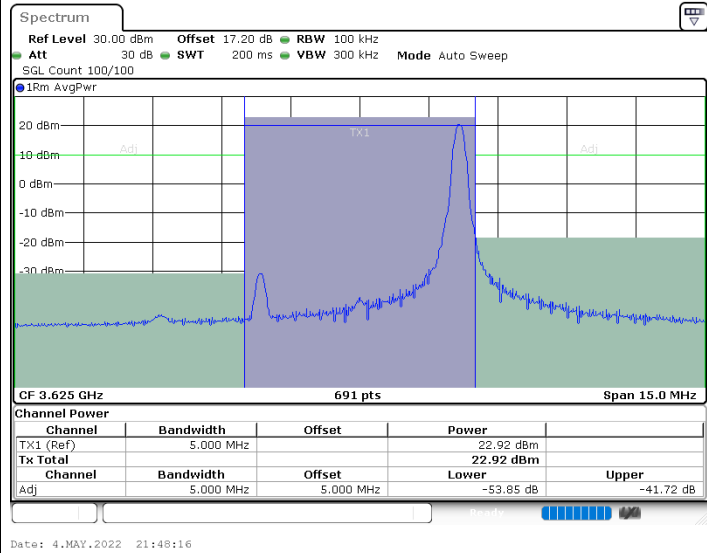
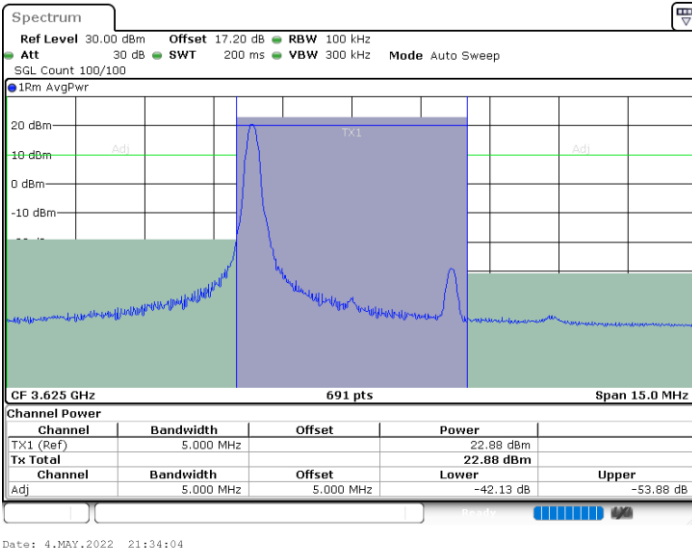

Middle Channel / FullRB

N/A

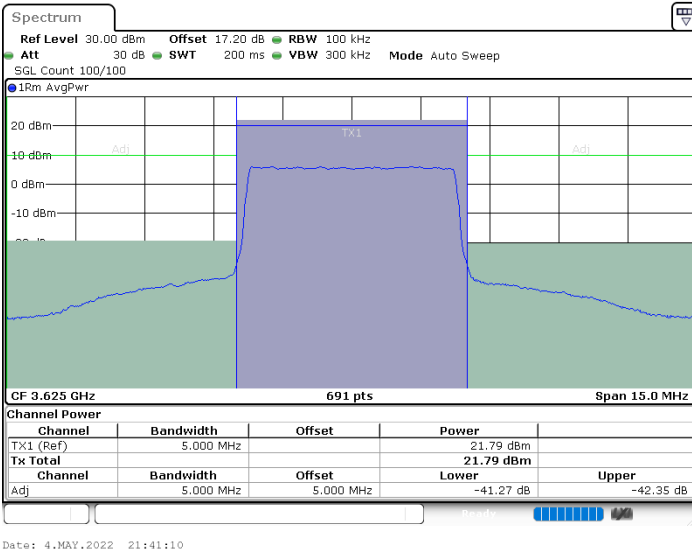





LTE Band 48 / 5MHz

64QAM

Highest Channel / 1RB0

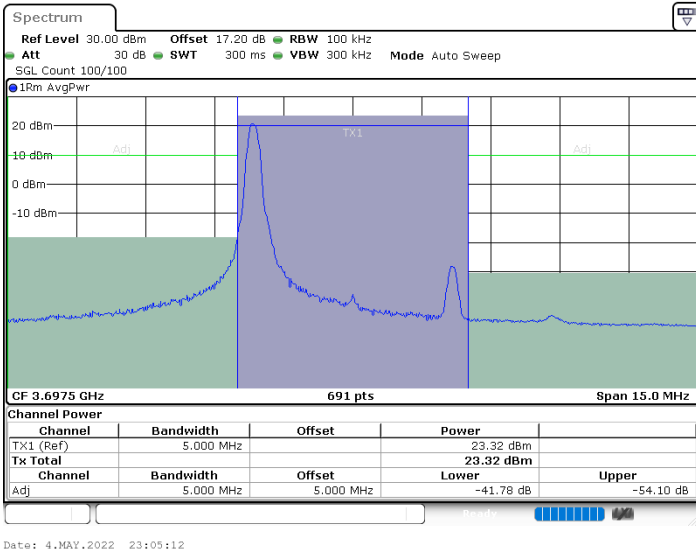

Highest Channel / 1RBmax

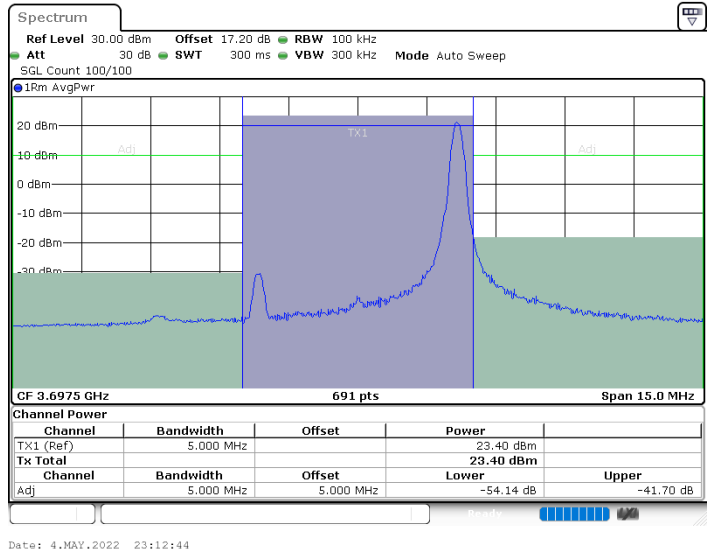

Highest Channel / FullRB

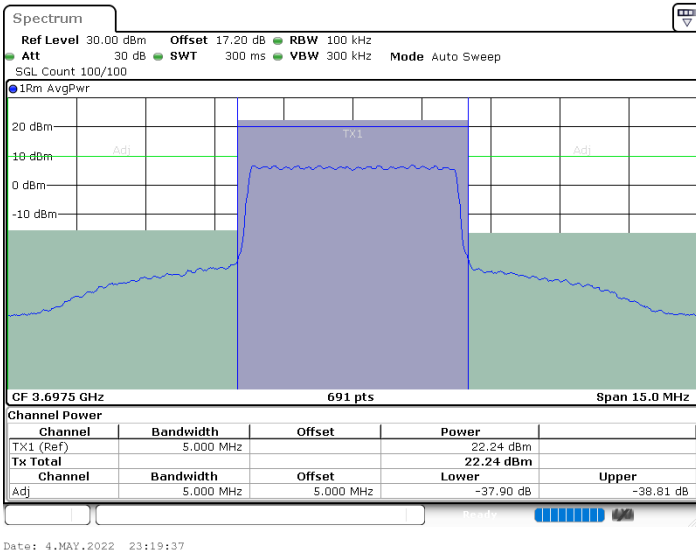

N/A



LTE Band 48 / 10MHz

64QAM

Lowest Channel / 1RB0

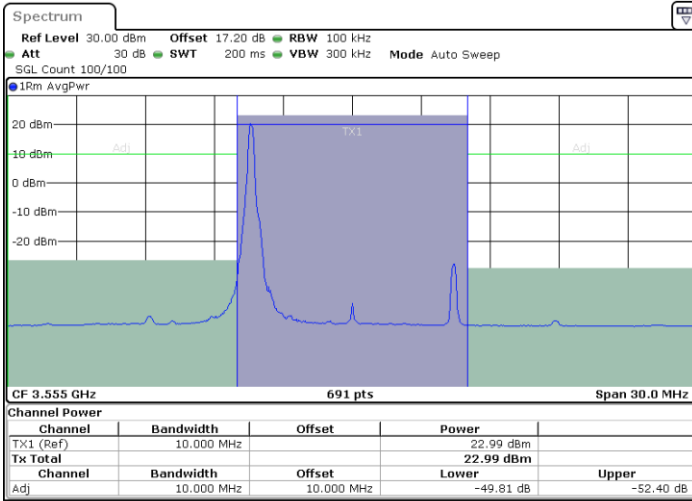

Date: 4.MAY.2022 21:53:06

Lowest Channel / 1RBmax

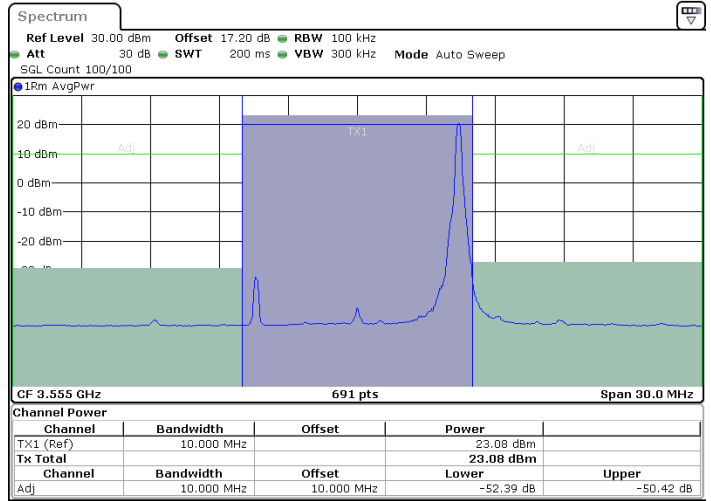

Date: 4.MAY.2022 22:07:26

Lowest Channel / FullRB

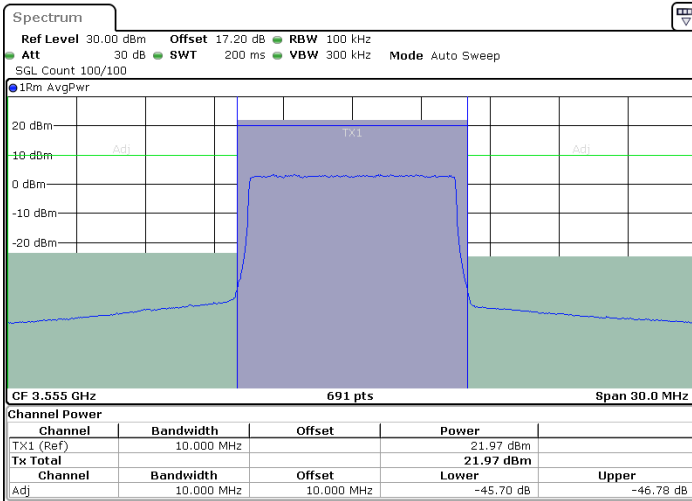

Date: 4.MAY.2022 22:00:16

N/A



LTE Band 48 / 10MHz

64QAM

MiddleChannel / 1RB0

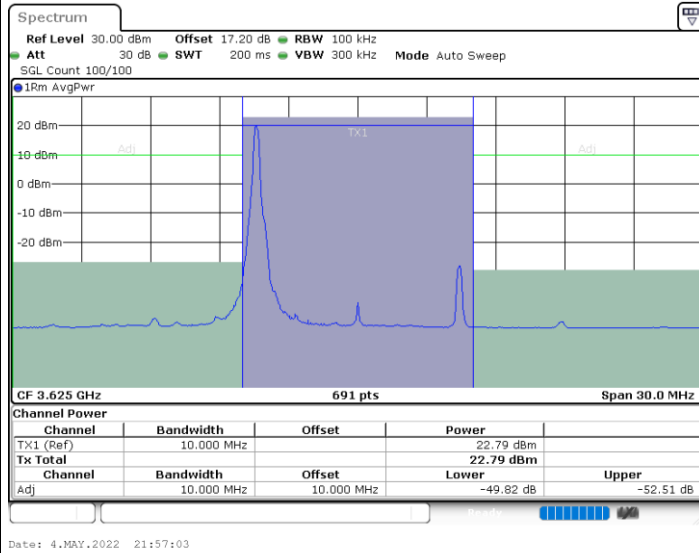

Middle Channel / 1RBmax

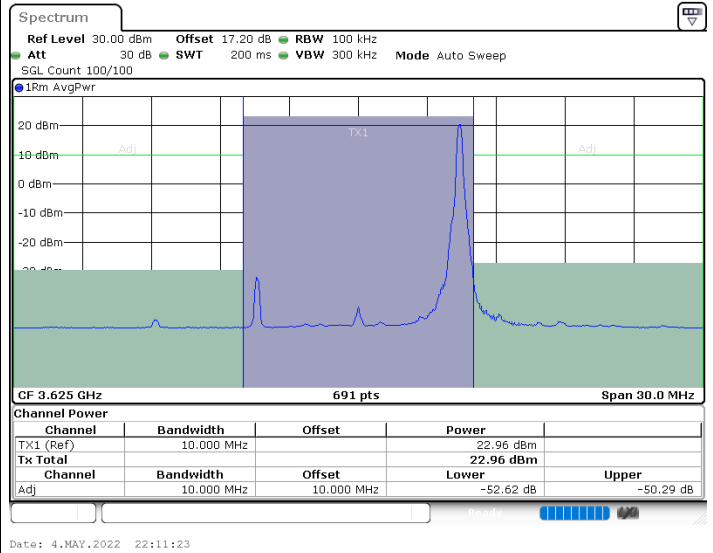

Middle Channel / FullRB

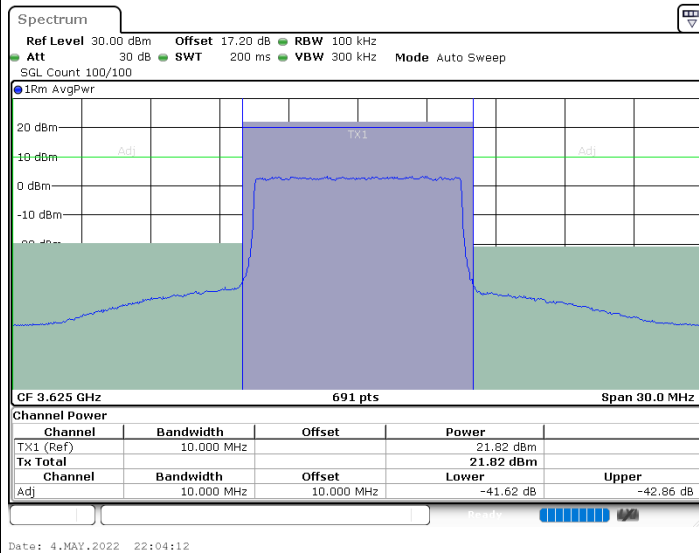

N/A



LTE Band 48 / 10MHz

64QAM

Highest Channel / 1RB0

Highest Channel / 1RBmax

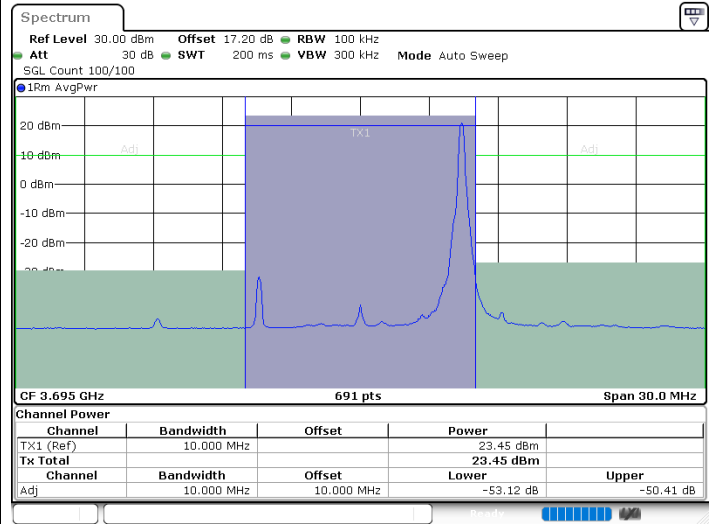
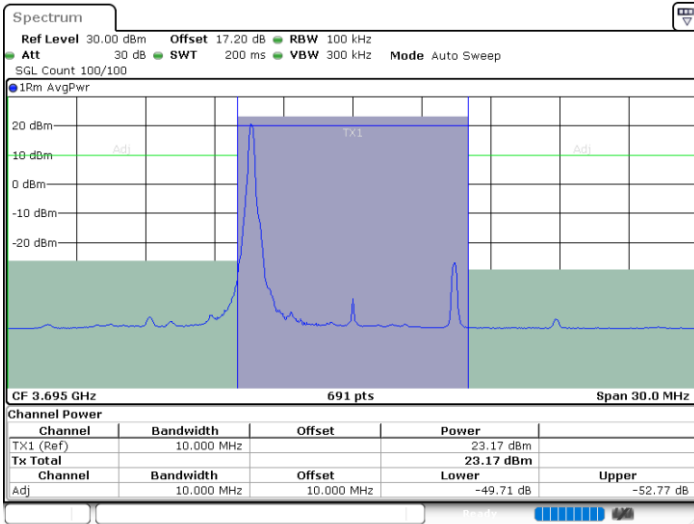

Date: 4.MAY.2022 21:57:51

Date: 4.MAY.2022 22:12:11

Highest Channel / FullRB

N/A

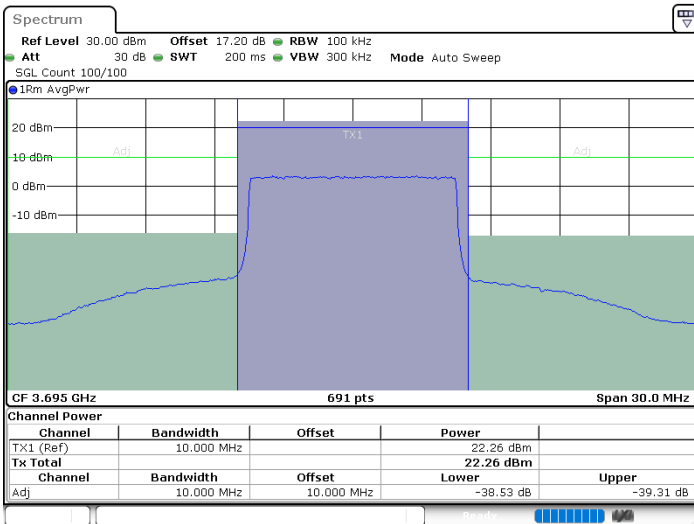

Date: 4.MAY.2022 22:05:00



LTE Band 48 / 15MHz

64QAM

Lowest Channel / 1RB0

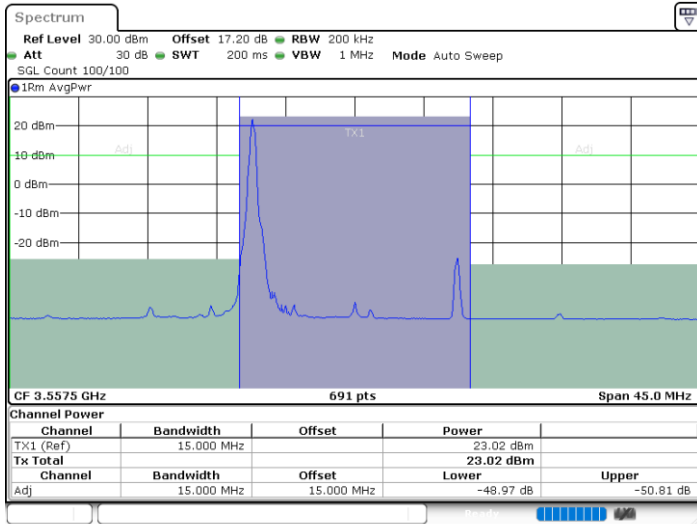

Date: 4.MAY.2022 22:16:16

Lowest Channel / 1RBmax

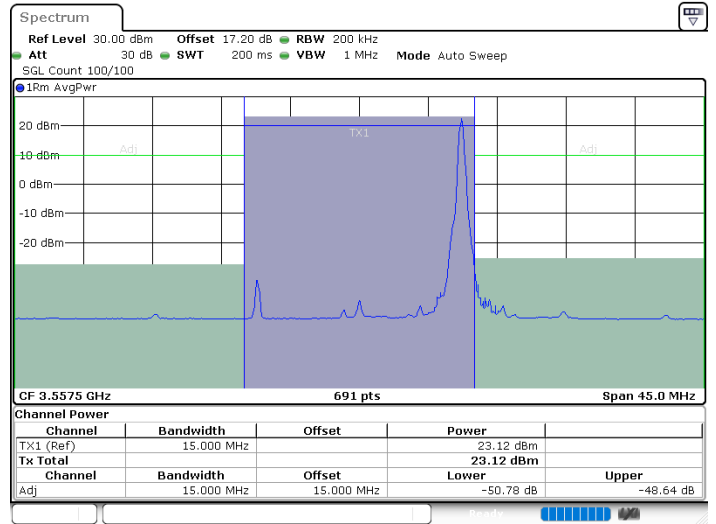

Date: 4.MAY.2022 22:30:35

Lowest Channel / FullRB

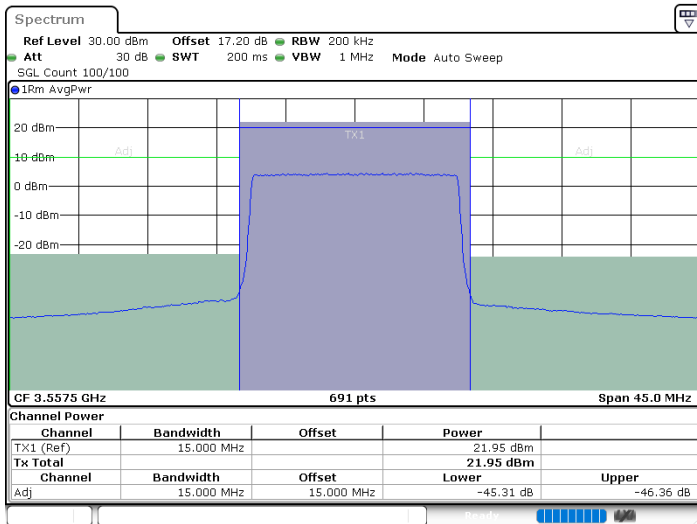

Date: 4.MAY.2022 22:23:26

N/A



LTE Band 48 / 15MHz

64QAM

Middle Channel / 1RB0

Middle Channel / 1RBmax

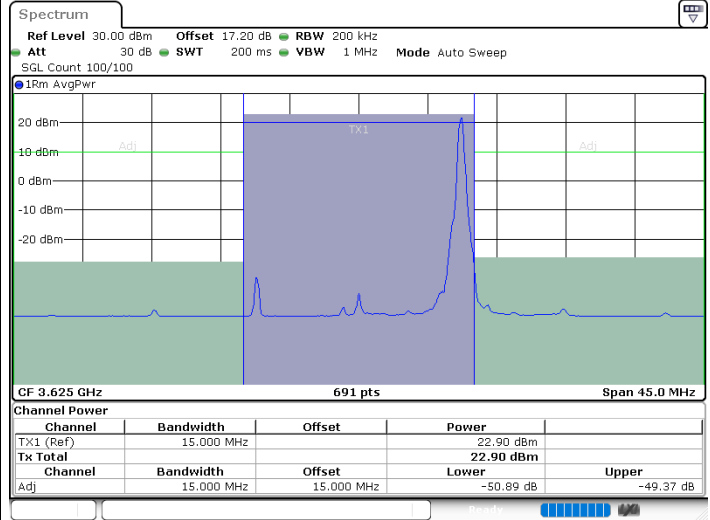
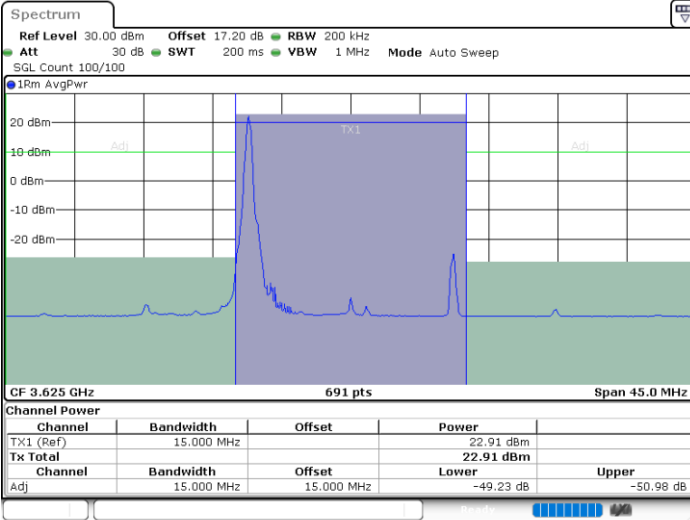

Date: 4.MAY.2022 22:17:04

Date: 4.MAY.2022 22:31:23

Middle Channel / FullRB

N/A

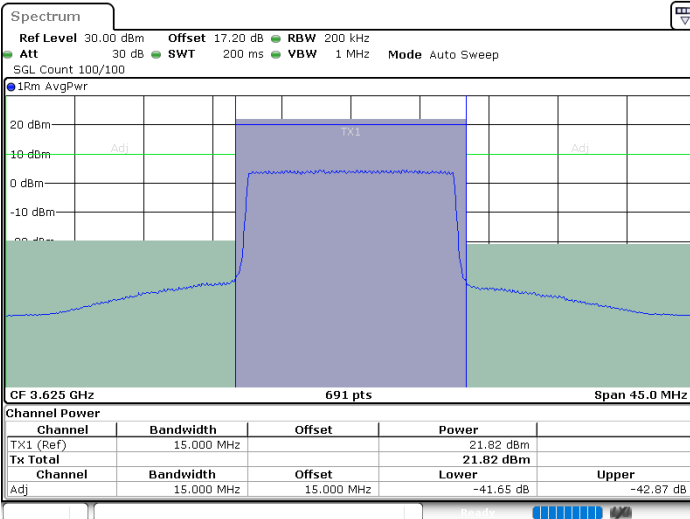

Date: 4.MAY.2022 22:24:13

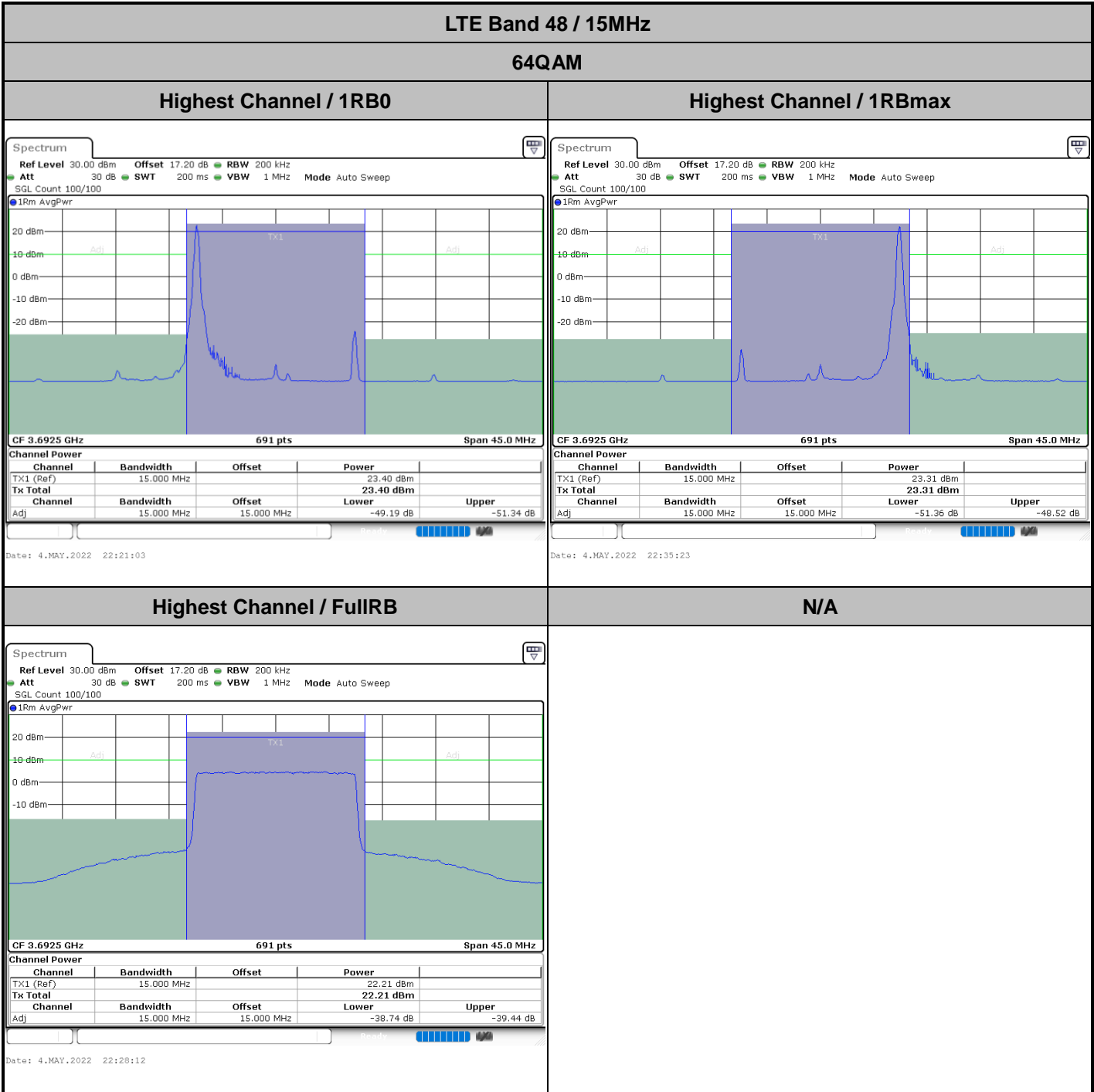

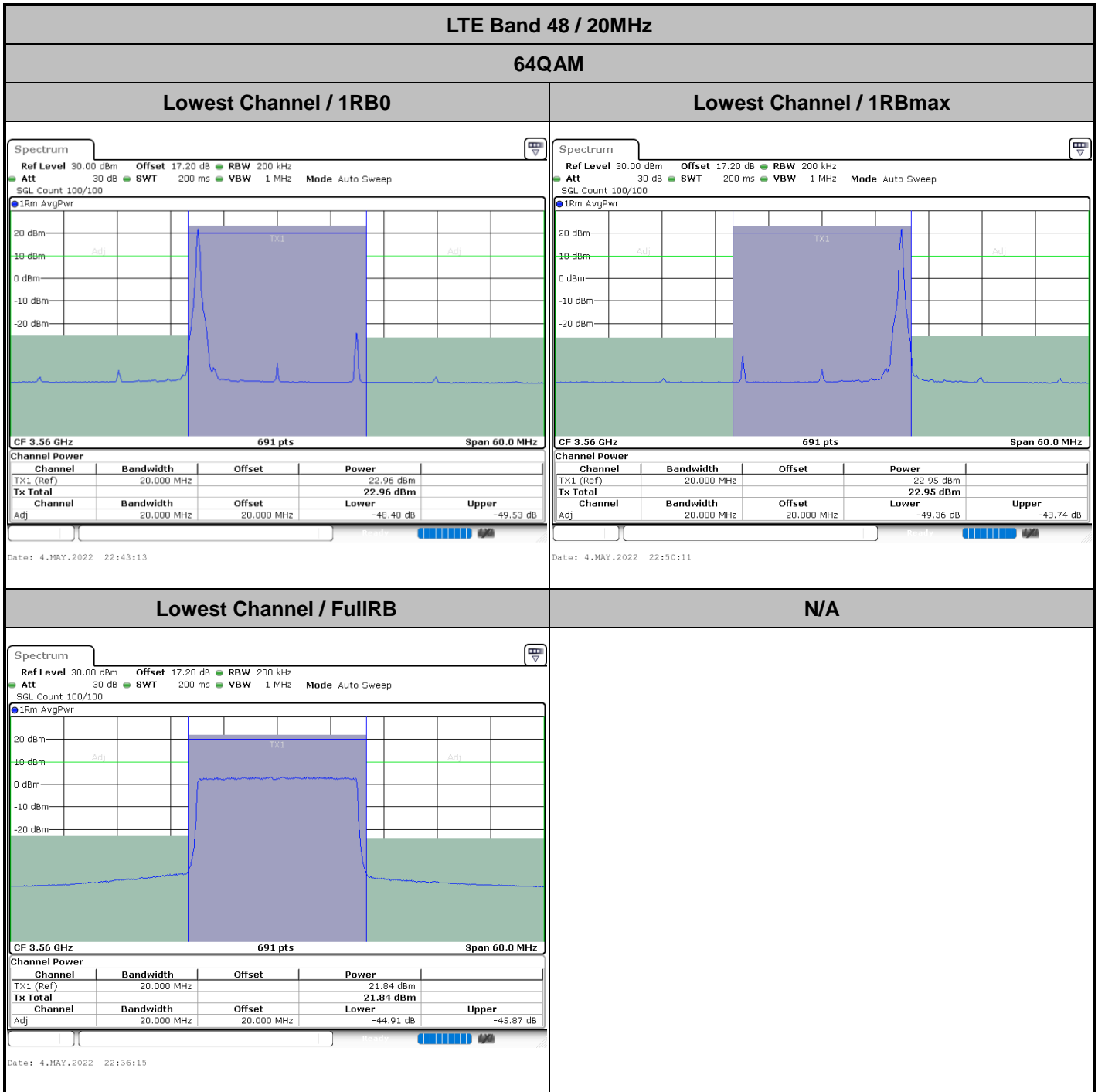



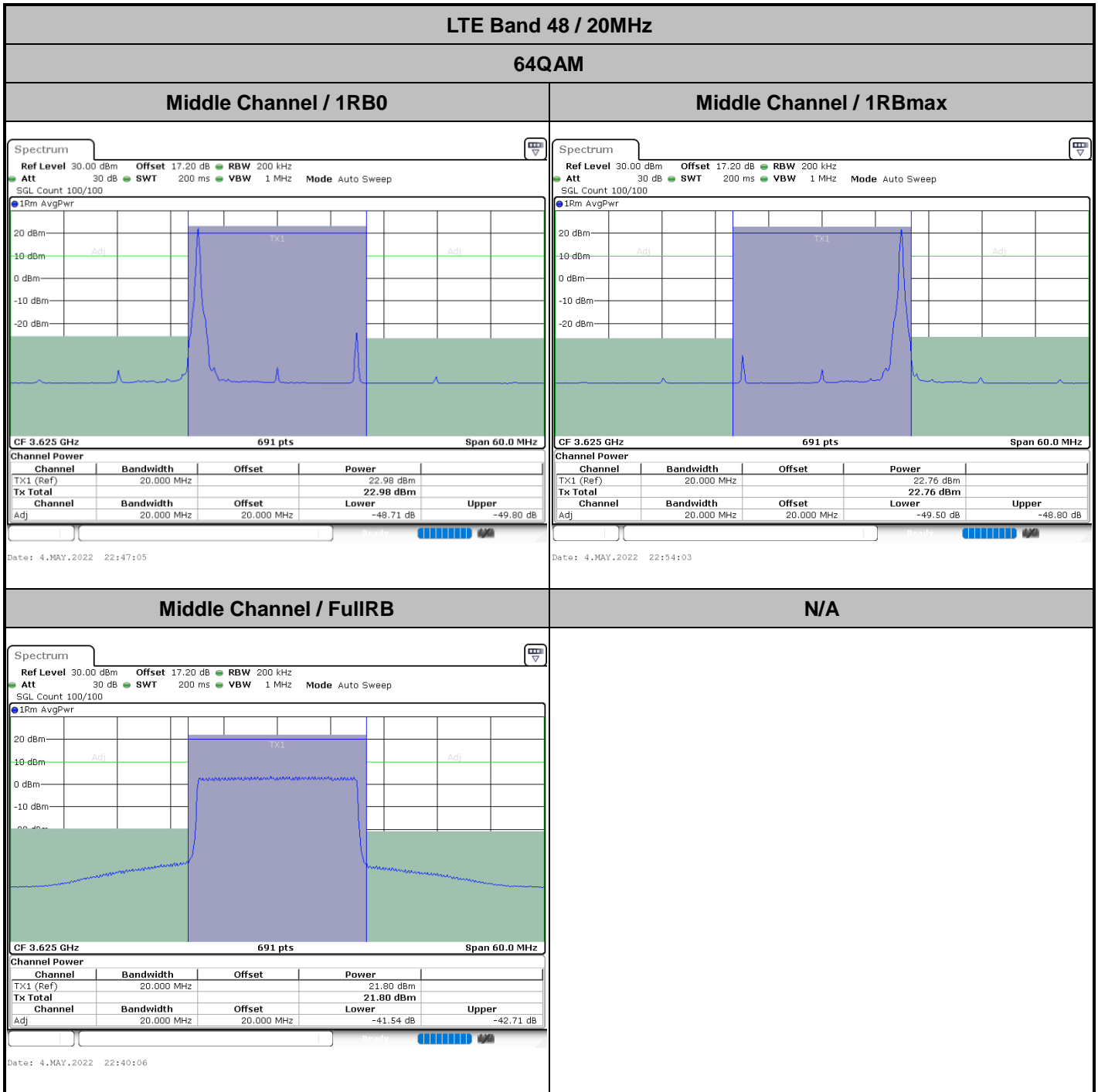



LTE Band 48 / 20MHz

64QAM

Highest Channel / 1RB0

Highest Channel / 1RBmax

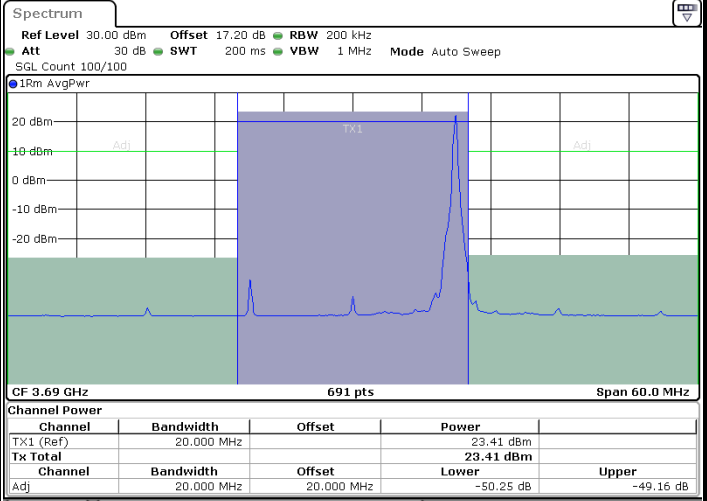
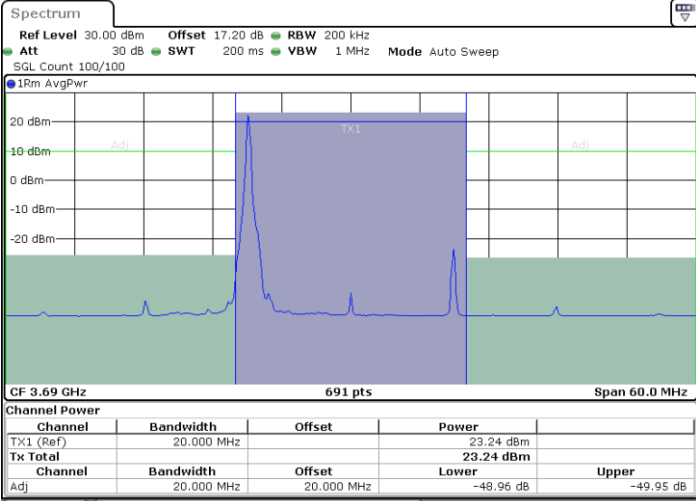

Date: 4.MAY.2022 22:47:51

Date: 4.MAY.2022 22:54:50

Highest Channel / FullIRB

N/A

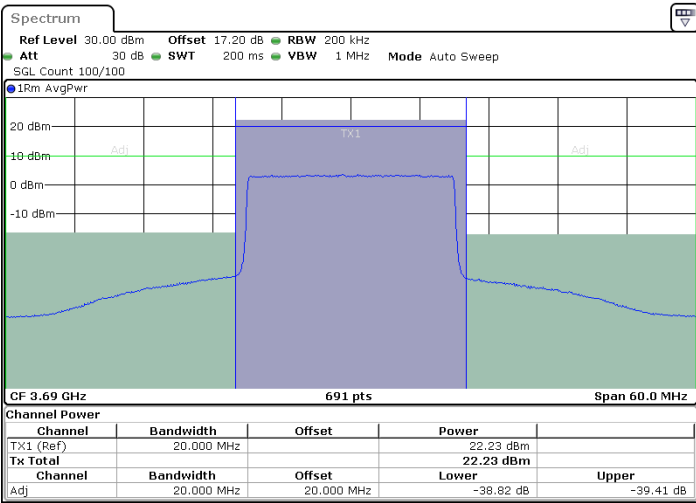

Date: 4.MAY.2022 22:40:53



# Conducted Band Edge

## LTE Band 48 / 5MHz QPSK

### Lowest Channel / 1RB0

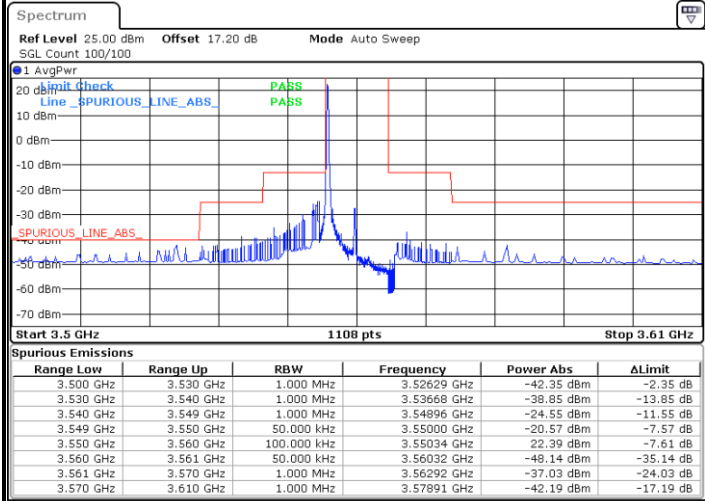

Date: 4.MAY.2022 19:47:23

### Lowest Channel / 1RBmax

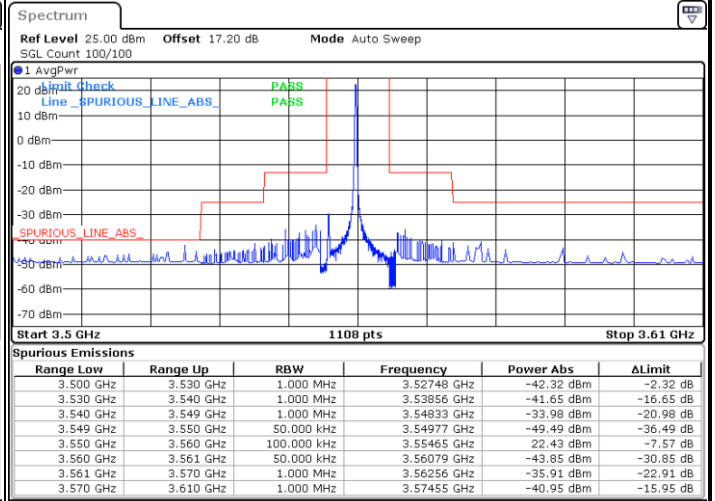

Date: 4.MAY.2022 20:04:44

### Lowest Channel / FullIRB

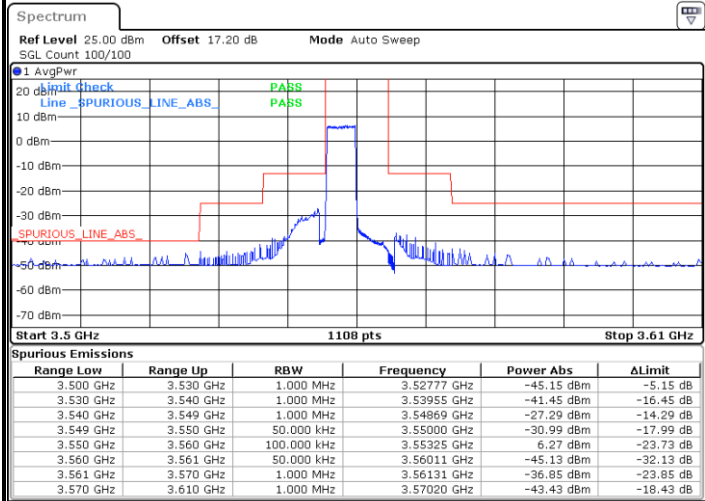

Date: 24.JUN.2022 21:05:14

### N/A



LTE Band 48 / 5MHz

QPSK

Middle Channel / 1RB0

Middle Channel / 1RBmax

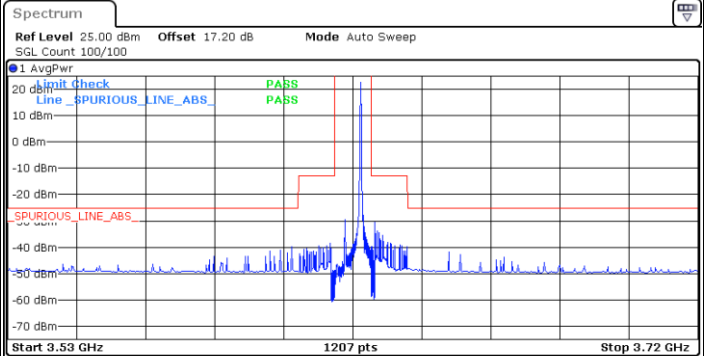
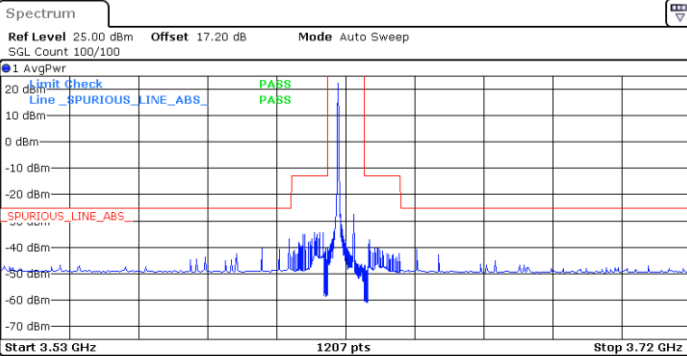

Range Low	Range Up	RBW	Frequency	Power Abs	ΔLimit
3.530 GHz	3.610 GHz	1.000 MHz	3.60940 GHz	-36.90 dBm	-11.90 dB
3.610 GHz	3.619 GHz	1.000 MHz	3.61887 GHz	-34.41 dBm	-21.41 dB
3.619 GHz	3.620 GHz	50.000 kHz	3.61948 GHz	-39.97 dBm	-26.97 dB
3.620 GHz	3.630 GHz	100.000 kHz	3.62286 GHz	22.48 dBm	-7.52 dB
3.630 GHz	3.631 GHz	50.000 kHz	3.63027 GHz	-46.60 dBm	-33.60 dB
3.631 GHz	3.640 GHz	1.000 MHz	3.63140 GHz	-36.97 dBm	-23.97 dB
3.640 GHz	3.720 GHz	1.000 MHz	3.64458 GHz	-40.79 dBm	-15.79 dB

Range Low	Range Up	RBW	Frequency	Power Abs	ΔLimit
3.530 GHz	3.610 GHz	1.000 MHz	3.60821 GHz	-39.74 dBm	-14.74 dB
3.610 GHz	3.619 GHz	1.000 MHz	3.61878 GHz	-38.33 dBm	-25.33 dB
3.619 GHz	3.620 GHz	50.000 kHz	3.61953 GHz	-48.78 dBm	-35.78 dB
3.620 GHz	3.630 GHz	100.000 kHz	3.62719 GHz	22.53 dBm	-7.47 dB
3.630 GHz	3.631 GHz	50.000 kHz	3.63015 GHz	-39.63 dBm	-26.63 dB
3.631 GHz	3.640 GHz	1.000 MHz	3.63104 GHz	-30.57 dBm	-17.57 dB
3.640 GHz	3.720 GHz	1.000 MHz	3.65134 GHz	-41.94 dBm	-16.94 dB

Date: 4.MAY.2022 19:52:11

Date: 4.MAY.2022 20:09:33

Middle Channel / FullIRB

N/A

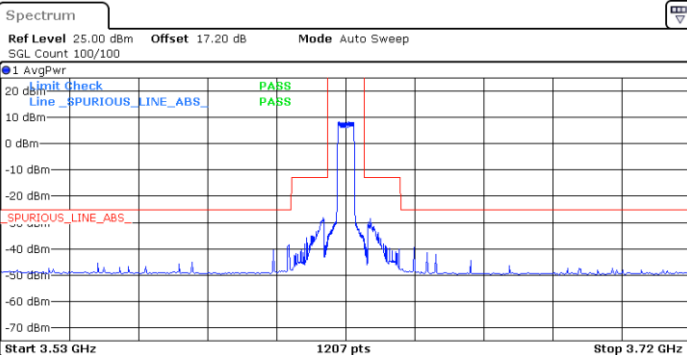

Range Low	Range Up	RBW	Frequency	Power Abs	ΔLimit
3.530 GHz	3.610 GHz	1.000 MHz	3.60940 GHz	-38.60 dBm	-13.60 dB
3.610 GHz	3.619 GHz	1.000 MHz	3.61869 GHz	-28.20 dBm	-15.20 dB
3.619 GHz	3.620 GHz	50.000 kHz	3.61990 GHz	-36.90 dBm	-23.90 dB
3.620 GHz	3.630 GHz	100.000 kHz	3.62562 GHz	8.27 dBm	-21.73 dB
3.630 GHz	3.631 GHz	50.000 kHz	3.63013 GHz	-37.66 dBm	-24.66 dB
3.631 GHz	3.640 GHz	1.000 MHz	3.63167 GHz	-28.43 dBm	-15.43 dB
3.640 GHz	3.720 GHz	1.000 MHz	3.64378 GHz	-39.46 dBm	-14.46 dB

Date: 4.MAY.2022 20:00:52



LTE Band 48 / 5MHz

QPSK

Highest Channel / 1RB0

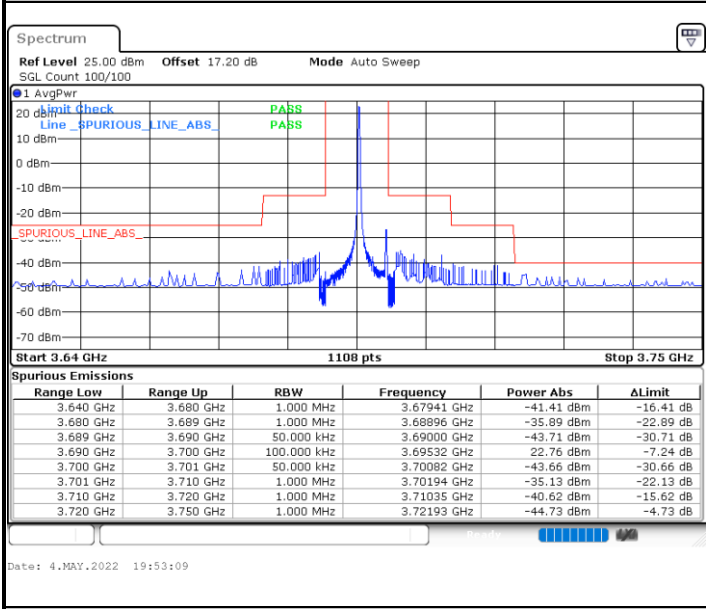

Highest Channel / 1RBmax

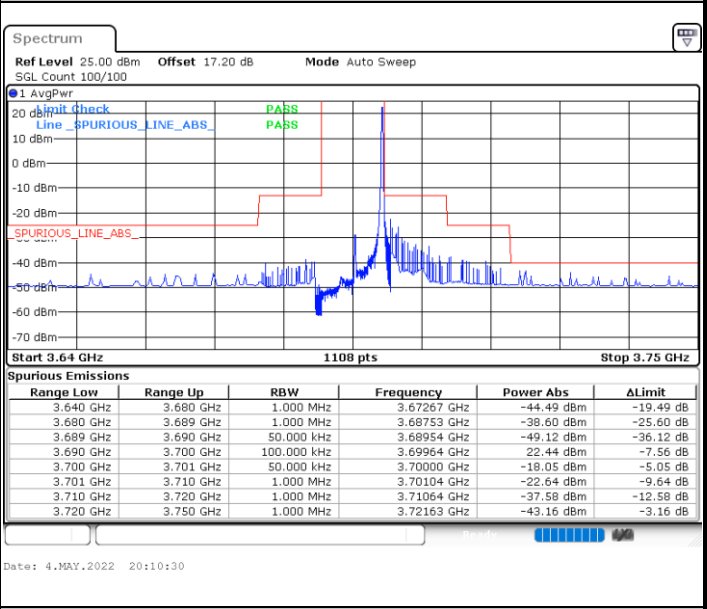

Highest Channel / FullIRB

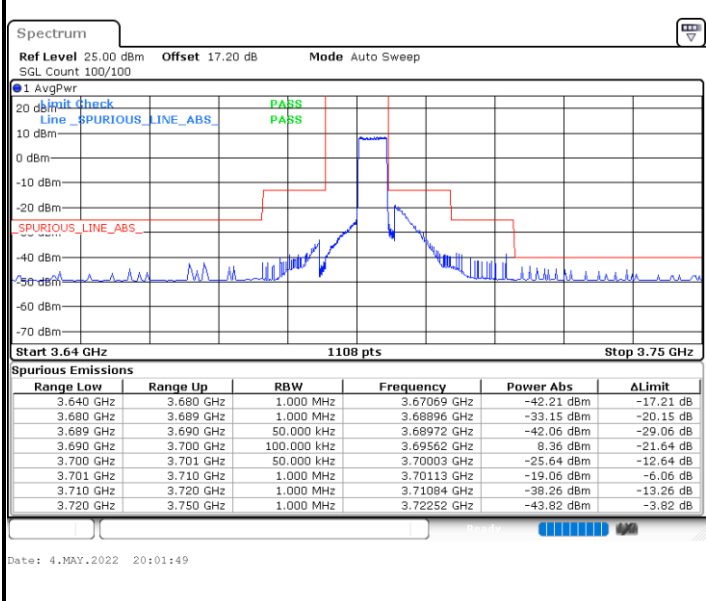

N/A



LTE Band 48 / 10MHz

QPSK

Lowest Channel / 1RB0

Lowest Channel / 1RBmax

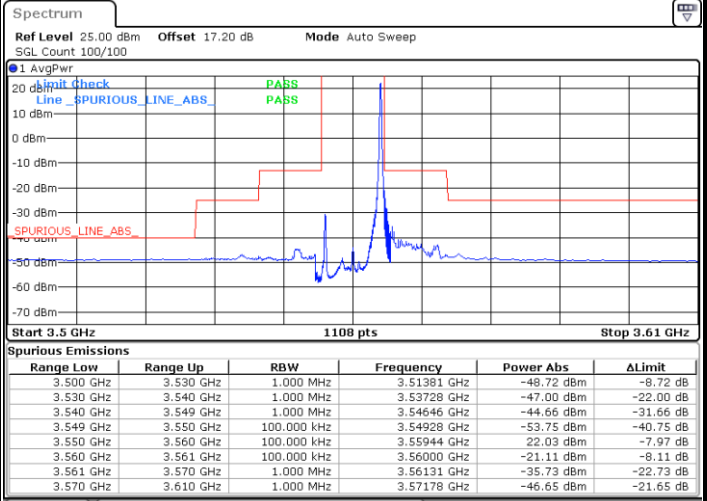
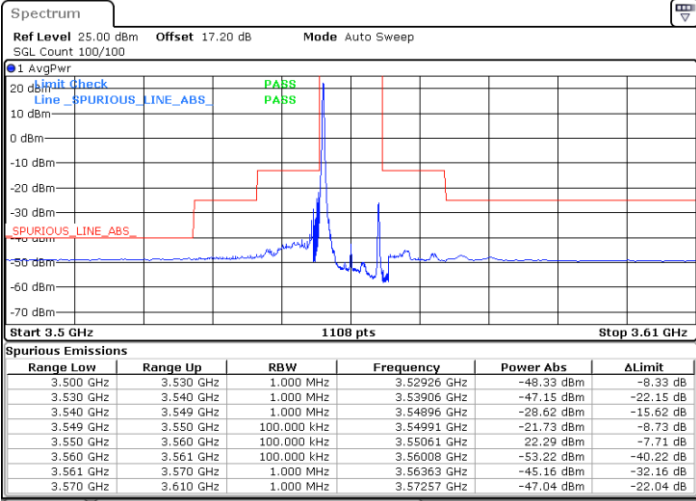

Date: 4.MAY.2022 20:15:25

Date: 4.MAY.2022 20:32:45

Lowest Channel / FullIRB

N/A

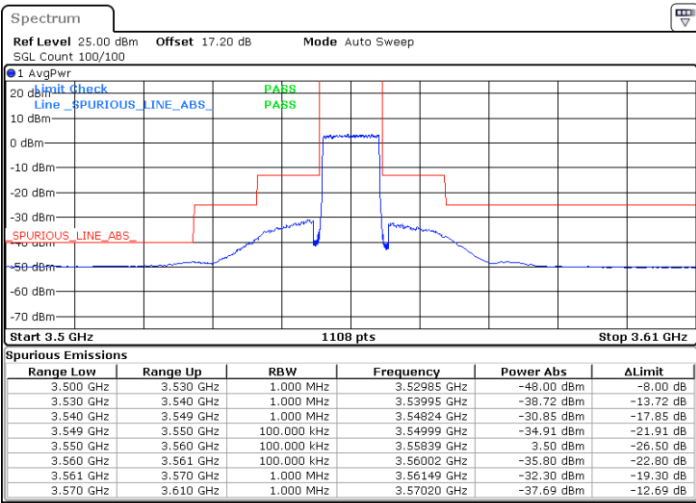

Date: 24.JUN.2022 21:09:18



LTE Band 48 / 10MHz

QPSK

MiddleChannel / 1RB0

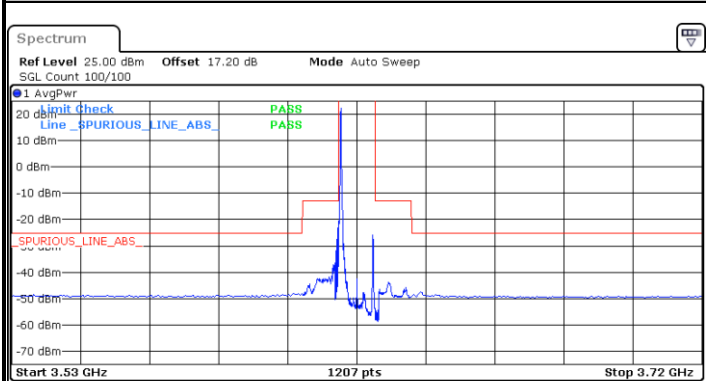

Range Low	Range Up	RBW	Frequency	Power Abs	ΔLimit
3.530 GHz	3.610 GHz	1.000 MHz	3.60980 GHz	-48.23 dBm	-23.23 dB
3.610 GHz	3.619 GHz	1.000 MHz	3.61896 GHz	-36.34 dBm	-23.34 dB
3.619 GHz	3.620 GHz	100.000 kHz	3.61991 GHz	-20.55 dBm	-7.55 dB
3.620 GHz	3.630 GHz	100.000 kHz	3.62056 GHz	22.23 dBm	-7.77 dB
3.630 GHz	3.631 GHz	100.000 kHz	3.63010 GHz	-54.54 dBm	-41.54 dB
3.631 GHz	3.640 GHz	1.000 MHz	3.63363 GHz	-43.93 dBm	-30.93 dB
3.640 GHz	3.720 GHz	1.000 MHz	3.64259 GHz	-47.51 dBm	-22.51 dB

Date: 4.MAY.2022 20:16:23

Middle Channel / 1RBmax

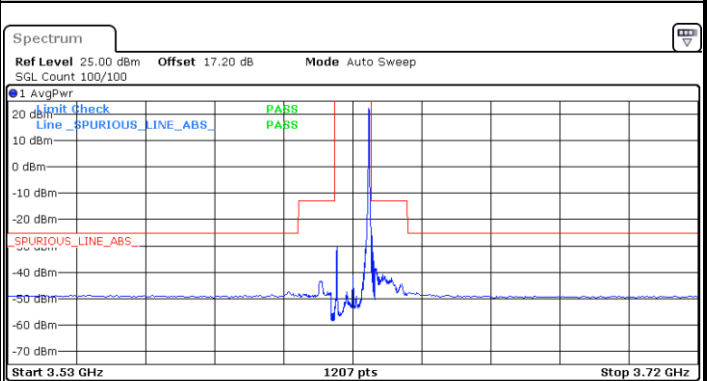

Range Low	Range Up	RBW	Frequency	Power Abs	ΔLimit
3.530 GHz	3.610 GHz	1.000 MHz	3.60741 GHz	-47.38 dBm	-22.38 dB
3.610 GHz	3.619 GHz	1.000 MHz	3.61628 GHz	-43.46 dBm	-30.46 dB
3.619 GHz	3.620 GHz	100.000 kHz	3.61998 GHz	-54.13 dBm	-41.13 dB
3.620 GHz	3.630 GHz	100.000 kHz	3.62941 GHz	22.26 dBm	-7.74 dB
3.630 GHz	3.631 GHz	100.000 kHz	3.63005 GHz	-23.00 dBm	-10.00 dB
3.631 GHz	3.640 GHz	1.000 MHz	3.63113 GHz	-38.40 dBm	-25.40 dB
3.640 GHz	3.720 GHz	1.000 MHz	3.64259 GHz	-47.65 dBm	-22.65 dB

Date: 4.MAY.2022 20:33:43

Middle Channel / FullIRB

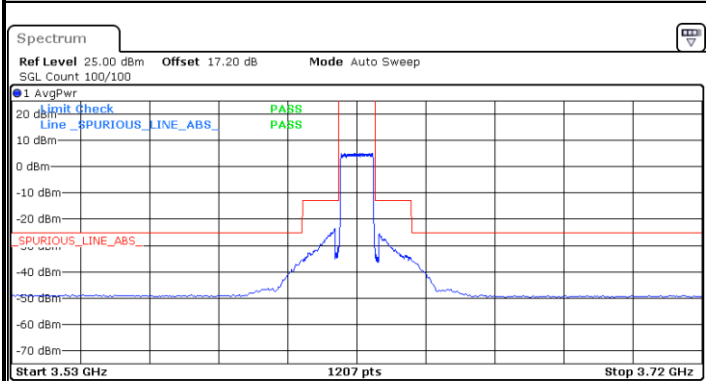

Range Low	Range Up	RBW	Frequency	Power Abs	ΔLimit
3.530 GHz	3.610 GHz	1.000 MHz	3.60980 GHz	-35.44 dBm	-10.44 dB
3.610 GHz	3.619 GHz	1.000 MHz	3.61896 GHz	-23.57 dBm	-10.57 dB
3.619 GHz	3.620 GHz	100.000 kHz	3.61989 GHz	-30.38 dBm	-17.38 dB
3.620 GHz	3.630 GHz	100.000 kHz	3.62842 GHz	5.13 dBm	-24.87 dB
3.630 GHz	3.631 GHz	100.000 kHz	3.63003 GHz	-32.03 dBm	-19.03 dB
3.631 GHz	3.640 GHz	1.000 MHz	3.63113 GHz	-25.54 dBm	-12.54 dB
3.640 GHz	3.720 GHz	1.000 MHz	3.64020 GHz	-35.75 dBm	-10.75 dB

Date: 4.MAY.2022 20:25:03

N/A