



FCC RADIO TEST REPORT

FCC ID : N7NEM75T
Equipment : Radio Module
Brand Name : AirPrime
Model Name : EM7590
Applicant : Sierra Wireless, Inc.
13811 Wireless Way, Richmond, BC V6V 3A4 Canada
Manufacturer : Sierra Wireless, Inc.
13811 Wireless Way, Richmond, BC V6V 3A4 Canada
Standard : FCC 47 CFR Part 2, 22(H), 24(E), 27(L)

The product was received on Apr. 25, 2022 and testing was performed from May 04, 2022 to May 11, 2022. We, Sporton International Inc. EMC & Wireless Communications Laboratory, would like to declare that the tested sample has been evaluated in accordance with the test procedures given in ANSI / TIA-603-E and has been in compliance with the applicable technical standards.

The test results in this report apply exclusively to the tested model / sample. Without written approval from Sporton International Inc. EMC & Wireless Communications Laboratory, the test report shall not be reproduced except in full.

Louis Wu

Approved by: Louis Wu

Sporton International Inc. EMC & Wireless Communications Laboratory

No. 52, Huaya 1st Rd., Guishan Dist., Taoyuan City 333, Taiwan (R.O.C.)



Table of Contents

History of this test report.....	3
Summary of Test Result.....	4
1 General Description	5
1.1 Product Feature of Equipment Under Test	5
1.2 Modification of EUT	5
1.3 Testing Location	6
1.4 Applicable Standards	6
2 Test Configuration of Equipment Under Test	7
2.1 Test Mode.....	7
2.2 Connection Diagram of Test System	7
2.3 Support Unit used in test configuration	8
2.4 Measurement Results Explanation Example	8
2.5 Frequency List of Low/Middle/High Channels.....	8
3 Conducted Test Result	9
3.1 Measuring Instruments.....	9
3.2 Conducted Output Power	10
3.3 Peak-to-Average Ratio	11
3.4 99% Occupied Bandwidth and 26dB Bandwidth Measurement.....	12
3.5 Conducted Band Edge	13
3.6 Conducted Spurious Emission	14
3.7 Frequency Stability.....	15
4 Radiated Test Items	16
4.1 Measuring Instruments.....	16
4.2 Test Setup	16
4.3 Test Result of Radiated Test.....	17
4.4 Field Strength of Spurious Radiation Measurement	18
5 List of Measuring Equipment.....	19
6 Uncertainty of Evaluation	21
Appendix A. Test Results of Conducted Test	
Appendix B. Test Results of Radiated Test	
Appendix C. Test Setup Photographs	



History of this test report

Report No.	Version	Description	Issue Date
FG242018A	01	Initial issue of report	Aug. 09, 2022



Summary of Test Result

Report Clause	Ref Std. Clause	Test Items	Result (PASS/FAIL)	Remark
3.2	§2.1046	Conducted Output Power	Pass	-
3.3	§24.232 (d)	Peak-to-Average Ratio	Pass	-
3.4	§2.1049 §22.917 (b) §24.238 (b) §27.53 (g)	Occupied Bandwidth (WCDMA Band V) (WCDMA Band II) (WCDMA Band IV)	Pass	-
3.5	§2.1051 §22.917 (a) §24.238 (a) §27.53 (g)	Band Edge Measurement (WCDMA Band V) (WCDMA Band II) (WCDMA Band IV)	Pass	-
3.6	§2.1051 §22.917 (a) §24.238 (a) §27.53 (g)	Conducted Emission (WCDMA Band V) (WCDMA Band II) (WCDMA Band IV)	Pass	-
3.7	§2.1055 §22.355 §24.235 §27.54	Frequency Stability Temperature & Voltage	Pass	-
4.4	§2.1053 §22.917 (a) §24.238 (a) §27.53 (h)	Field Strength of Spurious Radiation (WCDMA Band V) (WCDMA Band II) (WCDMA Band IV)	Pass	36.83 dB under the limit at 2480.000 MHz

Declaration of Conformity:

- The test results (PASS/FAIL) with all measurement uncertainty excluded are presented in accordance with the regulation limits or requirements declared by manufacturers. It's means measurement values may risk exceeding the limit of regulation standards, if measurement uncertainty is include in test results.
- The measurement uncertainty please refer to this report "Uncertainty of Evaluation".

Comments and Explanations:

The product specifications of the EUT presented in the report are declared by the manufacturer who shall take full responsibility for the authenticity.

Reviewed by: Avis Chuang

Report Producer: Yimin Ho



1 General Description

1.1 Product Feature of Equipment Under Test

WCDMA/LTE, and GNSS.

Remark:

1. The EUT's information above is declared by manufacturer. Please refer to Comments and Explanations in report summary.
2. Maximum allow antenna Gain : refer MPE Report FA242018.

1.2 Modification of EUT

No modifications made to the EUT during the testing.



1.3 Testing Location

Test Site	Sporton International Inc. EMC & Wireless Communications Laboratory	
Test Site Location	No.52, Huaya 1st Rd., Guishan Dist., Taoyuan City 333, Taiwan (R.O.C.) TEL: +886-3-327-3456 FAX: +886-3-328-4978	
Test Site No.	Sporton Site No.	
	TH03-HY	03CH07-HY
Test Engineer	Nina Cheng	Jesse Wang, Stan Hsieh, Ken Wu
Temperature (°C)	21~22	23.6~25.7
Relative Humidity (%)	51~52	56.3~62.5

Note: The test site complies with ANSI C63.4 2014 requirement.

FCC Designation No.: TW1190

1.4 Applicable Standards

According to the specifications declared by the manufacturer, the EUT must comply with the requirements of the following standards:

- ♦ ANSI C63.26-2015
- ♦ ANSI / TIA-603-E
- ♦ FCC 47 CFR Part 2, 22(H), 24(E), 27(L)
- ♦ FCC KDB 971168 D01 Power Meas. License Digital Systems v03r01
- ♦ FCC KDB 412172 D01 Determining ERP and EIRP v01r01
- ♦ FCC KDB 414788 D01 Radiated Test Site v01r01

Remark:

1. All the test items were validated and recorded in accordance with the standards without any modification during the testing.
2. The TAF code is not including all the FCC KDB listed without accreditation.

2 Test Configuration of Equipment Under Test

2.1 Test Mode

Antenna port conducted and radiated test items were performed according to KDB 971168 D01 Power Meas. License Digital Systems v03r01 with maximum output power.

For radiated measurement, the measured emission level of the EUT was maximized by rotating the EUT on a turntable, adjusting the orientation of the EUT and EUT antenna in two angle (Ant. Horizontal and Ant. Vertical), and adjusting the measurement antenna orientation, following C63.26 exploratory test procedures and find Ant. Vertical as worst plane.

Radiated emissions were investigated as following frequency range:

1. 30 MHz to 9000 MHz for WCDMA Band V
2. 30 MHz to 18000 MHz for WCDMA Band IV
3. 30 MHz to 19100 MHz for WCDMA Band II

All modes, data rates and positions were investigated.

Test modes are chosen to be reported as the worst case configuration below:

Test Modes		
Band	Radiated TCs	Conducted TCs
WCDMA Band V	■ RMC 12.2Kbps Link	■ RMC 12.2Kbps Link
WCDMA Band II	■ RMC 12.2Kbps Link	■ RMC 12.2Kbps Link
WCDMA Band IV	■ RMC 12.2Kbps Link	■ RMC 12.2Kbps Link

2.2 Connection Diagram of Test System

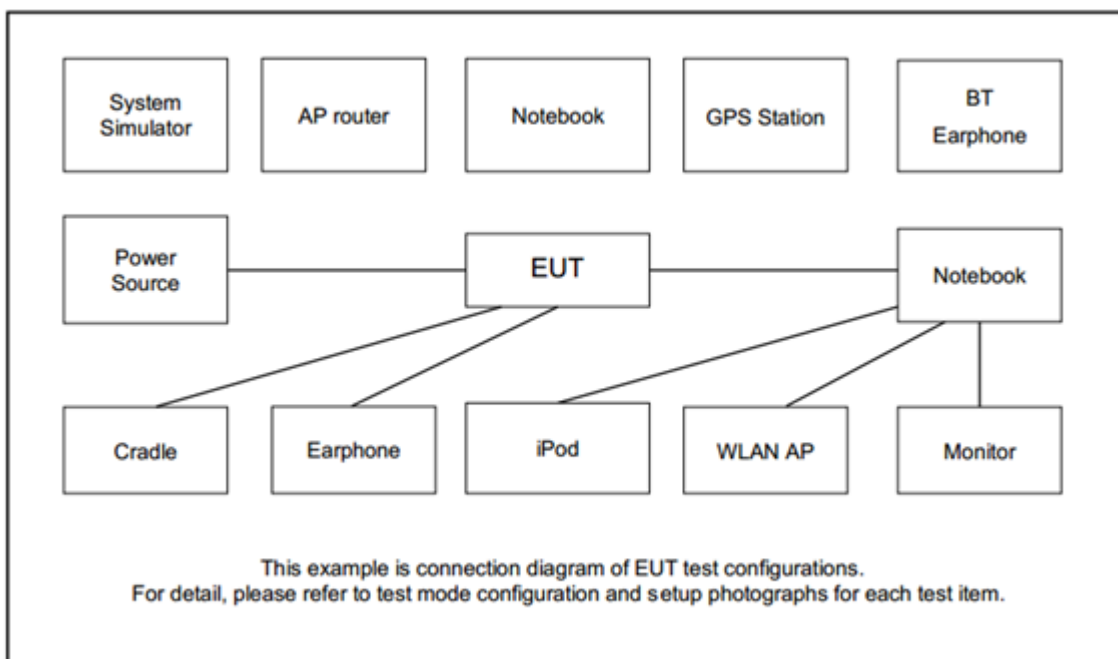



2.3 Support Unit used in test configuration

Item	Equipment	Brand Name	Model No.	FCC ID	Data Cable	Power Cord
1.	System Simulator	R&S	CMU 200	N/A	N/A	Unshielded, 1.8 m
2.	Antenna	PulseLarsen Antennas	SPDA24617/3900	N/A	N/A	N/A
3.	Fixture	Sierra Wireless	EM DevKit	N/A	N/A	N/A

2.4 Measurement Results Explanation Example

For all conducted test items:

The offset level is set in the spectrum analyzer to compensate the RF cable loss and attenuator factor between RF conducted output port and spectrum analyzer. With the offset compensation, the spectrum analyzer reading level will be exactly the RF output level.

The spectrum analyzer offset is derived from RF cable loss and attenuator factor.

Offset = RF cable loss + attenuator factor.

The following shows an offset computation example with RF cable loss 4.2 dB and a 10 dB attenuator.

Example:

$$\begin{aligned} \text{Offset(dB)} &= \text{RF cable loss(dB)} + \text{attenuator factor(dB)} \\ &= 4.2 + 10 = 14.2 \text{ (dB)} \end{aligned}$$

2.5 Frequency List of Low/Middle/High Channels

Frequency List				
Band	Channel/Frequency(MHz)	Lowest	Middle	Highest
WCDMA Band V	Channel	4132	4182	4233
	Frequency	826.4	836.4	846.6
WCDMA Band II	Channel	9262	9400	9538
	Frequency	1852.4	1880.0	1907.6
WCDMA Band IV	Channel	1312	1413	1513
	Frequency	1712.4	1732.6	1752.6

3 Conducted Test Result

3.1 Measuring Instruments

Please refer to the measuring equipment list in this test report.

3.1.1 Test Setup

3.1.2 Conducted Output Power

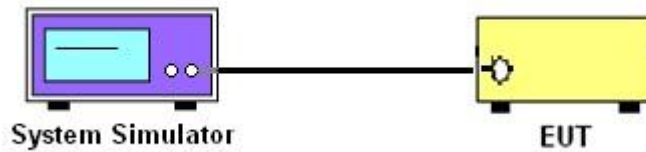

3.1.3 Peak-to-Average Ratio, Occupied Bandwidth, Conducted Band-Edge and Conducted Spurious Emission

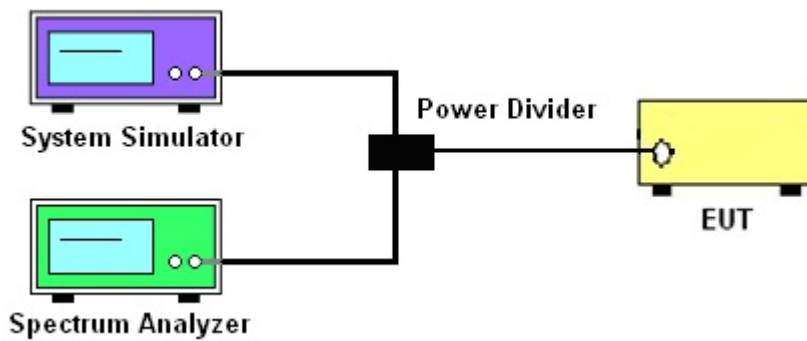

3.1.4 Frequency Stability

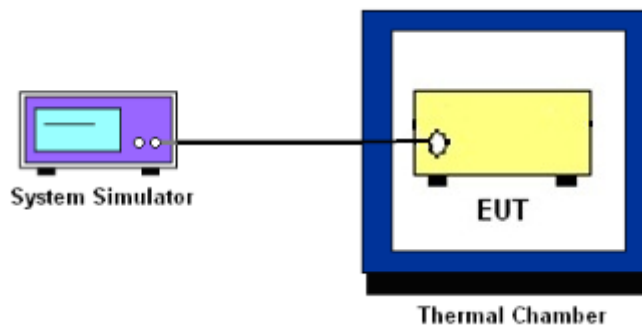

3.1.5 Test Result of Conducted Test

Please refer to Appendix A.



3.2 Conducted Output Power

3.2.1 Description of the Conducted Output Power

A system simulator was used to establish communication with the EUT. Its parameters were set to enforce EUT transmitting at the maximum power. The measured power in the radio frequency on the transmitter output terminals shall be reported.

3.2.2 Test Procedures

1. The transmitter output port is connected to the system simulator.
2. Set EUT at maximum power through system simulator.
3. Select the lowest, middle, and the highest channels for each band and different modulation.
4. Measure the maximum burst average power for GSM and maximum average power for other modulation signal.



3.3 Peak-to-Average Ratio

3.3.1 Description of the PAR Measurement

The peak-to-average ratio (PAR) of the transmission may not exceed 13 dB.

3.3.2 Test Procedures

The testing follows ANSI C63.26-2015 Section 5.2.6

1. The EUT is connected to spectrum analyzer and system simulator via a power divider.
2. Set EUT to transmit at maximum output power.
3. When the duty cycle is less than 98%, then signal gating will be implemented on the spectrum analyzer by triggering from the system simulator.
4. Set the CCDF (Complementary Cumulative Distribution Function) option of the spectrum analyzer.
5. Record the maximum PAPR level associated with a probability of 0.1%.



3.4 99% Occupied Bandwidth and 26dB Bandwidth Measurement

3.4.1 Description of 99% Occupied Bandwidth and 26dB Bandwidth Measurement

The occupied bandwidth is the width of a frequency band such that, below the lower and above the upper frequency limits, the mean powers emitted are each equal to a specified percentage 0.5% of the total mean transmitted power.

The 26 dB emission bandwidth is defined as the frequency range between two points, one above and one below the carrier frequency, at which the spectral density of the emission is attenuated 26 dB below the maximum in-band spectral density of the modulated signal. Spectral density (power per unit bandwidth) is to be measured with a detector of resolution bandwidth equal to approximately 1.0% of the emission bandwidth.

3.4.2 Test Procedures

The testing follows ANSI C63.26-2015 Section 5.4.3 (26dB) and Section 5.4.4 (99OB)

1. The EUT is connected to spectrum analyzer and system simulator via a power divider.
2. The spectrum analyzer center frequency is set to the nominal EUT channel center frequency. The span range for the spectrum analyzer shall be between two and five times the anticipated OBW.
3. The nominal resolution bandwidth (RBW) shall be in the range of 1 to 5 % of the anticipated OBW, and the VBW shall be at least 3 times the RBW.
4. Set the detection mode to peak, and the trace mode to max hold.
5. Determine the reference value: Set the EUT to transmit a modulated signal. Allow the trace to stabilize. Set the spectrum analyzer marker to the highest level of the displayed trace.
(This is the reference value)
6. Determine the “-26 dB down amplitude” as equal to (Reference Value – X).
7. Place two markers, one at the lowest and the other at the highest frequency of the envelope of the spectral display such that each marker is at or slightly below the “-X dB down amplitude” determined in step 6. If a marker is below this “-X dB down amplitude” value it shall be placed as close as possible to this value. The OBW is the positive frequency difference between the two markers.
8. Use the 99 % power bandwidth function of the spectrum analyzer and report the measured bandwidth.



3.5 Conducted Band Edge

3.5.1 Description of Conducted Band Edge Measurement

The power of any emission outside of the authorized operating frequency ranges must be lower than the transmitter power (P) by a factor of at least $43 + 10 \log (P)$ dB.

3.5.2 Test Procedures

The testing follows FCC KDB 971168 D01 v03r01 Section 6.1.

1. The EUT is connected to the spectrum analyzer and system simulator via a power divider.
2. The RF output of EUT is connected to the spectrum analyzer by an RF cable and attenuator. The path loss is compensated to the results for each measurement.
3. The band edges of low and high channels for the highest RF powers are measured.
4. The RF fundamental frequency shall be excluded against the limit line in the operating frequency band.
5. The limit line is derived from $43 + 10\log(P)$ dB below the transmitter power P(Watts)



3.6 Conducted Spurious Emission

3.6.1 Description of Conducted Spurious Emission Measurement

The power of any emission outside of the authorized operating frequency ranges must be lower than the transmitter power (P) by a factor of at least $43 + 10 \log (P)$ dB.

It is measured by means of a calibrated spectrum analyzer and scanned from 30 MHz up to a frequency including its 10th harmonic.

3.6.2 Test Procedures

The testing follows FCC KDB 971168 D01 v03r01 Section 6.1.

1. The EUT is connected to the spectrum analyzer and system simulator via a power divider.
2. The RF output of EUT is connected to the spectrum analyzer by an RF cable and attenuator. The path loss is compensated to the results for each measurement.
3. The middle channel for the highest RF power within the transmitting frequency is measured.
4. The conducted spurious emission for the whole frequency range is taken.
5. The RF fundamental frequency shall be excluded against the limit line in the operating frequency band.
6. The limit line is derived from $43 + 10\log(P)$ dB below the transmitter power P(Watts)



3.7 Frequency Stability

3.7.1 Description of Frequency Stability Measurement

22.355

The frequency stability shall be measured by variation of ambient temperature and variation of primary supply voltage to ensure that the fundamental emission stays within the authorized frequency block. The frequency stability of the transmitter shall be maintained within $\pm 0.00025\%$ ($\pm 2.5\text{ppm}$) of the center frequency.

24.235 & 27.54

The frequency stability shall be sufficient to ensure that the fundamental emission stays within the authorized frequency block.

3.7.2 Test Procedures for Temperature Variation

The testing follows FCC KDB 971168 D01 v03r01 Section 9.0.

1. The EUT is set up in the thermal chamber and connected with the system simulator.
2. With power OFF, the temperature is decreased to -30°C and the EUT is stabilized before testing. Power is applied and the maximum change in frequency is recorded within one minute.
3. With power OFF, the temperature is raised in 10°C steps up to 50°C . The EUT is stabilized at each step for at least half an hour. Power is applied and the maximum frequency change is recorded within one minute.

3.7.3 Test Procedures for Voltage Variation

The testing follows FCC KDB 971168 D01 v03r01 Section 9.0.

1. The EUT is placed in a temperature chamber at $20\pm 5^{\circ}\text{C}$ and connected with the system simulator.
2. The power supply voltage to the EUT is varied from 85% to 115% of the nominal value measured at the input to the EUT.
3. The variation in frequency is measured for the worst case.

4 Radiated Test Items

4.1 Measuring Instruments

Please refer to the measuring equipment list in this test report.

4.2 Test Setup

For radiated test below 30MHz

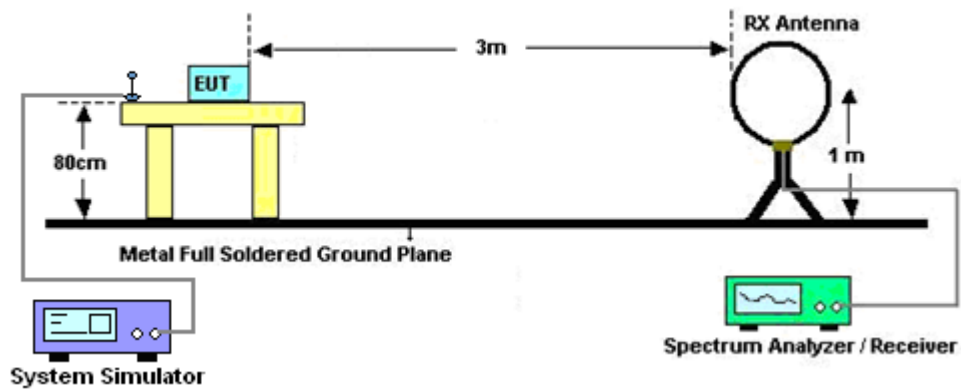

For radiated test from 30MHz to 1GHz

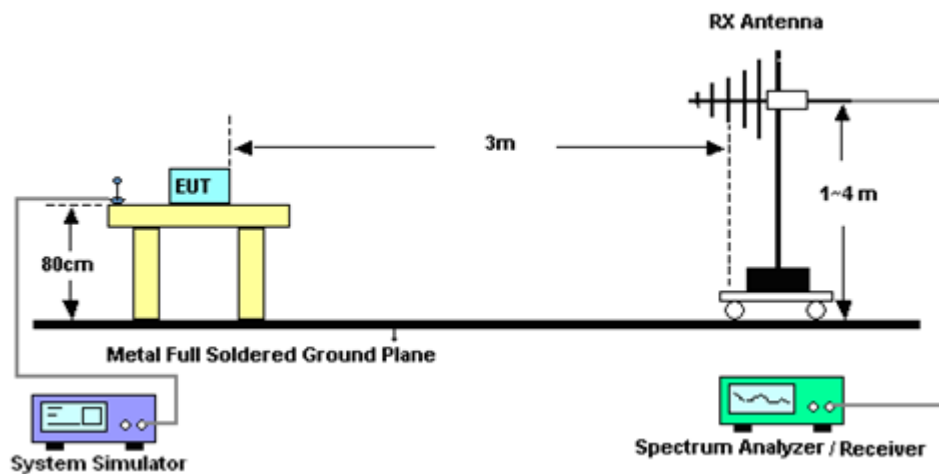

For radiated test from 1GHz to 18GHz

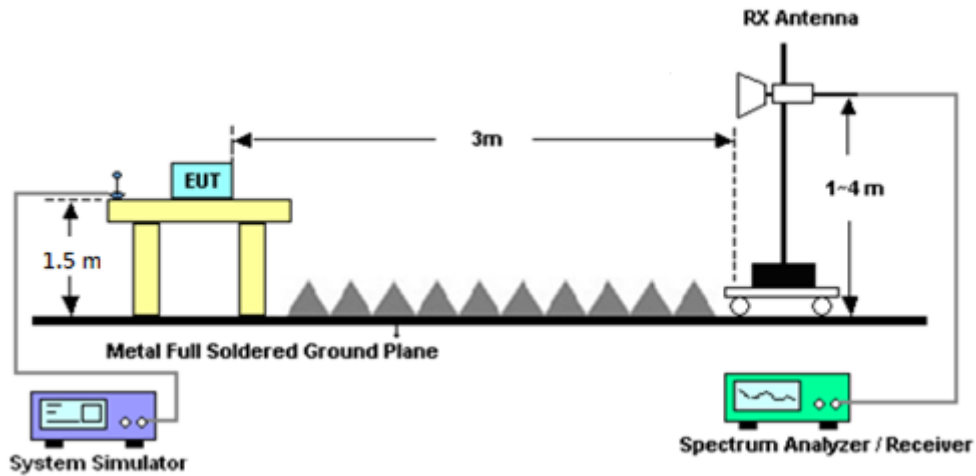

For radiated test above 18GHz

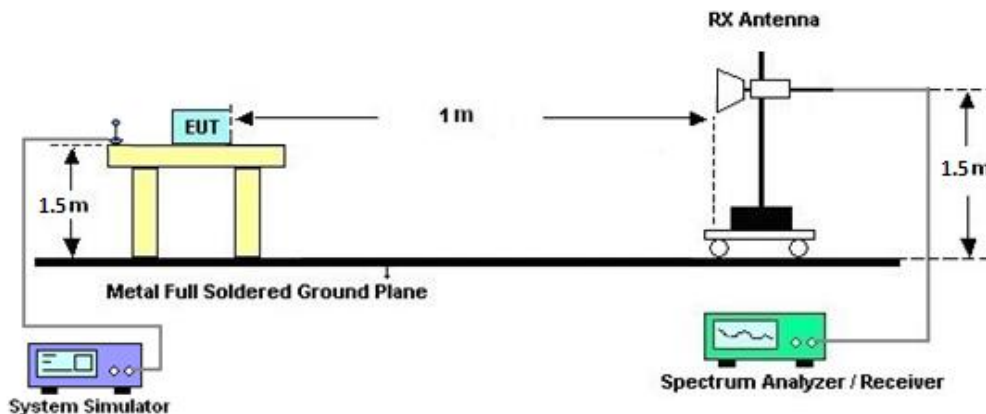

4.3 Test Result of Radiated Test

Please refer to Appendix B.

Note:

The low frequency, which starts from 9 kHz to 30 MHz, is pre-scanned and the result which is 20 dB lower than the limit line is not reported.

There is adequate comparison measurement of both open-field test site and alternative test site - semi-Anechoic chamber according to 414788 D01 Radiated Test Site v01r01, and the result came out very similar.



4.4 Field Strength of Spurious Radiation Measurement

4.4.1 Description of Field Strength of Spurious Radiated Measurement

The power of any emission outside of the authorized operating frequency ranges must be attenuated below the transmitter power (P) by a factor of at least $43 + 10 \log (P)$ dB. The spectrum is scanned from 30 MHz up to a frequency including its 10th harmonic.

4.4.2 Test Procedures

The testing follows FCC KDB 971168 D01 v03r01 Section 7 and ANSI / TIA-603-E Section 2.2.12.

1. The EUT is placed on a rotatable wooden table 0.8 meters for frequency below 1 GHz and 1.5 meter for frequency above 1 GHz above the ground.
2. The EUT is set 3 meters away from the receiving antenna, which is mounted on the antenna tower.
3. The table is rotated 360 degrees to determine the position of the highest spurious emission.
4. The height of the receiving antenna is varied between one meter and four meters to search for the maximum spurious emission for both horizontal and vertical polarizations.
5. Make the measurement with the spectrum analyzer's RBW = 1 MHz, VBW = 3 MHz, taking record of maximum spurious emission.
6. A horn antenna is substituted in place of the EUT and is driven by a signal generator.
7. Tune the output power of signal generator to the same emission level with EUT maximum spurious emission.
8. Take the record of output power at antenna port.
9. Repeat step 7 to step 8 for another polarization.
10. $EIRP \text{ (dBm)} = S.G. \text{ Power} - Tx \text{ Cable Loss} + Tx \text{ Antenna Gain}$
11. $ERP \text{ (dBm)} = EIRP - 2.15$
12. The RF fundamental frequency shall be excluded against the limit line in the operating frequency band.
13. The limit line is derived from $43 + 10\log(P)$ dB below the transmitter power P(Watts)



5 List of Measuring Equipment

Instrument	Brand Name	Model No.	Serial No.	Characteristics	Calibration Date	Test Date	Due Date	Remark
Bilog Antenna	TESEQ	CBL 6111D & 00800N1D01N-06	35419 & 03	30MHz~1GHz	Apr. 24, 2022	May 04, 2022~ May 11, 2022	Apr. 23, 2023	Radiation (03CH07-HY)
Double Ridge Horn Antenna	ESCO	3117	00075962	1GHz ~ 18GHz	Dec. 03, 2021	May 04, 2022~ May 11, 2022	Dec. 02, 2022	Radiation (03CH07-HY)
Loop Antenna	Rohde & Schwarz	HFH2-Z2	100315	9 kHz~30 MHz	Jan. 07, 2022	May 04, 2022~ May 11, 2022	Jan. 06, 2023	Radiation (03CH07-HY)
Preamplifier	MITEQ	AMF-7D-0010 1800-30-10P	1590075	1GHz~18GHz	Apr. 21, 2022	May 04, 2022~ May 11, 2022	Apr. 20, 2023	Radiation (03CH07-HY)
Preamplifier	COM-POWER	PA-103A	161241	10MHz~1GHz	Oct. 04, 2021	May 04, 2022~ May 11, 2022	Oct. 03, 2022	Radiation (03CH07-HY)
Preamplifier	Agilent	8449B	3008A02362	1GHz~26.5GHz	Oct. 04, 2021	May 04, 2022~ May 11, 2022	Oct. 03, 2022	Radiation (03CH07-HY)
Preamplifier	EMEC	EM18G40G	0600789	18-40GHz	Jul. 23, 2021	May 04, 2022~ May 11, 2022	Jul. 22, 2022	Radiation (03CH07-HY)
Spectrum Analyzer	Agilent	N9030A	MY52350276	3Hz~44GHz	Jul. 22, 2021	May 04, 2022~ May 11, 2022	Jul. 21, 2022	Radiation (03CH07-HY)
RF Cable	HUBER + SUHNER	SUCOFLEX 104	MY15682/4	30MHz to 18GHz	Feb. 23, 2022	May 04, 2022~ May 11, 2022	Feb. 22, 2023	Radiation (03CH07-HY)
RF Cable	HUBER + SUHNER	SUCOFLEX 104	MY24971/4	9kHz to 18GHz	Feb. 23, 2022	May 04, 2022~ May 11, 2022	Feb. 22, 2023	Radiation (03CH07-HY)
RF Cable	HUBER + SUHNER	SUCOFLEX 104	MY28655/4	9kHz to 18GHz	Feb. 23, 2022	May 04, 2022~ May 11, 2022	Feb. 22, 2023	Radiation (03CH07-HY)
RF Cable	HUBER + SUHNER	SUCOFLEX 126	532078/126E	30MHz~18GHz	Sep. 17, 2021	May 04, 2022~ May 11, 2022	Sep. 16, 2022	Radiation (03CH07-HY)
RF Cable	HUBER + SUHNER	SUCOFLEX 102	MY2858/2	18GHz~40GHz	Feb. 23, 2022	May 04, 2022~ May 11, 2022	Feb. 22, 2023	Radiation (03CH07-HY)
Controller	EMEC	EM1000	N/A	Control Ant Mast	N/A	May 04, 2022~ May 11, 2022	N/A	Radiation (03CH07-HY)
Controller	MF	MF-7802	N/A	Control Turn table	N/A	May 04, 2022~ May 11, 2022	N/A	Radiation (03CH07-HY)
Antenna Mast	EMEC	AM-BS-4500E	N/A	Boresight mast 1M~4M	N/A	May 04, 2022~ May 11, 2022	N/A	Radiation (03CH07-HY)
Turn Table	ChainTek	Chaintek 3000	N/A	0~360 Degree	N/A	May 04, 2022~ May 11, 2022	N/A	Radiation (03CH07-HY)
Software	Audix	E3	N/A	N/A	N/A	May 04, 2022~ May 11, 2022	N/A	Radiation (03CH07-HY)
USB Data Logger	TECPEL	TR-32	HE17XB2495	N/A	Mar. 07, 2022	May 04, 2022~ May 11, 2022	Mar. 06, 2023	Radiation (03CH07-HY)
Horn Antenna	EMCO	3117	00143261	1GHz~18GHz	Feb. 11, 2022	May 04, 2022~ May 11, 2022	Feb. 10, 2023	Radiation (03CH07-HY)
SHF-EHF Horn Antenna	SCHWARZBECK	BBHA 9170	BBHA9170251	18GHz~40GHz	Nov. 30, 2021	May 04, 2022~ May 11, 2022	Nov. 29, 2022	Radiation (03CH07-HY)
Signal Generator	Rohde & Schwarz	SMF100A	101107	100kHz~40GHz	Dec. 08, 2021	May 04, 2022~ May 11, 2022	Dec. 07, 2022	Radiation (03CH07-HY)



Instrument	Brand Name	Model No.	Serial No.	Characteristics	Calibration Date	Test Date	Due Date	Remark
Hygrometer	TECPEL	DTM-303B	TP210073	N/A	Nov. 16, 2021	May 04, 2022	Nov. 15, 2022	Conducted (TH03-HY)
Spectrum Analyzer	Rohde & Schwarz	FSP30	101329	9kHz~30GHz	Sep. 30, 2021	May 04, 2022	Sep. 29, 2022	Conducted (TH03-HY)
Temperature & Humidity Cabinet Chamber	ESPEC	LHU-113	1012005860	-20°C~85°C	Dec. 09, 2021	May 04, 2022	Dec. 08, 2022	Conducted (TH03-HY)
Programmable Power Supply	GW Instek	PSS-2005	EL890001	1V~20V 0.5A~4A	Oct. 06, 2021	May 04, 2022	Oct. 05, 2022	Conducted (TH03-HY)
Base Station (Measure)	Rohde & Schwarz	CMU200	117995	GSM / GPRS / WCDMA / CDMA	Jul. 13, 2021	May 04, 2022	Jul. 12, 2022	Conducted (TH03-HY)
Power Divider	Warison	WCOU-0.4-26.5S-20	#A	N/A	Nov. 01, 2021	May 04, 2022	Oct. 31, 2022	Conducted (TH03-HY)



6 Uncertainty of Evaluation

Uncertainty of Radiated Emission Measurement (30 MHz ~ 1000 MHz)

Measuring Uncertainty for a Level of Confidence of 95% ($U = 2Uc(y)$)	3.16 dB
---	---------

Uncertainty of Radiated Emission Measurement (1 GHz ~ 18 GHz)

Measuring Uncertainty for a Level of Confidence of 95% ($U = 2Uc(y)$)	3.71 dB
---	---------

Uncertainty of Radiated Emission Measurement (18 GHz ~ 40 GHz)

Measuring Uncertainty for a Level of Confidence of 95% ($U = 2Uc(y)$)	4.16 dB
---	---------



Appendix A. Test Results of Conducted Test

Conducted Output Power(Average power)					
WCDMA Band V Maximum Average Power [dBm]					
Channel	4132	4182	4233	Maximum Output Power (dBm)	Maximum Output Power (W)
Frequency	826.4	836.4	846.6		
RMC 12.2K	23.33	23.30	23.14	23.33	0.2153
HSDPA Subtest-1	22.32	22.25	22.18		
HSDPA Subtest-2	22.26	22.20	22.03		
HSDPA Subtest-3	21.75	21.76	21.53		
HSDPA Subtest-4	21.82	21.71	21.53		
HSUPA Subtest-1	21.71	21.68	20.48		
HSUPA Subtest-2	19.74	17.68	19.22		
HSUPA Subtest-3	20.74	18.47	20.30		
HSUPA Subtest-4	19.73	19.73	19.91		
HSUPA Subtest-5	21.80	21.70	22.13		
WCDMA Band II Maximum Average Power [dBm]					
Channel	9262	9400	9538	Maximum Output Power (dBm)	Maximum Output Power (W)
Frequency	1852.4	1880	1907.6		
RMC 12.2K	22.90	23.15	23.28	23.28	0.2128
HSDPA Subtest-1	21.89	22.05	22.32		
HSDPA Subtest-2	21.83	22.01	22.32		
HSDPA Subtest-3	21.36	21.61	21.80		
HSDPA Subtest-4	21.36	21.49	21.77		
HSUPA Subtest-1	21.89	21.84	22.14		
HSUPA Subtest-2	19.81	19.80	20.07		
HSUPA Subtest-3	20.84	20.69	21.10		
HSUPA Subtest-4	19.90	19.82	20.18		
HSUPA Subtest-5	21.60	21.80	21.90		
WCDMA Band IV Maximum Average Power [dBm]					
Channel	1312	1413	1513	Maximum Output Power (dBm)	Maximum Output Power (W)
Frequency	1712.4	1732.6	1752.6		
RMC 12.2K	23.30	23.51	23.66	23.66	0.2323
HSDPA Subtest-1	22.27	22.53	22.51		
HSDPA Subtest-2	22.23	22.55	22.52		
HSDPA Subtest-3	21.75	22.05	21.78		
HSDPA Subtest-4	21.73	21.98	22.10		
HSUPA Subtest-1	22.04	22.23	22.05		
HSUPA Subtest-2	20.03	20.27	19.95		
HSUPA Subtest-3	21.03	21.28	21.00		
HSUPA Subtest-4	20.01	20.31	20.14		
HSUPA Subtest-5	21.80	22.20	22.20		



A2. WCDMA

Peak-to-Average Ratio

Mode	WCDMA Band V	WCDMA Band II	WCDMA Band IV	Limit: 13dB
Mod.	RMC 12.2Kbps	RMC 12.2Kbps	RMC 12.2Kbps	Result
Lowest CH	3.08	3.04	2.72	PASS
Middle CH	2.96	3.12	2.72	
Highest CH	2.92	3.48	2.80	

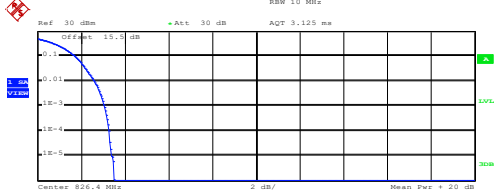
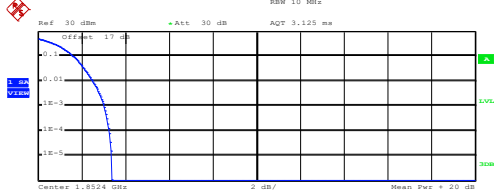
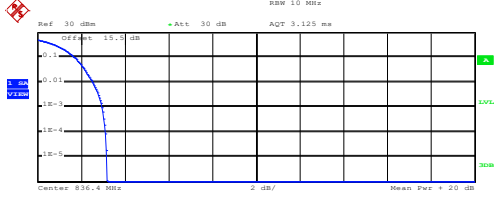
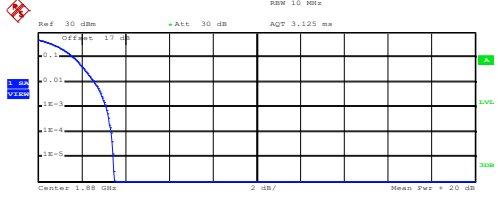
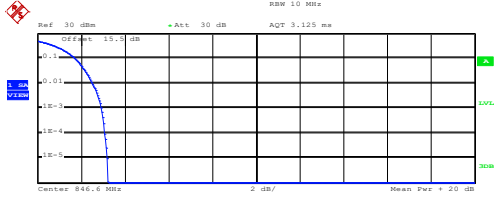
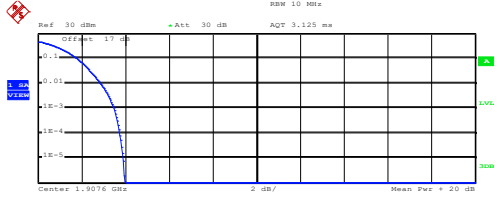

WCDMA Band V (RMC 12.2Kbps)	WCDMA Band II (RMC 12.2Kbps)
<p style="text-align: center;">Lowest Channel</p>  <p>Center: 826.4 MHz</p> <p>Complementary Cumulative Distribution Function (100000 samples)</p> <p>Trace 1</p> <p>Mean 23.28 dBm Peak 26.79 dBm Crest 3.52 dB</p> <p>10 % 1.72 dB 1 % 2.60 dB .1 % 3.08 dB .01 % 3.28 dB</p> <p>Date: 4.MAY.2022 11:02:54</p>	<p style="text-align: center;">Lowest Channel</p>  <p>Center: 1.8524 GHz</p> <p>Complementary Cumulative Distribution Function (100000 samples)</p> <p>Trace 1</p> <p>Mean 22.70 dBm Peak 26.09 dBm Crest 3.39 dB</p> <p>10 % 1.64 dB 1 % 2.52 dB .1 % 3.04 dB .01 % 3.28 dB</p> <p>Date: 4.MAY.2022 10:19:06</p>
<p style="text-align: center;">Middle Channel</p>  <p>Center: 826.4 MHz</p> <p>Complementary Cumulative Distribution Function (100000 samples)</p> <p>Trace 1</p> <p>Mean 23.28 dBm Peak 26.44 dBm Crest 3.16 dB</p> <p>10 % 1.72 dB 1 % 2.52 dB .1 % 2.96 dB .01 % 3.12 dB</p> <p>Date: 4.MAY.2022 11:03:13</p>	<p style="text-align: center;">Middle Channel</p>  <p>Center: 1.88 GHz</p> <p>Complementary Cumulative Distribution Function (100000 samples)</p> <p>Trace 1</p> <p>Mean 22.96 dBm Peak 26.44 dBm Crest 3.48 dB</p> <p>10 % 1.64 dB 1 % 2.60 dB .1 % 3.12 dB .01 % 3.36 dB</p> <p>Date: 4.MAY.2022 10:19:31</p>
<p style="text-align: center;">Highest Channel</p>  <p>Center: 846.6 MHz</p> <p>Complementary Cumulative Distribution Function (100000 samples)</p> <p>Trace 1</p> <p>Mean 23.08 dBm Peak 26.30 dBm Crest 3.22 dB</p> <p>10 % 1.72 dB 1 % 2.52 dB .1 % 2.92 dB .01 % 3.08 dB</p> <p>Date: 4.MAY.2022 11:03:31</p>	<p style="text-align: center;">Highest Channel</p>  <p>Center: 1.9076 GHz</p> <p>Complementary Cumulative Distribution Function (100000 samples)</p> <p>Trace 1</p> <p>Mean 23.11 dBm Peak 27.08 dBm Crest 3.97 dB</p> <p>10 % 1.80 dB 1 % 2.88 dB .1 % 3.48 dB .01 % 3.76 dB</p> <p>Date: 4.MAY.2022 10:19:51</p>



WCDMA Band IV (RMC 12.2Kbps)

Lowest Channel

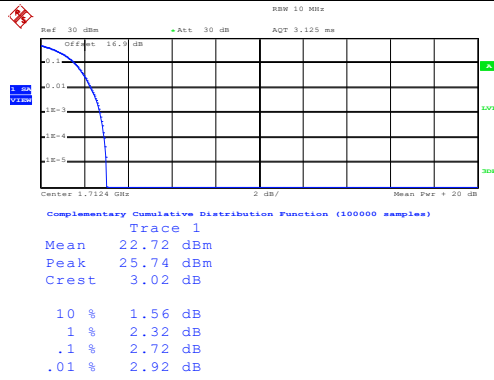

Middle Channel

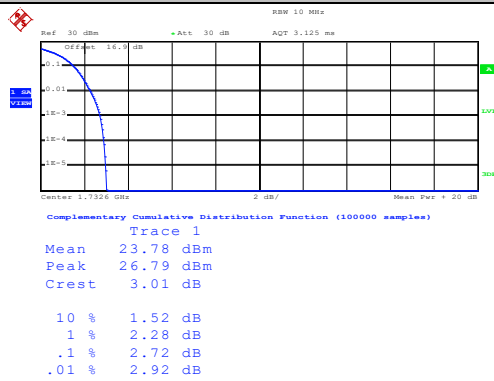

Highest Channel

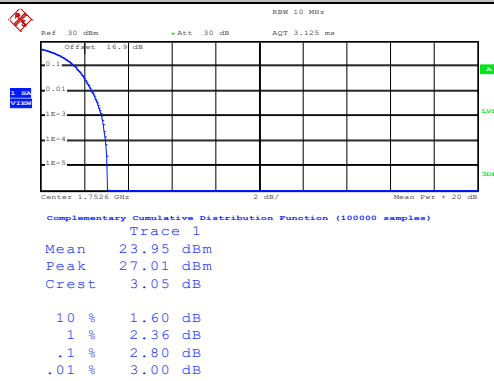



26dB Bandwidth

Mode	WCDMA Band V 26dB BW (MHz)	WCDMA Band II 26dB BW (MHz)	WCDMA Band IV 26dB BW (MHz)
Mod.	RMC 12.2Kbps	RMC 12.2Kbps	RMC 12.2Kbps
Lowest CH	4.69	4.74	4.75
Middle CH	4.71	4.72	4.77
Highest CH	4.71	4.72	4.76

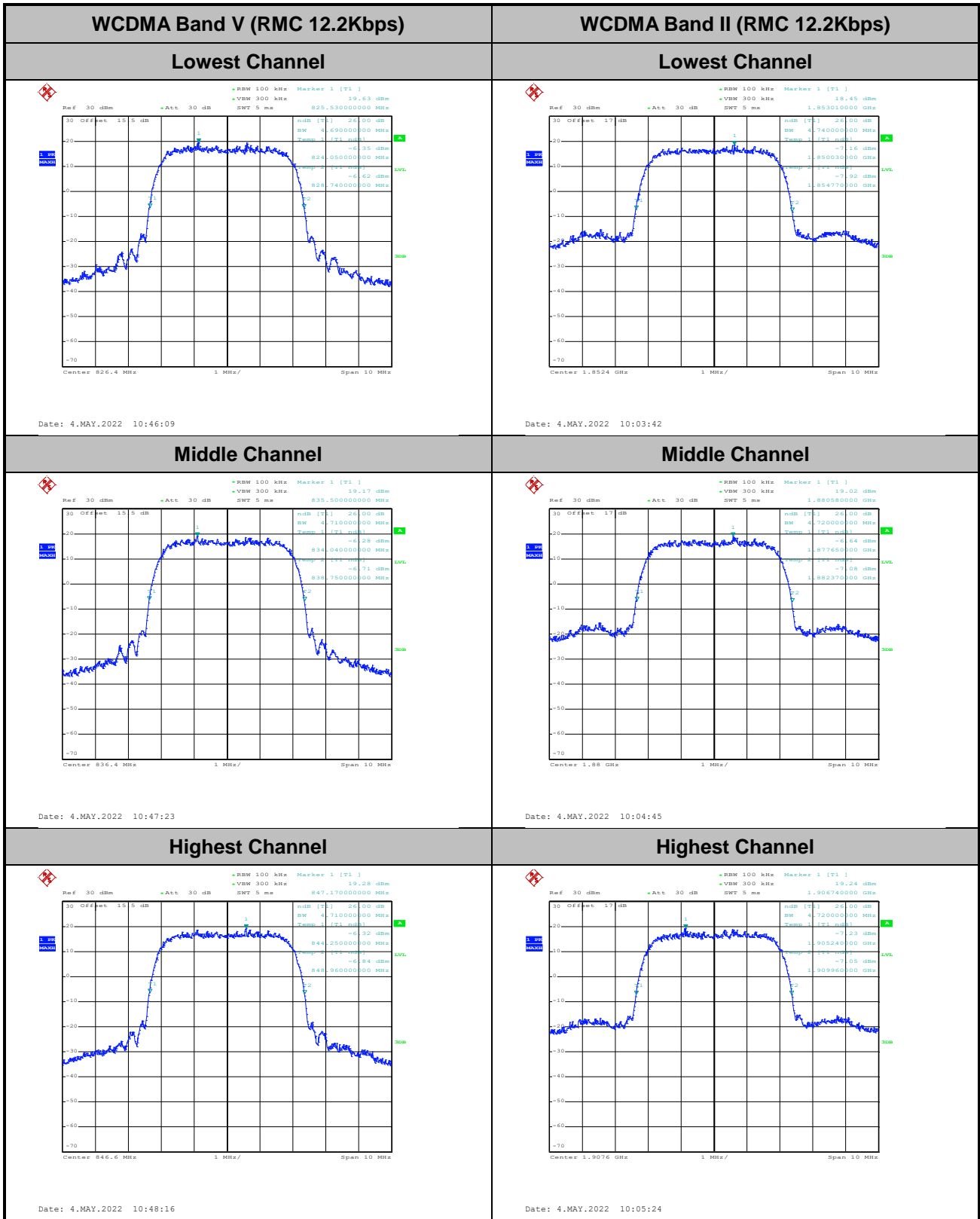



WCDMA Band IV (RMC 12.2Kbps)

Lowest Channel

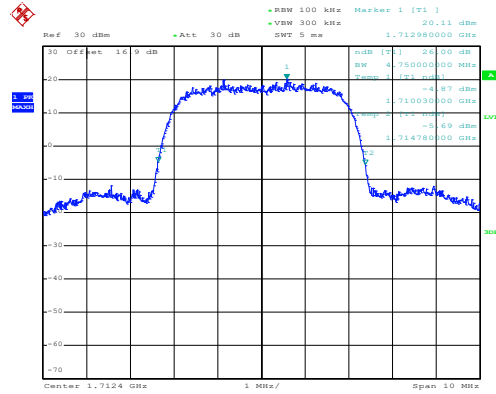

Date: 4.MAY.2022 10:21:38

Middle Channel

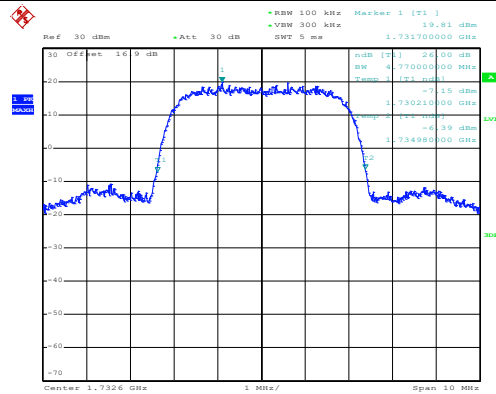

Date: 4.MAY.2022 10:22:17

Highest Channel

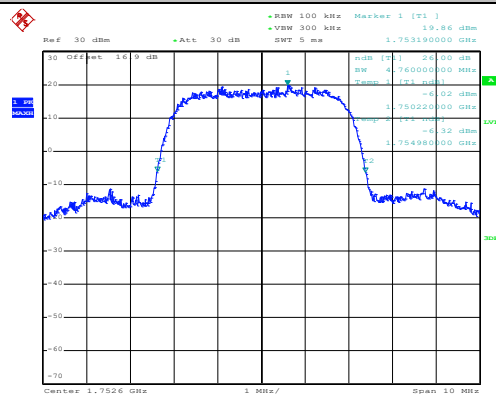

Date: 4.MAY.2022 10:22:58



Occupied Bandwidth

Mode	WCDMA Band V 99% OBW (MHz)	WCDMA Band II 99% OBW (MHz)	WCDMA Band IV 99% OBW (MHz)
Mod.	RMC 12.2Kbps	RMC 12.2Kbps	RMC 12.2Kbps
Lowest CH	4.13	4.15	4.15
Middle CH	4.14	4.14	4.17
Highest CH	4.13	4.15	4.17



WCDMA Band V (RMC 12.2Kbps)	WCDMA Band II (RMC 12.2Kbps)
<p style="text-align: center;">Lowest Channel</p> <p style="font-size: small;">Ref: 30 dBm, Att: 30 dB, RBW: 100 kHz, VBW: 300 kHz, SWT: 5 ms, Marker 1: [T1] 15.40 dBm, OSW: 4.15000000 MHz, Temp: 1 [T1] OSW, #24.33000000 MHz, #24.46000000 MHz, LVL: 20m, 30m</p> <p style="font-size: x-small;">Date: 4.MAY.2022 10:53:25</p>	<p style="text-align: center;">Lowest Channel</p> <p style="font-size: small;">Ref: 30 dBm, Att: 30 dB, RBW: 100 kHz, VBW: 300 kHz, SWT: 5 ms, Marker 1: [T1] 18.77 dBm, OSW: 4.15000000 MHz, Temp: 1 [T1] OSW, #24.33000000 MHz, #24.46000000 MHz, LVL: 20m, 30m</p> <p style="font-size: x-small;">Date: 4.MAY.2022 10:09:52</p>
<p style="text-align: center;">Middle Channel</p> <p style="font-size: small;">Ref: 30 dBm, Att: 30 dB, RBW: 100 kHz, VBW: 300 kHz, SWT: 5 ms, Marker 1: [T1] 19.20 dBm, OSW: 4.14000000 MHz, Temp: 1 [T1] OSW, #24.32000000 MHz, #24.46000000 MHz, LVL: 20m, 30m</p> <p style="font-size: x-small;">Date: 4.MAY.2022 10:54:05</p>	<p style="text-align: center;">Middle Channel</p> <p style="font-size: small;">Ref: 30 dBm, Att: 30 dB, RBW: 100 kHz, VBW: 300 kHz, SWT: 5 ms, Marker 1: [T1] 18.84 dBm, OSW: 4.14000000 MHz, Temp: 1 [T1] OSW, #24.32000000 MHz, #24.46000000 MHz, LVL: 20m, 30m</p> <p style="font-size: x-small;">Date: 4.MAY.2022 10:10:28</p>
<p style="text-align: center;">Highest Channel</p> <p style="font-size: small;">Ref: 30 dBm, Att: 30 dB, RBW: 100 kHz, VBW: 300 kHz, SWT: 5 ms, Marker 1: [T1] 19.35 dBm, OSW: 4.15000000 MHz, Temp: 1 [T1] OSW, #24.33000000 MHz, #24.46000000 MHz, LVL: 20m, 30m</p> <p style="font-size: x-small;">Date: 4.MAY.2022 10:55:12</p>	<p style="text-align: center;">Highest Channel</p> <p style="font-size: small;">Ref: 30 dBm, Att: 30 dB, RBW: 100 kHz, VBW: 300 kHz, SWT: 5 ms, Marker 1: [T1] 19.07 dBm, OSW: 4.15000000 MHz, Temp: 1 [T1] OSW, #24.33000000 MHz, #24.46000000 MHz, LVL: 20m, 30m</p> <p style="font-size: x-small;">Date: 4.MAY.2022 10:11:08</p>



WCDMA Band IV (RMC 12.2Kbps)

Lowest Channel

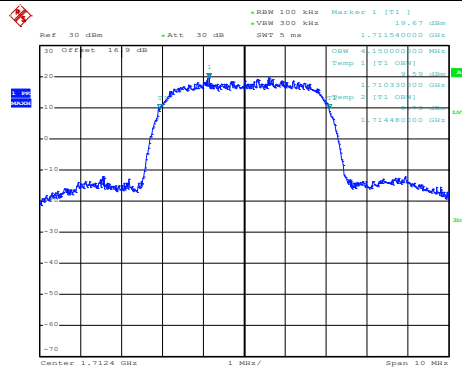

Date: 4.MAY.2022 10:28:01

Middle Channel

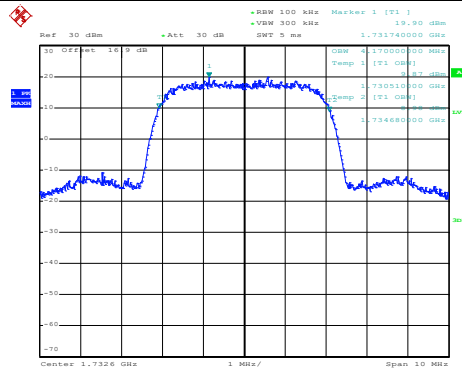

Date: 4.MAY.2022 10:28:46

Highest Channel

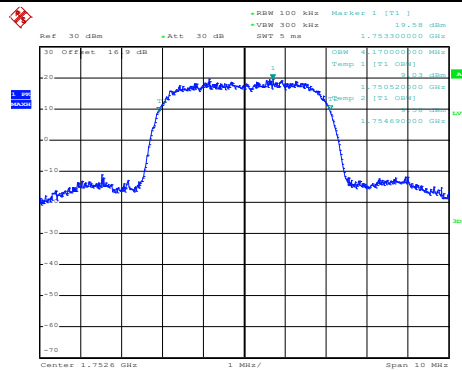

Date: 4.MAY.2022 10:30:03



Conducted Band Edge

WCDMA Band V (RMC 12.2Kbps)

Lowest Band Edge

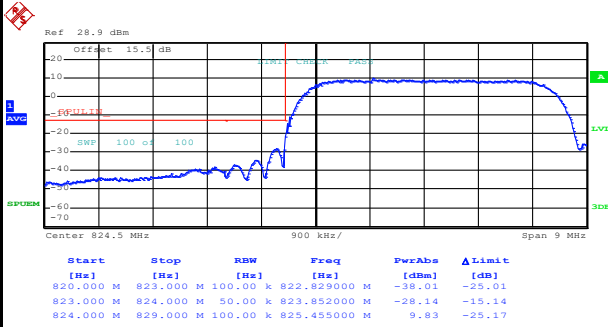

Date: 4.MAY.2022 10:58:20

Highest Band Edge

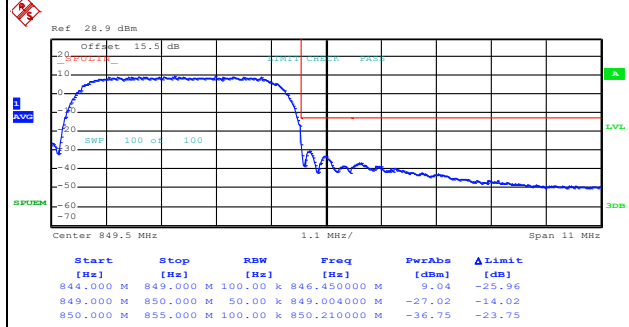

Date: 4.MAY.2022 11:01:19



WCDMA Band II (RMC 12.2Kbps)

Lowest Band Edge

Highest Band Edge

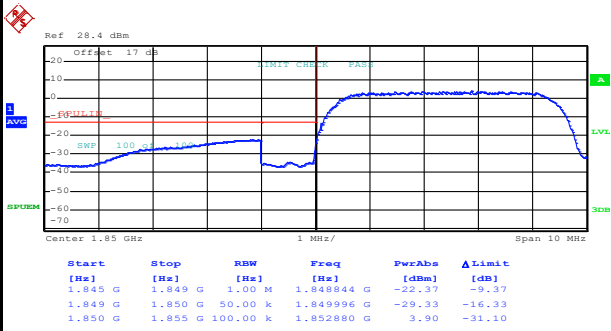

Date: 4.MAY.2022 10:41:33

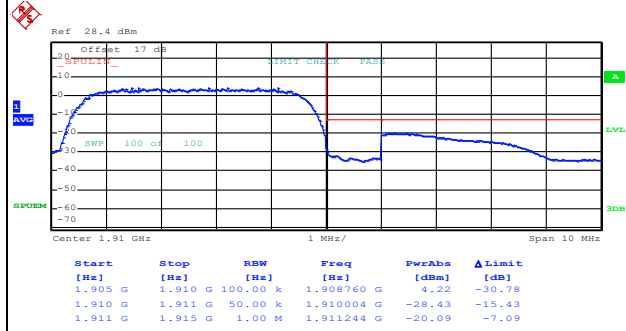

Date: 4.MAY.2022 10:44:30



WCDMA Band IV (RMC 12.2Kbps)

Lowest Band Edge

Highest Band Edge

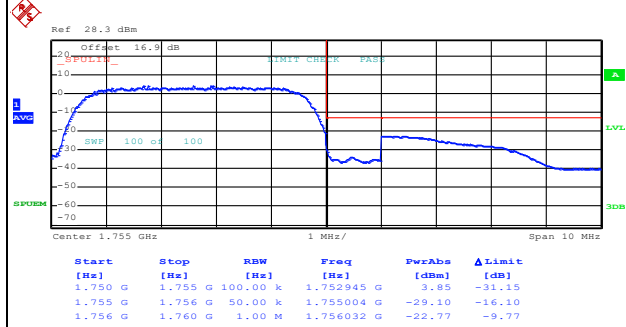
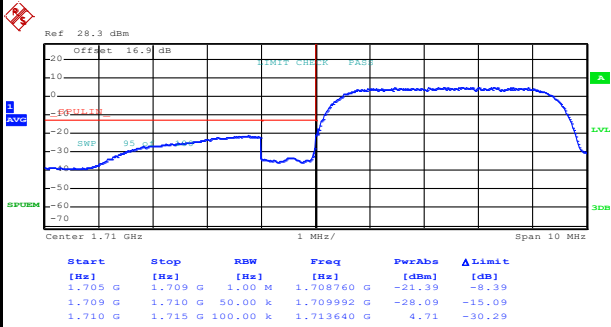

Date: 4.MAY.2022 10:33:11

Date: 4.MAY.2022 10:36:13

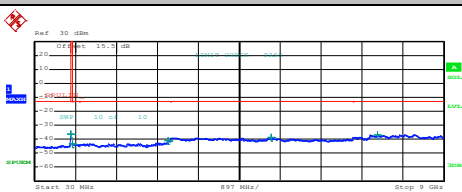
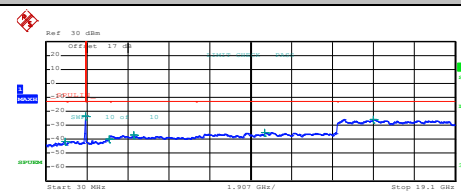
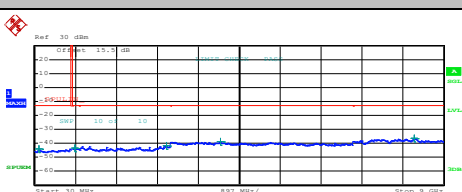
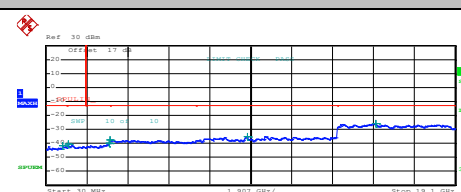
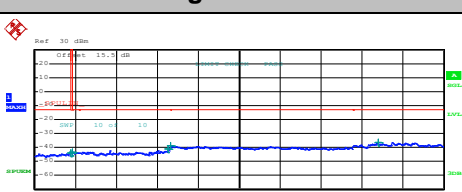
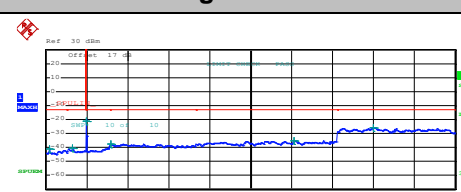

Conducted Spurious Emission

WCDMA Band V (RMC 12.2Kbps)	WCDMA Band II (RMC 12.2Kbps)																																																																														
Lowest Channel	Lowest Channel																																																																														
 <table border="1"> <thead> <tr> <th>Start [Hz]</th> <th>Stop [Hz]</th> <th>RBW [Hz]</th> <th>Freq [Hz]</th> <th>PerAbs [dBm]</th> <th>ΔLimit [dB]</th> </tr> </thead> <tbody> <tr> <td>35,000 M</td> <td>820,000 M</td> <td>1,00 M</td> <td>818,017500 M</td> <td>-36.37</td> <td>-23.37</td> </tr> <tr> <td>830,000 M</td> <td>1,000 G</td> <td>1,00 M</td> <td>818,088700 M</td> <td>-43.33</td> <td>-30.33</td> </tr> <tr> <td>1,000 G</td> <td>3,000 G</td> <td>1,00 M</td> <td>2,963000 G</td> <td>-41.12</td> <td>-28.12</td> </tr> <tr> <td>3,000 G</td> <td>7,000 G</td> <td>1,00 M</td> <td>5,216000 G</td> <td>-38.98</td> <td>-25.98</td> </tr> <tr> <td>7,000 G</td> <td>9,000 G</td> <td>1,00 M</td> <td>7,943000 G</td> <td>-36.73</td> <td>-23.73</td> </tr> </tbody> </table> <p>Date: 4.MAY.2022 10:49:57</p>	Start [Hz]	Stop [Hz]	RBW [Hz]	Freq [Hz]	PerAbs [dBm]	ΔLimit [dB]	35,000 M	820,000 M	1,00 M	818,017500 M	-36.37	-23.37	830,000 M	1,000 G	1,00 M	818,088700 M	-43.33	-30.33	1,000 G	3,000 G	1,00 M	2,963000 G	-41.12	-28.12	3,000 G	7,000 G	1,00 M	5,216000 G	-38.98	-25.98	7,000 G	9,000 G	1,00 M	7,943000 G	-36.73	-23.73	 <table border="1"> <thead> <tr> <th>Start [Hz]</th> <th>Stop [Hz]</th> <th>RBW [Hz]</th> <th>Freq [Hz]</th> <th>PerAbs [dBm]</th> <th>ΔLimit [dB]</th> </tr> </thead> <tbody> <tr> <td>30,000 M</td> <td>1,000 G</td> <td>1,00 M</td> <td>889,662500 M</td> <td>-41.53</td> <td>-28.53</td> </tr> <tr> <td>1,000 G</td> <td>3,845 G</td> <td>1,00 M</td> <td>3,844789 G</td> <td>-23.65</td> <td>-10.65</td> </tr> <tr> <td>1,915 G</td> <td>3,000 G</td> <td>1,00 M</td> <td>2,979385 G</td> <td>-40.01</td> <td>-27.01</td> </tr> <tr> <td>3,000 G</td> <td>7,000 G</td> <td>1,00 M</td> <td>4,093000 G</td> <td>-36.87</td> <td>-23.87</td> </tr> <tr> <td>7,000 G</td> <td>13,600 G</td> <td>1,00 M</td> <td>10,222400 G</td> <td>-35.13</td> <td>-22.13</td> </tr> <tr> <td>13,600 G</td> <td>19,100 G</td> <td>1,00 M</td> <td>15,296603 G</td> <td>-25.78</td> <td>-12.78</td> </tr> </tbody> </table> <p>Date: 4.MAY.2022 10:07:09</p>	Start [Hz]	Stop [Hz]	RBW [Hz]	Freq [Hz]	PerAbs [dBm]	ΔLimit [dB]	30,000 M	1,000 G	1,00 M	889,662500 M	-41.53	-28.53	1,000 G	3,845 G	1,00 M	3,844789 G	-23.65	-10.65	1,915 G	3,000 G	1,00 M	2,979385 G	-40.01	-27.01	3,000 G	7,000 G	1,00 M	4,093000 G	-36.87	-23.87	7,000 G	13,600 G	1,00 M	10,222400 G	-35.13	-22.13	13,600 G	19,100 G	1,00 M	15,296603 G	-25.78	-12.78
Start [Hz]	Stop [Hz]	RBW [Hz]	Freq [Hz]	PerAbs [dBm]	ΔLimit [dB]																																																																										
35,000 M	820,000 M	1,00 M	818,017500 M	-36.37	-23.37																																																																										
830,000 M	1,000 G	1,00 M	818,088700 M	-43.33	-30.33																																																																										
1,000 G	3,000 G	1,00 M	2,963000 G	-41.12	-28.12																																																																										
3,000 G	7,000 G	1,00 M	5,216000 G	-38.98	-25.98																																																																										
7,000 G	9,000 G	1,00 M	7,943000 G	-36.73	-23.73																																																																										
Start [Hz]	Stop [Hz]	RBW [Hz]	Freq [Hz]	PerAbs [dBm]	ΔLimit [dB]																																																																										
30,000 M	1,000 G	1,00 M	889,662500 M	-41.53	-28.53																																																																										
1,000 G	3,845 G	1,00 M	3,844789 G	-23.65	-10.65																																																																										
1,915 G	3,000 G	1,00 M	2,979385 G	-40.01	-27.01																																																																										
3,000 G	7,000 G	1,00 M	4,093000 G	-36.87	-23.87																																																																										
7,000 G	13,600 G	1,00 M	10,222400 G	-35.13	-22.13																																																																										
13,600 G	19,100 G	1,00 M	15,296603 G	-25.78	-12.78																																																																										
Middle Channel	Middle Channel																																																																														
 <table border="1"> <thead> <tr> <th>Start [Hz]</th> <th>Stop [Hz]</th> <th>RBW [Hz]</th> <th>Freq [Hz]</th> <th>PerAbs [dBm]</th> <th>ΔLimit [dB]</th> </tr> </thead> <tbody> <tr> <td>35,000 M</td> <td>820,000 M</td> <td>1,00 M</td> <td>818,017500 M</td> <td>-43.90</td> <td>-30.90</td> </tr> <tr> <td>830,000 M</td> <td>1,000 G</td> <td>1,00 M</td> <td>909,483754 M</td> <td>-43.16</td> <td>-30.16</td> </tr> <tr> <td>1,000 G</td> <td>3,000 G</td> <td>1,00 M</td> <td>2,928000 G</td> <td>-42.78</td> <td>-29.78</td> </tr> <tr> <td>3,000 G</td> <td>7,000 G</td> <td>1,00 M</td> <td>4,100000 G</td> <td>-38.44</td> <td>-25.44</td> </tr> <tr> <td>7,000 G</td> <td>9,000 G</td> <td>1,00 M</td> <td>8,357500 G</td> <td>-36.56</td> <td>-23.56</td> </tr> </tbody> </table> <p>Date: 4.MAY.2022 10:51:37</p>	Start [Hz]	Stop [Hz]	RBW [Hz]	Freq [Hz]	PerAbs [dBm]	ΔLimit [dB]	35,000 M	820,000 M	1,00 M	818,017500 M	-43.90	-30.90	830,000 M	1,000 G	1,00 M	909,483754 M	-43.16	-30.16	1,000 G	3,000 G	1,00 M	2,928000 G	-42.78	-29.78	3,000 G	7,000 G	1,00 M	4,100000 G	-38.44	-25.44	7,000 G	9,000 G	1,00 M	8,357500 G	-36.56	-23.56	 <table border="1"> <thead> <tr> <th>Start [Hz]</th> <th>Stop [Hz]</th> <th>RBW [Hz]</th> <th>Freq [Hz]</th> <th>PerAbs [dBm]</th> <th>ΔLimit [dB]</th> </tr> </thead> <tbody> <tr> <td>30,000 M</td> <td>1,000 G</td> <td>1,00 M</td> <td>799,650000 M</td> <td>-41.54</td> <td>-28.54</td> </tr> <tr> <td>1,000 G</td> <td>1,845 G</td> <td>1,00 M</td> <td>1,047320 G</td> <td>-40.67</td> <td>-27.67</td> </tr> <tr> <td>1,915 G</td> <td>3,000 G</td> <td>1,00 M</td> <td>2,967992 G</td> <td>-40.83</td> <td>-27.83</td> </tr> <tr> <td>3,000 G</td> <td>7,000 G</td> <td>1,00 M</td> <td>3,016000 G</td> <td>-37.46</td> <td>-24.46</td> </tr> <tr> <td>7,000 G</td> <td>13,600 G</td> <td>1,00 M</td> <td>9,415600 G</td> <td>-35.24</td> <td>-22.24</td> </tr> <tr> <td>13,600 G</td> <td>19,100 G</td> <td>1,00 M</td> <td>15,390250 G</td> <td>-25.65</td> <td>-12.65</td> </tr> </tbody> </table> <p>Date: 4.MAY.2022 10:08:05</p>	Start [Hz]	Stop [Hz]	RBW [Hz]	Freq [Hz]	PerAbs [dBm]	ΔLimit [dB]	30,000 M	1,000 G	1,00 M	799,650000 M	-41.54	-28.54	1,000 G	1,845 G	1,00 M	1,047320 G	-40.67	-27.67	1,915 G	3,000 G	1,00 M	2,967992 G	-40.83	-27.83	3,000 G	7,000 G	1,00 M	3,016000 G	-37.46	-24.46	7,000 G	13,600 G	1,00 M	9,415600 G	-35.24	-22.24	13,600 G	19,100 G	1,00 M	15,390250 G	-25.65	-12.65
Start [Hz]	Stop [Hz]	RBW [Hz]	Freq [Hz]	PerAbs [dBm]	ΔLimit [dB]																																																																										
35,000 M	820,000 M	1,00 M	818,017500 M	-43.90	-30.90																																																																										
830,000 M	1,000 G	1,00 M	909,483754 M	-43.16	-30.16																																																																										
1,000 G	3,000 G	1,00 M	2,928000 G	-42.78	-29.78																																																																										
3,000 G	7,000 G	1,00 M	4,100000 G	-38.44	-25.44																																																																										
7,000 G	9,000 G	1,00 M	8,357500 G	-36.56	-23.56																																																																										
Start [Hz]	Stop [Hz]	RBW [Hz]	Freq [Hz]	PerAbs [dBm]	ΔLimit [dB]																																																																										
30,000 M	1,000 G	1,00 M	799,650000 M	-41.54	-28.54																																																																										
1,000 G	1,845 G	1,00 M	1,047320 G	-40.67	-27.67																																																																										
1,915 G	3,000 G	1,00 M	2,967992 G	-40.83	-27.83																																																																										
3,000 G	7,000 G	1,00 M	3,016000 G	-37.46	-24.46																																																																										
7,000 G	13,600 G	1,00 M	9,415600 G	-35.24	-22.24																																																																										
13,600 G	19,100 G	1,00 M	15,390250 G	-25.65	-12.65																																																																										
Highest Channel	Highest Channel																																																																														
 <table border="1"> <thead> <tr> <th>Start [Hz]</th> <th>Stop [Hz]</th> <th>RBW [Hz]</th> <th>Freq [Hz]</th> <th>PerAbs [dBm]</th> <th>ΔLimit [dB]</th> </tr> </thead> <tbody> <tr> <td>35,000 M</td> <td>820,000 M</td> <td>1,00 M</td> <td>812,492500 M</td> <td>-44.06</td> <td>-31.06</td> </tr> <tr> <td>830,000 M</td> <td>1,000 G</td> <td>1,00 M</td> <td>843,492000 M</td> <td>-43.33</td> <td>-30.33</td> </tr> <tr> <td>1,000 G</td> <td>3,000 G</td> <td>1,00 M</td> <td>2,959000 G</td> <td>-40.96</td> <td>-27.96</td> </tr> <tr> <td>3,000 G</td> <td>7,000 G</td> <td>1,00 M</td> <td>3,011000 G</td> <td>-38.98</td> <td>-25.98</td> </tr> <tr> <td>7,000 G</td> <td>9,000 G</td> <td>1,00 M</td> <td>7,960000 G</td> <td>-36.45</td> <td>-23.45</td> </tr> </tbody> </table> <p>Date: 4.MAY.2022 10:52:39</p>	Start [Hz]	Stop [Hz]	RBW [Hz]	Freq [Hz]	PerAbs [dBm]	ΔLimit [dB]	35,000 M	820,000 M	1,00 M	812,492500 M	-44.06	-31.06	830,000 M	1,000 G	1,00 M	843,492000 M	-43.33	-30.33	1,000 G	3,000 G	1,00 M	2,959000 G	-40.96	-27.96	3,000 G	7,000 G	1,00 M	3,011000 G	-38.98	-25.98	7,000 G	9,000 G	1,00 M	7,960000 G	-36.45	-23.45	 <table border="1"> <thead> <tr> <th>Start [Hz]</th> <th>Stop [Hz]</th> <th>RBW [Hz]</th> <th>Freq [Hz]</th> <th>PerAbs [dBm]</th> <th>ΔLimit [dB]</th> </tr> </thead> <tbody> <tr> <td>30,000 M</td> <td>1,000 G</td> <td>1,00 M</td> <td>170,407500 M</td> <td>-41.09</td> <td>-28.09</td> </tr> <tr> <td>1,000 G</td> <td>3,845 G</td> <td>1,00 M</td> <td>3,245473 G</td> <td>-40.33</td> <td>-27.33</td> </tr> <tr> <td>1,915 G</td> <td>3,000 G</td> <td>1,00 M</td> <td>1,915542 G</td> <td>-20.91</td> <td>-7.91</td> </tr> <tr> <td>3,000 G</td> <td>7,000 G</td> <td>1,00 M</td> <td>3,044000 G</td> <td>-37.59</td> <td>-24.59</td> </tr> <tr> <td>7,000 G</td> <td>13,600 G</td> <td>1,00 M</td> <td>11,650300 G</td> <td>-35.10</td> <td>-22.10</td> </tr> <tr> <td>13,600 G</td> <td>19,100 G</td> <td>1,00 M</td> <td>15,300188 G</td> <td>-25.58</td> <td>-12.58</td> </tr> </tbody> </table> <p>Date: 4.MAY.2022 10:09:07</p>	Start [Hz]	Stop [Hz]	RBW [Hz]	Freq [Hz]	PerAbs [dBm]	ΔLimit [dB]	30,000 M	1,000 G	1,00 M	170,407500 M	-41.09	-28.09	1,000 G	3,845 G	1,00 M	3,245473 G	-40.33	-27.33	1,915 G	3,000 G	1,00 M	1,915542 G	-20.91	-7.91	3,000 G	7,000 G	1,00 M	3,044000 G	-37.59	-24.59	7,000 G	13,600 G	1,00 M	11,650300 G	-35.10	-22.10	13,600 G	19,100 G	1,00 M	15,300188 G	-25.58	-12.58
Start [Hz]	Stop [Hz]	RBW [Hz]	Freq [Hz]	PerAbs [dBm]	ΔLimit [dB]																																																																										
35,000 M	820,000 M	1,00 M	812,492500 M	-44.06	-31.06																																																																										
830,000 M	1,000 G	1,00 M	843,492000 M	-43.33	-30.33																																																																										
1,000 G	3,000 G	1,00 M	2,959000 G	-40.96	-27.96																																																																										
3,000 G	7,000 G	1,00 M	3,011000 G	-38.98	-25.98																																																																										
7,000 G	9,000 G	1,00 M	7,960000 G	-36.45	-23.45																																																																										
Start [Hz]	Stop [Hz]	RBW [Hz]	Freq [Hz]	PerAbs [dBm]	ΔLimit [dB]																																																																										
30,000 M	1,000 G	1,00 M	170,407500 M	-41.09	-28.09																																																																										
1,000 G	3,845 G	1,00 M	3,245473 G	-40.33	-27.33																																																																										
1,915 G	3,000 G	1,00 M	1,915542 G	-20.91	-7.91																																																																										
3,000 G	7,000 G	1,00 M	3,044000 G	-37.59	-24.59																																																																										
7,000 G	13,600 G	1,00 M	11,650300 G	-35.10	-22.10																																																																										
13,600 G	19,100 G	1,00 M	15,300188 G	-25.58	-12.58																																																																										



WCDMA Band IV (RMC 12.2Kbps)

Lowest Channel

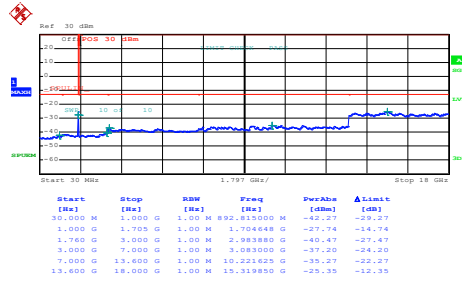

Date: 4.MAY.2022 10:24:32

Middle Channel

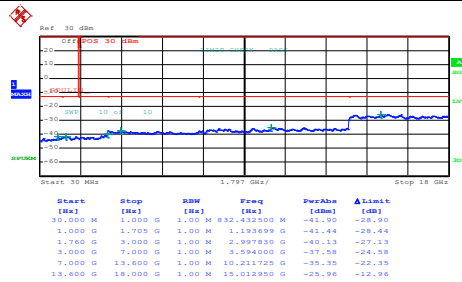

Date: 4.MAY.2022 10:25:40

Highest Channel

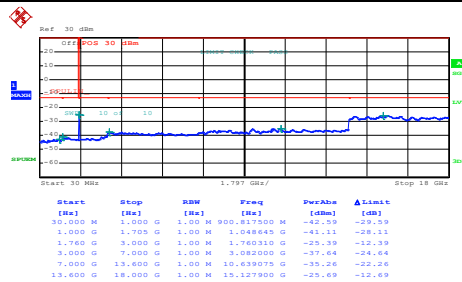

Date: 4.MAY.2022 10:26:47



Frequency Stability

Test Conditions	Middle Channel	WCDMA Band V (RMC 12.2Kbps)	Limit
Temperature (°C)	Voltage (Volt)	Deviation (ppm)	2.5ppm Result
50	Normal Voltage	0.0108	PASS
40	Normal Voltage	0.0072	
30	Normal Voltage	0.0036	
20(Ref.)	Normal Voltage	0.0000	
10	Normal Voltage	0.0036	
0	Normal Voltage	0.0060	
-10	Normal Voltage	0.0084	
-20	Normal Voltage	0.0060	
-30	Normal Voltage	0.0024	
20	Maximum Voltage	0.0108	
20	Normal Voltage	0.0096	
20	Battery End Point	0.0096	

Test Conditions	Middle Channel	WCDMA Band II (RMC 12.2Kbps)	Limit
Temperature (°C)	Voltage (Volt)	Deviation (ppm)	Note 2. Result
50	Normal Voltage	0.0021	PASS
40	Normal Voltage	0.0005	
30	Normal Voltage	0.0005	
20(Ref.)	Normal Voltage	0.0000	
10	Normal Voltage	0.0016	
0	Normal Voltage	0.0027	
-10	Normal Voltage	0.0000	
-20	Normal Voltage	0.0016	
-30	Normal Voltage	0.0032	
20	Maximum Voltage	0.0021	
20	Normal Voltage	0.0016	
20	Battery End Point	0.0011	

Note:

1. Normal Voltage = 3.3V. ; Battery End Point (BEP) = 3.135 V. ; Maximum Voltage =4.4 V
2. The frequency fundamental emissions stay within the authorized frequency block.



Test Conditions	Middle Channel	WCDMA Band IV (RMC 12.2Kbps)	Limit
Temperature (°C)	Voltage (Volt)	Deviation (ppm)	Note 2. Result
50	Normal Voltage	0.0081	PASS
40	Normal Voltage	0.0058	
30	Normal Voltage	0.0023	
20(Ref.)	Normal Voltage	0.0000	
10	Normal Voltage	0.0023	
0	Normal Voltage	0.0040	
-10	Normal Voltage	0.0052	
-20	Normal Voltage	0.0069	
-30	Normal Voltage	0.0092	
20	Maximum Voltage	0.0087	
20	Normal Voltage	0.0069	
20	Battery End Point	0.0052	

Note:

1. Normal Voltage = 3.3V. ; Battery End Point (BEP) = 3.135 V. ; Maximum Voltage =4.4 V
2. The frequency fundamental emissions stay within the authorized frequency block.



Appendix B. Test Results of Radiated Test

WCDMA 850

WCDMA 850									
Channel	Frequency (MHz)	ERP (dBm)	Limit (dBm)	Margin (dB)	SPA Reading (dBm)	S.G. Power (dBm)	TX Cable loss (dB)	TX Antenna Gain (dBi)	Polarization (H/V)
Lowest	1652	-63.77	-13	-50.77	-75.68	-65.51	0.98	4.87	H
	2480	-55.86	-13	-42.86	-73.05	-57.77	1.28	5.34	H
	3304	-58.03	-13	-45.03	-77.43	-61.47	1.54	7.14	H
									H
									H
									H
	1652	-61.86	-13	-48.86	-74.24	-63.6	0.98	4.87	V
	2480	-49.83	-13	-36.83	-67.46	-51.74	1.28	5.34	V
	3304	-57.96	-13	-44.96	-77.64	-61.4	1.54	7.14	V
									V
									V
									V
Middle	1672	-62.98	-13	-49.98	-75.17	-64.66	0.99	4.82	H
	2508	-56.68	-13	-43.68	-73.93	-58.64	1.29	5.41	H
	3344	-58.07	-13	-45.07	-77.64	-61.68	1.56	7.31	H
									H
									H
									H
	1672	-62.06	-13	-49.06	-74.71	-63.74	0.99	4.82	V
	2508	-50.96	-13	-37.96	-68.67	-52.92	1.29	5.41	V
	3344	-57.78	-13	-44.78	-77.56	-61.39	1.56	7.31	V
									V
									V
									V



Highest	1692	-63.47	-13	-50.47	-75.68	-65.09	1.00	4.76	H
	2544	-57.16	-13	-44.16	-74.4	-59.14	1.30	5.44	H
	3384	-57.84	-13	-44.84	-77.6	-61.61	1.57	7.49	H
									H
									H
									H
									H
	1692	-62.54	-13	-49.54	-75.34	-64.16	1.00	4.76	V
	2544	-52.53	-13	-39.53	-70.27	-54.51	1.30	5.44	V
	3384	-57.54	-13	-44.54	-77.43	-61.31	1.57	7.49	V
									V
									V
									V
									V

Remark: Spurious emissions within 30-1000MHz were found more than 20dB below limit line.



WCDMA 1900

WCDMA 1900									
Channel	Frequency (MHz)	EIRP (dBm)	Limit (dBm)	Margin (dB)	SPA Reading (dBm)	S.G. Power (dBm)	TX Cable loss (dB)	TX Antenna Gain (dBi)	Polarization (H/V)
Lowest	3708	-57.85	-13	-44.85	-78.73	-64.43	1.67	8.25	H
	5556	-56.01	-13	-43.01	-81.45	-63.08	2.66	9.72	H
	7410	-55.13	-13	-42.13	-82.15	-64.29	2.46	11.62	H
									H
									H
									H
									H
	3708	-58.01	-13	-45.01	-78.92	-64.59	1.67	8.25	V
	5556	-55.96	-13	-42.96	-81.36	-63.03	2.66	9.72	V
	7410	-54.92	-13	-41.92	-82.21	-64.08	2.46	11.62	V
									V
									V
									V
									V
Middle	3762	-58.41	-13	-45.41	-79.17	-65.04	1.69	8.31	H
	5640	-55.78	-13	-42.78	-81.41	-62.83	2.71	9.76	H
	7518	-54.22	-13	-41.22	-81.48	-63.61	2.42	11.81	H
									H
									H
									H
									H
	3762	-58.19	-13	-45.19	-78.88	-64.82	1.69	8.31	V
	5640	-55.89	-13	-42.89	-81.36	-62.94	2.71	9.76	V
	7518	-54.38	-13	-41.38	-81.79	-63.77	2.42	11.81	V
									V
									V
									V
									V



Highest	3816	-58.21	-13	-45.21	-78.92	-64.89	1.70	8.38	H
	5724	-55.54	-13	-42.54	-81.09	-62.58	2.75	9.79	H
	7632	-53.24	-13	-40.24	-80.74	-62.73	2.39	11.88	H
									H
									H
									H
									H
	3816	-57.64	-13	-44.64	-78.39	-64.32	1.70	8.38	V
	5724	-55.41	-13	-42.41	-81.07	-62.45	2.75	9.79	V
	7632	-53.84	-13	-40.84	-81.56	-63.33	2.39	11.88	V
									V
									V
									V
									V

Remark: Spurious emissions within 30-1000MHz were found more than 20dB below limit line.



WCDMA 1700

WCDMA 1700									
Channel	Frequency (MHz)	EIRP (dBm)	Limit (dBm)	Margin (dB)	SPA Reading (dBm)	S.G. Power (dBm)	TX Cable loss (dB)	TX Antenna Gain (dBi)	Polarization (H/V)
Lowest	3426	-57.26	-13	-44.26	-77.92	-63.35	1.58	7.67	H
	5136	-56.44	-13	-43.44	-80.48	-63.72	2.42	9.70	H
	6852	-54.67	-13	-41.67	-81.67	-62.65	2.64	10.62	H
									H
									H
									H
									H
	3426	-55.02	-13	-42.02	-75.73	-61.11	1.58	7.67	V
	5136	-56.28	-13	-43.28	-80.3	-63.56	2.42	9.70	V
	6852	-54.78	-13	-41.78	-81.73	-62.76	2.64	10.62	V
									V
									V
									V
									V
Middle	3462	-56.77	-13	-43.77	-77.55	-63.01	1.59	7.83	H
	5196	-56.33	-13	-43.33	-80.63	-63.58	2.45	9.70	H
	6930	-54.84	-13	-41.84	-81.66	-62.94	2.61	10.72	H
									H
									H
									H
									H
	3462	-53.52	-13	-40.52	-74.22	-59.76	1.59	7.83	V
	5196	-56.97	-13	-43.97	-81.01	-64.22	2.45	9.70	V
	6930	-55.15	-13	-42.15	-81.86	-63.25	2.61	10.72	V
									V
									V
									V
									V



Highest	3504	-56.35	-13	-43.35	-77.37	-62.75	1.61	8.00	H
	5256	-56.83	-13	-43.83	-81.17	-64.05	2.48	9.70	H
	7008	-55.41	-13	-42.41	-82	-63.64	2.59	10.82	H
									H
									H
									H
									H
	3504	-55.36	-13	-42.36	-76.25	-61.76	1.61	8.00	V
	5256	-56.33	-13	-43.33	-80.58	-63.55	2.48	9.70	V
	7008	-54.88	-13	-41.88	-81.6	-63.11	2.59	10.82	V
									V
									V
									V
									V

Remark: Spurious emissions within 30-1000MHz were found more than 20dB below limit line.