



FCC/IC RF Test Report

APPLICANT : Sierra Wireless Inc.
EQUIPMENT : Radio Module
BRAND NAME : AirPrime
MODEL NAME : EM7565-9
FCC ID : N7NEM75L
IC : 2417C-EM75L
STANDARD : FCC 47 CFR Part 2, 27
IC RSS-195 Issue 2
CLASSIFICATION : PCS Licensed Transmitter (PCB)

The product was received on Sep, 19, 2017 and completely tested on Oct. 06, 2017. We, SPORTON INTERNATIONAL INC., would like to declare that the tested sample has been evaluated in accordance with the procedures given in ANSI / TIA / EIA-603-E and shown compliance with the applicable technical standards.

The test results in this report apply exclusively to the tested model / sample. Without written approval of SPORTON INTERNATIONAL INC., the test report shall not be reproduced except in full.

Reviewed by: Joseph Lin / Supervisor

Approved by: Jones Tsai / Manager



SPORTON INTERNATIONAL INC.

No. 52, Hwa Ya 1st Rd., Hwa Ya Technology Park, Kwei-Shan District, Tao Yuan City, Taiwan, R.O.C.



TABLE OF CONTENTS

REVISION HISTORY..... 3
SUMMARY OF TEST RESULT 4
1 GENERAL DESCRIPTION 5
1.1 Applicant 5
1.2 Manufacturer 5
1.3 Product Feature of Equipment Under Test 5
1.4 Modification of EUT 5
1.5 Testing Site 5
1.6 Applied Standards 6
2 TEST CONFIGURATION OF EQUIPMENT UNDER TEST 7
2.1 Test Mode 7
2.2 Connection Diagram of Test System 8
2.3 Support Unit used in test configuration and system 8
2.4 Measurement Results Explanation Example 9
2.5 Frequency List of Low/Middle/High Channels 9
3 CONDUCTED TEST ITEMS 10
3.1 Measuring Instruments 10
3.2 Test Setup 10
3.3 Test Result of Conducted Test 10
3.4 Conducted Output Power Measurement 11
3.5 Peak-to-Average Ratio 12
3.6 EIRP Power Density 13
3.7 Occupied Bandwidth 14
3.8 Conducted Band Edge Measurement 15
3.9 Conducted Spurious Emission Measurement 17
3.10 Frequency Stability Measurement 19
4 RADIATED TEST ITEMS 20
4.1 Measuring Instruments 20
4.2 Test Setup 20
4.3 Test Result of Radiated Test 20
4.4 Radiated Spurious Emission Measurement 21
5 LIST OF MEASURING EQUIPMENT 23
6 UNCERTAINTY OF EVALUATION 24
APPENDIX A. TEST RESULTS OF CONDUCTED TEST
APPENDIX B. TEST RESULTS OF RADIATED TEST



REVISION HISTORY

REPORT NO.	VERSION	DESCRIPTION	ISSUED DATE
FG791919C	Rev. 01	Initial issue of report	Oct. 13, 2017



SUMMARY OF TEST RESULT

Report Section	FCC Rule	IC Rule	Description	Limit	Result	Remark
3.4	§2.1046	RSS-Gen(6.12)	Conducted Output Power	Reporting Only	PASS	-
3.5	-	RSS-195(5.5.1)	Peak-to-Average Ratio	<13dB	N/A	Reporting only
3.6	§27.50 (a)(3)	RSS-195(5.5)	EIRP Power Density	EIRP < 250mW/5MHz	PASS	-
3.7	§2.1049	RSS-GEN(6.6)	Occupied Bandwidth	Reporting Only	PASS	-
3.8	§2.1051 §27.53 (a)(4)	RSS-195(5.6)	Conducted Band Edge Measurement	Refer standard	PASS	-
3.9	§2.1051 §27.53 (a)(4)	RSS-195(5.6)	Conducted Spurious Emission	For Part 27 < 70+10log ₁₀ (P[Watts]) For RSS 195 < 43+10log ₁₀ (P[Watts])	PASS	-
3.10	§2.1055 §27.54	RSS-195(5.4)	Frequency Stability Temperature & Voltage	Within the band	PASS	-
4.4	§2.1053 §27.53 (a)(4)	RSS-195(5.6)	Radiated Spurious Emission	For Part 27 < 70+10log ₁₀ (P[Watts]) For RSS 195 < 43+10log ₁₀ (P[Watts])	PASS	Under limit 1.11 dB at 6930.000 MHz



1 General Description

1.1 Applicant

Sierra Wireless Inc.
13811 Wireless Way Richmond, BC Canada V6V 3A4

1.2 Manufacturer

Sierra Wireless Inc.
13811 Wireless Way Richmond, BC Canada V6V 3A4

1.3 Product Feature of Equipment Under Test

WCDMA/LTE

1.4 Modification of EUT

No modifications are made to the EUT during all test items.

1.5 Testing Site

Sporton Lab is accredited to ISO 17025 by Taiwan Accreditation Foundation (TAF code : 1190) and the FCC designation No. TW1190 under the FCC 2.948(e) by Mutual Recognition Agreement (MRA) in FCC Test.

Test Site	SPORTON INTERNATIONAL INC.		
Test Site Location	No. 52, Hwa Ya 1 st Rd., Hwa Ya Technology Park, Kwei-Shan District, Tao Yuan City, Taiwan, R.O.C. TEL: +886-3-327-3456 FAX: +886-3-328-4978		
Test Site No.	Sporton Site No.		IC Registration No.
	TH05-HY	03CH07-HY	4086B-5



1.6 Applied Standards

According to the specifications of the manufacturer, the EUT must comply with the requirements of the following standards:

- ♦ 47 CFR Part 2, Part 27(D)
- ♦ ANSI / TIA / EIA-603-E
- ♦ FCC KDB 971168 Power Meas License Digital Systems D01 v02r02
- ♦ ANSI C63.26-2015
- ♦ IC RSS-Gen Issue 4
- ♦ RSS-195 Issue 2

Remark: All test items were verified and recorded according to the standards and without any deviation during the test.



2 Test Configuration of Equipment Under Test

2.1 Test Mode

Antenna port conducted and radiated test items listed below are performed according to KDB 971168 D01 Power Meas. License Digital Systems v02r02 with maximum output power.

Radiated measurements are performed by rotating the EUT in three different orthogonal test planes to find the maximum emission.

Conducted Test Cases	Band	Bandwidth (MHz)						Modulation			RB #			Test Channel		
		1.4	3	5	10	15	20	QPSK	16QAM	64QAM	1	Half	Full	L	M	H
Max. Output Power	30	-	-	v	v	-	-	v	v	v	v	v	v	v	v	v
Peak-to-Average Ratio	30	-	-			-	-	v	v	v	v		v		v	
E.I.R.P PSD	30	-	-		v	-	-	v	v	v	v			v	v	v
26dB and 99% Bandwidth	30	-	-	v	v	-	-	v	v	v			v	v	v	v
Conducted Band Edge	30	-	-	v	v	-	-	v	v	v	v		v	v		v
Conducted Spurious Emission	30	-	-	v	v	-	-	v	v	v	v			v	v	v
Frequency Stability	30	-	-		v	-	-	v					v		v	
Radiated Spurious Emission	30	-	-	Worst case		-	-	v	Pre-test		v			v	v	v
Note	<ol style="list-style-type: none"> The mark "v" means that this configuration is chosen for testing The mark "-" means that this bandwidth is not supported. The device is investigated from 30MHz to 10 times of fundamental signal for radiated spurious emission test under different RB size/offset and modulations in exploratory test. Subsequently, only the worst case emissions are reported. 															

2.2 Connection Diagram of Test System

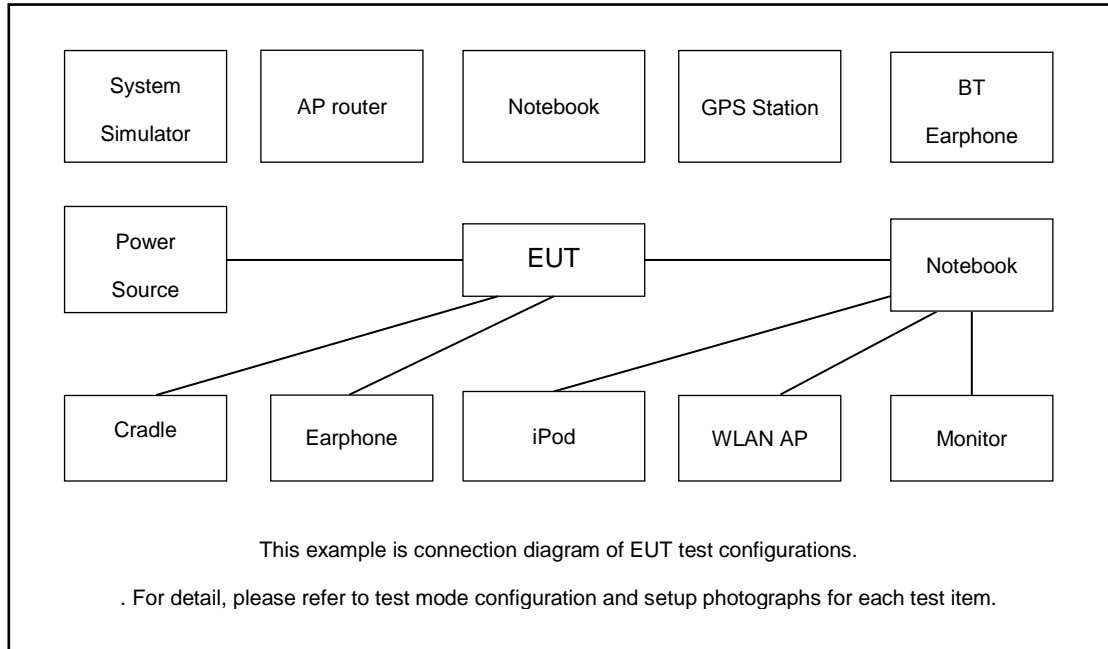

2.3 Support Unit used in test configuration and system

Item	Equipment	Trade Name	Model No.	FCC ID	Data Cable	Power Cord
1.	Base Station	Anritsu	8820C	N/A	N/A	Unshielded, 1.8 m

2.4 Measurement Results Explanation Example

For all conducted test items:

The offset level is set in the spectrum analyzer to compensate the RF cable loss and attenuator factor between EUT conducted output port and spectrum analyzer. With the offset compensation, the spectrum analyzer reading level is exactly the EUT RF output level.

The spectrum analyzer offset is derived from RF cable loss and attenuator factor.

Offset = RF cable loss + attenuator factor.

Following shows an offset computation example with cable loss 4.2 dB and 10dB attenuator.

Example :

$$\begin{aligned} \text{Offset(dB)} &= \text{RF cable loss(dB)} + \text{attenuator factor(dB)} \\ &= 4.2 + 10 = 14.2 \text{ (dB)} \end{aligned}$$

2.5 Frequency List of Low/Middle/High Channels

LTE Band 30 Channel and Frequency List				
BW [MHz]	Channel/Frequency(MHz)	Lowest	Middle	Highest
10	Channel	-	27710	-
	Frequency	-	2310	-
5	Channel	27685	27710	27735
	Frequency	2307.5	2310	2312.5

3 Conducted Test Items

3.1 Measuring Instruments

See list of measuring instruments of this test report.

3.2 Test Setup

3.2.1 Conducted Output Power

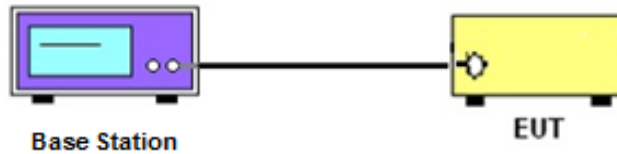

3.2.2 Peak-to-Average Ratio, Occupied / 26dB Bandwidth ,Band-Edge and Conducted Spurious Emission

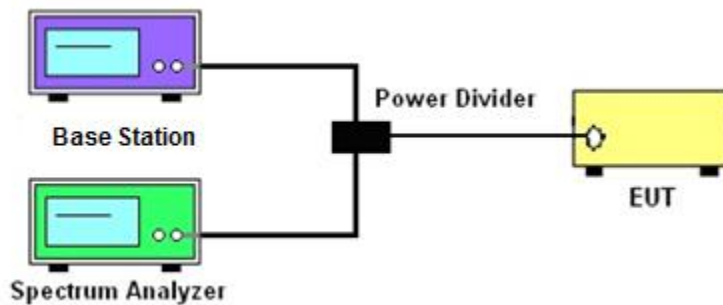

3.2.3 Frequency Stability

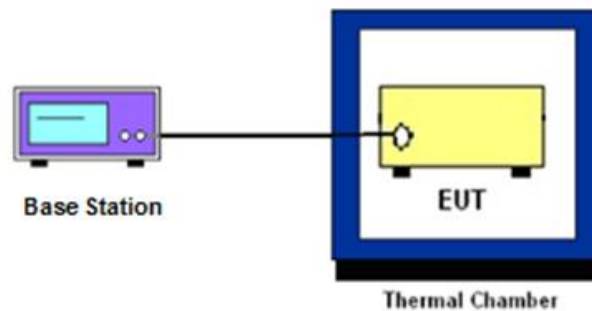

3.3 Test Result of Conducted Test

Please refer to Appendix A.



3.4 Conducted Output Power Measurement

3.4.1 Description of the Conducted Output Power Measurement

A base station simulator was used to establish communication with the EUT. Its parameters were set to transmit the maximum power on the EUT. The measured power in the radio frequency on the transmitter output terminals shall be reported.

3.4.2 Test Procedures

1. The transmitter output port was connected to the system simulator.
2. Set EUT at maximum power through the system simulator.
3. Select lowest, middle, and highest channels for each band and different modulation.
4. Measure and record the power level from the system simulator.



3.5 Peak-to-Average Ratio

3.5.1 Description of the PAR Measurement

Power Complementary Cumulative Distribution Function (CCDF) curves provide a means for characterizing the power peaks of a digitally modulated signal on a statistical basis. A CCDF curve depicts the probability of the peak signal amplitude exceeding the average power level. Most contemporary measurement instrumentation include the capability to produce CCDF curves for an input signal provided that the instrument's resolution bandwidth can be set wide enough to accommodate the entire input signal bandwidth. In measuring transmissions in this band using an average power technique, the peak-to-average ratio (PAR) of the transmission may not exceed 13 dB.

3.5.2 Test Procedures

1. The testing follows FCC KDB 971168 v02r02 Section 5.7.1 and ANSI C63.26 Section 5.2.3.4.
2. The EUT was connected to spectrum and system simulator via a power divider.
3. Set the CCDF (Complementary Cumulative Distribution Function) option in spectrum analyzer.
4. The highest RF powers were measured and recorded the maximum PAPR level associated with a probability of 0.1 %.
5. Record the deviation as Peak to Average Ratio.



3.6 EIRP Power Density

3.6.1 Description of EIRP Power Density

For mobile and portable stations transmitting in the 2305-2315 MHz band or the 2350-2360 MHz band, the average EIRP must not exceed 50 milliwatts within any 1 megahertz of authorized bandwidth, *except that* for mobile and portable stations compliant with 3GPP LTE standards or another advanced mobile broadband protocol that avoids concentrating energy at the edge of the operating band the average EIRP must not exceed 250 milliwatts within any 5 megahertz of authorized bandwidth but may exceed 50 milliwatts within any 1 megahertz of authorized bandwidth. For mobile and portable stations using time division duplexing (TDD) technology, the duty cycle must not exceed 38 percent in the 2305-2315 MHz and 2350-2360 MHz bands. Mobile and portable stations using FDD technology are restricted to transmitting in the 2305-2315 MHz band. Power averaging shall not include intervals in which the transmitter is off.

3.6.2 Test Procedures

1. The testing follows FCC KDB 971168 v02r02 Section 5.7.1 and ANSI C63.26 Section 5.2.4.1
2. Set instrument center frequency to OBW center frequency.
3. Set span to at least 1.5 times the OBW.
4. Set the RBW to the specified reference bandwidth (5MHz).
5. Set VBW $\geq 3 \times$ RBW.
6. Detector = RMS (power averaging).
7. Ensure that the number of measurement points in the sweep $\geq 2 \times$ span/RBW.
8. Sweep time = auto couple.
9. Employ trace averaging (RMS) mode over a minimum of 100 traces.
10. Use the peak marker function to determine the maximum amplitude level within the reference bandwidth (PSD).

3.7 Occupied Bandwidth

3.7.1 Description of Occupied Bandwidth Measurement

The occupied bandwidth is the width of a frequency band such that, below the lower and above the upper frequency limits, the mean powers emitted are each equal to a specified percentage 0.5% of the total mean transmitted power.

The 26 dB emission bandwidth is defined as the frequency range between two points, one above and one below the carrier frequency, at which the spectral density of the emission is attenuated 26 dB below the maximum in-band spectral density of the modulated signal. Spectral density (power per unit bandwidth) is to be measured with a detector of resolution bandwidth equal to approximately 1.0% of the emission bandwidth.

3.7.2 Test Procedures

1. The testing follows FCC KDB 971168 v02r02 Section 4.1 and 4.2 and ANSI C63.26 Section 5.4
2. The EUT was connected to spectrum analyzer and system simulator via a power divider.
3. The spectrum analyzer center frequency is set to the nominal EUT channel center frequency. The span range for the spectrum analyzer shall be between two and five times the anticipated OBW.
4. The nominal resolution bandwidth (RBW) shall be in the range of 1 to 5 % of the anticipated OBW, and the VBW shall be at least 3 times the RBW.
5. Set the detection mode to peak, and the trace mode to max hold.
6. Determine the reference value: Set the EUT to transmit a modulated signal. Allow the trace to stabilize. Set the spectrum analyzer marker to the highest level of the displayed trace.
(this is the reference value)
7. Determine the “-26 dB down amplitude” as equal to (Reference Value – X).
8. Place two markers, one at the lowest and the other at the highest frequency of the envelope of the spectral display such that each marker is at or slightly below the “-X dB down amplitude” determined in step 6. If a marker is below this “-X dB down amplitude” value it shall be placed as close as possible to this value. The OBW is the positive frequency difference between the two markers.
9. Use the 99 % power bandwidth function of the spectrum analyzer and report the measured bandwidth.



3.8 Conducted Band Edge Measurement

3.8.1 Description of Conducted Band Edge Measurement

27.53 (a)(4)

For mobile and portable stations operating in the 2305-2315 MHz and 2350-2360 MHz bands:

- (i) By a factor of not less than: $43 + 10 \log (P)$ dB on all frequencies between 2305 and 2320 MHz and on all frequencies between 2345 and 2360 MHz that are outside the licensed band(s) of operation, not less than $55 + 10 \log (P)$ dB on all frequencies between 2320 and 2324 MHz and on all frequencies between 2341 and 2345 MHz, not less than $61 + 10 \log (P)$ dB on all frequencies between 2324 and 2328 MHz and on all frequencies between 2337 and 2341 MHz, and not less than $67 + 10 \log (P)$ dB on all frequencies between 2328 and 2337 MHz;
- (ii) By a factor of not less than $43 + 10 \log (P)$ dB on all frequencies between 2300 and 2305 MHz, $55 + 10 \log (P)$ dB on all frequencies between 2296 and 2300 MHz, $61 + 10 \log (P)$ dB on all frequencies between 2292 and 2296 MHz, $67 + 10 \log (P)$ dB on all frequencies between 2288 and 2292 MHz, and $70 + 10 \log (P)$ dB below 2288 MHz;
- (iii) By a factor of not less than $43 + 10 \log (P)$ dB on all frequencies between 2360 and 2365 MHz, and not less than $70 + 10 \log (P)$ dB above 2365 MHz.

RSS-195 5.6.2

For mobile and portable stations:

- (i) By a factor of not less than: $43 + 10 \log (P)$ dB on all frequencies between 2305 and 2320 MHz and on all frequencies between 2345 and 2360 MHz that are outside the licensed band(s) of operation, not less than $55 + 10 \log (P)$ dB on all frequencies between 2320 and 2324 MHz and on all frequencies between 2341 and 2345 MHz, not less than $61 + 10 \log (P)$ dB on all frequencies between 2324 and 2328 MHz and on all frequencies between 2337 and 2341 MHz, and not less than $67 + 10 \log (P)$ dB on all frequencies between 2328 and 2337 MHz;
- (ii) By a factor of not less than $43 + 10 \log (P)$ dB on all frequencies between 2300 and 2305 MHz, $55 + 10 \log (P)$ dB on all frequencies between 2296 and 2300 MHz, $61 + 10 \log (P)$ dB on all frequencies between 2292 and 2296 MHz, $67 + 10 \log (P)$ dB on all frequencies between 2288 and 2292 MHz, $70 + 10 \log (P)$ dB on all frequencies between 2200 and 2288 MHz, and not less than $43 + 10 \log (P)$ dB below 2200 MHz;
- (iii) By a factor of not less than $43 + 10 \log (P)$ dB on all frequencies between 2360 and 2365 MHz, and not less than $70 + 10 \log (P)$ dB on all frequencies between 2365 and 2395 MHz, and not less than $43 + 10 \log (P)$ dB above 2395 MHz;



3.8.2 Test Procedures

1. The testing follows FCC KDB 971168 v02r02 Section 6.0 and ANSI C63.26 Section 5.7.
2. The EUT was connected to spectrum analyzer and system simulator via a power divider.
3. The band edges of low and high channels for the highest RF powers were measured.
4. Set RBW \geq 1% EBW in the 1MHz band immediately outside and adjacent to the band edge.
5. Beyond the 1 MHz band from the band edge, RBW=1MHz was used.
6. Set spectrum analyzer with RMS detector.
7. The RF fundamental frequency should be excluded against the limit line in the operating frequency band.
8. Checked that all the results comply with the emission limit line.

Example:

The limit line is derived from $43 + 10\log(P)$ dB below the transmitter power P(Watts)
= P(W)- [43 + 10log(P)] (dB)
= [30 + 10log(P)] (dBm) - [43 + 10log(P)] (dB) = -13dBm.



3.9 Conducted Spurious Emission Measurement

3.9.1 Description of Conducted Spurious Emission Measurement

27.53 (a)(4)

The power of any emission outside of the authorized operating frequency ranges must be lower than the transmitter power (P) by a factor of at least $70 + 10 \log (P)$ dB.

It is measured by means of a calibrated spectrum analyzer and scanned from 9 kHz up to a frequency including its 10th harmonic.

RSS-195(5.6)

The power of any emission outside of the authorized operating frequency ranges must be lower than the transmitter power (P) by a factor of at least $43 + 10 \log (P)$ dB.

It is measured by means of a calibrated spectrum analyzer and scanned from 30MHz up to a frequency including its 10th harmonic.



3.9.2 Test Procedures

1. The testing follows FCC KDB 971168 v02r02 Section 6.0 and ANSI C63.26 Section 5.7.
2. The EUT was connected to spectrum analyzer and system simulator via a power divider.
3. The RF output of EUT was connected to the spectrum analyzer by RF cable and attenuator. The path loss was compensated to the results for each measurement.
4. The middle channel for the highest RF power within the transmitting frequency was measured.
5. The conducted spurious emission for the whole frequency range was taken.
6. Make the measurement with the spectrum analyzer's RBW = 1MHz, VBW = 3MHz.
7. Set spectrum analyzer with RMS detector.
8. Taking the record of maximum spurious emission.
9. The RF fundamental frequency should be excluded against the limit line in the operating frequency band.
10. The limit line is derived from $70 + 10\log(P)$ dB below the transmitter power P(Watts)
 $= P(W) - [70 + 10\log(P)]$ (dB)
 $= [30 + 10\log(P)]$ (dBm) - $[70 + 10\log(P)]$ (dB)
 $= -40$ dBm
11. The limit line is derived from $43 + 10\log(P)$ dB below the transmitter power P(Watts)
 $= P(W) - [43 + 10\log(P)]$ (dB)
 $= [30 + 10\log(P)]$ (dBm) - $[43 + 10\log(P)]$ (dB)
 $= -13$ dBm.
12. The limit line $70+10\log(P)$ below the transmitter power is selected which is much worse.



3.10 Frequency Stability Measurement

3.10.1 Description of Frequency Stability Measurement

The frequency stability shall be measured by variation of ambient temperature and variation of primary supply voltage to ensure that the fundamental emission stays within the authorized frequency block. The frequency stability of the transmitter shall be maintained within $\pm 0.00025\%$ ($\pm 2.5\text{ppm}$) of the center frequency.

3.10.2 Test Procedures for Temperature Variation

1. The testing follows FCC KDB 971168 v02r02 Section 9.0 and ANSI C63.26 Section 5.6.
2. The EUT was set up in the thermal chamber and connected with the system simulator.
3. With power OFF, the temperature was decreased to -30°C and the EUT was stabilized before testing. Power was applied and the maximum change in frequency was recorded within one minute.
4. With power OFF, the temperature was raised in 10°C step up to 50°C . The EUT was stabilized at each step for at least half an hour. Power was applied and the maximum frequency change was recorded within one minute.

3.10.3 Test Procedures for Voltage Variation

1. The testing follows FCC KDB 971168 v02r02 Section 9.0 and ANSI C63.26 Section 5.6.
2. The EUT was placed in a temperature chamber at $20\pm 5^{\circ}\text{C}$ and connected with the system simulator.
3. The power supply voltage to the EUT was varied from 85% to 115% of the nominal value measured at the input to the EUT.
4. The variation in frequency was measured for the worst case.

4 Radiated Test Items

4.1 Measuring Instruments

See list of measuring instruments of this test report.

4.2 Test Setup

4.2.1 For radiated test from 30MHz to 1GHz

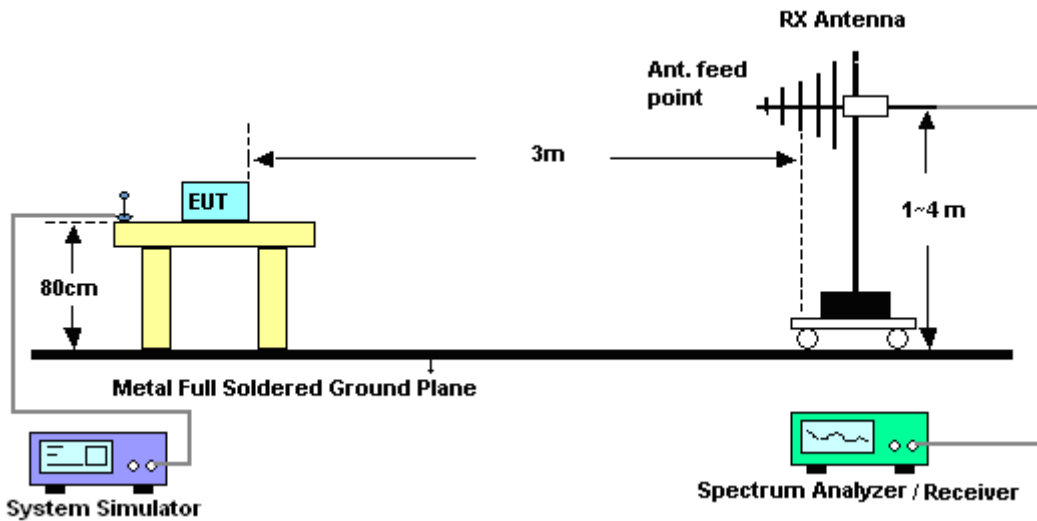

4.2.2 For radiated test above 1GHz

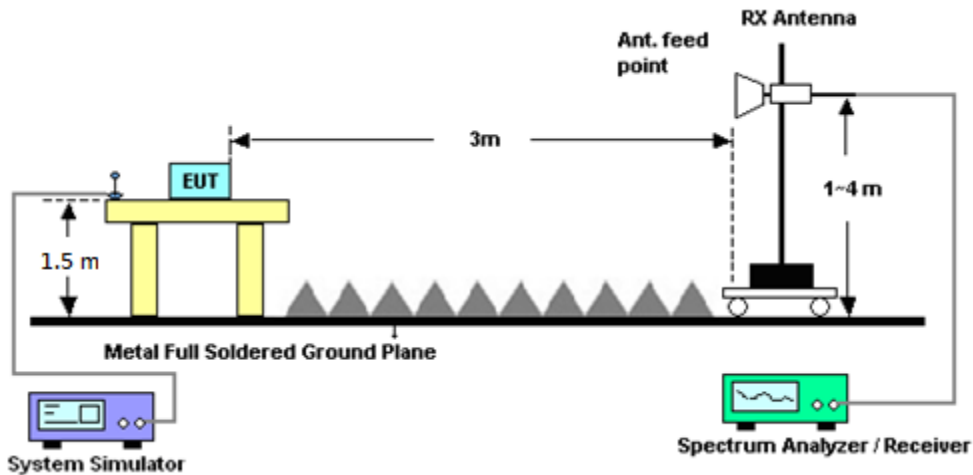

4.3 Test Result of Radiated Test

Please refer to Appendix B.



4.4 Radiated Spurious Emission Measurement

4.4.1 Description of Radiated Spurious Emission

27.53 (a)(4)

The radiated spurious emission was measured by substitution method according to ANSI / TIA / EIA-603-E. The power of any emission outside of the authorized operating frequency ranges must be attenuated below the transmitter power (P) by a factor of at least $70 + 10 \log (P)$ dB.

The spectrum is scanned from 30 MHz up to a frequency including its 10th harmonic.

RSS-195(5.6)

The radiated spurious emission was measured by substitution method according to ANSI C63.26.

The power of any emission outside of the authorized operating frequency ranges must be attenuated below the transmitter power (P) by a factor of at least $43 + 10 \log (P)$ dB.

The spectrum is scanned from 30 MHz up to a frequency including its 10th harmonic.



4.4.2 Test Procedures

1. The testing follows FCC KDB 971168 v02r02 Section 5.8 and ANSI / TIA-603-E Section 2.2.12 and ANSI C63.26 Section 5.5.3 Measurement of spurious emissions using substitution method. .
2. The EUT was placed on a turntable with 0.8 meter height for frequency below 1GHz and 1.5 meter height for frequency above 1GHz respectively above ground.
3. The EUT was set 3 meters from the receiving antenna mounted on the antenna tower.
4. The table was rotated 360 degrees to determine the position of the highest spurious emission.
5. The height of the receiving antenna is varied between 1m to 4m to search the maximum spurious emission for both horizontal and vertical polarizations.
6. During the measurement, the system simulator parameters were set to force the EUT transmitting at maximum output power.
7. Make the measurement with the spectrum analyzer's RBW = 1MHz, VBW = 3MHz, taking the record of maximum spurious emission.
8. A horn antenna was substituted in place of the EUT and was driven by a signal generator.
9. Tune the output power of signal generator to the same emission level with EUT maximum spurious emission.
EIRP (dBm) = S.G. Power – Tx Cable Loss + Tx Antenna Gain
ERP (dBm) = EIRP - 2.15
10. The RF fundamental frequency should be excluded against the limit line in the operating frequency band.
The limit line is derived from $70 + 10\log(P)$ dB below the transmitter power P(Watts)
= $P(W) - [70 + 10\log(P)]$ (dB)
= $[30 + 10\log(P)]$ (dBm) - $[70 + 10\log(P)]$ (dB)
= -40dBm.
For IC
11. The limit line is derived from $43 + 10\log(P)$ dB below the transmitter power P(Watts)
12. The limit line $70+10\log(P)$ below the transmitter power is selected which is much worse.



5 List of Measuring Equipment

Instrument	Manufacturer	Model No.	Serial No.	Characteristics	Calibration Date	Test Date	Due Date	Remark
LTE Base Station	Anritsu	MT8820C	620143282 1	GSM/GPRS /WCDMA/LTE	Oct. 11, 2016	Sep. 19, 2017 ~ Oct. 04, 2017	Oct. 10, 2017	Conducted (TH05-HY)
Spectrum Analyzer	Rohde & Schwarz	FSV40	101397	10Hz~40GHz	Nov. 04, 2016	Sep. 19, 2017 ~ Oct. 04, 2017	Nov. 03, 2017	Conducted (TH05-HY)
Temperature Chamber	ESPEC	SH-641	92013720	-30°C~70°C	Aug. 28, 2017	Sep. 19, 2017 ~ Oct. 04, 2017	Aug. 27, 2018	Conducted (TH05-HY)
Programmable Power Supply	GW Instek	PSS-2005	EL890089	1V~20V 0.5A~5A	Jan. 12, 2017	Sep. 19, 2017 ~ Oct. 04, 2017	Jan. 11, 2018	Conducted (TH05-HY)
Coupler	Warison	1-18GHz 20dB 25WSMA Directional Coupler	#B	1G~18GHz	Feb. 20, 2017	Sep. 19, 2017 ~ Oct. 04, 2017	Feb. 19, 2018	Conducted (DF02-HY)
Bilog Antenna	Schaffner	CBL6111C	2726	30MHz ~ 1GHz	N/A	Sep. 23, 2017 ~ Oct. 06, 2017	N/A	Radiation (03CH07-HY)
Double Ridge Horn Antenna	ESCO	3117	00075962	1GHz ~ 18GHz	Aug. 23, 2017	Sep. 23, 2017 ~ Oct. 06, 2017	Aug. 22, 2018	Radiation (03CH07-HY)
Preamplifier	MITEQ	AMF-7D-0010 1800-30-10P	1590075	1GHz ~ 18GHz	Apr. 25, 2017	Sep. 23, 2017 ~ Oct. 06, 2017	Apr. 24, 2018	Radiation (03CH07-HY)
Preamplifier	COM-POWER	PA-103A	161241	10MHz-1GHz	Mar. 14, 2017	Sep. 23, 2017 ~ Oct. 06, 2017	Mar. 13, 2018	Radiation (03CH07-HY)
EMI Test Receiver	Agilent	N9038A (MXE)	MY532900 53	20Hz to 26.5GHz	Jan. 12, 2017	Sep. 23, 2017 ~ Oct. 06, 2017	Jan. 11, 2018	Radiation (03CH07-HY)
Horn Antenna	ESCO	3117	00066584	1GHz~18GHz	Sep. 06, 2017	Sep. 23, 2017 ~ Oct. 06, 2017	Sep. 05, 2018	Radiation (03CH07-HY)
Antenna Mast	Max-Full	MFA520BS	N/A	1m~4m	N/A	Sep. 23, 2017 ~ Oct. 06, 2017	N/A	Radiation (03CH07-HY)
Turn Table	ChainTek	Chaintek 3000	N/A	0~360 Degree	N/A	Sep. 23, 2017 ~ Oct. 06, 2017	N/A	Radiation (03CH07-HY)
SHF-EHF Horn Antenna	SCHWARZBE CK	BBHA 9170	BBHA9170 584	18GHz- 40GHz	Nov. 08, 2016	Sep. 23, 2017 ~ Oct. 06, 2017	Nov. 07, 2017	Radiation (03CH07-HY)
Amplifier	MITEQ	TTA1840-35- HG	1871923	18GHz~40GHz, VSWR : 2.5:1 max	Jul. 18, 2017	Sep. 23, 2017 ~ Oct. 06, 2017	Jul. 17, 2018	Radiation (03CH07-HY)
Signal Generator	Rohde & Schwarz	SMF100A	101107	100kHz~40GHz	May 22, 2017	Sep. 23, 2017 ~ Oct. 06, 2017	May 21, 2018	Radiation (03CH07-HY)



6 Uncertainty of Evaluation

Uncertainty of Radiated Emission Measurement (30 MHz ~ 1000 MHz)

Measuring Uncertainty for a Level of Confidence of 95% ($U = 2Uc(y)$)	3.05
-------------------------------------------------------------------------	------

Uncertainty of Radiated Emission Measurement (1 GHz ~ 18 GHz)

Measuring Uncertainty for a Level of Confidence of 95% ($U = 2Uc(y)$)	3.44
-------------------------------------------------------------------------	------

Uncertainty of Radiated Emission Measurement (18 GHz ~ 40 GHz)

Measuring Uncertainty for a Level of Confidence of 95% ($U = 2Uc(y)$)	3.95
-------------------------------------------------------------------------	------



Appendix A. Test Results of Conducted Test

Conducted Output Power(Average power)

LTE Band 30 Maximum Average Power [dBm]						
BW [MHz]	RB Size	RB Offset	Mod	Lowest	Middle	Highest
10	1	0	QPSK	0.00	21.40	0.00
10	1	25			21.26	
10	1	49			21.22	
10	25	0			20.31	
10	25	12			20.32	
10	25	25			20.23	
10	50	0			20.31	
10	1	0	16-QAM	0.00	20.65	0.00
10	1	25			20.52	
10	1	49			20.48	
10	25	0			19.32	
10	25	12			19.33	
10	25	25			19.23	
10	50	0			19.32	
10	1	0	64-QAM	0.00	19.57	0.00
10	1	25			19.45	
10	1	49			19.41	
10	25	0			18.32	
10	25	12			18.36	
10	25	25			18.25	
10	50	0			18.35	
5	1	0	QPSK	21.33	21.28	21.43
5	1	12		21.31	21.24	21.31
5	1	24		21.25	21.30	21.34
5	12	0		20.32	20.32	20.42
5	12	7		20.38	20.34	20.37
5	12	13		20.25	20.29	20.34
5	25	0		20.34	20.31	20.36
5	1	0	16-QAM	20.61	20.53	20.68
5	1	12		20.60	20.55	20.56
5	1	24		20.51	20.55	20.58
5	12	0		19.39	19.31	19.45
5	12	7		19.37	19.34	19.39
5	12	13		19.24	19.30	19.34
5	25	0		19.36	19.33	19.35
5	1	0	64-QAM	19.54	19.49	19.66
5	1	12		19.50	19.48	19.51
5	1	24		19.43	19.50	19.55
5	12	0		18.39	18.36	18.51
5	12	7		18.43	18.37	18.42
5	12	13		18.32	18.37	18.42
5	25	0		18.34	18.32	18.38



LTE Band 30

Peak-to-Average Ratio

Mode	LTE Band 30 / 10MHz				
Mod.	QPSK		16QAM		Limit: 13dB
RB Size	1RB	Full RB	1RB	Full RB	Result
Lowest CH	-	-	-	-	PASS
Middle CH	3.86	4.55	4.87	5.42	
Highest CH	-	-	-	-	
Mode	LTE Band 30 / 10MHz				
Mod.	64QAM				Limit: 13dB
RB Size	1RB	Full RB			Result
Lowest CH	-	-	-	-	PASS
Middle CH	5.77	6.03	-	-	
Highest CH	-	-	-	-	



LTE Band 30 / 10MHz / QPSK

Middle Channel / 1RB

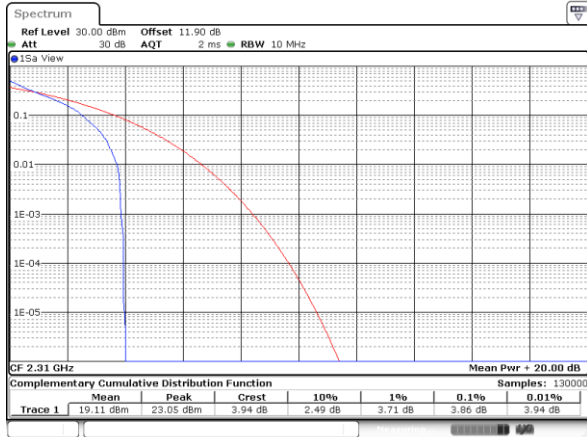

Date: 3.OCT.2017 16:06:16

Middle Channel / Full RB

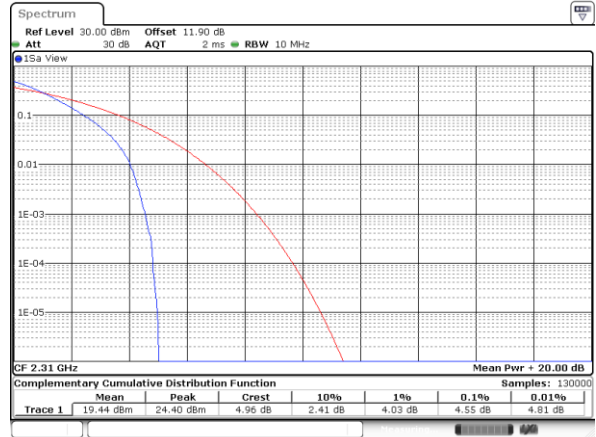

Date: 3.OCT.2017 16:07:52

LTE Band 30 / 10MHz / 16QAM

Middle Channel / 1RB

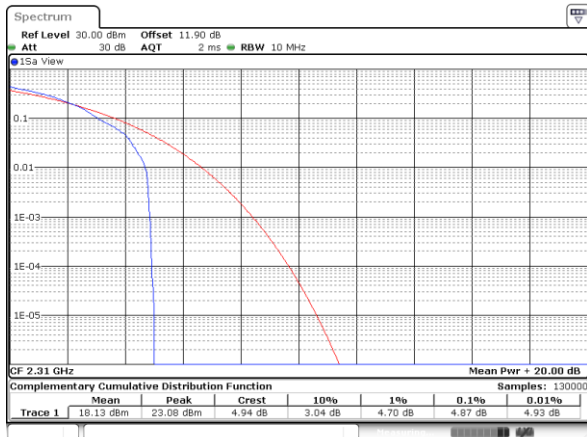

Date: 3.OCT.2017 15:56:51

Middle Channel / Full RB

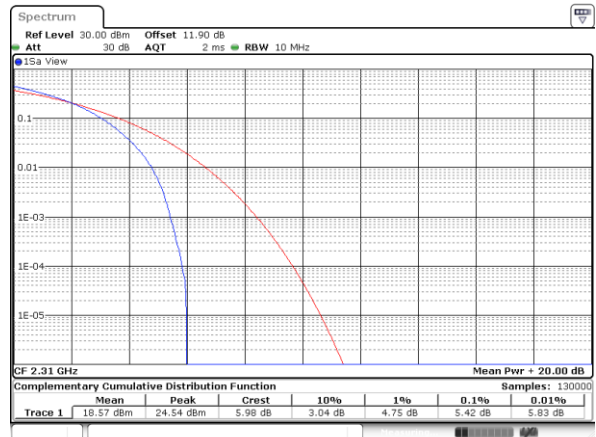

Date: 3.OCT.2017 16:06:06



LTE Band 30 / 10MHz / 64QAM

Middle Channel / 1RB

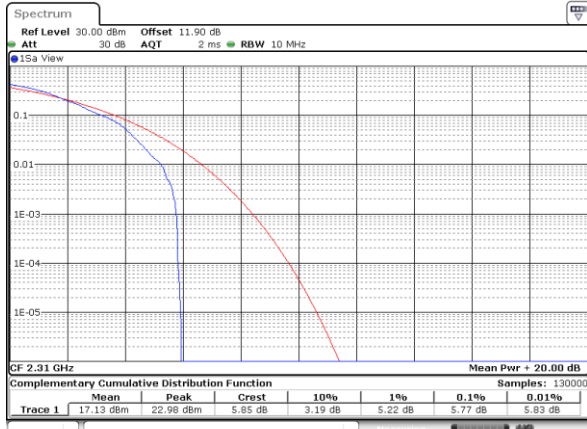

Date: 3.OCT.2017 15:47:02

Middle Channel / Full RB

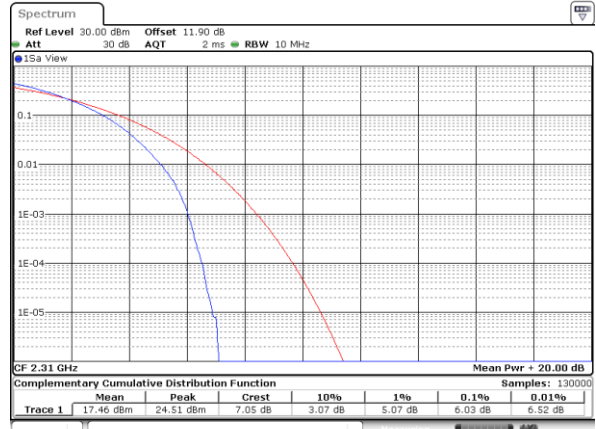

Date: 3.OCT.2017 15:51:40



EIRP Power Density

Mode	LTE Band 30 : Conducted Power Density (dBm/5MHz)											
	1.4MHz		3MHz		5MHz		10MHz		15MHz		20MHz	
Mod.	QPSK	16QAM	QPSK	16QAM	QPSK	16QAM	QPSK	16QAM	QPSK	16QAM	QPSK	16QAM
Lowest CH	-	-	-	-	21.83	21.09	-	-	-	-	-	-
Middle CH	-	-	-	-	21.51	21.05	21.7	20.96	-	-	-	-
Highest CH	-	-	-	-	21.77	20.89	-	-	-	-	-	-

Mode	LTE Band 30 : EIRP Power Density (dBm/5MHz)											
	1.4MHz		3MHz		5MHz		10MHz		15MHz		20MHz	
Mod.	QPSK	16QAM	QPSK	16QAM	QPSK	16QAM	QPSK	16QAM	QPSK	16QAM	QPSK	16QAM
Lowest CH	-	-	-	-	22.83	22.09	-	-	-	-	-	-
Middle CH	-	-	-	-	22.51	22.05	22.7	21.96	-	-	-	-
Highest CH	-	-	-	-	22.77	21.89	-	-	-	-	-	-
Antenna Gain	1 dBi											
Limit	250mW / 5MHz = 24dBm / 5MHz											
Result	Pass											

Mode	LTE Band 30 : Conducted Power Density (dBm/5MHz)											
	1.4MHz		3MHz		5MHz		10MHz		15MHz		20MHz	
Mod.	64QAM		64QAM		64QAM		64QAM		64QAM		64QAM	
Lowest CH	-	-	-	-	20.9	-	-	-	-	-	-	-
Middle CH	-	-	-	-	20.91	-	20.83	-	-	-	-	-
Highest CH	-	-	-	-	21.1	-	-	-	-	-	-	-

Mode	LTE Band 30 : EIRP Power Density (dBm/5MHz)											
	1.4MHz		3MHz		5MHz		10MHz		15MHz		20MHz	
Mod.	64QAM		64QAM		64QAM		64QAM		64QAM		64QAM	
Lowest CH	-	-	-	-	21.9			-	-	-	-	-
Middle CH	-	-	-	-	21.91		21.83	-	-	-	-	-
Highest CH	-	-	-	-	22.1			-	-	-	-	-
Antenna Gain	1 dBi											
Limit	250mW / 5MHz = 24dBm / 5MHz											
Result	Pass											



LTE Band 30 / 5MHz

Lowest Channel / 5MHz / 1RB0 / QPSK



Date: 3.OCT.2017 21:10:35

Lowest Channel / 5MHz / 1RB0 / 16QAM



Date: 3.OCT.2017 21:10:39

Middle Channel / 5MHz / 1RB0 / QPSK



Date: 3.OCT.2017 21:12:46

Middle Channel / 5MHz / 1RB0 / 16QAM



Date: 3.OCT.2017 21:12:51

Highest Channel / 5MHz / 1RB0 / QPSK



Date: 3.OCT.2017 21:12:15

Highest Channel / 5MHz / 1RB0 / 16QAM



Date: 3.OCT.2017 21:12:20



LTE Band 30 / 5MHz

Lowest Channel / 5MHz / 1RB0 / 64QAM



Date: 3.OCT.2017 21:10:35

Middle Channel / 5MHz / 1RB0 / 64QAM



Date: 3.OCT.2017 21:12:46

Highest Channel / 5MHz / 1RB0 / 64QAM



Date: 3.OCT.2017 21:12:15



LTE Band 30 / 10MHz

Lowest Channel / 10MHz / 1RB0 / QPSK



Date: 3.OCT.2017 21:13:23

Lowest Channel / 10MHz / 1RB0 / 16QAM



Date: 3.OCT.2017 21:13:28

Lowest Channel / 10MHz / 1RB0 / 64QAM



Date: 3.OCT.2017 21:13:32



26dB Bandwidth

Mode	LTE Band 30 : 26dB BW(MHz)											
	1.4MHz		3MHz		5MHz		10MHz		15MHz		20MHz	
Mod.	QPSK	16QAM	QPSK	16QAM	QPSK	16QAM	QPSK	16QAM	QPSK	16QAM	QPSK	16QAM
Lowest CH	-	-	-	-	4.915	4.835	-	-	-	-	-	-
Middle CH	-	-	-	-	4.915	4.915	9.81	9.79	-	-	-	-
Highest CH	-	-	-	-	4.925	4.855	-	-	-	-	-	-

Mode	LTE Band 30 : 26dB BW(MHz)											
	1.4MHz		3MHz		5MHz		10MHz		15MHz		20MHz	
Mod.	64QAM		64QAM		64QAM		64QAM		64QAM		64QAM	
Lowest CH	-	-	-	-	4.865	-	-	-	-	-	-	-
Middle CH	-	-	-	-	4.925	-	9.69	-	-	-	-	-
Highest CH	-	-	-	-	4.905	-	-	-	-	-	-	-



LTE Band 30

Lowest Channel / 5MHz / QPSK

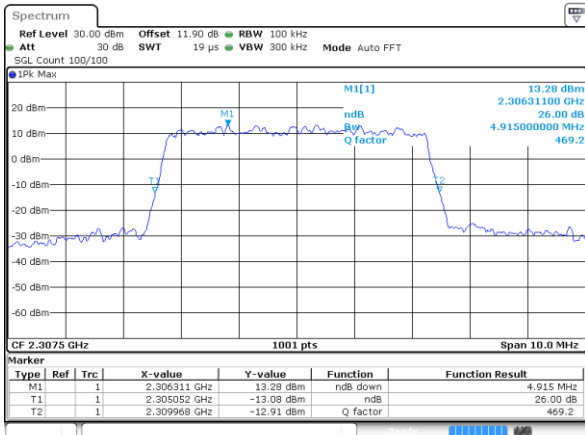

Date: 3.OCT.2017 15:18:11

Lowest Channel / 5MHz / 16QAM

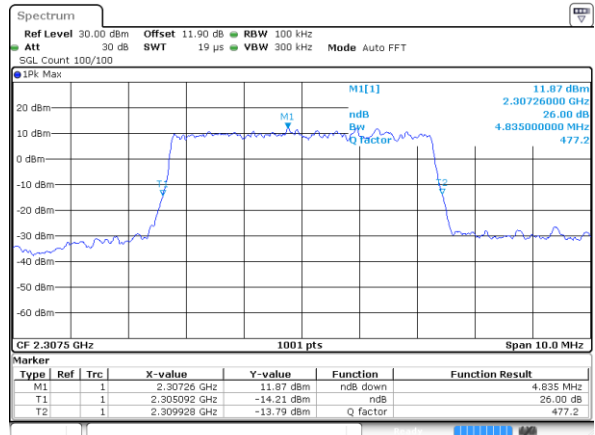

Date: 3.OCT.2017 15:18:21

Middle Channel / 5MHz / QPSK

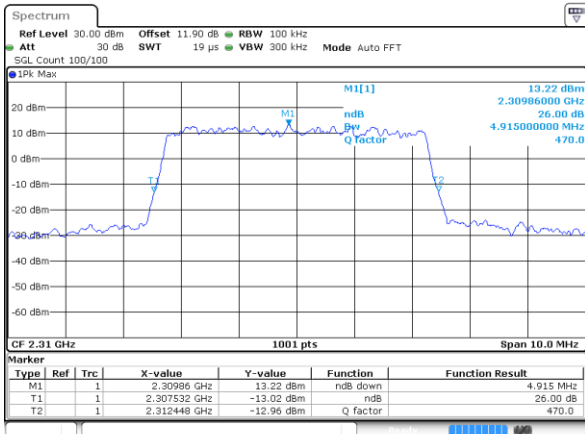

Date: 3.OCT.2017 15:23:29

Middle Channel / 5MHz / 16QAM

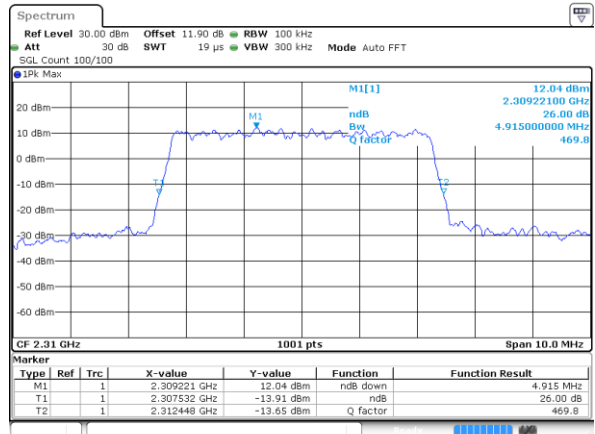

Date: 3.OCT.2017 15:23:39

Highest Channel / 5MHz / QPSK

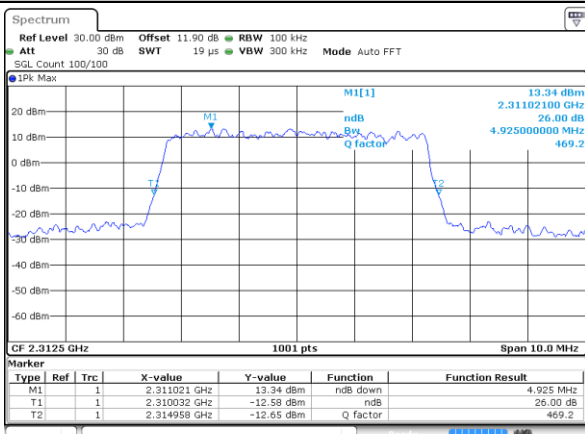

Date: 3.OCT.2017 15:24:09

Highest Channel / 5MHz / 16QAM

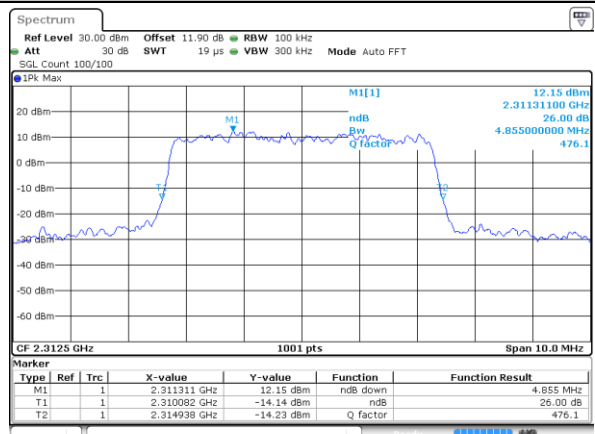

Date: 3.OCT.2017 15:24:19



LTE Band 30

Middle Channel / 10MHz / QPSK

Middle Channel / 10MHz / 16QAM

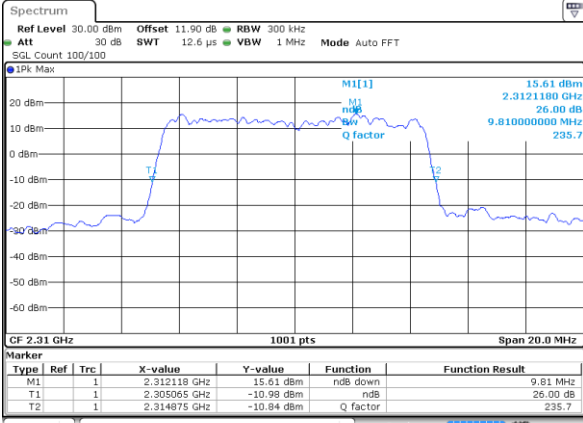

Date: 3.OCT.2017 15:29:27

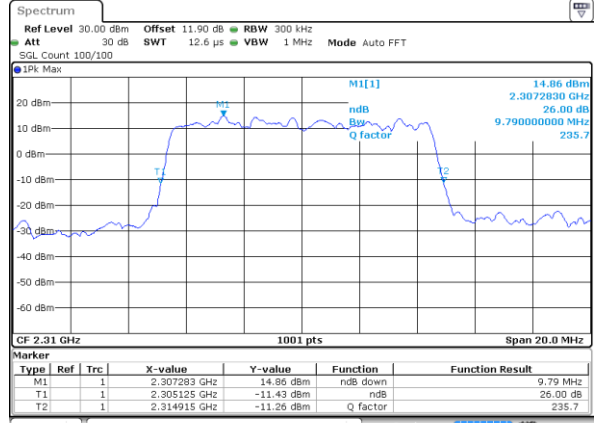

Date: 3.OCT.2017 15:29:37



LTE Band 30

Lowest Channel / 5MHz / 64QAM

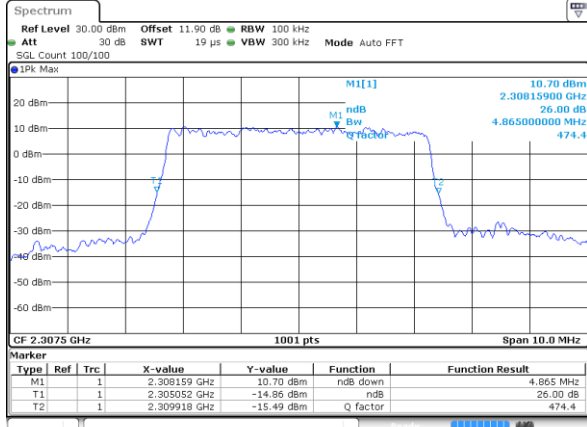

Date: 3.OCT.2017 15:36:53

Middle Channel / 5MHz / 64QAM

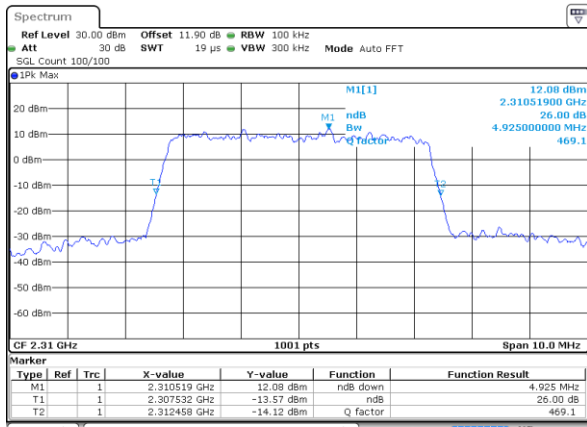

Date: 3.OCT.2017 15:39:32

Middle Channel / 10MHz / 64QAM

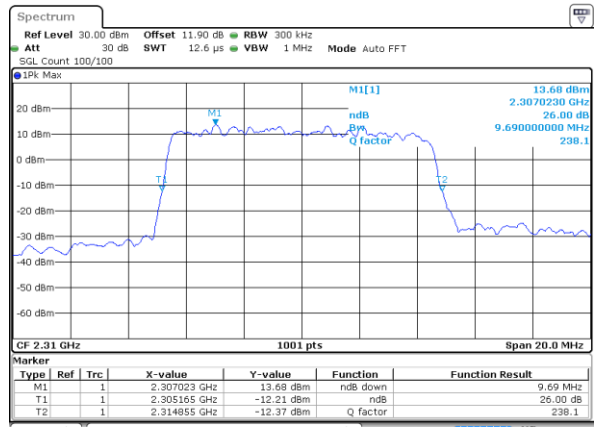

Date: 3.OCT.2017 15:42:31

Highest Channel / 5MHz / 64QAM

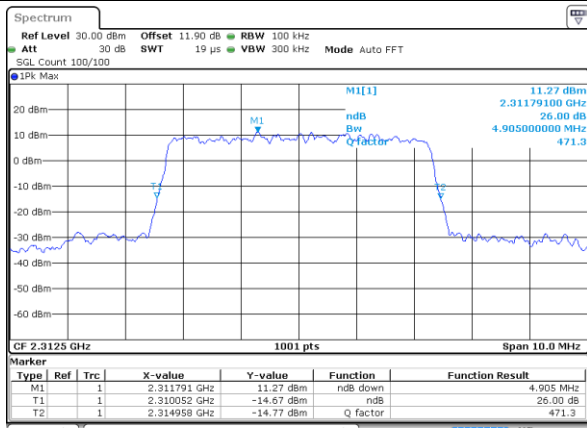

Date: 3.OCT.2017 15:39:52



Occupied Bandwidth

Mode	LTE Band 30 : 99%OBW(MHz)											
	1.4MHz		3MHz		5MHz		10MHz		15MHz		20MHz	
Mod.	QPSK	16QAM	QPSK	16QAM	QPSK	16QAM	QPSK	16QAM	QPSK	16QAM	QPSK	16QAM
Lowest CH	-	-	-	-	4.5	4.47	-	-	-	-	-	-
Middle CH	-	-	-	-	4.51	4.48	8.99	9.05	-	-	-	-
Highest CH	-	-	-	-	4.49	4.47	-	-	-	-	-	-

Mode	LTE Band 30 : 99%OBW(MHz)											
	1.4MHz		3MHz		5MHz		10MHz		15MHz		20MHz	
Mod.	64QAM		64QAM		64QAM		64QAM		64QAM		64QAM	
Lowest CH	-	-	-	-	4.5	-	-	-	-	-	-	-
Middle CH	-	-	-	-	4.49	-	8.99	-	-	-	-	-
Highest CH	-	-	-	-	4.48	-	-	-	-	-	-	-



LTE Band 30

Lowest Channel / 5MHz / QPSK

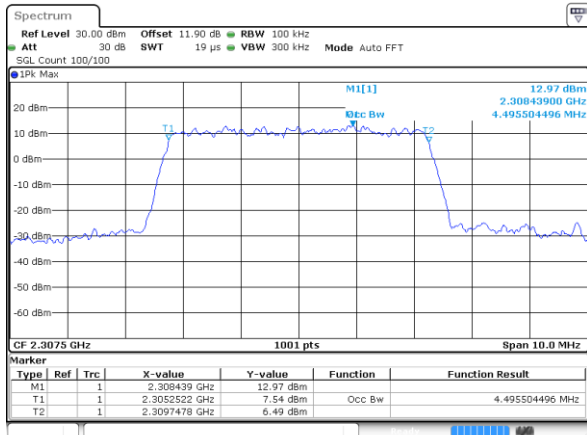

Date: 3.OCT.2017 15:17:51

Lowest Channel / 5MHz / 16QAM

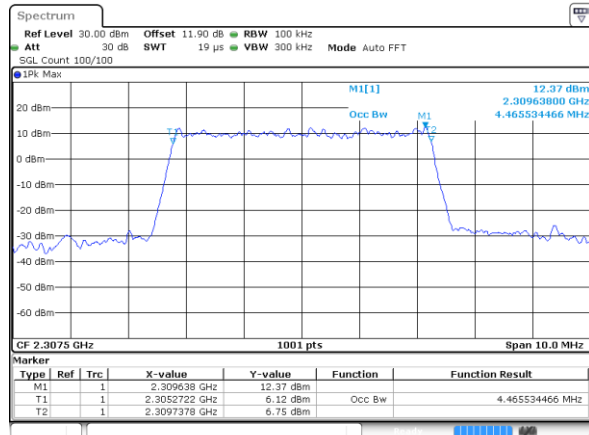

Date: 3.OCT.2017 15:18:01

Middle Channel / 5MHz / QPSK

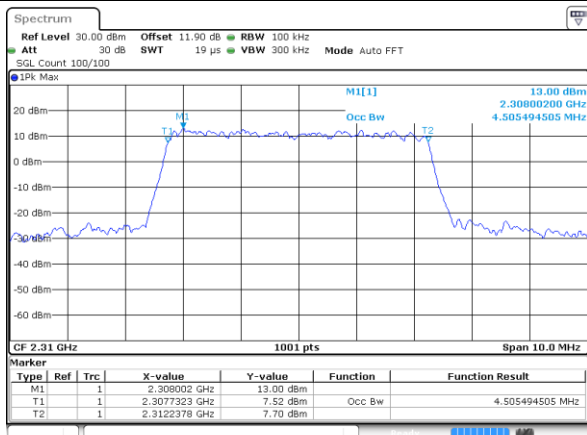

Date: 3.OCT.2017 15:23:09

Middle Channel / 5MHz / 16QAM

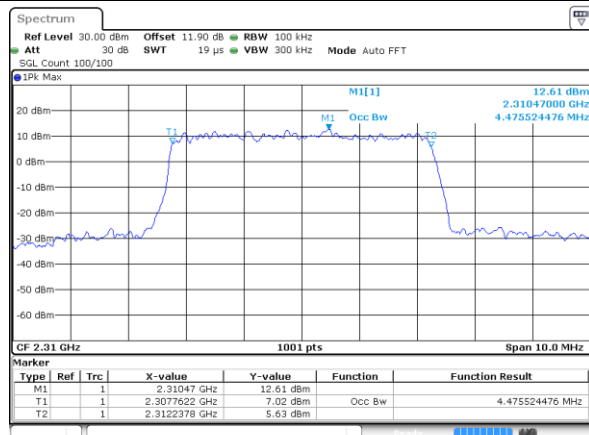

Date: 3.OCT.2017 15:23:19

Highest Channel / 5MHz / QPSK

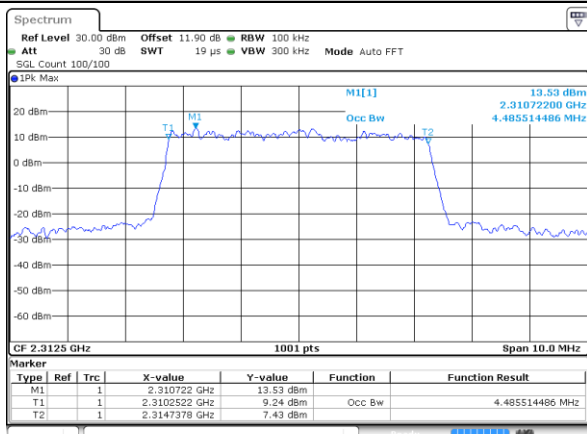

Date: 3.OCT.2017 15:23:49

Highest Channel / 5MHz / 16QAM

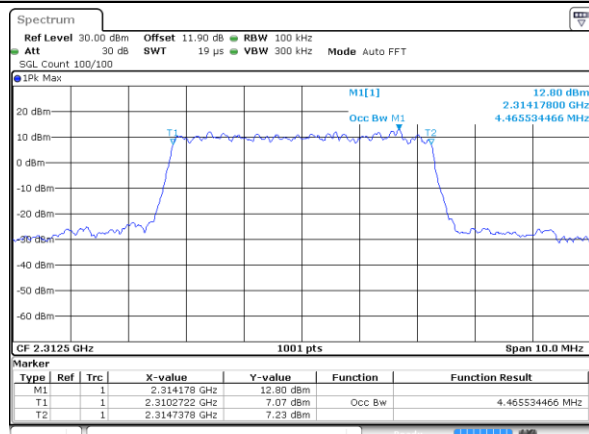

Date: 3.OCT.2017 15:23:59



LTE Band 30

Middle Channel / 10MHz / QPSK

Middle Channel / 10MHz / 16QAM

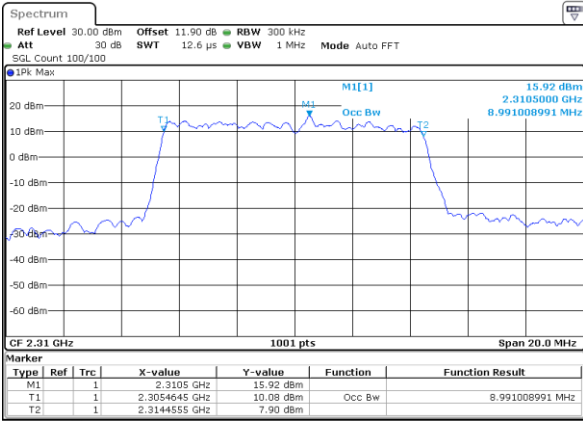

Date: 3.OCT.2017 15:29:07

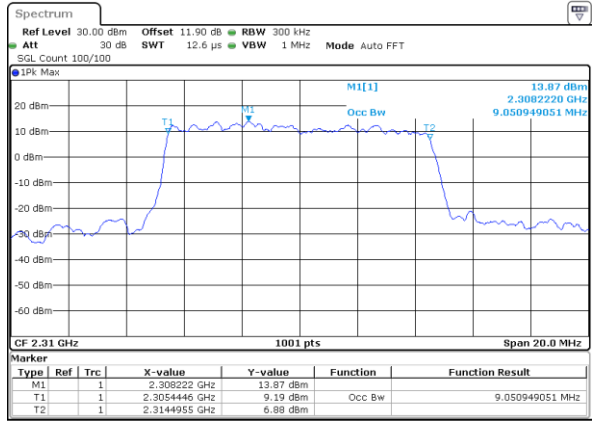

Date: 3.OCT.2017 15:29:17



LTE Band 30

Lowest Channel / 5MHz / 64QAM

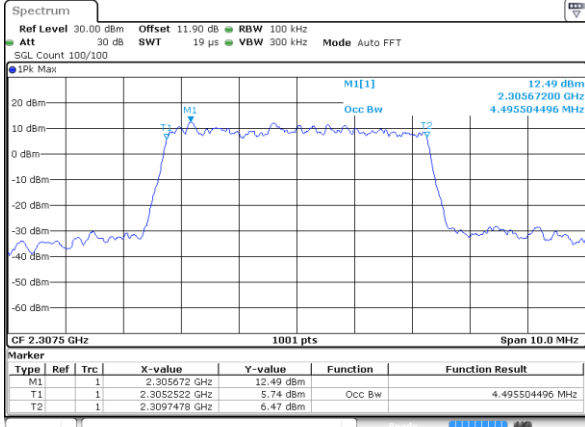

Date: 3.OCT.2017 15:36:43

Middle Channel / 5MHz / 64QAM

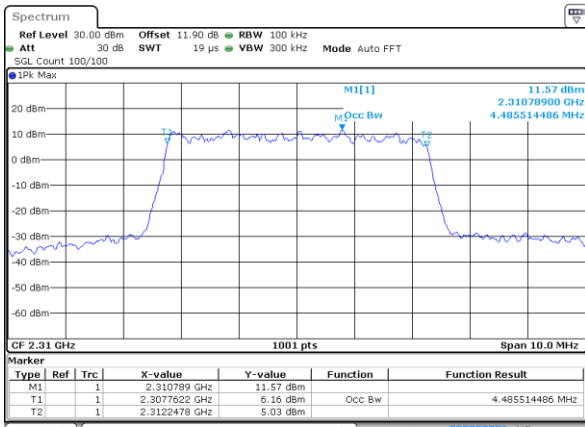

Date: 3.OCT.2017 15:39:22

Middle Channel / 10MHz / 64QAM

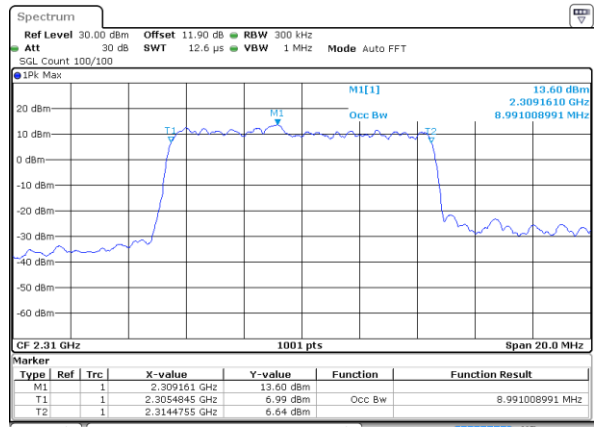

Date: 3.OCT.2017 15:42:21

Highest Channel / 5MHz / 64QAM

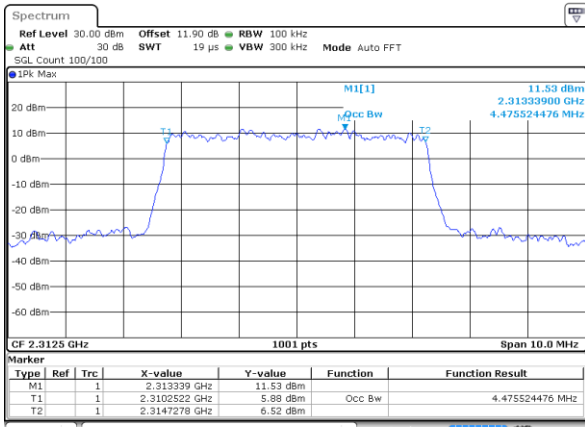

Date: 3.OCT.2017 15:39:42



Conducted Band Edge



LTE Band 30 / 5MHz / QPSK

Lowest Band Edge / 1 RB

Highest Band Edge / 1 RB

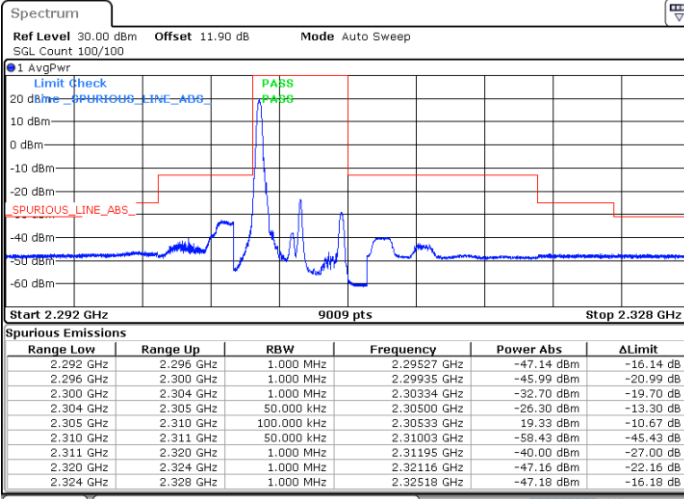

Date: 3.OCT.2017 15:19:30

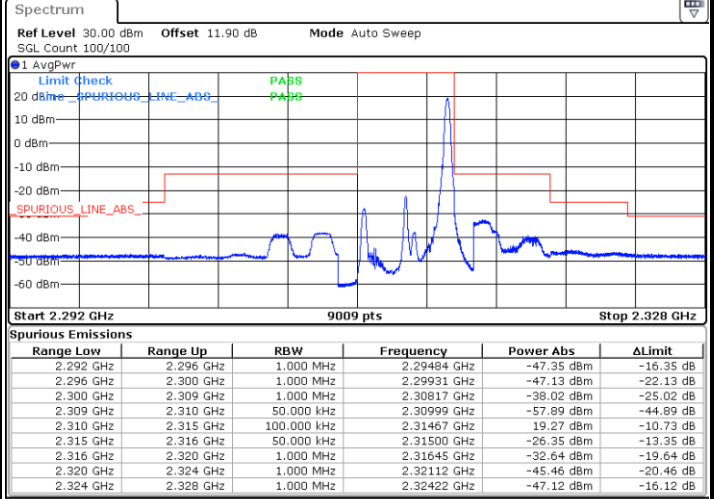

Date: 3.OCT.2017 15:25:28

Lowest Band Edge / Full RB

Highest Band Edge / Full RB

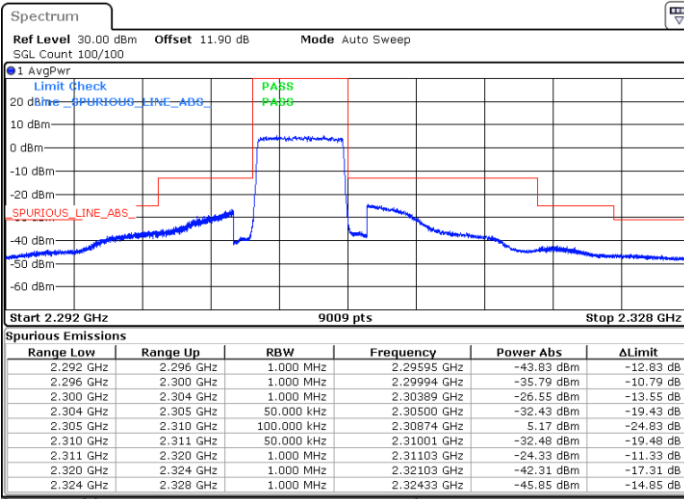

Date: 3.OCT.2017 15:21:49

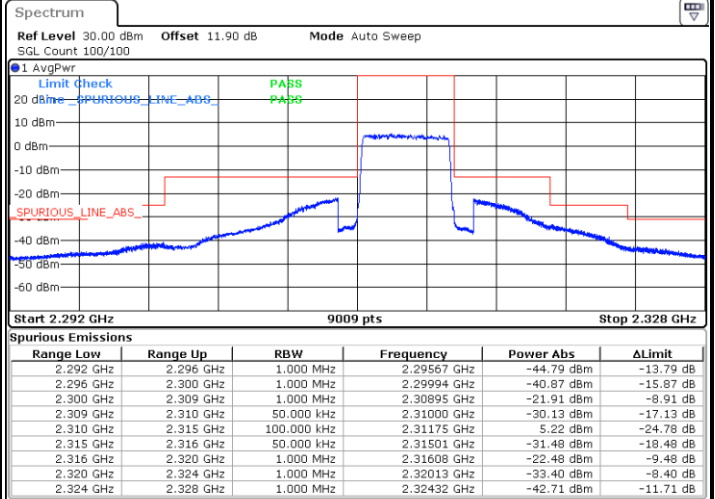

Date: 3.OCT.2017 15:27:47



LTE Band 30 / 5MHz / 16QAM

Lowest Band Edge / 1RB

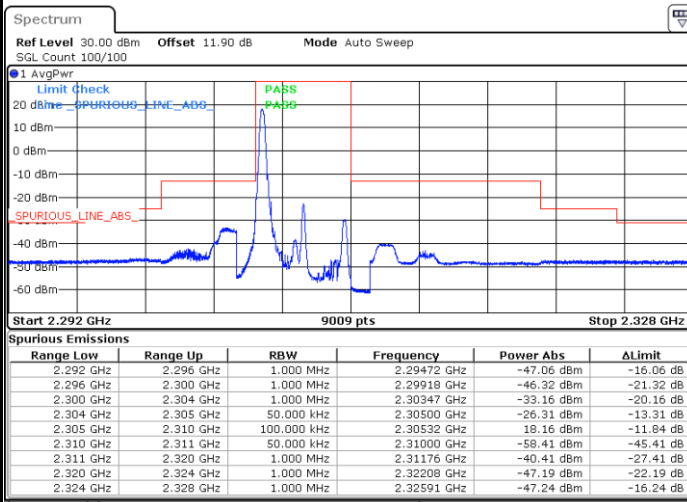

Date: 3.OCT.2017 15:20:39

Highest Band Edge / 1 RB

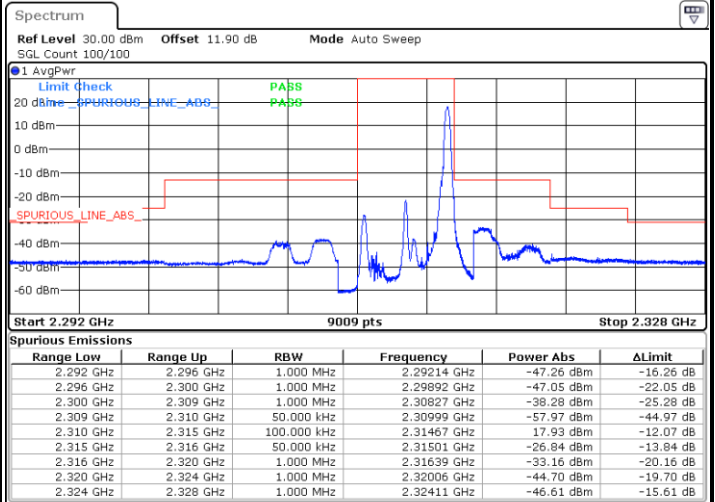

Date: 3.OCT.2017 15:26:37

Lowest Band Edge / Full RB

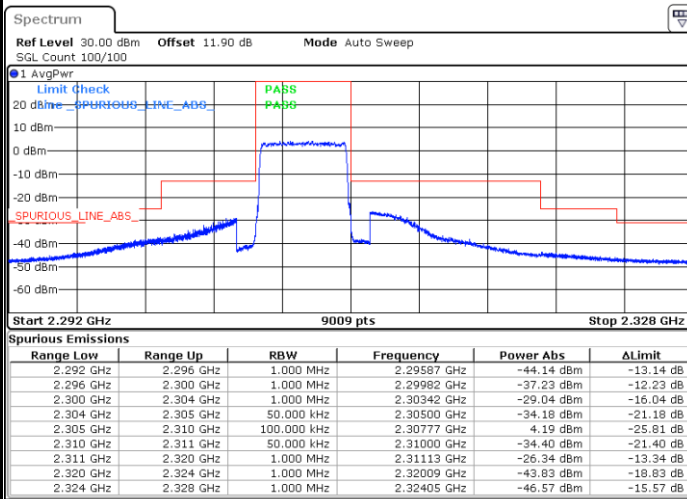

Date: 3.OCT.2017 15:22:58

Highest Band Edge / Full RB

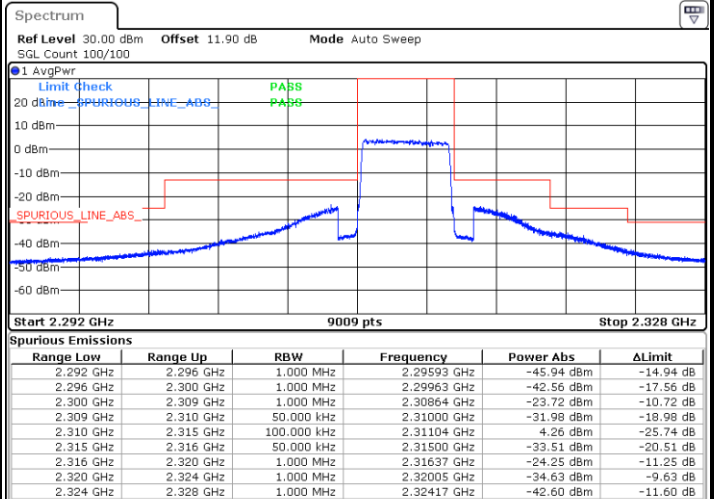

Date: 3.OCT.2017 15:28:56



LTE Band 30 / 5MHz / 64QAM

Lowest Band Edge / 1RB

Highest Band Edge / 1 RB

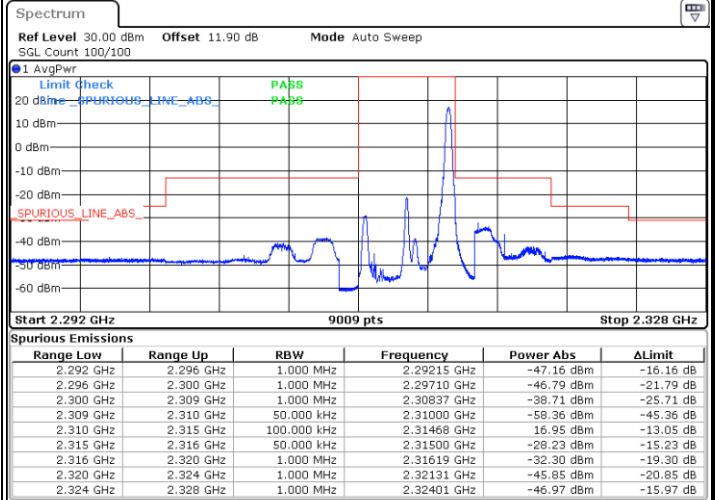
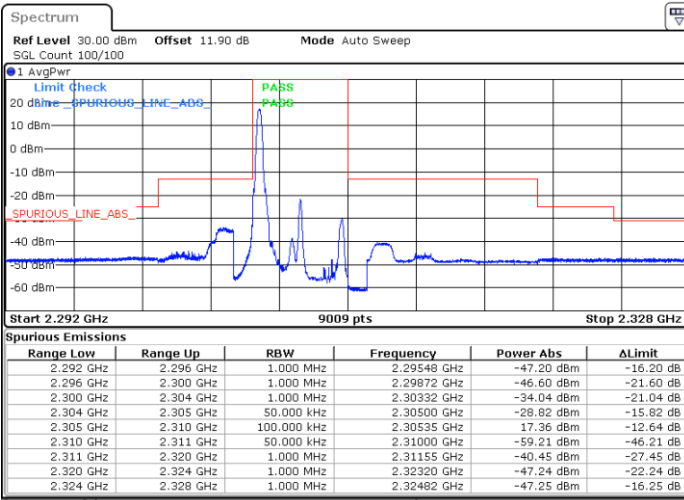

Date: 3.OCT.2017 15:38:02

Date: 3.OCT.2017 15:41:01

Lowest Band Edge / Full RB

Highest Band Edge / Full RB

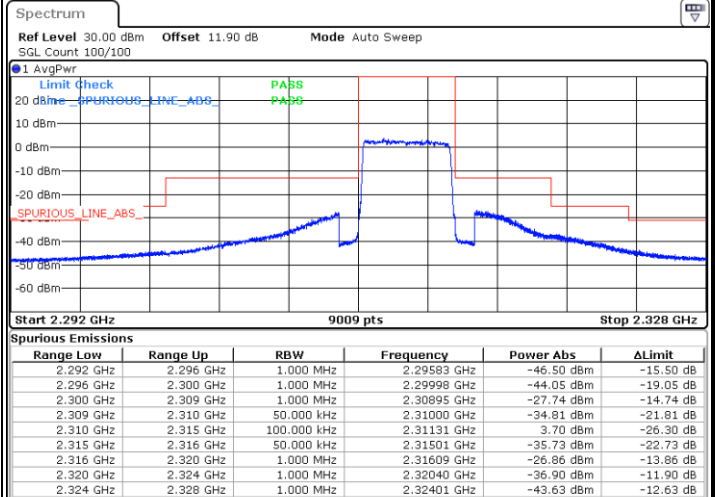
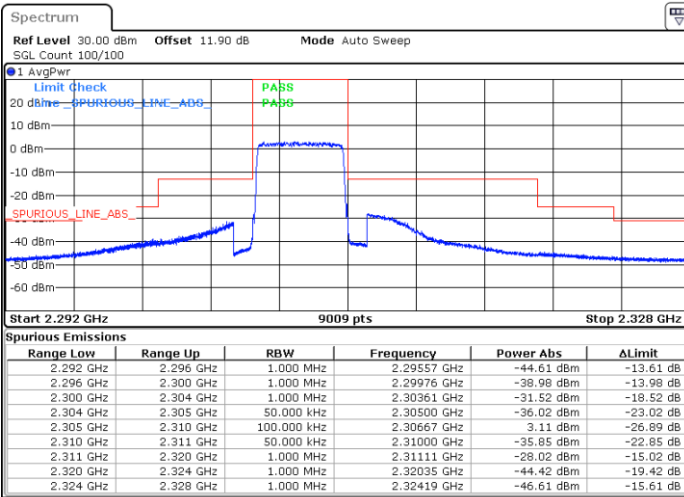

Date: 3.OCT.2017 15:39:12

Date: 3.OCT.2017 15:42:10



LTE Band 30 / 10MHz / QPSK

Lowest Band Edge / 1 RB

Highest Band Edge / 1 RB

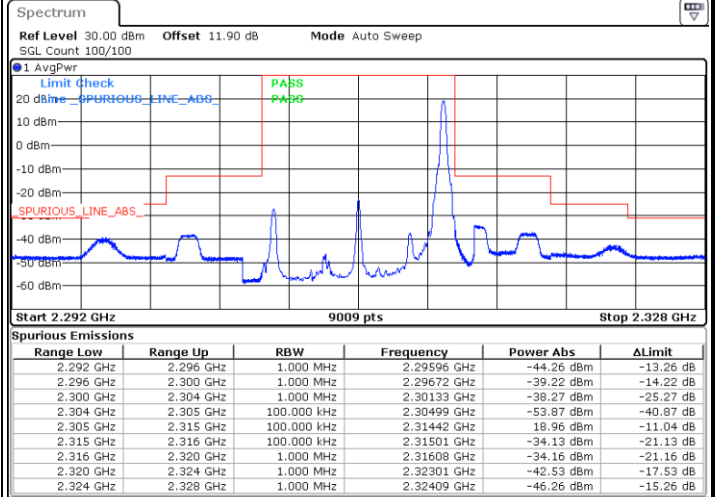
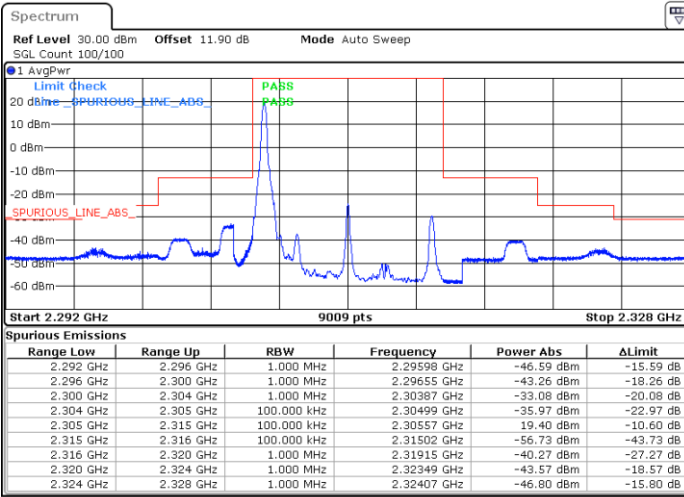

Date: 3 OCT.2017 15:30:46

Date: 3 OCT.2017 15:33:04

Band Edge / Full RB

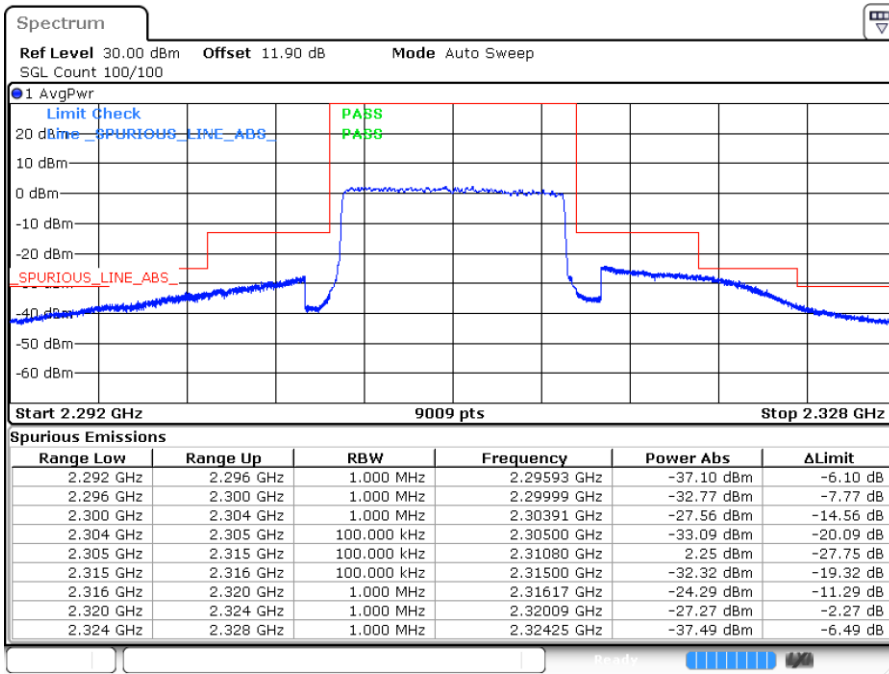

Date: 3 OCT.2017 15:35:23



LTE Band 30 / 10MHz / 16QAM

Lowest Band Edge / 1 RB

Highest Band Edge / 1 RB

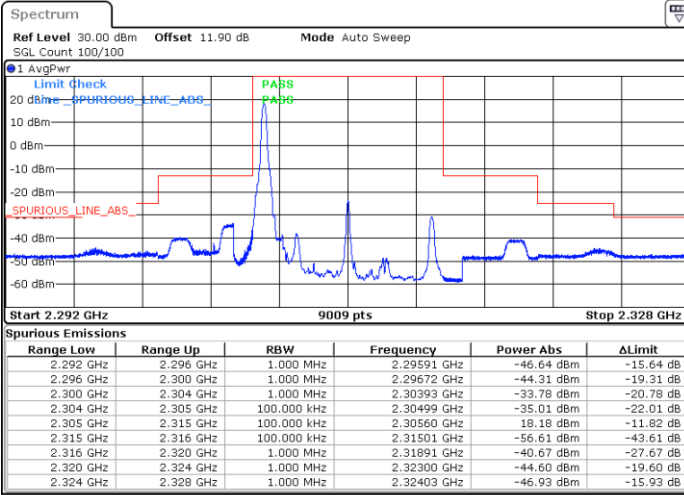

Date: 3 OCT 2017 15:31:55

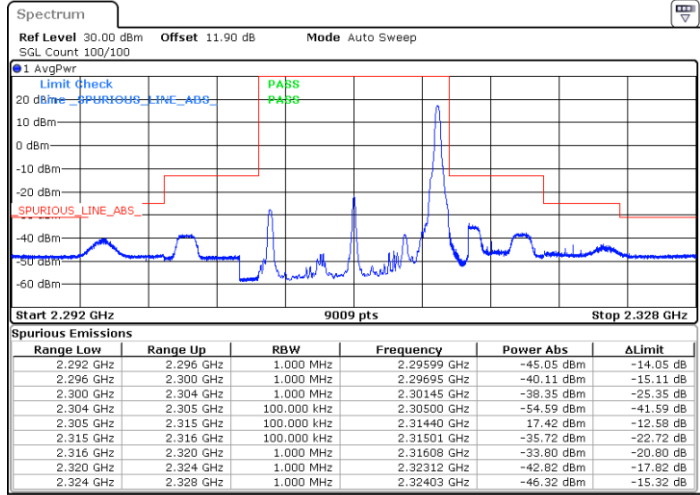

Date: 3 OCT 2017 15:34:14

Band Edge / Full RB

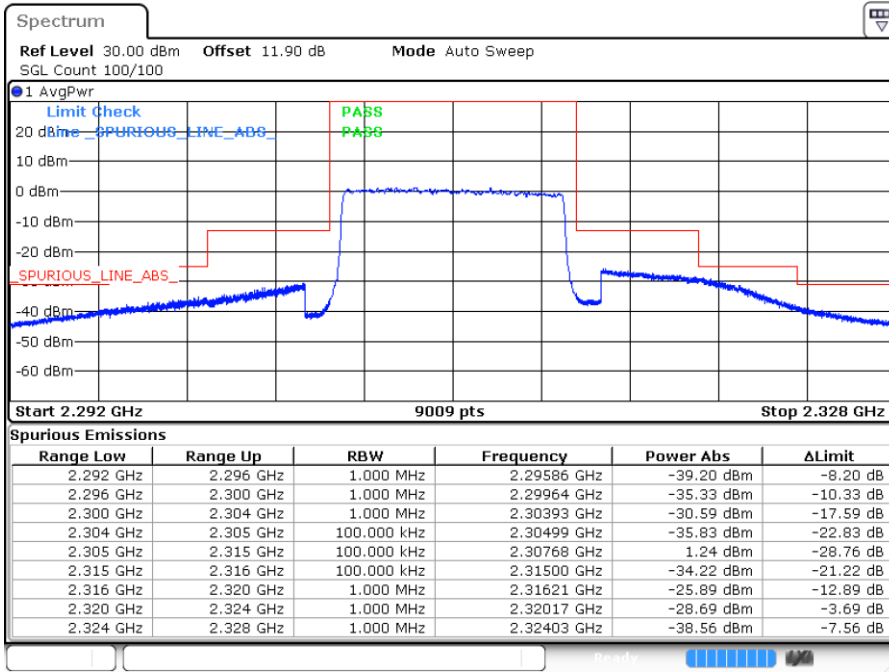

Date: 3 OCT 2017 15:36:33



LTE Band 30 / 10MHz / 64QAM

Lowest Band Edge / 1 RB

Highest Band Edge / 1 RB

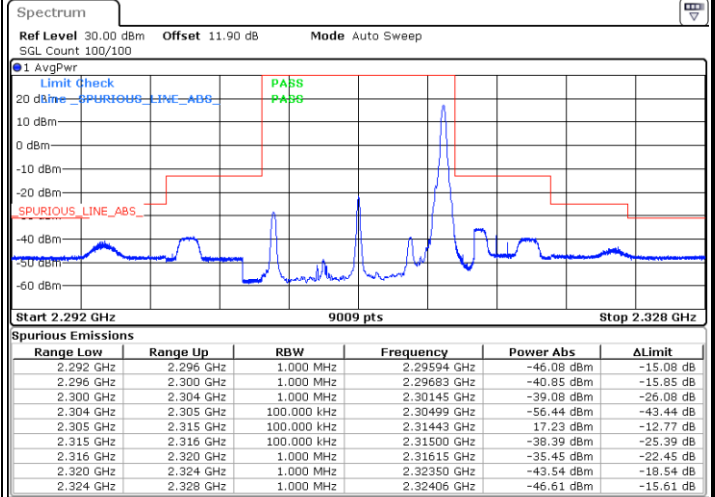
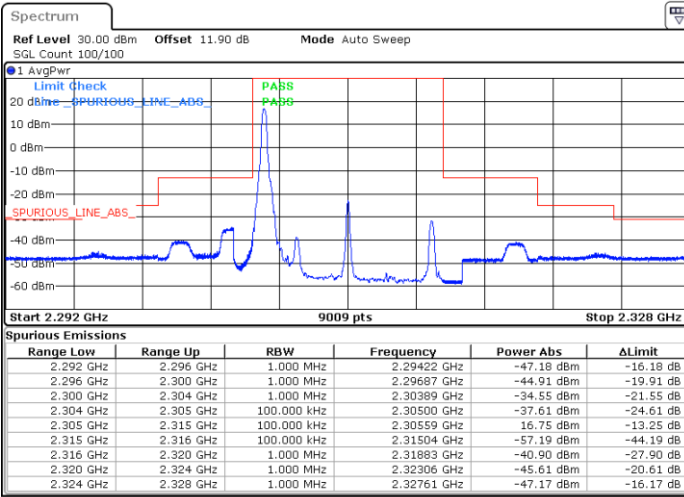

Date: 3 OCT 2017 15:43:40

Date: 3 OCT 2017 15:44:49

Band Edge / Full RB

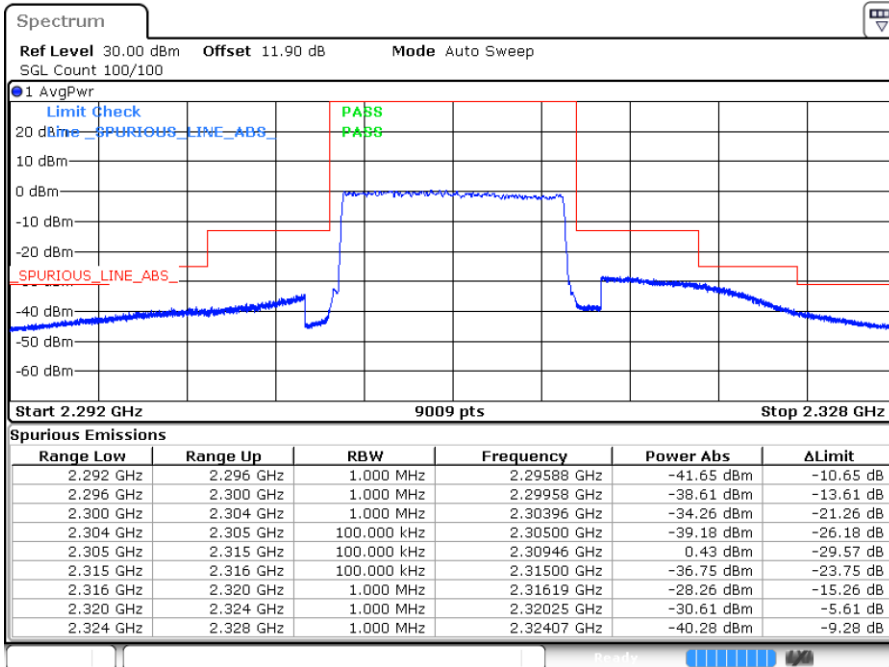

Date: 3 OCT 2017 15:45:58



Conducted Spurious Emission



LTE Band 30 / 5MHz

Lowest Channel / QPSK

Lowest Channel / 16QAM

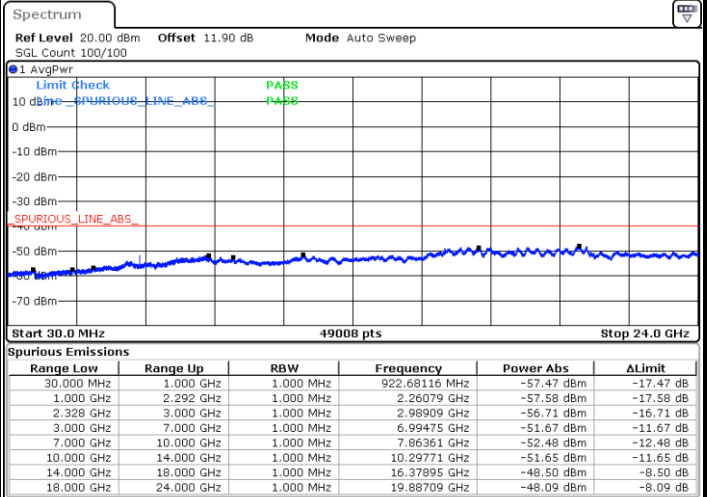
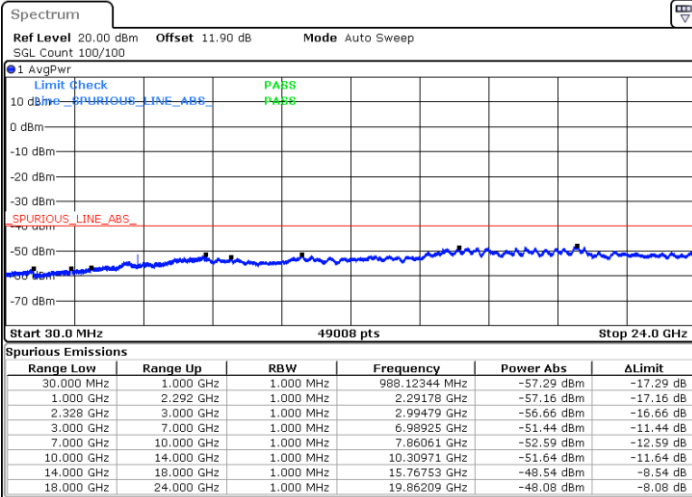

Date: 2.OCT.2017 10:52:51

Date: 2.OCT.2017 10:53:44

Middle Channel / QPSK

Middle Channel / 16QAM

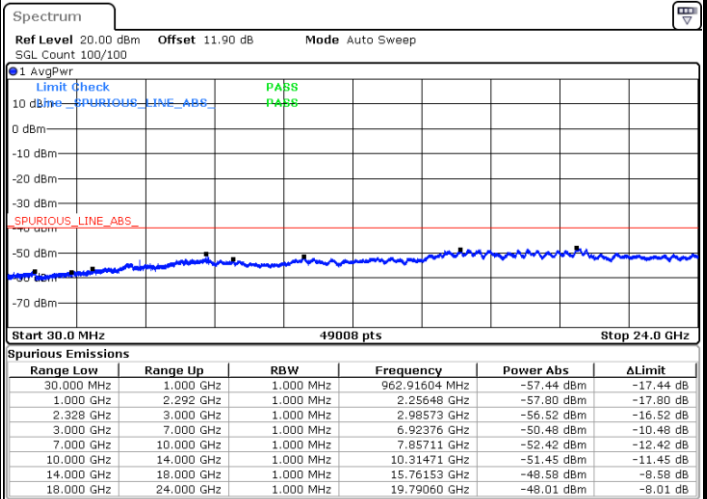
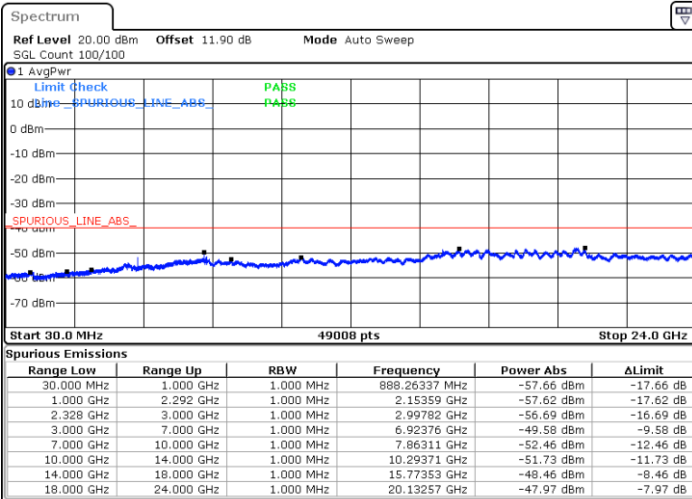

Date: 2.OCT.2017 10:54:37

Date: 2.OCT.2017 10:55:30



LTE Band 30 / 5MHz

Highest Channel / QPSK

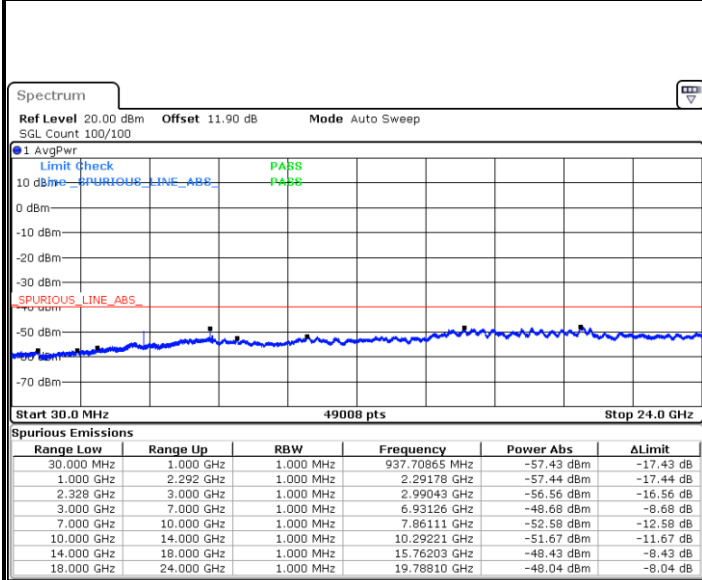

Date: 2.OCT.2017 10:56:24

Highest Channel / 16QAM

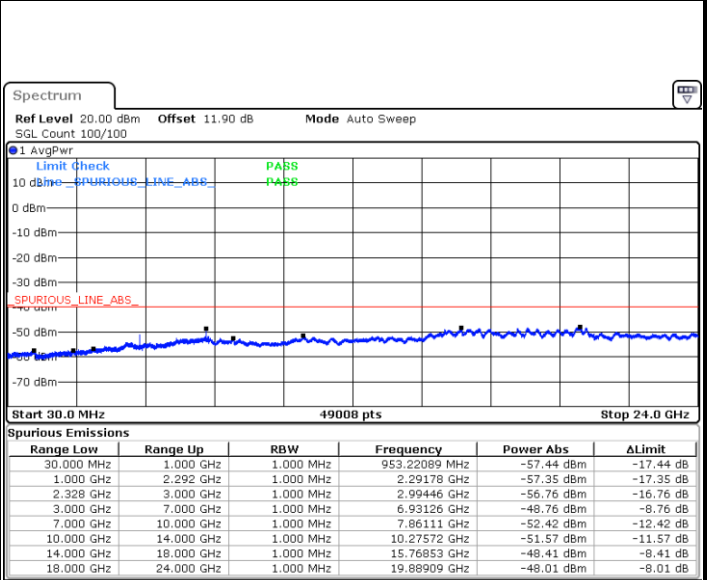

Date: 2.OCT.2017 10:57:17

LTE Band 30 / 10MHz

Middle Channel / QPSK

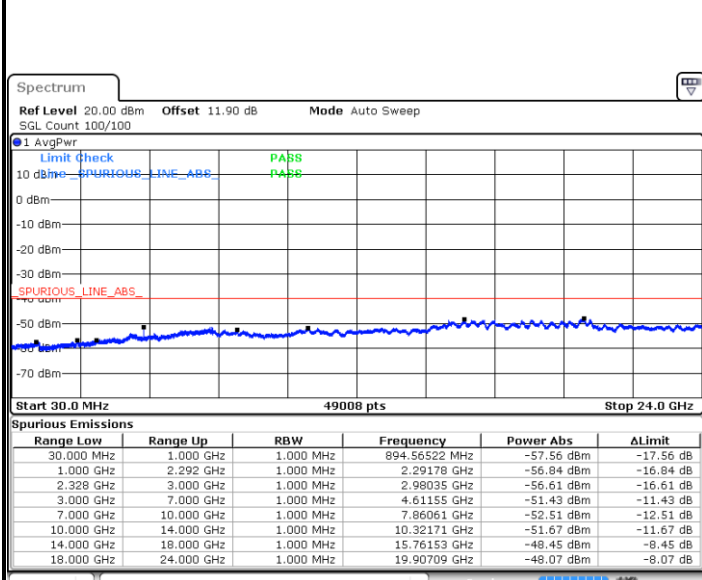

Date: 2.OCT.2017 10:58:10

Middle Channel / 16QAM

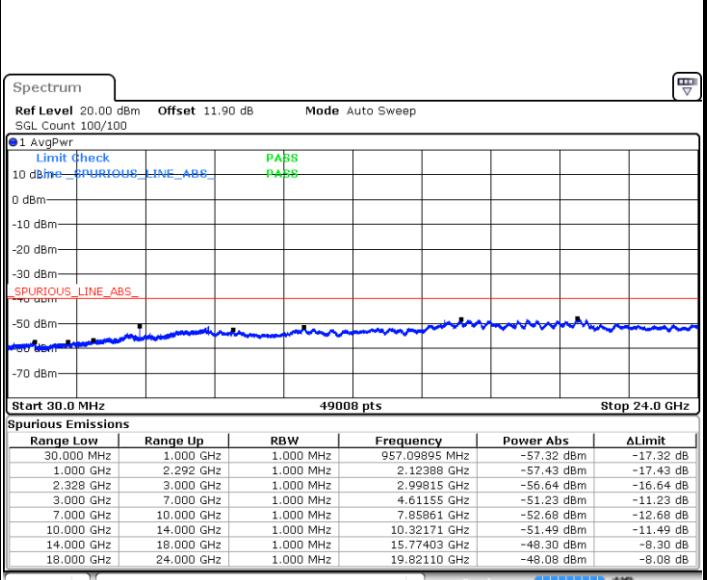

Date: 2.OCT.2017 10:59:03



LTE Band 30 / 5MHz

Lowest Channel / 64QAM

Middle Channel / 64QAM

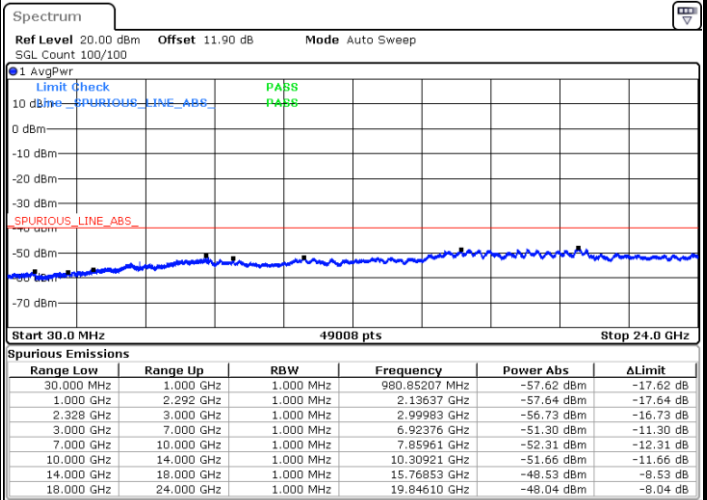
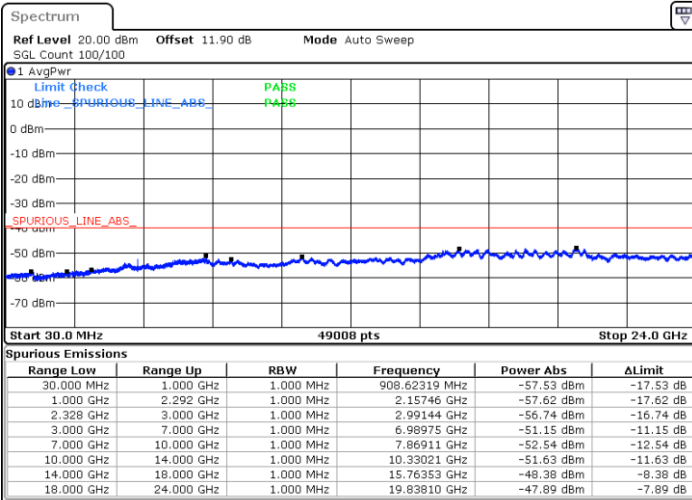

Date: 2.OCT.2017 11:00:14

Date: 2.OCT.2017 11:01:07

Highest Channel / 64QAM

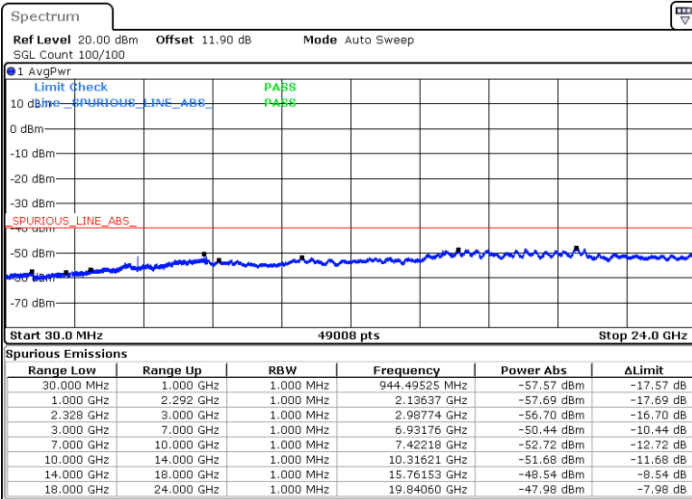

Date: 2.OCT.2017 11:02:00



LTE Band 30 / 10MHz

Middle Channel / 64QAM

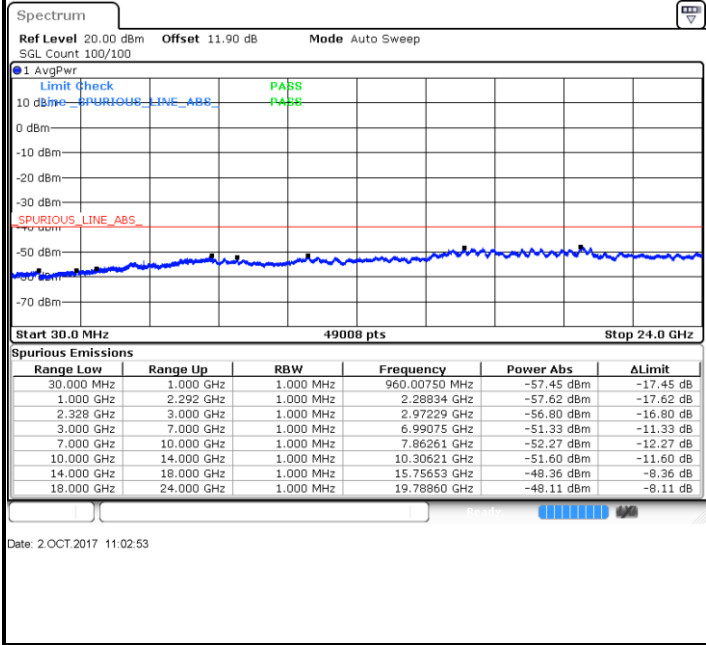



Frequency Stability

Test Conditions		LTE Band 30 (QPSK) / Middle Channel	Limit
Temperature (°C)	Voltage (Volt)	BW 10MHz	Note 2.
		Deviation (ppm)	Result
50	Normal Voltage	0.0064	PASS
40	Normal Voltage	0.0006	
30	Normal Voltage	0.0047	
20(Ref.)	Normal Voltage	0.0000	
10	Normal Voltage	0.0047	
0	Normal Voltage	0.0059	
-10	Normal Voltage	0.0003	
-20	Normal Voltage	0.0007	
-30	Normal Voltage	0.0056	
20	Maximum Voltage	0.0053	
20	Normal Voltage	0.0000	
20	Battery End Point	0.0057	

Note:

1. Normal Voltage =3.3 V. ; Battery End Point (BEP) =3.135 V. ; Maximum Voltage =4.4 V.
2. Note: The frequency fundamental emissions stay within the authorized frequency block.



Appendix B. Test Results of Radiated Test

Radiated Spurious Emission

LTE Band 30

LTE Band 30 / 5MHz / QPSK									
Channel	Frequency (MHz)	ERP (dBm)	Limit (dBm)	Over Limit (dB)	SPA Reading (dBm)	S.G. Power (dBm)	TX Cable loss (dB)	TX Antenna Gain (dBi)	Polarization (H/V)
Lowest	4614	-55.06	-40	-15.06	-52.66	-61.87	2.11	8.93	H
	6918	-46.01	-40	-6.01	-50.44	-54.09	2.62	10.70	H
	11520	-51.29	-40	-11.29	-63.93	-60.91	2.68	12.30	H
									H
									H
									H
									H
	4614	-58.02	-40	-18.02	-55.62	-64.83	2.11	8.93	V
	6918	-44.39	-40	-4.39	-48.69	-52.47	2.62	10.70	V
	11520	-47.55	-40	-7.55	-60.12	-57.17	2.68	12.30	V
									V
									V
									V
									V



Middle	4614	-54.86	-13	-41.86	-52.56	-61.67	2.11	8.93	H
	6924	-45.36	-13	-32.36	-49.75	-53.45	2.62	10.71	H
	11538	-54.07	-13	-41.07	-66.7	-63.69	2.68	12.30	H
									H
									H
									H
									H
	4614	-56.87	-13	-43.87	-54.57	-63.68	2.11	8.93	V
	6924	-43.35	-13	-30.35	-47.8	-51.44	2.62	10.71	V
	11538	-48.53	-13	-35.53	-61.06	-58.15	2.68	12.30	V
									V
									V
									V
									V
Highest	4620	-56.67	-40	-16.67	-54.04	-63.49	2.12	8.94	H
	6930	-47.68	-40	-7.68	-51.7	-55.78	2.61	10.72	H
	9234	-57.72	-40	-17.72	-63.81	-67.79	2.53	12.61	H
	11556	-51.33	-40	-11.33	-63.66	-60.95	2.68	12.30	H
									H
									H
									H
	4620	-56.34	-40	-16.34	-53.7	-63.16	2.12	8.94	V
	6930	-41.11	-40	-1.11	-48.66	-49.21	2.61	10.72	V
	9234	-55.17	-40	-15.17	-61.67	-65.24	2.53	12.61	V
	11556	-46.63	-40	-6.63	-58.88	-56.25	2.68	12.30	V
									V
									V
									V
								V	

Remark: Spurious emissions within 30-1000MHz were found more than 20dB below limit line.



LTE Band 30 / 10MHz / QPSK									
Channel	Frequency (MHz)	ERP (dBm)	Limit (dBm)	Over Limit (dB)	SPA Reading (dBm)	S.G. Power (dBm)	TX Cable loss (dB)	TX Antenna Gain (dBi)	Polarization (H/V)
Middle	4614	-55.94	-40	-15.94	-53.32	-62.75	2.11	8.93	H
	6918	-46.56	-40	-6.56	-50.63	-54.64	2.62	10.70	H
	9216	-57.93	-40	-17.93	-64.08	-68.01	2.53	12.61	H
	11538	-53.91	-40	-13.91	-66.25	-63.53	2.68	12.30	H
									H
									H
									H
	4614	-55.27	-40	-15.27	-52.64	-62.08	2.11	8.93	V
	6918	-45.16	-40	-5.16	-49.26	-53.24	2.62	10.70	V
	9216	-54.83	-40	-14.83	-61.38	-64.91	2.53	12.61	V
	11538	-45.97	-40	-5.97	-58.28	-55.59	2.68	12.30	V
	13842	-53.52	-40	-13.52	-66.32	-64.42	3.14	14.04	V
									V
									V

Remark: Spurious emissions within 30-1000MHz were found more than 20dB below limit line.