



FCC RADIO TEST REPORT

FCC ID : N7NEM7455
Equipment : PCI Express Mini Card
Brand Name : AirPrime
Model Name : EM7455
Applicant : Sierra Wireless Inc.
 13811 Wireless Way, Richmond, BC Canada V6V 3A4
Manufacturer : Sierra Wireless Inc.
 13811 Wireless Way, Richmond, BC Canada V6V 3A4
Standard : FCC 47 CFR Part 2, 27

The product was received on Feb. 08, 2022 and testing was performed from Feb. 17, 2022 to Feb. 21, 2022. We, Sporton International Inc. EMC & Wireless Communications Laboratory, would like to declare that the tested sample has been evaluated in accordance with the test procedures given in ANSI / TIA-603-E and has been in compliance with the applicable technical standards.

The test results in this partial report apply exclusively to the tested model / sample. Without written approval of Sporton International Inc. EMC & Wireless Communications Laboratory, the test report shall not be reproduced except in full.

Louis Wu

Approved by: Louis Wu

Sporton International Inc. EMC & Wireless Communications Laboratory

No. 52, Huaya 1st Rd., Guishan Dist., Taoyuan City 333, Taiwan (R.O.C.)



Table of Contents

History of this test report..... 3

Summary of Test Result..... 4

1 General Description 5

 1.1 Product Feature of Equipment Under Test..... 5

 1.2 Modification of EUT 5

 1.3 Testing Location 5

 1.4 Applicable Standards..... 5

2 Test Configuration of Equipment Under Test 6

 2.1 Test Mode..... 6

 2.2 Connection Diagram of Test System..... 7

 2.3 Support Unit used in test configuration and system 7

 2.4 Measurement Results Explanation Example..... 7

 2.5 Frequency List of Low/Middle/High Channels 8

3 Conducted Test Items..... 9

 3.1 Measuring Instruments 9

 3.2 Conducted Output Power Measurement 10

4 Radiated Test Items 11

 4.1 Measuring Instruments 11

 4.2 Radiated Spurious Emission Measurement 13

5 List of Measuring Equipment..... 14

6 Uncertainty of Evaluation 15

Appendix A. Test Results of Conducted Test

Appendix B. Test Results of Radiated Test

Appendix C. Test Setup Photographs

Appendix D. Test report



Summary of Test Result

Report Clause	Ref Std. Clause	Test Items	Result (PASS/FAIL)	Remark
3.2	§2.1046	Conducted Output Power	Reporting only	-
-	§2.1051 §27.1507 (d)	Peak-to-Average Ratio	-	See Note
-	§2.1049 §27.1506	Occupied Bandwidth	-	See Note
-	§2.1051 §27.1509 (a)	Conducted Band Edge Measurement	-	See Note
-	§2.1051 §27.1509 (a)	Conducted Spurious Emission	-	See Note
-	§2.1055	Frequency Stability Temperature & Voltage	-	See Note
4.2	§2.1051 §27.1509 (a)	Radiated Spurious Emission	Pass	Under limit 36.75dB at 8990.000 MHz

Remark:

- The test data in the report is tested using LTE-licensed transmitters for frequency band 8 (897.5 MHz-900.5 MHz) with 45MHz duplex spacing.
- The manufacturer confirms that both the EM7455 (FCC ID: N7NEM7455) and MC7455 (FCC ID: N7NMC7455) radio modules have the same baseband and RF design, same firmware and feature support, same component list and placement. The hardware is identical apart from the two modules having different antenna connectors. Both modules have the same RF performance. According to FCC KDB 484596 D01 v01, the test data of the MC7455 module can be fully leveraged for the EM7455 module. Report No. FG220812 contains the EM7455 conducted power and radiated emission data only.

Declaration of Conformity:

- The test results (PASS/FAIL) with all measurement uncertainty excluded are presented in accordance with the regulation limits or requirements declared by manufacturers. It's means measurement values may risk exceeding the limit of regulation standards, if measurement uncertainty is include in test results.
- The measurement uncertainty please refer to this report "Uncertainty of Evaluation".

Comments and Explanations:

The product specifications of the EUT presented in the report are declared by the manufacturer who shall take full responsibility for the authenticity.

Reviewed by: Yun Huang
Report Producer: Tina Chaung



1 General Description

1.1 Product Feature of Equipment Under Test

WCDMA/LTE

Product Feature	
Antenna Type	Dipole Antenna

Remark: The above EUT's information was declared by manufacturer. Please refer to Comments and Explanations in report summary.

1.2 Modification of EUT

No modifications are made to the EUT during all test items.

1.3 Testing Location

Test Site	Sporton International Inc. EMC & Wireless Communications Laboratory	
Test Site Location	No.52, Huaya 1st Rd., Guishan Dist., Taoyuan City 333, Taiwan (R.O.C.) TEL: +886-3-327-3456 FAX: +886-3-328-4978	
Test Site No.	Sporton Site No.	
	TH03-HY	03CH07-HY
Test Engineer	George Chen	Jesse Wang
Temperature (°C)	22.3~24.1	16.1~16.8
Relative Humidity (%)	51.0~58.0	65.6~66.4

Note: The test site complies with ANSI C63.4 2014 requirement.

FCC Designation No.: TW1190

1.4 Applicable Standards

According to the specifications of the manufacturer, the EUT must comply with the requirements of the following standards:

- ♦ ANSI C63.26-2015
- ♦ ANSI / TIA-603-E
- ♦ FCC 47 CFR Part 2, 27
- ♦ FCC KDB 971168 D01 Power Meas. License Digital Systems v03r01
- ♦ FCC KDB 414788 D01 Radiated Test Site v01r01.

Remark:

1. All test items were verified and recorded according to the standards and without any deviation during the test.
2. The TAF code is not including all the FCC KDB listed without accreditation.



2 Test Configuration of Equipment Under Test

2.1 Test Mode

Antenna port conducted and radiated test items listed below are performed according to KDB 971168 D01 Power Meas. License Digital Systems v03r01 with maximum output power.

For radiated measurement, the measured emission level of the EUT was maximized by rotating the EUT on a turntable, adjusting the orientation of the EUT and EUT antenna in two angle (0 degrees & 90 degrees), and adjusting the measurement antenna orientation, following C63.26 exploratory test procedures and find 90 degrees as worst plane.

Test Items	Band	Bandwidth (MHz)		Modulation		RB #			Test Channel		
		1.4	3	QPSK	16QAM	1	Half	Full	L	M	H
Max. Output Power	8	v	v	v	v	v		v	v	v	v
Radiated Spurious Emission	8	v		v		v			v	v	v
Remark	<ol style="list-style-type: none"> The mark "v " means that this configuration is chosen for testing The device is investigated from 30MHz to 10 times of fundamental signal for radiated spurious emission test under different RB size/offset and modulations in exploratory test. Subsequently, only the worst case emissions are reported. The device doesn't support modulation type of 64QAM and 256QAM. 										

2.2 Connection Diagram of Test System

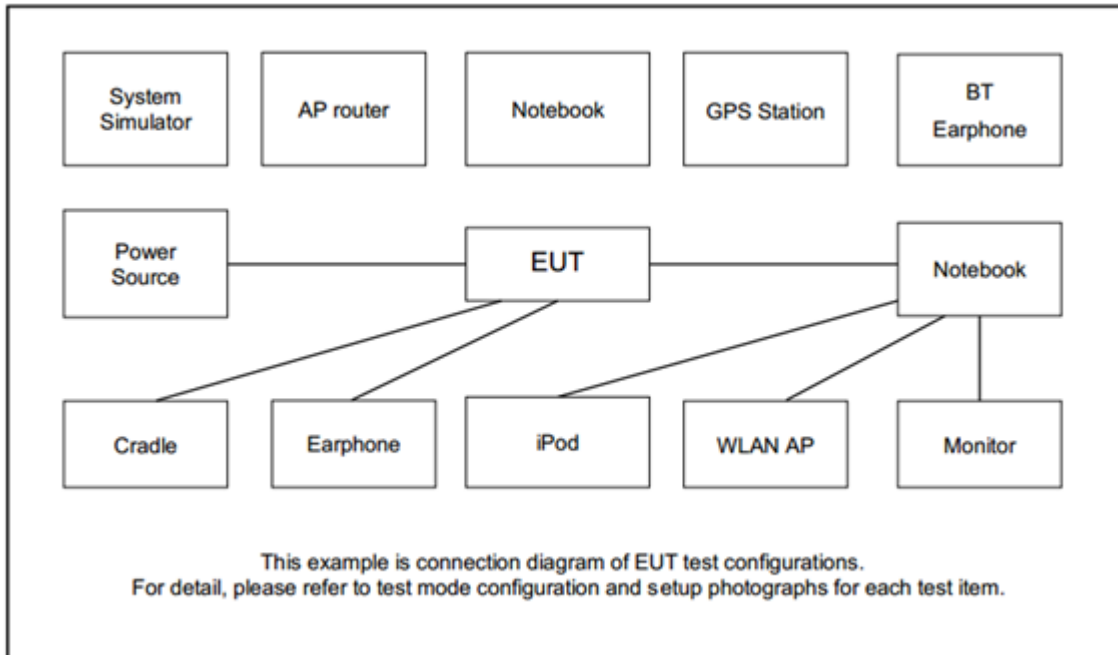

2.3 Support Unit used in test configuration and system

Item	Equipment	Brand Name	Model No.	FCC ID	Data Cable	Power Cord
1.	System Simulator	Anritsu	8821C	N/A	N/A	Unshielded, 1.8 m
2.	Adapter	GlobTeck	GT-41060-1505-1.0	N/A	N/A	N/A

2.4 Measurement Results Explanation Example

For all conducted test items:

The offset level is set in the spectrum analyzer to compensate the RF cable loss and attenuator factor between EUT conducted output port and spectrum analyzer. With the offset compensation, the spectrum analyzer reading level is exactly the EUT RF output level.

The spectrum analyzer offset is derived from RF cable loss and attenuator factor.

Offset = RF cable loss + attenuator factor.

Following shows an offset computation example with cable loss 4.2 dB and 10dB attenuator.

Example :

$$\begin{aligned} \text{Offset(dB)} &= \text{RF cable loss(dB)} + \text{attenuator factor(dB)} \\ &= 4.2 + 10 = 14.2 \text{ (dB)} \end{aligned}$$



2.5 Frequency List of Low/Middle/High Channels

BW [MHz]	Channel/Frequency(MHz)	Lowest	Middle	Highest
3	Channel	-	21640	-
	Frequency	-	899.0	-
1.4	Channel	21632	21640	21648
	Frequency	898.2	899.0	899.8

3 Conducted Test Items

3.1 Measuring Instruments

See list of measuring instruments of this test report.

3.1.1 Test Setup

3.1.2 Conducted Output Power

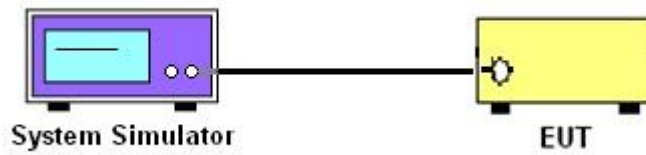

3.1.3 Test Result of Conducted Test

Please refer to Appendix A.



3.2 Conducted Output Power Measurement

3.2.1 Description of the Conducted Output Power Measurement

A base station simulator was used to establish communication with the EUT. Its parameters were set to transmit the maximum power on the EUT. The measured power in the radio frequency on the transmitter output terminals shall be reported.

3.2.2 Test Procedures

1. The transmitter output port was connected to the system simulator.
2. Set EUT at maximum power through the system simulator.
3. Select lowest, middle, and highest channels for each band and different modulation.
4. Measure and record the power level from the system simulator.

4 Radiated Test Items

4.1 Measuring Instruments

See list of measuring instruments of this test report.

4.1.1 Test Setup

For radiated test below 30MHz

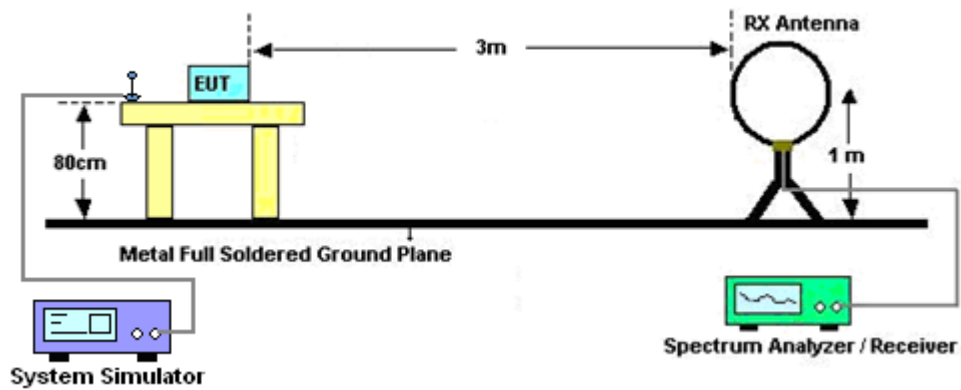

For radiated test from 30MHz to 1GHz

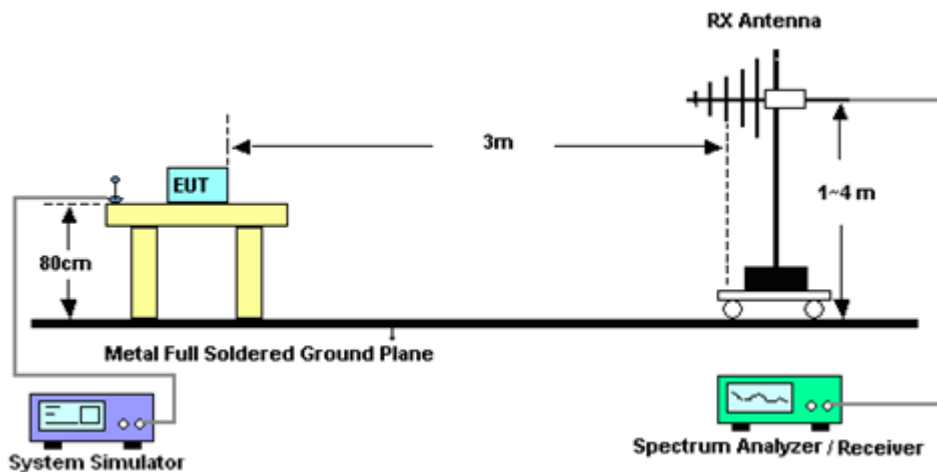

For radiated test above 1GHz

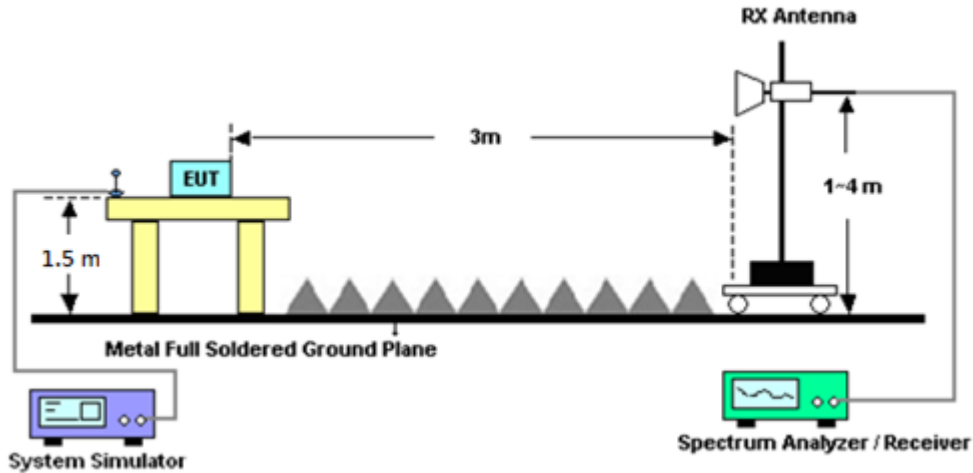

4.1.2 Test Result of Radiated Test

Please refer to Appendix B.

Note:

The low frequency, which started from 9 kHz to 30MHz, was pre-scanned and the result which was 20dB lower than the limit line was not reported.

There is adequate comparison measurement of both open-field test site and alternative test site - semi-Anechoic chamber according to 414788 D01 Radiated Test Site v01r01, and the result came out very similar.



4.2 Radiated Spurious Emission Measurement

4.2.1 Description of Radiated Spurious Emission Measurement

The radiated spurious emission was measured by substitution method according to ANSI / TIA-603-E. The power of any emission outside of the authorized operating frequency ranges must be attenuated below the transmitter power (P) by a factor of at least $43 + 10 \log (P)$ dB. The spectrum is scanned from 30 MHz up to a frequency including its 10th harmonic.

4.2.2 Test Procedures

The testing follows FCC KDB 971168 D01 v03r01 Section 7 and ANSI / TIA-603-E Section 2.2.12.

1. The EUT was placed on a turntable with 0.8 meter for frequency below 1GHz and 1.5 meter for frequency above 1GHz respectively above ground.
2. The EUT was set 3 meters from the receiving antenna, which was mounted on the antenna tower.
3. The table was rotated 360 degrees to determine the position of the highest spurious emission.
4. The height of the receiving antenna is varied between one meter and four meters to search the maximum spurious emission for both horizontal and vertical polarizations.
5. Make the measurement with the spectrum analyzer's RBW = 1MHz, VBW = 3MHz, taking the record of maximum spurious emission.
6. A horn antenna was substituted in place of the EUT and was driven by a signal generator.
7. Tune the output power of signal generator to the same emission level with EUT maximum spurious emission.
8. Taking the record of output power at antenna port.
9. Repeat step 7 to step 8 for another polarization.
10. The RF fundamental frequency should be excluded against the limit line in the operating frequency band.

The limit line is derived from $43 + 10\log(P)$ dB below the transmitter power P(Watts)

$EIRP \text{ (dBm)} = S.G. \text{ Power} - Tx \text{ Cable Loss} + Tx \text{ Antenna Gain}$

$ERP \text{ (dBm)} = EIRP - 2.15$



5 List of Measuring Equipment

Instrument	Brand Name	Model No.	Serial No.	Characteristics	Calibration Date	Test Date	Due Date	Remark
Radio Communication Analyzer	Anritsu	MT8821C	6201664755	2/3/4G/LTE FDD/TDD with44)/LTE-3C C DLCA/2CC ULCA, CatM1/NB1/NB2	Jul. 21, 2021	Feb. 17, 2022	Jul. 20, 2022	Conducted (TH03-HY)
Coupler	Warison	20dB 25W SMA Directional Coupler	#B	1-18GHz	Jan. 07, 2022	Feb. 17, 2022	Jan. 06, 2023	Conducted (TH03-HY)
Bilog Antenna	TESEQ	CBL 6111D & 00800N1D01N-06	35419 & 03	30MHz~1GHz	Apr. 28, 2021	Feb. 21, 2022	Apr. 27, 2022	Radiation (03CH07-HY)
Preamplifier	COM-POWER	PA-103A	161241	10MHz~1GHz	Oct. 04, 2021	Feb. 21, 2022	Oct. 03, 2022	Radiation (03CH07-HY)
Preamplifier	Agilent	8449B	3008A02362	1GHz~26.5GHz	Oct. 04, 2021	Feb. 21, 2022	Oct. 03, 2022	Radiation (03CH07-HY)
Spectrum Analyzer	Agilent	N9030A	MY52350276	3Hz~44GHz	Jul. 22, 2021	Feb. 21, 2022	Jul. 21, 2022	Radiation (03CH07-HY)
RF Cable	HUBER + SUHNER	SUCOFLEX 104	MY15682-4	30MHz to 18GHz	Feb. 24, 2021	Feb. 21, 2022	Feb. 23, 2022	Radiation (03CH07-HY)
RF Cable	HUBER + SUHNER	SUCOFLEX 104	MY24971-4	9kHz to 18GHz	Feb. 24, 2021	Feb. 21, 2022	Feb. 23, 2022	Radiation (03CH07-HY)
RF Cable	HUBER + SUHNER	SUCOFLEX 104	MY28655-4	9kHz to 18GHz	Feb. 24, 2021	Feb. 21, 2022	Feb. 23, 2022	Radiation (03CH07-HY)
Controller	EMEC	EM1000	N/A	Control Ant Mast	N/A	Feb. 21, 2022	N/A	Radiation (03CH07-HY)
Controller	MF	MF-7802	N/A	Control Turn table	N/A	Feb. 21, 2022	N/A	Radiation (03CH07-HY)
Antenna Mast	EMEC	AM-BS-4500E	N/A	Boresight mast 1M~4M	N/A	Feb. 21, 2022	N/A	Radiation (03CH07-HY)
Turn Table	ChainTek	Chaintek 3000	N/A	0~360 Degree	N/A	Feb. 21, 2022	N/A	Radiation (03CH07-HY)
Software	Audix	E3 6.2009-8-24	N/A	N/A	N/A	Feb. 21, 2022	N/A	Radiation (03CH07-HY)
USB Data Logger	TECPEL	TR-32	HE17XB2495	N/A	Mar. 09, 2021	Feb. 21, 2022	Mar. 08, 2022	Radiation (03CH07-HY)
Horn Antenna	ESCO	3117	00066584	1GHz~18GHz	Oct. 25, 2021	Feb. 21, 2022	Oct. 24, 2022	Radiation (03CH07-HY)



6 Uncertainty of Evaluation

Uncertainty of Radiated Emission Measurement (30 MHz ~ 1000 MHz)

Measuring Uncertainty for a Level of Confidence of 95% ($U = 2Uc(y)$)	3.16 dB
---	---------

Uncertainty of Radiated Emission Measurement (1 GHz ~ 18 GHz)

Measuring Uncertainty for a Level of Confidence of 95% ($U = 2Uc(y)$)	3.71 dB
---	---------

Uncertainty of Radiated Emission Measurement (18 GHz ~ 40 GHz)

Measuring Uncertainty for a Level of Confidence of 95% ($U = 2Uc(y)$)	4.16 dB
---	---------



Appendix A. Test Results of Conducted Test

Conducted Output Power(Average power)

LTE Band 8 Maximum Average Power [dBm]						
BW [MHz]	RB Size	RB Offset	Mod	Lowest	Middle	Highest
3	1	0	QPSK	-	22.94	-
3	1	14			23.02	
3	15	0			21.93	
3	1	0	16-QAM		22.21	
3	1	14			22.25	
3	15	0			20.97	

LTE Band 8 Maximum Average Power [dBm]						
BW [MHz]	RB Size	RB Offset	Mod	Lowest	Middle	Highest
1.4	1	0	QPSK	23.12	22.84	23.07
1.4	1	5		23.11	23.06	23.08
1.4	6	0		21.92	21.88	22.06
1.4	1	0	16-QAM	22.17	22.22	22.27
1.4	1	5		22.26	22.07	22.24
1.4	6	0		21.08	21.03	21.18



Appendix B. Test Results of Radiated Test

LTE Band 8

LTE Band 8 / 1.4MHz / QPSK									
Channel	Frequency (MHz)	ERP (dBm)	Limit (dBm)	Over Limit (dB)	SPA Reading (dBm)	S.G. Power (dBm)	TX Cable loss (dB)	TX Antenna Gain (dBi)	Polarization (H/V)
Lowest	1792	-59.04	-13	-46.04	-72.3	-60.33	1.04	4.48	H
	2691	-59.57	-13	-46.57	-76.99	-61.62	1.35	5.55	H
	8976	-50.91	-13	-37.91	-80.29	-58.97	2.48	12.69	H
									H
									H
									H
									H
	1792	-60.90	-13	-47.90	-74.57	-62.19	1.04	4.48	V
	2691	-58.79	-13	-45.79	-76.86	-60.84	1.35	5.55	V
	8976	-50.19	-13	-37.19	-79	-58.25	2.48	12.69	V
									V
									V
									V
									V
Middle	1797	-58.04	-13	-45.04	-71.3	-59.31	1.04	4.47	H
	2695	-58.88	-13	-45.88	-76.34	-60.93	1.35	5.56	H
	3593	-57.09	-13	-44.09	-77.53	-61.42	1.63	8.11	H
									H
									H
									H
									H
	1797	-59.41	-13	-46.41	-73.08	-60.68	1.04	4.47	V
	2695	-58.29	-13	-45.29	-76.42	-60.34	1.35	5.56	V
	3593	-57.26	-13	-44.26	-77.61	-61.59	1.63	8.11	V
									V
									V
									V
									V
								V	



LTE Band 8 / 1.4MHz / QPSK									
Channel	Frequency (MHz)	ERP (dBm)	Limit (dBm)	Over Limit (dB)	SPA Reading (dBm)	S.G. Power (dBm)	TX Cable loss (dB)	TX Antenna Gain (dBi)	Polarization (H/V)
Highest	1798	-57.13	-13	-44.13	-70.39	-58.4	1.04	4.47	H
	2697	-58.91	-13	-45.91	-76.37	-60.97	1.35	5.56	H
	8990	-51.78	-13	-38.78	-81.2	-59.85	2.48	12.70	H
									H
									H
									H
									H
	1798	-59.49	-13	-46.49	-73.16	-60.76	1.04	4.47	V
	2697	-58.54	-13	-45.54	-76.67	-60.6	1.35	5.56	V
	8990	-49.75	-13	-36.75	-79.6	-57.82	2.48	12.70	V
									V
									V
									V
									V

Remark: Spurious emissions within 30-1000MHz were found more than 20dB below limit line.

Appendix C. Setup Photographs

<Radiated Emission>

Vertical Antenna

LF



HF





Appendix D. Test Report

Please refer to Sporton report number FG1N0947 as below.



FCC RADIO TEST REPORT

FCC ID : N7NMC7455
Equipment : PCI Express Mini Card
Brand Name : AirPrime
Model Name : MC7455
Applicant : Sierra Wireless Inc.
13811 Wireless Way, Richmond, BC Canada V6V 3A4
Manufacturer : Sierra Wireless Inc.
13811 Wireless Way, Richmond, BC Canada V6V 3A4
Standard : FCC 47 CFR Part 2, 27

The product was received on Nov. 09, 2021 and testing was performed from Nov. 24, 2021 to Dec. 01, 2021. We, Sporton International Inc. EMC & Wireless Communications Laboratory, would like to declare that the tested sample has been evaluated in accordance with the test procedures given in ANSI / TIA-603-E and has been in compliance with the applicable technical standards.

The test results in this partial report apply exclusively to the tested model / sample. Without written approval of Sporton International Inc. EMC & Wireless Communications Laboratory, the test report shall not be reproduced except in full.

Louis Wu

Approved by: Louis Wu

Sporton International Inc. EMC & Wireless Communications Laboratory

No. 52, Huaya 1st Rd., Guishan Dist., Taoyuan City 333, Taiwan (R.O.C.)



Table of Contents

History of this test report..... 3

Summary of Test Result..... 4

1 General Description 5

 1.1 Product Feature of Equipment Under Test..... 5

 1.2 Modification of EUT 5

 1.3 Testing Location 5

 1.4 Applicable Standards..... 5

2 Test Configuration of Equipment Under Test 6

 2.1 Test Mode..... 6

 2.2 Connection Diagram of Test System..... 7

 2.3 Support Unit used in test configuration and system 7

 2.4 Measurement Results Explanation Example..... 7

 2.5 Frequency List of Low/Middle/High Channels 8

3 Conducted Test Items..... 9

 3.1 Measuring Instruments 9

 3.2 Conducted Output Power Measurement 10

 3.3 Peak-to-Average Ratio 11

 3.4 Occupied Bandwidth..... 12

 3.5 Conducted Band Edge 13

 3.6 Conducted Spurious Emission 14

 3.7 Frequency Stability 15

4 Radiated Test Items 16

 4.1 Measuring Instruments 16

 4.2 Radiated Spurious Emission Measurement 18

5 List of Measuring Equipment..... 19

6 Uncertainty of Evaluation..... 20

Appendix A. Test Results of Conducted Test

Appendix B. Test Results of Radiated Test

Appendix C. Test Setup Photographs



History of this test report

Report No.	Version	Description	Issued Date
FG1N0947	01	Initial issue of report	Dec. 08, 2021



Summary of Test Result

Report Clause	Ref Std. Clause	Test Items	Result (PASS/FAIL)	Remark
3.2	§2.1046	Conducted Output Power	Reporting only	-
3.3	§2.1051 §27.1507 (d)	Peak-to-Average Ratio	Reporting only	-
3.4	§2.1049 §27.1506	Occupied Bandwidth	Reporting only	-
3.5	§2.1051 §27.1509 (a)	Conducted Band Edge Measurement	Pass	-
3.6	§2.1051 §27.1509 (a)	Conducted Spurious Emission	Pass	-
3.7	§2.1055	Frequency Stability Temperature & Voltage	Pass	-
4.2	§2.1051 §27.1509 (a)	Radiated Spurious Emission	Pass	Under limit 43.87dB at 3593.000 MHz

Remark: The test data in the report is tested using LTE-licensed transmitters for frequency band 8 (897.5 MHz-900.5 MHz) with 45MHz duplex spacing.

Declaration of Conformity:

The test results with all measurement uncertainty excluded are presented in accordance with the regulation limits or requirements declared by manufacturers.

Comments and Explanations:

The declared of product specification for EUT presented in the report are provided by the manufacturer, and the manufacturer takes all the responsibilities for the accuracy of product specification.

Reviewed by: Yun Huang
Report Producer: Dara Chiu



1 General Description

1.1 Product Feature of Equipment Under Test

WCDMA/LTE

Product Feature	
Antenna Type	Dipole Antenna

Remark: The above EUT's information was declared by manufacturer. Please refer to Comments and Explanations in report summary.

1.2 Modification of EUT

No modifications are made to the EUT during all test items.

1.3 Testing Location

Test Site	Sporton International Inc. EMC & Wireless Communications Laboratory	
Test Site Location	No.52, Huaya 1st Rd., Guishan Dist., Taoyuan City 333, Taiwan (R.O.C.) TEL: +886-3-327-3456 FAX: +886-3-328-4978	
Test Site No.	Sporton Site No.	
	TH03-HY	03CH07-HY
Test Engineer	George Chen	Jesse Wang and Ken Wu
Temperature (°C)	22.1 ~ 25.1	21.6 ~ 23.1
Relative Humidity (%)	52 ~ 61	62.3 ~ 62.5

Note: The test site complies with ANSI C63.4 2014 requirement.

FCC Designation No.: TW1190

1.4 Applicable Standards

According to the specifications of the manufacturer, the EUT must comply with the requirements of the following standards:

- ♦ ANSI C63.26-2015
- ♦ ANSI / TIA-603-E
- ♦ FCC 47 CFR Part 2, 27
- ♦ FCC KDB 971168 D01 Power Meas. License Digital Systems v03r01
- ♦ FCC KDB 414788 D01 Radiated Test Site v01r01.

Remark:

1. All test items were verified and recorded according to the standards and without any deviation during the test.
2. The TAF code is not including all the FCC KDB listed without accreditation.



2 Test Configuration of Equipment Under Test

2.1 Test Mode

Antenna port conducted and radiated test items listed below are performed according to KDB 971168 D01 Power Meas. License Digital Systems v03r01 with maximum output power.

For radiated measurement, the measured emission level of the EUT was maximized by rotating the EUT on a turntable, adjusting the orientation of the EUT and EUT antenna in two angle (0 degrees & 90 degrees), and adjusting the measurement antenna orientation, following C63.26 exploratory test procedures and find 90 degrees as worst plane.

Test Items	Band	Bandwidth (MHz)		Modulation		RB #			Test Channel		
		1.4	3	QPSK	16QAM	1	Half	Full	L	M	H
Max. Output Power	8	v	v	v	v	v		v	v	v	v
Peak-to-Average Ratio	8		v	v	v			v		v	
26dB and 99% Bandwidth	8	v	v	v	v			v		v	
Conducted Band Edge	8	v	v	v	v	v		v	v		v
Conducted Spurious Emission	8	v	v	v		v			v	v	v
Frequency Stability	8		v	v				v		v	
Radiated Spurious Emission	8	v		v		v			v	v	v
Remark	<ol style="list-style-type: none"> The mark "v " means that this configuration is chosen for testing The device is investigated from 30MHz to 10 times of fundamental signal for radiated spurious emission test under different RB size/offset and modulations in exploratory test. Subsequently, only the worst case emissions are reported. The device doesn't support modulation type of 64QAM and 256QAM. 										

2.2 Connection Diagram of Test System

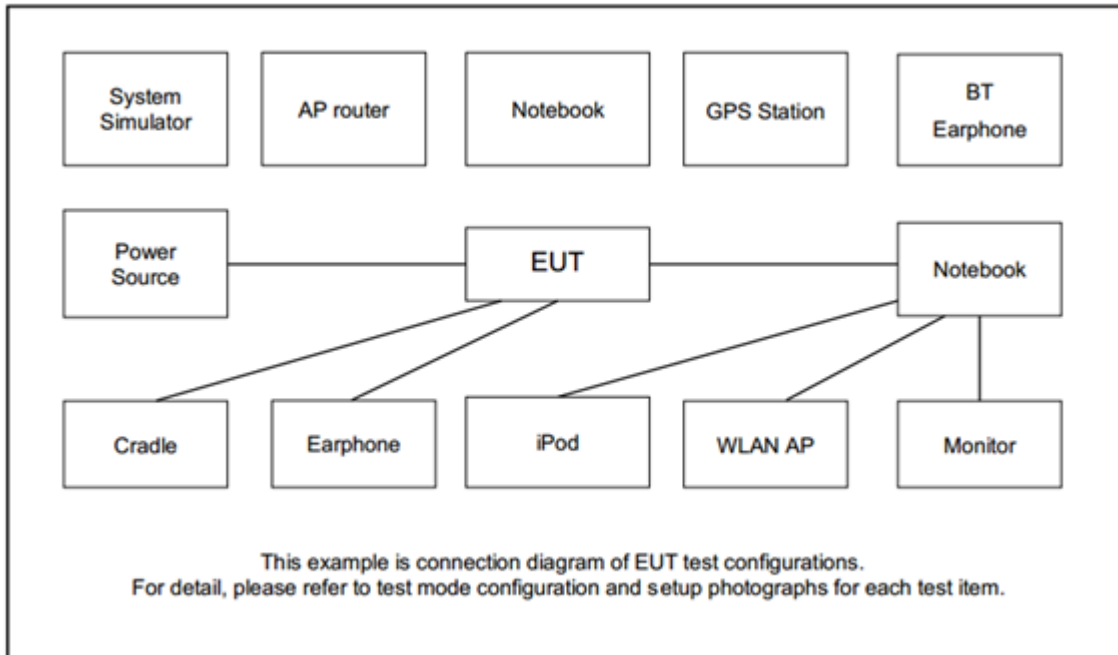

2.3 Support Unit used in test configuration and system

Item	Equipment	Brand Name	Model No.	FCC ID	Data Cable	Power Cord
1.	System Simulator	Anritsu	8821C	N/A	N/A	Unshielded, 1.8 m
2.	Adapter	elpac	FW1805	N/A	N/A	N/A
3.	Fixture	Sierra	N/A	N/A	N/A	N/A

2.4 Measurement Results Explanation Example

For all conducted test items:

The offset level is set in the spectrum analyzer to compensate the RF cable loss and attenuator factor between EUT conducted output port and spectrum analyzer. With the offset compensation, the spectrum analyzer reading level is exactly the EUT RF output level.

The spectrum analyzer offset is derived from RF cable loss and attenuator factor.

Offset = RF cable loss + attenuator factor.

Following shows an offset computation example with cable loss 4.2 dB and 10dB attenuator.

Example :

$$\begin{aligned} \text{Offset}(dB) &= \text{RF cable loss}(dB) + \text{attenuator factor}(dB). \\ &= 4.2 + 10 = 14.2 \text{ (dB)} \end{aligned}$$



2.5 Frequency List of Low/Middle/High Channels

BW [MHz]	Channel/Frequency(MHz)	Lowest	Middle	Highest
3	Channel	-	21640	-
	Frequency	-	899.0	-
1.4	Channel	21632	21640	21648
	Frequency	898.2	899.0	899.8

3 Conducted Test Items

3.1 Measuring Instruments

See list of measuring instruments of this test report.

3.1.1 Test Setup

3.1.2 Conducted Output Power

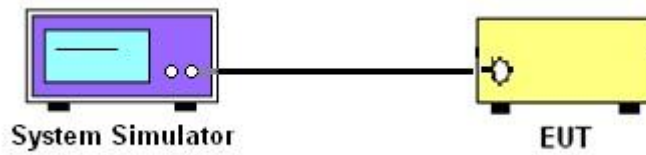

3.1.3 Peak-to-Average Ratio, Occupied Bandwidth ,Conducted Band-Edge and Conducted Spurious Emission

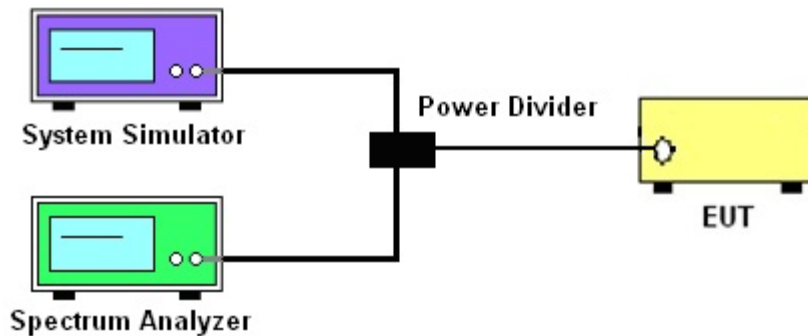

3.1.4 Frequency Stability

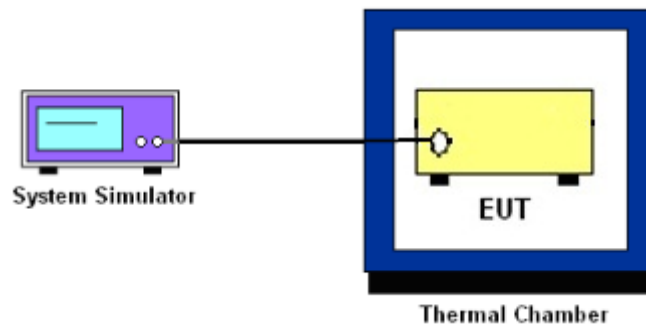

3.1.5 Test Result of Conducted Test

Please refer to Appendix A.



3.2 Conducted Output Power Measurement

3.2.1 Description of the Conducted Output Power Measurement

A base station simulator was used to establish communication with the EUT. Its parameters were set to transmit the maximum power on the EUT. The measured power in the radio frequency on the transmitter output terminals shall be reported.

3.2.2 Test Procedures

1. The transmitter output port was connected to the system simulator.
2. Set EUT at maximum power through the system simulator.
3. Select lowest, middle, and highest channels for each band and different modulation.
4. Measure and record the power level from the system simulator.



3.3 Peak-to-Average Ratio

3.3.1 Description of the PAR Measurement

Power Complementary Cumulative Distribution Function (CCDF) curves provide a means for characterizing the power peaks of a digitally modulated signal on a statistical basis. A CCDF curve depicts the probability of the peak signal amplitude exceeding the average power level. Most contemporary measurement instrumentation include the capability to produce CCDF curves for an input signal provided that the instrument's resolution bandwidth can be set wide enough to accommodate the entire input signal bandwidth. In measuring transmissions in this band using an average power technique, the peak-to-average ratio (PAR) of the transmission may not exceed 13 dB.

3.3.2 Test Procedures

The testing follows ANSI C63.26-2015 Section 5.2.6

1. The EUT was connected to spectrum and system simulator via a power divider.
2. Set the CCDF (Complementary Cumulative Distribution Function) option in spectrum analyzer.
3. The highest RF powers were measured and recorded the maximum PAPR level associated with a probability of 0.1 %.
4. Record the deviation as Peak to Average Ratio.



3.4 Occupied Bandwidth

3.4.1 Description of Occupied Bandwidth Measurement

The occupied bandwidth is the width of a frequency band such that, below the lower and above the upper frequency limits, the mean powers emitted are each equal to a specified percentage 0.5% of the total mean transmitted power.

The 26 dB emission bandwidth is defined as the frequency range between two points, one above and one below the carrier frequency, at which the spectral density of the emission is attenuated 26 dB below the maximum in-band spectral density of the modulated signal. Spectral density (power per unit bandwidth) is to be measured with a detector of resolution bandwidth equal to approximately 1.0% of the emission bandwidth.

3.4.2 Test Procedures

The testing follows ANSI C63.26-2015 Section 5.4.3 (26dB) and Section 5.4.4 (99OB)

1. The EUT was connected to spectrum analyzer and system simulator via a power divider.
2. The spectrum analyzer center frequency is set to the nominal EUT channel center frequency. The span range for the spectrum analyzer shall be between two and five times the anticipated OBW.
3. The nominal resolution bandwidth (RBW) shall be in the range of 1 to 5 % of the anticipated OBW, and the VBW shall be at least 3 times the RBW.
4. Set the detection mode to peak, and the trace mode to max hold.
5. Determine the reference value: Set the EUT to transmit a modulated signal. Allow the trace to stabilize. Set the spectrum analyzer marker to the highest level of the displayed trace.
(this is the reference value)
6. Determine the “-26 dB down amplitude” as equal to (Reference Value – X).
7. Place two markers, one at the lowest and the other at the highest frequency of the envelope of the spectral display such that each marker is at or slightly below the “-X dB down amplitude” determined in step 6. If a marker is below this “-X dB down amplitude” value it shall be placed as close as possible to this value. The OBW is the positive frequency difference between the two markers.
8. Use the 99 % power bandwidth function of the spectrum analyzer and report the measured bandwidth.



3.5 Conducted Band Edge

3.5.1 Description of Conducted Band Edge Measurement

The FCC limit is $43 + 10\log_{10}(P[\text{Watts}])$ dB below the transmitter power $P(\text{Watts})$ in a 100kHz bandwidth. However, in the 100kHz bands immediately outside and adjacent to the licensee's frequency block, a resolution bandwidth of at least one percent of the emission bandwidth of the fundamental emission of the transmitter may be employed.

3.5.2 Test Procedures

The testing follows FCC KDB 971168 D01 v03r01 Section 6.1.

1. The EUT was connected to spectrum analyzer and system simulator via a power divider.
2. The band edges of low and high channels for the highest RF powers were measured.
3. Set RBW $\geq 1\%$ EBW in the 100kHz band immediately outside and adjacent to the band edge.
4. Beyond the 100kHz band from the band edge, RBW = 100 kHz was used.
5. Set spectrum analyzer with RMS detector.
6. The RF fundamental frequency should be excluded against the limit line in the operating frequency band.
7. Checked that all the results comply with the emission limit line.

The limit line is derived from $43 + 10\log(P)\text{dB}$ below the transmitter power $P(\text{Watts})$



3.6 Conducted Spurious Emission

3.6.1 Description of Conducted Spurious Emission Measurement

The power of any emission outside of the authorized operating frequency ranges must be lower than the transmitter power (P) by a factor of at least $43 + 10 \log (P)$ dB.

It is measured by means of a calibrated spectrum analyzer and scanned from 30 MHz up to a frequency including its 10th harmonic.

3.6.2 Test Procedures

The testing follows FCC KDB 971168 D01 v03r01 Section 6.1.

1. The EUT was connected to spectrum analyzer and system simulator via a power divider.
2. The RF output of EUT was connected to the spectrum analyzer by RF cable and attenuator. The path loss was compensated to the results for each measurement.
3. The middle channel for the highest RF power within the transmitting frequency was measured.
4. The conducted spurious emission for the whole frequency range was taken.
5. Make the measurement with the spectrum analyzer's set RBW = 100 kHz for frequency below 1 GHz, RBW = 1 MHz for frequency above 1 GHz were used, VBW = 3MHz.
6. Set spectrum analyzer with RMS detector.
7. Taking the record of maximum spurious emission.
8. The RF fundamental frequency should be excluded against the limit line in the operating frequency band.
9. The limit line is derived from $43 + 10\log(P)$ dB below the transmitter power P(Watts)



3.7 Frequency Stability

3.7.1 Description of Frequency Stability Measurement

The frequency stability shall be sufficient to ensure that the fundamental emission stays within the authorized frequency block.

3.7.2 Test Procedures for Temperature Variation

The testing follows FCC KDB 971168 D01 v03r01 Section 9.0.

1. The EUT was set up in the thermal chamber and connected with the system simulator.
2. With power OFF, the temperature was decreased to -30°C and the EUT was stabilized before testing. Power was applied and the maximum change in frequency was recorded within one minute.
3. With power OFF, the temperature was raised in 10°C step up to 50°C. The EUT was stabilized at each step for at least half an hour. Power was applied and the maximum frequency change was recorded within one minute.

3.7.3 Test Procedures for Voltage Variation

The testing follows FCC KDB 971168 D01 v03r01 Section 9.0.

1. The EUT was placed in a temperature chamber at 20±5° C and connected with the system simulator.
2. The power supply voltage to the EUT was varied from 85% to 115% of the nominal value measured at the input to the EUT.
3. The variation in frequency was measured for the worst case.

4 Radiated Test Items

4.1 Measuring Instruments

See list of measuring instruments of this test report.

4.1.1 Test Setup

For radiated test below 30MHz

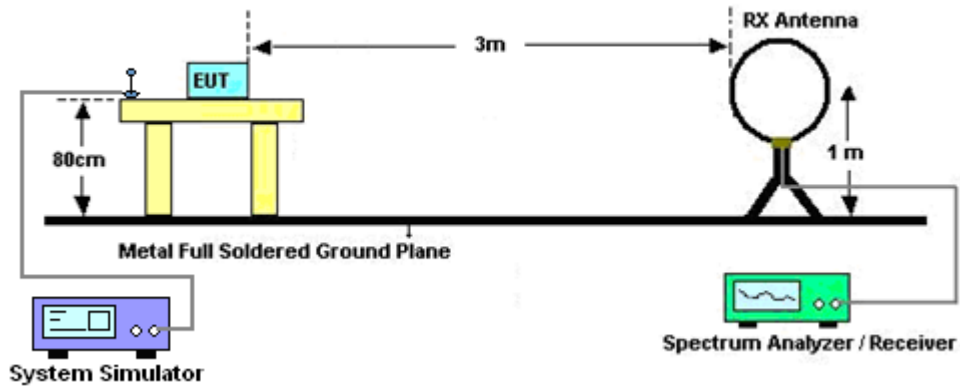

For radiated test from 30MHz to 1GHz

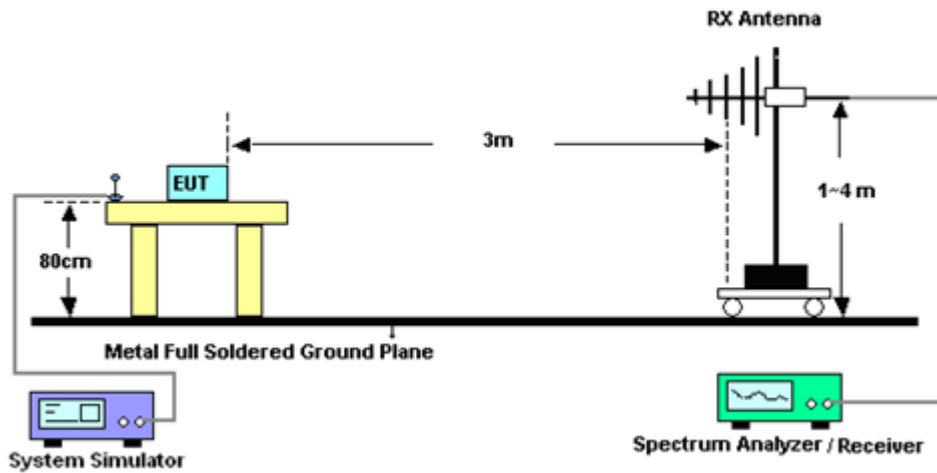

For radiated test above 1GHz

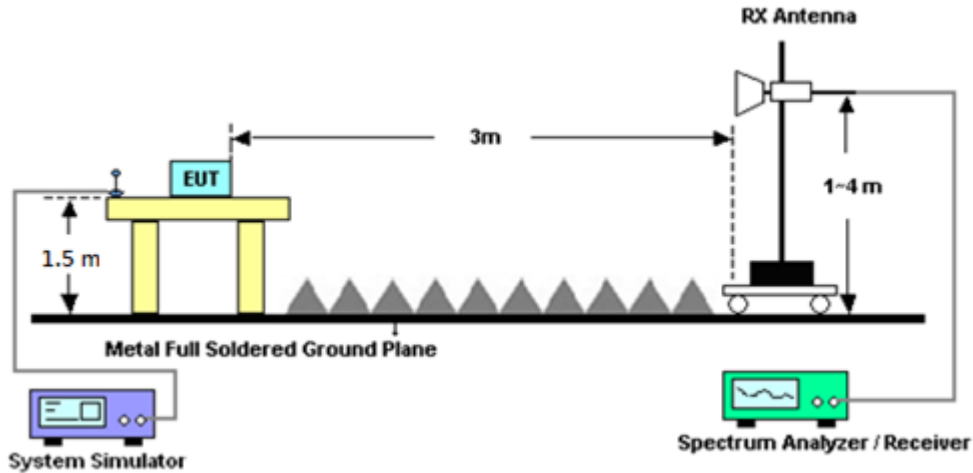

4.1.2 Test Result of Radiated Test

Please refer to Appendix B.

Note:

The low frequency, which started from 9 kHz to 30MHz, was pre-scanned and the result which was 20dB lower than the limit line was not reported.

There is adequate comparison measurement of both open-field test site and alternative test site - semi-Anechoic chamber according to 414788 D01 Radiated Test Site v01r01, and the result came out very similar.



4.2 Radiated Spurious Emission Measurement

4.2.1 Description of Radiated Spurious Emission Measurement

The radiated spurious emission was measured by substitution method according to ANSI / TIA-603-E. The power of any emission outside of the authorized operating frequency ranges must be attenuated below the transmitter power (P) by a factor of at least $43 + 10 \log (P)$ dB. The spectrum is scanned from 30 MHz up to a frequency including its 10th harmonic.

4.2.2 Test Procedures

The testing follows FCC KDB 971168 D01 v03r01 Section 7 and ANSI / TIA-603-E Section 2.2.12.

1. The EUT was placed on a turntable with 0.8 meter for frequency below 1GHz and 1.5 meter for frequency above 1GHz respectively above ground.
2. The EUT was set 3 meters from the receiving antenna, which was mounted on the antenna tower.
3. The table was rotated 360 degrees to determine the position of the highest spurious emission.
4. The height of the receiving antenna is varied between one meter and four meters to search the maximum spurious emission for both horizontal and vertical polarizations.
5. Make the measurement with the spectrum analyzer's RBW = 1MHz, VBW = 3MHz, taking the record of maximum spurious emission.
6. A horn antenna was substituted in place of the EUT and was driven by a signal generator.
7. Tune the output power of signal generator to the same emission level with EUT maximum spurious emission.
8. Taking the record of output power at antenna port.
9. Repeat step 7 to step 8 for another polarization.
10. The RF fundamental frequency should be excluded against the limit line in the operating frequency band.

The limit line is derived from $43 + 10\log(P)$ dB below the transmitter power P(Watts)

$EIRP \text{ (dBm)} = S.G. \text{ Power} - Tx \text{ Cable Loss} + Tx \text{ Antenna Gain}$

$ERP \text{ (dBm)} = EIRP - 2.15$



5 List of Measuring Equipment

Instrument	Brand Name	Model No.	Serial No.	Characteristics	Calibration Date	Test Date	Due Date	Remark
Radio Communication Analyzer	Anritsu	MT8821C	6201664755	2/3/4G/LTE FDD/TDD with44)/LTE-3C C DLCA/2CC ULCA, CatM1/NB1/NB2	Jul. 21, 2021	Nov. 24, 2021~ Dec. 01, 2021	Jul. 20, 2022	Conducted (TH03-HY)
Spectrum Analyzer	Rohde & Schwarz	FSV40	101909	10Hz~40GHz	Aug. 13, 2021	Nov. 24, 2021~ Dec. 01, 2021	Aug. 12, 2022	Conducted (TH03-HY)
Thermal Chamber	ESPEC	SH-641	92013720	-40°C ~90°C	Sep. 09, 2021	Nov. 24, 2021~ Dec. 01, 2021	Sep. 08, 2022	Conducted (TH03-HY)
DC Power Supply	GW Instek	GPP-2323	GES906037	0V~64V ; 0A~6A	Dec. 15, 2020	Nov. 24, 2021~ Dec. 01, 2021	Dec. 14, 2021	Conducted (TH03-HY)
Coupler	Warison	20dB 25W SMA Directional Coupler	#A	1-18GHz	Jan. 07, 2021	Nov. 24, 2021~ Dec. 01, 2021	Jan. 06, 2022	Conducted (TH03-HY)
Bilog Antenna	TESEQ	CBL 6111D & 00800N1D01N-06	35419 & 03	30MHz~1GHz	Apr. 28, 2021	Nov. 30, 2021	Apr. 27, 2022	Radiation (03CH07-HY)
Preamplifier	COM-POWER	PA-103A	161241	10MHz~1GHz	Oct. 04, 2021	Nov. 30, 2021	Oct. 03, 2022	Radiation (03CH07-HY)
Preamplifier	Agilent	8449B	3008A02362	1GHz~26.5GHz	Oct. 04, 2021	Nov. 30, 2021	Oct. 03, 2022	Radiation (03CH07-HY)
Spectrum Analyzer	Agilent	N9030A	MY52350276	3Hz~44GHz	Jul. 22, 2021	Nov. 30, 2021	Jul. 21, 2022	Radiation (03CH07-HY)
RF Cable	HUBER + SUHNER	SUCOFLEX 104	MY15682-4	30MHz to 18GHz	Feb. 24, 2021	Nov. 30, 2021	Feb. 23, 2022	Radiation (03CH07-HY)
RF Cable	HUBER + SUHNER	SUCOFLEX 104	MY24971-4	9kHz to 18GHz	Feb. 24, 2021	Nov. 30, 2021	Feb. 23, 2022	Radiation (03CH07-HY)
RF Cable	HUBER + SUHNER	SUCOFLEX 104	MY28655-4	9kHz to 18GHz	Feb. 24, 2021	Nov. 30, 2021	Feb. 23, 2022	Radiation (03CH07-HY)
Controller	EMEC	EM1000	N/A	Control Ant Mast	N/A	Nov. 30, 2021	N/A	Radiation (03CH07-HY)
Controller	MF	MF-7802	N/A	Control Turn table	N/A	Nov. 30, 2021	N/A	Radiation (03CH07-HY)
Antenna Mast	EMEC	AM-BS-4500E	N/A	Boresight mast 1M~4M	N/A	Nov. 30, 2021	N/A	Radiation (03CH07-HY)
Turn Table	ChainTek	Chaintek 3000	N/A	0~360 Degree	N/A	Nov. 30, 2021	N/A	Radiation (03CH07-HY)
Software	Audix	E3 6.2009-8-24	N/A	N/A	N/A	Nov. 30, 2021	N/A	Radiation (03CH07-HY)
USB Data Logger	TECPEL	TR-32	HE17XB2495	N/A	Mar. 09, 2021	Nov. 30, 2021	Mar. 08, 2022	Radiation (03CH07-HY)
Horn Antenna	ESCO	3117	00066584	1GHz~18GHz	Oct. 25, 2021	Nov. 30, 2021	Oct. 24, 2022	Radiation (03CH07-HY)



6 Uncertainty of Evaluation

Uncertainty of Radiated Emission Measurement (30 MHz ~ 1000 MHz)

Measuring Uncertainty for a Level of Confidence of 95% ($U = 2Uc(y)$)	3.16 dB
---	---------

Uncertainty of Radiated Emission Measurement (1 GHz ~ 18 GHz)

Measuring Uncertainty for a Level of Confidence of 95% ($U = 2Uc(y)$)	3.71 dB
---	---------

Uncertainty of Radiated Emission Measurement (18 GHz ~ 40 GHz)

Measuring Uncertainty for a Level of Confidence of 95% ($U = 2Uc(y)$)	4.16 dB
---	---------



Appendix A. Test Results of Conducted Test

Conducted Output Power(Average power)

LTE Band 8 Maximum Average Power [dBm]						
BW [MHz]	RB Size	RB Offset	Mod	Lowest	Middle	Highest
3	1	0	QPSK	-	22.32	-
3	1	14			22.02	
3	15	0			20.96	
3	1	0	16-QAM	-	21.39	-
3	1	14			21.31	
3	15	0			20.00	

LTE Band 8 Maximum Average Power [dBm]						
BW [MHz]	RB Size	RB Offset	Mod	Lowest	Middle	Highest
1.4	1	0	QPSK	22.38	22.27	22.14
1.4	1	5		22.26	22.18	22.15
1.4	6	0		21.03	21.14	21.01
1.4	1	0	16-QAM	21.74	21.45	21.38
1.4	1	5		21.36	21.33	21.37
1.4	6	0		20.20	20.15	20.14



Peak-to-Average Ratio

Mode	LTE Band 8 / 3MHz		
Mod.	QPSK	16QAM	Limit: 13dB
RB Size	Full RB	Full RB	Result
Middle CH	5.10	6.09	PASS

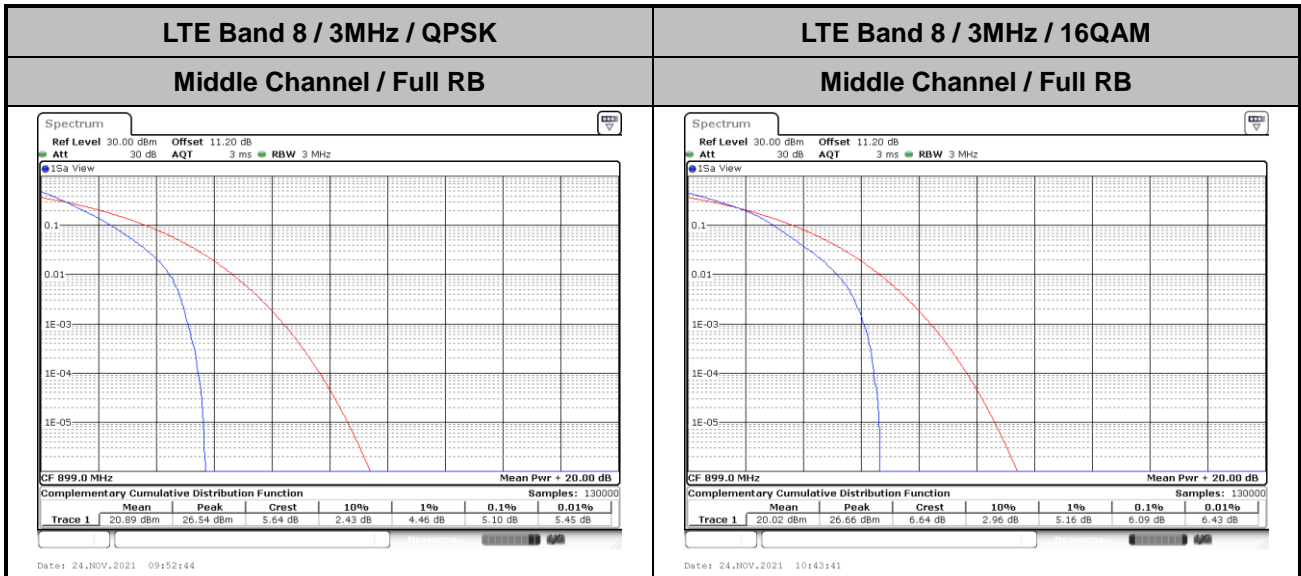



26dB Bandwidth

Mode	LTE Band 8 : 26dB BW(MHz)											
BW	1.4MHz		3MHz		5MHz		3MHz		15MHz		20MHz	
Mod.	QPSK	16QAM	QPSK	16QAM	QPSK	16QAM	QPSK	16QAM	QPSK	16QAM	QPSK	16QAM
Middle CH	1.23	1.23	2.99	3.02	-	-	-	-	-	-	-	-

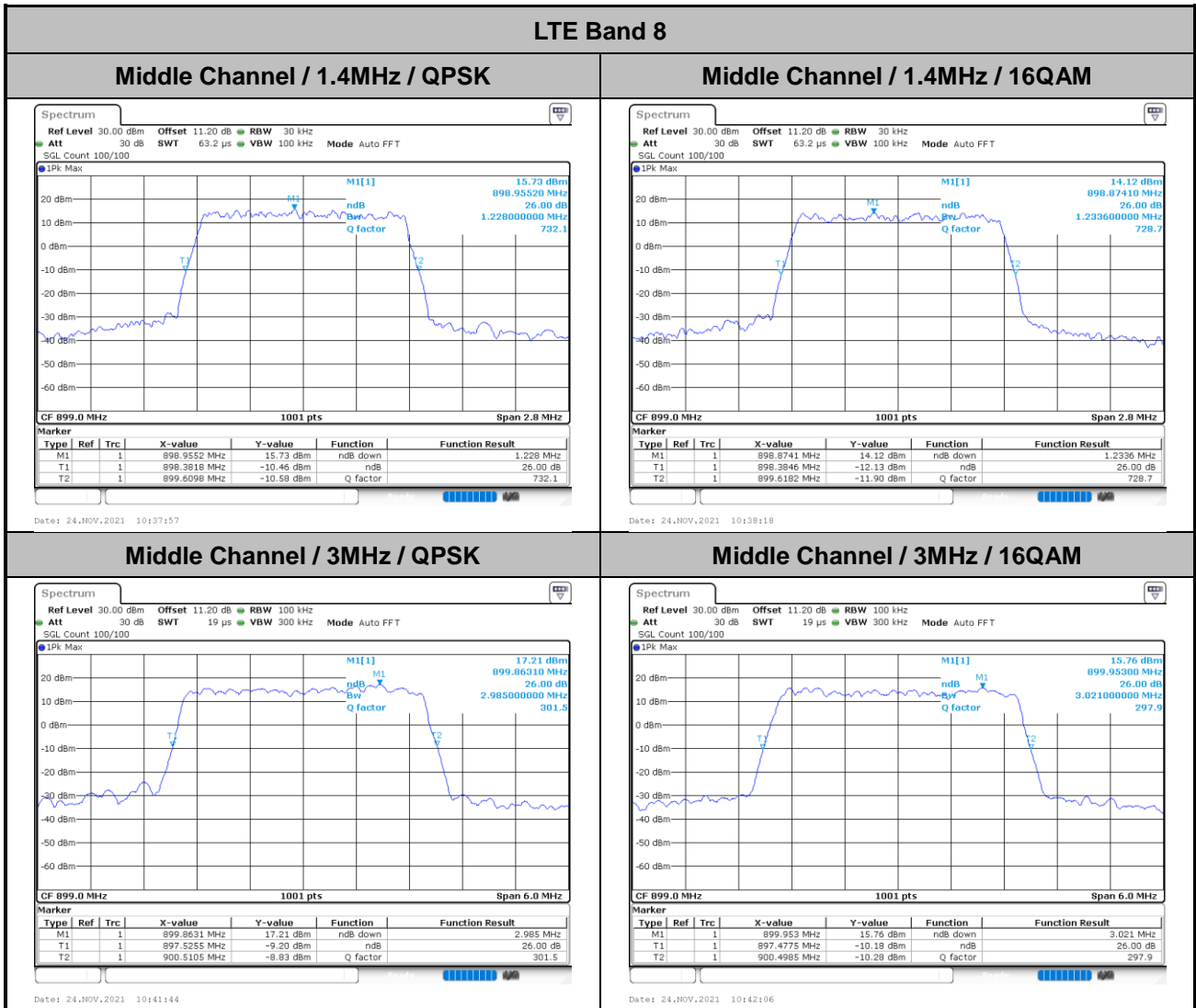



Occupied Bandwidth

Mode	LTE Band 8 : 99%OBW(MHz)											
	1.4MHz		3MHz		5MHz		3MHz		15MHz		20MHz	
Mod.	QPSK	16QAM	QPSK	16QAM	QPSK	16QAM	QPSK	16QAM	QPSK	16QAM	QPSK	16QAM
Middle CH	1.09	1.09	2.72	2.72	-	-	-	-	-	-	-	-

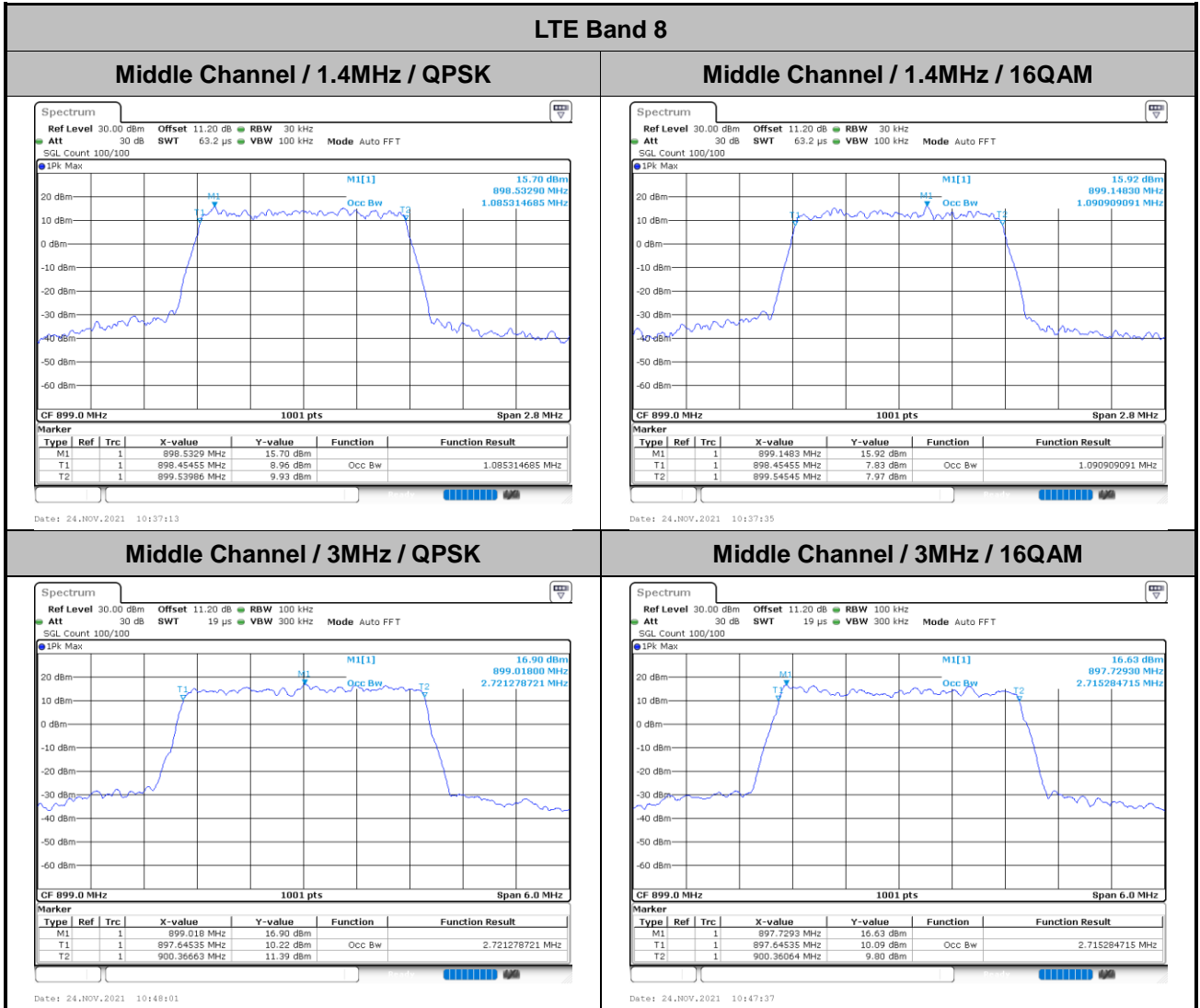



Conducted Band Edge

LTE Band 8 / 1.4MHz / QPSK

Lowest Band Edge / 1RB

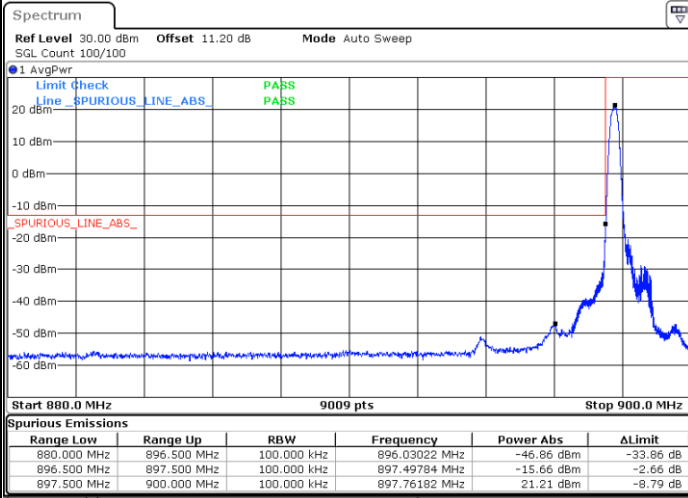

Date: 1.DEC.2021 19:33:29

Highest Band Edge / 1RB

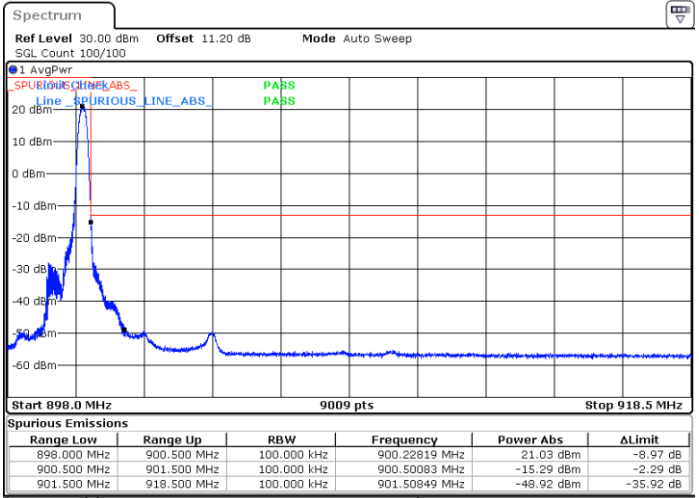

Date: 1.DEC.2021 19:38:36

Lowest Band Edge / Full RB

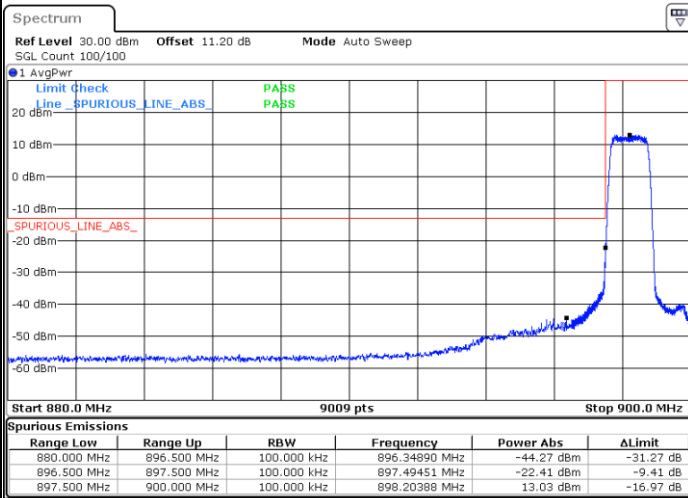

Date: 1.DEC.2021 19:37:32

Highest Band Edge / Full RB

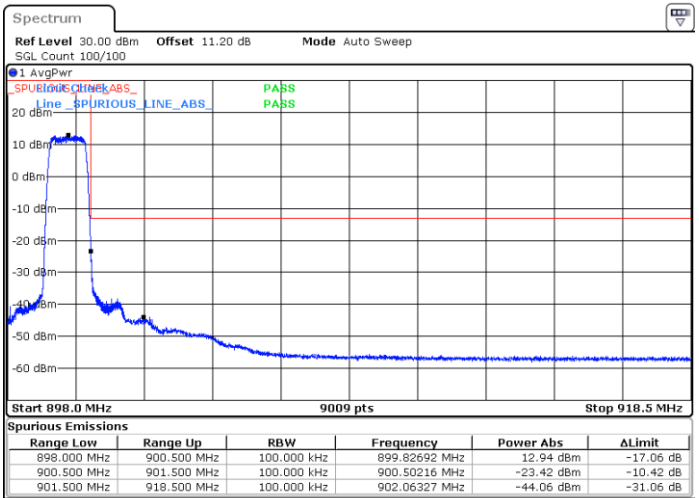

Date: 1.DEC.2021 19:41:22



LTE Band 8 / 1.4MHz / 16QAM

Lowest Band Edge / 1 RB

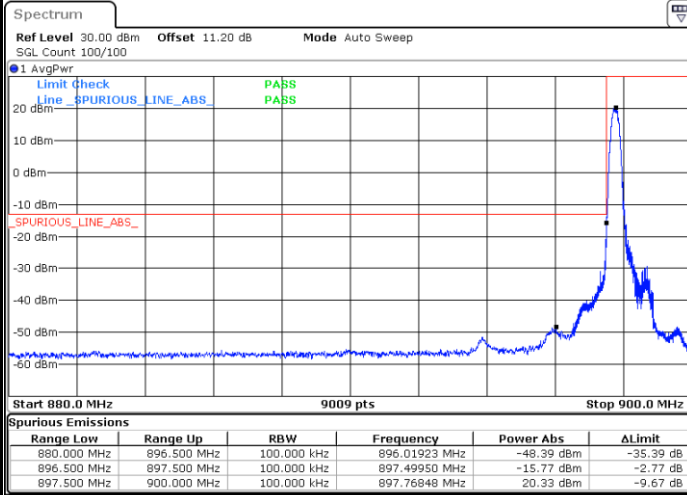

Date: 1.DEC.2021 19:34:59

Highest Band Edge / 1 RB

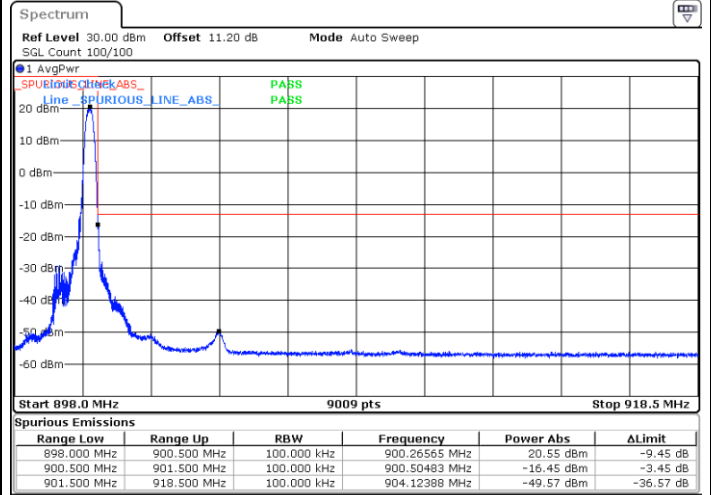

Date: 1.DEC.2021 19:39:27

Lowest Band Edge / Full RB

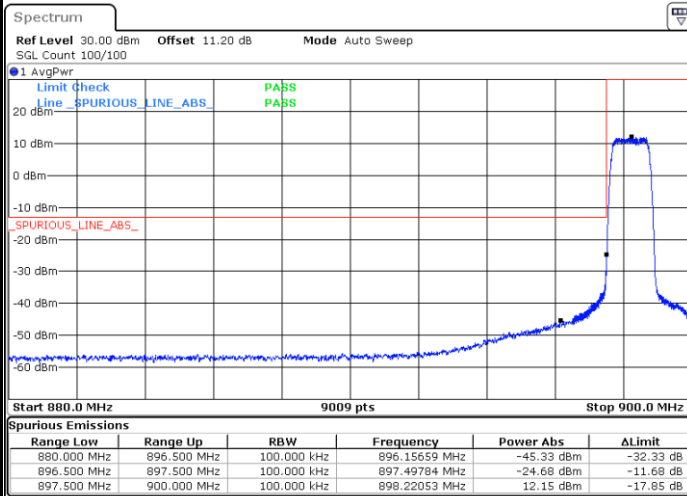

Date: 1.DEC.2021 19:36:53

Highest Band Edge / Full RB

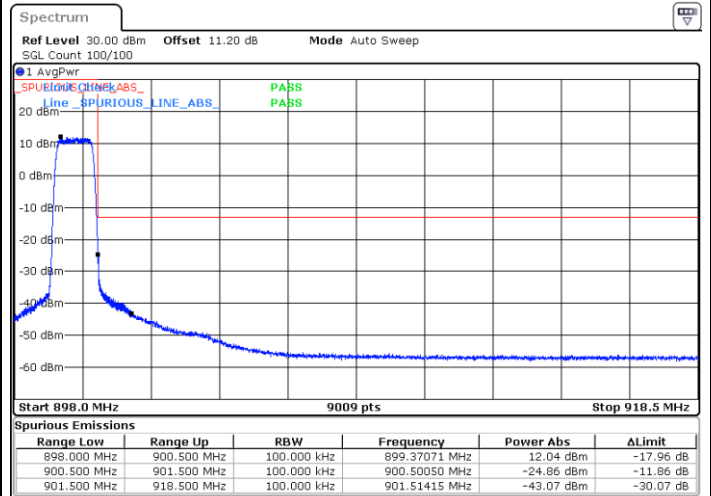

Date: 1.DEC.2021 19:40:36



LTE Band 8 / 3MHz / QPSK

Lowest Band Edge / 1 RB

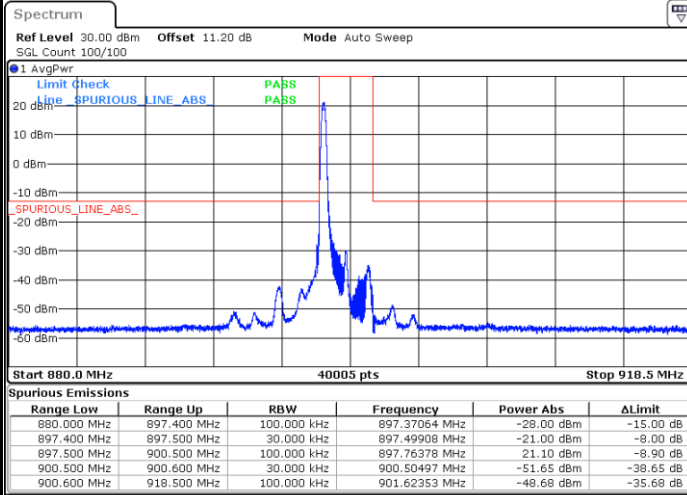

Date: 1.DEC.2021 19:59:32

Highest Band Edge / 1 RB

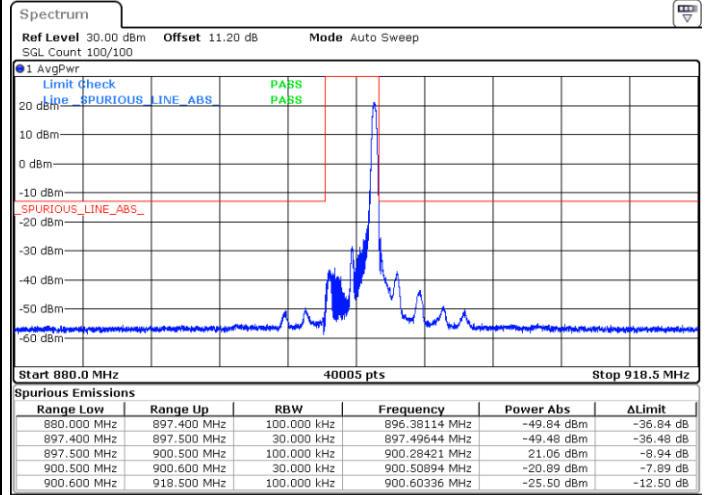

Date: 1.DEC.2021 20:01:39

Band Edge / Full RB

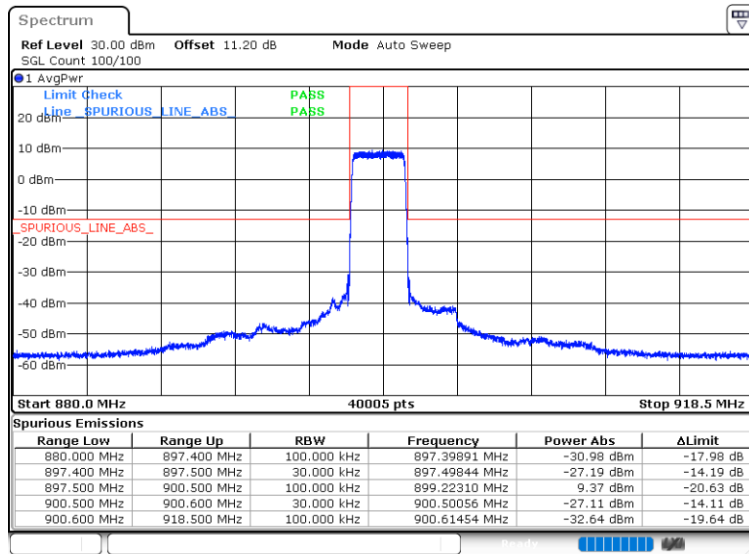

Date: 1.DEC.2021 20:03:32



LTE Band 8 / 3MHz / 16QAM

Lowest Band Edge / 1 RB

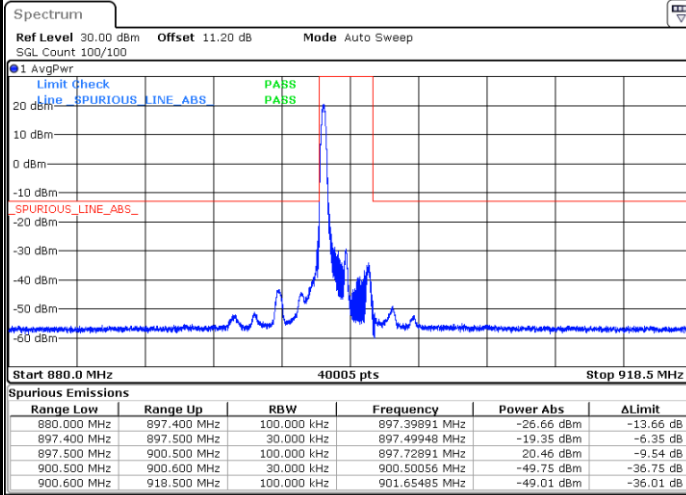

Date: 1.DEC.2021 20:00:38

Highest Band Edge / 1 RB

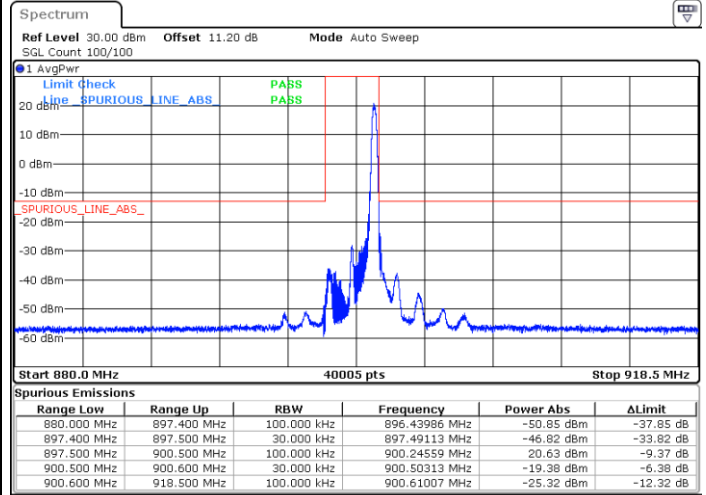

Date: 1.DEC.2021 20:02:31

Band Edge / Full RB

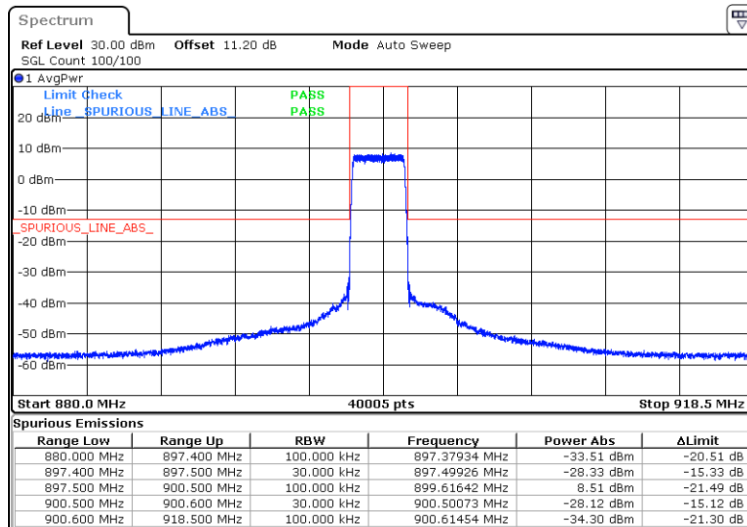

Date: 1.DEC.2021 20:04:42



Conducted Spurious Emission

LTE Band 8 / 1.4MHz

Lowest Channel / QPSK

Middle Channel / QPSK

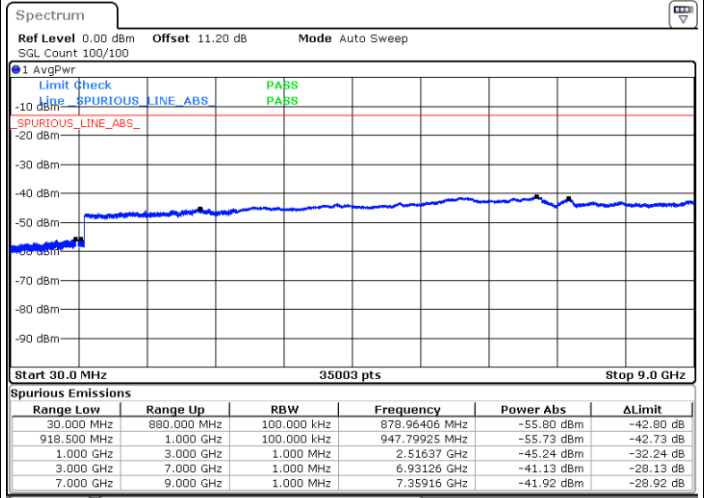
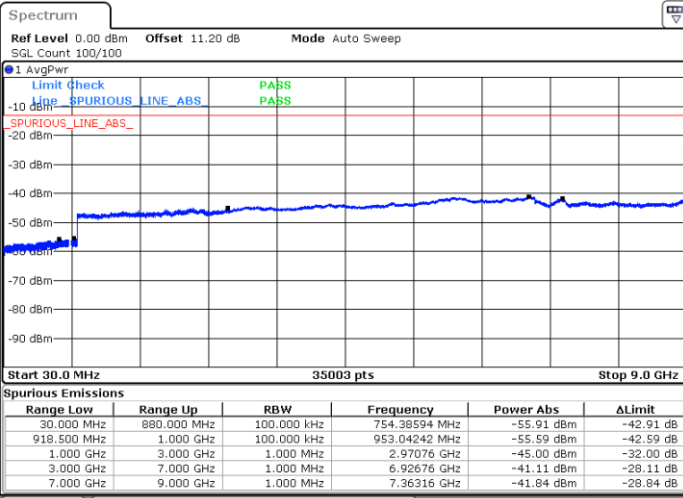

Date: 24.NOV.2021 10:30:46

Date: 24.NOV.2021 10:36:52

Highest Channel / QPSK

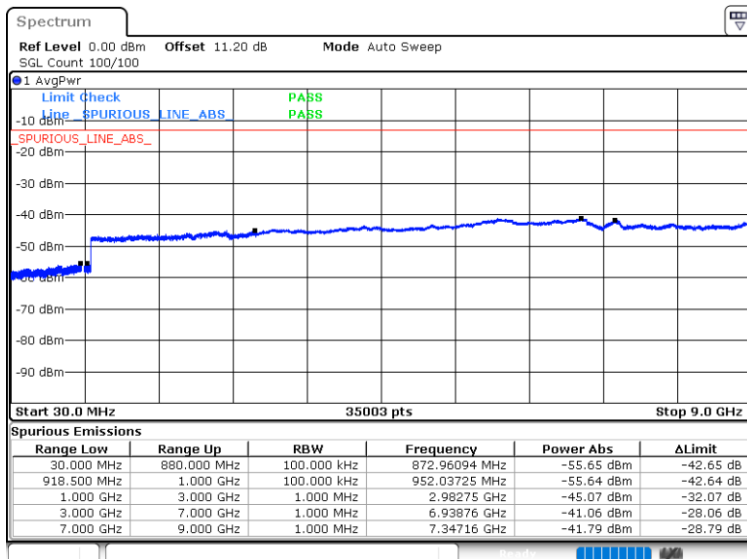

Date: 24.NOV.2021 10:36:12



LTE Band 8 / 3MHz

Middle Channel / QPSK

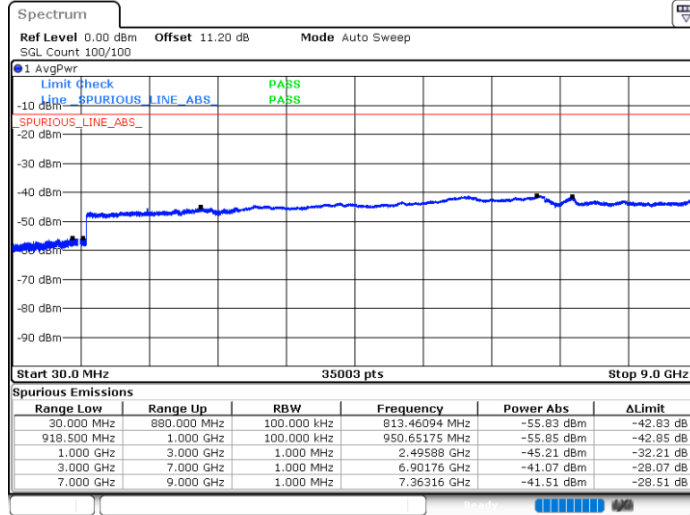

Date: 24.NOV.2021 10:38:58



Frequency Stability

Test Conditions		LTE Band 8 (QPSK) / Middle Channel	Limit
Temperature (°C)	Voltage (Volt)	BW 3MHz	Note 2.
		Deviation (ppm)	Result
50	Normal Voltage	0.0048	PASS
40	Normal Voltage	0.0096	
30	Normal Voltage	0.0047	
20(Ref.)	Normal Voltage	0.0000	
10	Normal Voltage	0.0136	
0	Normal Voltage	0.0039	
-10	Normal Voltage	0.0069	
-20	Normal Voltage	0.0123	
-30	Normal Voltage	0.0037	
20	Maximum Voltage	0.0078	
20	Normal Voltage	0.0000	
20	Battery End Point	0.0023	

Note:

- 1. Normal Voltage =3.3 V. ; Battery End Point (BEP) =3.135 V. ; Maximum Voltage =3.6 V.
- 2. The frequency fundamental emissions stay within the authorized frequency block.



Appendix B. Test Results of Radiated Test

LTE Band 8

LTE Band 8 / 1.4MHz / QPSK									
Channel	Frequency (MHz)	ERP (dBm)	Limit (dBm)	Over Limit (dB)	SPA Reading (dBm)	S.G. Power (dBm)	TX Cable loss (dB)	TX Antenna Gain (dBi)	Polarization (H/V)
Lowest	1795	-58.97	-13	-45.97	-72.23	-60.25	1.04	4.47	H
	2693	-59.21	-13	-46.21	-76.66	-61.26	1.35	5.55	H
	3590	-57.26	-13	-44.26	-77.7	-61.59	1.63	8.11	H
									H
									H
									H
									H
	1795	-57.47	-13	-44.47	-71.14	-58.75	1.04	4.47	V
	2693	-57.57	-13	-44.57	-75.69	-59.62	1.35	5.55	V
	3590	-57.21	-13	-44.21	-77.55	-61.54	1.63	8.11	V
									V
									V
									V
									V
Middle	1797	-58.40	-13	-45.40	-71.66	-59.67	1.04	4.47	H
	2695	-58.96	-13	-45.96	-76.42	-61.01	1.35	5.56	H
	3593	-56.99	-13	-43.99	-77.43	-61.32	1.63	8.11	H
									H
									H
									H
									H
	1797	-57.24	-13	-44.24	-70.91	-58.51	1.04	4.47	V
	2695	-58.48	-13	-45.48	-76.61	-60.53	1.35	5.56	V
	3593	-56.87	-13	-43.87	-77.22	-61.2	1.63	8.11	V
									V
									V
									V
									V
								V	



LTE Band 8 / 1.4MHz / QPSK									
Channel	Frequency (MHz)	ERP (dBm)	Limit (dBm)	Over Limit (dB)	SPA Reading (dBm)	S.G. Power (dBm)	TX Cable loss (dB)	TX Antenna Gain (dBi)	Polarization (H/V)
Highest	1798	-58.50	-13	-45.50	-71.76	-59.77	1.04	4.47	H
	2697	-58.58	-13	-45.58	-76.04	-60.64	1.35	5.56	H
	3596	-57.23	-13	-44.23	-77.67	-61.56	1.63	8.12	H
									H
									H
									H
									H
	1798	-56.99	-13	-43.99	-70.66	-58.26	1.04	4.47	V
	2697	-58.42	-13	-45.42	-76.55	-60.48	1.35	5.56	V
	3596	-57.03	-13	-44.03	-77.38	-61.36	1.63	8.12	V
									V
									V
									V
									V

Remark: Spurious emissions within 30-1000MHz were found more than 20dB below limit line.

Appendix C. Setup Photographs

<Radiated Emission>

Vertical Antenna

LF

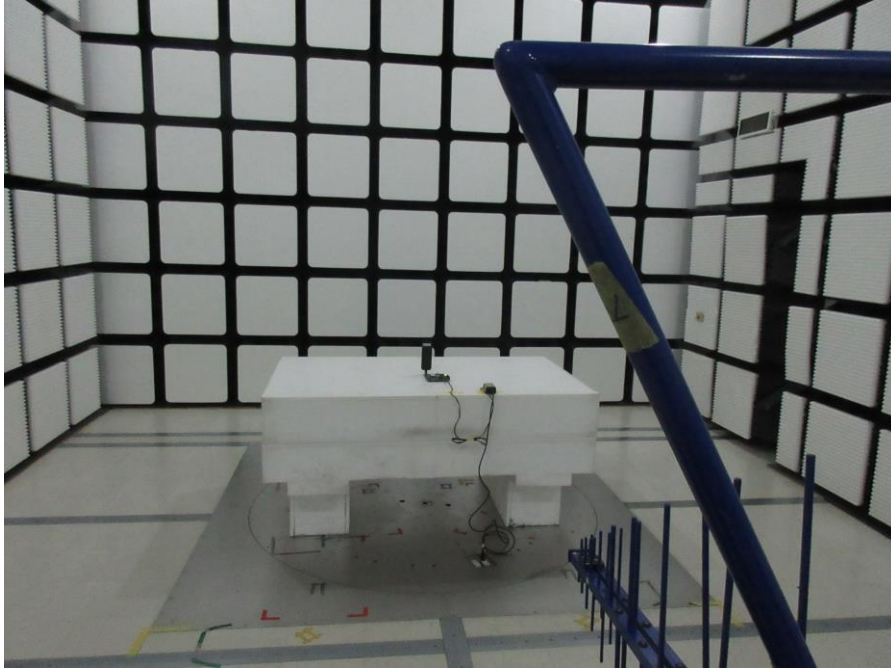

HF

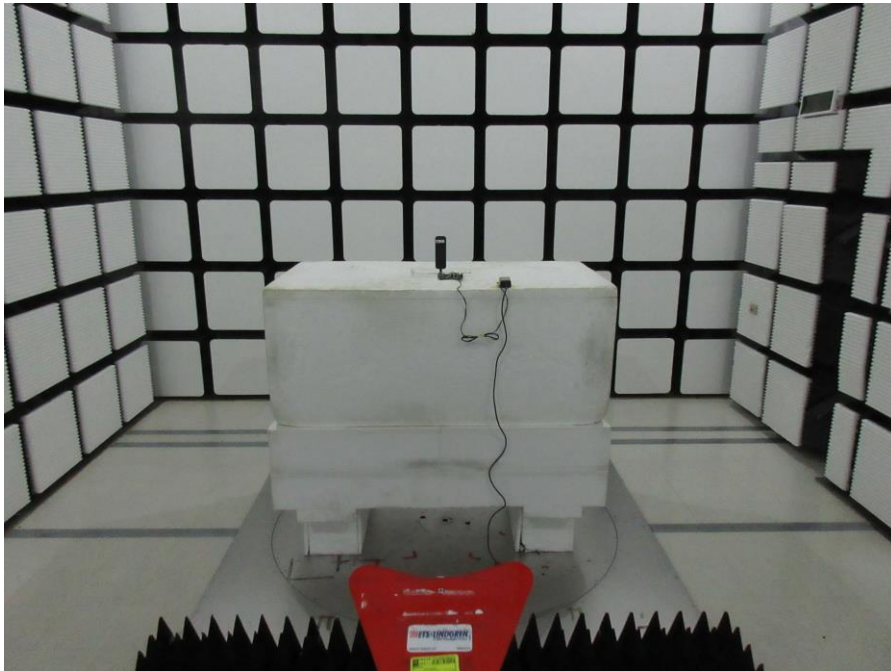

————THE END————