

FCC SAR Test Report

Report No. : SA160512C18
Applicant : Sierra Wireless Inc.
Address : 13811,Wireless Way,Richmond,BC Canada V6V 3A4
Product : PCIe wireless WAN card
FCC ID : N7NEM7455-D5
Brand : AirPrime
Model No. : EM7455
Standards : FCC 47 CFR Part 2 (2.1093) / IEEE C95.1:1992 / IEEE Std 1528:2013
KDB 865664 D01 v01r04 / KDB 865664 D02 v01r02
KDB 248227 D01 v02r02 / KDB 616217 D04 v01r02
KDB 941225 D01 v03r01 / KDB 941225 D05 v02r05
Sample Received Date : May 12, 2016
Date of Testing : Nov. 16, 2016 ~ Feb. 24, 2017
Lab Address : No. 47-2, 14th Ling, Chia Pau Vil., Lin Kou Dist., New Taipei City, Taiwan, R.O.C.
Test Location : No. 19, Hwa Ya 2nd Rd, Wen Hwa Vil, Kwei Shan Dist., Taoyuan City 33383, Taiwan (R.O.C)

CERTIFICATION: The above equipment have been tested by **Bureau Veritas Consumer Products Services (H.K.) Ltd., Taoyuan Branch – Lin Kou Laboratories**, and found compliance with the requirement of the above standards. The test record, data evaluation & Equipment Under Test (EUT) configurations represented herein are true and accurate accounts of the measurements of the sample's SAR characteristics under the conditions specified in this report. It should not be reproduced except in full, without the written approval of our laboratory. The client should not use it to claim product certification, approval, or endorsement by TAF or any government agencies.

Prepared By : 
Gina Liu / Specialist

Approved By : 
Eli Hsu / Project Engineer



This report is for your exclusive use. Any copying or replication of this report to or for any other person or entity, or use of our name or trademark, is permitted only with our prior written permission. This report sets forth our findings solely with respect to the test samples identified herein. The results set forth in this report are not indicative or representative of the quality or characteristics of the lot from which a test sample was taken or any similar or identical product unless specifically and expressly noted. Our report includes all of the tests requested by you and the results thereof based upon the information that you provided to us. You have 60 days from date of issuance of this report to notify us of any material error or omission caused by our negligence, provided, however, that such notice shall be in writing and shall specifically address the issue you wish to raise. A failure to raise such issue within the prescribed time shall constitute your unqualified acceptance of the completeness of this report, the tests conducted and the correctness of the report contents. Unless specific mention, the uncertainty of measurement has been explicitly taken into account to declare the compliance or non-compliance to the specification.

Table of Contents

Release Control Record	3
1. Summary of Maximum SAR Value	4
2. Description of Equipment Under Test	6
3. SAR Measurement System	8
3.1 Definition of Specific Absorption Rate (SAR)	8
3.2 SPEAG DASY52 System	8
3.2.1 Robot.....	9
3.2.2 Probes.....	10
3.2.3 Data Acquisition Electronics (DAE)	10
3.2.4 Phantoms	11
3.2.5 Device Holder.....	12
3.2.6 System Validation Dipoles	12
3.2.7 Tissue Simulating Liquids.....	13
3.3 SAR System Verification	16
3.4 SAR Measurement Procedure	17
3.4.1 Area & Zoom Scan Procedure	17
3.4.2 Volume Scan Procedure.....	17
3.4.3 Power Drift Monitoring.....	18
3.4.4 Spatial Peak SAR Evaluation	18
3.4.5 SAR Averaged Methods	18
4. SAR Measurement Evaluation	19
4.1 EUT Configuration and Setting.....	19
4.2 EUT Testing Position	26
4.2.1 Body Exposure Conditions	26
4.2.2 SAR Test Exclusion Evaluations	28
4.2.3 Simultaneous Transmission Possibilities	30
4.3 Tissue Verification	32
4.4 System Validation.....	34
4.5 System Verification.....	34
4.6 Maximum Output Power.....	37
4.6.1 Maximum Conducted Power	37
4.6.2 Measured Conducted Power Result.....	40
4.7 SAR Testing Results	63
4.7.1 SAR Test Reduction Considerations	63
4.7.2 SAR Results for Body Exposure Condition	65
4.7.3 SAR Measurement Variability.....	76
4.7.4 Simultaneous Multi-band Transmission Evaluation	77
5. Calibration of Test Equipment.....	126
6. Measurement Uncertainty	127
7. Information on the Testing Laboratories.....	129
Appendix A. SAR Plots of System Verification	
Appendix B. SAR Plots of SAR Measurement	
Appendix C. Calibration Certificate for Probe and Dipole	
Appendix D. Photographs of EUT and Setup	



Release Control Record

Report No.	Reason for Change	Date Issued
SA160512C18	Initial release	Feb. 24, 2017

1. Summary of Maximum SAR Value

WWAN (EM7455) + WLAN (QCNFA344A)

Equipment Class	Mode	Highest Reported Body SAR _{1g} (W/kg)	
		Tablet PC	Laptop PC
PCB	WCDMA II	1.33	N/A
	WCDMA IV	1.33	N/A
	WCDMA V	0.85	N/A
	LTE 2	1.08	N/A
	LTE 4	0.97	N/A
	LTE 5	1.15	N/A
	LTE 7	0.71	N/A
	LTE 12	1.02	N/A
	LTE 13	1.04	N/A
	LTE 25	0.92	N/A
	LTE 26	0.63	N/A
LTE 41	0.75	N/A	
DTS	2.4G WLAN	0.19	0.02
NII	5.3G WLAN	0.55	0.04
	5.6G WLAN	0.46	0.03
	5.8G WLAN	0.61	0.04
DSS	Bluetooth	0.00	0.00
Highest Simultaneous Transmission SAR		Body (W/kg)	Body (W/kg)
PCB + DTS+DSS		1.38	0.63
PCB + NII+DSS		1.58	0.65

Note:

- The SAR limit (**Head & Body: SAR_{1g} 1.6 W/kg, Extremity: SAR_{10g} 4.0 W/kg**) for general population / uncontrolled exposure is specified in FCC 47 CFR part 2 (2.1093) and ANSI/IEEE C95.1-1992.

FCC SAR Test Report

WWAN (EM7455) + WLAN (8265NGW)

Equipment Class	Mode	Highest Reported Body SAR _{1g} (W/kg)	
		Tablet PC	Laptop PC
PCB	WCDMA II	1.33	N/A
	WCDMA IV	1.33	N/A
	WCDMA V	0.85	N/A
	LTE 2	1.08	N/A
	LTE 4	0.97	N/A
	LTE 5	1.15	N/A
	LTE 7	0.71	N/A
	LTE 12	1.02	N/A
	LTE 13	1.04	N/A
	LTE 25	0.92	N/A
	LTE 26	0.63	N/A
LTE 41	0.75	N/A	
DTS	2.4G WLAN	0.44	0.06
NII	5.3G WLAN	0.82	0.10
	5.6G WLAN	0.97	0.10
	5.8G WLAN	1.11	0.08
DSS	Bluetooth	0.20	0.06
Highest Simultaneous Transmission SAR		Body (W/kg)	Body (W/kg)
PCB + DTS Ant0 + DTS Ant1		1.57	0.86
PCB + NII Ant0 +NII Ant1		1.53	0.90
PCB + DTS Ant0 + DSS Ant1		1.51	0.83
PCB + NII Ant0 + DSS Ant1		1.53	0.83

Note:

1. The SAR limit (**Head & Body: SAR_{1g} 1.6 W/kg, Extremity: SAR_{10g} 4.0 W/kg**) for general population / uncontrolled exposure is specified in FCC 47 CFR part 2 (2.1093) and ANSI/IEEE C95.1-1992.
2. Since the models of P29S have the same WLAN and BT feature, the test data for WLAN SAR in RF Exposure Lab report is referring to SAR report (Test Report No.: SAR.20161106, Issue Date: Nov. 16-18, 2016).

2. Description of Equipment Under Test

EUT Type	PCIe wireless WAN card
FCC ID	N7NEM7455-D5
Brand Name	AirPrime
Model Name	EM7455
EUT Configurations	EUT 1: EUT + Antenna 1 (Ethertronics) EUT 2: EUT + Antenna 2 (WNC)
Tx Frequency Bands (Unit: MHz)	WCDMA Band II : 1852.4 ~ 1907.6 WCDMA Band IV : 1712.4 ~ 1752.6 WCDMA Band V : 826.4 ~ 846.6 LTE Band 2 : 1850.7 ~ 1909.3 (1.4M), 1851.5 ~ 1908.5 (3M), 1852.5 ~ 1907.5 (5M), 1855 ~ 1905 (10M), 1857.5 ~ 1902.5 (15M), 1860 ~ 1900 (20M) LTE Band 4 : 1710.7 ~ 1754.3 (1.4M), 1711.5 ~ 1753.5 (3M), 1712.5 ~ 1752.5 (5M), 1715 ~ 1750 (10M), 1717.5 ~ 1747.5 (15M), 1720 ~ 1745 (20M) LTE Band 5 : 824.7 ~ 848.3 (1.4M), 825.5 ~ 847.5 (3M), 826.5 ~ 846.5 (5M), 829 ~ 844 (10M) LTE Band 7 : 2502.5 ~ 2567.5 (5M), 2505 ~ 2565 (10M), 2507.5 ~ 2562.5 (15M), 2510 ~ 2560 (20M) LTE Band 12 : 699.7 ~ 715.3 (1.4M), 700.5 ~ 714.5 (3M), 701.5 ~ 713.5 (5M), 704 ~ 711 (10M) LTE Band 13 : 779.5 ~ 784.5 (5M), 782 (10M) LTE Band 25 : 1850.7 ~ 1914.3 (1.4M), 1851.5 ~ 1913.5 (3M), 1852.5 ~ 1912.5 (5M), 1855 ~ 1910 (10M), 1857.5 ~ 1907.5 (15M), 1860 ~ 1905 (20M) LTE Band 26 : 814.7 ~ 848.3 (1.4M), 815.5 ~ 847.5 (3M), 816.5 ~ 846.5 (5M), 819 ~ 844 (10M), 821.5 ~ 841.5 (15M) LTE Band 30 : Disabled LTE Band 41 : 2502.5 ~ 2687.5 (5M), 2505 ~ 2685 (10M), 2507.5 ~ 2682.5 (15M), 2510 ~ 2680 (20M) WLAN : 2412 ~ 2462, 5180 ~ 5240, 5260 ~ 5320, 5500 ~ 5700, 5745 ~ 5825 Bluetooth : 2402 ~ 2480
Uplink Modulations	GSM & GPRS : GMSK EDGE : 8PSK WCDMA : QPSK CDMA : QPSK LTE : QPSK, 16QAM 802.11b : DSSS 802.11a/g/n/ac : OFDM Bluetooth : GFSK, $\pi/4$ -DQPSK, 8-DPSK
Maximum Tune-up Conducted Power (Unit: dBm)	Please refer to section 4.6.1 of this report.
Antenna Type	Refer to Note
EUT Stage	Identical Prototype

Note:

1. The EUT was installed in Portable Computer (Brand: DELL, Model: P29S).
2. The information of WLAN and WWAN module collocated in this EUT is listed as below.

Item	Brand Name	Model Name	Specification
BT + Wifi module	Qualcomm Atheros	QCNFA344A	2T2R 802.11 a/b/g/n/ac WLAN+ Bluetooth
BT + Wifi module	Intel	8265NGW	2T2R 802.11 a/b/g/n/ac WLAN+ Bluetooth
WWAN module	AirPrime (SIERRA)	EM7455	WCDMA + LTE

FCC SAR Test Report

3. The antenna information is listed as below.

Tablet Mode						
Antenna Type	Manufacturer	Parts Number	Antenna Gain (dBi)			
			WLAN 2.4 GHz	WLAN 5.15~5.35 GHz	WLAN 5.47~5.725 GHz	WLAN 5.725~5.825 GHz
PIFA	Ethertronics Inc.	WLAN Main Antenna: 5002345 WLAN Aux Antenna: 5002359	Main: -1.46 Aux.: 0.30	Main: 1.14 Aux.: -2.04	Main: -1.67 Aux.: -0.42	Main: -1.57 Aux.: 0.64
	WNC	WLAN Main Antenna: 81EAA515.G53 WLAN Aux Antenna: 81EAA515.G54	Main: 0.33 Aux.: 1.75	Main: -2.07 Aux.: -1.52	Main: -2.63 Aux.: -1.78	Main: -2.85 Aux.: -1.60

Tablet Mode														
Antenna Type	Manufacturer	Parts Number	Antenna Gain (dBi)											
			WCDMA II	WCDMA IV	WCDMA V	LTE B2	LTE B4	LTE B5	LTE B7	LTE B12	LTE B13	LTE B25	LTE B26	LTE B41
PIFA	Ethertronics Inc.	WWAN Main Antenna: 5002331	Main: 2.98	Main: 2.98	Main: 1.67	Main: 2.98	Main: 2.98	Main: 1.67	Main: 2.48	Main: 1.49	Main: 2.04	Main: 2.98	Main: 2.04	Main: 2.48
		WWAN Aux Antenna: 5002345	Aux.: -1.90	Aux.: -1.90	Aux.: -	Aux.: -1.90	Aux.: -1.90	Aux.: -	Aux.: 0.38	Aux.: -	Aux.: -0.44	Aux.: -1.90	Aux.: -0.44	Aux.: 0.38
	WNC	WWAN Main Antenna: 81EAA515.G52	Main: 2.58	Main: 2.58	Main: 0.19	Main: 2.58	Main: 2.58	Main: 0.19	Main: 1.98	Main: 0.46	Main: 0.46	Main: 2.58	Main: 0.46	Main: 1.98
		WWAN Aux Antenna: 81EAA515.G53	Aux.: 0.92	Aux.: 0.92	Aux.: -	Aux.: 0.92	Aux.: 0.92	Aux.: -	Aux.: 0.24	Aux.: -	Aux.: -2.53	Aux.: 0.92	Aux.: -2.53	Aux.: 0.24

Laptop Mode						
Antenna Type	Manufacturer	Parts Number	Antenna Gain (dBi)			
			WLAN 2.4 GHz	WLAN 5.15~5.35 GHz	WLAN 5.47~5.725 GHz	WLAN 5.725~5.825 GHz
PIFA	Ethertronics Inc.	WLAN Main Antenna: 5002345 WLAN Aux Antenna: 5002359	Main: -0.95 Aux.: 0.65	Main: 0.03 Aux.: -2.63	Main: -1.67 Aux.: -1.46	Main: -2.17 Aux.: -1.46
	WNC	WLAN Main Antenna: 81EAA515.G53 WLAN Aux Antenna: 81EAA515.G54	Main: -0.21 Aux.: 0.05	Main: -2.09 Aux.: 0.38	Main: -1.77 Aux.: 0.88	Main: -2.13 Aux.: 0.32

Laptop Mode														
Antenna Type	Manufacturer	Parts Number	Antenna Gain (dBi)											
			WCDMA II	WCDMA IV	WCDMA V	LTE B2	LTE B4	LTE B5	LTE B7	LTE B12	LTE B13	LTE B25	LTE B26	LTE B41
PIFA	Ethertronics Inc.	WWAN Main Antenna: 5002331	Main: 1.49	Main: 1.49	Main: 0.91	Main: 1.49	Main: 1.49	Main: 0.91	Main: 2.98	Main: 1.49	Main: 1.49	Main: 1.49	Main: 1.49	Main: 2.98
		WWAN Aux Antenna: 5002345	Aux.: 1.24	Aux.: 1.24	Aux.: -	Aux.: 1.24	Aux.: 1.24	Aux.: -	Aux.: 1.86	Aux.: -	Aux.: 1.24	Aux.: 1.24	Aux.: 1.24	Aux.: 1.86
	WNC	WWAN Main Antenna: 81EAA515.G52	Main: 1.44	Main: 1.44	Main: 0.66	Main: 1.44	Main: 1.44	Main: 0.66	Main: 2.21	Main: 1.44	Main: 1.44	Main: 1.44	Main: 1.44	Main: 2.21
		WWAN Aux Antenna: 81EAA515.G53	Aux.: -1.57	Aux.: -1.57	Aux.: -	Aux.: -1.57	Aux.: -1.57	Aux.: -	Aux.: 0.68	Aux.: -	Aux.: -1.57	Aux.: -1.57	Aux.: -1.57	Aux.: 0.68

4. The above EUT information is declared by manufacturer and for more detailed features description please refers to the manufacturer's specifications or User's Manual.

List of Accessory:

Battery 1	Brand Name	Dell (Simplo)
	Model Name	71TG4
	Power Rating	7.6 Vdc, 7500 mAh, 45 Wh
	Type	Li-ion
Battery 2	Brand Name	Dell (Simplo)
	Model Name	K5XWW
	Power Rating	7.6 Vdc, 7500 mAh, 60 Wh
	Type	Li-ion

3. SAR Measurement System

3.1 Definition of Specific Absorption Rate (SAR)

SAR is related to the rate at which energy is absorbed per unit mass in an object exposed to a radio field. The SAR distribution in a biological body is complicated and is usually carried out by experimental techniques or numerical modeling. The standard recommends limits for two tiers of groups, occupational/controlled and general population/uncontrolled, based on a person's awareness and ability to exercise control over his or her exposure. In general, occupational/controlled exposure limits are higher than the limits for general population/uncontrolled.

The SAR definition is the time derivative (rate) of the incremental energy (dW) absorbed by (dissipated in) an incremental mass (dm) contained in a volume element (dv) of a given density (ρ). The equation description is as below:

$$\text{SAR} = \frac{d}{dt} \left(\frac{dW}{dm} \right) = \frac{d}{dt} \left(\frac{dW}{\rho dv} \right)$$

SAR is expressed in units of Watts per kilogram (W/kg)

SAR measurement can be related to the electrical field in the tissue by

$$\text{SAR} = \frac{\sigma |E|^2}{\rho}$$

Where: σ is the conductivity of the tissue, ρ is the mass density of the tissue and E is the RMS electrical field strength.

3.2 SPEAG DASY52 System

DASY52 system consists of high precision robot, probe alignment sensor, phantom, robot controller, controlled measurement server and near-field probe. The robot includes six axes that can move to the precision position of the DASY52 software defined. The DASY52 software can define the area that is detected by the probe. The robot is connected to controlled box. Controlled measurement server is connected to the controlled robot box. The DAE includes amplifier, signal multiplexing, AD converter, offset measurement and surface detection. It is connected to the Electro-optical coupler (ECO). The ECO performs the conversion from the optical into digital electric signal of the DAE and transfers data to the PC.

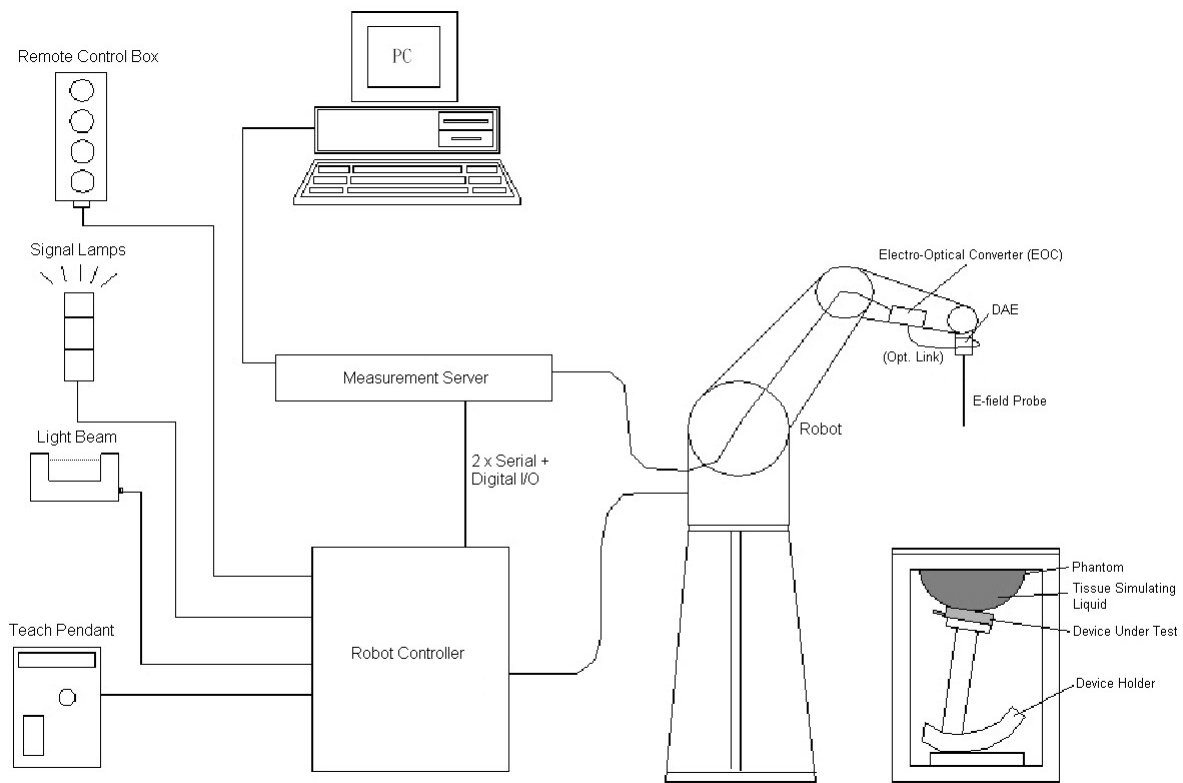

Fig-3.1 SPEAG DASY52 System Setup

3.2.1 Robot

The DASY52 systems use the high precision robots from Stäubli SA (France). For the 6-axis controller system, the robot controller version of CS8c from Stäubli is used. The Stäubli robot series have many features that are important for our application:

- High precision (repeatability ± 0.035 mm)
- High reliability (industrial design)
- Jerk-free straight movements
- Low ELF interference (the closed metallic construction shields against motor control fields)





Fig-3.2 SPEAG DASY52 System

FCC SAR Test Report

3.2.2 Probes

The SAR measurement is conducted with the dosimetric probe. The probe is specially designed and calibrated for use in liquid with high permittivity. The dosimetric probe has special calibration in liquid at different frequency.

Model	EX3DV4	
Construction	Symmetrical design with triangular core. Built-in shielding against static charges. PEEK enclosure material (resistant to organic solvents, e.g., DGBE).	
Frequency	10 MHz to 6 GHz Linearity: ± 0.2 dB	
Directivity	± 0.3 dB in HSL (rotation around probe axis) ± 0.5 dB in tissue material (rotation normal to probe axis)	
Dynamic Range	10 μ W/g to 100 mW/g Linearity: ± 0.2 dB (noise: typically < 1 μ W/g)	
Dimensions	Overall length: 337 mm (Tip: 20 mm) Tip diameter: 2.5 mm (Body: 12 mm) Typical distance from probe tip to dipole centers: 1 mm	

Model	ES3DV3	
Construction	Symmetrical design with triangular core. Interleaved sensors. Built-in shielding against static charges. PEEK enclosure material (resistant to organic solvents, e.g., DGBE).	
Frequency	10 MHz to 4 GHz Linearity: ± 0.2 dB	
Directivity	± 0.2 dB in HSL (rotation around probe axis) ± 0.3 dB in tissue material (rotation normal to probe axis)	
Dynamic Range	5 μ W/g to 100 mW/g Linearity: ± 0.2 dB	
Dimensions	Overall length: 337 mm (Tip: 20 mm) Tip diameter: 3.9 mm (Body: 12 mm) Distance from probe tip to dipole centers: 2.0 mm	

Model	ET3DV6	
Construction	Symmetrical design with triangular core Built-in optical fiber for surface detection system. Built-in shielding against static charges. PEEK enclosure material (resistant to organic solvents, e.g., DGBE)	
Frequency	10 MHz to 2.3 GHz; Linearity: ± 0.2 dB	
Directivity	± 0.2 dB in TSL (rotation around probe axis) ± 0.4 dB in TSL (rotation normal to probe axis)	
Dynamic Range	5 μ W/g to 100 mW/g; Linearity: ± 0.2 dB	
Dimensions	Overall length: 337 mm (Tip: 16 mm) Tip diameter: 6.8 mm (Body: 12 mm) Distance from probe tip to dipole centers: 2.7 mm	

3.2.3 Data Acquisition Electronics (DAE)

Model	DAE3, DAE4	
Construction	Signal amplifier, multiplexer, A/D converter and control logic. Serial optical link for communication with DASY embedded system (fully remote controlled). Two step probe touch detector for mechanical surface detection and emergency robot stop.	
Measurement Range	-100 to +300 mV (16 bit resolution and two range settings: 4mV, 400mV)	
Input Offset Voltage	$< 5\mu$ V (with auto zero)	
Input Bias Current	< 50 fA	
Dimensions	60 x 60 x 68 mm	

FCC SAR Test Report

3.2.4 Phantoms

Model	Twin SAM	
Construction	The shell corresponds to the specifications of the Specific Anthropomorphic Mannequin (SAM) phantom defined in IEEE 1528 and IEC 62209-1. It enables the dosimetric evaluation of left and right hand phone usage as well as body mounted usage at the flat phantom region. A cover prevents evaporation of the liquid. Reference markings on the phantom allow the complete setup of all predefined phantom positions and measurement grids by teaching three points with the robot.	
Material	Vinylester, glass fiber reinforced (VE-GF)	
Shell Thickness	2 ± 0.2 mm (6 ± 0.2 mm at ear point)	
Dimensions	Length: 1000 mm Width: 500 mm Height: adjustable feet	
Filling Volume	approx. 25 liters	

Model	ELI	
Construction	Phantom for compliance testing of handheld and body-mounted wireless devices in the frequency range of 30 MHz to 6 GHz. ELI is fully compatible with the IEC 62209-2 standard and all known tissue simulating liquids. ELI has been optimized regarding its performance and can be integrated into our standard phantom tables. A cover prevents evaporation of the liquid. Reference markings on the phantom allow installation of the complete setup, including all predefined phantom positions and measurement grids, by teaching three points. The phantom is compatible with all SPEAG dosimetric probes and dipoles.	
Material	Vinylester, glass fiber reinforced (VE-GF)	
Shell Thickness	2.0 ± 0.2 mm (bottom plate)	
Dimensions	Major axis: 600 mm Minor axis: 400 mm	
Filling Volume	approx. 30 liters	

FCC SAR Test Report

3.2.5 Device Holder

Model	Mounting Device	
Construction	In combination with the Twin SAM Phantom or ELI4, the Mounting Device enables the rotation of the mounted transmitter device in spherical coordinates. Rotation point is the ear opening point. Transmitter devices can be easily and accurately positioned according to IEC, IEEE, FCC or other specifications. The device holder can be locked for positioning at different phantom sections (left head, right head, flat).	
Material	POM	

Model	Laptop Extensions Kit	
Construction	Simple but effective and easy-to-use extension for Mounting Device that facilitates the testing of larger devices according to IEC 62209-2 (e.g., laptops, cameras, etc.). It is lightweight and fits easily on the upper part of the Mounting Device in place of the phone positioner.	
Material	POM, Acrylic glass, Foam	

3.2.6 System Validation Dipoles

Model	D-Serial	
Construction	Symmetrical dipole with 1/4 balun. Enables measurement of feed point impedance with NWA. Matched for use near flat phantoms filled with tissue simulating solutions.	
Frequency	750 MHz to 5800 MHz	
Return Loss	> 20 dB	
Power Capability	> 100 W (f < 1GHz), > 40 W (f > 1GHz)	

3.2.7 Tissue Simulating Liquids

For SAR measurement of the field distribution inside the phantom, the phantom must be filled with homogeneous tissue simulating liquid to a depth of at least 15 cm. For head SAR testing, the liquid height from the ear reference point (ERP) of the phantom to the liquid top surface is larger than 15 cm. For body SAR testing, the liquid height from the center of the flat phantom to the liquid top surface is larger than 15 cm. The nominal dielectric values of the tissue simulating liquids in the phantom and the tolerance of 5% are listed in Table-3.1.

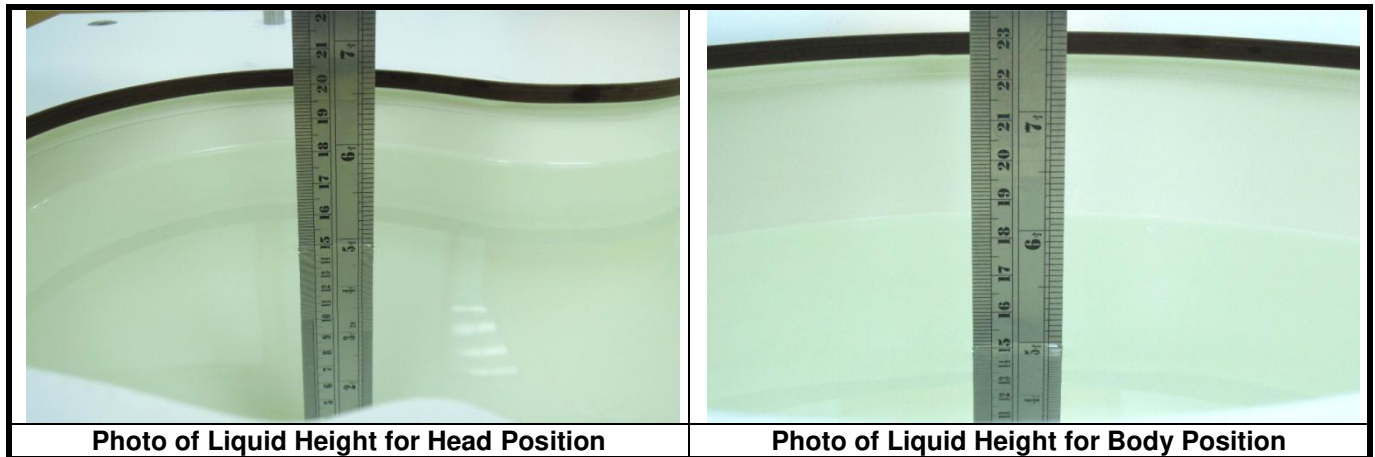

The dielectric properties of the head tissue simulating liquids are defined in IEEE 1528, and KDB 865664 D01 Appendix A. For the body tissue simulating liquids, the dielectric properties are defined in KDB 865664 D01 Appendix A. The dielectric properties of the tissue simulating liquids were verified prior to the SAR evaluation using a dielectric assessment kit and a network analyzer.

Table-3.1 Targets of Tissue Simulating Liquid

Frequency (MHz)	Target Permittivity	Range of $\pm 5\%$	Target Conductivity	Range of $\pm 5\%$
For Head				
750	41.9	39.8 ~ 44.0	0.89	0.85 ~ 0.93
835	41.5	39.4 ~ 43.6	0.90	0.86 ~ 0.95
900	41.5	39.4 ~ 43.6	0.97	0.92 ~ 1.02
1450	40.5	38.5 ~ 42.5	1.20	1.14 ~ 1.26
1640	40.3	38.3 ~ 42.3	1.29	1.23 ~ 1.35
1750	40.1	38.1 ~ 42.1	1.37	1.30 ~ 1.44
1800	40.0	38.0 ~ 42.0	1.40	1.33 ~ 1.47
1900	40.0	38.0 ~ 42.0	1.40	1.33 ~ 1.47
2000	40.0	38.0 ~ 42.0	1.40	1.33 ~ 1.47
2300	39.5	37.5 ~ 41.5	1.67	1.59 ~ 1.75
2450	39.2	37.2 ~ 41.2	1.80	1.71 ~ 1.89
2600	39.0	37.1 ~ 41.0	1.96	1.86 ~ 2.06
3500	37.9	36.0 ~ 39.8	2.91	2.76 ~ 3.06
5200	36.0	34.2 ~ 37.8	4.66	4.43 ~ 4.89
5300	35.9	34.1 ~ 37.7	4.76	4.52 ~ 5.00
5500	35.6	33.8 ~ 37.4	4.96	4.71 ~ 5.21
5600	35.5	33.7 ~ 37.3	5.07	4.82 ~ 5.32
5800	35.3	33.5 ~ 37.1	5.27	5.01 ~ 5.53
For Body				
750	55.5	52.7 ~ 58.3	0.96	0.91 ~ 1.01
835	55.2	52.4 ~ 58.0	0.97	0.92 ~ 1.02
900	55.0	52.3 ~ 57.8	1.05	1.00 ~ 1.10
1450	54.0	51.3 ~ 56.7	1.30	1.24 ~ 1.37
1640	53.8	51.1 ~ 56.5	1.40	1.33 ~ 1.47
1750	53.4	50.7 ~ 56.1	1.49	1.42 ~ 1.56
1800	53.3	50.6 ~ 56.0	1.52	1.44 ~ 1.60
1900	53.3	50.6 ~ 56.0	1.52	1.44 ~ 1.60
2000	53.3	50.6 ~ 56.0	1.52	1.44 ~ 1.60
2300	52.9	50.3 ~ 55.5	1.81	1.72 ~ 1.90
2450	52.7	50.1 ~ 55.3	1.95	1.85 ~ 2.05
2600	52.5	49.9 ~ 55.1	2.16	2.05 ~ 2.27
3500	51.3	48.7 ~ 53.9	3.31	3.14 ~ 3.48
5200	49.0	46.6 ~ 51.5	5.30	5.04 ~ 5.57
5300	48.9	46.5 ~ 51.3	5.42	5.15 ~ 5.69
5500	48.6	46.2 ~ 51.0	5.65	5.37 ~ 5.93
5600	48.5	46.1 ~ 50.9	5.77	5.48 ~ 6.06
5800	48.2	45.8 ~ 50.6	6.00	5.70 ~ 6.30

FCC SAR Test Report

The following table gives the recipes for tissue simulating liquids.

Table-3.2 Recipes of Tissue Simulating Liquid

Tissue Type	Bactericide	DGBE	HEC	NaCl	Sucrose	Triton X-100	Water	Diethylene Glycol Mono-hexylether
H750	0.2	-	0.2	1.5	56.0	-	42.1	-
H835	0.2	-	0.2	1.5	57.0	-	41.1	-
H900	0.2	-	0.2	1.4	58.0	-	40.2	-
H1450	-	43.3	-	0.6	-	-	56.1	-
H1640	-	45.8	-	0.5	-	-	53.7	-
H1750	-	47.0	-	0.4	-	-	52.6	-
H1800	-	44.5	-	0.3	-	-	55.2	-
H1900	-	44.5	-	0.2	-	-	55.3	-
H2000	-	44.5	-	0.1	-	-	55.4	-
H2300	-	44.9	-	0.1	-	-	55.0	-
H2450	-	45.0	-	0.1	-	-	54.9	-
H2600	-	45.1	-	0.1	-	-	54.8	-
H3500	-	8.0	-	0.2	-	20.0	71.8	-
H5G	-	-	-	-	-	17.2	65.5	17.3
B750	0.2	-	0.2	0.8	48.8	-	50.0	-
B835	0.2	-	0.2	0.9	48.5	-	50.2	-
B900	0.2	-	0.2	0.9	48.2	-	50.5	-
B1450	-	34.0	-	0.3	-	-	65.7	-
B1640	-	32.5	-	0.3	-	-	67.2	-
B1750	-	31.0	-	0.2	-	-	68.8	-
B1800	-	29.5	-	0.4	-	-	70.1	-
B1900	-	29.5	-	0.3	-	-	70.2	-
B2000	-	30.0	-	0.2	-	-	69.8	-
B2300	-	31.0	-	0.1	-	-	68.9	-
B2450	-	31.4	-	0.1	-	-	68.5	-
B2600	-	31.8	-	0.1	-	-	68.1	-
B3500	-	28.8	-	0.1	-	-	71.1	-
B5G	-	-	-	-	-	10.7	78.6	10.7

3.3 SAR System Verification

The system check verifies that the system operates within its specifications. It is performed daily or before every SAR measurement. The system check uses normal SAR measurements in the flat section of the phantom with a matched dipole at a specified distance. The system verification setup is shown as below.

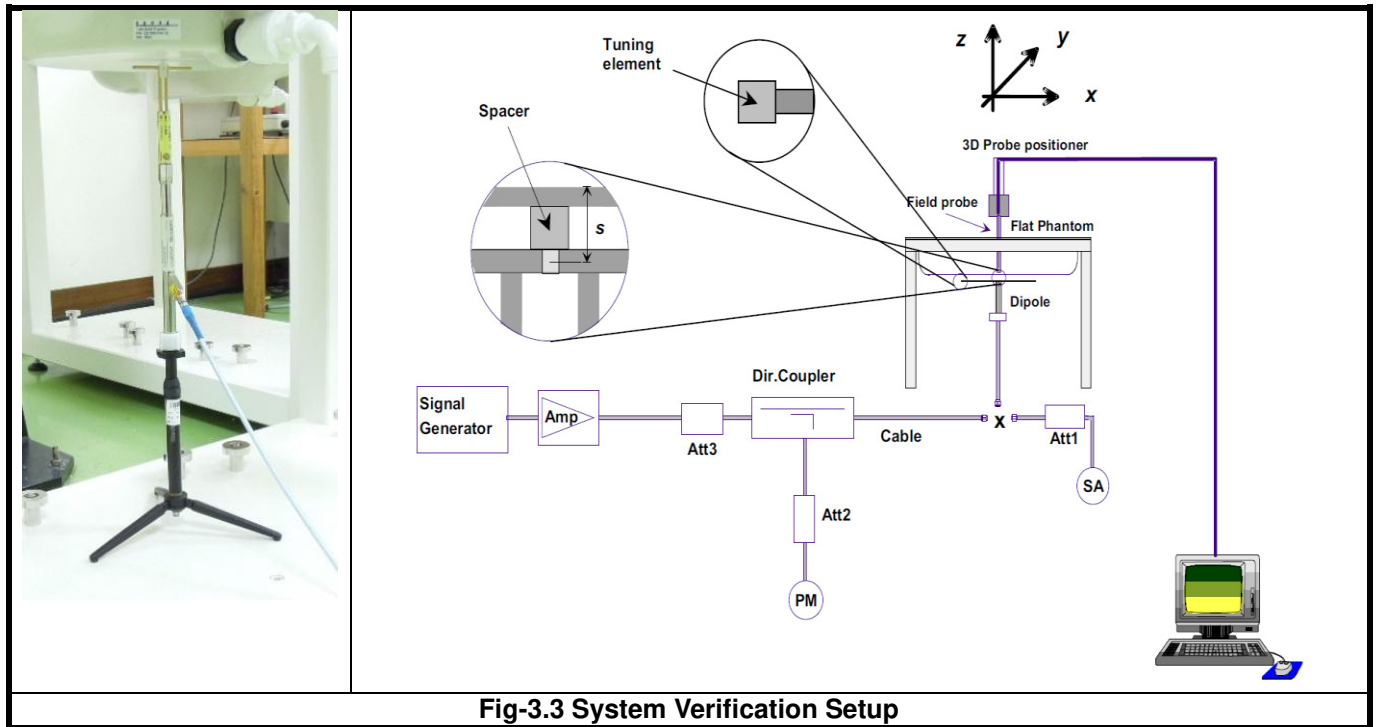

Fig-3.3 System Verification Setup

The validation dipole is placed beneath the flat phantom with the specific spacer in place. The distance spacer is touch the phantom surface with a light pressure at the reference marking and be oriented parallel to the long side of the phantom. The spectrum analyzer measures the forward power at the location of the system check dipole connector. The signal generator is adjusted for the desired forward power (250 mW is used for 700 MHz to 3 GHz, 100 mW is used for 3.5 GHz to 6 GHz) at the dipole connector and the power meter is read at that level. After connecting the cable to the dipole, the signal generator is readjusted for the same reading at power meter.

After system check testing, the SAR result will be normalized to 1W forward input power and compared with the reference SAR value derived from validation dipole certificate report. The deviation of system check should be within 10 %.

3.4 SAR Measurement Procedure

According to the SAR test standard, the recommended procedure for assessing the peak spatial-average SAR value consists of the following steps:

- (a) Power reference measurement
- (b) Area scan
- (c) Zoom scan
- (d) Power drift measurement

The SAR measurement procedures for each of test conditions are as follows:

- (a) Make EUT to transmit maximum output power
- (b) Measure conducted output power through RF cable
- (c) Place the EUT in the specific position of phantom
- (d) Perform SAR testing steps on the DASY system
- (e) Record the SAR value

3.4.1 Area & Zoom Scan Procedure

First Area Scan is used to locate the approximate location(s) of the local peak SAR value(s). The measurement grid within an Area Scan is defined by the grid extent, grid step size and grid offset. Next, in order to determine the EM field distribution in a three-dimensional spatial extension, Zoom Scan is required. The Zoom Scan is performed around the highest E-field value to determine the averaged SAR-distribution over 10 g. According to KDB 865664 D01, the resolution for Area and Zoom scan is specified in the table below.

Items	<= 2 GHz	2-3 GHz	3-4 GHz	4-5 GHz	5-6 GHz
Area Scan ($\Delta x, \Delta y$)	<= 15 mm	<= 12 mm	<= 12 mm	<= 10 mm	<= 10 mm
Zoom Scan ($\Delta x, \Delta y$)	<= 8 mm	<= 5 mm	<= 5 mm	<= 4 mm	<= 4 mm
Zoom Scan (Δz)	<= 5 mm	<= 5 mm	<= 4 mm	<= 3 mm	<= 2 mm
Zoom Scan Volume	>= 30 mm	>= 30 mm	>= 28 mm	>= 25 mm	>= 22 mm

Note:

When zoom scan is required and report SAR is <= 1.4 W/kg, the zoom scan resolution of $\Delta x / \Delta y$ (2-3GHz: <= 8 mm, 3-4GHz: <= 7 mm, 4-6GHz: <= 5 mm) may be applied.

3.4.2 Volume Scan Procedure

The volume scan is used for assess overlapping SAR distributions for antennas transmitting in different frequency bands. It is equivalent to an oversized zoom scan used in standalone measurements. The measurement volume will be used to enclose all the simultaneous transmitting antennas. For antennas transmitting simultaneously in different frequency bands, the volume scan is measured separately in each frequency band. In order to sum correctly to compute the 1g aggregate SAR, the EUT remain in the same test position for all measurements and all volume scan use the same spatial resolution and grid spacing. When all volume scan were completed, the software, SEMCAD postprocessor can combine and subsequently superpose these measurement data to calculating the multiband SAR.

3.4.3 Power Drift Monitoring

All SAR testing is under the EUT install full charged battery and transmit maximum output power. In DASY measurement software, the power reference measurement and power drift measurement procedures are used for monitoring the power drift of EUT during SAR test. Both these procedures measure the field at a specified reference position before and after the SAR testing. The software will calculate the field difference in dB. If the power drift more than 5%, the SAR will be retested.

3.4.4 Spatial Peak SAR Evaluation

The procedure for spatial peak SAR evaluation has been implemented according to the test standard. It can be conducted for 1g and 10g, as well as for user-specific masses. The DASY software includes all numerical procedures necessary to evaluate the spatial peak SAR value.

The base for the evaluation is a "cube" measurement. The measured volume must include the 1g and 10g cubes with the highest averaged SAR values. For that purpose, the center of the measured volume is aligned to the interpolated peak SAR value of a previously performed area scan.

The entire evaluation of the spatial peak values is performed within the post-processing engine (SEMCAD). The system always gives the maximum values for the 1g and 10g cubes. The algorithm to find the cube with highest averaged SAR is divided into the following stages:

- (a) Extraction of the measured data (grid and values) from the Zoom Scan
- (b) Calculation of the SAR value at every measurement point based on all stored data (A/D values and measurement parameters)
- (c) Generation of a high-resolution mesh within the measured volume
- (d) Interpolation of all measured values from the measurement grid to the high-resolution grid
- (e) Extrapolation of the entire 3-D field distribution to the phantom surface over the distance from sensor to surface
- (f) Calculation of the averaged SAR within masses of 1g and 10g

3.4.5 SAR Averaged Methods

In DASY, the interpolation and extrapolation are both based on the modified Quadratic Shepard's method. The interpolation scheme combines a least-square fitted function method and a weighted average method which are the two basic types of computational interpolation and approximation.

Extrapolation routines are used to obtain SAR values between the lowest measurement points and the inner phantom surface. The extrapolation distance is determined by the surface detection distance and the probe sensor offset. The uncertainty increases with the extrapolation distance. To keep the uncertainty within 1% for the 1 g and 10 g cubes, the extrapolation distance should not be larger than 5 mm.

4. SAR Measurement Evaluation

4.1 EUT Configuration and Setting

<Considerations Related to Proximity Sensor>

The device supports WWAN, WLAN, and Bluetooth capabilities. It is designed with a proximity sensor which can trigger/not trigger power reduction for WCDMA and LTE on Top Side of EUT for SAR compliance. Others RF capability (WLAN and Bluetooth) have no power reduction. The power levels for all wireless technologies and the power reduction please refer to section 4.6 of this report.

Proximity Sensor Triggering Distances (KDB 616217 D04 §6.2)

The proximity sensor triggering distance was determined per KDB 616217 for rear face and applicable edge. Summary for power verification per distance was tabulated in the below table.

Output Power Verification in dBm for EUT Top Edge											
Distance (mm)	24	25	26	27	28	29	30	31	32	33	34
WCDMA II	19.4	19.5	19.3	19.5	19.4	19.6	23.3	23.5	23.2	23.1	23.1
WCDMA IV	18.5	18.5	18.2	18.5	18.3	18.5	22.8	22.6	22.8	22.5	22.6
WCDMA V	21.3	21.1	21.1	20.8	21.2	21.0	22.5	22.6	22.7	22.6	22.6
LTE 2	20.4	20.2	20.0	20.0	20.3	20.2	22.7	22.8	22.7	22.7	22.9
LTE 4	18.7	18.6	18.9	18.9	18.6	18.7	22.7	23.1	22.6	23.1	23.0
LTE 5	21.6	21.8	21.3	21.8	21.5	21.8	22.2	22.3	22.6	22.6	22.4
LTE 7	16.3	16.3	16.7	16.4	16.6	16.8	21.1	21.3	21.1	21.2	21.0
LTE 12	20.7	20.6	20.8	20.8	20.6	20.8	22.5	22.8	22.6	22.9	23.0
LTE 13	20.7	20.5	20.5	20.5	20.5	20.6	22.8	22.8	22.6	22.8	22.5
LTE 25	19.7	19.5	19.7	19.8	19.5	19.7	22.9	22.6	22.5	22.4	22.8
LTE 26	21.2	21.0	21.1	21.0	20.8	21.1	22.7	22.8	22.7	22.6	22.7
LTE 41	18.6	18.8	18.7	18.8	18.3	18.5	21.3	21.7	21.3	21.5	21.8

FCC SAR Test Report

Proximity Sensor Coverage (KDB 616217 D04 §6.3)

Since the proximity sensor is collocated with antenna in one component, the procedure for proximity sensor coverage is not required.

Proximity Sensor Tilt Angle Influences (KDB 616217 D04 §6.4)

The proximity sensor tilt angle influence was determined per KDB 616217 for applicable edge. Summary for proximity sensor tilt angle influence is shown in below.

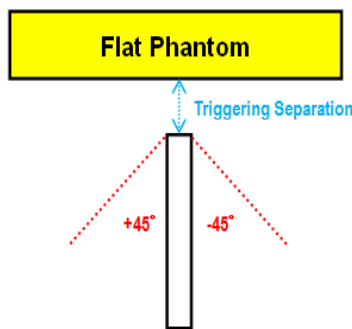

Orientation	Separation Distance (mm)	Tilt Angle										
		-45°	-40°	-30°	-20°	-10°	0°	10°	20°	30°	40°	45°
Top Edge	29	On	On	On	On	On	On	On	On	On	On	On

Summary for Proximity Sensor Triggering Test

According to the procedures noticed in KDB 616217 D04, the proximity sensor triggering distance is 30 mm for Top Side. The separation distance of 29 mm determined by the smallest triggering distance on Top Side is used to access the tilt angle influence and the sensor does not release during ± 45 degree. Therefore, the smallest separation distance for tilt angle influence is 12 mm for the Top Side.

The power reduction is depends on the proximity sensor input. For a steady SAR test, the power reduction was enabled or disabled manually by engineering software during SAR testing.

<Connections between EUT and System Simulator>

For WWAN SAR testing, the EUT was linked and controlled by base station emulator (Agilent E5515C is used for GSM/WCDMA/CDMA, and Anritsu MT8820C is used for LTE). Communication between the EUT and the emulator was established by air link. The distance between the EUT and the communicating antenna of the emulator is larger than 50 cm and the output power radiated from the emulator antenna is at least 30 dB smaller than the output power of EUT. The EUT was set from the emulator to radiate maximum output power during SAR testing.

<Considerations Related to WCDMA for Setup and Testing>

Handsets with Release 5 HSDPA

The 3G SAR test reduction procedure is applied to HSDPA body-worn configurations with 12.2 kbps RMC as the primary mode. Otherwise, SAR is measured for HSDPA using the HSDPA body SAR procedures in the “Release 5 HSDPA Data Devices”, for the highest reported SAR body-worn exposure configuration in 12.2 kbps RMC. Handsets with both HSDPA and HSUPA are tested according to Release 6 HSPA test procedures.

Handsets with Release 6 HSUPA

The 3G SAR test reduction procedure is applied to HSPA (HSUPA/HSDPA with RMC) body-worn configurations with 12.2 kbps RMC as the primary mode. Otherwise, SAR is measured for HSPA using the HSPA body SAR procedures in the “Release 6 HSPA Data Devices”, for the highest reported body-worn exposure SAR configuration in 12.2 kbps RMC. When VOIP is applicable for next to the ear head exposure in HSPA, the 3G SAR test reduction procedure is applied to HSPA with 12.2 kbps RMC as the primary mode; otherwise, the same HSPA configuration used for body-worn measurements is tested for next to the ear head exposure.

Release 5 HSDPA Data Devices

The 3G SAR test reduction procedure is applied to body SAR with 12.2 kbps RMC as the primary mode. Otherwise, body SAR for HSDPA is measured using an FRC with H-Set 1 in Sub-test 1 and a 12.2 kbps RMC configured in Test Loop Mode 1, for the highest reported SAR configuration in 12.2 kbps RMC without HSDPA. HSDPA is configured according to the applicable UE category of a test device. The number of HS-DSCH / HS-PDSCHs, HARQ processes, minimum inter-TTI interval, transport block sizes and RV coding sequence are defined by the H-set. To maintain a consistent test configuration and stable transmission conditions, QPSK is used in the H-set for SAR testing. HS-DPCCH should be configured with a CQI feedback cycle of 4 ms and a CQI repetition factor of 2 to maintain a constant rate of active CQI slots. DPCCH and DPDCH gain factors (β_c , β_d), and HS-DPCCH power offset parameters (Δ_{ACK} , Δ_{NACK} , Δ_{CQI}) are set according to values indicated in below. The CQI value is determined by the UE category, transport block size, number of HS-PDSCHs and modulation used in the H-set.

Sub-test	β_c	β_d	β_d (SF)	β_c / β_d	$\beta_{hs}^{(1)}$	CM (dB) ⁽²⁾	MPR
1	2 / 15	15 / 15	64	2 / 15	4 / 15	0.0	0
2	12 / 15 ⁽³⁾	15 / 15 ⁽³⁾	64	12 / 15 ⁽³⁾	24 / 15	1.0	0
3	15 / 15	8 / 15	64	15 / 8	30 / 15	1.5	0.5
4	15 / 15	4 / 15	64	15 / 4	30 / 15	1.5	0.5

Note 1: Δ_{ACK} , Δ_{NACK} and $\Delta_{CQI} = 8 \Leftrightarrow A_{hs} = \beta_{hs} / \beta_c = 30 / 15 \Leftrightarrow \beta_{hs} = 30 / 15 * \beta_c$.
Note 2: CM = 1 for $\beta_c / \beta_d = 12 / 15$, $\beta_{hs} / \beta_c = 24 / 15$.
Note 3: For subtest 2 the β_c / β_d ratio of 12 / 15 for the TFC during the measurement period (TF1, TF0) is achieved by setting the signaled gain factors for the reference TFC (TF1, TF1) to $\beta_c = 11 / 15$ and $\beta_d = 15 / 15$.

FCC SAR Test Report

Release 6 HSUPA Data Devices

The 3G SAR test reduction procedure is applied to body SAR with 12.2 kbps RMC as the primary mode. Otherwise, body SAR for HSPA is measured with E-DCH Sub-test 5, using H-Set 1 and QPSK for FRC and a 12.2 kbps RMC configured in Test Loop Mode 1 and power control algorithm 2, according to the highest reported body SAR configuration in 12.2 kbps RMC without HSPA. When VOIP applies to head exposure, the 3G SAR test reduction procedure is applied with 12.2 kbps RMC as the primary mode. Otherwise, the same HSPA configuration used for body SAR measurements are applied to head exposure testing. Due to inner loop power control requirements in HSPA, a communication test set is required for output power and SAR tests. The 12.2 kbps RMC, FRC H-set 1 and E-DCH configurations for HSPA are configured according to the β values indicated in below.

Sub-test	β_c	β_d	β_d (SF)	β_c / β_d	β_{hs} (1)	β_{ec}	β_{ed}	β_{ed} (SF)	β_{ed} (codes)	CM (2)	MPR (dB)	AG (4) Index	E-TFCI
1	11 / 15 (3)	15 / 15 (3)	64	11 / 15 (3)	22 / 15	209 / 225	1039 / 225	4	1	1.0	0.0	20	75
2	6 / 15	15 / 15	64	6 / 15	12 / 15	12 / 15	94 / 75	4	1	3.0	2.0	12	67
3	15 / 15	9 / 15	64	15 / 9	30 / 15	30 / 15	$\beta_{ed1}: 47/15$ $\beta_{ed2}: 47/15$	4	2	2.0	1.0	15	92
4	2 / 15	15 / 15	64	2 / 15	4 / 15	2 / 15	56 / 75	4	1	3.0	2.0	17	71
5	15 / 15 (4)	15 / 15 (4)	64	15 / 15 (4)	30 / 15	24 / 15	134 / 15	4	1	1.0	0.0	21	81

Note 1: $\Delta_{ACK}, \Delta_{NACK}$ and $\Delta_{CQI} = 8 \Leftrightarrow A_{hs} = \beta_{hs} / \beta_c = 30 / 15 \Leftrightarrow \beta_{hs} = 30 / 15 * \beta_c$
 Note 2: CM = 1 for $\beta_c / \beta_d = 12 / 15, \beta_{hs} / \beta_c = 24 / 15$. For all other combinations of DPDCH, DPCCH, HS-DPCCH, E-DPDCH and E-DPCCH the MPR is based on the relative CM difference.
 Note 3: For subtest 1 the β_c / β_d ratio of 11 / 15 for the TFC during the measurement period (TF1, TF0) is achieved by setting the signaled gain factors for the reference TFC (TF1, TF1) to $\beta_c = 10 / 15$ and $\beta_d = 15 / 15$.
 Note 4: For subtest 5 the β_c / β_d ratio of 15 / 15 for the TFC during the measurement period (TF1, TF0) is achieved by setting the signaled gain factors for the reference TFC (TF1, TF1) to $\beta_c = 14 / 15$ and $\beta_d = 15 / 15$.
 Note 5: Testing UE using E-DPDCH Physical Layer category 1 Sub-test 3 is not required according to TS 25.306 Table 5.1g.
 Note 6: β_{ed} cannot be set directly; it is set by Absolute Grant Value.

<Considerations Related to LTE for Setup and Testing>

This device contains LTE transmitter which follows 3GPP standards, is category 3, supports both QPSK and 16QAM modulations, and supported LTE band and channel bandwidth is listed in below. The output power was tested per 3GPP TS 36.521-1 maximum transmit procedures for both QPSK and 16QAM modulation. The results please refer to section 4.6 of this report.

EUT Supported LTE Band and Channel Bandwidth						
LTE Band	BW 1.4 MHz	BW 3 MHz	BW 5 MHz	BW 10 MHz	BW 15 MHz	BW 20 MHz
2	V	V	V	V	V	V
4	V	V	V	V	V	V
5	V	V	V	V		
7			V	V	V	V
12	V	V	V	V		
13			V	V		
25	V	V	V	V	V	V
26	V	V	V	V	V	
41			V	V	V	V

The LTE maximum power reduction (MPR) in accordance with 3GPP TS 36.101 is active all times during LTE operation. The allowed MPR for the maximum output power is specified in below.

FCC SAR Test Report

Modulation	Channel Bandwidth / RB Configurations						LTE MPR Setting (dB)
	BW 1.4 MHz	BW 3 MHz	BW 5 MHz	BW 10 MHz	BW 15 MHz	BW 20 MHz	
QPSK	> 5	> 4	> 8	> 12	> 16	> 18	1
16QAM	<= 5	<= 4	<= 8	<= 12	<= 16	<= 18	1
16QAM	> 5	> 4	> 8	> 12	> 16	> 18	2

Note: MPR is according to the standard and implemented in the circuit (mandatory).

In addition, the device is compliant with additional maximum power reduction (A-MPR) requirements defined in 3GPP TS 36.101 section 6.2.4 that was disabled for all FCC compliance testing.

During LTE SAR testing, the related parameters of operating band, channel bandwidth, uplink channel number, modulation type, and RB was set in base station simulator. When the EUT has registered and communicated to base station simulator, the simulator set to make EUT transmitting the maximum radiated power.

TDD-LTE Setup Configurations

According to KDB 941225 D05, SAR testing for TDD-LTE device must be tested using a fixed periodic duty factor according to the highest transmission duty factor implemented for the device and supported by the defined 3GPP TDD-LTE configurations. The TDD-LTE of this device supports frame structure type 2 defined in 3GPP TS 36.211 section 4.2, and the frame structure configuration can be referred to below.

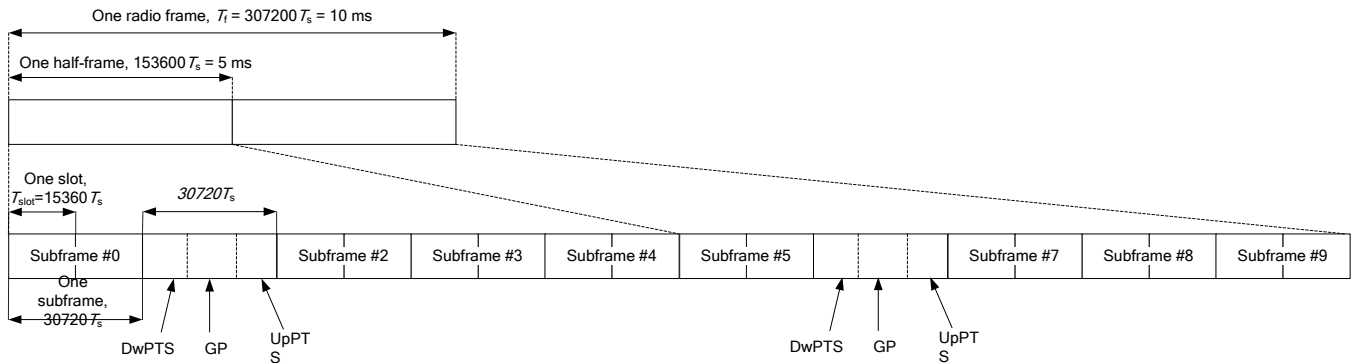

3GPP TS 36.211 Figure 4.2-1: Frame Structure Type 2

Special Subframe Configuration	Normal Cyclic Prefix in Downlink			Extended Cyclic Prefix in Downlink		
	DwPTS	UpPTS		DwPTS	UpPTS	
		Normal Cyclic Prefix in Uplink	Extended Cyclic Prefix in Uplink		Normal Cyclic Prefix in Uplink	Extended Cyclic Prefix in Uplink
0	6592 · Ts	2192 · Ts	2560 · Ts	7680 · Ts	2192 · Ts	2560 · Ts
1	19760 · Ts			20480 · Ts		
2	21952 · Ts			23040 · Ts		
3	24144 · Ts			25600 · Ts		
4	26336 · Ts	4384 · Ts	5120 · Ts	7680 · Ts	4384 · Ts	5120 · Ts
5	6592 · Ts			20480 · Ts		
6	19760 · Ts			23040 · Ts		
7	21952 · Ts	-	-	12800 · Ts	-	-
8	24144 · Ts					
9	13168 · Ts	-	-	-	-	-

3GPP TS 36.211 Table 4.2-1: Configuration of Special Subframe

Uplink-Downlink Configuration	Downlink-to-Uplink Switch-Point Periodicity	Subframe Number									
		0	1	2	3	4	5	6	7	8	9
0	5 ms	D	S	U	U	U	D	S	U	U	U
1	5 ms	D	S	U	U	D	D	S	U	U	D
2	5 ms	D	S	U	D	D	D	S	U	D	D
3	10 ms	D	S	U	U	U	D	D	D	D	D
4	10 ms	D	S	U	U	D	D	D	D	D	D
5	10 ms	D	S	U	D	D	D	D	D	D	D
6	5 ms	D	S	U	U	U	D	S	U	U	D

3GPP TS 36.211 Table 4.2-2: Uplink-Downlink Configurations

The variety of different TD-LTE uplink-downlink configurations allows a network operator to allocate the network's capacity between uplink and downlink traffic to meet the needs of the network. The uplink duty cycle of these seven configurations can readily be computed and shown in below.

UL-DL Configuration	0	1	2	3	4	5	6
Highest Duty-Cycle	63.33%	43.33%	23.33%	31.67%	21.67%	11.67%	53.33%

Considering the highest transmission duty cycle, TDD-LTE was tested using Uplink-Downlink Configuration 0 with 6 uplink subframe and 2 special subframe. The special subframe was set to special subframe configuration 7 using extended cyclic prefix uplink. Therefore, SAR testing for TDD-LTE was performed at the maximum output power with highest transmission duty cycle of 63.33%.

<Considerations Related to WLAN for Setup and Testing>

In general, various vendor specific external test software and chipset based internal test modes are typically used for SAR measurement. These chipset based test mode utilities are generally hardware and manufacturer dependent, and often include substantial flexibility to reconfigure or reprogram a device. A Wi-Fi device must be configured to transmit continuously at the required data rate, channel bandwidth and signal modulation, using the highest transmission duty factor supported by the test mode tools for SAR measurement. The test frequencies established using test mode must correspond to the actual channel frequencies. When 802.11 frame gaps are accounted for in the transmission, a maximum transmission duty factor of 92 - 96% is typically achievable in most test mode configurations. A minimum transmission duty factor of 85% is required to avoid certain hardware and device implementation issues related to wide range SAR scaling. In addition, a periodic transmission duty factor is required for current generation SAR systems to measure SAR correctly. The reported SAR must be scaled to 100% transmission duty factor to determine compliance at the maximum tune-up tolerance limit.

According to KDB 248227 D01, this device has installed WLAN engineering testing software which can provide continuous transmitting RF signal. During WLAN SAR testing, this device was operated to transmit continuously at the maximum transmission duty with specified transmission mode, operating frequency, lowest data rate, and maximum output power.

Initial Test Configuration

An initial test configuration is determined for OFDM transmission modes in 2.4 GHz and 5 GHz bands according to the channel bandwidth, modulation and data rate combination(s) with the highest maximum output power specified for production units in each standalone and aggregated frequency band. When the same maximum power is specified for multiple transmission modes in a frequency band, the largest channel bandwidth, lowest order modulation, lowest data rate and lowest order 802.11a/g/n/ac mode is used for SAR measurement, on the highest measured output power channel in the initial test configuration, for each frequency band.

Subsequent Test Configuration

SAR measurement requirements for the remaining 802.11 transmission mode configurations that have not been tested in the initial test configuration are determined separately for each standalone and aggregated frequency band, in each exposure condition, according to the maximum output power specified for production units. Additional power measurements may be required to determine if SAR measurements are required for subsequent highest output power channels in a subsequent test configuration. When the highest reported SAR for the initial test configuration according to the initial test position or fixed exposure position requirements, is adjusted by the ratio of the subsequent test configuration to initial test configuration specified maximum output power and the adjusted SAR is ≤ 1.2 W/kg, SAR is not required for that subsequent test configuration.

SAR Test Configuration and Channel Selection

When multiple channel bandwidth configurations in a frequency band have the same specified maximum output power, the initial test configuration is using largest channel bandwidth, lowest order modulation, lowest data rate, and lowest order 802.11 mode (i.e., 802.11a is chosen over 802.11n then 802.11ac or 802.11g is chosen over 802.11n). After an initial test configuration is determined, if multiple test channels have the same measured maximum output power, the channel chosen for SAR measurement is determined according to the following.

- 1) The channel closest to mid-band frequency is selected for SAR measurement.
- 2) For channels with equal separation from mid-band frequency; for example, high and low channels or two mid-band channels, the higher frequency (number) channel is selected for SAR measurement.

Test Reduction for U-NII-1 (5.2 GHz) and U-NII-2A (5.3 GHz) Bands

For devices that operate in both U-NII bands using the same transmitter and antenna(s), SAR test reduction is determined according to the following.

- 1) When the same maximum output power is specified for both bands, begin SAR measurement in U-NII-2A band by applying the OFDM SAR requirements. If the highest reported SAR for a test configuration is ≤ 1.2 W/kg, SAR is not required for U-NII-1 band for that configuration (802.11 mode and exposure condition).
- 2) When different maximum output power is specified for the bands, begin SAR measurement in the band with higher specified maximum output power. The highest reported SAR for the tested configuration is adjusted by the ratio of lower to higher specified maximum output power for the two bands. When the adjusted SAR is ≤ 1.2 W/kg, SAR is not required for the band with lower maximum output power in that test configuration.

<Considerations Related to Bluetooth for Setup and Testing>

This device has installed Bluetooth engineering testing software which can provide continuous transmitting RF signal. During Bluetooth SAR testing, this device was operated to transmit continuously at the maximum transmission duty with specified transmission mode, operating frequency, lowest data rate, and maximum output power.

4.2 EUT Testing Position

4.2.1 Body Exposure Conditions

For laptop PC, according to KDB 616217 D04, SAR evaluation is required for the bottom surface of the keyboard. This EUT was tested in the base of EUT directly against the flat phantom. The required minimum test separation distance for incorporating transmitters and antennas into laptop computer display is determined with the display screen opened at an angle of 90° to the keyboard compartment.

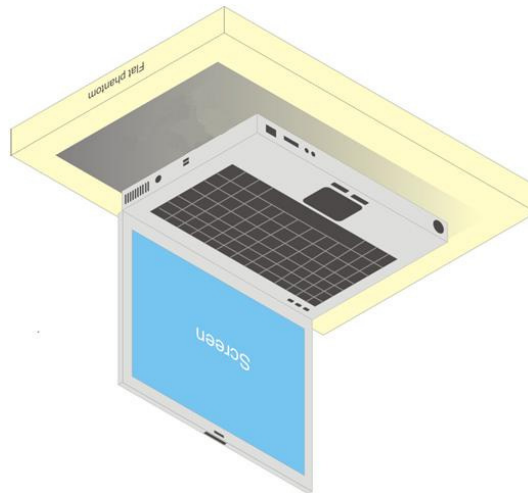

Fig-4.1 Illustration for Laptop Setup

FCC SAR Test Report

For full-size tablet, according to KDB 616217 D04, SAR evaluation is required for back surface and edges of the devices. The back surface and edges of the tablet are tested with the tablet touching the phantom. Exposures from antennas through the front surface of the display section of a tablet are generally limited to the user's hands. Exposures to hands for typical consumer transmitters used in tablets are not expected to exceed the extremity SAR limit; therefore, SAR evaluation for the front surface of tablet display screens are generally not necessary. When voice mode is supported on a tablet and it is limited to speaker mode or headset operations only, additional SAR testing for this type of voice use is not required.

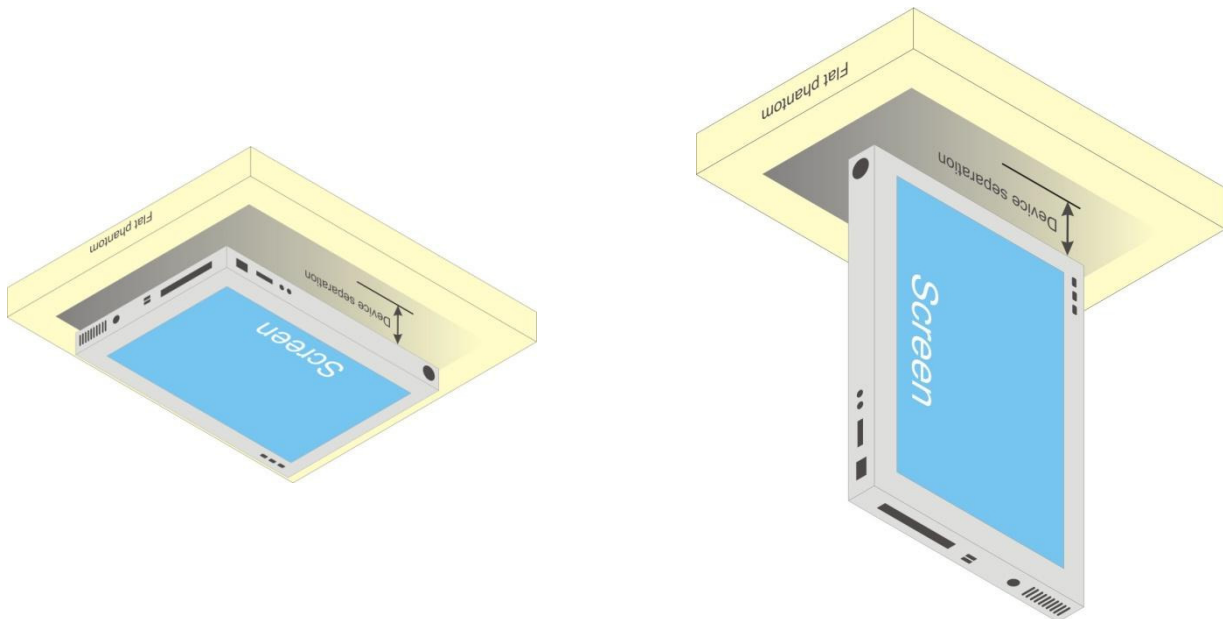

Fig-4.2 Illustration for Tablet Setup

4.2.2 SAR Test Exclusion Evaluations

According to KDB 447498 D01, the SAR test exclusion condition is based on source-based time-averaged maximum conducted output power, adjusted for tune-up tolerance, and the minimum test separation distance required for the exposure conditions. The SAR exclusion threshold is determined by the following formula.

- For the test separation distance ≤ 50 mm

$$\frac{\text{Max. Tune up Power}_{(mW)}}{\text{Min. Test Separation Distance}_{(mm)}} \times \sqrt{f_{(GHz)}} \leq 3.0 \text{ for SAR-1g, } \leq 7.5 \text{ for SAR-10g}$$

When the minimum test separation distance is < 5 mm, a distance of 5 mm is applied to determine SAR test exclusion.

- For the test separation distance > 50 mm, and the frequency at 100 MHz to 1500 MHz

$$\left[(\text{Threshold at 50 mm in Step 1}) + (\text{Test Separation Distance} - 50 \text{ mm}) \times \left(\frac{f_{(MHz)}}{150} \right) \right]_{(mW)}$$

- For the test separation distance > 50 mm, and the frequency at > 1500 MHz to 6 GHz

$$[(\text{Threshold at 50 mm in Step 1}) + (\text{Test Separation Distance} - 50 \text{ mm}) \times 10]_{(mW)}$$

WWAN (EM7455)

Mode	Max. Tune-up Power (dBm)	Max. Tune-up Power (mW)	Rear Face			Left Side			Right Side			Top Side			Bottom Side		
			Ant. to Surface (mm)	Power Threshold (mW)	Require SAR Testing?	Ant. to Surface (mm)	Power Threshold (mW)	Require SAR Testing?	Ant. to Surface (mm)	Power Threshold (mW)	Require SAR Testing?	Ant. to Surface (mm)	Power Threshold (mW)	Require SAR Testing?	Ant. to Surface (mm)	Power Threshold (mW)	Require SAR Testing?
WCDMA II	24.0	251.19	16.48	21.1	Yes	183	1439 mW	No	6.9	50.3	Yes	3	69.4	Yes	194.5	1554 mW	No
WCDMA IV	24.0	251.19	16.48	20.2	Yes	183	1443 mW	No	6.9	48.2	Yes	3	66.5	Yes	194.5	1558 mW	No
WCDMA V	24.0	251.19	16.48	14	Yes	183	914 mW	No	6.9	33.5	Yes	3	46.2	Yes	194.5	979 mW	No
LTE 2	24.0	251.19	16.48	21.1	Yes	183	1439 mW	No	6.9	50.3	Yes	3	69.4	Yes	194.5	1554 mW	No
LTE 4	24.0	251.19	16.48	20.2	Yes	183	1443 mW	No	6.9	48.2	Yes	3	66.5	Yes	194.5	1558 mW	No
LTE 5	24.0	251.19	16.48	14	Yes	183	914 mW	No	6.9	33.5	Yes	3	46.2	Yes	194.5	980 mW	No
LTE 7	23.0	199.53	16.48	19.4	Yes	183	1424 mW	No	6.9	46.3	Yes	3	63.8	Yes	194.5	1539 mW	No
LTE 12	24.0	251.19	16.48	12.9	Yes	183	811 mW	No	6.9	30.8	Yes	3	42.5	Yes	194.5	866 mW	No
LTE 13	24.0	251.19	16.48	13.5	Yes	183	865 mW	No	6.9	32.3	Yes	3	44.5	Yes	194.5	925 mW	No
LTE 25	24.0	251.19	16.48	21.1	Yes	183	1438 mW	No	6.9	50.4	Yes	3	69.5	Yes	194.5	1553 mW	No
LTE 26	24.0	251.19	16.48	14	Yes	183	916 mW	No	6.9	33.5	Yes	3	46.3	Yes	194.5	980 mW	No
LTE 41	23.0	199.53	16.48	19.9	Yes	183	1421 mW	No	6.9	47.4	Yes	3	65.5	Yes	194.5	1537 mW	No

FCC SAR Test Report

WLAN (QCNFA344A)

<For WLAN Ant-0>

Mode	Max. Tune-up Power (dBm)	Max. Tune-up Power (mW)	Rear Face			Left Side			Right Side			Top Side			Bottom Side		
			Ant. to Surface (mm)	Power Threshold (mW)	Require SAR Testing?	Ant. to Surface (mm)	Power Threshold (mW)	Require SAR Testing?	Ant. to Surface (mm)	Power Threshold (mW)	Require SAR Testing?	Ant. to Surface (mm)	Power Threshold (mW)	Require SAR Testing?	Ant. to Surface (mm)	Power Threshold (mW)	Require SAR Testing?
WLAN 2.4G	12.0	15.85	16.48	2	No	6.9	3.60	Yes	258.4	2180 mW	No	3	4.97	Yes	194.5	1541 mW	No
WLAN 5.2G	10.5	11.22	16.48	2	No	6.9	3.70	Yes	258.4	2150 mW	No	3	5.14	Yes	194.5	1511 mW	No
WLAN 5.3G	10.5	11.22	16.48	2	No	6.9	3.80	Yes	258.4	2149 mW	No	3	5.18	Yes	194.5	1510 mW	No
WLAN 5.6G	10.5	11.22	16.48	2	No	6.9	3.90	Yes	258.4	2147 mW	No	3	5.36	Yes	194.5	1508 mW	No
WLAN 5.8G	10.5	11.22	16.48	2	No	6.9	3.90	Yes	258.4	2146 mW	No	3	5.42	Yes	194.5	1507 mW	No

<For WLAN Ant-1/BT>

Mode	Max. Tune-up Power (dBm)	Max. Tune-up Power (mW)	Rear Face			Left Side			Right Side			Top Side			Bottom Side		
			Ant. to Surface (mm)	Power Threshold (mW)	Require SAR Testing?	Ant. to Surface (mm)	Power Threshold (mW)	Require SAR Testing?	Ant. to Surface (mm)	Power Threshold (mW)	Require SAR Testing?	Ant. to Surface (mm)	Power Threshold (mW)	Require SAR Testing?	Ant. to Surface (mm)	Power Threshold (mW)	Require SAR Testing?
WLAN 2.4G	12	15.85	16.48	2	No	63.9	235 mW	No	200.9	1605 mW	No	196.5	1561 mW	No	4	4.97	Yes
WLAN 5.2G	10.5	11.22	16.48	2	No	63.9	205 mW	No	200.9	1575 mW	No	196.5	1531 mW	No	4	5.14	Yes
WLAN 5.3G	10.5	11.22	16.48	2	No	63.9	204 mW	No	200.9	1574 mW	No	196.5	1530 mW	No	4	5.18	Yes
WLAN 5.6G	10.5	11.22	16.48	2	No	63.9	202 mW	No	200.9	1572 mW	No	196.5	1528 mW	No	4	5.36	Yes
WLAN 5.8G	10.5	11.22	16.48	2	No	63.9	201 mW	No	200.9	1571 mW	No	196.5	1527 mW	No	4	5.42	Yes
BT	7.0	5.01	16.48	1	No	63.9	234 mW	No	200.9	1604 mW	No	196.5	1560 mW	No	4	1.58	No

<For WLAN Ant-0 + Ant-1>

Mode	Max. Tune-up Power (dBm)	Max. Tune-up Power (mW)	Rear Face			Left Side			Right Side			Top Side			Bottom Side		
			Ant. to Surface (mm)	Power Threshold (mW)	Require SAR Testing?	Ant. to Surface (mm)	Power Threshold (mW)	Require SAR Testing?	Ant. to Surface (mm)	Power Threshold (mW)	Require SAR Testing?	Ant. to Surface (mm)	Power Threshold (mW)	Require SAR Testing?	Ant. to Surface (mm)	Power Threshold (mW)	Require SAR Testing?
WLAN 2.4G	15.0	31.62	16.48	3	No	6.9	7.20	Yes	200.9	1605 mW	No	3	9.92	Yes	4	9.92	Yes
WLAN 5.2G	13.5	22.39	16.48	3	Yes	6.9	7.40	Yes	200.9	1575 mW	No	3	10.25	Yes	4	10.25	Yes
WLAN 5.3G	13.5	22.39	16.48	3	Yes	6.9	7.50	Yes	200.9	1574 mW	No	3	10.33	Yes	4	10.33	Yes
WLAN 5.6G	13.5	22.39	16.48	3	Yes	6.9	7.70	Yes	200.9	1572 mW	No	3	10.69	Yes	4	10.69	Yes
WLAN 5.8G	13.5	22.39	16.48	3	Yes	6.9	7.80	Yes	200.9	1571 mW	No	3	10.81	Yes	4	10.81	Yes

Note:

1. When separation distance ≤ 50 mm and the calculated result shown in above table is ≤ 3.0 for SAR-1g exposure condition, or ≤ 7.5 for SAR-10g exposure condition, the SAR testing exclusion is applied.
2. When separation distance > 50 mm and the device output power is less than the calculated result (power threshold, mW) shown in above table, the SAR testing exclusion is applied.

FCC SAR Test Report

4.2.3 Simultaneous Transmission Possibilities

The simultaneous transmission possibilities for this device are listed as below.

WWAN (EM7455) + WLAN (QCNFA344A)

Simultaneous TX Combination	Capable Transmit Configurations	Body Exposure Condition
1	WCDMA II (Data) + WLAN (Data)	Yes
2	WCDMA IV (Data) + WLAN (Data)	Yes
3	WCDMA V (Data) + WLAN (Data)	Yes
4	LTE 2 (Data) + WLAN (Data)	Yes
5	LTE 4 (Data) + WLAN (Data)	Yes
6	LTE 5 (Data) + WLAN (Data)	Yes
7	LTE 7 (Data) + WLAN (Data)	Yes
8	LTE 12 (Data) + WLAN (Data)	Yes
9	LTE 13 (Data) + WLAN (Data)	Yes
10	LTE 25 (Data) + WLAN (Data)	Yes
11	LTE 26 (Data) + WLAN (Data)	Yes
12	LTE 41 (Data) + WLAN (Data)	Yes
13	WCDMA II (Data) + BT (Data)	Yes
14	WCDMA IV (Data) + BT (Data)	Yes
15	WCDMA V (Data) + BT (Data)	Yes
16	LTE 2 (Data) + BT (Data)	Yes
17	LTE 4 (Data) + BT (Data)	Yes
18	LTE 5 (Data) + BT (Data)	Yes
19	LTE 7 (Data) + BT (Data)	Yes
20	LTE 12 (Data) + BT (Data)	Yes
21	LTE 13 (Data) + BT (Data)	Yes
22	LTE 25 (Data) + BT (Data)	Yes
23	LTE 26 (Data) + BT (Data)	Yes
24	LTE 41 (Data) + BT (Data)	Yes
25	WCDMA II (Data) + WLAN (Data) + BT (Data)	Yes
26	WCDMA IV (Data) + WLAN (Data) + BT (Data)	Yes
27	WCDMA V (Data) + WLAN (Data) + BT (Data)	Yes
28	LTE 2 (Data) + WLAN (Data) + BT (Data)	Yes
29	LTE 4 (Data) + WLAN (Data) + BT (Data)	Yes
30	LTE 5 (Data) + WLAN (Data) + BT (Data)	Yes
31	LTE 7 (Data) + WLAN (Data) + BT (Data)	Yes
32	LTE 12 (Data) + WLAN (Data) + BT (Data)	Yes
33	LTE 13 (Data) + WLAN (Data) + BT (Data)	Yes
34	LTE 25 (Data) + WLAN (Data) + BT (Data)	Yes
35	LTE 26 (Data) + WLAN (Data) + BT (Data)	Yes
36	LTE 41 (Data) + WLAN (Data) + BT (Data)	Yes

Note :

1. The 2.4G WLAN and 5G WLAN cannot transmit simultaneously.

FCC SAR Test Report

WWAN (EM7455) + WLAN (8265NGW)

Simultaneous TX Combination	Capable Transmit Configurations	Body Exposure Condition
1	WCDMA II (Data) + WLAN Ant 0 (Data) + WLAN Ant 1 (Data)	Yes
2	WCDMA IV (Data) + WLAN Ant 0 (Data) + WLAN Ant 1 (Data)	Yes
3	WCDMA V (Data) + WLAN Ant 0 (Data) + WLAN Ant 1 (Data)	Yes
4	LTE 2 (Data) + WLAN Ant 0 (Data) + WLAN Ant 1 (Data)	Yes
5	LTE 4 (Data) + WLAN Ant 0 (Data) + WLAN Ant 1 (Data)	Yes
6	LTE 5 (Data) + WLAN Ant 0 (Data) + WLAN Ant 1 (Data)	Yes
7	LTE 7 (Data) + WLAN Ant 0 (Data) + WLAN Ant 1 (Data)	Yes
8	LTE 12 (Data) + WLAN Ant 0 (Data) + WLAN Ant 1 (Data)	Yes
9	LTE 13 (Data) + WLAN Ant 0 (Data) + WLAN Ant 1 (Data)	Yes
10	LTE 25 (Data) + WLAN Ant 0 (Data) + WLAN Ant 1 (Data)	Yes
11	LTE 26 (Data) + WLAN Ant 0 (Data) + WLAN Ant 1 (Data)	Yes
12	LTE 41 (Data) + WLAN Ant 0 (Data) + WLAN Ant 1 (Data)	Yes
13	WCDMA II (Data) + WLAN Ant 0 (Data) + BT Ant 1 (Data)	Yes
14	WCDMA IV (Data) + WLAN Ant 0 (Data) + BT Ant 1 (Data)	Yes
15	WCDMA V (Data) + WLAN Ant 0 (Data) + BT Ant 1 (Data)	Yes
16	LTE 2 (Data) + WLAN Ant 0 (Data) + BT Ant 1 (Data)	Yes
17	LTE 4 (Data) + WLAN Ant 0 (Data) + BT Ant 1 (Data)	Yes
18	LTE 5 (Data) + WLAN Ant 0 (Data) + BT Ant 1 (Data)	Yes
19	LTE 7 (Data) + WLAN Ant 0 (Data) + BT Ant 1 (Data)	Yes
20	LTE 12 (Data) + WLAN Ant 0 (Data) + BT Ant 1 (Data)	Yes
21	LTE 13 (Data) + WLAN Ant 0 (Data) + BT Ant 1 (Data)	Yes
22	LTE 25 (Data) + WLAN Ant 0 (Data) + BT Ant 1 (Data)	Yes
23	LTE 26 (Data) + WLAN Ant 0 (Data) + BT Ant 1 (Data)	Yes
24	LTE 41 (Data) + WLAN Ant 0 (Data) + BT Ant 1 (Data)	Yes

Note :

1. The 2.4G WLAN and 5G WLAN cannot transmit simultaneously.

4.3 Tissue Verification

The measuring results for tissue simulating liquid are shown as below.

WWAN (EM7455)

Test Date	Tissue Type	Frequency (MHz)	Liquid Temp. (°C)	Measured Conductivity (σ)	Measured Permittivity (ε _r)	Target Conductivity (σ)	Target Permittivity (ε _r)	Conductivity Deviation (%)	Permittivity Deviation (%)
Nov. 18, 2016	Body	750	23.4	0.967	56.100	0.96	55.5	0.73	1.08
Dec. 09, 2016	Body	750	23.5	0.959	54.477	0.96	55.5	-0.10	-1.84
Fbe. 14, 2017	Body	750	23.3	0.960	56.423	0.96	55.5	0.00	1.66
Dec. 05, 2016	Body	835	23.5	0.985	53.035	0.97	55.2	1.55	-3.92
Dec. 09, 2016	Body	835	23.5	1.015	56.103	0.97	55.2	4.64	1.64
Nov. 16, 2016	Body	1750	23.6	1.443	53.336	1.49	53.4	-3.15	-0.12
Dec. 02, 2016	Body	1750	23.6	1.449	51.673	1.49	53.4	-2.75	-3.23
Dec. 08, 2016	Body	1750	23.5	1.433	51.529	1.49	53.4	-3.83	-3.50
Dec. 09, 2016	Body	1750	23.5	1.451	51.707	1.49	53.4	-2.62	-3.17
Dec. 14, 2016	Body	1750	23.5	1.447	52.512	1.49	53.4	-2.89	-1.66
Fbe. 13, 2017	Body	1750	23.1	1.440	51.715	1.49	53.4	-3.36	-3.16
Dec. 02, 2016	Body	1900	23.6	1.564	51.374	1.52	53.3	2.89	-3.61
Dec. 06, 2016	Body	1900	23.5	1.539	51.528	1.52	53.3	1.25	-3.32
Dec. 08, 2016	Body	1900	23.5	1.572	51.094	1.52	53.3	3.42	-4.14
Fbe. 13, 2017	Body	1900	23.2	1.554	51.475	1.52	53.3	2.24	-3.42
Dec. 09, 2016	Body	2600	23.5	2.173	50.236	2.16	52.5	0.60	-4.31
Dec. 14, 2016	Body	2600	23.5	2.226	53.274	2.16	52.5	3.06	1.47
Dec. 14, 2016	Body	2600	23.5	2.209	51.172	2.16	52.5	2.27	-2.53
Fbe. 13, 2017	Body	2600	23.2	2.173	50.236	2.16	52.5	0.60	-4.31

WLAN (QCNFA344A)

Test Date	Tissue Type	Frequency (MHz)	Liquid Temp. (°C)	Measured Conductivity (σ)	Measured Permittivity (ε _r)	Target Conductivity (σ)	Target Permittivity (ε _r)	Conductivity Deviation (%)	Permittivity Deviation (%)
Nov. 17, 2016	Body	2450	23.5	2.024	50.672	1.95	52.7	3.79	-3.85
Dec. 12, 2016	Body	2450	23.5	2.044	53.606	1.95	52.7	4.82	1.72
Feb. 24, 2017	Body	2450	23.5	2.024	50.609	1.95	52.7	3.79	-3.97
Nov. 17, 2016	Body	5250	23.3	5.537	46.921	5.36	48.9	3.30	-4.05
Dec. 13, 2016	Body	5250	23.5	5.357	48.606	5.36	48.9	-0.06	-0.60
Feb. 24, 2017	Body	5250	23.5	5.405	47.547	5.36	48.9	0.84	-2.77
Dec. 13, 2016	Body	5600	23.5	5.792	48.099	5.77	48.5	0.38	-0.83
Dec. 22, 2016	Body	5600	23.5	5.894	46.750	5.77	48.5	2.15	-3.61
Feb. 24, 2017	Body	5600	23.5	5.894	46.817	5.77	48.5	2.15	-3.47
Dec. 13, 2016	Body	5800	23.5	6.245	48.363	6.00	48.2	4.08	0.34
Dec. 22, 2016	Body	5800	23.5	6.171	46.415	6.00	48.2	2.85	-3.70
Feb. 24, 2017	Body	5800	23.5	6.172	46.486	6.00	48.2	2.87	-3.56

FCC SAR Test Report

WLAN (8265NGW)

Test Date	Tissue Type	Frequency (MHz)	Liquid Temp. (°C)	Measured Conductivity (σ)	Measured Permittivity (ϵ_r)	Target Conductivity (σ)	Target Permittivity (ϵ_r)	Conductivity Deviation (%)	Permittivity Deviation (%)
Jan. 04, 2017	Body	2450	23.5	2.029	51.700	1.95	52.7	4.05	-1.90
Jan. 04, 2017	Body	5250	23.3	5.357	48.606	5.36	48.9	-0.06	-0.60
Jan. 04, 2017	Body	5600	23.3	5.792	48.099	5.77	48.5	0.38	-0.83
Jan. 04, 2017	Body	5800	23.3	6.245	48.363	6.00	48.2	4.08	0.34

Note:

The dielectric properties of the tissue simulating liquid must be measured within 24 hours before the SAR testing and within $\pm 5\%$ of the target values. Liquid temperature during the SAR testing must be within ± 2 °C.

FCC SAR Test Report

4.4 System Validation

The SAR measurement system was validated according to procedures in KDB 865664 D01. The validation status in tabulated summary is as below.

WWAN (EM7455)

Test Date	Probe S/N	Calibration Point		Measured Conductivity (σ)	Measured Permittivity (ϵ_r)	Validation for CW			Validation for Modulation		
						Sensitivity Range	Probe Linearity	Probe Isotropy	Modulation Type	Duty Factor	PAR
Nov. 18, 2016	7350	Body	750	0.967	56.100	Pass	Pass	Pass	N/A	N/A	N/A
Dec. 09, 2016	1790	Body	750	0.959	54.477	Pass	Pass	Pass	N/A	N/A	N/A
Fbe. 14, 2017	3820	Body	750	0.960	56.423	Pass	Pass	Pass	N/A	N/A	N/A
Dec. 05, 2016	1790	Body	835	0.985	53.035	Pass	Pass	Pass	N/A	N/A	N/A
Dec. 09, 2016	1790	Body	835	1.015	56.103	Pass	Pass	Pass	N/A	N/A	N/A
Nov. 16, 2016	7350	Body	1750	1.443	53.336	Pass	Pass	Pass	N/A	N/A	N/A
Dec. 02, 2016	1790	Body	1750	1.449	51.673	Pass	Pass	Pass	N/A	N/A	N/A
Dec. 08, 2016	1790	Body	1750	1.433	51.529	Pass	Pass	Pass	N/A	N/A	N/A
Dec. 09, 2016	3971	Body	1750	1.451	51.707	Pass	Pass	Pass	N/A	N/A	N/A
Dec. 14, 2016	1790	Body	1750	1.447	52.512	Pass	Pass	Pass	N/A	N/A	N/A
Fbe. 13, 2017	3820	Body	1750	1.440	51.715	Pass	Pass	Pass	N/A	N/A	N/A
Dec. 02, 2016	1790	Body	1900	1.564	51.374	Pass	Pass	Pass	N/A	N/A	N/A
Dec. 06, 2016	3971	Body	1900	1.539	51.528	Pass	Pass	Pass	N/A	N/A	N/A
Dec. 08, 2016	1790	Body	1900	1.572	51.094	Pass	Pass	Pass	N/A	N/A	N/A
Fbe. 13, 2017	3820	Body	1900	1.554	51.475	Pass	Pass	Pass	N/A	N/A	N/A
Dec. 09, 2016	3971	Body	2600	2.173	50.236	Pass	Pass	Pass	OFDM	N/A	Pass
Dec. 14, 2016	3971	Body	2600	2.226	53.274	Pass	Pass	Pass	OFDM	N/A	Pass
Dec. 14, 2016	3971	Body	2600	2.209	51.172	Pass	Pass	Pass	OFDM	N/A	Pass
Fbe. 13, 2017	3820	Body	2600	2.173	50.236	Pass	Pass	Pass	N/A	N/A	N/A

WLAN (QCNFA344A)

Test Date	Probe S/N	Calibration Point		Measured Conductivity (σ)	Measured Permittivity (ϵ_r)	Validation for CW			Validation for Modulation		
						Sensitivity Range	Probe Linearity	Probe Isotropy	Modulation Type	Duty Factor	PAR
Nov. 17, 2016	7350	Body	2450	2.024	50.672	Pass	Pass	Pass	OFDM	N/A	Pass
Dec. 12, 2016	3971	Body	2450	2.044	53.606	Pass	Pass	Pass	OFDM	N/A	Pass
Feb. 24, 2017	3971	Body	2450	2.024	50.609	Pass	Pass	Pass	OFDM	N/A	Pass
Nov. 17, 2016	7350	Body	5250	5.537	46.921	Pass	Pass	Pass	OFDM	N/A	Pass
Dec. 13, 2016	3971	Body	5250	5.357	48.606	Pass	Pass	Pass	OFDM	N/A	Pass
Feb. 24, 2017	3971	Body	5250	5.405	47.547	Pass	Pass	Pass	OFDM	N/A	Pass
Dec. 13, 2016	3971	Body	5600	5.792	48.099	Pass	Pass	Pass	OFDM	N/A	Pass
Dec. 13, 2016	3650	Body	5600	5.894	46.750	Pass	Pass	Pass	OFDM	N/A	Pass
Feb. 24, 2017	3971	Body	5600	5.894	46.817	Pass	Pass	Pass	OFDM	N/A	Pass
Dec. 13, 2016	3971	Body	5800	6.245	48.363	Pass	Pass	Pass	OFDM	N/A	Pass
Dec. 13, 2016	3650	Body	5800	6.171	46.415	Pass	Pass	Pass	OFDM	N/A	Pass
Feb. 24, 2017	3971	Body	5800	6.172	46.486	Pass	Pass	Pass	OFDM	N/A	Pass

WLAN (8265NGW)

Test Date	Probe S/N	Calibration Point		Measured Conductivity (σ)	Measured Permittivity (ϵ_r)	Validation for CW			Validation for Modulation		
						Sensitivity Range	Probe Linearity	Probe Isotropy	Modulation Type	Duty Factor	PAR
Jan. 04, 2017	3864	Body	2450	2.029	51.700	Pass	Pass	Pass	OFDM	N/A	Pass
Jan. 04, 2017	3864	Body	5250	5.357	48.606	Pass	Pass	Pass	OFDM	N/A	Pass
Jan. 04, 2017	3864	Body	5600	5.792	48.099	Pass	Pass	Pass	OFDM	N/A	Pass
Jan. 04, 2017	3864	Body	5800	6.245	48.363	Pass	Pass	Pass	OFDM	N/A	Pass

FCC SAR Test Report

4.5 System Verification

The measuring result for system verification is tabulated as below.

WWAN (EM7455)

Test Date	Mode	Frequency (MHz)	1W Target SAR-1g (W/kg)	Measured SAR-1g (W/kg)	Normalized to 1W SAR-1g (W/kg)	Deviation (%)	Dipole S/N	Probe S/N	DAE S/N
Nov. 18, 2016	Body	750	8.77	2.02	8.08	-7.87	1013	7350	1305
Dec. 09, 2016	Body	750	8.77	2.24	8.96	2.17	1013	1790	1277
Fbe. 14, 2017	Body	750	8.77	2.35	9.40	7.18	1013	3820	913
Dec. 05, 2016	Body	835	9.57	2.48	9.92	3.66	4d121	1790	1277
Dec. 09, 2016	Body	835	9.57	2.50	10.00	4.49	4d121	1790	1277
Nov. 16, 2016	Body	1750	37.50	9.04	36.16	-3.57	1055	7350	1305
Dec. 02, 2016	Body	1750	37.50	9.10	36.40	-2.93	1055	1790	1277
Dec. 08, 2016	Body	1750	37.50	9.53	38.12	1.65	1055	1790	1277
Dec. 09, 2016	Body	1750	37.50	9.07	36.28	-3.25	1055	3971	579
Dec. 14, 2016	Body	1750	37.50	9.57	38.28	2.08	1055	1790	1277
Fbe. 13, 2017	Body	1750	37.50	8.92	35.68	-4.85	1055	3820	913
Dec. 02, 2016	Body	1900	40.70	9.80	39.20	-3.69	5d036	1790	1277
Dec. 06, 2016	Body	1900	40.70	9.79	39.16	-3.78	5d036	3971	579
Dec. 08, 2016	Body	1900	40.70	10.01	40.04	-1.62	5d036	1790	1277
Fbe. 13, 2017	Body	1900	40.20	10.50	42.00	4.48	5d142	3820	913
Dec. 09, 2016	Body	2600	55.70	15.00	60.00	7.72	1020	3971	579
Dec. 14, 2016	Body	2600	55.70	14.00	56.00	0.54	1020	3971	579
Dec. 14, 2016	Body	2600	55.70	13.40	53.60	-3.77	1020	3971	579
Fbe. 13, 2017	Body	2600	55.70	13.90	55.60	-0.18	1020	3820	913

WLAN (QCFA344A)

Test Date	Mode	Frequency (MHz)	1W Target SAR-1g (W/kg)	Measured SAR-1g (W/kg)	Normalized to 1W SAR-1g (W/kg)	Deviation (%)	Dipole S/N	Probe S/N	DAE S/N
Nov. 17, 2016	Body	2450	51.10	12.60	50.40	-1.37	737	7350	1305
Dec. 12, 2016	Body	2450	51.10	12.80	51.20	0.20	737	3971	579
Feb. 24, 2017	Body	2450	51.10	12.70	50.80	-0.59	737	3971	1431
Nov. 17, 2016	Body	5250	77.60	7.61	76.10	-1.93	1019	7350	1305
Dec. 13, 2016	Body	5250	77.60	7.88	78.80	1.55	1019	3971	579
Feb. 24, 2017	Body	5250	77.60	7.97	79.70	2.71	737	3971	1431
Dec. 13, 2016	Body	5600	79.60	7.79	77.90	-2.14	1019	3971	579
Dec. 22, 2016	Body	5600	79.60	7.85	78.50	-1.38	1019	3650	861
Feb. 24, 2017	Body	5600	79.60	7.95	79.50	-0.13	737	3971	1431
Dec. 13, 2016	Body	5800	77.30	8.21	82.10	6.21	1019	3971	579
Dec. 22, 2016	Body	5800	77.30	7.67	76.70	-0.78	1019	3650	861
Feb. 24, 2017	Body	5800	77.30	8.13	81.30	5.17	737	3971	1431

FCC SAR Test Report

WLAN (8265NGW)

Test Date	Mode	Frequency (MHz)	1W Target SAR-1g (W/kg)	Measured SAR-1g (W/kg)	Normalized to 1W SAR-1g (W/kg)	Deviation (%)	Dipole S/N	Probe S/N	DAE S/N
Jan. 04, 2017	Body	2450	51.10	12.00	48.00	-6.07	737	3864	1431
Jan. 04, 2017	Body	5250	77.60	7.81	78.10	0.64	1019	3864	1431
Jan. 04, 2017	Body	5600	79.60	7.80	78.00	-2.01	1019	3864	1431
Jan. 04, 2017	Body	5800	77.30	8.06	80.60	4.27	1019	3864	1431

Note:

Comparing to the reference SAR value provided by SPEAG, the validation data should be within its specification of 10 %. The result indicates the system check can meet the variation criterion and the plots can be referred to Appendix A of this report.

FCC SAR Test Report

4.6 Maximum Output Power

4.6.1 Maximum Conducted Power

The maximum conducted average power (Unit: dBm) including tune-up tolerance is shown as below.

Mode	WCDMA Band II (without Power Reduction)	WCDMA Band II (with Power Reduction)	Power Reduction (dB)
RMC 12.2K	24.0	20.0	4.0
HSDPA	24.0	20.0	4.0
HSUPA	24.0	20.0	4.0

Mode	WCDMA Band IV (without Power Reduction)	WCDMA Band IV (with Power Reduction)	Power Reduction (dB)
RMC 12.2K	24.0	19.0	5.0
HSDPA	24.0	19.0	5.0
HSUPA	24.0	19.0	5.0

Mode	WCDMA Band V (without Power Reduction)	WCDMA Band V (with Power Reduction)	Power Reduction (dB)
RMC 12.2K	24.0	21.5	2.5
HSDPA	24.0	21.5	2.5
HSUPA	24.0	21.5	2.5

Mode	LTE 2 (without Power Reduction)	LTE 2 (with Power Reduction)	Power Reduction (dB)
QPSK / 16QAM	24.0	20.5	3.5

Mode	LTE 4 (without Power Reduction)	LTE 4 (with Power Reduction)	Power Reduction (dB)
QPSK / 16QAM	24.0	19.0	5.0

Mode	LTE 5 (without Power Reduction)	LTE 5 (with Power Reduction)	Power Reduction (dB)
QPSK / 16QAM	24.0	22.0	2.0

Mode	LTE 7 (without Power Reduction)	LTE 7 (with Power Reduction)	Power Reduction (dB)
QPSK / 16QAM	23.0	18.0	5.0

Mode	LTE 12 (without Power Reduction)	LTE 12 (with Power Reduction)	Power Reduction (dB)
QPSK / 16QAM	24.0	21.0	3.0

Mode	LTE 13 (without Power Reduction)	LTE 13 (with Power Reduction)	Power Reduction (dB)
QPSK / 16QAM	24.0	21.0	3.0

FCC SAR Test Report

Mode	LTE 25 (without Power Reduction)	LTE 25 (with Power Reduction)	Power Reduction (dB)
QPSK / 16QAM	24.0	20.0	4.0

Mode	LTE 26 (without Power Reduction)	LTE 26 (with Power Reduction)	Power Reduction (dB)
QPSK / 16QAM	24.0	21.5	2.5

Mode	LTE 41 (without Power Reduction)	LTE 41 (with Power Reduction)	Power Reduction (dB)
QPSK / 16QAM	23.0	19.5	3.5

Mode	Ant.	802.11b	802.11g	802.11n HT20	802.11n HT40
2.4G WLAN	Ant-0	CH1-12:12.0 CH13:11.5	CH1-12:12.0 CH13:3.0	CH1-12:12.0 CH13:1.5	CH3-8:12.0 CH9-10:11.0 CH11:2.5
	Ant-1	CH1-12:12.0 CH13:11.5	CH1-12:12.0 CH13:3.0	CH1-12:12.0 CH13:1.5	CH3-8:12.0 CH9-10:11.0 CH11:2.5
	Ant-0+1	Ant 0: CH1-12:12.0 CH13:11.5 Ant 1: CH1-12:12.0 CH13:11.5 Ant 0+1: CH1-12:15.0 CH13:14.5	Ant 0: CH1-12:12.0 CH13:3.0 Ant 1: CH1-12:12.0 CH13:3.0 Ant 0+1: CH1-12:15.0 CH13:6.0	Ant 0: CH1-12:12.0 CH13:1.5 Ant 1: CH1-12:12.0 CH13:1.5 Ant 0+1: CH1-12:15.0 CH13:4.5	Ant 0: CH3-8:12.0 CH9-10:11.0 CH11:2.5 Ant 1: CH3-8:12.0 CH9-10:11.0 CH11:2.5 Ant 0+1: CH3-8:15.0 CH9-10:14.0 CH11:5.5

FCC SAR Test Report

Mode	Ant.	802.11a	802.11n HT20	802.11n HT40	802.11ac VHT80
5.2G WLAN	Ant-0	10.5	10.5	10.5	10.5
	Ant-1	10.5	10.5	10.5	10.5
	Ant-0+1	Ant 0:10.5 Ant 1:10.5 Ant 0+1:13.5	Ant 0:10.5 Ant 1:10.5 Ant 0+1:13.5	Ant 0:10.5 Ant 1:10.5 Ant 0+1:13.5	Ant 0: 10.5 Ant 1:10.5 Ant 0+1:13.5
5.3G WLAN	Ant-0	10.5	10.5	10.5	10.5
	Ant-1	10.5	10.5	10.5	10.5
	Ant-0+1	Ant 0:10.5 Ant 1:10.5 Ant 0+1:13.5	Ant 0:10.5 Ant 1:10.5 Ant 0+1:13.5	Ant 0:10.5 Ant 1:10.5 Ant 0+1:13.5	Ant 0: 10.5 Ant 1:10.5 Ant 0+1:13.5
5.6G WLAN	Ant-0	10.5	10.5	10.5	10.5
	Ant-1	10.5	10.5	10.5	10.5
	Ant-0+1	Ant 0:10.5 Ant 1:10.5 Ant 0+1:13.5	Ant 0:10.5 Ant 1:10.5 Ant 0+1:13.5	Ant 0:10.5 Ant 1:10.5 Ant 0+1:13.5	Ant 0: 10.5 Ant 1:10.5 Ant 0+1:13.5
5.8G WLAN	Ant-0	10.5	10.5	10.5	10.0
	Ant-1	10.5	10.5	10.5	10.0
	Ant-0+1	Ant 0:10.5 Ant 1:10.5 Ant 0+1:13.5	Ant 0:10.5 Ant 1:10.5 Ant 0+1:13.5	Ant 0:10.5 Ant 1:10.5 Ant 0+1:13.5	Ant 0: 10.0 Ant 1:10.0 Ant 0+1:13.0

Mode	2.4G Bluetooth
Bluetooth DH	7.0

FCC SAR Test Report

4.6.2 Measured Conducted Power Result

The measuring conducted average power (Unit: dBm) is shown as below.

Band Channel Frequency (MHz)	WCDMA Band II			WCDMA Band IV			WCDMA Band V			3GPP MPR (dB)
	9262 1852.4	9400 1880.0	9538 1907.6	1312 1712.4	1413 1732.6	1513 1752.6	4132 826.4	4182 836.4	4233 846.6	
EUT without Power Reduction (P-Sensor NOT Triggered)										
RMC 12.2K	23.32	23.17	23.22	23.06	23.08	23.14	22.71	22.79	22.82	-
HSDPA Subtest-1	22.79	22.55	22.65	22.60	22.64	22.71	22.33	22.42	22.50	0
HSDPA Subtest-2	22.64	22.51	22.57	22.50	22.57	22.60	22.32	22.39	22.41	0
HSDPA Subtest-3	22.20	21.97	22.06	22.04	22.06	22.09	21.79	21.88	21.96	0.5
HSDPA Subtest-4	22.05	21.95	22.00	21.64	21.66	21.81	21.78	21.85	21.89	0.5
HSUPA Subtest-1	22.30	22.16	22.21	22.73	22.80	22.84	22.09	22.14	22.17	0
HSUPA Subtest-2	20.69	21.01	20.61	21.24	21.14	21.09	21.01	20.99	20.97	2
HSUPA Subtest-3	21.18	21.07	21.16	21.19	21.21	21.35	21.18	21.25	21.06	1
HSUPA Subtest-4	20.61	20.91	21.01	21.11	21.28	20.92	20.82	20.85	20.91	2
HSUPA Subtest-5	22.63	22.50	22.56	22.55	22.60	22.64	22.13	22.30	22.33	0
EUT with Power Reduction (P-Sensor Triggered)										
RMC 12.2K	19.76	19.65	19.53	18.61	18.64	18.70	21.24	21.32	21.26	-
HSDPA Subtest-1	19.47	19.29	19.32	17.85	18.03	18.01	20.64	20.56	20.56	0
HSDPA Subtest-2	19.50	19.30	19.33	17.86	18.04	18.04	20.70	20.61	20.60	0
HSDPA Subtest-3	18.99	18.78	18.81	17.44	17.52	17.54	20.18	20.09	19.93	0.5
HSDPA Subtest-4	18.99	18.73	18.82	17.39	17.53	17.53	20.18	20.09	20.09	0.5
HSUPA Subtest-1	19.21	18.99	19.00	17.65	17.71	17.75	20.01	20.11	20.05	0
HSUPA Subtest-2	19.38	19.28	19.31	17.94	18.02	17.92	20.48	20.39	20.39	2
HSUPA Subtest-3	19.41	19.23	19.29	17.89	18.00	17.95	20.26	20.17	20.16	1
HSUPA Subtest-4	19.43	19.16	19.20	17.82	17.91	17.97	20.62	20.59	20.45	2
HSUPA Subtest-5	19.48	19.27	19.40	17.93	18.11	18.02	20.51	20.63	20.73	0

FCC SAR Test Report

Band / BW	RB Size	RB Offset	QPSK			3GPP MPR (dB)	16QAM			3GPP MPR (dB)
			Low CH 18607	Mid CH 18900	High CH 19193		Low CH 18607	Mid CH 18900	High CH 19193	
			1850.7 MHz	1880.0 MHz	1909.3 MHz		1850.7 MHz	1880.0 MHz	1909.3 MHz	
EUT without Power Reduction (P-Sensor NOT Triggered)										
2 / 1.4M	1	0	22.48	22.52	22.44	0	21.39	21.43	21.35	1
	1	2	22.30	22.34	22.26	0	21.21	21.25	21.17	1
	1	5	22.35	22.39	22.31	0	21.26	21.30	21.22	1
	3	0	22.16	22.20	22.12	0	21.07	21.11	21.03	1
	3	1	22.13	22.17	22.09	0	21.04	21.08	21.01	1
	3	3	22.15	22.19	22.11	0	21.06	21.10	21.02	1
	6	0	21.20	21.24	21.16	1	20.11	20.15	20.07	2
EUT with Power Reduction (P-Sensor Triggered)										
2 / 1.4M	1	0	20.17	20.09	20.06	0	20.12	20.04	20.01	0
	1	2	20.13	20.06	19.94	0	20.08	20.01	19.89	0
	1	5	19.94	19.89	19.83	0	19.89	19.84	19.78	0
	3	0	20.13	20.07	20.02	0	20.08	20.02	19.97	0
	3	1	20.12	20.04	20.01	0	20.07	19.99	19.96	0
	3	3	20.11	20.03	20.00	0	20.06	19.98	19.95	0
	6	0	20.16	20.11	20.04	0	20.11	20.06	19.99	0

Band / BW	RB Size	RB Offset	QPSK			3GPP MPR (dB)	16QAM			3GPP MPR (dB)
			Low CH 18615	Mid CH 18900	High CH 19185		Low CH 18615	Mid CH 18900	High CH 19185	
			1851.5 MHz	1880.0 MHz	1908.5 MHz		1851.5 MHz	1880.0 MHz	1908.5 MHz	
EUT without Power Reduction (P-Sensor NOT Triggered)										
2 / 3M	1	0	22.60	22.64	22.56	0	21.51	21.55	21.47	1
	1	7	22.42	22.46	22.38	0	21.33	21.37	21.29	1
	1	14	22.47	22.51	22.43	0	21.38	21.42	21.34	1
	8	0	21.38	21.42	21.34	1	20.29	20.33	20.25	2
	8	3	21.35	21.39	21.31	1	20.26	20.30	20.22	2
	8	7	21.37	21.41	21.33	1	20.28	20.32	20.24	2
	15	0	21.32	21.36	21.28	1	20.23	20.27	20.19	2
EUT with Power Reduction (P-Sensor Triggered)										
2 / 3M	1	0	20.23	20.15	20.12	0	20.18	20.10	20.07	0
	1	7	20.19	20.12	20.00	0	20.14	20.07	19.95	0
	1	14	20.00	19.95	19.89	0	19.95	19.90	19.84	0
	8	0	20.19	20.13	20.08	0	20.14	20.08	20.03	0
	8	3	20.18	20.10	20.07	0	20.13	20.05	20.02	0
	8	7	20.17	20.09	20.06	0	20.12	20.04	20.01	0
	15	0	20.22	20.17	20.10	0	20.17	20.12	20.05	0

FCC SAR Test Report

Band / BW	RB Size	RB Offset	QPSK			3GPP MPR (dB)	16QAM			3GPP MPR (dB)
			Low CH 18625	Mid CH 18900	High CH 19175		Low CH 18625	Mid CH 18900	High CH 19175	
			1852.5 MHz	1880.0 MHz	1907.5 MHz		1852.5 MHz	1880.0 MHz	1907.5 MHz	
EUT without Power Reduction (P-Sensor NOT Triggered)										
2 / 5M	1	0	22.71	22.75	22.67	0	21.62	21.66	21.58	1
	1	12	22.53	22.57	22.49	0	21.44	21.48	21.40	1
	1	24	22.58	22.62	22.54	0	21.49	21.53	21.45	1
	12	0	21.49	21.53	21.45	1	20.40	20.44	20.36	2
	12	6	21.46	21.50	21.42	1	20.37	20.41	20.33	2
	12	13	21.48	21.52	21.44	1	20.39	20.43	20.35	2
	25	0	21.43	21.47	21.39	1	20.34	20.38	20.30	2
EUT with Power Reduction (P-Sensor Triggered)										
2 / 5M	1	0	20.25	20.17	20.14	0	20.20	20.12	20.09	0
	1	12	20.21	20.14	20.02	0	20.16	20.09	19.97	0
	1	24	20.02	19.97	19.91	0	19.97	19.92	19.86	0
	12	0	20.21	20.15	20.10	0	20.16	20.10	20.05	0
	12	6	20.20	20.12	20.09	0	20.15	20.07	20.04	0
	12	13	20.19	20.11	20.08	0	20.14	20.06	20.03	0
	25	0	20.24	20.19	20.12	0	20.19	20.14	20.07	0

Band / BW	RB Size	RB Offset	QPSK			3GPP MPR (dB)	16QAM			3GPP MPR (dB)
			Low CH 18650	Mid CH 18900	High CH 19150		Low CH 18650	Mid CH 18900	High CH 19150	
			1855.0 MHz	1880.0 MHz	1905.0 MHz		1855.0 MHz	1880.0 MHz	1905.0 MHz	
EUT without Power Reduction (P-Sensor NOT Triggered)										
2 / 10M	1	0	22.84	22.88	22.80	0	21.75	21.79	21.71	1
	1	24	22.66	22.70	22.62	0	21.57	21.61	21.53	1
	1	49	22.71	22.75	22.67	0	21.62	21.66	21.58	1
	25	0	21.62	21.66	21.58	1	20.53	20.57	20.49	2
	25	12	21.59	21.63	21.55	1	20.50	20.54	20.46	2
	25	25	21.61	21.65	21.57	1	20.52	20.56	20.48	2
	50	0	21.56	21.60	21.52	1	20.47	20.51	20.43	2
EUT with Power Reduction (P-Sensor Triggered)										
2 / 10M	1	0	20.30	20.22	20.19	0	20.17	20.25	20.14	0
	1	24	20.26	20.19	20.07	0	20.14	20.21	20.02	0
	1	49	20.07	20.02	19.96	0	19.97	20.02	19.91	0
	25	0	20.26	20.20	20.15	0	20.15	20.21	20.10	0
	25	12	20.25	20.17	20.14	0	20.12	20.20	20.09	0
	25	25	20.24	20.16	20.13	0	20.11	20.19	20.08	0
	50	0	20.29	20.24	20.17	0	20.19	20.24	20.12	0

FCC SAR Test Report

Band / BW	RB Size	RB Offset	QPSK			3GPP MPR (dB)	16QAM			3GPP MPR (dB)
			Low CH 18675	Mid CH 18900	High CH 19125		Low CH 18675	Mid CH 18900	High CH 19125	
			1857.5 MHz	1880.0 MHz	1902.5 MHz		1857.5 MHz	1880.0 MHz	1902.5 MHz	
EUT without Power Reduction (P-Sensor NOT Triggered)										
2 / 15M	1	0	22.93	22.97	22.89	0	21.84	21.88	21.80	1
	1	37	22.75	22.79	22.71	0	21.66	21.70	21.62	1
	1	74	22.80	22.84	22.76	0	21.71	21.75	21.67	1
	36	0	21.71	21.75	21.67	1	20.62	20.66	20.58	2
	36	19	21.68	21.72	21.64	1	20.59	20.63	20.55	2
	36	39	21.70	21.74	21.66	1	20.61	20.65	20.57	2
	75	0	21.65	21.69	21.61	1	20.56	20.60	20.52	2
EUT with Power Reduction (P-Sensor Triggered)										
2 / 15M	1	0	20.34	20.26	20.23	0	20.29	20.21	20.18	0
	1	37	20.30	20.23	20.11	0	20.25	20.18	20.06	0
	1	74	20.11	20.06	20.00	0	20.06	20.01	19.95	0
	36	0	20.30	20.24	20.19	0	20.25	20.19	20.14	0
	36	19	20.29	20.21	20.18	0	20.24	20.16	20.13	0
	36	39	20.28	20.20	20.17	0	20.23	20.15	20.12	0
	75	0	20.33	20.28	20.21	0	20.28	20.23	20.16	0

Band / BW	RB Size	RB Offset	QPSK			3GPP MPR (dB)	16QAM			3GPP MPR (dB)
			Low CH 18700	Mid CH 18900	High CH 19100		Low CH 18700	Mid CH 18900	High CH 19100	
			1860.0 MHz	1880.0 MHz	1900.0 MHz		1860.0 MHz	1880.0 MHz	1900.0 MHz	
EUT without Power Reduction (P-Sensor NOT Triggered)										
2 / 20M	1	0	23.05	23.09	23.01	0	21.96	22.00	21.92	1
	1	50	22.87	22.91	22.83	0	21.78	21.82	21.74	1
	1	99	22.92	22.96	22.88	0	21.83	21.87	21.79	1
	50	0	21.83	21.87	21.79	1	20.74	20.78	20.70	2
	50	25	21.80	21.84	21.76	1	20.71	20.75	20.67	2
	50	50	21.82	21.86	21.78	1	20.73	20.77	20.69	2
	100	0	21.77	21.81	21.73	1	20.68	20.72	20.64	2
EUT with Power Reduction (P-Sensor Triggered)										
2 / 20M	1	0	20.40	20.32	20.29	0	20.35	20.27	20.24	0
	1	50	20.36	20.29	20.17	0	20.31	20.24	20.12	0
	1	99	20.17	20.12	20.06	0	20.12	20.07	20.01	0
	50	0	20.36	20.30	20.25	0	20.31	20.25	20.20	0
	50	25	20.35	20.27	20.24	0	20.30	20.22	20.19	0
	50	50	20.34	20.26	20.23	0	20.29	20.21	20.18	0
	100	0	20.39	20.34	20.27	0	20.34	20.29	20.22	0

FCC SAR Test Report

Band / BW	RB Size	RB Offset	QPSK			3GPP MPR (dB)	16QAM			3GPP MPR (dB)
			Low CH 19957	Mid CH 20175	High CH 20393		Low CH 19957	Mid CH 20175	High CH 20393	
			1710.7 MHz	1732.5 MHz	1754.3 MHz		1710.7 MHz	1732.5 MHz	1754.3 MHz	
EUT without Power Reduction (P-Sensor NOT Triggered)										
4 / 1.4M	1	0	22.59	22.50	22.52	0	21.47	21.38	21.40	1
	1	2	22.35	22.26	22.28	0	21.23	21.14	21.16	1
	1	5	22.22	22.13	22.15	0	21.10	21.01	21.03	1
	3	0	22.37	22.28	22.30	0	21.25	21.16	21.18	1
	3	1	22.32	22.23	22.25	0	21.20	21.11	21.13	1
	3	3	22.27	22.18	22.20	0	21.15	21.06	21.08	1
	6	0	21.45	21.36	21.38	1	20.33	20.24	20.26	2
EUT with Power Reduction (P-Sensor Triggered)										
4 / 1.4M	1	0	18.37	18.22	18.35	0	18.28	18.13	18.26	0
	1	2	18.36	18.17	18.28	0	18.27	18.08	18.19	0
	1	5	18.01	17.91	17.99	0	17.92	17.82	17.90	0
	3	0	18.35	18.18	18.33	0	18.26	18.09	18.24	0
	3	1	18.28	18.10	18.21	0	18.19	18.01	18.12	0
	3	3	18.21	18.07	18.14	0	18.12	17.98	18.05	0
	6	0	18.24	18.10	18.21	0	18.15	18.01	18.12	0
EUT without Power Reduction (P-Sensor NOT Triggered)										
Band / BW	RB Size	RB Offset	QPSK			3GPP MPR (dB)	16QAM			3GPP MPR (dB)
			Low CH 19965	Mid CH 20175	High CH 20385		Low CH 19965	Mid CH 20175	High CH 20385	
			1711.5 MHz	1732.5 MHz	1753.5 MHz		1711.5 MHz	1732.5 MHz	1753.5 MHz	
EUT without Power Reduction (P-Sensor NOT Triggered)										
4 / 3M	1	0	22.70	22.61	22.63	0	21.58	21.49	21.51	1
	1	7	22.46	22.37	22.39	0	21.34	21.25	21.27	1
	1	14	22.33	22.24	22.26	0	21.21	21.12	21.14	1
	8	0	21.62	21.53	21.55	1	20.50	20.41	20.43	2
	8	3	21.57	21.48	21.50	1	20.45	20.36	20.38	2
	8	7	21.52	21.43	21.45	1	20.40	20.31	20.33	2
	15	0	21.56	21.47	21.49	1	20.44	20.35	20.37	2
EUT with Power Reduction (P-Sensor Triggered)										
4 / 3M	1	0	18.46	18.31	18.44	0	18.37	18.22	18.35	0
	1	7	18.45	18.26	18.37	0	18.36	18.17	18.28	0
	1	14	18.10	18.00	18.08	0	18.01	17.91	17.99	0
	8	0	18.44	18.27	18.42	0	18.35	18.18	18.33	0
	8	3	18.37	18.19	18.30	0	18.28	18.10	18.21	0
	8	7	18.30	18.16	18.23	0	18.21	18.07	18.14	0
	15	0	18.33	18.19	18.30	0	18.24	18.10	18.21	0

FCC SAR Test Report

Band / BW	RB Size	RB Offset	QPSK			3GPP MPR (dB)	16QAM			3GPP MPR (dB)
			Low CH 19975	Mid CH 20175	High CH 20375		Low CH 19975	Mid CH 20175	High CH 20375	
			1712.5 MHz	1732.5 MHz	1752.5 MHz		1712.5 MHz	1732.5 MHz	1752.5 MHz	
EUT without Power Reduction (P-Sensor NOT Triggered)										
4 / 5M	1	0	22.82	22.73	22.75	0	21.70	21.61	21.63	1
	1	12	22.58	22.49	22.51	0	21.46	21.37	21.39	1
	1	24	22.45	22.36	22.38	0	21.33	21.24	21.26	1
	12	0	21.74	21.65	21.67	1	20.62	20.53	20.55	2
	12	6	21.69	21.60	21.62	1	20.57	20.48	20.50	2
	12	13	21.64	21.55	21.57	1	20.52	20.43	20.45	2
	25	0	21.68	21.59	21.61	1	20.56	20.47	20.49	2
EUT with Power Reduction (P-Sensor Triggered)										
4 / 5M	1	0	18.58	18.43	18.56	0	18.49	18.34	18.47	0
	1	12	18.57	18.38	18.49	0	18.48	18.29	18.40	0
	1	24	18.22	18.12	18.20	0	18.13	18.03	18.11	0
	12	0	18.56	18.39	18.54	0	18.47	18.30	18.45	0
	12	6	18.49	18.31	18.42	0	18.40	18.22	18.33	0
	12	13	18.42	18.28	18.35	0	18.33	18.19	18.26	0
	25	0	18.45	18.31	18.42	0	18.36	18.22	18.33	0

Band / BW	RB Size	RB Offset	QPSK			3GPP MPR (dB)	16QAM			3GPP MPR (dB)
			Low CH 20000	Mid CH 20175	High CH 20350		Low CH 20000	Mid CH 20175	High CH 20350	
			1715.0 MHz	1732.5 MHz	1750.0 MHz		1715.0 MHz	1732.5 MHz	1750.0 MHz	
EUT without Power Reduction (P-Sensor NOT Triggered)										
4 / 10M	1	0	22.93	22.84	22.86	0	21.81	21.72	21.74	1
	1	24	22.69	22.60	22.62	0	21.57	21.48	21.50	1
	1	49	22.56	22.47	22.49	0	21.44	21.35	21.37	1
	25	0	21.85	21.76	21.78	1	20.73	20.64	20.66	2
	25	12	21.80	21.71	21.73	1	20.68	20.59	20.61	2
	25	25	21.75	21.66	21.68	1	20.63	20.54	20.56	2
	50	0	21.79	21.70	21.72	1	20.67	20.58	20.60	2
EUT with Power Reduction (P-Sensor Triggered)										
4 / 10M	1	0	18.69	18.54	18.67	0	18.60	18.45	18.58	0
	1	24	18.68	18.49	18.60	0	18.59	18.40	18.51	0
	1	49	18.33	18.23	18.31	0	18.24	18.14	18.22	0
	25	0	18.67	18.50	18.65	0	18.58	18.41	18.56	0
	25	12	18.60	18.42	18.53	0	18.51	18.33	18.44	0
	25	25	18.53	18.39	18.46	0	18.44	18.30	18.37	0
	50	0	18.56	18.42	18.53	0	18.47	18.33	18.44	0

FCC SAR Test Report

Band / BW	RB Size	RB Offset	QPSK			3GPP MPR (dB)	16QAM			3GPP MPR (dB)
			Low CH 20025	Mid CH 20175	High CH 20325		Low CH 20025	Mid CH 20175	High CH 20325	
			1717.5 MHz	1732.5 MHz	1747.5 MHz		1717.5 MHz	1732.5 MHz	1747.5 MHz	
EUT without Power Reduction (P-Sensor NOT Triggered)										
4 / 15M	1	0	23.02	22.93	22.95	0	21.90	21.81	21.83	1
	1	37	22.78	22.69	22.71	0	21.66	21.57	21.59	1
	1	74	22.65	22.56	22.58	0	21.53	21.44	21.46	1
	36	0	21.94	21.85	21.87	1	20.82	20.73	20.75	2
	36	19	21.89	21.80	21.82	1	20.77	20.68	20.70	2
	36	39	21.84	21.75	21.77	1	20.72	20.63	20.65	2
	75	0	21.88	21.79	21.81	1	20.76	20.67	20.69	2
EUT with Power Reduction (P-Sensor Triggered)										
4 / 15M	1	0	18.82	18.67	18.80	0	18.73	18.58	18.71	0
	1	37	18.81	18.62	18.73	0	18.72	18.53	18.64	0
	1	74	18.46	18.36	18.44	0	18.37	18.27	18.35	0
	36	0	18.80	18.63	18.78	0	18.71	18.54	18.69	0
	36	19	18.73	18.55	18.66	0	18.64	18.46	18.57	0
	36	39	18.66	18.52	18.59	0	18.57	18.43	18.50	0
	75	0	18.69	18.55	18.66	0	18.60	18.46	18.57	0

Band / BW	RB Size	RB Offset	QPSK			3GPP MPR (dB)	16QAM			3GPP MPR (dB)
			Low CH 20050	Mid CH 20175	High CH 20300		Low CH 20050	Mid CH 20175	High CH 20300	
			1720.0 MHz	1732.5 MHz	1745.0 MHz		1720.0 MHz	1732.5 MHz	1745.0 MHz	
EUT without Power Reduction (P-Sensor NOT Triggered)										
4 / 20M	1	0	23.14	23.05	23.07	0	22.02	21.93	21.95	1
	1	50	22.90	22.81	22.83	0	21.78	21.69	21.71	1
	1	99	22.77	22.68	22.70	0	21.65	21.56	21.58	1
	50	0	22.06	21.97	21.99	1	20.94	20.85	20.87	2
	50	25	22.01	21.92	21.94	1	20.89	20.80	20.82	2
	50	50	21.96	21.87	21.89	1	20.84	20.75	20.77	2
	100	0	22.00	21.91	21.93	1	20.88	20.79	20.81	2
EUT with Power Reduction (P-Sensor Triggered)										
4 / 20M	1	0	18.92	18.77	18.90	0	18.83	18.68	18.81	0
	1	50	18.91	18.72	18.83	0	18.82	18.63	18.74	0
	1	99	18.56	18.46	18.54	0	18.47	18.37	18.45	0
	50	0	18.90	18.73	18.88	0	18.81	18.64	18.79	0
	50	25	18.83	18.65	18.76	0	18.74	18.56	18.67	0
	50	50	18.76	18.62	18.69	0	18.67	18.53	18.60	0
	100	0	18.79	18.65	18.76	0	18.70	18.56	18.67	0

FCC SAR Test Report

Band / BW	RB Size	RB Offset	QPSK			3GPP MPR (dB)	16QAM			3GPP MPR (dB)
			Low CH 20407	Mid CH 20525	High CH 20643		Low CH 20407	Mid CH 20525	High CH 20643	
			824.7 MHz	836.5 MHz	848.3 MHz		824.7 MHz	836.5 MHz	848.3 MHz	
EUT without Power Reduction (P-Sensor NOT Triggered)										
5 / 1.4M	1	0	22.45	22.46	22.42	0	21.31	21.32	21.28	1
	1	2	22.44	22.45	22.41	0	21.30	21.31	21.27	1
	1	5	22.41	22.42	22.38	0	21.27	21.28	21.24	1
	3	0	22.21	22.22	22.18	0	21.07	21.08	21.04	1
	3	1	22.19	22.20	22.16	0	21.05	21.06	21.02	1
	3	3	22.18	22.19	22.15	0	21.04	21.05	21.01	1
	6	0	21.35	21.36	21.32	1	20.21	20.22	20.18	2
EUT with Power Reduction (P-Sensor Triggered)										
5 / 1.4M	1	0	21.53	21.27	21.41	0	21.47	21.21	21.35	0
	1	2	21.33	21.07	21.21	0	21.27	21.01	21.15	0
	1	5	21.41	21.15	21.29	0	21.35	21.09	21.23	0
	3	0	21.48	21.22	21.36	0	21.42	21.16	21.30	0
	3	1	21.29	21.03	21.17	0	21.23	20.97	21.11	0
	3	3	21.45	21.19	21.33	0	21.39	21.13	21.27	0
	6	0	21.44	21.18	21.32	0	21.38	21.12	21.26	0

Band / BW	RB Size	RB Offset	QPSK			3GPP MPR (dB)	16QAM			3GPP MPR (dB)
			Low CH 20415	Mid CH 20525	High CH 20635		Low CH 20415	Mid CH 20525	High CH 20635	
			825.5 MHz	836.5 MHz	847.5 MHz		825.5 MHz	836.5 MHz	847.5 MHz	
EUT without Power Reduction (P-Sensor NOT Triggered)										
5 / 3M	1	0	22.56	22.57	22.53	0	21.42	21.43	21.39	1
	1	7	22.55	22.56	22.52	0	21.41	21.42	21.38	1
	1	14	22.52	22.53	22.49	0	21.38	21.39	21.35	1
	8	0	21.52	21.53	21.49	1	20.38	20.39	20.35	2
	8	3	21.50	21.51	21.47	1	20.36	20.37	20.33	2
	8	7	21.49	21.50	21.46	1	20.35	20.36	20.32	2
	15	0	21.46	21.47	21.43	1	20.32	20.33	20.29	2
EUT with Power Reduction (P-Sensor Triggered)										
5 / 3M	1	0	21.65	21.39	21.53	0	21.59	21.33	21.47	0
	1	7	21.45	21.19	21.33	0	21.39	21.13	21.27	0
	1	14	21.53	21.27	21.41	0	21.47	21.21	21.35	0
	8	0	21.60	21.34	21.48	0	21.54	21.28	21.42	0
	8	3	21.41	21.15	21.29	0	21.35	21.09	21.23	0
	8	7	21.57	21.31	21.45	0	21.51	21.25	21.39	0
	15	0	21.56	21.30	21.44	0	21.50	21.24	21.38	0

FCC SAR Test Report

Band / BW	RB Size	RB Offset	QPSK			3GPP MPR (dB)	16QAM			3GPP MPR (dB)
			Low CH 20425	Mid CH 20525	High CH 20625		Low CH 20425	Mid CH 20525	High CH 20625	
			826.5 MHz	836.5 MHz	846.5 MHz		826.5 MHz	836.5 MHz	846.5 MHz	
EUT without Power Reduction (P-Sensor NOT Triggered)										
5 / 5M	1	0	22.65	22.66	22.62	0	21.51	21.52	21.48	1
	1	12	22.64	22.65	22.61	0	21.50	21.51	21.47	1
	1	24	22.61	22.62	22.58	0	21.47	21.48	21.44	1
	12	0	21.61	21.62	21.58	1	20.47	20.48	20.44	2
	12	6	21.59	21.60	21.56	1	20.45	20.46	20.42	2
	12	13	21.58	21.59	21.55	1	20.44	20.45	20.41	2
	25	0	21.55	21.56	21.52	1	20.41	20.42	20.38	2
EUT with Power Reduction (P-Sensor Triggered)										
5 / 5M	1	0	21.73	21.47	21.61	0	21.67	21.41	21.55	0
	1	12	21.53	21.27	21.41	0	21.47	21.21	21.35	0
	1	24	21.61	21.35	21.49	0	21.55	21.29	21.43	0
	12	0	21.68	21.42	21.56	0	21.62	21.36	21.50	0
	12	6	21.49	21.23	21.37	0	21.43	21.17	21.31	0
	12	13	21.65	21.39	21.53	0	21.59	21.33	21.47	0
	25	0	21.64	21.38	21.52	0	21.58	21.32	21.46	0

Band / BW	RB Size	RB Offset	QPSK			3GPP MPR (dB)	16QAM			3GPP MPR (dB)
			Low CH 20450	Mid CH 20525	High CH 20600		Low CH 20450	Mid CH 20525	High CH 20600	
			829.0 MHz	836.5 MHz	844.0 MHz		829.0 MHz	836.5 MHz	844.0 MHz	
EUT without Power Reduction (P-Sensor NOT Triggered)										
5 / 10M	1	0	22.78	22.79	22.75	0	21.64	21.65	21.61	1
	1	24	22.77	22.78	22.74	0	21.63	21.64	21.60	1
	1	49	22.74	22.75	22.71	0	21.60	21.61	21.57	1
	25	0	21.74	21.75	21.71	1	20.60	20.61	20.57	2
	25	12	21.72	21.73	21.69	1	20.58	20.59	20.55	2
	25	25	21.71	21.72	21.68	1	20.57	20.58	20.54	2
	50	0	21.68	21.69	21.65	1	20.54	20.55	20.51	2
EUT with Power Reduction (P-Sensor Triggered)										
5 / 10M	1	0	21.84	21.58	21.72	0	21.78	21.52	21.66	0
	1	24	21.64	21.38	21.52	0	21.58	21.32	21.46	0
	1	49	21.72	21.46	21.60	0	21.66	21.40	21.54	0
	25	0	21.79	21.53	21.67	0	21.73	21.47	21.61	0
	25	12	21.60	21.34	21.48	0	21.54	21.28	21.42	0
	25	25	21.76	21.50	21.64	0	21.70	21.44	21.58	0
	50	0	21.75	21.49	21.63	0	21.69	21.43	21.57	0

FCC SAR Test Report

Band / BW	RB Size	RB Offset	QPSK			3GPP MPR (dB)	16QAM			3GPP MPR (dB)
			Low CH 20775	Mid CH 21100	High CH 21425		Low CH 20775	Mid CH 21100	High CH 21425	
			2502.5 MHz	2535.0 MHz	2567.5 MHz		2502.5 MHz	2535.0 MHz	2567.5 MHz	
EUT without Power Reduction (P-Sensor NOT Triggered)										
7 / 5M	1	0	21.04	21.12	21.06	0	20.14	20.15	20.11	1
	1	12	21.02	21.10	21.04	0	20.12	20.13	20.09	1
	1	24	21.01	21.06	21.01	0	20.04	20.05	20.01	1
	12	0	20.07	20.15	20.09	1	19.14	19.18	19.10	2
	12	6	20.06	20.14	20.08	1	19.13	19.17	19.09	2
	12	13	20.04	20.12	20.06	1	19.11	19.15	19.07	2
	25	0	20.03	20.11	20.05	1	19.10	19.14	19.06	2
EUT with Power Reduction (P-Sensor Triggered)										
7 / 5M	1	0	16.11	16.64	16.13	0	16.08	16.60	16.11	0
	1	12	16.08	16.57	16.09	0	16.05	16.53	16.09	0
	1	24	16.06	16.29	16.05	0	16.04	16.25	16.07	0
	12	0	16.04	16.55	16.04	0	16.02	16.51	16.04	0
	12	6	16.07	16.34	16.06	0	16.08	16.30	16.08	0
	12	13	16.02	16.27	16.03	0	16.05	16.23	16.06	0
	25	0	16.02	16.57	16.04	0	16.07	16.53	16.02	0

Band / BW	RB Size	RB Offset	QPSK			3GPP MPR (dB)	16QAM			3GPP MPR (dB)
			Low CH 20800	Mid CH 21100	High CH 21400		Low CH 20800	Mid CH 21100	High CH 21400	
			2505.0 MHz	2535.0 MHz	2565.0 MHz		2505.0 MHz	2535.0 MHz	2565.0 MHz	
EUT without Power Reduction (P-Sensor NOT Triggered)										
7 / 10M	1	0	21.17	21.25	21.09	0	20.16	20.20	20.08	1
	1	24	21.15	21.23	21.07	0	20.14	20.18	20.06	1
	1	49	21.07	21.15	21.05	0	20.06	20.10	20.04	1
	25	0	20.20	20.28	20.12	1	19.19	19.23	19.11	2
	25	12	20.19	20.27	20.11	1	19.18	19.22	19.10	2
	25	25	20.17	20.25	20.09	1	19.16	19.20	19.08	2
	50	0	20.16	20.24	20.08	1	19.15	19.19	19.07	2
EUT with Power Reduction (P-Sensor Triggered)										
7 / 10M	1	0	16.13	16.72	16.21	0	16.09	16.68	16.17	0
	1	24	16.08	16.65	16.15	0	16.03	16.61	16.07	0
	1	49	16.05	16.37	16.06	0	16.04	16.33	16.04	0
	25	0	16.04	16.63	16.02	0	16.07	16.59	16.08	0
	25	12	16.08	16.42	16.03	0	16.08	16.38	16.12	0
	25	25	16.02	16.35	16.05	0	16.05	16.31	16.06	0
	50	0	16.09	16.65	16.04	0	16.07	16.61	16.14	0

FCC SAR Test Report

Band / BW	RB Size	RB Offset	QPSK			3GPP MPR (dB)	16QAM			3GPP MPR (dB)
			Low CH 20825	Mid CH 21100	High CH 21375		Low CH 20825	Mid CH 21100	High CH 21375	
			2507.5 MHz	2535.0 MHz	2562.5 MHz		2507.5 MHz	2535.0 MHz	2562.5 MHz	
EUT without Power Reduction (P-Sensor NOT Triggered)										
7 / 15M	1	0	21.26	21.34	21.18	0	20.14	20.22	20.11	1
	1	37	21.24	21.32	21.16	0	20.12	20.20	20.09	1
	1	74	21.16	21.24	21.08	0	20.04	20.12	20.01	1
	36	0	20.29	20.37	20.21	1	19.17	19.25	19.14	2
	36	19	20.28	20.36	20.20	1	19.16	19.24	19.13	2
	36	39	20.26	20.34	20.18	1	19.14	19.22	19.11	2
	75	0	20.25	20.33	20.17	1	19.13	19.21	19.10	2
EUT with Power Reduction (P-Sensor Triggered)										
7 / 15M	1	0	16.19	16.78	16.27	0	16.16	16.75	16.24	0
	1	37	16.06	16.71	16.17	0	16.03	16.68	16.14	0
	1	74	16.08	16.43	16.09	0	16.05	16.40	16.06	0
	36	0	16.18	16.69	16.25	0	16.17	16.66	16.22	0
	36	19	16.16	16.48	16.21	0	16.13	16.45	16.18	0
	36	39	16.10	16.41	16.13	0	16.07	16.38	16.10	0
	75	0	16.17	16.71	16.22	0	16.14	16.68	16.19	0
EUT without Power Reduction (P-Sensor NOT Triggered)										
7 / 20M	1	0	21.37	21.45	21.29	0	20.25	20.33	20.17	1
	1	50	21.35	21.43	21.27	0	20.23	20.31	20.15	1
	1	99	21.27	21.35	21.19	0	20.15	20.23	20.07	1
	50	0	20.40	20.48	20.32	1	19.28	19.36	19.20	2
	50	25	20.39	20.47	20.31	1	19.27	19.35	19.19	2
	50	50	20.37	20.45	20.29	1	19.25	19.33	19.17	2
	100	0	20.36	20.44	20.28	1	19.24	19.32	19.16	2
EUT with Power Reduction (P-Sensor Triggered)										
7 / 20M	1	0	16.27	16.86	16.35	0	16.23	16.82	16.31	0
	1	50	16.14	16.79	16.25	0	16.10	16.75	16.21	0
	1	99	16.11	16.51	16.12	0	16.07	16.47	16.08	0
	50	0	16.23	16.77	16.28	0	16.19	16.73	16.24	0
	50	25	16.14	16.56	16.29	0	16.10	16.52	16.25	0
	50	50	16.08	16.49	16.11	0	16.04	16.45	16.07	0
	100	0	16.25	16.79	16.20	0	16.21	16.75	16.26	0

FCC SAR Test Report

Band / BW	RB Size	RB Offset	QPSK			3GPP MPR (dB)	16QAM			3GPP MPR (dB)
			Low CH 23017	Mid CH 23095	High CH 23173		Low CH 23017	Mid CH 23095	High CH 23173	
			699.7 MHz	707.5 MHz	715.3 MHz		699.7 MHz	707.5 MHz	715.3 MHz	
EUT without Power Reduction (P-Sensor NOT Triggered)										
12 / 1.4M	1	0	22.61	22.63	22.72	0	21.48	21.50	21.59	1
	1	2	22.55	22.57	22.66	0	21.42	21.44	21.53	1
	1	5	22.54	22.56	22.65	0	21.41	21.43	21.52	1
	3	0	22.41	22.43	22.52	0	21.28	21.30	21.39	1
	3	1	22.39	22.41	22.50	0	21.26	21.28	21.37	1
	3	3	22.37	22.39	22.48	0	21.24	21.26	21.35	1
	6	0	21.54	21.56	21.65	1	20.41	20.43	20.52	2
EUT with Power Reduction (P-Sensor Triggered)										
12 / 1.4M	1	0	20.72	20.69	20.76	0	20.67	20.64	20.71	0
	1	2	20.63	20.57	20.67	0	20.58	20.52	20.62	0
	1	5	20.57	20.55	20.61	0	20.52	20.50	20.56	0
	3	0	20.66	20.64	20.70	0	20.61	20.59	20.65	0
	3	1	20.65	20.59	20.69	0	20.60	20.54	20.64	0
	3	3	20.60	20.55	20.62	0	20.55	20.50	20.57	0
	6	0	20.64	20.58	20.67	0	20.59	20.53	20.62	0
Band / BW	RB Size	RB Offset	QPSK			3GPP MPR (dB)	16QAM			3GPP MPR (dB)
			Low CH 23025	Mid CH 23095	High CH 23165		Low CH 23025	Mid CH 23095	High CH 23165	
			700.5 MHz	707.5 MHz	714.5 MHz		700.5 MHz	707.5 MHz	714.5 MHz	
EUT without Power Reduction (P-Sensor NOT Triggered)										
12 / 3M	1	0	22.72	22.74	22.83	0	21.59	21.61	21.70	1
	1	7	22.66	22.68	22.77	0	21.53	21.55	21.64	1
	1	14	22.65	22.67	22.76	0	21.52	21.54	21.63	1
	8	0	21.67	21.69	21.78	1	20.54	20.56	20.65	2
	8	3	21.65	21.67	21.76	1	20.52	20.54	20.63	2
	8	7	21.63	21.65	21.74	1	20.50	20.52	20.61	2
	15	0	21.65	21.67	21.76	1	20.52	20.54	20.63	2
EUT with Power Reduction (P-Sensor Triggered)										
12 / 3M	1	0	20.80	20.77	20.84	0	20.76	20.73	20.80	0
	1	7	20.71	20.65	20.75	0	20.67	20.61	20.71	0
	1	14	20.65	20.63	20.69	0	20.61	20.59	20.65	0
	8	0	20.74	20.72	20.78	0	20.70	20.68	20.74	0
	8	3	20.73	20.67	20.77	0	20.69	20.63	20.73	0
	8	7	20.68	20.63	20.70	0	20.64	20.59	20.66	0
	15	0	20.72	20.66	20.75	0	20.68	20.62	20.71	0

FCC SAR Test Report

Band / BW	RB Size	RB Offset	QPSK			3GPP MPR (dB)	16QAM			3GPP MPR (dB)
			Low CH 23035	Mid CH 23095	High CH 23155		Low CH 23035	Mid CH 23095	High CH 23155	
			701.5 MHz	707.5 MHz	713.5 MHz		701.5 MHz	707.5 MHz	713.5 MHz	
EUT without Power Reduction (P-Sensor NOT Triggered)										
12 / 5M	1	0	22.81	22.83	22.92	0	21.68	21.70	21.79	1
	1	12	22.75	22.77	22.86	0	21.62	21.64	21.73	1
	1	24	22.74	22.76	22.85	0	21.61	21.63	21.72	1
	12	0	21.76	21.78	21.87	1	20.63	20.65	20.74	2
	12	6	21.74	21.76	21.85	1	20.61	20.63	20.72	2
	12	13	21.72	21.74	21.83	1	20.59	20.61	20.70	2
	25	0	21.74	21.76	21.85	1	20.61	20.63	20.72	2
EUT with Power Reduction (P-Sensor Triggered)										
12 / 5M	1	0	20.88	20.85	20.92	0	20.84	20.81	20.88	0
	1	12	20.79	20.73	20.83	0	20.75	20.69	20.79	0
	1	24	20.73	20.71	20.77	0	20.69	20.67	20.73	0
	12	0	20.82	20.80	20.86	0	20.78	20.76	20.82	0
	12	6	20.81	20.75	20.85	0	20.77	20.71	20.81	0
	12	13	20.76	20.71	20.78	0	20.72	20.67	20.74	0
	25	0	20.80	20.74	20.83	0	20.76	20.70	20.79	0
EUT without Power Reduction (P-Sensor NOT Triggered)										
12 / 10M	1	0	22.92	22.94	23.03	0	21.79	21.81	21.90	1
	1	24	22.86	22.88	22.97	0	21.73	21.75	21.84	1
	1	49	22.85	22.87	22.96	0	21.72	21.74	21.83	1
	25	0	21.87	21.89	21.98	1	20.74	20.76	20.85	2
	25	12	21.85	21.87	21.96	1	20.72	20.74	20.83	2
	25	25	21.83	21.85	21.94	1	20.70	20.72	20.81	2
	50	0	21.85	21.87	21.96	1	20.72	20.74	20.83	2
EUT with Power Reduction (P-Sensor Triggered)										
12 / 10M	1	0	20.91	20.88	20.95	0	20.87	20.84	20.91	0
	1	24	20.82	20.76	20.86	0	20.78	20.72	20.82	0
	1	49	20.76	20.74	20.80	0	20.72	20.70	20.76	0
	25	0	20.85	20.83	20.89	0	20.81	20.79	20.85	0
	25	12	20.84	20.78	20.88	0	20.80	20.74	20.84	0
	25	25	20.79	20.74	20.81	0	20.75	20.70	20.77	0
	50	0	20.83	20.77	20.86	0	20.79	20.73	20.82	0

FCC SAR Test Report

Band / BW	RB Size	RB Offset	QPSK			3GPP MPR (dB)	16QAM			3GPP MPR (dB)
			Low CH 23205	Mid CH 23230	High CH 23255		Low CH 23205	Mid CH 23230	High CH 23255	
			779.5 MHz	782.0 MHz	784.5 MHz		779.5 MHz	782.0 MHz	784.5 MHz	
EUT without Power Reduction (P-Sensor NOT Triggered)										
13 / 5M	1	0	22.09	22.80	22.73	0	21.04	21.68	21.61	1
	1	12	22.68	22.62	22.54	0	21.56	21.50	21.42	1
	1	24	22.71	22.65	22.57	0	21.59	21.53	21.45	1
	12	0	21.94	21.88	21.80	1	20.82	20.76	20.68	2
	12	6	21.84	21.78	21.70	1	20.72	20.66	20.58	2
	12	13	21.79	21.73	21.65	1	20.67	20.61	20.53	2
	25	0	21.80	21.74	21.66	1	20.68	20.62	20.54	2
EUT with Power Reduction (P-Sensor Triggered)										
13 / 5M	1	0	20.68	20.70	20.67	0	20.63	20.65	20.62	0
	1	12	20.55	20.57	20.54	0	20.50	20.52	20.49	0
	1	24	20.63	20.65	20.62	0	20.58	20.60	20.57	0
	12	0	20.66	20.68	20.65	0	20.61	20.63	20.60	0
	12	6	20.64	20.66	20.63	0	20.59	20.61	20.58	0
	12	13	20.45	20.47	20.44	0	20.40	20.42	20.39	0
	25	0	20.58	20.60	20.57	0	20.53	20.55	20.52	0
EUT without Power Reduction (P-Sensor NOT Triggered)										
Band / BW	RB Size	RB Offset	QPSK			3GPP MPR (dB)	16QAM			3GPP MPR (dB)
			Mid CH 23230				Mid CH 23230			
			782.0 MHz				782.0 MHz			
EUT without Power Reduction (P-Sensor NOT Triggered)										
13 / 10M	1	0	22.15			0	21.08			1
	1	24	22.95			0	21.83			1
	1	49	22.89			0	21.77			1
	25	0	21.94			1	20.82			2
	25	12	21.86			1	20.74			2
	25	25	21.81			1	20.69			2
	50	0	21.89			1	20.77			2
EUT with Power Reduction (P-Sensor Triggered)										
13 / 10M	1	0	20.74			0	20.72			0
	1	24	20.61			0	20.59			0
	1	49	20.69			0	20.67			0
	25	0	20.72			0	20.70			0
	25	12	20.70			0	20.68			0
	25	25	20.51			0	20.49			0
	50	0	20.64			0	20.62			0

FCC SAR Test Report

Band / BW	RB Size	RB Offset	QPSK			3GPP MPR (dB)	16QAM			3GPP MPR (dB)
			Low CH 26047	Mid CH 26365	High CH 26683		Low CH 26047	Mid CH 26365	High CH 26683	
			1850.7 MHz	1882.5 MHz	1914.3 MHz		1850.7 MHz	1882.5 MHz	1914.3 MHz	
EUT without Power Reduction (P-Sensor NOT Triggered)										
25 / 1.4M	1	0	22.39	22.36	22.34	0	21.28	21.25	21.23	1
	1	2	22.09	22.06	22.04	0	21.10	21.07	21.05	1
	1	5	22.07	22.04	22.01	0	21.05	21.02	21.01	1
	3	0	22.15	22.12	22.10	0	21.16	21.13	21.11	1
	3	1	22.12	22.09	22.07	0	21.13	21.10	21.08	1
	3	3	22.10	22.07	22.05	0	21.11	21.08	21.06	1
	6	0	21.14	21.11	21.09	1	20.15	20.12	20.10	2
EUT with Power Reduction (P-Sensor Triggered)										
25 / 1.4M	1	0	19.76	19.75	19.73	0	19.73	19.72	19.70	0
	1	2	19.74	19.73	19.62	0	19.71	19.70	19.59	0
	1	5	19.43	19.42	19.40	0	19.40	19.39	19.37	0
	3	0	19.75	19.74	19.72	0	19.72	19.71	19.69	0
	3	1	19.71	19.70	19.68	0	19.68	19.67	19.65	0
	3	3	19.72	19.71	19.69	0	19.69	19.68	19.66	0
	6	0	19.74	19.73	19.71	0	19.71	19.70	19.68	0

Band / BW	RB Size	RB Offset	QPSK			3GPP MPR (dB)	16QAM			3GPP MPR (dB)
			Low CH 26055	Mid CH 26365	High CH 26675		Low CH 26055	Mid CH 26365	High CH 26675	
			1851.5 MHz	1882.5 MHz	1913.5 MHz		1851.5 MHz	1882.5 MHz	1913.5 MHz	
EUT without Power Reduction (P-Sensor NOT Triggered)										
25 / 3M	1	0	22.52	22.49	22.47	0	21.41	21.38	21.36	1
	1	7	22.22	22.19	22.17	0	21.11	21.08	21.06	1
	1	14	22.17	22.14	22.12	0	21.06	21.03	21.01	1
	8	0	21.35	21.32	21.30	1	20.24	20.21	20.19	2
	8	3	21.32	21.29	21.27	1	20.21	20.18	20.16	2
	8	7	21.30	21.27	21.25	1	20.19	20.16	20.14	2
	15	0	21.27	21.24	21.22	1	20.16	20.13	20.11	2
EUT with Power Reduction (P-Sensor Triggered)										
25 / 3M	1	0	19.80	19.79	19.77	0	19.76	19.77	19.74	0
	1	7	19.78	19.77	19.66	0	19.74	19.75	19.63	0
	1	14	19.47	19.46	19.44	0	19.43	19.44	19.41	0
	8	0	19.79	19.78	19.76	0	19.75	19.76	19.73	0
	8	3	19.75	19.74	19.72	0	19.71	19.72	19.69	0
	8	7	19.76	19.75	19.73	0	19.72	19.73	19.70	0
	15	0	19.78	19.77	19.75	0	19.74	19.75	19.72	0

FCC SAR Test Report

Band / BW	RB Size	RB Offset	QPSK			3GPP MPR (dB)	16QAM			3GPP MPR (dB)
			Low CH 26065	Mid CH 26365	High CH 26665		Low CH 26065	Mid CH 26365	High CH 26665	
			1852.5 MHz	1882.5 MHz	1912.5 MHz		1852.5 MHz	1882.5 MHz	1912.5 MHz	
EUT without Power Reduction (P-Sensor NOT Triggered)										
25 / 5M	1	0	22.61	22.58	22.56	0	21.50	21.47	21.45	1
	1	12	22.31	22.28	22.26	0	21.20	21.17	21.15	1
	1	24	22.26	22.23	22.21	0	21.15	21.12	21.10	1
	12	0	21.44	21.41	21.39	1	20.33	20.30	20.28	2
	12	6	21.41	21.38	21.36	1	20.30	20.27	20.25	2
	12	13	21.39	21.36	21.34	1	20.28	20.25	20.23	2
	25	0	21.36	21.33	21.31	1	20.25	20.22	20.20	2
EUT with Power Reduction (P-Sensor Triggered)										
25 / 5M	1	0	19.83	19.82	19.80	0	19.80	19.79	19.77	0
	1	12	19.81	19.80	19.69	0	19.78	19.77	19.66	0
	1	24	19.50	19.49	19.47	0	19.47	19.46	19.44	0
	12	0	19.82	19.81	19.79	0	19.79	19.78	19.76	0
	12	6	19.78	19.77	19.75	0	19.75	19.74	19.72	0
	12	13	19.79	19.78	19.76	0	19.76	19.75	19.73	0
	25	0	19.81	19.80	19.78	0	19.78	19.77	19.75	0

Band / BW	RB Size	RB Offset	QPSK			3GPP MPR (dB)	16QAM			3GPP MPR (dB)
			Low CH 26090	Mid CH 26365	High CH 26640		Low CH 26090	Mid CH 26365	High CH 26640	
			1855.0 MHz	1882.5 MHz	1910.0 MHz		1855.0 MHz	1882.5 MHz	1910.0 MHz	
EUT without Power Reduction (P-Sensor NOT Triggered)										
25 / 10M	1	0	22.73	22.70	22.68	0	21.62	21.59	21.57	1
	1	24	22.43	22.40	22.38	0	21.32	21.29	21.27	1
	1	49	22.38	22.35	22.33	0	21.27	21.24	21.22	1
	25	0	21.56	21.53	21.51	1	20.45	20.42	20.40	2
	25	12	21.53	21.50	21.48	1	20.42	20.39	20.37	2
	25	25	21.51	21.48	21.46	1	20.40	20.37	20.35	2
	50	0	21.48	21.45	21.43	1	20.37	20.34	20.32	2
EUT with Power Reduction (P-Sensor Triggered)										
25 / 10M	1	0	19.87	19.86	19.84	0	19.84	19.83	19.81	0
	1	24	19.85	19.84	19.73	0	19.82	19.81	19.70	0
	1	49	19.54	19.53	19.51	0	19.51	19.50	19.48	0
	25	0	19.86	19.85	19.83	0	19.83	19.82	19.80	0
	25	12	19.82	19.81	19.79	0	19.79	19.78	19.76	0
	25	25	19.83	19.82	19.80	0	19.80	19.79	19.77	0
	50	0	19.85	19.84	19.82	0	19.82	19.81	19.79	0

FCC SAR Test Report

Band / BW	RB Size	RB Offset	QPSK			3GPP MPR (dB)	16QAM			3GPP MPR (dB)
			Low CH 26115	Mid CH 26365	High CH 26615		Low CH 26115	Mid CH 26365	High CH 26615	
			1857.5 MHz	1882.5 MHz	1907.5 MHz		1857.5 MHz	1882.5 MHz	1907.5 MHz	
EUT without Power Reduction (P-Sensor NOT Triggered)										
25 / 15M	1	0	22.82	22.79	22.77	0	21.71	21.68	21.66	1
	1	37	22.52	22.49	22.47	0	21.41	21.38	21.36	1
	1	74	22.47	22.44	22.42	0	21.36	21.33	21.31	1
	36	0	21.65	21.62	21.60	1	20.54	20.51	20.49	2
	36	19	21.62	21.59	21.57	1	20.51	20.48	20.46	2
	36	39	21.60	21.57	21.55	1	20.49	20.46	20.44	2
	75	0	21.57	21.54	21.52	1	20.46	20.43	20.41	2
EUT with Power Reduction (P-Sensor Triggered)										
25 / 15M	1	0	19.89	19.88	19.86	0	19.86	19.85	19.83	0
	1	37	19.87	19.86	19.75	0	19.84	19.83	19.72	0
	1	74	19.56	19.55	19.53	0	19.53	19.52	19.50	0
	36	0	19.88	19.87	19.85	0	19.85	19.84	19.82	0
	36	19	19.84	19.83	19.81	0	19.81	19.80	19.78	0
	36	39	19.85	19.84	19.82	0	19.82	19.81	19.79	0
	75	0	19.87	19.86	19.84	0	19.84	19.83	19.81	0

Band / BW	RB Size	RB Offset	QPSK			3GPP MPR (dB)	16QAM			3GPP MPR (dB)
			Low CH 26140	Mid CH 26365	High CH 26590		Low CH 26140	Mid CH 26365	High CH 26590	
			1860.0 MHz	1882.5 MHz	1905.0 MHz		1860.0 MHz	1882.5 MHz	1905.0 MHz	
EUT without Power Reduction (P-Sensor NOT Triggered)										
25 / 20M	1	0	22.93	22.90	22.88	0	21.82	21.79	21.77	1
	1	50	22.63	22.60	22.58	0	21.52	21.49	21.47	1
	1	99	22.58	22.55	22.53	0	21.47	21.44	21.42	1
	50	0	21.76	21.73	21.71	1	20.65	20.62	20.60	2
	50	25	21.73	21.70	21.68	1	20.62	20.59	20.57	2
	50	50	21.71	21.68	21.66	1	20.60	20.57	20.55	2
	100	0	21.68	21.65	21.63	1	20.57	20.54	20.52	2
EUT with Power Reduction (P-Sensor Triggered)										
25 / 20M	1	0	19.94	19.93	19.91	0	19.91	19.90	19.88	0
	1	50	19.92	19.91	19.80	0	19.89	19.88	19.77	0
	1	99	19.61	19.60	19.58	0	19.58	19.57	19.55	0
	50	0	19.93	19.92	19.90	0	19.90	19.89	19.87	0
	50	25	19.89	19.88	19.86	0	19.86	19.85	19.83	0
	50	50	19.90	19.89	19.87	0	19.87	19.86	19.84	0
	100	0	19.92	19.91	19.89	0	19.89	19.88	19.86	0

FCC SAR Test Report

Band / BW	RB Size	RB Offset	QPSK			3GPP MPR (dB)	16QAM			3GPP MPR (dB)
			Low CH 26697	Mid CH 26865	High CH 27033		Low CH 26697	Mid CH 26865	High CH 27033	
			814.7 MHz	831.5 MHz	848.3 MHz		814.7 MHz	831.5 MHz	848.3 MHz	
EUT without Power Reduction (P-Sensor NOT Triggered)										
26 / 1.4M	1	0	22.38	22.44	22.46	0	21.29	21.35	21.37	1
	1	2	22.24	22.30	22.32	0	21.15	21.21	21.23	1
	1	5	22.30	22.36	22.38	0	21.21	21.27	21.29	1
	3	0	22.30	22.36	22.38	0	21.21	21.27	21.29	1
	3	1	22.26	22.32	22.34	0	21.17	21.23	21.25	1
	3	3	22.27	22.33	22.35	0	21.18	21.24	21.26	1
	6	0	21.41	21.47	21.49	1	20.32	20.38	20.40	2
EUT with Power Reduction (P-Sensor Triggered)										
26 / 1.4M	1	0	20.89	20.69	21.11	0	20.84	20.64	21.06	0
	1	2	20.47	20.34	20.69	0	20.42	20.29	20.64	0
	1	5	20.42	20.22	20.61	0	20.37	20.17	20.56	0
	3	0	20.61	20.50	20.83	0	20.56	20.45	20.78	0
	3	1	20.58	20.35	20.81	0	20.53	20.30	20.76	0
	3	3	20.50	20.30	20.70	0	20.45	20.25	20.65	0
	6	0	20.53	20.33	20.75	0	20.48	20.28	20.70	0

Band / BW	RB Size	RB Offset	QPSK			3GPP MPR (dB)	16QAM			3GPP MPR (dB)
			Low CH 26705	Mid CH 26865	High CH 27025		Low CH 26705	Mid CH 26865	High CH 27025	
			815.5 MHz	831.5 MHz	847.5 MHz		815.5 MHz	831.5 MHz	847.5 MHz	
EUT without Power Reduction (P-Sensor NOT Triggered)										
26 / 3M	1	0	22.51	22.57	22.59	0	21.42	21.48	21.50	1
	1	7	22.37	22.43	22.45	0	21.28	21.34	21.36	1
	1	14	22.43	22.49	22.51	0	21.34	21.40	21.42	1
	8	0	21.56	21.62	21.64	1	20.47	20.53	20.55	2
	8	3	21.52	21.58	21.60	1	20.43	20.49	20.51	2
	8	7	21.53	21.59	21.61	1	20.44	20.50	20.52	2
	15	0	21.54	21.60	21.62	1	20.45	20.51	20.53	2
EUT with Power Reduction (P-Sensor Triggered)										
26 / 3M	1	0	20.94	20.74	21.16	0	20.89	20.69	21.11	0
	1	7	20.52	20.39	20.74	0	20.47	20.34	20.69	0
	1	14	20.47	20.27	20.66	0	20.42	20.22	20.61	0
	8	0	20.66	20.55	20.88	0	20.61	20.50	20.83	0
	8	3	20.63	20.40	20.86	0	20.58	20.35	20.81	0
	8	7	20.55	20.35	20.75	0	20.50	20.30	20.70	0
	15	0	20.58	20.38	20.80	0	20.53	20.33	20.75	0

FCC SAR Test Report

Band / BW	RB Size	RB Offset	QPSK			3GPP MPR (dB)	16QAM			3GPP MPR (dB)
			Low CH 26715	Mid CH 26865	High CH 27015		Low CH 26715	Mid CH 26865	High CH 27015	
			816.5 MHz	831.5 MHz	846.5 MHz		816.5 MHz	831.5 MHz	846.5 MHz	
EUT without Power Reduction (P-Sensor NOT Triggered)										
26 / 5M	1	0	22.62	22.68	22.70	0	21.53	21.59	21.61	1
	1	12	22.48	22.54	22.56	0	21.39	21.45	21.47	1
	1	24	22.54	22.60	22.62	0	21.45	21.51	21.53	1
	12	0	21.67	21.73	21.75	1	20.58	20.64	20.66	2
	12	6	21.63	21.69	21.71	1	20.54	20.60	20.62	2
	12	13	21.64	21.70	21.72	1	20.55	20.61	20.63	2
	25	0	21.65	21.71	21.73	1	20.56	20.62	20.64	2
EUT with Power Reduction (P-Sensor Triggered)										
26 / 5M	1	0	21.00	20.80	21.22	0	20.95	20.75	21.17	0
	1	12	20.58	20.45	20.80	0	20.53	20.40	20.75	0
	1	24	20.53	20.33	20.72	0	20.48	20.28	20.67	0
	12	0	20.72	20.61	20.94	0	20.67	20.56	20.89	0
	12	6	20.69	20.46	20.92	0	20.64	20.41	20.87	0
	12	13	20.61	20.41	20.81	0	20.56	20.36	20.76	0
	25	0	20.64	20.44	20.86	0	20.59	20.39	20.81	0

Band / BW	RB Size	RB Offset	QPSK			3GPP MPR (dB)	16QAM			3GPP MPR (dB)
			Low CH 26740	Mid CH 26865	High CH 26990		Low CH 26740	Mid CH 26865	High CH 26990	
			819.0 MHz	831.5 MHz	844.0 MHz		819.0 MHz	831.5 MHz	844.0 MHz	
EUT without Power Reduction (P-Sensor NOT Triggered)										
26 / 10M	1	0	22.71	22.77	22.79	0	21.62	21.68	21.70	1
	1	24	22.57	22.63	22.65	0	21.48	21.54	21.56	1
	1	49	22.63	22.69	22.71	0	21.54	21.60	21.62	1
	25	0	21.76	21.82	21.84	1	20.67	20.73	20.75	2
	25	12	21.72	21.78	21.80	1	20.63	20.69	20.71	2
	25	25	21.73	21.79	21.81	1	20.64	20.70	20.72	2
	50	0	21.74	21.80	21.82	1	20.65	20.71	20.73	2
EUT with Power Reduction (P-Sensor Triggered)										
26 / 10M	1	0	21.03	20.83	21.25	0	20.98	20.78	21.20	0
	1	24	20.61	20.48	20.83	0	20.56	20.43	20.78	0
	1	49	20.56	20.36	20.75	0	20.51	20.31	20.70	0
	25	0	20.75	20.64	20.97	0	20.70	20.59	20.92	0
	25	12	20.72	20.49	20.95	0	20.67	20.44	20.90	0
	25	25	20.64	20.44	20.84	0	20.59	20.39	20.79	0
	50	0	20.67	20.47	20.89	0	20.62	20.42	20.84	0

FCC SAR Test Report

Band / BW	RB Size	RB Offset	QPSK			3GPP MPR (dB)	16QAM			3GPP MPR (dB)
			Low CH 26765	Mid CH 26865	High CH 26965		Low CH 26765	Mid CH 26865	High CH 26965	
			821.5 MHz	831.5 MHz	841.5 MHz		821.5 MHz	831.5 MHz	841.5 MHz	
EUT without Power Reduction (P-Sensor NOT Triggered)										
26 / 15M	1	0	22.83	22.89	22.91	0	21.74	21.80	21.82	1
	1	37	22.69	22.75	22.77	0	21.60	21.66	21.68	1
	1	74	22.75	22.81	22.83	0	21.66	21.72	21.74	1
	36	0	21.88	21.94	21.96	1	20.79	20.85	20.87	2
	36	19	21.84	21.90	21.92	1	20.75	20.81	20.83	2
	36	39	21.85	21.91	21.93	1	20.76	20.82	20.84	2
	75	0	21.86	21.92	21.94	1	20.77	20.83	20.85	2
EUT with Power Reduction (P-Sensor Triggered)										
26 / 15M	1	0	21.07	20.87	21.29	0	21.02	20.82	21.24	0
	1	37	20.65	20.52	20.87	0	20.60	20.47	20.82	0
	1	74	20.60	20.40	20.79	0	20.55	20.35	20.74	0
	36	0	20.79	20.68	21.01	0	20.74	20.63	20.96	0
	36	19	20.76	20.53	20.99	0	20.71	20.48	20.94	0
	36	39	20.68	20.48	20.88	0	20.63	20.43	20.83	0
	75	0	20.71	20.51	20.93	0	20.66	20.46	20.88	0

Band / BW	RB Size	RB Offset	QPSK					3GPP MPR (dB)	16QAM					3GPP MPR (dB)
			L-CH 39675	M-CH 40148	M-CH 40620	M-CH 41093	H-CH 41565		L-CH 39675	M-CH 40148	M-CH 40620	M-CH 41093	H-CH 41565	
			2498.5 MHz	2545.8 MHz	2593.0 MHz	2640.3 MHz	2687.5 MHz		2498.5 MHz	2545.8 MHz	2593.0 MHz	2640.3 MHz	2687.5 MHz	
EUT without Power Reduction (P-Sensor NOT Triggered)														
41 / 5M	1	0	21.46	21.49	21.48	21.30	21.38	0	20.33	20.36	20.35	20.17	20.25	1
	1	12	21.33	21.36	21.35	21.17	21.25	0	20.20	20.23	20.22	20.04	20.12	1
	1	24	21.12	21.15	21.14	21.02	21.04	0	20.08	20.11	20.10	20.02	20.01	1
	12	0	20.43	20.46	20.45	20.27	20.35	1	19.30	19.33	19.32	19.14	19.22	2
	12	6	20.40	20.43	20.42	20.24	20.32	1	19.27	19.30	19.29	19.11	19.19	2
	12	13	20.21	20.24	20.23	20.05	20.13	1	19.18	19.21	19.20	19.02	19.10	2
	25	0	20.29	20.32	20.31	20.13	20.21	1	19.26	19.29	19.28	19.10	19.18	2
EUT with Power Reduction (P-Sensor Triggered)														
41 / 5M	1	0	18.33	18.74	18.56	18.37	18.34	0	18.30	18.71	18.53	18.34	18.31	0
	1	12	18.24	18.70	18.51	18.32	18.30	0	18.27	18.67	18.48	18.29	18.27	0
	1	24	18.05	18.46	18.35	18.11	18.07	0	18.04	18.43	18.32	18.08	18.04	0
	12	0	18.31	18.73	18.54	18.41	18.34	0	18.31	18.70	18.51	18.38	18.31	0
	12	6	18.26	18.69	18.53	18.32	18.30	0	18.27	18.66	18.50	18.29	18.27	0
	12	13	18.19	18.60	18.44	18.23	18.21	0	18.18	18.57	18.41	18.20	18.18	0
	25	0	18.30	18.72	18.61	18.34	18.32	0	18.29	18.69	18.58	18.31	18.29	0

FCC SAR Test Report

Band / BW	RB Size	RB Offset	QPSK					3GPP MPR (dB)	16QAM					3GPP MPR (dB)
			L-CH 39700	M-CH 40160	M-CH 40620	M-CH 41080	H-CH 41540		L-CH 39700	M-CH 40160	M-CH 40620	M-CH 41080	H-CH 41540	
			2501.0 MHz	2547.0 MHz	2593.0 MHz	2639.0 MHz	2685.0 MHz		2501.0 MHz	2547.0 MHz	2593.0 MHz	2639.0 MHz	2685.0 MHz	
EUT without Power Reduction (P-Sensor NOT Triggered)														
41 / 10M	1	0	21.57	21.60	21.59	21.41	21.49	0	20.44	20.47	20.46	20.28	20.36	1
	1	24	21.44	21.47	21.46	21.28	21.36	0	20.31	20.34	20.33	20.15	20.23	1
	1	49	21.16	21.19	21.18	21.06	21.08	0	20.11	20.14	20.13	20.04	20.03	1
	25	0	20.54	20.57	20.56	20.38	20.46	1	19.41	19.44	19.43	19.25	19.33	2
	25	12	20.51	20.54	20.53	20.35	20.43	1	19.38	19.41	19.40	19.22	19.30	2
	25	25	20.32	20.35	20.34	20.16	20.24	1	19.22	19.25	19.24	19.06	19.14	2
	50	0	20.40	20.43	20.42	20.24	20.32	1	19.30	19.33	19.32	19.14	19.22	2
EUT with Power Reduction (P-Sensor Triggered)														
41 / 10M	1	0	18.35	18.76	18.58	18.39	18.36	0	18.32	18.73	18.55	18.36	18.33	0
	1	24	18.26	18.72	18.53	18.34	18.32	0	18.29	18.69	18.50	18.31	18.29	0
	1	49	18.07	18.48	18.37	18.13	18.09	0	18.06	18.45	18.34	18.10	18.06	0
	25	0	18.33	18.75	18.56	18.43	18.36	0	18.33	18.72	18.53	18.40	18.33	0
	25	12	18.28	18.71	18.55	18.34	18.32	0	18.29	18.68	18.52	18.31	18.29	0
	25	25	18.21	18.62	18.46	18.25	18.23	0	18.20	18.59	18.43	18.22	18.20	0
	50	0	18.32	18.74	18.63	18.36	18.34	0	18.31	18.71	18.60	18.33	18.31	0
EUT without Power Reduction (P-Sensor NOT Triggered)														
41 / 15M	1	0	21.66	21.69	21.68	21.50	21.58	0	20.53	20.56	20.55	20.37	20.45	1
	1	37	21.53	21.56	21.55	21.37	21.45	0	20.40	20.43	20.42	20.24	20.32	1
	1	74	21.25	21.28	21.27	21.13	21.17	0	20.15	20.18	20.17	20.05	20.07	1
	36	0	20.63	20.66	20.65	20.47	20.55	1	19.50	19.53	19.52	19.34	19.42	2
	36	19	20.60	20.63	20.62	20.44	20.52	1	19.47	19.50	19.49	19.31	19.39	2
	36	39	20.41	20.44	20.43	20.25	20.33	1	19.28	19.31	19.30	19.12	19.20	2
	75	0	20.49	20.52	20.51	20.33	20.41	1	19.36	19.39	19.38	19.20	19.28	2
EUT with Power Reduction (P-Sensor Triggered)														
41 / 15M	1	0	18.38	18.79	18.61	18.42	18.39	0	18.35	18.76	18.58	18.39	18.36	0
	1	37	18.29	18.75	18.56	18.37	18.35	0	18.32	18.72	18.53	18.34	18.32	0
	1	74	18.10	18.51	18.40	18.16	18.12	0	18.09	18.48	18.37	18.13	18.09	0
	36	0	18.36	18.78	18.59	18.46	18.39	0	18.36	18.75	18.56	18.43	18.36	0
	36	19	18.31	18.74	18.58	18.37	18.35	0	18.32	18.71	18.55	18.34	18.32	0
	36	39	18.24	18.65	18.49	18.28	18.26	0	18.23	18.62	18.46	18.25	18.23	0
	75	0	18.35	18.77	18.66	18.39	18.37	0	18.34	18.74	18.63	18.36	18.34	0

FCC SAR Test Report

Band / BW	RB Size	RB Offset	QPSK					3GPP MPR (dB)	16QAM					3GPP MPR (dB)
			L-CH 39750	M-CH 40185	M-CH 40620	M-CH 41055	H-CH 41490		L-CH 39750	M-CH 40185	M-CH 40620	M-CH 41055	H-CH 41490	
			2506.0 MHz	2549.5 MHz	2593.0 MHz	2636.5 MHz	2680.0 MHz		2506.0 MHz	2549.5 MHz	2593.0 MHz	2636.5 MHz	2680.0 MHz	
EUT without Power Reduction (P-Sensor NOT Triggered)														
41 / 20M	1	0	21.79	21.82	21.81	21.63	21.71	0	20.66	20.69	20.68	20.50	20.58	1
	1	50	21.66	21.69	21.68	21.50	21.58	0	20.53	20.56	20.55	20.37	20.45	1
	1	99	21.31	21.34	21.33	21.15	21.23	0	20.18	20.21	20.20	20.08	20.10	1
	50	0	20.76	20.79	20.78	20.60	20.68	1	19.63	19.66	19.65	19.47	19.55	2
	50	25	20.73	20.76	20.75	20.57	20.65	1	19.60	19.63	19.62	19.44	19.52	2
	50	50	20.54	20.57	20.56	20.38	20.46	1	19.41	19.44	19.43	19.25	19.33	2
	100	0	20.62	20.65	20.64	20.46	20.54	1	19.49	19.52	19.51	19.33	19.41	2
EUT with Power Reduction (P-Sensor Triggered)														
41 / 20M	1	0	18.42	18.83	18.65	18.46	18.43	0	18.39	18.80	18.62	18.43	18.40	0
	1	50	18.33	18.79	18.60	18.41	18.39	0	18.30	18.76	18.57	18.38	18.36	0
	1	99	18.14	18.55	18.44	18.20	18.16	0	18.11	18.52	18.41	18.17	18.13	0
	50	0	18.40	18.82	18.63	18.50	18.43	0	18.37	18.79	18.60	18.47	18.40	0
	50	25	18.35	18.78	18.62	18.41	18.39	0	18.32	18.75	18.59	18.38	18.36	0
	50	50	18.28	18.69	18.53	18.32	18.30	0	18.25	18.66	18.50	18.29	18.27	0
	100	0	18.39	18.81	18.70	18.43	18.41	0	18.36	18.78	18.67	18.40	18.38	0

WLAN (8265NGW)

<WLAN 2.4G>

Mode	802.11b				
Channel / Frequency (MHz)	1 (2412)	6 (2437)	11 (2462)	12 (2467)	13 (2472)
Average Power (Ant-0)	11.41	11.76	11.57	11.54	11.08
Average Power (Ant-1)	11.41	11.76	11.57	11.56	11.09
2Tx Average Power (Ant-0)	11.11	11.77	11.63	11.67	11.02
2Tx Average Power (Ant-1)	11.93	11.88	12.00	11.34	10.58
2Tx Average Power (Ant-0 + Ant-1)	14.55	14.84	14.83	14.52	13.82

<WLAN 5.3G>

Mode	802.11ac (VHT80)
Channel / Frequency (MHz)	58 (5290)
Average Power (Ant-0)	9.65
Average Power (Ant-1)	9.98
2Tx Average Power (Ant-0)	9.46
2Tx Average Power (Ant-1)	9.85
2Tx Average Power (Ant-0 + Ant-1)	12.67

<WLAN 5.6G>

Mode	802.11ac (VHT80)	
Channel / Frequency (MHz)	106 (5530)	122 (5610)
Average Power (Ant-0)	9.90	9.48
Average Power (Ant-1)	10.01	9.75
2Tx Average Power (Ant-0)	9.36	9.63
2Tx Average Power (Ant-1)	10.22	10.14
2Tx Average Power (Ant-0 + Ant-1)	12.82	12.90

FCC SAR Test Report

<WLAN 5.8G>

Mode Channel / Frequency (MHz)	802.11n (HT40)	
	151 (5755)	159 (5795)
Average Power (Ant-0)	9.48	9.34
Average Power (Ant-1)	9.47	9.59
2Tx Average Power (Ant-0)	9.15	9.31
2Tx Average Power (Ant-1)	10.36	10.29
2Tx Average Power (Ant-0 + Ant-1)	12.81	12.84

<Bluetooth>

Mode Channel / Frequency (MHz)	Bluetooth		
	0 (2402)	39 (2441)	78 (2480)
Average Power	5.08	5.14	5.37

4.7 SAR Testing Results

4.7.1 SAR Test Reduction Considerations

<KDB 447498 D01, General RF Exposure Guidance>

Testing of other required channels within the operating mode of a frequency band is not required when the reported SAR for the mid-band or highest output power channel is:

- (1) ≤ 0.8 W/kg or 2.0 W/kg, for 1-g or 10-g respectively, when the transmission band is ≤ 100 MHz
- (2) ≤ 0.6 W/kg or 1.5 W/kg, for 1-g or 10-g respectively, when the transmission band is between 100 MHz and 200 MHz
- (3) ≤ 0.4 W/kg or 1.0 W/kg, for 1-g or 10-g respectively, when the transmission band is ≥ 200 MHz

<KDB 941225 D01, 3G SAR Measurement Procedures>

The mode tested for SAR is referred to as the primary mode. The equivalent modes considered for SAR test reduction are denoted as secondary modes. Both primary and secondary modes must be in the same frequency band. When the maximum output power and tune-up tolerance specified for production units in a secondary mode is $\leq 1/4$ dB higher than the primary mode or when the highest reported SAR of the primary mode is scaled by the ratio of specified maximum output power and tune-up tolerance of secondary to primary mode and the adjusted SAR is ≤ 1.2 W/kg, SAR measurement is not required for the secondary mode.

<KDB 941225 D05, SAR Evaluation Considerations for LTE Devices>

(1) QPSK with 1 RB and 50% RB allocation

Start with the largest channel bandwidth and measure SAR, using the RB offset and required test channel combination with the highest maximum output power among RB offsets at the upper edge, middle and lower edge of each required test channel. When the reported SAR is ≤ 0.8 W/kg, testing of the remaining RB offset configurations and required test channels is not required; otherwise, SAR is required for the remaining required test channels and only for the RB offset configuration with the highest output power for that channel. When the reported SAR of a required test channel is > 1.45 W/kg, SAR is required for all three RB offset configurations for that required test channel.

(2) QPSK with 100% RB allocation

SAR is not required when the highest maximum output power for 100% RB allocation is less than the highest maximum output power in 50% and 1 RB allocations and the highest reported SAR for 1 RB and 50% RB allocation are ≤ 0.8 W/kg. Otherwise, SAR is measured for the highest output power channel; and if the reported SAR is > 1.45 W/kg, the remaining required test channels must also be tested.

(3) Higher order modulations

SAR is required only when the highest maximum output power for the configuration in the higher order modulation is $> 1/2$ dB higher than the same configuration in QPSK or when the reported SAR for the QPSK configuration is > 1.45 W/kg.

(4) Other channel bandwidth

SAR is required when the highest maximum output power of the smaller channel bandwidth is $> 1/2$ dB higher than the equivalent channel configurations in the largest channel bandwidth configuration or the reported SAR of a configuration for the largest channel bandwidth is > 1.45 W/kg.

<KDB 248227 D01, SAR Guidance for Wi-Fi Transmitters>

- (1) For handsets operating next to ear, hotspot mode or mini-tablet configurations, the initial test position procedures were applied. The test position with the highest extrapolated peak SAR will be used as the initial test position. When the reported SAR of initial test position is ≤ 0.4 W/kg, SAR testing for remaining test positions is not required. Otherwise, SAR is evaluated at the subsequent highest peak SAR positions until the reported SAR result is ≤ 0.8 W/kg or all test positions are measured.
- (2) For WLAN 2.4 GHz, the highest measured maximum output power channel for DSSS was selected for SAR measurement. When the reported SAR is ≤ 0.8 W/kg, no further SAR testing is required. Otherwise, SAR is evaluated at the next highest measured output power channel. When any reported SAR is > 1.2 W/kg, SAR is required for the third channel. For OFDM modes (802.11g/n), SAR is not required when the highest reported SAR for DSSS is adjusted by the ratio of OFDM to DSSS specified maximum output power and it is ≤ 1.2 W/kg.
- (3) For WLAN 5 GHz, the initial test configuration was selected according to the transmission mode with the highest maximum output power. When the reported SAR of initial test configuration is > 0.8 W/kg, SAR is required for the subsequent highest measured output power channel until the reported SAR result is ≤ 1.2 W/kg or all required channels are measured. For other transmission modes, SAR is not required when the highest reported SAR for initial test configuration is adjusted by the ratio of subsequent test configuration to initial test configuration specified maximum output power and it is ≤ 1.2 W/kg.
- (4) For WLAN MIMO mode, the power-based standalone SAR test exclusion or the sum of SAR provision in KDB 447498 to determine simultaneous transmission SAR test exclusion should be applied. Otherwise, SAR for MIMO mode will be measured with all applicable antennas transmitting simultaneously at the specified maximum output power of MIMO operation.

FCC SAR Test Report

4.7.2 SAR Results for Body Exposure Condition

WWAN (EM7455)

Tablet PC Mode

Plot No.	Band	Mode	Test Position	Separation Distance (cm)	Ch.	EUT Configurations	Power Reduction	Battery	Max. Tune-up Power (dBm)	Measured Conducted Power (dBm)	Scaling Factor	Power Drift (dB)	Measured SAR-1g (W/kg)	Scaled SAR-1g (W/kg)
	WCDMA II	RMC12.2K	Rear Face	0	9262	1	w/o	1	24.0	23.32	1.17	-0.04	0.873	1.02
	WCDMA II	RMC12.2K	Rear Face	0	9400	1	w/o	1	24.0	23.17	1.21	0.03	0.831	1.01
	WCDMA II	RMC12.2K	Rear Face	0	9538	1	w/o	1	24.0	23.22	1.20	0.01	0.899	1.08
	WCDMA II	RMC12.2K	Left Side	0	9262	1	w/o	1	24.0	23.32	1.17	0.19	0.151	0.18
	WCDMA II	RMC12.2K	Right Side	0	9262	1	w/o	1	24.0	23.32	1.17	-0.07	0.296	0.35
	WCDMA II	RMC12.2K	Top Side	0	9262	1	w	1	20.0	19.76	1.06	0.07	0.56	0.59
	WCDMA II	RMC12.2K	Top Side	1.2	9262	1	w/o	1	24.0	23.32	1.17	0.09	0.528	0.62
	WCDMA II	RMC12.2K	Bottom Side	0	9262	1	w/o	1	24.0	23.32	1.17	0.14	0.095	0.11
	WCDMA II	RMC12.2K	Rear Face	0	9538	1	w/o	2	24.0	23.22	1.20	0.01	0.807	0.97
	WCDMA II	RMC12.2K	Rear Face	0	9262	1	w/o	2	24.0	23.32	1.17	0.19	0.782	0.91
	WCDMA II	RMC12.2K	Rear Face	0	9400	1	w/o	2	24.0	23.17	1.21	-0.13	0.748	0.91
01	WCDMA II	RMC12.2K	Rear Face	0	9538	2	w/o	1	24.0	23.22	1.20	-0.11	1.11	1.33
	WCDMA II	RMC12.2K	Rear Face	0	9538	2	w/o	1	24.0	23.22	1.20	0.01	1.09	1.30
	WCDMA II	RMC12.2K	Rear Face	0	9262	2	w/o	1	24.0	23.32	1.17	0.19	1.09	1.27
	WCDMA II	RMC12.2K	Rear Face	0	9400	2	w/o	1	24.0	23.17	1.21	-0.13	1.07	1.30
	WCDMA II	HSDPA Subtest-1	Rear Face	0	9262	2	w/o	1	24.0	22.79	1.32	0.07	0.682	0.90
	WCDMA II	HSDPA Subtest-1	Rear Face	0	9400	2	w/o	1	24.0	22.55	1.40	-0.18	0.676	0.94
	WCDMA II	HSDPA Subtest-1	Rear Face	0	9538	2	w/o	1	24.0	22.65	1.36	-0.01	0.782	1.07
	WCDMA II	HSUPA Subtest-5	Rear Face	0	9262	2	w/o	1	24.0	22.63	1.37	-0.11	0.696	0.95
	WCDMA II	HSUPA Subtest-5	Rear Face	0	9400	2	w/o	1	24.0	22.50	1.41	-0.17	0.671	0.95
	WCDMA II	HSUPA Subtest-5	Rear Face	0	9538	2	w/o	1	24.0	22.56	1.39	0.18	0.791	1.10
	WCDMA IV	RMC12.2K	Left Side	0	1513	1	w/o	1	24.0	23.14	1.22	0.17	0.082	0.10
	WCDMA IV	RMC12.2K	Right Side	0	1513	1	w/o	1	24.0	23.14	1.22	0.01	0.308	0.38
	WCDMA IV	RMC12.2K	Top Side	0	1513	1	w	1	19.0	18.70	1.07	-0.06	0.710	0.76
	WCDMA IV	RMC12.2K	Top Side	1.2	1513	1	w/o	1	24.0	23.14	1.22	-0.08	0.549	0.67
	WCDMA IV	RMC12.2K	Bottom Side	0	1513	1	w/o	1	24.0	23.14	1.22	0.03	0.031	0.04
	WCDMA IV	RMC12.2K	Rear Face	0	1312	1	w/o	2	24.0	23.06	1.24	0.1	0.806	1.00
	WCDMA IV	RMC12.2K	Rear Face	0	1413	1	w/o	2	24.0	23.08	1.24	0.04	0.775	0.96
	WCDMA IV	RMC12.2K	Rear Face	0	1513	1	w/o	2	24.0	23.14	1.22	0.02	0.792	0.97
	WCDMA IV	RMC12.2K	Rear Face	0	1312	2	w/o	1	24.0	23.06	1.24	0.04	1.03	1.28
02	WCDMA IV	RMC12.2K	Rear Face	0	1413	2	w/o	1	24.0	23.08	1.24	-0.1	1.08	1.33
	WCDMA IV	RMC12.2K	Rear Face	0	1413	2	w/o	1	24.0	23.08	1.24	-0.03	1.06	1.31
	WCDMA IV	RMC12.2K	Rear Face	0	1513	2	w/o	1	24.0	23.14	1.22	0.16	1.07	1.30
	WCDMA IV	HSDPA Subtest-1	Rear Face	0	1513	2	w/o	1	24.0	22.71	1.35	-0.15	0.859	1.16
	WCDMA IV	HSDPA Subtest-1	Rear Face	0	1312	2	w/o	1	24.0	22.60	1.38	-0.12	0.790	1.09
	WCDMA IV	HSDPA Subtest-1	Rear Face	0	1413	2	w/o	1	24.0	22.64	1.37	-0.13	0.856	1.17
	WCDMA IV	HSUPA Subtest-1	Rear Face	0	1513	2	w/o	1	24.0	22.84	1.31	-0.1	0.849	1.11
	WCDMA IV	HSUPA Subtest-1	Rear Face	0	1312	2	w/o	1	24.0	22.73	1.34	-0.12	0.809	1.08
	WCDMA IV	HSUPA Subtest-1	Rear Face	0	1413	2	w/o	1	24.0	22.80	1.32	-0.13	0.868	1.14

FCC SAR Test Report

Plot No.	Band	Mode	Test Position	Separation Distance (cm)	Ch.	EUT Configurations	Power Reduction	Battery	Max. Tune-up Power (dBm)	Measured Conducted Power (dBm)	Scaling Factor	Power Drift (dB)	Measured SAR-1g (W/kg)	Scaled SAR-1g (W/kg)
	WCDMA V	RMC12.2K	Rear Face	0	4233	1	w/o	1	24.0	22.82	1.31	0.04	0.411	0.54
	WCDMA V	RMC12.2K	Left Side	0	4233	1	w/o	1	24.0	22.82	1.31	0.02	0.004	0.01
	WCDMA V	RMC12.2K	Right Side	0	4233	1	w/o	1	24.0	22.82	1.31	-0.07	0.077	0.10
	WCDMA V	RMC12.2K	Top Side	0	4182	1	w	1	21.5	21.32	1.04	-0.02	0.704	0.73
	WCDMA V	RMC12.2K	Top Side	1.2	4233	1	w/o	1	24.0	22.82	1.31	0.05	0.246	0.32
	WCDMA V	RMC12.2K	Bottom Side	0	4233	1	w/o	1	24.0	22.82	1.31	0.01	0	0.00
	WCDMA V	RMC12.2K	Top Side	0	4182	1	w	2	21.5	21.32	1.04	0.03	0.768	0.80
03	WCDMA V	RMC12.2K	Top Side	0	4132	1	w	2	21.5	21.24	1.06	-0.1	0.805	0.85
	WCDMA V	RMC12.2K	Top Side	0	4132	1	w	2	21.5	21.24	1.06	-0.06	0.795	0.84
	WCDMA V	RMC12.2K	Top Side	0	4233	1	w	2	21.5	21.26	1.06	0.02	0.716	0.76
	WCDMA V	RMC12.2K	Top Side	0	4132	2	w	2	21.5	21.24	1.06	0.03	0.468	0.50

Plot No.	Band	Mode	Test Position	Separation Distance (cm)	Ch.	EUT Config.	Power Reduction	Battery	RB#	RB Offset	Max. Tune-up Power (dBm)	Measured Conducted Power (dBm)	Scaling Factor	Power Drift (dB)	Measured SAR-1g (W/kg)	Scaled SAR-1g (W/kg)
	LTE 2	QPSK20M	Rear Face	0	18900	1	w/o	1	1	0	24.0	23.09	1.23	-0.12	0.643	0.79
	LTE 2	QPSK20M	Rear Face	0	18900	1	w/o	1	50	0	23.0	21.87	1.30	0.05	0.498	0.65
	LTE 2	QPSK20M	Left Side	0	18900	1	w/o	1	1	0	24.0	23.09	1.23	0.19	0.182	0.22
	LTE 2	QPSK20M	Left Side	0	18900	1	w/o	1	50	0	23.0	21.87	1.30	-0.08	0.151	0.20
	LTE 2	QPSK20M	Right Side	0	18900	1	w/o	1	1	0	24.0	23.09	1.23	-0.09	0.256	0.32
	LTE 2	QPSK20M	Right Side	0	18900	1	w/o	1	50	0	23.0	21.87	1.30	-0.12	0.189	0.25
	LTE 2	QPSK20M	Top Side	0	18700	1	w	1	1	0	20.5	20.4	1.02	0.18	0.777	0.8
	LTE 2	QPSK20M	Top Side	0	18900	1	w	1	1	0	20.5	20.32	1.04	0.09	0.699	0.73
	LTE 2	QPSK20M	Top Side	0	19100	1	w	1	1	0	20.5	20.29	1.05	0.17	0.7	0.73
	LTE 2	QPSK20M	Top Side	0	18700	1	w	1	50	0	20.5	20.36	1.03	0.09	0.631	0.65
	LTE 2	QPSK20M	Top Side	0	18700	1	w	1	100	0	20.5	20.39	1.03	-0.01	0.581	0.6
	LTE 2	QPSK20M	Top Side	1.2	18900	1	w/o	1	1	0	24.0	23.09	1.23	0.04	0.462	0.57
	LTE 2	QPSK20M	Top Side	1.2	18900	1	w/o	1	50	0	23.0	21.87	1.30	0.01	0.375	0.49
	LTE 2	QPSK20M	Bottom Side	0	18900	1	w/o	1	1	0	24.0	23.09	1.23	0.06	0.123	0.15
	LTE 2	QPSK20M	Bottom Side	0	18900	1	w/o	1	50	0	23.0	21.87	1.30	0.02	0.106	0.14
	LTE 2	QPSK20M	Top Side	0	18700	1	w	2	1	0	20.5	20.4	1.02	0.03	0.758	0.78
04	LTE 2	QPSK20M	Top Side	0	18700	2	w	1	1	0	20.5	20.4	1.02	-0.15	1.06	1.08
	LTE 2	QPSK20M	Top Side	0	18700	2	w	1	1	0	20.5	20.4	1.02	0.02	0.997	1.02
	LTE 2	QPSK20M	Top Side	0	18900	2	w	1	1	0	20.5	20.32	1.04	-0.11	0.942	0.98
	LTE 2	QPSK20M	Top Side	0	19100	2	w	1	1	0	20.5	20.29	1.05	0.04	1.01	1.06
	LTE 2	QPSK20M	Top Side	0	18700	2	w	1	50	0	20.5	20.36	1.03	-0.05	0.837	0.86
	LTE 2	QPSK20M	Top Side	0	18900	2	w	1	50	0	20.5	20.3	1.05	-0.19	0.813	0.85
	LTE 2	QPSK20M	Top Side	0	19100	2	w	1	50	0	20.5	20.25	1.06	-0.1	0.795	0.84
	LTE 2	QPSK20M	Top Side	0	18700	2	w	1	100	0	20.5	20.39	1.03	-0.1	0.815	0.84

FCC SAR Test Report

Plot No.	Band	Mode	Test Position	Separation Distance (cm)	Ch.	EUT Config.	Power Reduction	Battery	RB#	RB Offset	Max. Tune-up Power (dBm)	Measured Conducted Power (dBm)	Scaling Factor	Power Drift (dB)	Measured SAR-1g (W/kg)	Scaled SAR-1g (W/kg)
	LTE 4	QPSK20M	Rear Face	0	20050	1	w/o	1	1	0	24.0	23.14	1.22	-0.01	0.706	0.86
	LTE 4	QPSK20M	Rear Face	0	20175	1	w/o	1	1	0	24.0	23.05	1.24	0.12	0.674	0.84
	LTE 4	QPSK20M	Rear Face	0	20300	1	w/o	1	1	0	24.0	23.07	1.24	-0.08	0.663	0.82
	LTE 4	QPSK20M	Rear Face	0	20050	1	w/o	1	50	0	23.0	22.06	1.24	0.05	0.553	0.69
	LTE 4	QPSK20M	Rear Face	0	20050	1	w/o	1	100	0	23.0	22	1.26	0.02	0.549	0.69
	LTE 4	QPSK20M	Left Side	0	20050	1	w/o	1	1	0	24.0	23.14	1.22	-0.01	0.086	0.10
	LTE 4	QPSK20M	Left Side	0	20050	1	w/o	1	50	0	23.0	22.06	1.24	-0.06	0.057	0.07
	LTE 4	QPSK20M	Right Side	0	20050	1	w/o	1	1	0	24.0	23.14	1.22	0.03	0.231	0.28
	LTE 4	QPSK20M	Right Side	0	20050	1	w/o	1	50	0	23.0	22.06	1.24	-0.01	0.178	0.22
	LTE 4	QPSK20M	Top Side	0	20050	1	w	1	1	0	19.0	18.92	1.02	0.07	0.856	0.87
	LTE 4	QPSK20M	Top Side	0	20175	1	w	1	1	0	19.0	18.77	1.05	0.06	0.826	0.87
	LTE 4	QPSK20M	Top Side	0	20300	1	w	1	1	0	19.0	18.9	1.02	-0.02	0.812	0.83
	LTE 4	QPSK20M	Top Side	0	20050	1	w	1	50	0	19.0	18.9	1.02	0.1	0.852	0.87
	LTE 4	QPSK20M	Top Side	0	20175	1	w	1	50	0	19.0	18.73	1.06	0.07	0.814	0.87
	LTE 4	QPSK20M	Top Side	0	20300	1	w	1	50	0	19.0	18.88	1.03	0.05	0.801	0.82
	LTE 4	QPSK20M	Top Side	0	20050	1	w	1	100	0	19.0	18.79	1.05	0.03	0.813	0.85
	LTE 4	QPSK20M	Top Side	1.2	20050	1	w/o	1	1	0	24.0	23.14	1.22	-0.05	0.451	0.55
	LTE 4	QPSK20M	Top Side	1.2	20050	1	w/o	1	50	0	23.0	22.06	1.24	0.01	0.317	0.39
	LTE 4	QPSK20M	Bottom Side	0	20050	1	w/o	1	1	0	24.0	23.14	1.22	0.03	0.014	0.02
	LTE 4	QPSK20M	Bottom Side	0	20050	1	w/o	1	50	0	23.0	22.06	1.24	0.17	0.00142	0.00
	LTE 4	QPSK20M	Top Side	0	20050	1	w	2	1	0	19.0	18.92	1.02	0.12	0.59	0.60
05	LTE 4	QPSK20M	Top Side	0	20050	2	w	1	1	0	19.0	18.92	1.02	0.14	0.955	0.97
	LTE 4	QPSK20M	Top Side	0	20050	2	w	1	1	0	19.0	18.92	1.02	0.14	0.943	0.96
	LTE 4	QPSK20M	Top Side	0	20175	2	w	1	1	0	19.0	18.77	1.05	0.11	0.899	0.95
	LTE 4	QPSK20M	Top Side	0	20300	2	w	1	1	0	19.0	18.9	1.02	0.06	0.881	0.90
	LTE 4	QPSK20M	Top Side	0	20050	2	w	1	50	0	19.0	18.9	1.02	-0.1	0.841	0.86
	LTE 4	QPSK20M	Top Side	0	20175	2	w	1	50	0	19.0	18.73	1.06	-0.03	0.871	0.93
	LTE 4	QPSK20M	Top Side	0	20300	2	w	1	50	0	19.0	18.88	1.03	0.08	0.864	0.89
	LTE 4	QPSK20M	Top Side	0	20050	2	w	1	100	0	19.0	18.79	1.05	0.09	0.869	0.91

FCC SAR Test Report

Plot No.	Band	Mode	Test Position	Separation Distance (cm)	Ch.	EUT Config.	Power Reduction	Battery	RB#	RB Offset	Max. Tune-up Power (dBm)	Measured Conducted Power (dBm)	Scaling Factor	Power Drift (dB)	Measured SAR-1g (W/kg)	Scaled SAR-1g (W/kg)
	LTE 5	QPSK10M	Rear Face	0	20525	1	w/o	1	1	0	24.0	22.79	1.32	0.02	0.533	0.70
	LTE 5	QPSK10M	Rear Face	0	20525	1	w/o	1	25	0	23.0	21.75	1.33	-0.04	0.394	0.53
	LTE 5	QPSK10M	Left Side	0	20525	1	w/o	1	1	0	24.0	22.79	1.32	-0.04	0.017	0.02
	LTE 5	QPSK10M	Left Side	0	20525	1	w/o	1	25	0	23.0	21.75	1.33	-0.13	0.013	0.02
	LTE 5	QPSK10M	Right Side	0	20525	1	w/o	1	1	0	24.0	22.79	1.32	-0.07	0.096	0.13
	LTE 5	QPSK10M	Right Side	0	20525	1	w/o	1	25	0	23.0	21.75	1.33	-0.07	0.069	0.09
06	LTE 5	QPSK10M	Top Side	0	20450	1	w	1	1	0	22.0	21.84	1.04	-0.02	1.11	1.15
	LTE 5	QPSK10M	Top Side	0	20450	1	w	1	1	0	22.0	21.84	1.04	0.02	1.09	1.13
	LTE 5	QPSK10M	Top Side	0	20525	1	w	1	1	0	22.0	21.58	1.1	0.06	1.01	1.11
	LTE 5	QPSK10M	Top Side	0	20600	1	w	1	1	0	22.0	21.72	1.07	0.02	0.889	0.95
	LTE 5	QPSK10M	Top Side	0	20450	1	w	1	25	0	22.0	21.79	1.05	0.09	0.89	0.93
	LTE 5	QPSK10M	Top Side	0	20525	1	w	1	25	0	22.0	21.53	1.11	0.02	0.783	0.87
	LTE 5	QPSK10M	Top Side	0	20600	1	w	1	25	0	22.0	21.67	1.08	-0.03	0.748	0.81
	LTE 5	QPSK10M	Top Side	0	20450	1	w	1	50	0	22.0	21.75	1.06	0.04	0.826	0.87
	LTE 5	QPSK10M	Top Side	1.2	20525	1	w/o	1	1	0	24.0	22.79	1.32	0.05	0.308	0.41
	LTE 5	QPSK10M	Top Side	1.2	20525	1	w/o	1	25	0	23.0	21.75	1.33	0.05	0.243	0.32
	LTE 5	QPSK10M	Bottom Side	0	20525	1	w/o	1	1	0	24.0	22.79	1.32	-0.03	0.021	0.03
	LTE 5	QPSK10M	Bottom Side	0	20525	1	w/o	1	25	0	23.0	21.75	1.33	-0.05	0.017	0.02
	LTE 5	QPSK10M	Top Side	0	20450	1	w	2	1	0	22.0	21.84	1.04	0.05	0.857	0.89
	LTE 5	QPSK10M	Top Side	0	20525	1	w	2	1	0	22.0	21.58	1.1	0.09	0.783	0.86
	LTE 5	QPSK10M	Top Side	0	20600	1	w	2	1	0	22.0	21.72	1.07	0.01	0.686	0.73
	LTE 5	QPSK10M	Top Side	0	20450	1	w	2	25	0	22.0	21.79	1.05	0.05	0.687	0.72
	LTE 5	QPSK10M	Top Side	0	20450	1	w	2	50	0	22.0	21.75	1.06	-0.03	0.637	0.67
	LTE 5	QPSK10M	Top Side	0	20450	2	w	1	1	0	22.0	21.84	1.04	0.02	0.692	0.72
	LTE 7	QPSK20M	Rear Face	0	21100	1	w/o	1	1	0	23.0	21.45	1.43	0.01	0.413	0.59
	LTE 7	QPSK20M	Rear Face	0	21100	1	w/o	1	50	0	22.0	20.48	1.42	0.03	0.386	0.55
	LTE 7	QPSK20M	Left Side	0	21100	1	w/o	1	1	0	23.0	21.45	1.43	0	0	0.00
	LTE 7	QPSK20M	Left Side	0	21100	1	w/o	1	50	0	22.0	20.48	1.42	0	0	0.00
	LTE 7	QPSK20M	Right Side	0	21100	1	w/o	1	1	0	23.0	21.45	1.43	0.05	0.316	0.45
	LTE 7	QPSK20M	Right Side	0	21100	1	w/o	1	50	0	22.0	20.48	1.42	0.09	0.255	0.36
07	LTE 7	QPSK20M	Top Side	0	21100	1	w	1	1	0	18.0	16.86	1.30	-0.13	0.545	0.71
	LTE 7	QPSK20M	Top Side	0	21100	1	w	1	50	0	18.0	16.77	1.33	-0.06	0.526	0.70
	LTE 7	QPSK20M	Top Side	1.2	21100	1	w/o	1	1	0	23.0	21.45	1.43	0.06	0.241	0.34
	LTE 7	QPSK20M	Top Side	1.2	21100	1	w/o	1	50	0	22.0	20.48	1.42	0.06	0.121	0.17
	LTE 7	QPSK20M	Bottom Side	0	21100	1	w/o	1	1	0	23.0	21.45	1.43	0	0	0.00
	LTE 7	QPSK20M	Bottom Side	0	21100	1	w/o	1	50	0	22.0	20.48	1.42	0	0	0.00
	LTE 7	QPSK20M	Top Side	0	21100	1	w	2	1	0	18.0	16.86	1.30	0.11	0.511	0.66
	LTE 7	QPSK20M	Top Side	0	21100	2	w	1	1	0	18.0	16.86	1.30	-0.01	0.506	0.66

FCC SAR Test Report

Plot No.	Band	Mode	Test Position	Separation Distance (cm)	Ch.	EUT Config.	Power Reduction	Battery	RB#	RB Offset	Max. Tune-up Power (dBm)	Measured Conducted Power (dBm)	Scaling Factor	Power Drift (dB)	Measured SAR-1g (W/kg)	Scaled SAR-1g (W/kg)
	LTE 12	QPSK10M	Rear Face	0	23130	1	w/o	1	1	0	24.0	23.03	1.25	-0.02	0.685	0.86
	LTE 12	QPSK10M	Rear Face	0	23060	1	w/o	1	1	0	24.0	22.92	1.28	0.01	0.668	0.86
	LTE 12	QPSK10M	Rear Face	0	23095	1	w/o	1	1	0	24.0	22.94	1.28	0.03	0.653	0.83
	LTE 12	QPSK10M	Rear Face	0	23130	1	w/o	1	25	0	23.0	21.98	1.26	-0.05	0.582	0.74
	LTE 12	QPSK10M	Rear Face	0	23130	1	w/o	1	50	0	23.0	21.96	1.27	-0.01	0.504	0.64
	LTE 12	QPSK10M	Left Side	0	23130	1	w/o	1	1	0	24.0	23.03	1.25	-0.06	0	0.00
	LTE 12	QPSK10M	Left Side	0	23130	1	w/o	1	25	0	23.0	21.98	1.26	-0.15	0	0.00
	LTE 12	QPSK10M	Right Side	0	23130	1	w/o	1	1	0	24.0	23.03	1.25	0.11	0.198	0.25
	LTE 12	QPSK10M	Right Side	0	23130	1	w/o	1	25	0	23.0	21.98	1.26	-0.14	0.135	0.17
	LTE 12	QPSK10M	Top Side	0	23130	1	w	1	1	0	21.0	20.95	1.01	0.1	0.914	0.92
	LTE 12	QPSK10M	Top Side	0	23060	1	w	1	1	0	21.0	20.91	1.02	-0.11	0.884	0.9
	LTE 12	QPSK10M	Top Side	0	23095	1	w	1	1	0	21.0	20.88	1.03	0.09	0.872	0.9
	LTE 12	QPSK10M	Top Side	0	23130	1	w	1	25	0	21.0	20.89	1.03	0.09	0.736	0.75
	LTE 12	QPSK10M	Top Side	0	23130	1	w	1	50	0	21.0	20.86	1.03	0.03	0.734	0.76
	LTE 12	QPSK10M	Top Side	1.2	23130	1	w/o	1	1	0	24.0	23.03	1.25	0.12	0.413	0.52
	LTE 12	QPSK10M	Top Side	1.2	23130	1	w/o	1	25	0	23.0	21.98	1.26	0.02	0.336	0.42
	LTE 12	QPSK10M	Bottom Side	0	23130	1	w/o	1	1	0	24.0	23.03	1.25	-0.15	0	0.00
	LTE 12	QPSK10M	Bottom Side	0	23130	1	w/o	1	25	0	23.0	21.98	1.26	-0.06	0	0.00
08	LTE 12	QPSK10M	Top Side	0	23130	1	w	2	1	0	21.0	20.95	1.01	-0.06	1.01	1.02
	LTE 12	QPSK10M	Top Side	0	23130	1	w	2	1	0	21.0	20.95	1.01	0.02	0.99	1
	LTE 12	QPSK10M	Top Side	0	23060	1	w	2	1	0	21.0	20.91	1.02	-0.11	0.977	1
	LTE 12	QPSK10M	Top Side	0	23095	1	w	2	1	0	21.0	20.88	1.03	0.1	0.963	0.99
	LTE 12	QPSK10M	Top Side	0	23130	1	w	2	25	0	21.0	20.89	1.03	-0.18	0.818	0.84
	LTE 12	QPSK10M	Top Side	0	23060	1	w	2	25	0	21.0	20.85	1.04	0.07	0.836	0.87
	LTE 12	QPSK10M	Top Side	0	23095	1	w	2	25	0	21.0	20.83	1.04	-0.11	0.814	0.85
	LTE 12	QPSK10M	Top Side	0	23130	1	w	2	50	0	21.0	20.86	1.03	0.14	0.812	0.84
	LTE 12	QPSK10M	Top Side	0	23130	2	w	2	1	0	21.0	20.95	1.01	-0.01	0.831	0.84
	LTE 12	QPSK10M	Top Side	0	23060	2	w	2	1	0	21.0	20.91	1.02	-0.02	0.804	0.82
	LTE 12	QPSK10M	Top Side	0	23095	2	w	2	1	0	21.0	20.88	1.03	0.12	0.793	0.82
	LTE 12	QPSK10M	Top Side	0	23130	2	w	2	25	0	21.0	20.89	1.03	-0.06	0.673	0.69
	LTE 12	QPSK10M	Top Side	0	23130	2	w	2	50	0	21.0	20.86	1.03	0.07	0.668	0.69
	LTE 13	QPSK10M	Rear Face	0	23230	1	w/o	1	1	24	24.0	22.95	1.27	-0.12	0.596	0.76
	LTE 13	QPSK10M	Rear Face	0	23230	1	w/o	1	25	0	23.0	21.94	1.28	0.05	0.501	0.64
	LTE 13	QPSK10M	Left Side	0	23230	1	w/o	1	1	24	24.0	22.95	1.27	0.04	0	0.00
	LTE 13	QPSK10M	Left Side	0	23230	1	w/o	1	25	0	23.0	21.94	1.28	0.02	0	0.00
	LTE 13	QPSK10M	Right Side	0	23230	1	w/o	1	1	24	24.0	22.95	1.27	-0.12	0.105	0.13
	LTE 13	QPSK10M	Right Side	0	23230	1	w/o	1	25	0	23.0	21.94	1.28	-0.14	0.088	0.11
	LTE 13	QPSK10M	Top Side	0	23230	1	w	1	1	0	21.0	20.74	1.06	0.03	0.757	0.8
	LTE 13	QPSK10M	Top Side	0	23230	1	w	1	25	0	21.0	20.72	1.07	0.04	0.576	0.61
	LTE 13	QPSK10M	Top Side	0	23230	1	w	1	50	0	21.0	20.64	1.09	0.04	0.553	0.6
	LTE 13	QPSK10M	Top Side	1.2	23230	1	w/o	1	1	24	24.0	22.95	1.27	0.06	0.309	0.39
	LTE 13	QPSK10M	Top Side	1.2	23230	1	w/o	1	25	0	23.0	21.94	1.28	0.05	0.298	0.38
	LTE 13	QPSK10M	Bottom Side	0	23230	1	w/o	1	1	24	24.0	22.95	1.27	0.01	0	0.00
	LTE 13	QPSK10M	Bottom Side	0	23230	1	w/o	1	25	0	23.0	21.94	1.28	-0.01	0	0.00
09	LTE 13	QPSK10M	Top Side	0	23230	1	w	2	1	0	21.0	20.74	1.06	-0.07	0.984	1.04
	LTE 13	QPSK10M	Top Side	0	23230	1	w	2	1	0	21.0	20.74	1.06	0.01	0.973	1.03
	LTE 13	QPSK10M	Top Side	0	23230	1	w	1	25	0	21.0	20.72	1.07	0.02	0.739	0.79
	LTE 13	QPSK10M	Top Side	0	23230	1	w	1	50	0	21.0	20.64	1.09	0.04	0.673	0.73
	LTE 13	QPSK10M	Top Side	0	23230	2	w	2	1	0	21.0	20.74	1.06	0.03	0.587	0.62

FCC SAR Test Report

Plot No.	Band	Mode	Test Position	Separation Distance (cm)	Ch.	EUT Config.	Power Reduction	Battery	RB#	RB Offset	Max. Tune-up Power (dBm)	Measured Conducted Power (dBm)	Scaling Factor	Power Drift (dB)	Measured SAR-1g (W/kg)	Scaled SAR-1g (W/kg)
10	LTE 25	QPSK20M	Rear Face	0	26140	1	w/o	1	1	0	24.0	22.93	1.28	0	0.72	0.92
	LTE 25	QPSK20M	Rear Face	0	26365	1	w/o	1	1	0	24.0	22.9	1.29	0	0.575	0.74
	LTE 25	QPSK20M	Rear Face	0	26590	1	w/o	1	1	0	24.0	22.88	1.29	0.05	0.386	0.50
	LTE 25	QPSK20M	Rear Face	0	26140	1	w/o	1	50	0	23.0	21.76	1.33	-0.03	0.497	0.66
	LTE 25	QPSK20M	Rear Face	0	26140	1	w/o	1	100	0	23.0	21.68	1.36	-0.16	0.402	0.54
	LTE 25	QPSK20M	Left Side	0	26140	1	w/o	1	1	0	24.0	22.93	1.28	0.03	0.144	0.18
	LTE 25	QPSK20M	Left Side	0	26140	1	w/o	1	50	0	23.0	21.76	1.33	0.04	0.12	0.16
	LTE 25	QPSK20M	Right Side	0	26140	1	w/o	1	1	0	24.0	22.93	1.28	-0.07	0.287	0.37
	LTE 25	QPSK20M	Right Side	0	26140	1	w/o	1	50	0	23.0	21.76	1.33	-0.01	0.206	0.27
	LTE 25	QPSK20M	Top Side	0	26140	1	w	1	1	0	20.0	19.94	1.01	0.07	0.578	0.59
	LTE 25	QPSK20M	Top Side	0	26140	1	w	1	50	0	20.0	19.93	1.02	-0.14	0.481	0.49
	LTE 25	QPSK20M	Top Side	1.2	26140	1	w/o	1	1	0	24.0	22.93	1.28	-0.15	0.301	0.39
	LTE 25	QPSK20M	Top Side	1.2	26140	1	w/o	1	50	0	23.0	21.76	1.33	0.1	0.229	0.30
	LTE 25	QPSK20M	Bottom Side	0	26140	1	w/o	1	1	0	24.0	22.93	1.28	-0.04	0.087	0.11
	LTE 25	QPSK20M	Bottom Side	0	26140	1	w/o	1	50	0	23.0	21.76	1.33	-0.09	0.08	0.11
	LTE 25	QPSK20M	Rear Face	0	26140	1	w/o	2	1	0	24.0	22.93	1.28	-0.1	0.633	0.81
	LTE 25	QPSK20M	Rear Face	0	26365	1	w/o	2	1	0	24.0	22.9	1.29	-0.14	0.386	0.50
	LTE 25	QPSK20M	Rear Face	0	26590	1	w/o	2	1	0	24.0	22.88	1.29	-0.03	0.383	0.50
	LTE 25	QPSK20M	Rear Face	0	26140	1	w/o	2	50	0	23.0	21.76	1.33	-0.08	0.412	0.55
	LTE 25	QPSK20M	Rear Face	0	26140	1	w/o	2	100	0	23.0	21.68	1.36	-0.12	0.404	0.55
	LTE 25	QPSK20M	Rear Face	0	26140	2	w/o	1	1	0	24.0	22.93	1.28	0.08	0.356	0.46
11	LTE 26	QPSK15M	Rear Face	0	26965	1	w/o	1	1	0	24.0	22.91	1.29	-0.01	0.493	0.63
	LTE 26	QPSK15M	Rear Face	0	26965	1	w/o	1	36	0	23.0	21.96	1.27	0.01	0.401	0.51
	LTE 26	QPSK15M	Left Side	0	26965	1	w/o	1	1	0	24.0	22.91	1.29	0	0	0.00
	LTE 26	QPSK15M	Left Side	0	26965	1	w/o	1	36	0	23.0	21.96	1.27	0	0	0.00
	LTE 26	QPSK15M	Right Side	0	26965	1	w/o	1	1	0	24.0	22.91	1.29	-0.14	0.09	0.12
	LTE 26	QPSK15M	Right Side	0	26965	1	w/o	1	36	0	23.0	21.96	1.27	-0.05	0.056	0.07
	LTE 26	QPSK15M	Top Side	0	26965	1	w	1	1	0	21.5	21.29	1.05	0.1	0.441	0.46
	LTE 26	QPSK15M	Top Side	0	26965	1	w	1	36	0	21.5	21.01	1.12	0.03	0.395	0.44
	LTE 26	QPSK15M	Top Side	1.2	26965	1	w/o	1	1	0	24.0	22.91	1.29	-0.05	0.233	0.30
	LTE 26	QPSK15M	Top Side	1.2	26965	1	w/o	1	36	0	23.0	21.96	1.27	0.02	0.184	0.23
	LTE 26	QPSK15M	Bottom Side	0	26965	1	w/o	1	1	0	24.0	22.91	1.29	0.07	0.028	0.04
	LTE 26	QPSK15M	Bottom Side	0	26965	1	w/o	1	36	0	23.0	21.96	1.27	-0.09	0.015	0.02
	LTE 26	QPSK15M	Rear Face	0	26965	1	w/o	2	1	0	24.0	22.91	1.29	0.04	0.282	0.36
	LTE 26	QPSK15M	Rear Face	0	26965	2	w/o	1	1	0	24.0	22.91	1.29	0.01	0.095	0.12
	LTE 41	QPSK20M	Rear Face	0	40185	1	w/o	1	1	0	23.0	21.82	1.31	0.01	0.251	0.33
	LTE 41	QPSK20M	Rear Face	0	40185	1	w/o	1	50	0	22.0	20.79	1.32	-0.03	0.196	0.26
	LTE 41	QPSK20M	Left Side	0	40185	1	w/o	1	1	0	23.0	21.82	1.31	0	0	0.00
	LTE 41	QPSK20M	Left Side	0	40185	1	w/o	1	50	0	22.0	20.79	1.32	0	0	0.00
	LTE 41	QPSK20M	Right Side	0	40185	1	w/o	1	1	0	23.0	21.82	1.31	-0.11	0.182	0.24
	LTE 41	QPSK20M	Right Side	0	40185	1	w/o	1	50	0	22.0	20.79	1.32	0.01	0.036	0.05
12	LTE 41	QPSK20M	Top Side	0	40185	1	w	1	1	0	19.5	18.83	1.17	-0.06	0.64	0.75
	LTE 41	QPSK20M	Top Side	0	40185	1	w	1	50	0	19.5	18.82	1.17	-0.03	0.608	0.71
	LTE 41	QPSK20M	Top Side	1.2	40185	1	w/o	1	1	0	23.0	21.82	1.31	0.09	0.137	0.18
	LTE 41	QPSK20M	Top Side	1.2	40185	1	w/o	1	50	0	22.0	20.79	1.32	0.05	0.11	0.15
	LTE 41	QPSK20M	Bottom Side	0	40185	1	w/o	1	1	0	23.0	21.82	1.31	0	0	0.00
	LTE 41	QPSK20M	Bottom Side	0	40185	1	w/o	1	50	0	22.0	20.79	1.32	0	0	0.00
	LTE 41	QPSK20M	Top Side	0	40185	1	w	2	1	0	19.5	18.83	1.17	0.12	0.187	0.22
	LTE 41	QPSK20M	Top Side	0	40185	2	w	1	1	0	19.5	18.83	1.17	0.15	0.354	0.41

FCC SAR Test Report

WLAN (QCFA344A)

Tablet PC Mode

Plot No.	Band	Mode	Test Position	Separation Distance (cm)	Ch.	EUT Config.	Tx Antenna	Battery	Max. Tune-up Power (dBm)	Measured Conducted Power (dBm)	Scaling Factor	Power Drift (dB)	Measured SAR-1g (W/kg)	Scaled SAR-1g (W/kg)	
	2.4G WLAN	802.11b	Rear Face	0	6	1		0	1	12.0	11.76	1.06	0.09	0.035	0.04
	2.4G WLAN	802.11b	Rear Face	0	6	1		1	1	12.0	11.76	1.06	0.06	0.052	0.05
	2.4G WLAN	802.11b	Rear Face	0	6	1	2TX	1	1	12.0	11.88	1.03	-0.06	0.045	0.05
	2.4G WLAN	802.11b	Left Side	0	6	1		0	1	12.0	11.76	1.06	0	0	0.00
	2.4G WLAN	802.11b	Left Side	0	6	1		0	1	12.0	11.77	1.05	0	0	0.00
	2.4G WLAN	802.11b	Left Side	0	6	1	2TX	1	1	12.0	11.88	1.03	0	0	0.00
	2.4G WLAN	802.11b	Top Side	0	6	1		0	1	12.0	11.76	1.06	0.12	0.079	0.08
	2.4G WLAN	802.11b	Top Side	0	6	1	2TX	0	1	12.0	11.77	1.05	-0.09	0.077	0.08
13	2.4G WLAN	802.11b	Bottom Side	0	6	1		1	1	12.0	11.76	1.06	-0.07	0.178	0.19
	2.4G WLAN	802.11b	Bottom Side	0	6	1	2TX	1	1	12.0	11.88	1.03	-0.14	0.181	0.19
	2.4G WLAN	802.11b	Bottom Side	0	6	1		1	2	12.0	11.76	1.06	0.13	0.12	0.13
	2.4G WLAN	802.11b	Bottom Side	0	6	2		1	1	12.0	11.76	1.06	0.01	0.111	0.12
	5.3G WLAN	802.11ac VH80	Rear Face	0	58	1		0	1	10.5	9.65	1.22	0.04	0.07	0.09
	5.3G WLAN	802.11ac VH80	Rear Face	0	58	1		1	1	10.5	9.98	1.13	0	0	0.00
	5.3G WLAN	802.11ac VH80	Rear Face	0	58	1		0	1	10.5	9.46	1.27	0	0	0.00
	5.3G WLAN	802.11ac VH80	Rear Face	0	58	1	2TX	1	1	10.5	9.85	1.16	0	0	0.00
	5.3G WLAN	802.11ac VH80	Left Side	0	58	1		0	1	10.5	9.65	1.22	0	0	0.00
	5.3G WLAN	802.11ac VH80	Left Side	0	58	1		0	1	10.5	9.46	1.27	0	0	0.00
	5.3G WLAN	802.11ac VH80	Left Side	0	58	1	2TX	1	1	10.5	9.85	1.16	0	0	0.00
	5.3G WLAN	802.11ac VH80	Top Side	0	58	1		0	1	10.5	9.65	1.22	0	0.301	0.37
	5.3G WLAN	802.11ac VH80	Top Side	0	58	1	2TX	0	1	10.5	9.46	1.27	0	0.298	0.38
	5.3G WLAN	802.11ac VH80	Bottom Side	0	58	1		1	1	10.5	9.98	1.13	-0.09	0.433	0.49
14	5.3G WLAN	802.11ac VH80	Bottom Side	0	58	1	2TX	1	1	10.5	9.85	1.16	-0.01	0.475	0.55
	5.3G WLAN	802.11ac VH80	Bottom Side	0	58	1	2TX	1	2	10.5	9.85	1.16	0	0.291	0.34
	5.3G WLAN	802.11ac VH80	Bottom Side	0	58	2	2TX	1	1	10.5	9.85	1.16	0	0	0.00
	5.6G WLAN	802.11ac VH80	Rear Face	0	106	1		0	1	10.5	9.90	1.15	0.04	0.188	0.22
	5.6G WLAN	802.11ac VH80	Rear Face	0	106	1		1	1	10.5	10.01	1.12	0	0	0.00
	5.6G WLAN	802.11ac VH80	Rear Face	0	106	1		0	1	10.5	9.36	1.30	0	0	0.00
	5.6G WLAN	802.11ac VH80	Rear Face	0	106	1	2TX	1	1	10.5	10.22	1.07	0	0	0.00
	5.6G WLAN	802.11ac VH80	Left Side	0	106	1		0	1	10.5	9.90	1.15	0	0	0.00
	5.6G WLAN	802.11ac VH80	Left Side	0	106	1		0	1	10.5	9.36	1.07	0	0	0.00
	5.6G WLAN	802.11ac VH80	Left Side	0	106	1	2TX	1	1	10.5	10.22	1.07	0	0	0.00
15	5.6G WLAN	802.11ac VH80	Top Side	0	106	1		0	1	10.5	9.90	1.15	0.05	0.398	0.46
	5.6G WLAN	802.11ac VH80	Top Side	0	106	1	2TX	0	1	10.5	9.36	1.30	0.12	0.259	0.34
	5.6G WLAN	802.11ac VH80	Bottom Side	0	106	1		1	1	10.5	10.01	1.12	0.07	0.235	0.26
	5.6G WLAN	802.11ac VH80	Bottom Side	0	106	1	2TX	1	1	10.5	10.22	1.07	0.11	0.378	0.40
	5.6G WLAN	802.11ac VH80	Top Side	0	106	1		0	2	10.5	9.90	1.15	-0.08	0.372	0.43
	5.6G WLAN	802.11ac VH80	Top Side	0	106	2		0	1	10.5	9.90	1.15	-0.05	0.327	0.38

FCC SAR Test Report

Plot No.	Band	Mode	Test Position	Separation Distance (cm)	Ch.	EUT Config.	Tx Antenna	Battery	Max. Tune-up Power (dBm)	Measured Conducted Power (dBm)	Scaling Factor	Power Drift (dB)	Measured SAR-1g (W/kg)	Scaled SAR-1g (W/kg)	
	5.8G WLAN	802.11n HT40	Rear Face	0	151	1		0	1	10.5	9.48	1.26	0	0	0.00
	5.8G WLAN	802.11n HT40	Rear Face	0	159	1		1	1	10.5	9.59	1.23	0	0	0.00
	5.8G WLAN	802.11n HT40	Rear Face	0	159	1	2TX	0	1	10.5	9.31	1.32	0	0	0.00
	5.8G WLAN	802.11n HT40	Rear Face	0	159	1		1	1	10.5	10.29	1.05	0	0	0.00
	5.8G WLAN	802.11n HT40	Left Side	0	151	1		0	1	10.5	9.48	1.26	0	0	0.00
	5.8G WLAN	802.11n HT40	Left Side	0	159	1	2TX	0	1	10.5	9.31	1.32	0	0	0.00
	5.8G WLAN	802.11n HT40	Left Side	0	159	1		1	1	10.5	10.29	1.05	0	0	0.00
16	5.8G WLAN	802.11n HT40	Top Side	0	151	1		0	1	10.5	9.48	1.26	0.10	0.484	0.61
	5.8G WLAN	802.11n HT40	Top Side	0	159	1	2TX	0	1	10.5	9.31	1.32	0.08	0.327	0.43
	5.8G WLAN	802.11n HT40	Bottom Side	0	159	1		1	1	10.5	9.59	1.23	0.05	0.402	0.50
	5.8G WLAN	802.11n HT40	Bottom Side	0	159	1	2TX	0	1	10.5	9.31	1.32	0	0	0.00
	5.8G WLAN	802.11n HT40	Bottom Side	0	159	1		1	1	10.5	10.29	1.05	0.01	0.358	0.38
	5.8G WLAN	802.11n HT40	Top Side	0	151	1		0	2	10.5	9.48	1.26	0.16	0.394	0.50
	5.8G WLAN	802.11n HT40	Top Side	0	151	2		0	1	10.5	9.48	1.26	-0.12	0.385	0.49

Plot No.	Band	Test Position	Separation Distance (cm)	Ch.	EUT Config.	Battery	Max. Tune-up Power (dBm)	Measured Conducted Power (dBm)	Scaling Factor	Power Drift (dB)	Measured SAR-1g (W/kg)	Scaled SAR-1g (W/kg)
	Bluetooth	Rear Face	0	78	1	1	7.0	5.37	1.46	0	0	0
	Bluetooth	Top Side	0	78	1	1	7.0	5.37	1.46	0	0	0
	Bluetooth	Bottom Side	0	78	1	1	7.0	5.37	1.46	0	0	0
	Bluetooth	Bottom Side	0	78	1	2	7.0	5.37	1.46	0	0	0
	Bluetooth	Bottom Side	0	78	2	1	7.0	5.37	1.46	0	0	0

FCC SAR Test Report

WLAN (QCFA344A)

Laptop PC Mode

Plot No.	Band	Mode	Test Position	Separation Distance (cm)	Ch.	EUT Config.	Tx Antenna		Battery	Max. Tune-up Power (dBm)	Measured Conducted Power (dBm)	Scaling Factor	Power Drift (dB)	Measured SAR-1g (W/kg)	Scaled SAR-1g (W/kg)
17	2.4G WLAN	802.11b	Bottom Side	0	6	1		1	1	12.0	11.76	1.06	-0.12	0.012	0.01
	2.4G WLAN	802.11b	Bottom Side	0	6	1	2TX	1	1	12.0	11.88	1.03	-0.09	0.022	0.02
	2.4G WLAN	802.11b	Bottom Side	0	6	1	2TX	1	2	12.0	11.88	1.03	0.11	0.014	0.01
	2.4G WLAN	802.11b	Bottom Side	0	6	2	2TX	1	1	12.0	11.88	1.03	-0.01	0.013	0.01
	2.4G WLAN	802.11b	Left Side	2.5	6	1		0	1	12.0	11.76	1.06	0	0	0.00
	2.4G WLAN	802.11b	Left Side	2.5	6	1	2TX	0	1	12.0	11.77	1.05	0	0	0.00
	2.4G WLAN	802.11b	Left Side	2.5	6	1		1	1	12.0	11.88	1.03	0	0	0.00
	2.4G WLAN	802.11b	Top Side	2.5	6	1		0	1	12.0	11.76	1.06	0.04	0.0094	0.01
	2.4G WLAN	802.11b	Top Side	2.5	6	1	2TX	0	1	12.0	11.77	1.05	0.01	0.004	0.00
	2.4G WLAN	802.11b	Top Side	2.5	6	1		0	2	12.0	11.76	1.06	-0.01	0.006	0.01
2.4G WLAN	802.11b	Top Side	2.5	6	2		0	1	12.0	11.76	1.06	0.03	0.00538	0.01	
33	5.3G WLAN	802.11ac VH80	Bottom Side	0	58	1		1	1	10.5	9.98	1.13	0	0	0.00
	5.3G WLAN	802.11ac VH80	Bottom Side	0	58	1	2TX	0	1	10.5	9.46	1.27	0	0	0.00
	5.3G WLAN	802.11ac VH80	Bottom Side	0	58	1		1	1	10.5	9.85	1.16	0	0	0.00
	5.3G WLAN	802.11ac VH80	Bottom Side	0	58	1		1	2	10.5	9.98	1.13	0	0	0.00
	5.3G WLAN	802.11ac VH80	Bottom Side	0	58	2		1	1	10.5	9.98	1.13	0	0	0.00
	5.3G WLAN	802.11ac VH80	Left Side	2.5	58	1		0	1	10.5	9.65	1.22	0	0	0.00
	5.3G WLAN	802.11ac VH80	Left Side	2.5	58	1	2TX	0	1	10.5	9.46	1.27	0	0	0.00
	5.3G WLAN	802.11ac VH80	Left Side	2.5	58	1		1	1	10.5	9.85	1.16	0	0	0.00
	5.3G WLAN	802.11ac VH80	Top Side	2.5	58	1		0	1	10.5	9.65	1.22	-0.08	0.032	0.04
	5.3G WLAN	802.11ac VH80	Top Side	2.5	58	1	2TX	0	1	10.5	9.46	1.27	0.05	0.03	0.04
5.3G WLAN	802.11ac VH80	Top Side	2.5	58	1		0	2	10.5	9.65	1.22	0.02	0.028	0.03	
5.3G WLAN	802.11ac VH80	Top Side	2.5	58	2		0	1	10.5	9.65	1.22	-0.01	0.027	0.03	
18	5.6G WLAN	802.11ac VH80	Bottom Side	0	106	1		1	1	10.5	10.01	1.12	0.02	0.031	0.03
	5.6G WLAN	802.11ac VH80	Bottom Side	0	106	1	2TX	0	1	10.5	9.36	1.30	-0.02	0.024	0.03
	5.6G WLAN	802.11ac VH80	Bottom Side	0	106	1		1	1	10.5	10.22	1.07	0.04	0.024	0.03
	5.6G WLAN	802.11ac VH80	Bottom Side	0	106	1		1	2	10.5	10.01	1.12	0.07	0.026	0.03
	5.6G WLAN	802.11ac VH80	Bottom Side	0	106	2		1	1	10.5	10.01	1.12	0.09	0.026	0.03
	5.6G WLAN	802.11ac VH80	Left Side	2.5	106	1		0	1	10.5	9.90	1.15	0	0	0.00
	5.6G WLAN	802.11ac VH80	Left Side	2.5	106	1	2TX	0	1	10.5	9.36	1.30	0	0	0.00
	5.6G WLAN	802.11ac VH80	Left Side	2.5	106	1		1	1	10.5	10.22	1.07	0	0	0.00
	5.6G WLAN	802.11ac VH80	Top Side	2.5	106	1		0	1	10.5	9.90	1.15	-0.03	0.018	0.02
	5.6G WLAN	802.11ac VH80	Top Side	2.5	106	1	2TX	0	1	10.5	9.36	1.30	0.02	0.016	0.02
5.6G WLAN	802.11ac VH80	Top Side	2.5	106	1		0	2	10.5	9.90	1.15	0.04	0.015	0.02	
5.6G WLAN	802.11ac VH80	Top Side	2.5	106	2		0	1	10.5	9.90	1.15	0.01	0.014	0.02	

FCC SAR Test Report

Plot No.	Band	Mode	Test Position	Separation Distance (cm)	Ch.	EUT Config.	Tx Antenna	Battery	Max. Tune-up Power (dBm)	Measured Conducted Power (dBm)	Scaling Factor	Power Drift (dB)	Measured SAR-1g (W/kg)	Scaled SAR-1g (W/kg)	
19	5.8G WLAN	802.11n HT40	Bottom Side	0	159	1		1	1	10.5	9.59	1.23	0.18	0.033	0.04
	5.8G WLAN	802.11n HT40	Bottom Side	0	159	1	2TX	0	1	10.5	9.31	1.32	0.02	0.025	0.03
	5.8G WLAN	802.11n HT40	Bottom Side	0	159	1		1	1	10.5	10.29	1.05	0.01	0.026	0.03
	5.8G WLAN	802.11n HT40	Bottom Side	0	159	1		1	2	10.5	9.59	1.23	0.06	0.027	0.03
	5.8G WLAN	802.11n HT40	Bottom Side	0	159	2		1	1	10.5	9.59	1.23	0.01	0.028	0.03
	5.8G WLAN	802.11n HT40	Left Side	2.5	151	1		0	1	10.5	9.48	1.26	0	0	0.00
	5.8G WLAN	802.11n HT40	Left Side	2.5	159	1	2TX	0	1	10.5	9.31	1.32	0	0	0.00
	5.8G WLAN	802.11n HT40	Left Side	2.5	159	1		1	1	10.5	10.29	1.05	0	0	0.00
	5.8G WLAN	802.11n HT40	Top Side	2.5	151	1		0	1	10.5	9.48	1.26	-0.11	0.021	0.03
	5.8G WLAN	802.11n HT40	Top Side	2.5	159	1	2TX	0	1	10.5	9.31	1.32	0.04	0.020	0.03
	5.8G WLAN	802.11n HT40	Top Side	2.5	151	1		0	2	10.5	9.48	1.26	-0.03	0.020	0.03
	5.8G WLAN	802.11n HT40	Top Side	2.5	151	2		0	1	10.5	9.48	1.26	0.04	0.018	0.02

Plot No.	Band	Test Position	Separation Distance (cm)	Ch.	EUT Config.	Battery	Max. Tune-up Power (dBm)	Measured Conducted Power (dBm)	Scaling Factor	Power Drift (dB)	Measured SAR-1g (W/kg)	Scaled SAR-1g (W/kg)
	Bluetooth	Bottom Side	0	78	1	1	7.0	5.37	1.46	0	0	0
	Bluetooth	Bottom Side	0	78	1	2	7.0	5.37	1.46	0	0	0
	Bluetooth	Bottom Side	0	78	2	1	7.0	5.37	1.46	0	0	0

FCC SAR Test Report

WLAN (8265NGW)

Tablet PC Mode

Plot No.	Band	Mode	Test Position	Separation Distance (cm)	Ch.	EUT Config.	Tx Antenna	Battery	Max. Tune-up Power (dBm)	Measured Conducted Power (dBm)	Scaling Factor	Power Drift (dB)	Measured SAR-1g (W/kg)	Scaled SAR-1g (W/kg)
	2.4G WLAN	802.11b	Top Side	0	6	1	1	1	15.0	15.00	1.00	0	0	0.00
	2.4G WLAN	802.11b	Top Side	0	6	2	1	2	15.0	15.00	1.00	0	0	0.00
	5.3G WLAN	802.11a	Top Side	0	60	1	1	1	13.5	13.50	1.00	0	0	0.00
	5.3G WLAN	802.11a	Top Side	0	60	2	1	2	13.5	13.50	1.00	0	0	0.00
	5.3G WLAN	802.11a	Bottom Side	0	60	1	0	1	13.5	13.50	1.00	0	0	0.00
	5.3G WLAN	802.11a	Bottom Side	0	60	2	0	2	13.5	13.50	1.00	0	0	0.00
	5.6G WLAN	802.11a	Top Side	0	116	1	1	1	13.5	13.50	1.00	0	0	0.00
	5.6G WLAN	802.11a	Top Side	0	116	2	1	2	13.5	13.50	1.00	0	0	0.00
	5.6G WLAN	802.11a	Bottom Side	0	116	1	0	1	13.5	13.50	1.00	0	0	0.00
	5.6G WLAN	802.11a	Bottom Side	0	116	2	0	2	13.5	13.50	1.00	0	0	0.00
	5.8G WLAN	802.11a	Top Side	0	157	1	1	1	13.5	13.50	1.00	0	0	0.00
	5.8G WLAN	802.11a	Top Side	0	157	2	1	2	13.5	13.50	1.00	0	0	0.00
	5.8G WLAN	802.11a	Bottom Side	0	157	1	0	1	13.5	13.50	1.00	0	0	0.00
	5.8G WLAN	802.11a	Bottom Side	0	157	2	0	2	13.5	13.50	1.00	0	0	0.00

Plot No.	Band	Test Position	Separation Distance (cm)	Ch.	EUT Config.	Tx Antenna	Battery	Max. Tune-up Power (dBm)	Measured Conducted Power (dBm)	Scaling Factor	Power Drift (dB)	Measured SAR-1g (W/kg)	Scaled SAR-1g (W/kg)
	Bluetooth	Top Side	0	39	1	1	1	11.5	11.50	1.00	0	0	0.00
	Bluetooth	Top Side	0	39	2	1	2	11.5	11.50	1.00	0	0	0.00

FCC SAR Test Report

4.7.3 SAR Measurement Variability

According to KDB 865664 D01, SAR measurement variability was assessed for each frequency band, which is determined by the SAR probe calibration point and tissue-equivalent medium used for the device measurements. When both head and body tissue-equivalent media are required for SAR measurements in a frequency band, the variability measurement procedures should be applied to the tissue medium with the highest measured SAR, using the highest measured SAR configuration for that tissue-equivalent medium. Alternatively, if the highest measured SAR for both head and body tissue-equivalent media are ≤ 1.45 W/kg and the ratio of these highest SAR values, i.e., largest divided by smallest value, is ≤ 1.10 , the highest SAR configuration for either head or body tissue-equivalent medium may be used to perform the repeated measurement. These additional measurements are repeated after the completion of all measurements requiring the same head or body tissue-equivalent medium in a frequency band. The test device should be returned to ambient conditions (normal room temperature) with the battery fully charged before it is re-mounted on the device holder for the repeated measurement(s) to minimize any unexpected variations in the repeated results.

SAR repeated measurement procedure:

1. When the highest measured SAR is < 0.80 W/kg, repeated measurement is not required.
2. When the highest measured SAR is ≥ 0.80 W/kg, repeat that measurement once.
3. If the ratio of largest to smallest SAR for the original and first repeated measurements is > 1.20 , or when the original or repeated measurement is ≥ 1.45 W/kg, perform a second repeated measurement.
4. If the ratio of largest to smallest SAR for the original, first and second repeated measurements is > 1.20 , and the original, first or second repeated measurement is ≥ 1.5 W/kg, perform a third repeated measurement.

Band	Test Position	Ch.	Original Measured SAR-1g (W/kg)	1st Repeated SAR-1g (W/kg)	L/S Ratio	2nd Repeated SAR-1g (W/kg)	L/S Ratio	3rd Repeated SAR-1g (W/kg)	L/S Ratio
WCDMA II	Rear Face	9538	1.11	1.09	1.02	N/A	N/A	N/A	N/A
WCDMA IV	Rear Face	1413	1.08	1.06	1.02	N/A	N/A	N/A	N/A
WCDMA V	Top Side	4132	0.805	0.795	1.01	N/A	N/A	N/A	N/A
LTE 2	Top Side	18700	1.06	0.997	1.06	N/A	N/A	N/A	N/A
LTE 4	Top Side	20050	0.955	0.943	1.01	N/A	N/A	N/A	N/A
LTE 5	Top Side	20450	1.11	1.09	1.02	N/A	N/A	N/A	N/A
LTE 12	Top Side	23130	1.01	0.990	1.02	N/A	N/A	N/A	N/A
LTE 13	Top Side	23230	0.984	0.973	1.01	N/A	N/A	N/A	N/A

FCC SAR Test Report

4.7.4 Simultaneous Multi-band Transmission Evaluation

<Estimated SAR Calculation>

According to KDB 447498 D01, when standalone SAR test exclusion applies to an antenna that transmits simultaneously with other antennas, the standalone SAR was estimated according to following formula to result in substantially conservative SAR values of ≤ 0.4 W/kg to determine simultaneous transmission SAR test exclusion.

$$\text{Estimated SAR} = \frac{\text{Max. Tune up Power}_{(mW)}}{\text{Min. Test Separation Distance}_{(mm)}} \times \frac{\sqrt{f_{(GHz)}}}{7.5}$$

If the minimum test separation distance is < 5 mm, a distance of 5 mm is used for estimated SAR calculation. When the test separation distance is > 50 mm, the 0.4 W/kg is used for SAR-1g.

WWAN (EM7455) + WLAN (QCNFA344A)

Mode / Band	Frequency (GHz)	Max. Tune-up Power (dBm)	Test Position	Separation Distance (mm)	Estimated SAR (W/kg)
WCDMA II	1.907	24.0	Body	5	0.40
WCDMA IV	1.752	24.0	Body	5	0.40
WCDMA V	1.907	24.0	Body	5	0.40
LTE 2	1.909	24.0	Body	5	0.40
LTE 4	1.754	24.0	Body	5	0.40
LTE 5	0.848	24.0	Body	5	0.40
LTE 7	2.567	23.0	Body	5	0.40
LTE 12	0.715	24.0	Body	5	0.40
LTE 13	0.784	24.0	Body	5	0.40
LTE 25	1.914	24.0	Body	5	0.40
LTE 26	0.848	24.0	Body	5	0.40
LTE 41	2.687	23.0	Body	5	0.40
WLAN 2.4G	2.462	13.5	Body	5	0.40
WLAN 5.2G	5.24	13.5	Body	5	0.40
WLAN 5.3G	5.32	13.5	Body	5	0.40
WLAN 5.6G	5.7	13.5	Body	5	0.40
WLAN 5.8G	5.8	13.5	Body	5	0.40
BT (DSS)	2.48	7.0	Body	5	0.21

Note:

1. The separation distance is determined from the outer housing of the EUT to the user.
2. When standalone SAR testing is not required, an estimated SAR can be applied to determine simultaneous transmission SAR test exclusion.

FCC SAR Test Report

WWAN (EM7455) + WLAN (8265NGW)

Mode / Band	Frequency (GHz)	Max. Tune-up Power (dBm)	Test Position	Separation Distance (mm)	Estimated SAR (W/kg)
WCDMA II	1.907	24.0	Body	5	0.40
WCDMA IV	1.752	24.0	Body	5	0.40
WCDMA V	1.907	24.0	Body	5	0.40
LTE 2	1.909	24.0	Body	5	0.40
LTE 4	1.754	24.0	Body	5	0.40
LTE 5	0.848	24.0	Body	5	0.40
LTE 7	2.567	23.0	Body	5	0.40
LTE 12	0.715	24.0	Body	5	0.40
LTE 13	0.784	24.0	Body	5	0.40
LTE 25	1.914	24.0	Body	5	0.40
LTE 26	0.848	24.0	Body	5	0.40
LTE 41	2.687	23.0	Body	5	0.40
WLAN 2.4G	2.462	15.0	Body	5	0.40
WLAN 5.2G	5.24	13.5	Body	5	0.40
WLAN 5.3G	5.32	13.5	Body	5	0.40
WLAN 5.6G	5.7	13.5	Body	5	0.40
WLAN 5.8G	5.8	13.5	Body	5	0.40
BT (DSS)	2.48	11.5	Body	5	0.40

Note:

1. The separation distance is determined from the outer housing of the EUT to the user.
2. When standalone SAR testing is not required, an estimated SAR can be applied to determine simultaneous transmission SAR test exclusion.

FCC SAR Test Report

<SAR Summation Analysis>

Simultaneous transmission SAR test exclusion is determined for each operating configuration and exposure condition according to the reported standalone SAR of each applicable simultaneous transmitting antenna. When the sum of SAR_{1g} of all simultaneously transmitting antennas in an operating mode and exposure condition combination is within the SAR limit (SAR_{1g} 1.6 W/kg), the simultaneous transmission SAR is not required. When the sum of SAR_{1g} is greater than the SAR limit (SAR_{1g} 1.6 W/kg), SAR test exclusion is determined by the SPLSR.

WWAN (EM7455) + WLAN (QCNFA344A)

Tablet PC Mode:

No.	Conditions (SAR1 + SAR2+ SAR3)	Exposure Condition	Test Position	Max. SAR1	Max. SAR2	Max. SAR3	SAR Summation	SPLSR Analysis
1	WCDMA II + WLAN (DTS) + BT (DSS)	Body	Rear Face	1.33	0.05	0	1.38	Σ SAR < 1.6, Not required
			Left Side	0.18	0	0.21	0.39	Σ SAR < 1.6, Not required
			Right Side	0.35	0.40	0.21	0.96	Σ SAR < 1.6, Not required
			Top Side	0.62	0.08	0	0.70	Σ SAR < 1.6, Not required
			Bottom Side	0.11	0.19	0	0.30	Σ SAR < 1.6, Not required
2	WCDMA II + WLAN (NII) + BT (DSS)	Body	Rear Face	1.33	0.22	0	1.55	Σ SAR < 1.6, Not required
			Left Side	0.18	0	0.21	0.39	Σ SAR < 1.6, Not required
			Right Side	0.35	0.40	0.21	0.96	Σ SAR < 1.6, Not required
			Top Side	0.62	0.61	0	1.23	Σ SAR < 1.6, Not required
			Bottom Side	0.11	0.55	0	0.66	Σ SAR < 1.6, Not required
3	WCDMA IV + WLAN (DTS) + BT (DSS)	Body	Rear Face	1.33	0.05	0	1.38	Σ SAR < 1.6, Not required
			Left Side	0.10	0	0.21	0.31	Σ SAR < 1.6, Not required
			Right Side	0.38	0.40	0.21	0.99	Σ SAR < 1.6, Not required
			Top Side	0.76	0.08	0	0.84	Σ SAR < 1.6, Not required
			Bottom Side	0.04	0.19	0	0.23	Σ SAR < 1.6, Not required
4	WCDMA IV + WLAN (NII) + BT (DSS)	Body	Rear Face	1.33	0.22	0	1.55	Σ SAR < 1.6, Not required
			Left Side	0.10	0	0.21	0.31	Σ SAR < 1.6, Not required
			Right Side	0.38	0.40	0.21	0.99	Σ SAR < 1.6, Not required
			Top Side	0.76	0.61	0	1.37	Σ SAR < 1.6, Not required
			Bottom Side	0.04	0.55	0	0.59	Σ SAR < 1.6, Not required

FCC SAR Test Report

No.	Conditions (SAR1 + SAR2+ SAR3)	Exposure Condition	Test Position	Max. SAR1	Max. SAR2	Max. SAR3	SAR Summation	SPLSR Analysis
5	WCDMA V + WLAN (DTS) + BT (DSS)	Body	Rear Face	0.54	0.05	0	0.59	Σ SAR < 1.6, Not required
			Left Side	0.01	0	0.21	0.22	Σ SAR < 1.6, Not required
			Right Side	0.10	0.40	0.21	0.71	Σ SAR < 1.6, Not required
			Top Side	0.85	0.08	0	0.93	Σ SAR < 1.6, Not required
			Bottom Side	0	0.19	0	0.19	Σ SAR < 1.6, Not required
6	WCDMA V + WLAN (NII) + BT (DSS)	Body	Rear Face	0.54	0.22	0	0.76	Σ SAR < 1.6, Not required
			Left Side	0.01	0	0.21	0.22	Σ SAR < 1.6, Not required
			Right Side	0.10	0.40	0.21	0.71	Σ SAR < 1.6, Not required
			Top Side	0.85	0.61	0	1.46	Σ SAR < 1.6, Not required
			Bottom Side	0	0.55	0	0.55	Σ SAR < 1.6, Not required
7	LTE 2 + WLAN (DTS) + BT (DSS)	Body	Rear Face	0.79	0.05	0	0.84	Σ SAR < 1.6, Not required
			Left Side	0.22	0	0.21	0.43	Σ SAR < 1.6, Not required
			Right Side	0.32	0.40	0.21	0.93	Σ SAR < 1.6, Not required
			Top Side	1.08	0.08	0	1.16	Σ SAR < 1.6, Not required
			Bottom Side	0.15	0.19	0	0.34	Σ SAR < 1.6, Not required
8	LTE 2 + WLAN (NII) + BT (DSS)	Body	Rear Face	0.79	0.22	0	1.01	Σ SAR < 1.6, Not required
			Left Side	0.22	0	0.21	0.43	Σ SAR < 1.6, Not required
			Right Side	0.32	0.40	0.21	0.93	Σ SAR < 1.6, Not required
			Top Side	1.08	0.61	0	1.69	Analyzed as below
			Bottom Side	0.15	0.55	0	0.70	Σ SAR < 1.6, Not required
9	LTE 4 + WLAN (DTS) + BT (DSS)	Body	Rear Face	0.86	0.05	0	0.91	Σ SAR < 1.6, Not required
			Left Side	0.10	0	0.21	0.31	Σ SAR < 1.6, Not required
			Right Side	0.28	0.40	0.21	0.89	Σ SAR < 1.6, Not required
			Top Side	0.97	0.08	0	1.05	Σ SAR < 1.6, Not required
			Bottom Side	0.02	0.19	0	0.21	Σ SAR < 1.6, Not required
10	LTE 4 + WLAN (NII) + BT (DSS)	Body	Rear Face	0.86	0.22	0	1.08	Σ SAR < 1.6, Not required
			Left Side	0.10	0	0.21	0.31	Σ SAR < 1.6, Not required
			Right Side	0.28	0.40	0.21	0.89	Σ SAR < 1.6, Not required
			Top Side	0.97	0.61	0	1.58	Σ SAR < 1.6, Not required
			Bottom Side	0.02	0.55	0	0.57	Σ SAR < 1.6, Not required

FCC SAR Test Report

No.	Conditions (SAR1 + SAR2 + SAR3)	Exposure Condition	Test Position	Max. SAR1	Max. SAR2	Max. SAR3	SAR Summation	SPLSR Analysis
11	LTE 5 + WLAN (DTS) + BT (DSS)	Body	Rear Face	0.70	0.05	0	0.75	Σ SAR < 1.6, Not required
			Left Side	0.02	0	0.21	0.23	Σ SAR < 1.6, Not required
			Right Side	0.13	0.40	0.21	0.74	Σ SAR < 1.6, Not required
			Top Side	1.15	0.08	0	1.23	Σ SAR < 1.6, Not required
			Bottom Side	0.03	0.19	0	0.22	Σ SAR < 1.6, Not required
12	LTE 5 + WLAN (NII) + BT (DSS)	Body	Rear Face	0.70	0.22	0	0.92	Σ SAR < 1.6, Not required
			Left Side	0.02	0	0.21	0.23	Σ SAR < 1.6, Not required
			Right Side	0.13	0.40	0.21	0.74	Σ SAR < 1.6, Not required
			Top Side	1.15	0.61	0	1.76	Analyzed as below
			Bottom Side	0.03	0.55	0	0.58	Σ SAR < 1.6, Not required
13	LTE 7 + WLAN (DTS) + BT (DSS)	Body	Rear Face	0.59	0.05	0	0.64	Σ SAR < 1.6, Not required
			Left Side	0	0	0.21	0.21	Σ SAR < 1.6, Not required
			Right Side	0.45	0.40	0.21	1.06	Σ SAR < 1.6, Not required
			Top Side	0.71	0.08	0	0.79	Σ SAR < 1.6, Not required
			Bottom Side	0	0.19	0	0.19	Σ SAR < 1.6, Not required
14	LTE 7 + WLAN (NII) + BT (DSS)	Body	Rear Face	0.59	0.22	0	0.81	Σ SAR < 1.6, Not required
			Left Side	0	0	0.21	0.21	Σ SAR < 1.6, Not required
			Right Side	0.45	0.40	0.21	1.06	Σ SAR < 1.6, Not required
			Top Side	0.71	0.61	0	1.32	Σ SAR < 1.6, Not required
			Bottom Side	0	0.55	0	0.55	Σ SAR < 1.6, Not required
15	LTE 12 + WLAN (DTS) + BT (DSS)	Body	Rear Face	0.86	0.05	0	0.91	Σ SAR < 1.6, Not required
			Left Side	0	0	0.21	0.21	Σ SAR < 1.6, Not required
			Right Side	0.25	0.40	0.21	0.86	Σ SAR < 1.6, Not required
			Top Side	1.02	0.08	0	1.10	Σ SAR < 1.6, Not required
			Bottom Side	0	0.19	0	0.19	Σ SAR < 1.6, Not required
16	LTE 12 + WLAN (NII) + BT (DSS)	Body	Rear Face	0.86	0.22	0	1.08	Σ SAR < 1.6, Not required
			Left Side	0	0	0.21	0.21	Σ SAR < 1.6, Not required
			Right Side	0.25	0.40	0.21	0.86	Σ SAR < 1.6, Not required
			Top Side	1.02	0.61	0	1.63	Analyzed as below
			Bottom Side	0	0.55	0	0.55	Σ SAR < 1.6, Not required

FCC SAR Test Report

No.	Conditions (SAR1 + SAR2 + SAR3)	Exposure Condition	Test Position	Max. SAR1	Max. SAR2	Max. SAR3	SAR Summation	SPLSR Analysis
17	LTE 13 + WLAN (DTS) + BT (DSS)	Body	Rear Face	0.76	0.05	0	0.81	Σ SAR < 1.6, Not required
			Left Side	0	0	0.21	0.21	Σ SAR < 1.6, Not required
			Right Side	0.13	0.40	0.21	0.74	Σ SAR < 1.6, Not required
			Top Side	1.04	0.08	0	1.12	Σ SAR < 1.6, Not required
			Bottom Side	0	0.19	0	0.19	Σ SAR < 1.6, Not required
18	LTE 13 + WLAN (NII) + BT (DSS)	Body	Rear Face	0.76	0.22	0	0.98	Σ SAR < 1.6, Not required
			Left Side	0	0	0.21	0.21	Σ SAR < 1.6, Not required
			Right Side	0.13	0.40	0.21	0.74	Σ SAR < 1.6, Not required
			Top Side	1.04	0.61	0	1.65	Analyzed as below
			Bottom Side	0	0.55	0	0.55	Σ SAR < 1.6, Not required
19	LTE 25 + WLAN (DTS) + BT (DSS)	Body	Rear Face	0.92	0.05	0	0.97	Σ SAR < 1.6, Not required
			Left Side	0.18	0	0.21	0.39	Σ SAR < 1.6, Not required
			Right Side	0.37	0.40	0.21	0.98	Σ SAR < 1.6, Not required
			Top Side	0.59	0.08	0	0.67	Σ SAR < 1.6, Not required
			Bottom Side	0.11	0.19	0	0.30	Σ SAR < 1.6, Not required
20	LTE 25 + WLAN (NII) + BT (DSS)	Body	Rear Face	0.92	0.22	0	1.14	Σ SAR < 1.6, Not required
			Left Side	0.18	0	0.21	0.39	Σ SAR < 1.6, Not required
			Right Side	0.37	0.40	0.21	0.98	Σ SAR < 1.6, Not required
			Top Side	0.59	0.61	0	1.20	Σ SAR < 1.6, Not required
			Bottom Side	0.11	0.55	0	0.66	Σ SAR < 1.6, Not required
21	LTE 26 + WLAN (DTS) + BT (DSS)	Body	Rear Face	0.63	0.05	0	0.68	Σ SAR < 1.6, Not required
			Left Side	0	0	0.21	0.21	Σ SAR < 1.6, Not required
			Right Side	0.12	0.40	0.21	0.73	Σ SAR < 1.6, Not required
			Top Side	0.46	0.08	0	0.54	Σ SAR < 1.6, Not required
			Bottom Side	0.04	0.19	0	0.23	Σ SAR < 1.6, Not required
22	LTE 26 + WLAN (NII) + BT (DSS)	Body	Rear Face	0.63	0.22	0	0.85	Σ SAR < 1.6, Not required
			Left Side	0	0	0.21	0.21	Σ SAR < 1.6, Not required
			Right Side	0.12	0.40	0.21	0.73	Σ SAR < 1.6, Not required
			Top Side	0.46	0.61	0	1.07	Σ SAR < 1.6, Not required
			Bottom Side	0.04	0.55	0	0.59	Σ SAR < 1.6, Not required

FCC SAR Test Report

No.	Conditions (SAR1 + SAR2 + SAR3)	Exposure Condition	Test Position	Max. SAR1	Max. SAR2	Max. SAR3	SAR Summation	SPLSR Analysis
23	LTE 41 + WLAN (DTS) + BT (DSS)	Body	Rear Face	0.33	0.05	0	0.38	Σ SAR < 1.6, Not required
			Left Side	0	0	0.21	0.21	Σ SAR < 1.6, Not required
			Right Side	0.24	0.40	0.21	0.85	Σ SAR < 1.6, Not required
			Top Side	0.75	0.08	0	0.83	Σ SAR < 1.6, Not required
			Bottom Side	0	0.19	0	0.19	Σ SAR < 1.6, Not required
24	LTE 41 + WLAN (NII) + BT (DSS)	Body	Rear Face	0.33	0.22	0	0.55	Σ SAR < 1.6, Not required
			Left Side	0	0	0.21	0.21	Σ SAR < 1.6, Not required
			Right Side	0.24	0.40	0.21	0.85	Σ SAR < 1.6, Not required
			Top Side	0.75	0.61	0	1.36	Σ SAR < 1.6, Not required
			Bottom Side	0	0.55	0	0.55	Σ SAR < 1.6, Not required

FCC SAR Test Report

Laptop PC Mode

No.	Conditions (SAR1 + SAR2 + SAR3)	Exposure Condition	Test Position	Max. SAR1	Max. SAR2	Max. SAR3	SAR Summation	SPLSR Analysis
1	WCDMA II + WLAN (DTS) + BT (DSS)	Body	Bottom Side	0.40	0.02	0.21	0.63	Σ SAR < 1.6, Not required
2	WCDMA II + WLAN (NII) + BT (DSS)	Body	Bottom Side	0.40	0.04	0.21	0.65	Σ SAR < 1.6, Not required
3	WCDMA IV + WLAN (DTS) + BT (DSS)	Body	Bottom Side	0.40	0.02	0.21	0.63	Σ SAR < 1.6, Not required
4	WCDMA IV + WLAN (NII) + BT (DSS)	Body	Bottom Side	0.40	0.04	0.21	0.65	Σ SAR < 1.6, Not required
5	WCDMA V + WLAN (DTS) + BT (DSS)	Body	Bottom Side	0.40	0.02	0.21	0.63	Σ SAR < 1.6, Not required
6	WCDMA V + WLAN (NII) + BT (DSS)	Body	Bottom Side	0.40	0.04	0.21	0.65	Σ SAR < 1.6, Not required
7	LTE 2 + WLAN (DTS) + BT (DSS)	Body	Bottom Side	0.40	0.02	0.21	0.63	Σ SAR < 1.6, Not required
8	LTE 2 + WLAN (NII) + BT (DSS)	Body	Bottom Side	0.40	0.04	0.21	0.65	Σ SAR < 1.6, Not required
9	LTE 4 + WLAN (DTS) + BT (DSS)	Body	Bottom Side	0.40	0.02	0.21	0.63	Σ SAR < 1.6, Not required
10	LTE 4 + WLAN (NII) + BT (DSS)	Body	Bottom Side	0.40	0.04	0.21	0.65	Σ SAR < 1.6, Not required

FCC SAR Test Report

No.	Conditions (SAR1 + SAR2 + SAR3)	Exposure Condition	Test Position	Max. SAR1	Max. SAR2	Max. SAR3	SAR Summation	SPLSR Analysis
11	LTE 5 + WLAN (DTS) + BT (DSS)	Body	Bottom Side	0.40	0.02	0.21	0.63	Σ SAR < 1.6, Not required
12	LTE 5 + WLAN (NII) + BT (DSS)	Body	Bottom Side	0.40	0.04	0.21	0.65	Σ SAR < 1.6, Not required
13	LTE 7 + WLAN (DTS) + BT (DSS)	Body	Bottom Side	0.40	0.02	0.21	0.63	Σ SAR < 1.6, Not required
14	LTE 7 + WLAN (NII) + BT (DSS)	Body	Bottom Side	0.40	0.04	0.21	0.65	Σ SAR < 1.6, Not required
15	LTE 12 + WLAN (DTS) + BT (DSS)	Body	Bottom Side	0.40	0.02	0.21	0.63	Σ SAR < 1.6, Not required
16	LTE 12 + WLAN (NII) + BT (DSS)	Body	Bottom Side	0.40	0.04	0.21	0.65	Σ SAR < 1.6, Not required
17	LTE 13 + WLAN (DTS) + BT (DSS)	Body	Bottom Side	0.40	0.02	0.21	0.63	Σ SAR < 1.6, Not required
18	LTE 13 + WLAN (NII) + BT (DSS)	Body	Bottom Side	0.40	0.04	0.21	0.65	Σ SAR < 1.6, Not required

FCC SAR Test Report

No.	Conditions (SAR1 + SAR2 + SAR3)	Exposure Condition	Test Position	Max. SAR1	Max. SAR2	Max. SAR3	SAR Summation	SPLSR Analysis
19	LTE 25 + WLAN (DTS) + BT (DSS)	Body	Bottom Side	0.40	0.02	0.21	0.63	Σ SAR < 1.6, Not required
20	LTE 25 + WLAN (NII) + BT (DSS)	Body	Bottom Side	0.40	0.04	0.21	0.65	Σ SAR < 1.6, Not required
21	LTE 26 + WLAN (DTS) + BT (DSS)	Body	Bottom Side	0.40	0.02	0.21	0.63	Σ SAR < 1.6, Not required
22	LTE 26 + WLAN (NII) + BT (DSS)	Body	Bottom Side	0.40	0.04	0.21	0.65	Σ SAR < 1.6, Not required
23	LTE 41 + WLAN (DTS) + BT (DSS)	Body	Bottom Side	0.40	0.02	0.21	0.63	Σ SAR < 1.6, Not required
24	LTE 41 + WLAN (NII) + BT (DSS)	Body	Bottom Side	0.40	0.04	0.21	0.65	Σ SAR < 1.6, Not required

FCC SAR Test Report

WWAN (EM7455) + WLAN (8265NGW)

Tablet PC Mode:

No.	Conditions (SAR1 + SAR2 + SAR3)	Exposure Condition	Test Position	Max. SAR1	Max. SAR2	Max. SAR3	SAR Summation	SPLSR Analysis
1	WCDMA II + WLAN Ant 0 (DTS) + WLAN Ant 1 (DTS)	Body	Rear Face	1.33	0.10	0.14	1.57	Σ SAR < 1.6, Not required
			Left Side	0.18	0.40	0.40	0.98	Σ SAR < 1.6, Not required
			Right Side	0.35	0.40	0.40	1.15	Σ SAR < 1.6, Not required
			Top Side	0.62	0.36	0	0.98	Σ SAR < 1.6, Not required
			Bottom Side	0.11	0.40	0.44	0.95	Σ SAR < 1.6, Not required
2	WCDMA II + WLAN Ant 0 (NII) + WLAN Ant 1 (NII)	Body	Rear Face	1.33	0.30	0.27	1.90	Analyzed as below
			Left Side	0.18	0.40	0.40	0.98	Σ SAR < 1.6, Not required
			Right Side	0.35	0.40	0.40	1.15	Σ SAR < 1.6, Not required
			Top Side	0.62	0.77	0	1.39	Σ SAR < 1.6, Not required
			Bottom Side	0.11	0	1.11	1.22	Σ SAR < 1.6, Not required
3	WCDMA II + WLAN Ant 0 (DTS) + BT (DSS) Ant 1	Body	Rear Face	1.33	0.10	0.06	1.49	Σ SAR < 1.6, Not required
			Left Side	0.18	0.40	0.40	0.98	Σ SAR < 1.6, Not required
			Right Side	0.35	0.40	0.40	1.15	Σ SAR < 1.6, Not required
			Top Side	0.62	0.36	0	0.98	Σ SAR < 1.6, Not required
			Bottom Side	0.11	0.40	0.20	0.71	Σ SAR < 1.6, Not required
4	WCDMA II + WLAN Ant 0 (NII) + BT (DSS) Ant 1	Body	Rear Face	1.33	0.30	0.06	1.69	Analyzed as below
			Left Side	0.18	0.40	0.40	0.98	Σ SAR < 1.6, Not required
			Right Side	0.35	0.40	0.40	1.15	Σ SAR < 1.6, Not required
			Top Side	0.62	0.77	0	1.39	Σ SAR < 1.6, Not required
			Bottom Side	0.11	0	0.20	0.31	Σ SAR < 1.6, Not required

FCC SAR Test Report

No.	Conditions (SAR1 + SAR2 + SAR3)	Exposure Condition	Test Position	Max. SAR1	Max. SAR2	Max. SAR3	SAR Summation	SPLSR Analysis
5	WCDMA IV + WLAN Ant 0 (DTS) + WLAN Ant 1 (DTS)	Body	Rear Face	1.33	0.10	0.14	1.57	Σ SAR < 1.6, Not required
			Left Side	0.10	0.40	0.40	0.90	Σ SAR < 1.6, Not required
			Right Side	0.38	0.40	0.40	1.18	Σ SAR < 1.6, Not required
			Top Side	0.76	0.36	0	1.12	Σ SAR < 1.6, Not required
			Bottom Side	0.04	0.40	0.44	0.88	Σ SAR < 1.6, Not required
6	WCDMA IV + WLAN Ant 0 (NII) + WLAN Ant 1 (NII)	Body	Rear Face	1.33	0.30	0.27	1.90	Analyzed as below
			Left Side	0.10	0.40	0.40	0.90	Σ SAR < 1.6, Not required
			Right Side	0.38	0.40	0.40	1.18	Σ SAR < 1.6, Not required
			Top Side	0.76	0.77	0	1.53	Σ SAR < 1.6, Not required
			Bottom Side	0.04	0	1.11	1.15	Σ SAR < 1.6, Not required
7	WCDMA IV + WLAN Ant 0 (DTS) + BT (DSS) Ant 1	Body	Rear Face	1.33	0.10	0.06	1.49	Σ SAR < 1.6, Not required
			Left Side	0.10	0.40	0.40	0.90	Σ SAR < 1.6, Not required
			Right Side	0.38	0.40	0.40	1.18	Σ SAR < 1.6, Not required
			Top Side	0.76	0.36	0	1.12	Σ SAR < 1.6, Not required
			Bottom Side	0.04	0.40	0.20	0.64	Σ SAR < 1.6, Not required
8	WCDMA IV + WLAN Ant 0 (NII) + BT (DSS) Ant 1	Body	Rear Face	1.33	0.30	0.06	1.69	Analyzed as below
			Left Side	0.10	0.40	0.40	0.90	Σ SAR < 1.6, Not required
			Right Side	0.38	0.40	0.40	1.18	Σ SAR < 1.6, Not required
			Top Side	0.76	0.77	0	1.53	Σ SAR < 1.6, Not required
			Bottom Side	0.04	0	0.20	0.24	Σ SAR < 1.6, Not required

FCC SAR Test Report

No.	Conditions (SAR1 + SAR2 + SAR3)	Exposure Condition	Test Position	Max. SAR1	Max. SAR2	Max. SAR3	SAR Summation	SPLSR Analysis
9	WCDMA V + WLAN Ant 0 (DTS) + WLAN Ant 1 (DTS)	Body	Rear Face	0.54	0.10	0.14	0.78	Σ SAR < 1.6, Not required
			Left Side	0.01	0.40	0.40	0.81	Σ SAR < 1.6, Not required
			Right Side	0.10	0.40	0.40	0.90	Σ SAR < 1.6, Not required
			Top Side	0.85	0.36	0	1.21	Σ SAR < 1.6, Not required
			Bottom Side	0	0.40	0.44	0.84	Σ SAR < 1.6, Not required
10	WCDMA V + WLAN Ant 0 (NII) + WLAN Ant 1 (NII)	Body	Rear Face	0.54	0.30	0.27	1.11	Σ SAR < 1.6, Not required
			Left Side	0.01	0.40	0.40	0.81	Σ SAR < 1.6, Not required
			Right Side	0.10	0.40	0.40	0.90	Σ SAR < 1.6, Not required
			Top Side	0.85	0.77	0	1.62	Analyzed as below
			Bottom Side	0	0	1.11	1.11	Σ SAR < 1.6, Not required
11	WCDMA V + WLAN Ant 0 (DTS) + BT (DSS) Ant 1	Body	Rear Face	0.54	0.10	0.06	0.70	Σ SAR < 1.6, Not required
			Left Side	0.01	0.40	0.40	0.81	Σ SAR < 1.6, Not required
			Right Side	0.10	0.40	0.40	0.90	Σ SAR < 1.6, Not required
			Top Side	0.85	0.36	0	1.21	Σ SAR < 1.6, Not required
			Bottom Side	0	0.40	0.20	0.60	Σ SAR < 1.6, Not required
12	WCDMA V + WLAN Ant 0 (NII) + BT (DSS) Ant 1	Body	Rear Face	0.54	0.30	0.06	0.90	Σ SAR < 1.6, Not required
			Left Side	0.01	0.40	0.40	0.81	Σ SAR < 1.6, Not required
			Right Side	0.10	0.40	0.40	0.90	Σ SAR < 1.6, Not required
			Top Side	0.85	0.77	0	1.62	Analyzed as below
			Bottom Side	0	0	0.20	0.20	Σ SAR < 1.6, Not required

FCC SAR Test Report

No.	Conditions (SAR1 + SAR2 + SAR3)	Exposure Condition	Test Position	Max. SAR1	Max. SAR2	Max. SAR3	SAR Summation	SPLSR Analysis
13	LTE 2 + WLAN Ant 0 (DTS) + WLAN Ant 1 (DTS)	Body	Rear Face	0.79	0.10	0.14	1.01	Σ SAR < 1.6, Not required
			Left Side	0.22	0.40	0.40	1.00	Σ SAR < 1.6, Not required
			Right Side	0.32	0.40	0.40	1.08	Σ SAR < 1.6, Not required
			Top Side	1.08	0.36	0	1.44	Σ SAR < 1.6, Not required
			Bottom Side	0.15	0.40	0.44	0.98	Σ SAR < 1.6, Not required
14	LTE 2 + WLAN Ant 0 (NII) + WLAN Ant 1 (NII)	Body	Rear Face	0.79	0.30	0.27	1.34	Σ SAR < 1.6, Not required
			Left Side	0.22	0.40	0.40	1.00	Σ SAR < 1.6, Not required
			Right Side	0.32	0.40	0.40	1.08	Σ SAR < 1.6, Not required
			Top Side	1.08	0.77	0	1.85	Analyzed as below
			Bottom Side	0.15	0	1.11	1.25	Σ SAR < 1.6, Not required
15	LTE 2 + WLAN Ant 0 (DTS) + BT (DSS) Ant 1	Body	Rear Face	0.79	0.10	0.06	0.93	Σ SAR < 1.6, Not required
			Left Side	0.22	0.40	0.40	1.00	Σ SAR < 1.6, Not required
			Right Side	0.32	0.40	0.40	1.08	Σ SAR < 1.6, Not required
			Top Side	1.08	0.36	0	1.44	Σ SAR < 1.6, Not required
			Bottom Side	0.15	0.40	0.20	0.74	Σ SAR < 1.6, Not required
16	LTE 2 + WLAN Ant 0 (NII) + BT (DSS) Ant 1	Body	Rear Face	0.79	0.30	0.06	1.13	Σ SAR < 1.6, Not required
			Left Side	0.22	0.40	0.40	1.00	Σ SAR < 1.6, Not required
			Right Side	0.32	0.40	0.40	1.08	Σ SAR < 1.6, Not required
			Top Side	1.08	0.77	0	1.85	Analyzed as below
			Bottom Side	0.15	0	0.20	0.34	Σ SAR < 1.6, Not required

FCC SAR Test Report

No.	Conditions (SAR1 + SAR2 + SAR3)	Exposure Condition	Test Position	Max. SAR1	Max. SAR2	Max. SAR3	SAR Summation	SPLSR Analysis
17	LTE 4 + WLAN Ant 0 (DTS) + WLAN Ant 1 (DTS)	Body	Rear Face	0.86	0.10	0.14	1.10	Σ SAR < 1.6, Not required
			Left Side	0.10	0.40	0.40	0.90	Σ SAR < 1.6, Not required
			Right Side	0.28	0.40	0.40	1.08	Σ SAR < 1.6, Not required
			Top Side	0.97	0.36	0	1.33	Σ SAR < 1.6, Not required
			Bottom Side	0.02	0.40	0.44	0.86	Σ SAR < 1.6, Not required
18	LTE 4 + WLAN Ant 0 (NII) + WLAN Ant 1 (NII)	Body	Rear Face	0.86	0.30	0.27	1.43	Σ SAR < 1.6, Not required
			Left Side	0.10	0.40	0.40	0.90	Σ SAR < 1.6, Not required
			Right Side	0.28	0.40	0.40	1.08	Σ SAR < 1.6, Not required
			Top Side	0.97	0.77	0	1.74	Analyzed as below
			Bottom Side	0.02	0	1.11	1.13	Σ SAR < 1.6, Not required
19	LTE 4 + WLAN Ant 0 (DTS) + BT (DSS) Ant 1	Body	Rear Face	0.86	0.10	0.06	1.02	Σ SAR < 1.6, Not required
			Left Side	0.10	0.40	0.40	0.90	Σ SAR < 1.6, Not required
			Right Side	0.28	0.40	0.40	1.08	Σ SAR < 1.6, Not required
			Top Side	0.97	0.36	0	1.33	Σ SAR < 1.6, Not required
			Bottom Side	0.02	0.40	0.20	0.62	Σ SAR < 1.6, Not required
20	LTE 4 + WLAN Ant 0 (NII) + BT (DSS) Ant 1	Body	Rear Face	0.86	0.30	0.06	1.22	Σ SAR < 1.6, Not required
			Left Side	0.10	0.40	0.40	0.90	Σ SAR < 1.6, Not required
			Right Side	0.28	0.40	0.40	1.08	Σ SAR < 1.6, Not required
			Top Side	0.97	0.77	0	1.74	Analyzed as below
			Bottom Side	0.02	0	0.20	0.22	Σ SAR < 1.6, Not required

FCC SAR Test Report

No.	Conditions (SAR1 + SAR2 + SAR3)	Exposure Condition	Test Position	Max. SAR1	Max. SAR2	Max. SAR3	SAR Summation	SPLSR Analysis
21	LTE 5 + WLAN Ant 0 (DTS) + WLAN Ant 1 (DTS)	Body	Rear Face	0.70	0.10	0.14	0.94	Σ SAR < 1.6, Not required
			Left Side	0.02	0.40	0.40	0.82	Σ SAR < 1.6, Not required
			Right Side	0.13	0.40	0.40	0.93	Σ SAR < 1.6, Not required
			Top Side	1.15	0.36	0	1.51	Σ SAR < 1.6, Not required
			Bottom Side	0.03	0.40	0.44	0.87	Σ SAR < 1.6, Not required
22	LTE 5 + WLAN Ant 0 (NII) + WLAN Ant 1 (NII)	Body	Rear Face	0.70	0.30	0.27	1.27	Σ SAR < 1.6, Not required
			Left Side	0.02	0.40	0.40	0.82	Σ SAR < 1.6, Not required
			Right Side	0.13	0.40	0.40	0.93	Σ SAR < 1.6, Not required
			Top Side	1.15	0.77	0	1.92	Analyzed as below
			Bottom Side	0.03	0	1.11	1.14	Σ SAR < 1.6, Not required
23	LTE 5 + WLAN Ant 0 (DTS) + BT (DSS) Ant 1	Body	Rear Face	0.70	0.10	0.06	0.86	Σ SAR < 1.6, Not required
			Left Side	0.02	0.40	0.40	0.82	Σ SAR < 1.6, Not required
			Right Side	0.13	0.40	0.40	0.93	Σ SAR < 1.6, Not required
			Top Side	1.15	0.36	0	1.51	Σ SAR < 1.6, Not required
			Bottom Side	0.03	0.40	0.20	0.63	Σ SAR < 1.6, Not required
24	LTE 5 + WLAN Ant 0 (NII) + BT (DSS) Ant 1	Body	Rear Face	0.70	0.30	0.06	1.06	Σ SAR < 1.6, Not required
			Left Side	0.02	0.40	0.40	0.82	Σ SAR < 1.6, Not required
			Right Side	0.13	0.40	0.40	0.93	Σ SAR < 1.6, Not required
			Top Side	1.15	0.77	0	1.92	Analyzed as below
			Bottom Side	0.03	0	0.20	0.23	Σ SAR < 1.6, Not required

FCC SAR Test Report

No.	Conditions (SAR1 + SAR2 + SAR3)	Exposure Condition	Test Position	Max. SAR1	Max. SAR2	Max. SAR3	SAR Summation	SPLSR Analysis
25	LTE 7 + WLAN Ant 0 (DTS) + WLAN Ant 1 (DTS)	Body	Rear Face	0.59	0.10	0.14	0.83	Σ SAR < 1.6, Not required
			Left Side	0	0.40	0.40	0.80	Σ SAR < 1.6, Not required
			Right Side	0.45	0.40	0.40	1.25	Σ SAR < 1.6, Not required
			Top Side	0.71	0.36	0	1.07	Σ SAR < 1.6, Not required
			Bottom Side	0	0.40	0.44	0.84	Σ SAR < 1.6, Not required
26	LTE 7 + WLAN Ant 0 (NII) + WLAN Ant 1 (NII)	Body	Rear Face	0.59	0.30	0.27	1.16	Σ SAR < 1.6, Not required
			Left Side	0	0.40	0.40	0.80	Σ SAR < 1.6, Not required
			Right Side	0.45	0.40	0.40	1.25	Σ SAR < 1.6, Not required
			Top Side	0.71	0.77	0	1.48	Σ SAR < 1.6, Not required
			Bottom Side	0	0	1.11	1.11	Σ SAR < 1.6, Not required
27	LTE 7 + WLAN Ant 0 (DTS) + BT (DSS) Ant 1	Body	Rear Face	0.59	0.10	0.06	0.75	Σ SAR < 1.6, Not required
			Left Side	0	0.40	0.40	0.80	Σ SAR < 1.6, Not required
			Right Side	0.45	0.40	0.40	1.25	Σ SAR < 1.6, Not required
			Top Side	0.71	0.36	0	1.07	Σ SAR < 1.6, Not required
			Bottom Side	0	0.40	0.20	0.60	Σ SAR < 1.6, Not required
28	LTE 7 + WLAN Ant 0 (NII) + BT (DSS) Ant 1	Body	Rear Face	0.59	0.30	0.06	0.95	Σ SAR < 1.6, Not required
			Left Side	0	0.40	0.40	0.80	Σ SAR < 1.6, Not required
			Right Side	0.45	0.40	0.40	1.25	Σ SAR < 1.6, Not required
			Top Side	0.71	0.77	0	1.48	Σ SAR < 1.6, Not required
			Bottom Side	0	0	0.20	0.20	Σ SAR < 1.6, Not required

FCC SAR Test Report

No.	Conditions (SAR1 + SAR2 + SAR3)	Exposure Condition	Test Position	Max. SAR1	Max. SAR2	Max. SAR3	SAR Summation	SPLSR Analysis
29	LTE 12 + WLAN Ant 0 (DTS) + WLAN Ant 1 (DTS)	Body	Rear Face	0.86	0.10	0.14	1.10	Σ SAR < 1.6, Not required
			Left Side	0	0.40	0.40	0.80	Σ SAR < 1.6, Not required
			Right Side	0.25	0.40	0.40	1.05	Σ SAR < 1.6, Not required
			Top Side	1.02	0.36	0	1.38	Σ SAR < 1.6, Not required
			Bottom Side	0	0.40	0.44	0.84	Σ SAR < 1.6, Not required
30	LTE 12 + WLAN Ant 0 (NII) + WLAN Ant 1 (NII)	Body	Rear Face	0.86	0.30	0.27	1.43	Σ SAR < 1.6, Not required
			Left Side	0	0.40	0.40	0.80	Σ SAR < 1.6, Not required
			Right Side	0.25	0.40	0.40	1.05	Σ SAR < 1.6, Not required
			Top Side	1.02	0.77	0	1.79	Analyzed as below
			Bottom Side	0	0	1.11	1.11	Σ SAR < 1.6, Not required
31	LTE 12 + WLAN Ant 0 (DTS) + BT (DSS) Ant 1	Body	Rear Face	0.86	0.10	0.06	1.02	Σ SAR < 1.6, Not required
			Left Side	0	0.40	0.40	0.80	Σ SAR < 1.6, Not required
			Right Side	0.25	0.40	0.40	1.05	Σ SAR < 1.6, Not required
			Top Side	1.02	0.36	0	1.38	Σ SAR < 1.6, Not required
			Bottom Side	0	0.40	0.20	0.60	Σ SAR < 1.6, Not required
32	LTE 12 + WLAN Ant 0 (NII) + BT (DSS) Ant 1	Body	Rear Face	0.86	0.30	0.06	1.22	Σ SAR < 1.6, Not required
			Left Side	0	0.40	0.40	0.80	Σ SAR < 1.6, Not required
			Right Side	0.25	0.40	0.40	1.05	Σ SAR < 1.6, Not required
			Top Side	1.02	0.77	0	1.79	Analyzed as below
			Bottom Side	0	0	0.20	0.20	Σ SAR < 1.6, Not required

FCC SAR Test Report

No.	Conditions (SAR1 + SAR2 + SAR3)	Exposure Condition	Test Position	Max. SAR1	Max. SAR2	Max. SAR3	SAR Summation	SPLSR Analysis
33	LTE 13 + WLAN Ant 0 (DTS) + WLAN Ant 1 (DTS)	Body	Rear Face	0.76	0.10	0.14	1.00	Σ SAR < 1.6, Not required
			Left Side	0	0.40	0.40	0.80	Σ SAR < 1.6, Not required
			Right Side	0.13	0.40	0.40	0.93	Σ SAR < 1.6, Not required
			Top Side	1.04	0.36	0	1.40	Σ SAR < 1.6, Not required
			Bottom Side	0	0.40	0.44	0.84	Σ SAR < 1.6, Not required
34	LTE 13 + WLAN Ant 0 (NII) + WLAN Ant 1 (NII)	Body	Rear Face	0.76	0.30	0.27	1.33	Σ SAR < 1.6, Not required
			Left Side	0	0.40	0.40	0.80	Σ SAR < 1.6, Not required
			Right Side	0.13	0.40	0.40	0.93	Σ SAR < 1.6, Not required
			Top Side	1.04	0.77	0	1.81	Analyzed as below
			Bottom Side	0	0	1.11	1.11	Σ SAR < 1.6, Not required
35	LTE 13 + WLAN Ant 0 (DTS) + BT (DSS) Ant 1	Body	Rear Face	0.76	0.10	0.06	0.92	Σ SAR < 1.6, Not required
			Left Side	0	0.40	0.40	0.80	Σ SAR < 1.6, Not required
			Right Side	0.13	0.40	0.40	0.93	Σ SAR < 1.6, Not required
			Top Side	1.04	0.36	0	1.40	Σ SAR < 1.6, Not required
			Bottom Side	0	0.40	0.20	0.60	Σ SAR < 1.6, Not required
36	LTE 13 + WLAN Ant 0 (NII) + BT (DSS) Ant 1	Body	Rear Face	0.76	0.30	0.06	1.12	Σ SAR < 1.6, Not required
			Left Side	0	0.40	0.40	0.80	Σ SAR < 1.6, Not required
			Right Side	0.13	0.40	0.40	0.93	Σ SAR < 1.6, Not required
			Top Side	1.04	0.77	0	1.81	Analyzed as below
			Bottom Side	0	0	0.20	0.20	Σ SAR < 1.6, Not required

FCC SAR Test Report

No.	Conditions (SAR1 + SAR2 + SAR3)	Exposure Condition	Test Position	Max. SAR1	Max. SAR2	Max. SAR3	SAR Summation	SPLSR Analysis
37	LTE 25 + WLAN Ant 0 (DTS) + WLAN Ant 1 (DTS)	Body	Rear Face	0.92	0.10	0.14	1.16	Σ SAR < 1.6, Not required
			Left Side	0.18	0.40	0.40	0.98	Σ SAR < 1.6, Not required
			Right Side	0.37	0.40	0.40	1.17	Σ SAR < 1.6, Not required
			Top Side	0.59	0.36	0	0.95	Σ SAR < 1.6, Not required
			Bottom Side	0.11	0.40	0.44	0.95	Σ SAR < 1.6, Not required
38	LTE 25 + WLAN Ant 0 (NII) + WLAN Ant 1 (NII)	Body	Rear Face	0.92	0.30	0.27	1.49	Σ SAR < 1.6, Not required
			Left Side	0.18	0.40	0.40	0.98	Σ SAR < 1.6, Not required
			Right Side	0.37	0.40	0.40	1.17	Σ SAR < 1.6, Not required
			Top Side	0.59	0.77	0	1.36	Σ SAR < 1.6, Not required
			Bottom Side	0.11	0	1.11	1.22	Σ SAR < 1.6, Not required
39	LTE 25 + WLAN Ant 0 (DTS) + BT (DSS) Ant 1	Body	Rear Face	0.92	0.10	0.06	1.08	Σ SAR < 1.6, Not required
			Left Side	0.18	0.40	0.40	0.98	Σ SAR < 1.6, Not required
			Right Side	0.37	0.40	0.40	1.17	Σ SAR < 1.6, Not required
			Top Side	0.59	0.36	0	0.95	Σ SAR < 1.6, Not required
			Bottom Side	0.11	0.40	0.20	0.71	Σ SAR < 1.6, Not required
40	LTE 25 + WLAN Ant 0 (NII) + BT (DSS) Ant 1	Body	Rear Face	0.92	0.30	0.06	1.28	Σ SAR < 1.6, Not required
			Left Side	0.18	0.40	0.40	0.98	Σ SAR < 1.6, Not required
			Right Side	0.37	0.40	0.40	1.17	Σ SAR < 1.6, Not required
			Top Side	0.59	0.77	0	1.36	Σ SAR < 1.6, Not required
			Bottom Side	0.11	0	0.20	0.31	Σ SAR < 1.6, Not required

FCC SAR Test Report

No.	Conditions (SAR1 + SAR2 + SAR3)	Exposure Condition	Test Position	Max. SAR1	Max. SAR2	Max. SAR3	SAR Summation	SPLSR Analysis
41	LTE 26 + WLAN Ant 0 (DTS) + WLAN Ant 1 (DTS)	Body	Rear Face	0.63	0.10	0.14	0.87	Σ SAR < 1.6, Not required
			Left Side	0	0.40	0.40	0.80	Σ SAR < 1.6, Not required
			Right Side	0.12	0.40	0.40	0.92	Σ SAR < 1.6, Not required
			Top Side	0.46	0.36	0	0.82	Σ SAR < 1.6, Not required
			Bottom Side	0.04	0.40	0.44	0.88	Σ SAR < 1.6, Not required
42	LTE 26 + WLAN Ant 0 (NII) + WLAN Ant 1 (NII)	Body	Rear Face	0.63	0.30	0.27	1.20	Σ SAR < 1.6, Not required
			Left Side	0	0.40	0.40	0.80	Σ SAR < 1.6, Not required
			Right Side	0.12	0.40	0.40	0.92	Σ SAR < 1.6, Not required
			Top Side	0.46	0.77	0	1.23	Σ SAR < 1.6, Not required
			Bottom Side	0.04	0	1.11	1.15	Σ SAR < 1.6, Not required
43	LTE 26 + WLAN Ant 0 (DTS) + BT (DSS) Ant 1	Body	Rear Face	0.63	0.10	0.06	0.79	Σ SAR < 1.6, Not required
			Left Side	0	0.40	0.40	0.80	Σ SAR < 1.6, Not required
			Right Side	0.12	0.40	0.40	0.92	Σ SAR < 1.6, Not required
			Top Side	0.46	0.36	0	0.82	Σ SAR < 1.6, Not required
			Bottom Side	0.04	0.40	0.20	0.64	Σ SAR < 1.6, Not required
44	LTE 26 + WLAN Ant 0 (NII) + BT (DSS) Ant 1	Body	Rear Face	0.63	0.30	0.06	0.99	Σ SAR < 1.6, Not required
			Left Side	0	0.40	0.40	0.80	Σ SAR < 1.6, Not required
			Right Side	0.12	0.40	0.40	0.92	Σ SAR < 1.6, Not required
			Top Side	0.46	0.77	0	1.23	Σ SAR < 1.6, Not required
			Bottom Side	0.04	0	0.20	0.24	Σ SAR < 1.6, Not required

FCC SAR Test Report

No.	Conditions (SAR1 + SAR2 + SAR3)	Exposure Condition	Test Position	Max. SAR1	Max. SAR2	Max. SAR3	SAR Summation	SPLSR Analysis
45	LTE 41 + WLAN Ant 0 (DTS) + WLAN Ant 1 (DTS)	Body	Rear Face	0.33	0.10	0.14	0.57	Σ SAR < 1.6, Not required
			Left Side	0	0.40	0.40	0.80	Σ SAR < 1.6, Not required
			Right Side	0.24	0.40	0.40	1.04	Σ SAR < 1.6, Not required
			Top Side	0.75	0.36	0	1.11	Σ SAR < 1.6, Not required
			Bottom Side	0	0.40	0.44	0.84	Σ SAR < 1.6, Not required
46	LTE 41 + WLAN Ant 0 (NII) + WLAN Ant 1 (NII)	Body	Rear Face	0.33	0.30	0.27	0.90	Σ SAR < 1.6, Not required
			Left Side	0	0.40	0.40	0.80	Σ SAR < 1.6, Not required
			Right Side	0.24	0.40	0.40	1.04	Σ SAR < 1.6, Not required
			Top Side	0.75	0.77	0	1.52	Σ SAR < 1.6, Not required
			Bottom Side	0	0	1.11	1.11	Σ SAR < 1.6, Not required
47	LTE 41 + WLAN Ant 0 (DTS) + BT (DSS) Ant 1	Body	Rear Face	0.33	0.10	0.06	0.49	Σ SAR < 1.6, Not required
			Left Side	0	0.40	0.40	0.80	Σ SAR < 1.6, Not required
			Right Side	0.24	0.40	0.40	1.04	Σ SAR < 1.6, Not required
			Top Side	0.75	0.36	0	1.11	Σ SAR < 1.6, Not required
			Bottom Side	0	0.40	0.20	0.60	Σ SAR < 1.6, Not required
48	LTE 41 + WLAN Ant 0 (NII) + BT (DSS) Ant 1	Body	Rear Face	0.33	0.30	0.06	0.69	Σ SAR < 1.6, Not required
			Left Side	0	0.40	0.40	0.80	Σ SAR < 1.6, Not required
			Right Side	0.24	0.40	0.40	1.04	Σ SAR < 1.6, Not required
			Top Side	0.75	0.77	0	1.52	Σ SAR < 1.6, Not required
			Bottom Side	0	0	0.20	0.20	Σ SAR < 1.6, Not required

FCC SAR Test Report

Laptop PC Mode

No.	Conditions (SAR1 + SAR2 + SAR3)	Exposure Condition	Test Position	Max. SAR1	Max. SAR2	Max. SAR3	SAR Summation	SPLSR Analysis
1	WCDMA II + WLAN Ant 0 (DTS) + WLAN Ant 1 (DTS)	Body	Bottom Side	0.40	0.40	0.06	0.86	Σ SAR < 1.6, Not required
2	WCDMA II + WLAN Ant 0 (NII) + WLAN Ant 1 (NII)	Body	Bottom Side	0.40	0.40	0.10	0.90	Σ SAR < 1.6, Not required
3	WCDMA II + WLAN Ant 0 (DTS) + BT (DSS) Ant 1	Body	Bottom Side	0.40	0.40	0.03	0.83	Σ SAR < 1.6, Not required
4	WCDMA II + WLAN Ant 0 (NII) + BT (DSS) Ant 1	Body	Bottom Side	0.40	0.40	0.03	0.83	Σ SAR < 1.6, Not required

FCC SAR Test Report

No.	Conditions (SAR1 + SAR2 + SAR3)	Exposure Condition	Test Position	Max. SAR1	Max. SAR2	Max. SAR3	SAR Summation	SPLSR Analysis
5	WCDMA IV + WLAN Ant 0 (DTS) + WLAN Ant 1 (DTS)	Body	Bottom Side	0.40	0.40	0.06	0.86	Σ SAR < 1.6, Not required
6	WCDMA IV + WLAN Ant 0 (NII) + WLAN Ant 1 (NII)	Body	Bottom Side	0.40	0.40	0.10	0.90	Σ SAR < 1.6, Not required
7	WCDMA IV + WLAN Ant 0 (DTS) + BT (DSS) Ant 1	Body	Bottom Side	0.40	0.40	0.03	0.83	Σ SAR < 1.6, Not required
8	WCDMA IV + WLAN Ant 0 (NII) + BT (DSS) Ant 1	Body	Bottom Side	0.40	0.40	0.03	0.83	Σ SAR < 1.6, Not required

FCC SAR Test Report

No.	Conditions (SAR1 + SAR2 + SAR3)	Exposure Condition	Test Position	Max. SAR1	Max. SAR2	Max. SAR3	SAR Summation	SPLSR Analysis
9	WCDMA V + WLAN Ant 0 (DTS) + WLAN Ant 1 (DTS)	Body	Bottom Side	0.40	0.40	0.06	0.86	Σ SAR < 1.6, Not required
10	WCDMA V + WLAN Ant 0 (NII) + WLAN Ant 1 (NII)	Body	Bottom Side	0.40	0.40	0.10	0.90	Σ SAR < 1.6, Not required
11	WCDMA V + WLAN Ant 0 (DTS) + BT (DSS) Ant 1	Body	Bottom Side	0.40	0.40	0.03	0.83	Σ SAR < 1.6, Not required
12	WCDMA V + WLAN Ant 0 (NII) + BT (DSS) Ant 1	Body	Bottom Side	0.40	0.40	0.03	0.83	Σ SAR < 1.6, Not required

FCC SAR Test Report

No.	Conditions (SAR1 + SAR2 + SAR3)	Exposure Condition	Test Position	Max. SAR1	Max. SAR2	Max. SAR3	SAR Summation	SPLSR Analysis
13	LTE 2 + WLAN Ant 0 (DTS) + WLAN Ant 1 (DTS)	Body	Bottom Side	0.40	0.40	0.06	0.86	Σ SAR < 1.6, Not required
14	LTE 2 + WLAN Ant 0 (NII) + WLAN Ant 1 (NII)	Body	Bottom Side	0.40	0.40	0.10	0.90	Σ SAR < 1.6, Not required
15	LTE 2 + WLAN Ant 0 (DTS) + BT (DSS) Ant 1	Body	Bottom Side	0.40	0.40	0.03	0.83	Σ SAR < 1.6, Not required
16	LTE 2 + WLAN Ant 0 (NII) + BT (DSS) Ant 1	Body	Bottom Side	0.40	0.40	0.03	0.83	Σ SAR < 1.6, Not required

FCC SAR Test Report

No.	Conditions (SAR1 + SAR2 + SAR3)	Exposure Condition	Test Position	Max. SAR1	Max. SAR2	Max. SAR3	SAR Summation	SPLSR Analysis
17	LTE 4 + WLAN Ant 0 (DTS) + WLAN Ant 1 (DTS)	Body	Bottom Side	0.40	0.40	0.06	0.86	Σ SAR < 1.6, Not required
18	LTE 4 + WLAN Ant 0 (NII) + WLAN Ant 1 (NII)	Body	Bottom Side	0.40	0.40	0.10	0.90	Σ SAR < 1.6, Not required
19	LTE 4 + WLAN Ant 0 (DTS) + BT (DSS) Ant 1	Body	Bottom Side	0.40	0.40	0.03	0.83	Σ SAR < 1.6, Not required
20	LTE 4 + WLAN Ant 0 (NII) + BT (DSS) Ant 1	Body	Bottom Side	0.40	0.40	0.03	0.83	Σ SAR < 1.6, Not required

FCC SAR Test Report

No.	Conditions (SAR1 + SAR2 + SAR3)	Exposure Condition	Test Position	Max. SAR1	Max. SAR2	Max. SAR3	SAR Summation	SPLSR Analysis
21	LTE 5 + WLAN Ant 0 (DTS) + WLAN Ant 1 (DTS)	Body	Bottom Side	0.40	0.40	0.06	0.86	Σ SAR < 1.6, Not required
22	LTE 5 + WLAN Ant 0 (NII) + WLAN Ant 1 (NII)	Body	Bottom Side	0.40	0.40	0.10	0.90	Σ SAR < 1.6, Not required
23	LTE 5 + WLAN Ant 0 (DTS) + BT (DSS) Ant 1	Body	Bottom Side	0.40	0.40	0.03	0.83	Σ SAR < 1.6, Not required
24	LTE 5 + WLAN Ant 0 (NII) + BT (DSS) Ant 1	Body	Bottom Side	0.40	0.40	0.03	0.83	Σ SAR < 1.6, Not required

FCC SAR Test Report

No.	Conditions (SAR1 + SAR2 + SAR3)	Exposure Condition	Test Position	Max. SAR1	Max. SAR2	Max. SAR3	SAR Summation	SPLSR Analysis
25	LTE 7 + WLAN Ant 0 (DTS) + WLAN Ant 1 (DTS)	Body	Bottom Side	0.40	0.40	0.06	0.86	Σ SAR < 1.6, Not required
26	LTE 7 + WLAN Ant 0 (NII) + WLAN Ant 1 (NII)	Body	Bottom Side	0.40	0.40	0.10	0.90	Σ SAR < 1.6, Not required
27	LTE 7 + WLAN Ant 0 (DTS) + BT (DSS) Ant 1	Body	Bottom Side	0.40	0.40	0.03	0.83	Σ SAR < 1.6, Not required
28	LTE 7 + WLAN Ant 0 (NII) + BT (DSS) Ant 1	Body	Bottom Side	0.40	0.40	0.03	0.83	Σ SAR < 1.6, Not required

FCC SAR Test Report

No.	Conditions (SAR1 + SAR2 + SAR3)	Exposure Condition	Test Position	Max. SAR1	Max. SAR2	Max. SAR3	SAR Summation	SPLSR Analysis
29	LTE 12 + WLAN Ant 0 (DTS) + WLAN Ant 1 (DTS)	Body	Bottom Side	0.40	0.40	0.06	0.86	Σ SAR < 1.6, Not required
30	LTE 12 + WLAN Ant 0 (NII) + WLAN Ant 1 (NII)	Body	Bottom Side	0.40	0.40	0.10	0.90	Σ SAR < 1.6, Not required
31	LTE 12 + WLAN Ant 0 (DTS) + BT (DSS) Ant 1	Body	Bottom Side	0.40	0.40	0.03	0.83	Σ SAR < 1.6, Not required
32	LTE 12 + WLAN Ant 0 (NII) + BT (DSS) Ant 1	Body	Bottom Side	0.40	0.40	0.03	0.83	Σ SAR < 1.6, Not required

FCC SAR Test Report

No.	Conditions (SAR1 + SAR2 + SAR3)	Exposure Condition	Test Position	Max. SAR1	Max. SAR2	Max. SAR3	SAR Summation	SPLSR Analysis
33	LTE 13 + WLAN Ant 0 (DTS) + WLAN Ant 1 (DTS)	Body	Bottom Side	0.40	0.40	0.06	0.86	Σ SAR < 1.6, Not required
34	LTE 13 + WLAN Ant 0 (NII) + WLAN Ant 1 (NII)	Body	Bottom Side	0.40	0.40	0.10	0.90	Σ SAR < 1.6, Not required
35	LTE 13 + WLAN Ant 0 (DTS) + BT (DSS) Ant 1	Body	Bottom Side	0.40	0.40	0.03	0.83	Σ SAR < 1.6, Not required
36	LTE 13 + WLAN Ant 0 (NII) + BT (DSS) Ant 1	Body	Bottom Side	0.40	0.40	0.03	0.83	Σ SAR < 1.6, Not required

FCC SAR Test Report

No.	Conditions (SAR1 + SAR2 + SAR3)	Exposure Condition	Test Position	Max. SAR1	Max. SAR2	Max. SAR3	SAR Summation	SPLSR Analysis
37	LTE 25 + WLAN Ant 0 (DTS) + WLAN Ant 1 (DTS)	Body	Bottom Side	0.40	0.40	0.06	0.86	Σ SAR < 1.6, Not required
38	LTE 25 + WLAN Ant 0 (NII) + WLAN Ant 1 (NII)	Body	Bottom Side	0.40	0.40	0.10	0.90	Σ SAR < 1.6, Not required
39	LTE 25 + WLAN Ant 0 (DTS) + BT (DSS) Ant 1	Body	Bottom Side	0.40	0.40	0.03	0.83	Σ SAR < 1.6, Not required
40	LTE 25 + WLAN Ant 0 (NII) + BT (DSS) Ant 1	Body	Bottom Side	0.40	0.40	0.03	0.83	Σ SAR < 1.6, Not required

FCC SAR Test Report

No.	Conditions (SAR1 + SAR2 + SAR3)	Exposure Condition	Test Position	Max. SAR1	Max. SAR2	Max. SAR3	SAR Summation	SPLSR Analysis
41	LTE 26 + WLAN Ant 0 (DTS) + WLAN Ant 1 (DTS)	Body	Bottom Side	0.40	0.40	0.06	0.86	Σ SAR < 1.6, Not required
42	LTE 26 + WLAN Ant 0 (NII) + WLAN Ant 1 (NII)	Body	Bottom Side	0.40	0.40	0.10	0.90	Σ SAR < 1.6, Not required
43	LTE 26 + WLAN Ant 0 (DTS) + BT (DSS) Ant 1	Body	Bottom Side	0.40	0.40	0.03	0.83	Σ SAR < 1.6, Not required
44	LTE 26 + WLAN Ant 0 (NII) + BT (DSS) Ant 1	Body	Bottom Side	0.40	0.40	0.03	0.83	Σ SAR < 1.6, Not required

FCC SAR Test Report

No.	Conditions (SAR1 + SAR2 + SAR3)	Exposure Condition	Test Position	Max. SAR1	Max. SAR2	Max. SAR3	SAR Summation	SPLSR Analysis
45	LTE 41 + WLAN Ant 0 (DTS) + WLAN Ant 1 (DTS)	Body	Bottom Side	0.40	0.40	0.06	0.86	Σ SAR < 1.6, Not required
46	LTE 41 + WLAN Ant 0 (NII) + WLAN Ant 1 (NII)	Body	Bottom Side	0.40	0.40	0.10	0.90	Σ SAR < 1.6, Not required
47	LTE 41 + WLAN Ant 0 (DTS) + BT (DSS) Ant 1	Body	Bottom Side	0.40	0.40	0.03	0.83	Σ SAR < 1.6, Not required
48	LTE 41 + WLAN Ant 0 (NII) + BT (DSS) Ant 1	Body	Bottom Side	0.40	0.40	0.03	0.83	Σ SAR < 1.6, Not required

<SAR to Peak Location Separation Ratio Analysis>

The simultaneous transmitting antennas in each operating mode and exposure condition combination are considered one pair at a time to determine the SPLSR. When SAR is measured for both antennas in the pair, the peak location separation distance is computed by the following formula.

$$\text{Peak Location Separation Distance} = \sqrt{(x_1 - x_2)^2 + (y_1 - y_2)^2 + (z_1 - z_2)^2}$$

Where (x_1, y_1, z_1) and (x_2, y_2, z_2) are the coordinates of the extrapolated peak SAR locations in the area or zoom scans.

When standalone test exclusion applies, SAR is estimated; the peak location is assumed to be at the feed-point or geometric center of the antenna. Due to curvatures on the SAM phantom, when SAR is estimated for one of the antennas in an antenna pair, the measured peak SAR location will be translated onto the test device to determine the peak location separation for the antenna pair.

The SPLSR is determined by the following formula.

$$\text{SPLSR} = \frac{(SAR_1 + SAR_2)^{1.5}}{R_i}$$

Where SAR_1 and SAR_2 are the highest reported or estimated SAR for each antenna in the pair, and R_i is the separation distance between the peak SAR locations for the antenna pair in mm.

When the SPLSR is ≤ 0.04 , the simultaneous transmission SAR is not required. Otherwise, the enlarged zoom scan and volume scan post-processing procedures will be performed.

WWAN (EM7455) + WLAN (QCNFA344A)

Conditions	Exposure Condition	Test Position	SAR Value (W/kg)	Coordinates			Peak Location Separation Distance (R_i , mm)	SPLSR	Simultaneous Transmission SAR Test
				x	y	z			
LTE 2 QPSK20M Ch18700	Body	Top Side	1.08	1.4	138.9	-1.5	253.5	0.01	SPLSR ≤ 0.04 , Not required
802.11n HT40 Ch151			0.61	-3.5	-114.5	2.07			

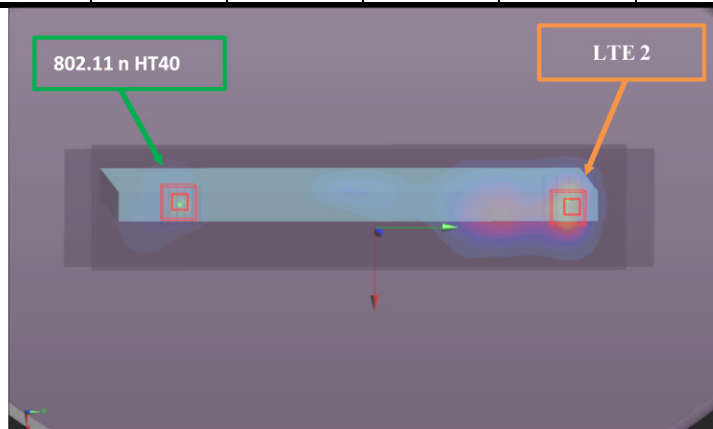

FCC SAR Test Report

Conditions	Exposure Condition	Test Position	SAR Value (W/kg)	Coordinates			Peak Location Separation Distance (R _i , mm)	SPLSR	Simultaneous Transmission SAR Test
				x	y	z			
LTE 5 QPSK10M Ch20450	Body	Top Side	1.15	0.4	84.4	-2.69	199.0	0.01	SPLSR ≤ 0.04, Not required
802.11n HT40 Ch151			0.61	-3.5	-114.5	2.07			

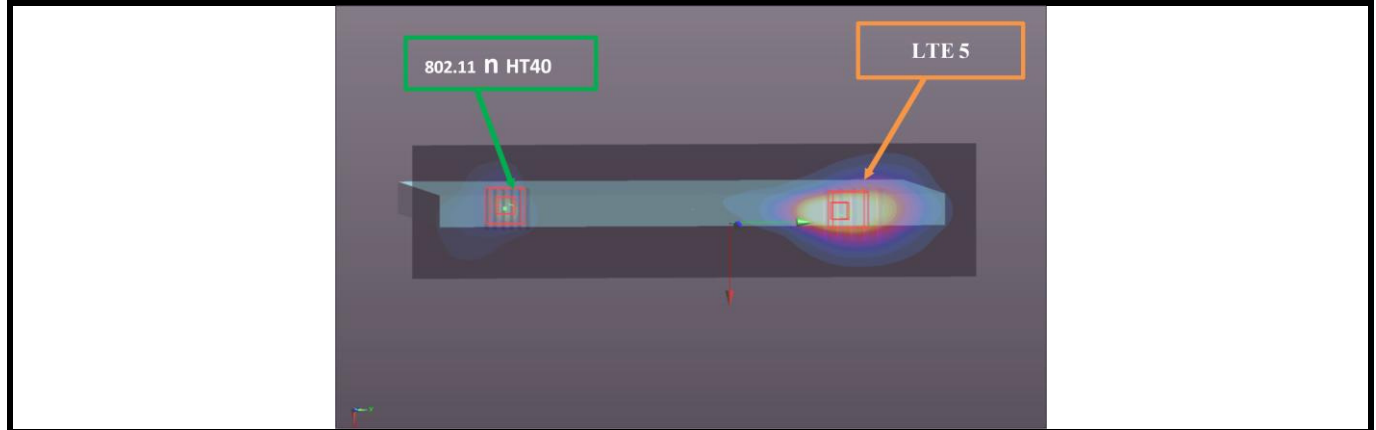

Conditions	Exposure Condition	Test Position	SAR Value (W/kg)	Coordinates			Peak Location Separation Distance (R _i , mm)	SPLSR	Simultaneous Transmission SAR Test
				x	y	z			
LTE 12 QPSK10M Ch23230	Body	Top Side	1.02	0	80	-2.87	194.6	0.01	SPLSR ≤ 0.04, Not required
802.11n HT40 Ch151			0.61	-3.5	-114.5	2.07			

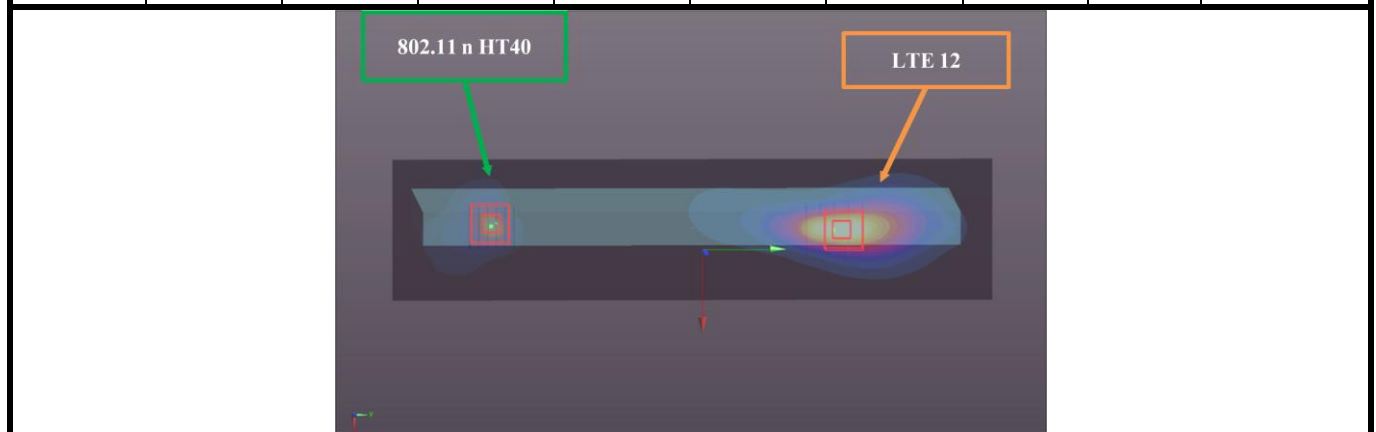

FCC SAR Test Report

Conditions	Exposure Condition	Test Position	SAR Value (W/kg)	Coordinates			Peak Location Separation Distance (R _i , mm)	SPLSR	Simultaneous Transmission SAR Test
				x	y	z			
LTE 13 QPSK10M Ch23230	Body	Top Side	1.04	0	82	-2.84	196.6	0.01	SPLSR ≤ 0.04, Not required
802.11n HT40 Ch151			0.61	-3.5	-114.5	2.07			

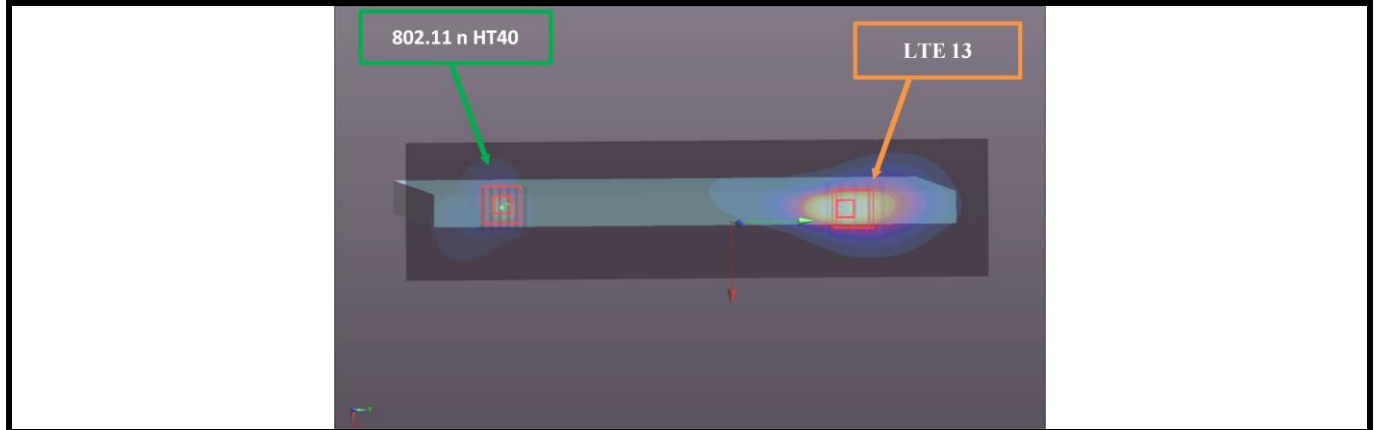

WWAN (EM7455) + WLAN (8265NGW)

Conditions	Exposure Condition	Test Position	SAR Value (W/kg)	Coordinates			Peak Location Separation Distance (R _i , mm)	SPLSR	Simultaneous Transmission SAR Test
				x	y	z			
WCDMA II Ch9538	Body	Rear Face	1.33	99.8	93.2	-1	207.1	0.01	SPLSR ≤ 0.04, Not required
802.11n HT40 Ch151			0.3	81	-113	2.91			

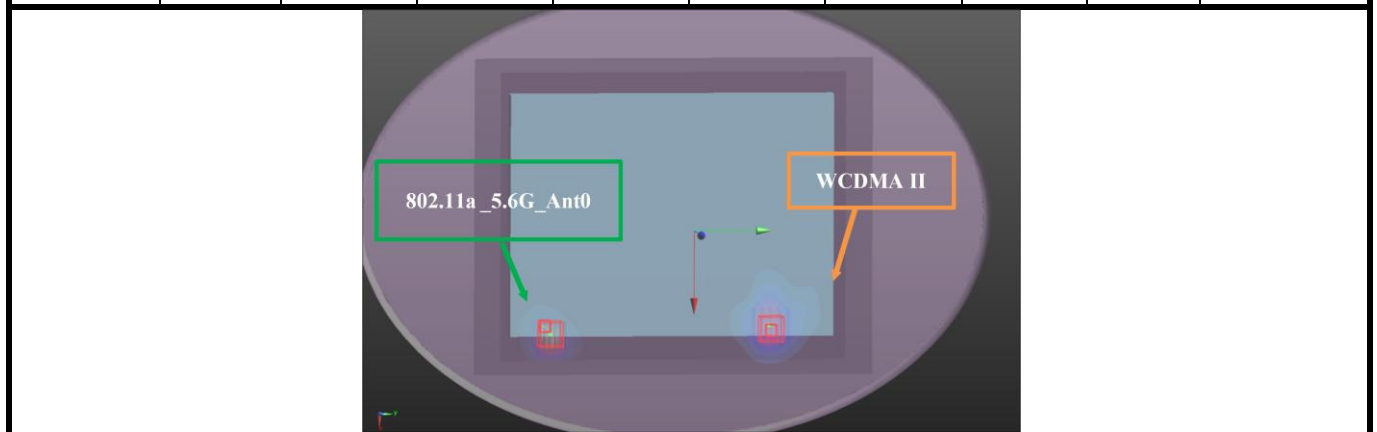

FCC SAR Test Report

Conditions	Exposure Condition	Test Position	SAR Value (W/kg)	Coordinates			Peak Location Separation Distance (R _i , mm)	SPLSR	Simultaneous Transmission SAR Test
				x	y	z			
WCDMA II_Ch9538	Body	Rear Face	1.33	99.8	93.2	-1	136.6	0.01	SPLSR ≤ 0.04, Not required
802.11a_Ch157_Ant1			0.27	0	0	0			

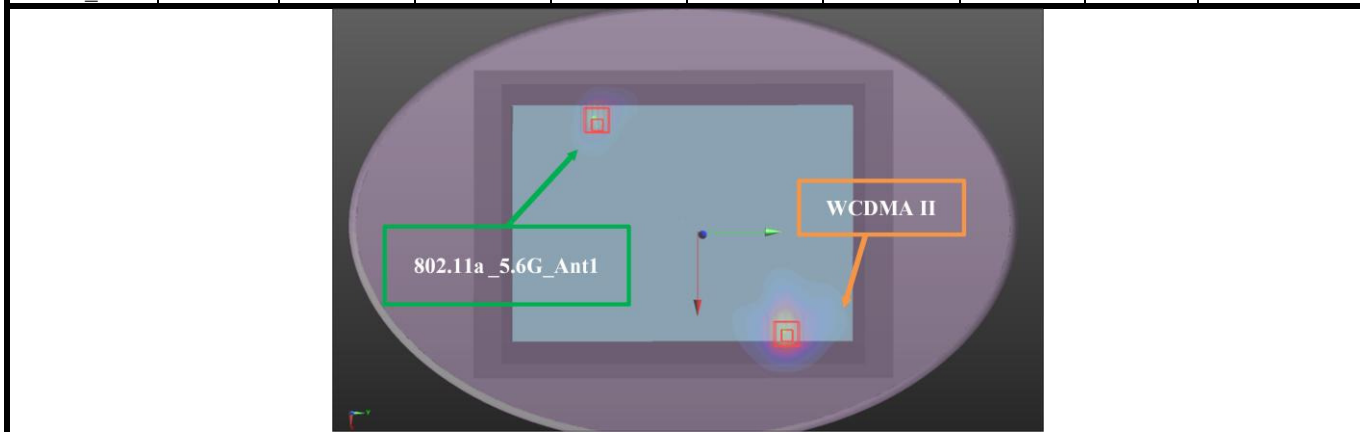

Conditions	Exposure Condition	Test Position	SAR Value (W/kg)	Coordinates			Peak Location Separation Distance (R _i , mm)	SPLSR	Simultaneous Transmission SAR Test
				x	y	z			
802.11a_Ch157_Ant0	Body	Rear Face	0.3	81	-113	2.91	139.1	0.00	SPLSR ≤ 0.04, Not required
802.11a_Ch157_Ant1			0.27	0	0	0			

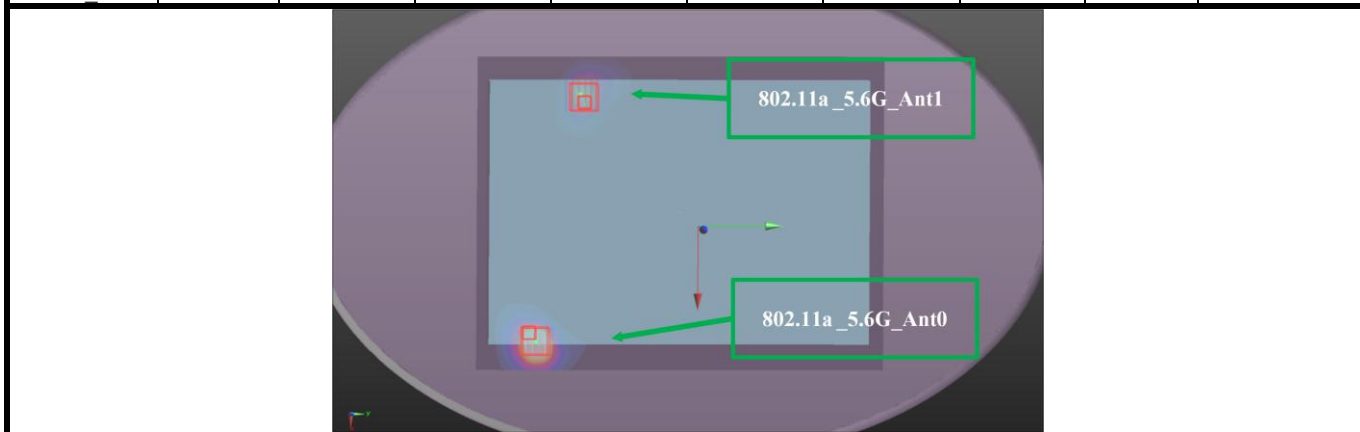

FCC SAR Test Report

Conditions	Exposure Condition	Test Position	SAR Value (W/kg)	Coordinates			Peak Location Separation Distance (R _i , mm)	SPLSR	Simultaneous Transmission SAR Test
				x	y	z			
WCDMA II_Ch9538	Body	Rear Face	1.33	99.8	93.2	-1	207.1	0.01	SPLSR ≤ 0.04, Not required
802.11n HT40 Ch151			0.3	81	-113	2.91			

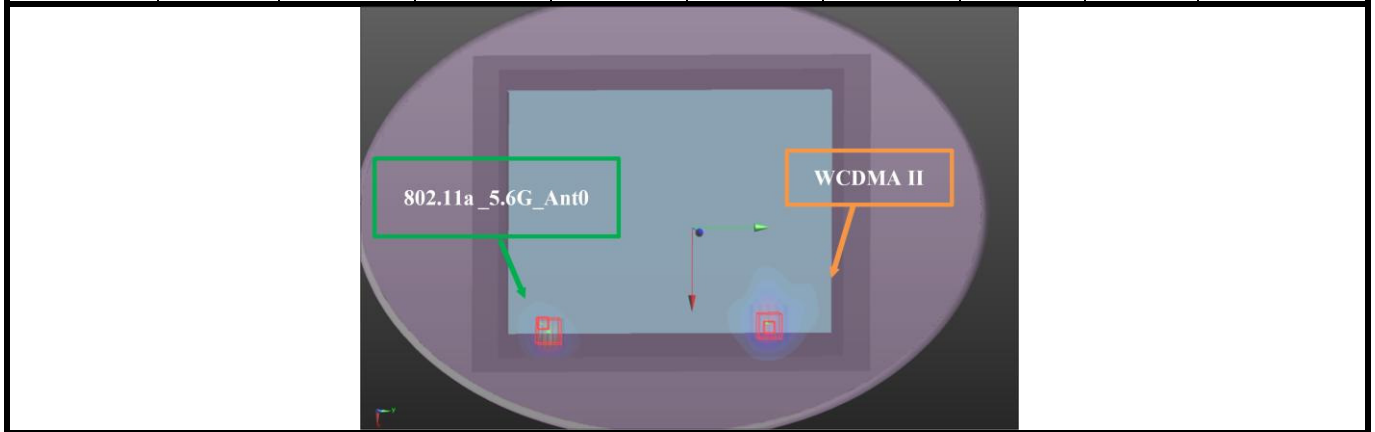

Conditions	Exposure Condition	Test Position	SAR Value (W/kg)	Coordinates			Peak Location Separation Distance (R _i , mm)	SPLSR	Simultaneous Transmission SAR Test
				x	y	z			
WCDMA II_Ch9538	Body	Rear Face	1.33	99.8	93.2	-1	115.5	0.01	SPLSR ≤ 0.04, Not required
Bluetooth			0.06	131	-17	13.87			

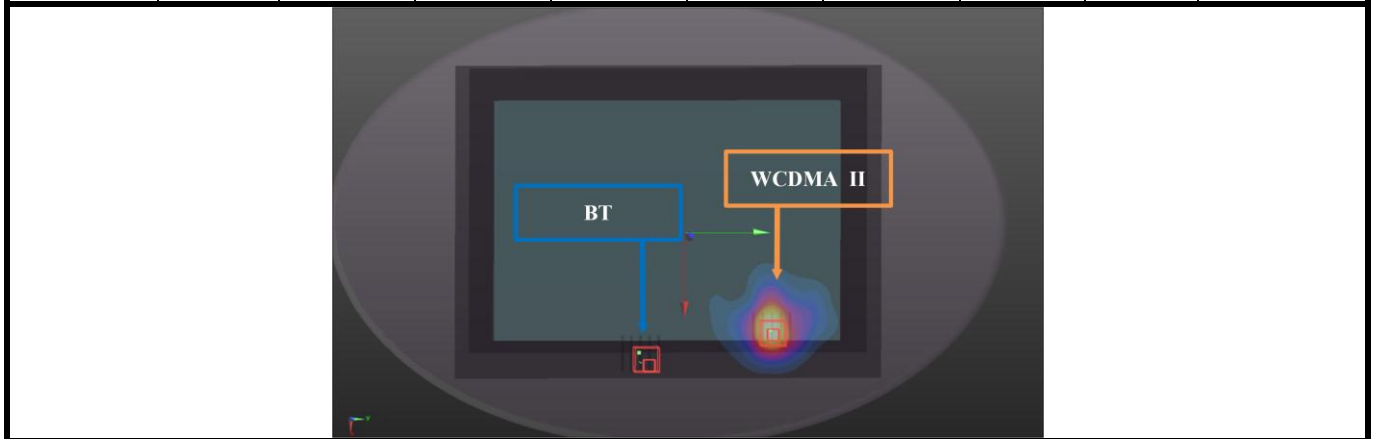

FCC SAR Test Report

Conditions	Exposure Condition	Test Position	SAR Value (W/kg)	Coordinates			Peak Location Separation Distance (R _i , mm)	SPLSR	Simultaneous Transmission SAR Test
				x	y	z			
802.11n HT40 Ch151	Body	Rear Face	0.3	81	-113	2.91	108.8	0.00	SPLSR ≤ 0.04, Not required
Bluetooth			0.06	131	-17	13.87			

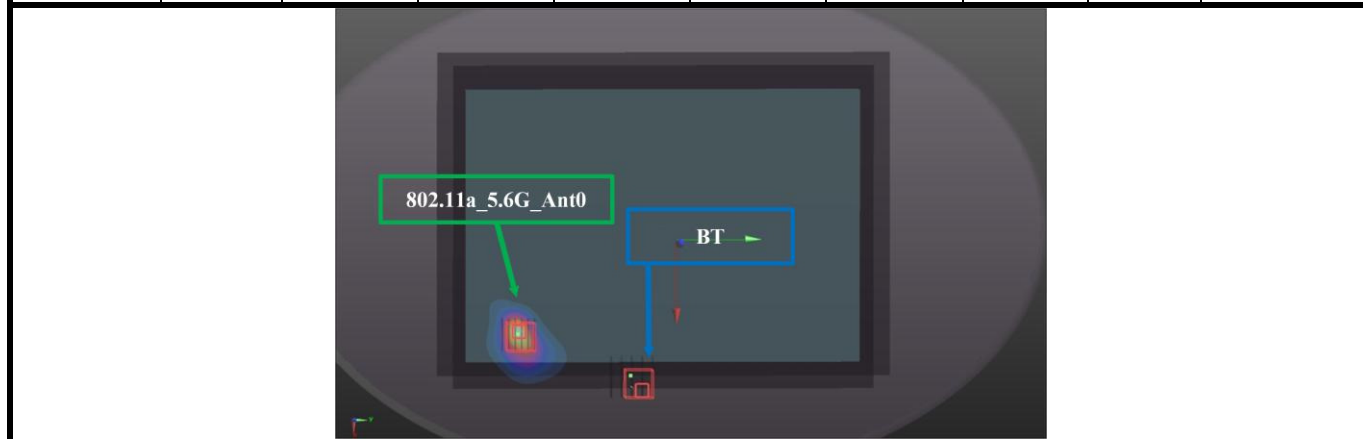

Conditions	Exposure Condition	Test Position	SAR Value (W/kg)	Coordinates			Peak Location Separation Distance (R _i , mm)	SPLSR	Simultaneous Transmission SAR Test
				x	y	z			
WCDMA IV_Ch1413	Body	Rear Face	1.33	99.1	92.3	-1.29	206.1	0.01	SPLSR ≤ 0.04, Not required
802.11a Ch157_Ant0			0.3	81	-113	2.91			

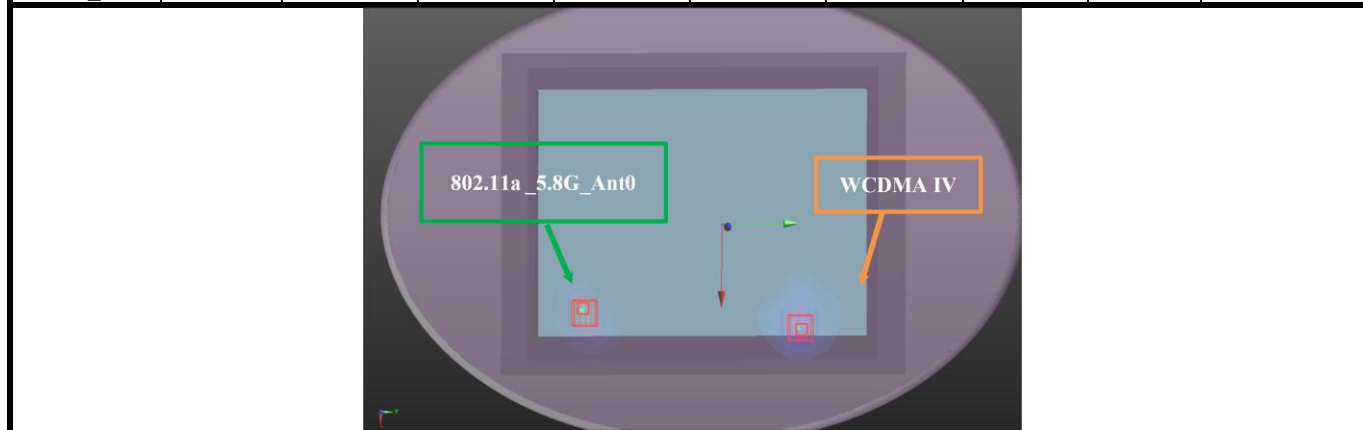

FCC SAR Test Report

Conditions	Exposure Condition	Test Position	SAR Value (W/kg)	Coordinates			Peak Location Separation Distance (R _i , mm)	SPLSR	Simultaneous Transmission SAR Test
				x	y	z			
WCDMA IV_Ch1413	Body	Rear Face	1.33	99.1	92.3	-1.29	135.4	0.01	SPLSR ≤ 0.04, Not required
802.11a_Ch157_Ant1			0.27	0	0	0			

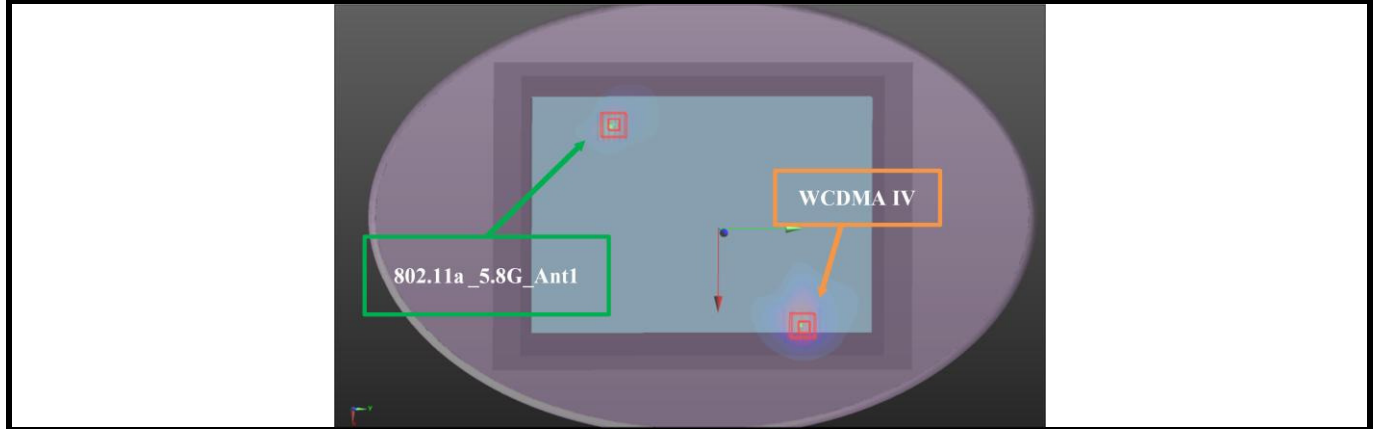

Conditions	Exposure Condition	Test Position	SAR Value (W/kg)	Coordinates			Peak Location Separation Distance (R _i , mm)	SPLSR	Simultaneous Transmission SAR Test
				x	y	z			
WCDMA IV_Ch1413	Body	Rear Face	1.33	99.1	92.3	-1.29	114.9	0.01	SPLSR ≤ 0.04, Not required
Bluetooth			0.06	131	-17	13.87			

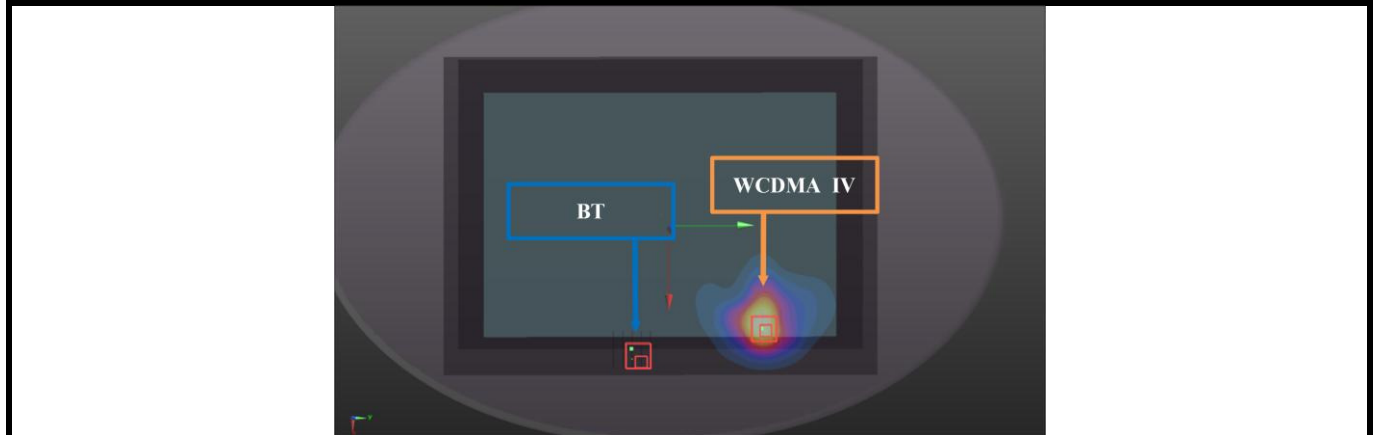

FCC SAR Test Report

Conditions	Exposure Condition	Test Position	SAR Value (W/kg)	Coordinates			Peak Location Separation Distance (R _i , mm)	SPLSR	Simultaneous Transmission SAR Test
				x	y	z			
802.11a Ch157_Ant0	Body	Rear Face	0.3	81	-113	2.91	108.8	0.00	SPLSR ≤ 0.04, Not required
Bluetooth			0.06	131	-17	13.87			



Conditions	Exposure Condition	Test Position	SAR Value (W/kg)	Coordinates			Peak Location Separation Distance (R _i , mm)	SPLSR	Simultaneous Transmission SAR Test
				x	y	z			
802.11a Ch157_Ant0	Body	Rear Face	0.3	81	-113	2.91	139.1	0.00	SPLSR ≤ 0.04, Not required
802.11a Ch157_Ant1			0.27	0	0	0			

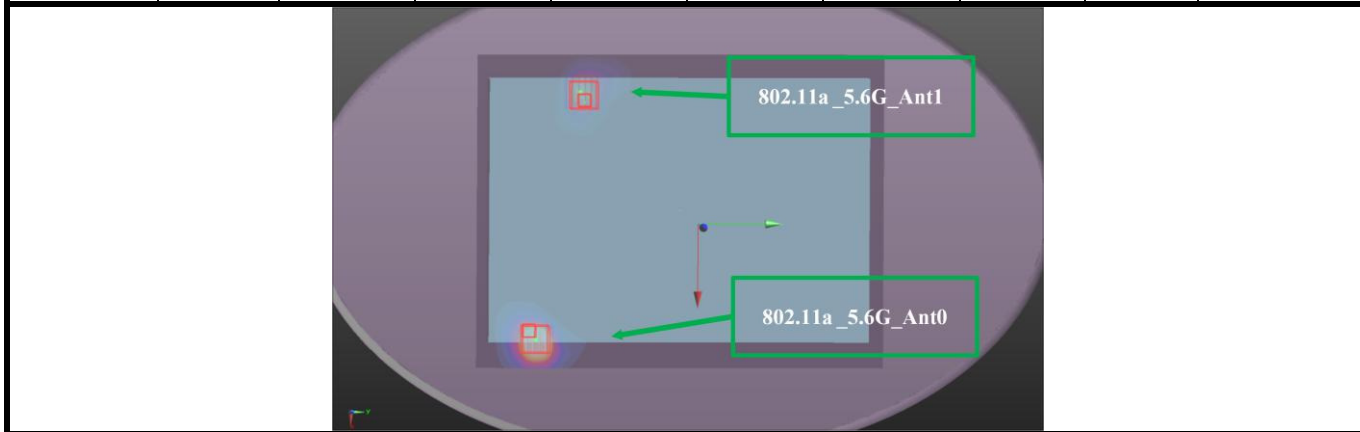

FCC SAR Test Report

Conditions	Exposure Condition	Test Position	SAR Value (W/kg)	Coordinates			Peak Location Separation Distance (R _i , mm)	SPLSR	Simultaneous Transmission SAR Test
				x	y	z			
WCDMA IV_Ch1413	Body	Rear Face	1.33	99.1	92.3	-1.29	206.1	0.01	SPLSR ≤ 0.04, Not required
802.11a Ch157_Ant0			0.3	81	-113	2.91			

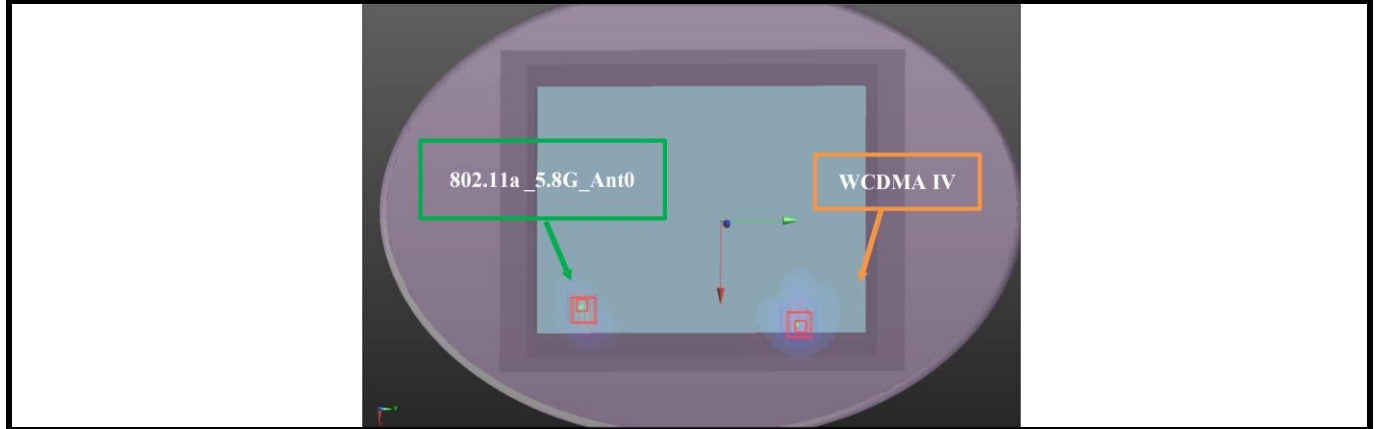

Conditions	Exposure Condition	Test Position	SAR Value (W/kg)	Coordinates			Peak Location Separation Distance (R _i , mm)	SPLSR	Simultaneous Transmission SAR Test
				x	y	z			
WCDMA V_Ch4132	Body	Top Side	0.85	0	86	-2.77	202.6	0.01	SPLSR ≤ 0.04, Not required
802.11a Ch116_Ant0			0.77	3.5	-116.5	1.47			

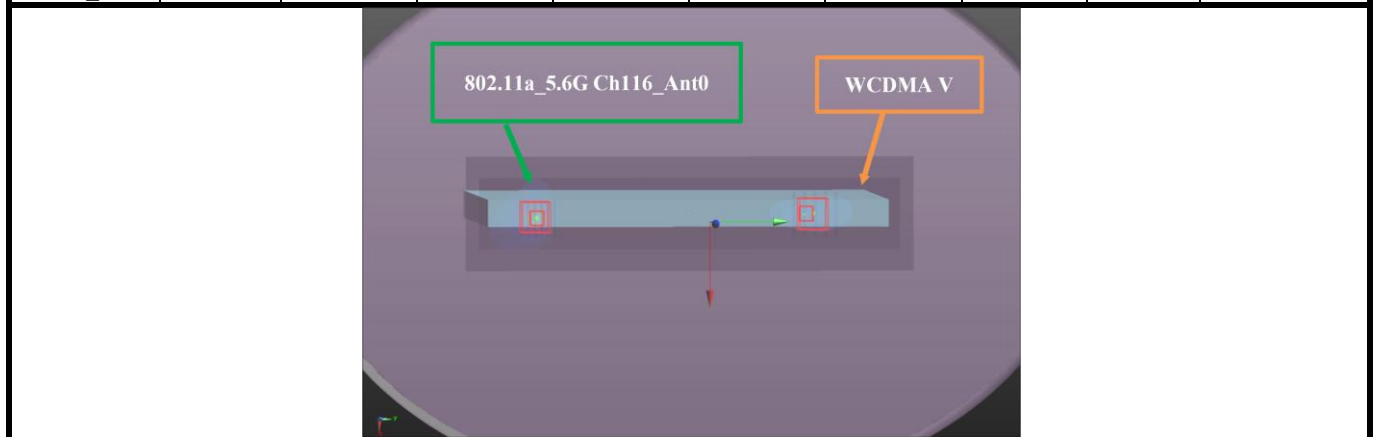

FCC SAR Test Report

Conditions	Exposure Condition	Test Position	SAR Value (W/kg)	Coordinates			Peak Location Separation Distance (R _i , mm)	SPLSR	Simultaneous Transmission SAR Test
				x	y	z			
WCDMA V_Ch4132	Body	Top Side	0.85	0	86	-2.77	202.6	0.01	SPLSR ≤ 0.04, Not required
802.11a Ch116_Ant0			0.77	3.5	-116.5	1.47			

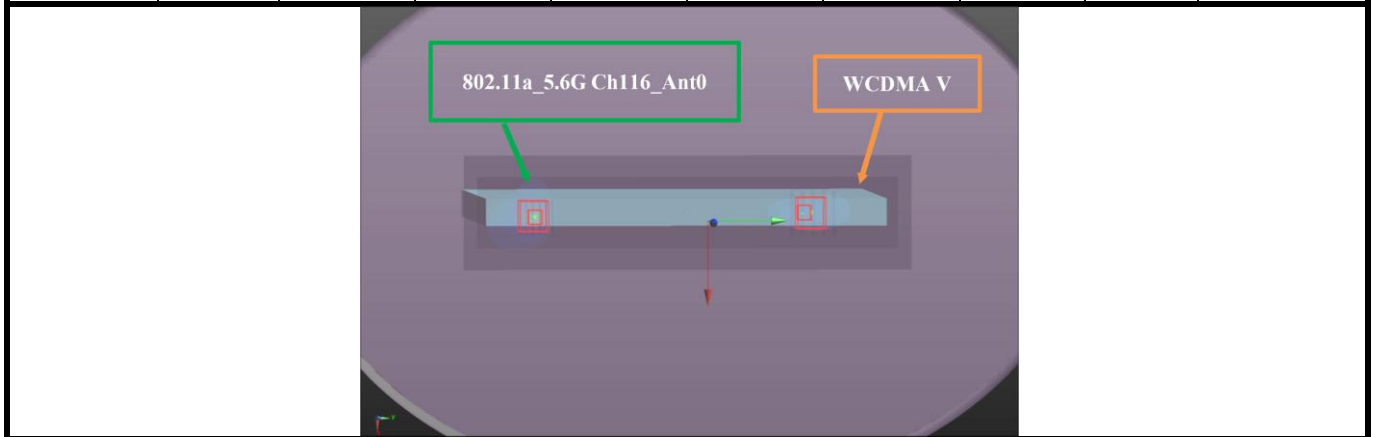

Conditions	Exposure Condition	Test Position	SAR Value (W/kg)	Coordinates			Peak Location Separation Distance (R _i , mm)	SPLSR	Simultaneous Transmission SAR Test
				x	y	z			
LTE 2_QPSK20 M_Ch18700	Body	Top Side	1.08	1.4	138.9	-1.5	255.4	0.01	SPLSR ≤ 0.04, Not required
802.11a Ch116_Ant0			0.77	3.5	-116.5	1.47			

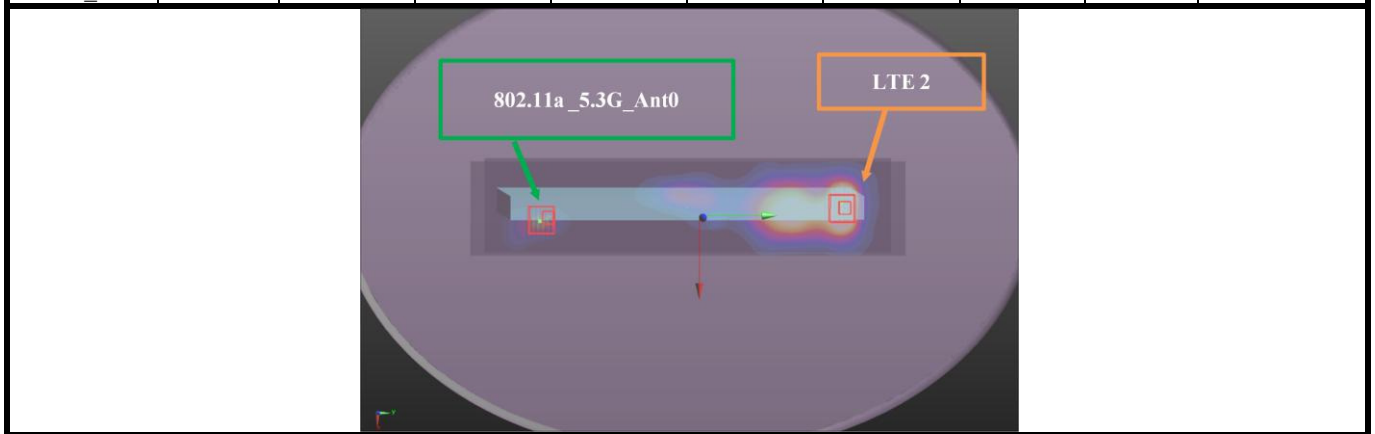

FCC SAR Test Report

Conditions	Exposure Condition	Test Position	SAR Value (W/kg)	Coordinates			Peak Location Separation Distance (R _i , mm)	SPLSR	Simultaneous Transmission SAR Test
				x	y	z			
LTE 2_QPSK20 M_Ch18700	Body	Top Side	1.08	1.4	138.9	-1.5	255.4	0.01	SPLSR ≤ 0.04, Not required
802.11a Ch116_Ant0			0.77	3.5	-116.5	1.47			

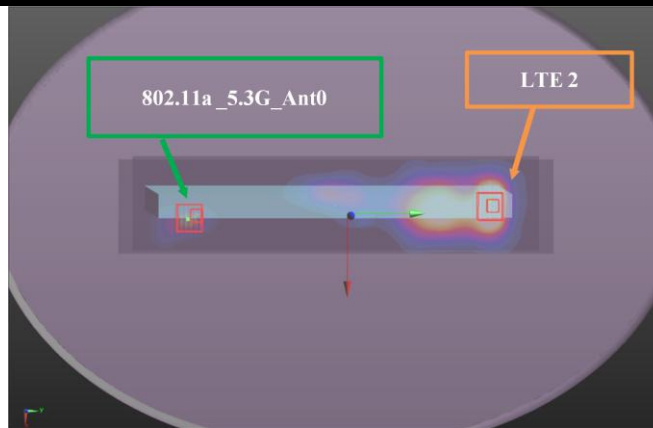

Conditions	Exposure Condition	Test Position	SAR Value (W/kg)	Coordinates			Peak Location Separation Distance (R _i , mm)	SPLSR	Simultaneous Transmission SAR Test
				x	y	z			
LTE 4 QPSK20M Ch20050	Body	Top Side	0.97	4.4	103.6	1.81	220.1	0.01	SPLSR ≤ 0.04, Not required
802.11a Ch116_Ant0			0.77	3.5	-116.5	1.47			

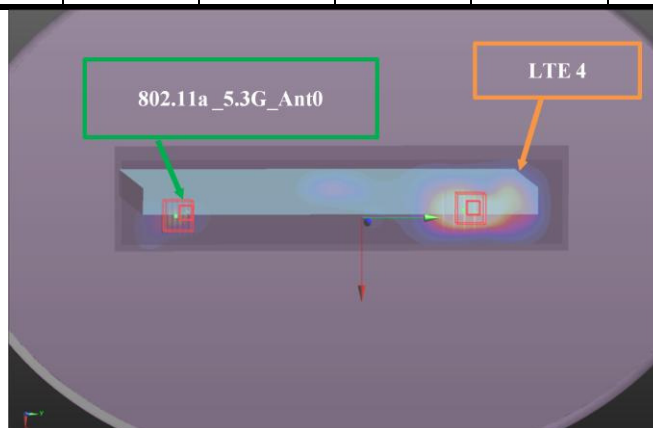

FCC SAR Test Report

Conditions	Exposure Condition	Test Position	SAR Value (W/kg)	Coordinates			Peak Location Separation Distance (R _i , mm)	SPLSR	Simultaneous Transmission SAR Test
				x	y	z			
LTE 4 QPSK20M Ch20050	Body	Top Side	0.97	4.4	103.6	1.81	220.1	0.01	SPLSR ≤ 0.04, Not required
802.11a Ch116_Ant0			0.77	3.5	-116.5	1.47			

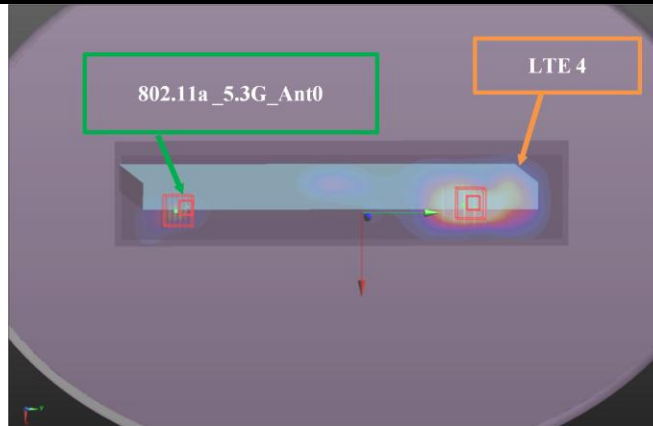

Conditions	Exposure Condition	Test Position	SAR Value (W/kg)	Coordinates			Peak Location Separation Distance (R _i , mm)	SPLSR	Simultaneous Transmission SAR Test
				x	y	z			
LTE 5 QPSK10 M_Ch20450	Body	Top Side	1.15	0.4	84.4	-2.69	201.0	0.01	SPLSR ≤ 0.04, Not required
802.11a Ch116_Ant0			0.77	3.5	-116.5	1.47			

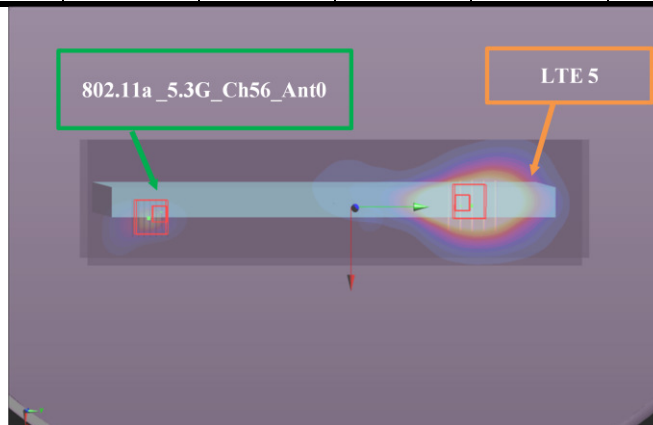

FCC SAR Test Report

Conditions	Exposure Condition	Test Position	SAR Value (W/kg)	Coordinates			Peak Location Separation Distance (R _i , mm)	SPLSR	Simultaneous Transmission SAR Test
				x	y	z			
LTE 5_QPSK10_M_Ch20450	Body	Top Side	1.15	0.4	84.4	-2.69	201.0	0.01	SPLSR ≤ 0.04, Not required
802.11a_Ch116_Ant0			0.77	3.5	-116.5	1.47			

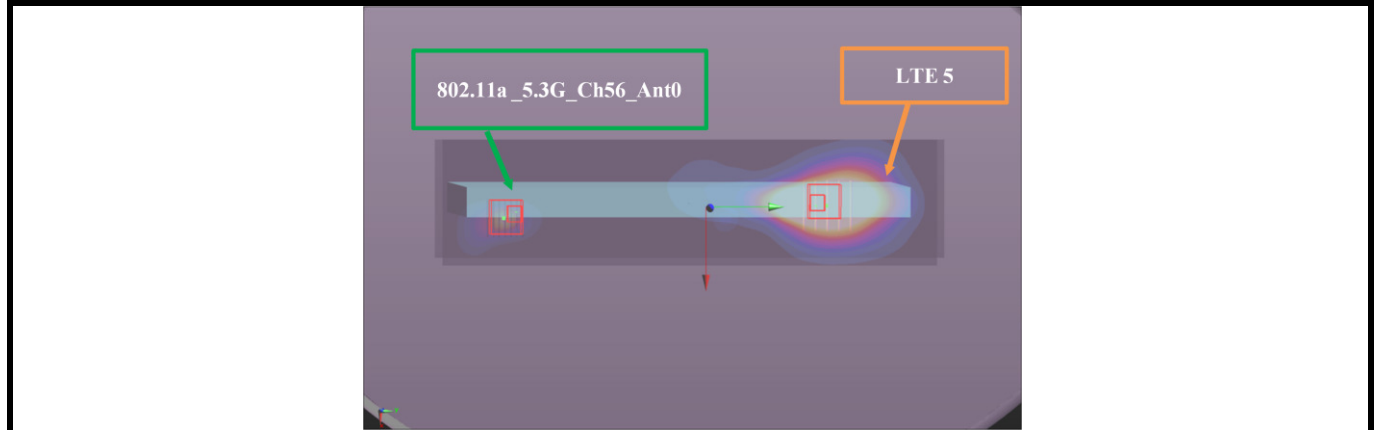

Conditions	Exposure Condition	Test Position	SAR Value (W/kg)	Coordinates			Peak Location Separation Distance (R _i , mm)	SPLSR	Simultaneous Transmission SAR Test
				x	y	z			
LTE 12_QPSK10_M_Ch23130	Body	Top Side	1.02	0	80	-2.87	196.6	0.01	SPLSR ≤ 0.04, Not required
802.11a_Ch116_Ant0			0.77	3.5	-116.5	1.47			

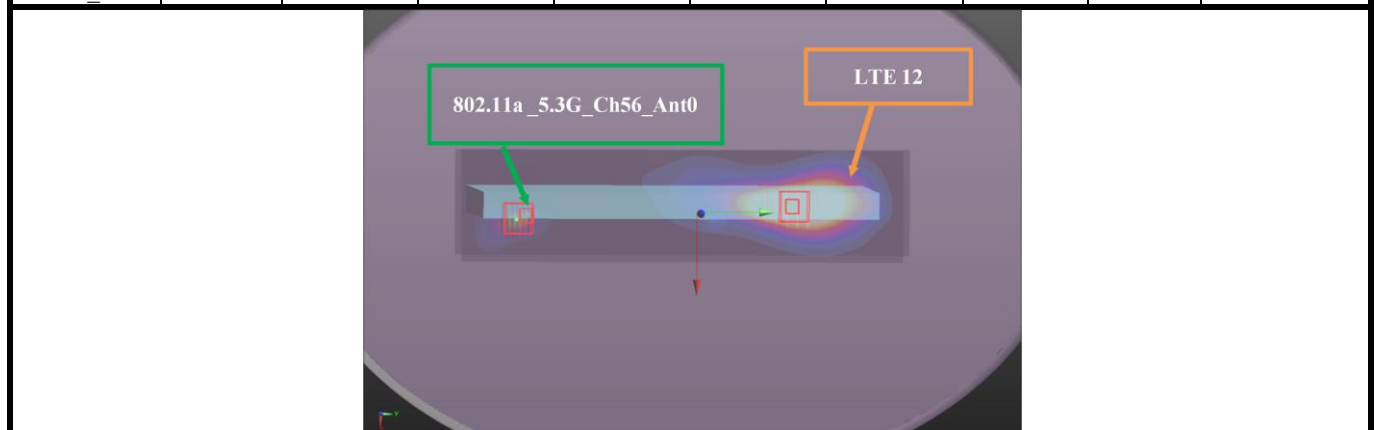

FCC SAR Test Report

Conditions	Exposure Condition	Test Position	SAR Value (W/kg)	Coordinates			Peak Location Separation Distance (R _i , mm)	SPLSR	Simultaneous Transmission SAR Test
				x	y	z			
LTE 12_QPSK10_M_Ch23130	Body	Top Side	1.02	0	80	-2.87	196.6	0.01	SPLSR ≤ 0.04, Not required
802.11a_Ch116_Ant0			0.77	3.5	-116.5	1.47			

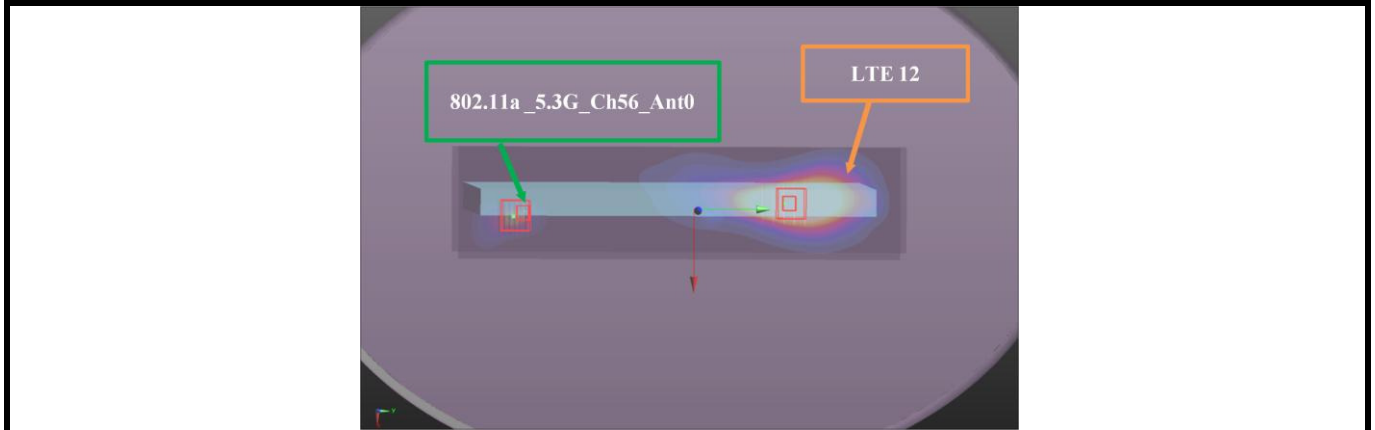

Conditions	Exposure Condition	Test Position	SAR Value (W/kg)	Coordinates			Peak Location Separation Distance (R _i , mm)	SPLSR	Simultaneous Transmission SAR Test
				x	y	z			
LTE 13_QPSK10_M_23230	Body	Top Side	1.04	0	82	-2.84	198.6	0.01	SPLSR ≤ 0.04, Not required
802.11a_Ch116_Ant0			0.77	3.5	-116.5	1.47			

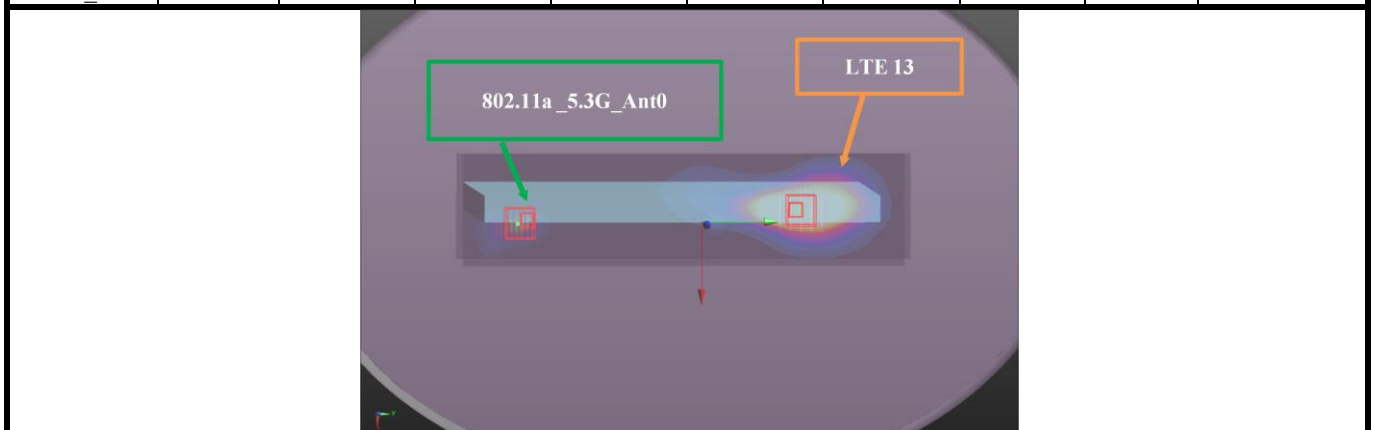

FCC SAR Test Report

Conditions	Exposure Condition	Test Position	SAR Value (W/kg)	Coordinates			Peak Location Separation Distance (R _i , mm)	SPLSR	Simultaneous Transmission SAR Test
				x	y	z			
LTE 13_QPSK10_M_23230	Body	Top Side	1.04	0	82	-2.84	198.6	0.01	SPLSR ≤ 0.04, Not required
802.11a_Ch116_Ant0			0.77	3.5	-116.5	1.47			

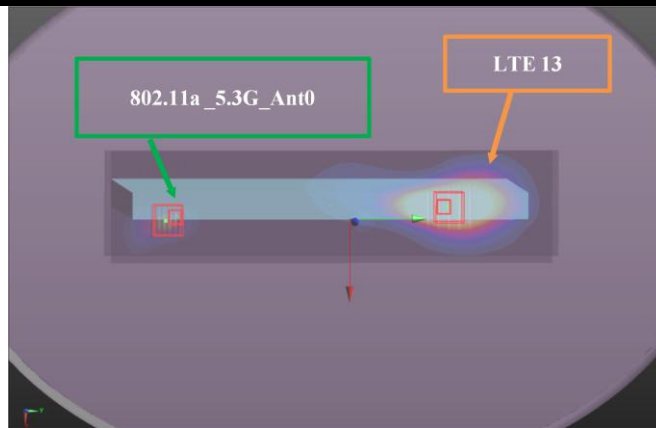

Test Engineer : Willy Chang, and Austin Lin

5. Calibration of Test Equipment.

Equipment	Manufacturer	Model	SN	Cal. Date	Cal. Interval
System Validation Dipole	SPEAG	D750V3	1013	Aug. 30, 2016	1 Year
System Validation Dipole	SPEAG	D835V2	4d121	Aug. 25, 2016	1 Year
System Validation Dipole	SPEAG	D1750V2	1055	Aug. 31, 2016	1 Year
System Validation Dipole	SPEAG	D1900V2	5d036	Jan. 22, 2016	1 Year
System Validation Dipole	SPEAG	D1900V2	5d142	Jun. 23, 2016	1 Year
System Validation Dipole	SPEAG	D2450V2	737	Aug. 26, 2016	1 Year
System Validation Dipole	SPEAG	D2600V2	1020	Aug. 26, 2016	1 Year
System Validation Dipole	SPEAG	D5GHzV2	1019	Aug. 23, 2016	1 Year
Dosimetric E-Field Probe	SPEAG	EX3DV4	7350	Dec. 17, 2015	1 Year
Dosimetric E-Field Probe	SPEAG	ET3DV6	1790	Jun. 24, 2016	1 Year
Dosimetric E-Field Probe	SPEAG	EX3DV4	3971	Mar. 23, 2016	1 Year
Dosimetric E-Field Probe	SPEAG	EX3DV4	3650	Jul. 25, 2016	1 Year
Dosimetric E-Field Probe	SPEAG	EX3DV4	3864	Jul. 25, 2016	1 Year
Dosimetric E-Field Probe	SPEAG	EX3DV4	3820	Jun. 27, 2016	1 Year
Data Acquisition Electronics	SPEAG	DAE4	1305	Dec. 11, 2015	1 Year
Data Acquisition Electronics	SPEAG	DAE4	1277	Jul. 22, 2016	1 Year
Data Acquisition Electronics	SPEAG	DAE3	579	Sep. 05, 2016	1 Year
Data Acquisition Electronics	SPEAG	DAE4	861	Jun. 16, 2016	1 Year
Data Acquisition Electronics	SPEAG	DAE4	1431	Mar. 21, 2016	1 Year
Data Acquisition Electronics	SPEAG	DAE4	913	Mar. 31, 2016	1 Year
Radio Communication Analyzer	Anritsu	MT8820C	6201381727	May. 04, 2016	1 Year
Spectrum Analyzer	R&S	FSL6	102006	Mar. 25, 2016	1 Year
ENA Series Network Analyzer	Agilent	E5071C	MY46214281	Jun. 13, 2016	1 Year
MXG Analog Signal Generator	Agilent	N5181A	MY50143868	Jul. 07, 2016	1 Year
Power Meter	Anritsu	ML2495A	1218009	Jul. 06, 2016	1 Year
Power Sensor	Anritsu	MA2411B	1207252	Jul. 06, 2016	1 Year
Thermometer	YFE	YF-160A	150601220	May. 04, 2016	1 Year
Power Amplifier	AR	551G4	339656	Sep. 21, 2016	1 Year
Power Amplifier	mini-circuits	ZVE-8G	05770420A	Sep. 21, 2016	1 Year
Attenuator	MTJ	MTJ6011-03	N/A	Sep. 21, 2016	1 Year
Directional Coupler	Woken	0110A05602O-10	11122702	Sep. 21, 2016	1 Year

6. Measurement Uncertainty

Source of Uncertainty	Tolerance (± %)	Probability Distribution	Divisor	Ci (1g)	Ci (10g)	Standard Uncertainty (± %, 1g)	Standard Uncertainty (± %, 10g)	Vi
Measurement System								
Probe Calibration	6.0	Normal	1	1	1	6.0	6.0	∞
Axial Isotropy	4.7	Rectangular	√3	√0.5	√0.5	1.9	1.9	∞
Hemispherical Isotropy	9.6	Rectangular	√3	√0.5	√0.5	3.9	3.9	∞
Boundary Effect	1.0	Rectangular	√3	1	1	0.6	0.6	∞
Linearity	4.7	Rectangular	√3	1	1	2.7	2.7	∞
System Detection Limits	0.25	Rectangular	√3	1	1	0.14	0.14	∞
Modulation Response	3.5	Rectangular	√3	1	1	2.0	2.0	∞
Readout Electronics	0.3	Normal	1	1	1	0.3	0.3	∞
Response Time	0.0	Rectangular	√3	1	1	0.0	0.0	∞
Integration Time	1.7	Rectangular	√3	1	1	1.0	1.0	∞
RF Ambient Conditions - Noise	3.0	Rectangular	√3	1	1	1.7	1.7	∞
RF Ambient Conditions - Reflections	3.0	Rectangular	√3	1	1	1.7	1.7	∞
Probe Positioner Mechanical Tolerance	0.4	Rectangular	√3	1	1	0.2	0.2	∞
Probe Positioning with Respect to Phantom	2.9	Rectangular	√3	1	1	1.7	1.7	∞
Extrapolation, Interpolation, and Integration Algorithms for Max. SAR Evaluation	2.0	Rectangular	√3	1	1	1.2	1.2	∞
Test Sample Related								
Test Sample Positioning	3.9 / 2.06	Normal	1	1	1	3.9	2.1	35
Device Holder Uncertainty	2.9 / 4.1	Normal	1	1	1	2.9	4.1	11
Output Power Variation - SAR Drift Measurement	5.0	Rectangular	√3	1	1	2.9	2.9	∞
SAR Scaling	0.0	Rectangular	√3	1	1	0.0	0.0	∞
Phantom and Tissue								
Phantom Shell Uncertainty - Shape, Thickness and Permittivity	7.2	Rectangular	√3	1	1	4.2	4.2	∞
Uncertainty in SAR Correction for Deviations in Permittivity and Conductivity	1.2 / 0.97	Normal	1	1	0.84	1.2	0.8	∞
Liquid Conductivity Measurement	2.88	Normal	1	0.78	0.71	2.2	2.0	43
Liquid Permittivity Measurement	2.50	Normal	1	0.23	0.26	0.6	0.7	54
Liquid Conductivity - Temperature Uncertainty	3.24	Rectangular	√3	0.78	0.71	1.5	1.3	∞
Liquid Permittivity - Temperature Uncertainty	1.13	Rectangular	√3	0.23	0.26	0.2	0.2	∞
Combined Standard Uncertainty						± 11.7 %	± 11.5 %	
Expanded Uncertainty (K=2)						± 23.4 %	± 23.0 %	

Uncertainty budget for frequency range 300 MHz to 3 GHz

FCC SAR Test Report

Source of Uncertainty	Tolerance (± %)	Probability Distribution	Divisor	Ci (1g)	Ci (10g)	Standard Uncertainty (± %, 1g)	Standard Uncertainty (± %, 10g)	Vi
Measurement System								
Probe Calibration	6.55	Normal	1	1	1	6.55	6.55	∞
Axial Isotropy	4.7	Rectangular	√3	√0.5	√0.5	1.9	1.9	∞
Hemispherical Isotropy	9.6	Rectangular	√3	√0.5	√0.5	3.9	3.9	∞
Boundary Effect	2.0	Rectangular	√3	1	1	1.2	1.2	∞
Linearity	4.7	Rectangular	√3	1	1	2.7	2.7	∞
System Detection Limits	0.25	Rectangular	√3	1	1	0.14	0.14	∞
Modulation Response	3.5	Rectangular	√3	1	1	2.0	2.0	∞
Readout Electronics	0.3	Normal	1	1	1	0.3	0.3	∞
Response Time	0.0	Rectangular	√3	1	1	0.0	0.0	∞
Integration Time	1.7	Rectangular	√3	1	1	1.0	1.0	∞
RF Ambient Conditions - Noise	3.0	Rectangular	√3	1	1	1.7	1.7	∞
RF Ambient Conditions - Reflections	3.0	Rectangular	√3	1	1	1.7	1.7	∞
Probe Positioner Mechanical Tolerance	0.4	Rectangular	√3	1	1	0.2	0.2	∞
Probe Positioning with Respect to Phantom Shell	6.7	Rectangular	√3	1	1	3.9	3.9	∞
Extrapolation, Interpolation, and Integration Algorithms for Max. SAR Evaluation	4.0	Rectangular	√3	1	1	2.3	2.3	∞
Test Sample Related								
Test Sample Positioning	3.9 / 2.06	Normal	1	1	1	3.9	2.1	35
Device Holder Uncertainty	2.9 / 4.1	Normal	1	1	1	2.9	4.1	11
Output Power Variation - SAR Drift Measurement	5.0	Rectangular	√3	1	1	2.9	2.9	∞
SAR Scaling	0.0	Rectangular	√3	1	1	0.0	0.0	∞
Phantom and Tissue								
Phantom Shell Uncertainty - Shape, Thickness and Permittivity	7.6	Rectangular	√3	1	1	4.4	4.4	∞
Uncertainty in SAR Correction for Deviations in Permittivity and Conductivity	1.2 / 0.97	Normal	1	1	0.84	1.2	0.8	∞
Liquid Conductivity Measurement	2.88	Normal	1	0.78	0.71	2.2	2.0	43
Liquid Permittivity Measurement	2.50	Normal	1	0.23	0.26	0.6	0.7	54
Liquid Conductivity - Temperature Uncertainty	3.24	Rectangular	√3	0.78	0.71	1.5	1.3	∞
Liquid Permittivity - Temperature Uncertainty	1.13	Rectangular	√3	0.23	0.26	0.2	0.2	∞
Combined Standard Uncertainty						± 12.7 %	± 12.6 %	
Expanded Uncertainty (K=2)						± 25.4 %	± 25.2 %	

Uncertainty budget for frequency range 3 GHz to 6 GHz

7. Information on the Testing Laboratories

We, Bureau Veritas Consumer Products Services (H.K.) Ltd., Taoyuan Branch, were founded in 1988 to provide our best service in EMC, Radio, Telecom and Safety consultation. Our laboratories are accredited and approved according to ISO/IEC 17025.

If you have any comments, please feel free to contact us at the following:

Taiwan HwaYa EMC/RF/Safety/Telecom Lab:

Add: No. 19, Hwa Ya 2nd Rd, Wen Hwa Vil., Kwei Shan Hsiang, Taoyuan Hsien 333, Taiwan, R.O.C.

Tel: 886-3-318-3232

Fax: 886-3-327-0892

Taiwan LinKo EMC/RF Lab:

Add: No. 47-2, 14th Ling, Chia Pau Vil., Linkou Dist., New Taipei City 244, Taiwan, R.O.C.

Tel: 886-2-2605-2180

Fax: 886-2-2605-1924

Taiwan HsinChu EMC/RF Lab:

Add: No. 81-1, Lu Liao Keng, 9th Ling, Wu Lung Vil., Chiung Lin Township, Hsinchu County 307, Taiwan, R.O.C.

Tel: 886-3-593-5343

Fax: 886-3-593-5342

Email: service.adt@tw.bureauveritas.com

Web Site: www.adt.com.tw

The road map of all our labs can be found in our web site also.

---END---



Appendix A. SAR Plots of System Verification

The plots for system verification with largest deviation for each SAR system combination are shown as follows.

System Check_B750_161118

DUT: Dipole 750 MHz; Type: D750V3; SN: 1013

Communication System: CW; Frequency: 750 MHz; Duty Cycle: 1:1

Medium: B06T09N1_1118 Medium parameters used: $f = 750 \text{ MHz}$; $\sigma = 0.967 \text{ S/m}$; $\epsilon_r = 56.1$; $\rho = 1000 \text{ kg/m}^3$

Ambient Temperature : 23.7 °C ; Liquid Temperature : 23.4 °C

DASY5 Configuration:

- Probe: EX3DV4 - SN7350; ConvF(10.15, 10.15, 10.15); Calibrated: 2015/12/17;
- Sensor-Surface: 1.4mm (Mechanical Surface Detection)
- Electronics: DAE4 Sn1305; Calibrated: 2015/12/11
- Phantom: ELI Phantom_1039; Type: QDOVA;
- Measurement SW: DASY52, Version 52.8 (8); SEMCAD X Version 14.6.10 (7373)

Pin=250mW/Area Scan (61x81x1): Interpolated grid: $dx=1.500 \text{ mm}$, $dy=1.500 \text{ mm}$
Maximum value of SAR (interpolated) = 2.69 W/kg

Pin=250mW/Zoom Scan (5x5x7)/Cube 0: Measurement grid: $dx=8\text{mm}$, $dy=8\text{mm}$, $dz=5\text{mm}$
Reference Value = 55.03 V/m; Power Drift = -0.01 dB
Peak SAR (extrapolated) = 3.03 W/kg
SAR(1 g) = 2.02 W/kg; SAR(10 g) = 1.34 W/kg
Maximum value of SAR (measured) = 2.69 W/kg

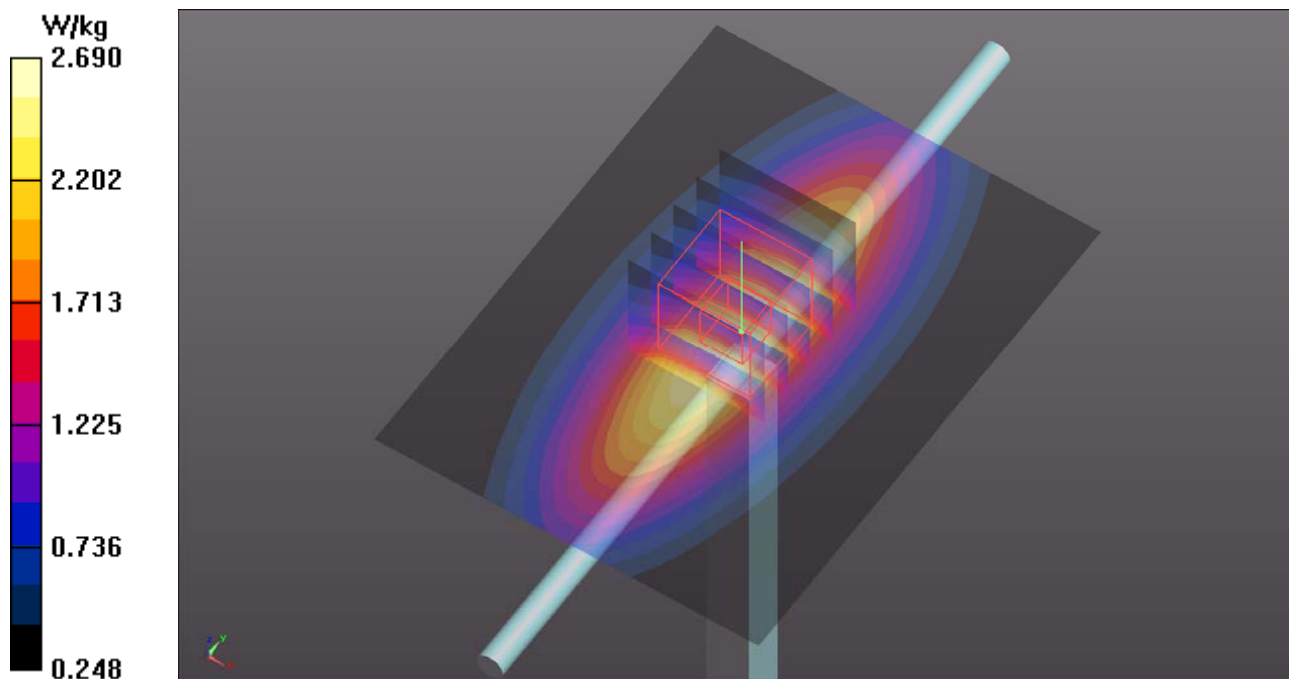

System Check_B835_161209

DUT: Dipole 835 MHz; Type: D835V2; SN: 4d121

Communication System: CW; Frequency: 835 MHz; Duty Cycle: 1:1

Medium: B07T10N3_1209 Medium parameters used: $f = 835 \text{ MHz}$; $\sigma = 1.015 \text{ S/m}$; $\epsilon_r = 56.103$; $\rho = 1000 \text{ kg/m}^3$

Ambient Temperature : 23.8 °C ; Liquid Temperature : 23.5 °C

DASY5 Configuration:

- Probe: ET3DV6 - SN1790; ConvF(6.37, 6.37, 6.37); Calibrated: 2016/06/24;
- Sensor-Surface: 4mm (Mechanical Surface Detection)
- Electronics: DAE4 Sn1277; Calibrated: 2016/07/22
- Phantom: ELI Phantom_1206; Type: QDOVA;
- Measurement SW: DASY52, Version 52.8 (8); SEMCAD X Version 14.6.10 (7373)

Pin=250mW/Area Scan (61x61x1): Interpolated grid: $dx=1.500 \text{ mm}$, $dy=1.500 \text{ mm}$
Maximum value of SAR (interpolated) = 3.14 W/kg

Pin=250mW/Zoom Scan (5x5x7)/Cube 0: Measurement grid: $dx=8\text{mm}$, $dy=8\text{mm}$, $dz=5\text{mm}$
Reference Value = 53.92 V/m; Power Drift = -0.04 dB
Peak SAR (extrapolated) = 3.61 W/kg
SAR(1 g) = 2.5 W/kg; SAR(10 g) = 1.66 W/kg
Maximum value of SAR (measured) = 3.13 W/kg

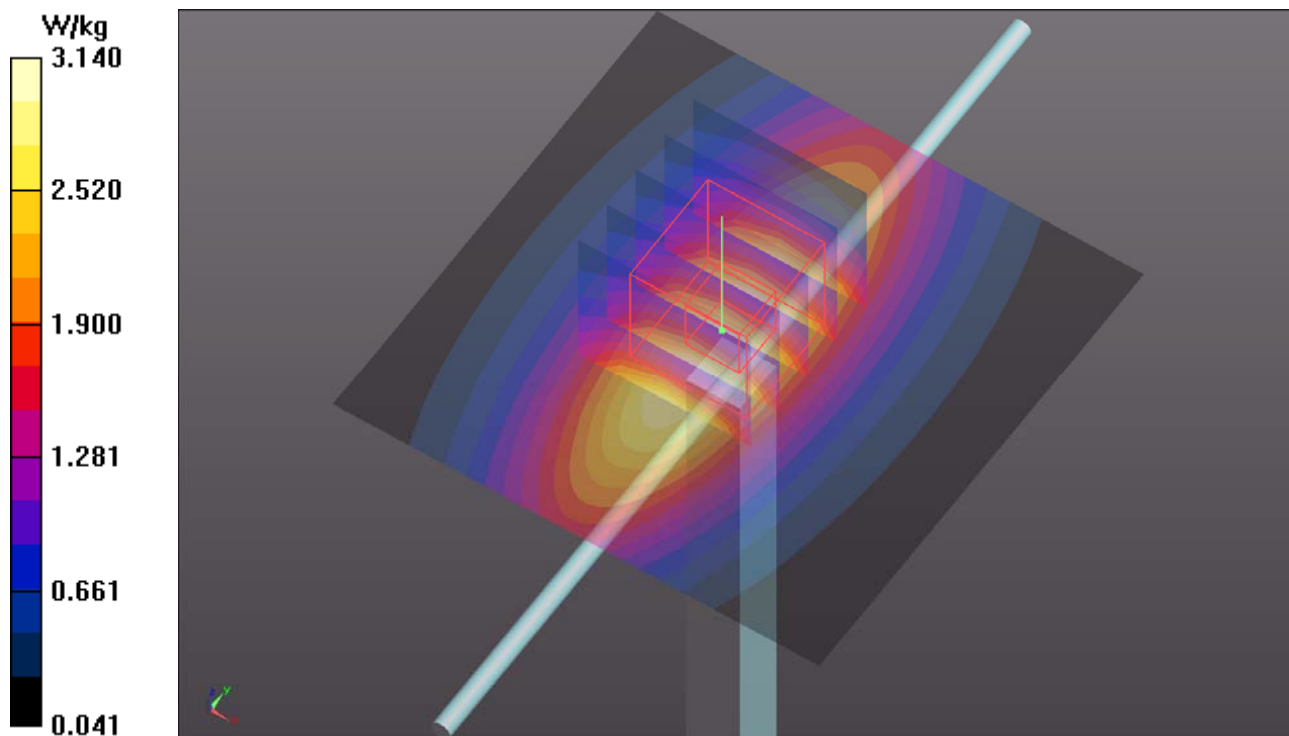

System Check_B1750_170213

DUT: Dipole 1750 MHz; Type: D1750V2; SN: 1055

Communication System: CW; Frequency: 1750 MHz; Duty Cycle: 1:1

Medium: B16T20N1_0213 Medium parameters used: $f = 1750$ MHz; $\sigma = 1.44$ S/m; $\epsilon_r = 51.715$; $\rho = 1000$ kg/m³

Ambient Temperature : 23.8 °C ; Liquid Temperature : 23.1 °C

DASY5 Configuration:

- Probe: EX3DV4 - SN3820; ConvF(7.65, 7.65, 7.65); Calibrated: 2016/06/27;
- Sensor-Surface: 1.4mm (Mechanical Surface Detection)
- Electronics: DAE4 Sn913; Calibrated: 2016/03/31
- Phantom: ELI Phantom_1206; Type: QDOVA;
- Measurement SW: DASY52, Version 52.8 (8); SEMCAD X Version 14.6.10 (7373)

Pin=250mW/Area Scan (61x61x1): Interpolated grid: dx=1.500 mm, dy=1.500 mm
Maximum value of SAR (interpolated) = 13.2 W/kg

Pin=250mW/Zoom Scan (5x5x7)/Cube 0: Measurement grid: dx=8mm, dy=8mm, dz=5mm
Reference Value = 94.69 V/m; Power Drift = -0.03 dB
Peak SAR (extrapolated) = 15.5 W/kg
SAR(1 g) = 8.92 W/kg; SAR(10 g) = 4.78 W/kg
Maximum value of SAR (measured) = 12.3 W/kg

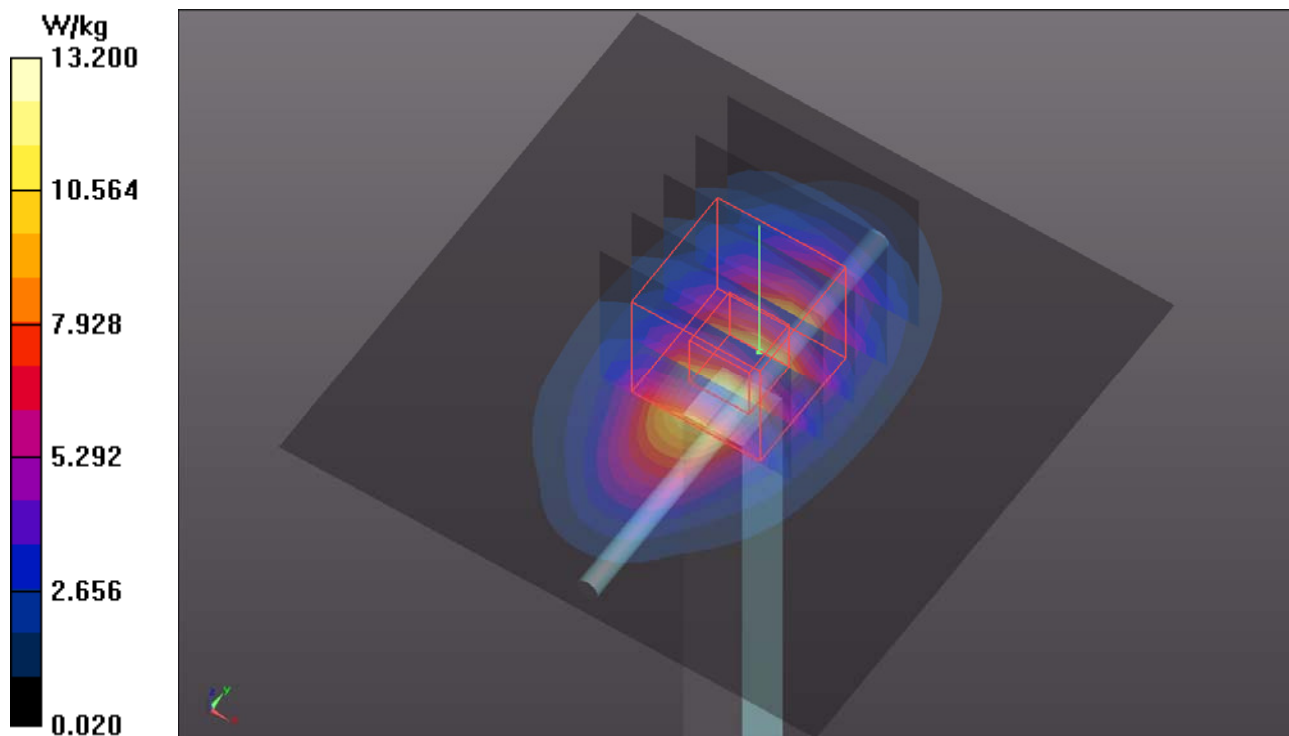

System Check_B1900_170213

DUT: Dipole 1900 MHz; Type: D1900V2; SN: 5d142

Communication System: CW; Frequency: 1900 MHz; Duty Cycle: 1:1

Medium: B16T20N1_0213 Medium parameters used: $f = 1900$ MHz; $\sigma = 1.554$ S/m; $\epsilon_r = 51.475$; $\rho = 1000$ kg/m³

Ambient Temperature : 23.8 °C ; Liquid Temperature : 23.2 °C

DASY5 Configuration:

- Probe: EX3DV4 - SN3820; ConvF(7.41, 7.41, 7.41); Calibrated: 2016/06/27;
- Sensor-Surface: 1.4mm (Mechanical Surface Detection)
- Electronics: DAE4 Sn913; Calibrated: 2016/03/31
- Phantom: ELI Phantom_1206; Type: QDOVA;
- Measurement SW: DASY52, Version 52.8 (8); SEMCAD X Version 14.6.10 (7373)

Pin=250mW/Area Scan (61x61x1): Interpolated grid: dx=1.500 mm, dy=1.500 mm
Maximum value of SAR (interpolated) = 15.8 W/kg

Pin=250mW/Zoom Scan (5x5x7)/Cube 0: Measurement grid: dx=8mm, dy=8mm, dz=5mm
Reference Value = 99.62 V/m; Power Drift = 0.03 dB
Peak SAR (extrapolated) = 18.8 W/kg
SAR(1 g) = 10.5 W/kg; SAR(10 g) = 5.47 W/kg
Maximum value of SAR (measured) = 14.8 W/kg

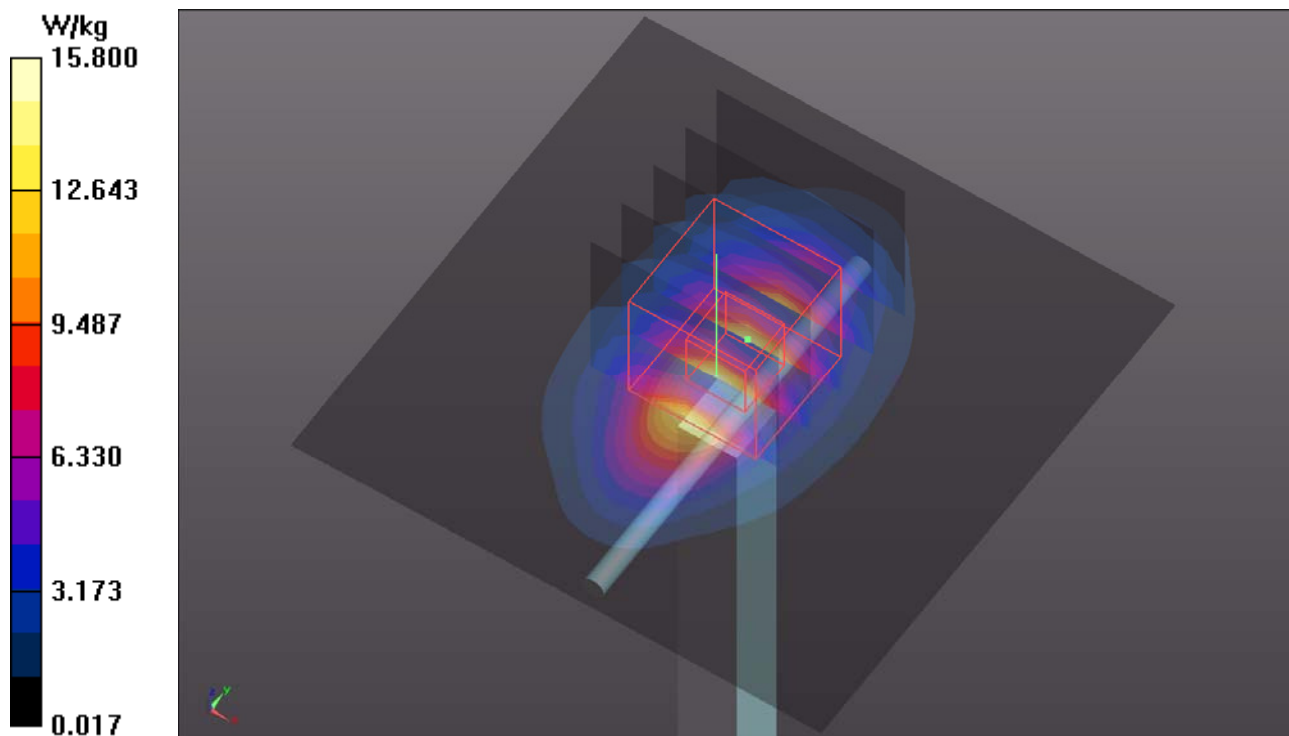

System Check_B2600_161209

DUT: Dipole 2600 MHz; Type: D2600V2; SN: 1020

Communication System: CW; Frequency: 2600 MHz; Duty Cycle: 1:1

Medium: B19T27N2_1209 Medium parameters used: $f = 2600$ MHz; $\sigma = 2.173$ S/m; $\epsilon_r = 50.236$; $\rho = 1000$ kg/m³

Ambient Temperature : 23.8 °C ; Liquid Temperature : 23.5 °C

DASY5 Configuration:

- Probe: EX3DV4 - SN3971; ConvF(6.88, 6.88, 6.88); Calibrated: 2016/03/23;
- Sensor-Surface: 1.4mm (Mechanical Surface Detection)
- Electronics: DAE3 Sn579; Calibrated: 2016/09/05
- Phantom: ELI Phantom_1206; Type: QDOVA;
- Measurement SW: DASY52, Version 52.8 (8); SEMCAD X Version 14.6.10 (7373)

Pin=250mW/Area Scan (81x81x1): Interpolated grid: dx=1.200 mm, dy=1.200 mm

Maximum value of SAR (interpolated) = 23.8 W/kg

Pin=250mW/Zoom Scan (7x7x7)/Cube 0: Measurement grid: dx=5mm, dy=5mm, dz=5mm

Reference Value = 105.3 V/m; Power Drift = 0.01 dB

Peak SAR (extrapolated) = 33.0 W/kg

SAR(1 g) = 15 W/kg; SAR(10 g) = 6.64 W/kg

Maximum value of SAR (measured) = 23.7 W/kg

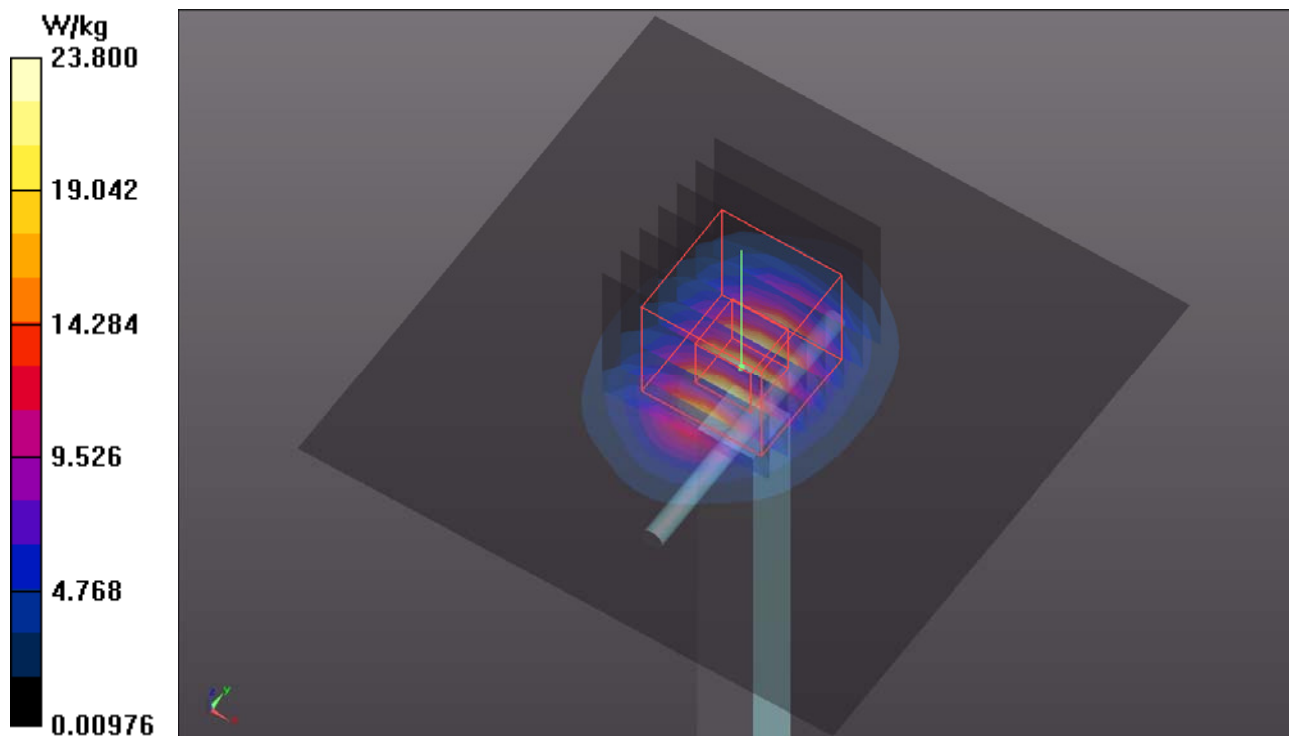

System Check_B2450_161117

DUT: Dipole 2450 MHz; Type: D2450V2; SN: 737

Communication System: CW ; Frequency: 2450 MHz;Duty Cycle: 1:1

Medium: B19T27N1_1117 Medium parameters used: $f = 2450$ MHz; $\sigma = 2.024$ S/m; $\epsilon_r = 50.672$; $\rho = 1000$ kg/m³

Ambient Temperature : 23.6 °C ; Liquid Temperature : 23.5 °C

DASY5 Configuration:

- Probe: EX3DV4 - SN7350; ConvF(7.49, 7.49, 7.49); Calibrated: 2015/12/17;
- Sensor-Surface: 1.4mm (Mechanical Surface Detection)
- Electronics: DAE4 Sn1305; Calibrated: 2015/12/11
- Phantom: ELI Phantom_1039; Type: QDOVA;
- Measurement SW: DASY52, Version 52.8 (8); SEMCAD X Version 14.6.10 (7373)

Pin=250mW/Area Scan (81x81x1): Interpolated grid: dx=1.200 mm, dy=1.200 mm
Maximum value of SAR (interpolated) = 20.5 W/kg

Pin=250mW/Zoom Scan (7x7x7)/Cube 0: Measurement grid: dx=5mm, dy=5mm, dz=5mm
Reference Value = 93.21 V/m; Power Drift = -0.04 dB
Peak SAR (extrapolated) = 26.1 W/kg
SAR(1 g) = 12.6 W/kg; SAR(10 g) = 5.83 W/kg
Maximum value of SAR (measured) = 21.1 W/kg

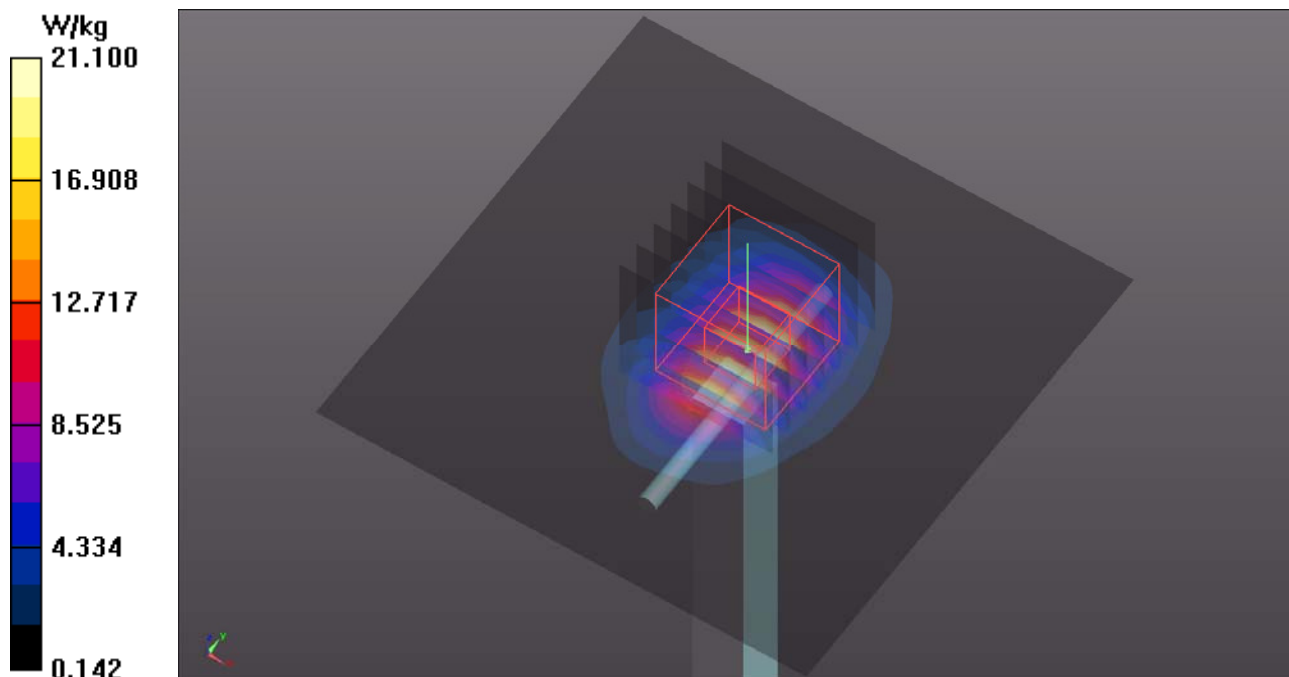

System Check_B5250_170224

DUT: Dipole 5 GHz; Type: D5GHzV2; SN: 1019

Communication System: CW; Frequency: 5250 MHz; Duty Cycle: 1:1

Medium: B34T60N3_0224 Medium parameters used: $f = 5250$ MHz; $\sigma = 5.405$ S/m; $\epsilon_r = 47.547$; $\rho = 1000$ kg/m³

Ambient Temperature : 23.7 °C ; Liquid Temperature : 23.5 °C

DASY5 Configuration:

- Probe: EX3DV4 - SN3971; ConvF(4.54, 4.54, 4.54); Calibrated: 2016/03/23;
- Sensor-Surface: 1.4mm (Mechanical Surface Detection)
- Electronics: DAE4 Sn1431; Calibrated: 2016/03/21
- Phantom: ELI Phantom_1206; Type: QDOVA;
- Measurement SW: DASY52, Version 52.8 (8); SEMCAD X Version 14.6.10 (7373)

Pin=100mW/Area Scan (91x91x1): Interpolated grid: dx=1.000 mm, dy=1.000 mm
Maximum value of SAR (interpolated) = 18.2 W/kg

Pin=100mW/Zoom Scan (7x7x12)/Cube 0: Measurement grid: dx=4mm, dy=4mm, dz=2mm
Reference Value = 68.66 V/m; Power Drift = -0.02 dB
Peak SAR (extrapolated) = 30.5 W/kg
SAR(1 g) = 7.97 W/kg; SAR(10 g) = 2.27 W/kg
Maximum value of SAR (measured) = 19.7 W/kg

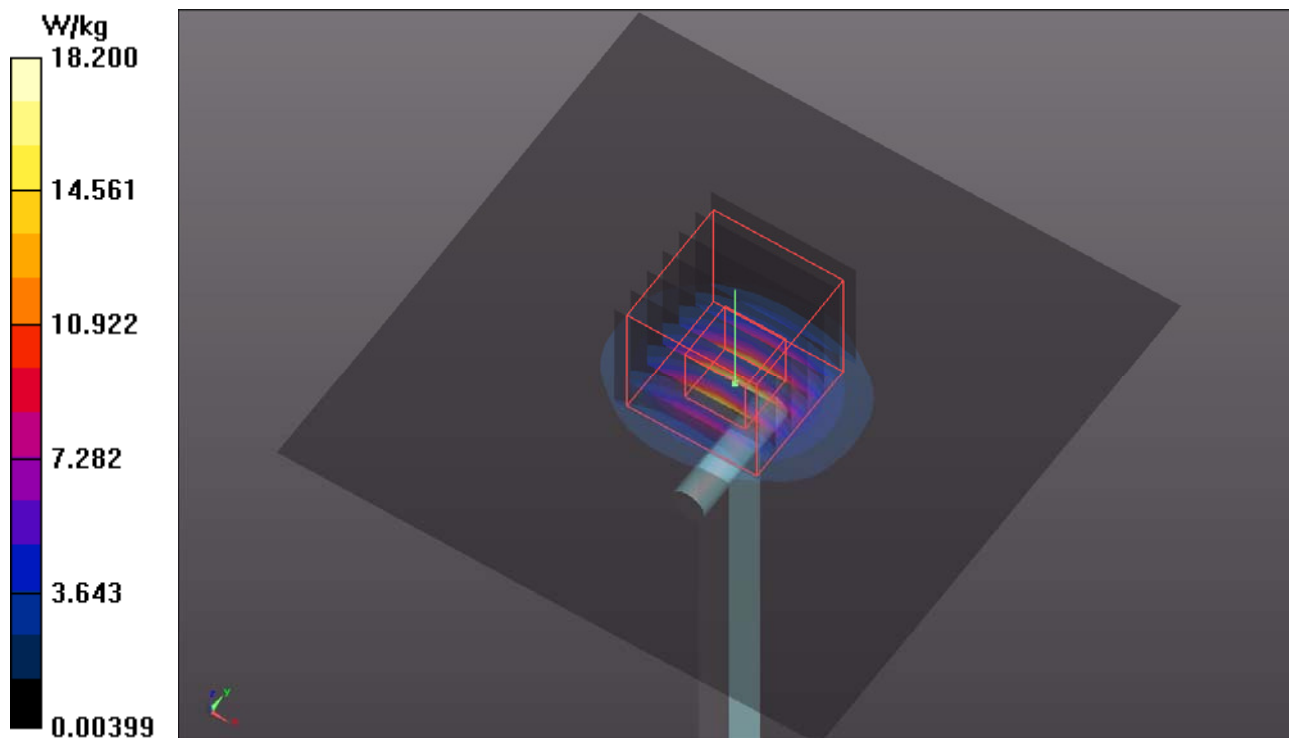

System Check_B5600_161213

DUT: Dipole 5 GHz; Type: D5GHzV2; SN: 1019

Communication System: CW; Frequency: 5600 MHz; Duty Cycle: 1:1

Medium: B34T60N3_1213 Medium parameters used: $f = 5600$ MHz; $\sigma = 5.792$ S/m; $\epsilon_r = 48.099$; $\rho = 1000$ kg/m³

Ambient Temperature : 23.9 °C ; Liquid Temperature : 23.5 °C

DASY5 Configuration:

- Probe: EX3DV4 - SN3971; ConvF(3.68, 3.68, 3.68); Calibrated: 2016/03/23;
- Sensor-Surface: 1.4mm (Mechanical Surface Detection)
- Electronics: DAE3 Sn579; Calibrated: 2016/09/05
- Phantom: ELI Phantom_1204; Type: QDOVA;
- Measurement SW: DASY52, Version 52.8 (8); SEMCAD X Version 14.6.10 (7373)

Pin=100mW/Area Scan (91x91x1): Interpolated grid: dx=1.000 mm, dy=1.000 mm
Maximum value of SAR (interpolated) = 18.1 W/kg

Pin=100mW/Zoom Scan (7x7x12)/Cube 0: Measurement grid: dx=4mm, dy=4mm, dz=2mm
Reference Value = 68.26 V/m; Power Drift = -0.08 dB
Peak SAR (extrapolated) = 31.4 W/kg
SAR(1 g) = 7.79 W/kg; SAR(10 g) = 2.18 W/kg
Maximum value of SAR (measured) = 19.9 W/kg

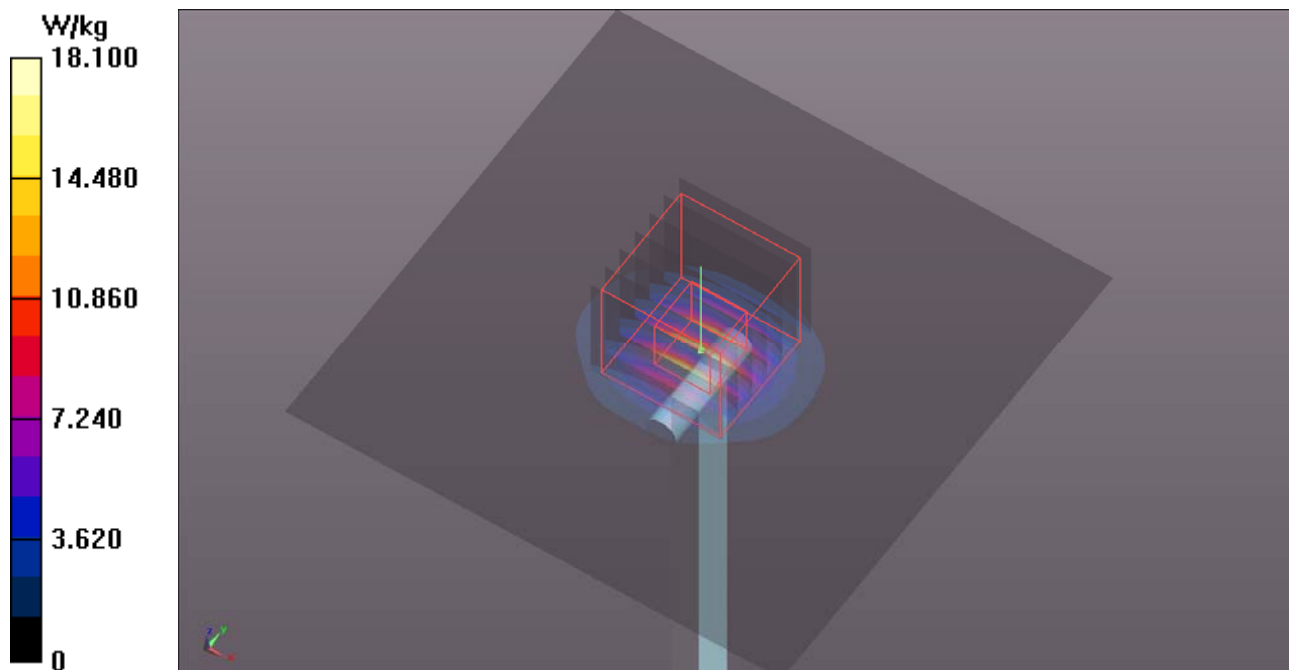

System Check_B5800_161213

DUT: Dipole 5 GHz; Type: D5GHzV2; SN: 1019

Communication System: CW; Frequency: 5800 MHz; Duty Cycle: 1:1

Medium: B34T60N3_1213 Medium parameters used: $f = 5800$ MHz; $\sigma = 6.245$ S/m; $\epsilon_r = 48.363$; $\rho = 1000$ kg/m³

Ambient Temperature : 23.9 °C ; Liquid Temperature : 23.5 °C

DASY5 Configuration:

- Probe: EX3DV4 - SN3971; ConvF(3.9, 3.9, 3.9); Calibrated: 2016/03/23;
- Sensor-Surface: 1.4mm (Mechanical Surface Detection)
- Electronics: DAE3 Sn579; Calibrated: 2016/09/05
- Phantom: ELI Phantom_1204; Type: QDOVA;
- Measurement SW: DASY52, Version 52.8 (8); SEMCAD X Version 14.6.10 (7373)

Pin=100mW/Area Scan (91x91x1): Interpolated grid: dx=1.000 mm, dy=1.000 mm
Maximum value of SAR (interpolated) = 19.2 W/kg

Pin=100mW/Zoom Scan (7x7x12)/Cube 0: Measurement grid: dx=4mm, dy=4mm, dz=2mm
Reference Value = 68.18 V/m; Power Drift = -0.07 dB
Peak SAR (extrapolated) = 34.6 W/kg
SAR(1 g) = 8.21 W/kg; SAR(10 g) = 2.31 W/kg
Maximum value of SAR (measured) = 21.3 W/kg

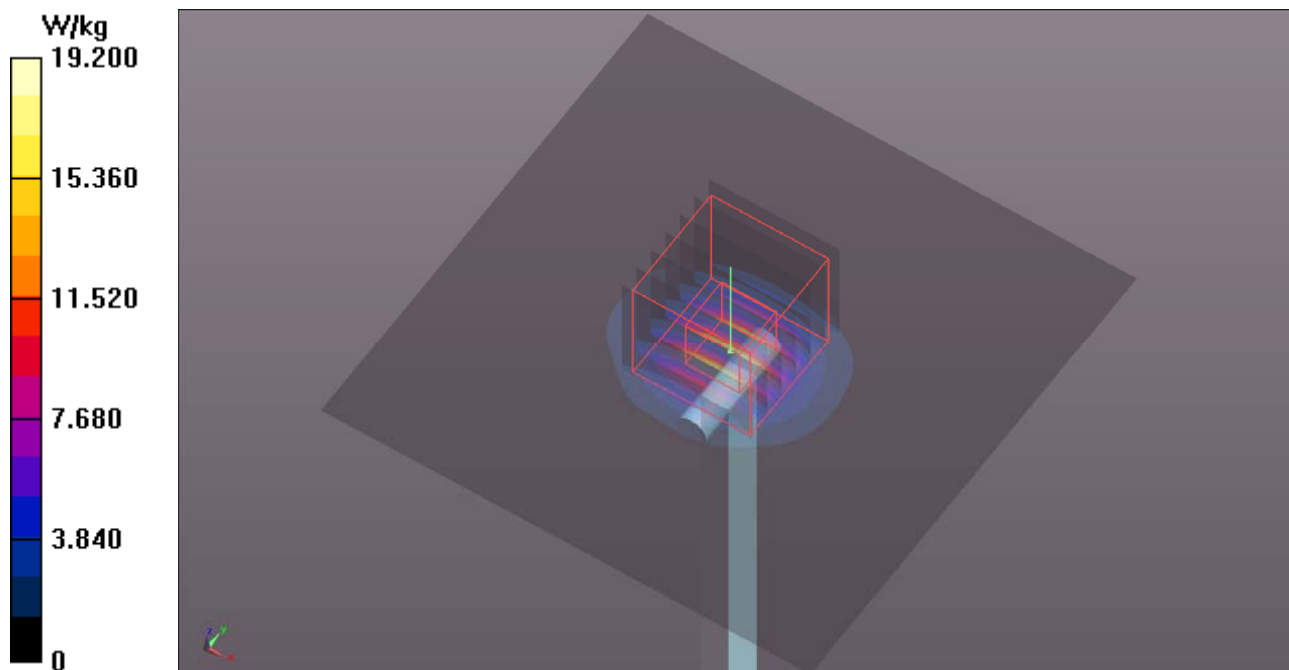

System Check_B2450_170104

DUT: Dipole 2450 MHz; Type: D2450V2; SN: 737

Communication System: CW; Frequency: 2450 MHz; Duty Cycle: 1:1

Medium: B19T27N2_0104 Medium parameters used: $f = 2450$ MHz; $\sigma = 2.029$ S/m; $\epsilon_r = 51.7$; $\rho = 1000$ kg/m³

Ambient Temperature : 23.8 °C ; Liquid Temperature : 23.5 °C

DASY5 Configuration:

- Probe: EX3DV4 - SN3864; ConvF(7.82, 7.82, 7.82); Calibrated: 2016/07/25;
- Sensor-Surface: 1.4mm (Mechanical Surface Detection)
- Electronics: DAE4 Sn1431; Calibrated: 2016/03/21
- Phantom: ELI Phantom_1204; Type: QDOVA;
- Measurement SW: DASY52, Version 52.8 (8); SEMCAD X Version 14.6.10 (7373)

Pin=250mW/Area Scan (81x81x1): Interpolated grid: dx=1.200 mm, dy=1.200 mm
Maximum value of SAR (interpolated) = 18.4 W/kg

Pin=250mW/Zoom Scan (7x7x7)/Cube 0: Measurement grid: dx=5mm, dy=5mm, dz=5mm
Reference Value = 96.18 V/m; Power Drift = -0.12 dB
Peak SAR (extrapolated) = 25.1 W/kg
SAR(1 g) = 12 W/kg; SAR(10 g) = 5.5 W/kg
Maximum value of SAR (measured) = 18.5 W/kg

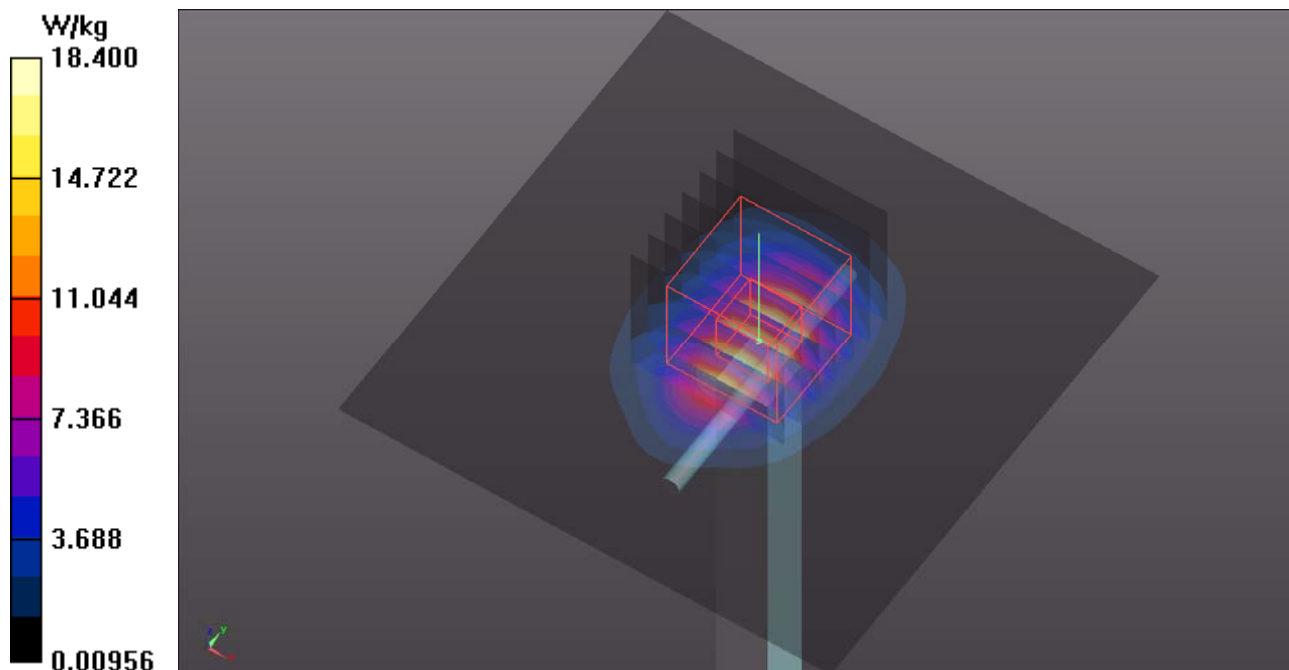

System Check_B5250_170104

DUT: Dipole 5 GHz; Type: D5GHzV2; SN: 1019

Communication System: CW; Frequency: 5250 MHz; Duty Cycle: 1:1

Medium: B34T60N3_0104 Medium parameters used: $f = 5250$ MHz; $\sigma = 5.357$ S/m; $\epsilon_r = 48.606$; $\rho = 1000$ kg/m³

Ambient Temperature : 23.9 °C ; Liquid Temperature : 23.3 °C

DASY5 Configuration:

- Probe: EX3DV4 - SN3864; ConvF(4.42, 4.42, 4.42); Calibrated: 2016/07/25;
- Sensor-Surface: 1.4mm (Mechanical Surface Detection)
- Electronics: DAE4 Sn1431; Calibrated: 2016/03/21
- Phantom: ELI Phantom_1204; Type: QDOVA;
- Measurement SW: DASY52, Version 52.8 (8); SEMCAD X Version 14.6.10 (7373)

Pin=100mW/Area Scan (91x91x1): Interpolated grid: dx=1.000 mm, dy=1.000 mm
Maximum value of SAR (interpolated) = 18.5 W/kg

Pin=100mW/Zoom Scan (7x7x12)/Cube 0: Measurement grid: dx=4mm, dy=4mm, dz=2mm
Reference Value = 59.90 V/m; Power Drift = -0.15 dB
Peak SAR (extrapolated) = 29.6 W/kg
SAR(1 g) = 7.81 W/kg; SAR(10 g) = 2.25 W/kg
Maximum value of SAR (measured) = 19.4 W/kg

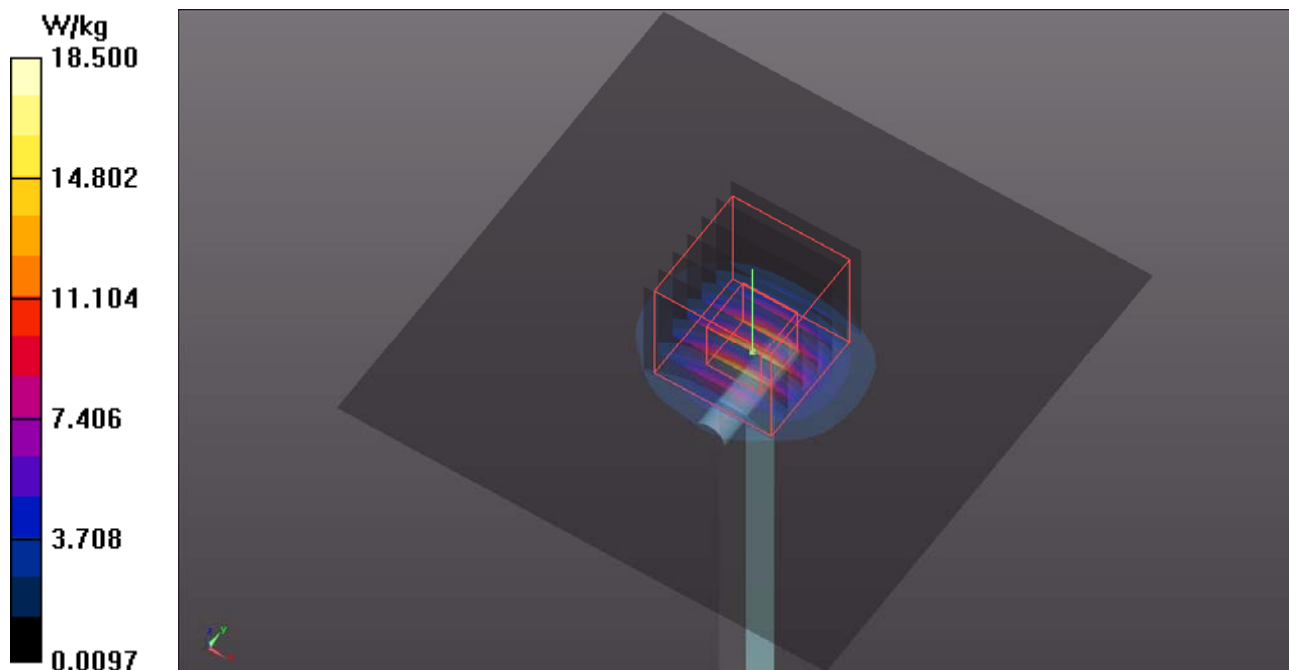

System Check_B5600_170104

DUT: Dipole 5 GHz; Type: D5GHzV2; SN: 1019

Communication System: CW; Frequency: 5600 MHz; Duty Cycle: 1:1

Medium: B34T60N3_0104 Medium parameters used: $f = 5600$ MHz; $\sigma = 5.792$ S/m; $\epsilon_r = 48.099$; $\rho = 1000$ kg/m³

Ambient Temperature : 23.9 °C ; Liquid Temperature : 23.3 °C

DASY5 Configuration:

- Probe: EX3DV4 - SN3864; ConvF(3.85, 3.85, 3.85); Calibrated: 2016/07/25;
- Sensor-Surface: 1.4mm (Mechanical Surface Detection)
- Electronics: DAE4 Sn1431; Calibrated: 2016/03/21
- Phantom: ELI Phantom_1204; Type: QDOVA;
- Measurement SW: DASY52, Version 52.8 (8); SEMCAD X Version 14.6.10 (7373)

Pin=100mW/Area Scan (91x91x1): Interpolated grid: dx=1.000 mm, dy=1.000 mm
Maximum value of SAR (interpolated) = 18.1 W/kg

Pin=100mW/Zoom Scan (7x7x12)/Cube 0: Measurement grid: dx=4mm, dy=4mm, dz=2mm
Reference Value = 67.46 V/m; Power Drift = -0.09 dB
Peak SAR (extrapolated) = 31.1 W/kg
SAR(1 g) = 7.8 W/kg; SAR(10 g) = 2.2 W/kg
Maximum value of SAR (measured) = 19.4 W/kg

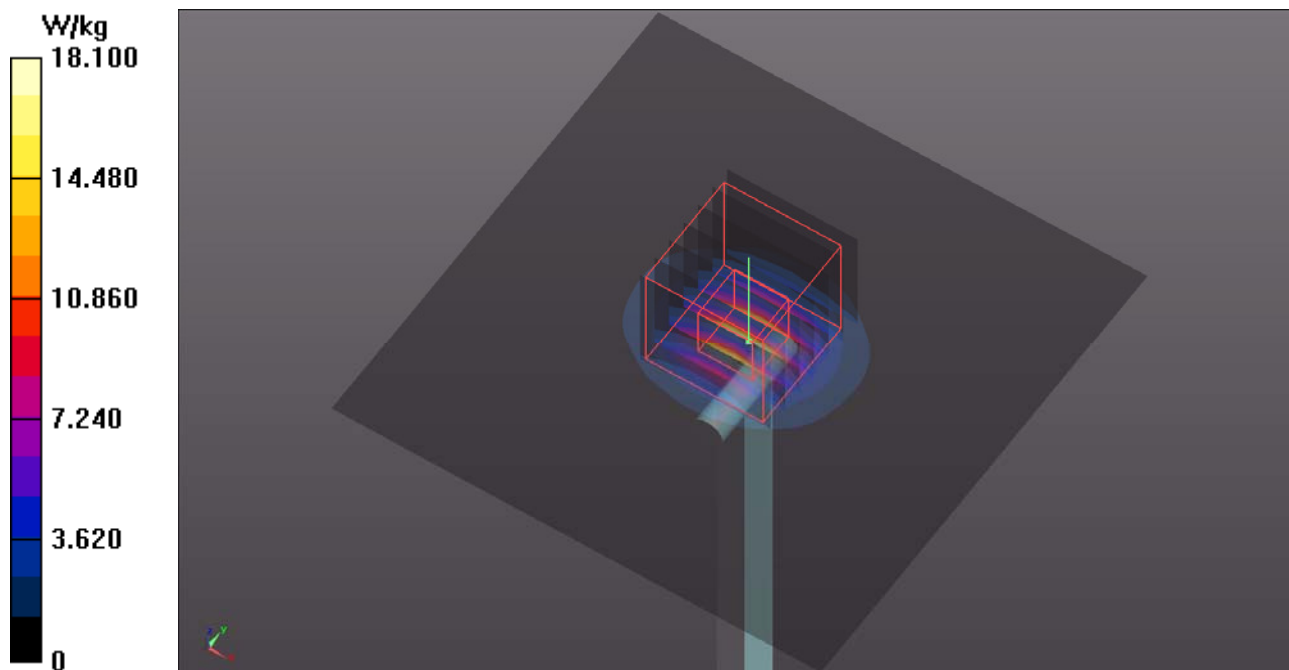

System Check_B5800_160104

DUT: Dipole 5 GHz; Type: D5GHzV2; SN: 1019

Communication System: CW; Frequency: 5800 MHz; Duty Cycle: 1:1

Medium: B34T60N3_0104 Medium parameters used: $f = 5800$ MHz; $\sigma = 6.245$ S/m; $\epsilon_r = 48.363$; $\rho = 1000$ kg/m³

Ambient Temperature : 23.9 °C ; Liquid Temperature : 23.3 °C

DASY5 Configuration:

- Probe: EX3DV4 - SN3864; ConvF(3.96, 3.96, 3.96); Calibrated: 2016/07/25;
- Sensor-Surface: 1.4mm (Mechanical Surface Detection)
- Electronics: DAE4 Sn1431; Calibrated: 2016/03/21
- Phantom: ELI Phantom_1204; Type: QDOVA;
- Measurement SW: DASY52, Version 52.8 (8); SEMCAD X Version 14.6.10 (7373)

Pin=100mW/Area Scan (91x91x1): Interpolated grid: dx=1.000 mm, dy=1.000 mm
Maximum value of SAR (interpolated) = 15.7 W/kg

Pin=100mW/Zoom Scan (7x7x12)/Cube 0: Measurement grid: dx=4mm, dy=4mm, dz=2mm
Reference Value = 58.80 V/m; Power Drift = -0.03 dB
Peak SAR (extrapolated) = 32.0 W/kg
SAR(1 g) = 8.06 W/kg; SAR(10 g) = 2.28 W/kg
Maximum value of SAR (measured) = 17.2 W/kg

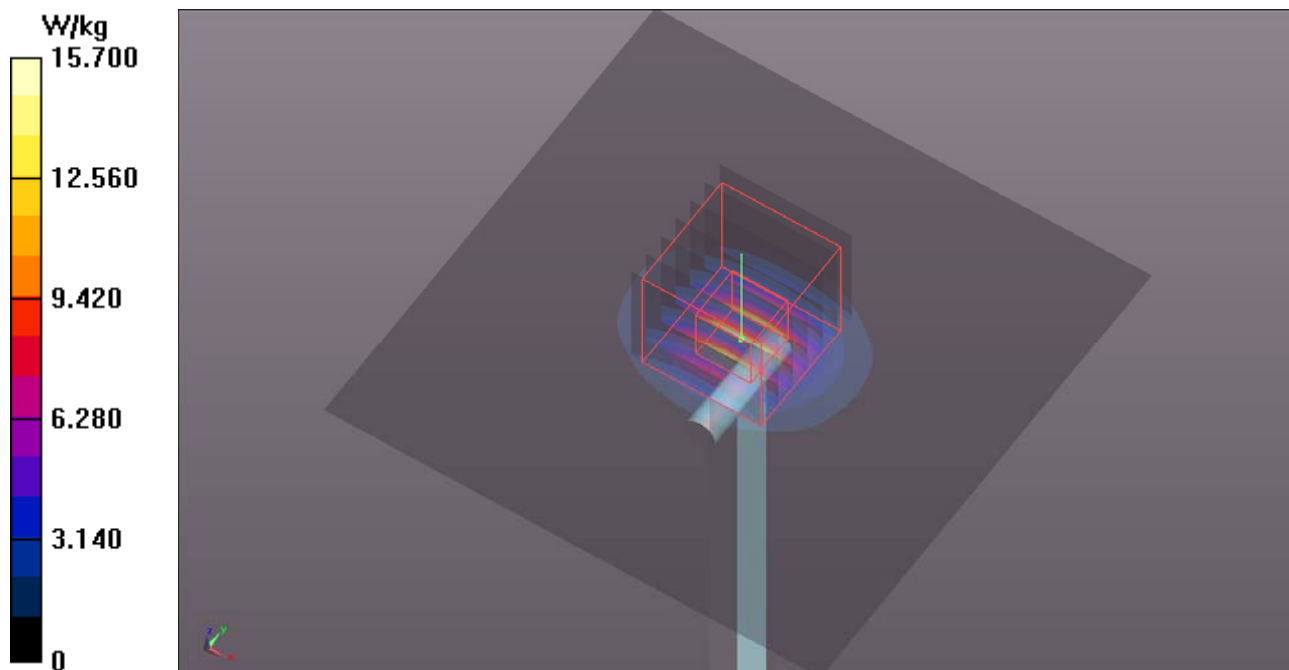

Appendix B. SAR Plots of SAR Measurement

The SAR plots for highest measured SAR in each exposure configuration, wireless mode and frequency band combination, and measured SAR > 1.5 W/kg are shown as follows.

P01 WCDMA II_RMC12.2K_Rear Face_0cm_Ch9538_Sample2_w_o_Battery1

DUT: 160512C18

Communication System: WCDMA; Frequency: 1907.6 MHz; Duty Cycle: 1:1

Medium: B16T20N2_1208 Medium parameters used: $f = 1908$ MHz; $\sigma = 1.58$ S/m; $\epsilon_r = 51.081$; $\rho = 1000$ kg/m³

Ambient Temperature : 23.7 °C ; Liquid Temperature : 23.5 °C

DASY5 Configuration:

- Probe: ET3DV6 - SN1790; ConvF(4.74, 4.74, 4.74); Calibrated: 2016/06/24;
- Sensor-Surface: 4mm (Mechanical Surface Detection)
- Electronics: DAE4 Sn1277; Calibrated: 2016/07/22
- Phantom: ELI Phantom_1206; Type: QDOVA;
- Measurement SW: DASY52, Version 52.8 (8); SEMCAD X Version 14.6.10 (7373)

- **Area Scan (191x251x1):** Interpolated grid: dx=1.500 mm, dy=1.500 mm
Maximum value of SAR (interpolated) = 0.940 W/kg

- **Zoom Scan (5x5x7)/Cube 0:** Measurement grid: dx=8mm, dy=8mm, dz=5mm
Reference Value = 25.48 V/m; Power Drift = -0.11 dB
Peak SAR (extrapolated) = 1.98 W/kg
SAR(1 g) = 1.11 W/kg; SAR(10 g) = 0.628 W/kg
Maximum value of SAR (measured) = 1.19 W/kg

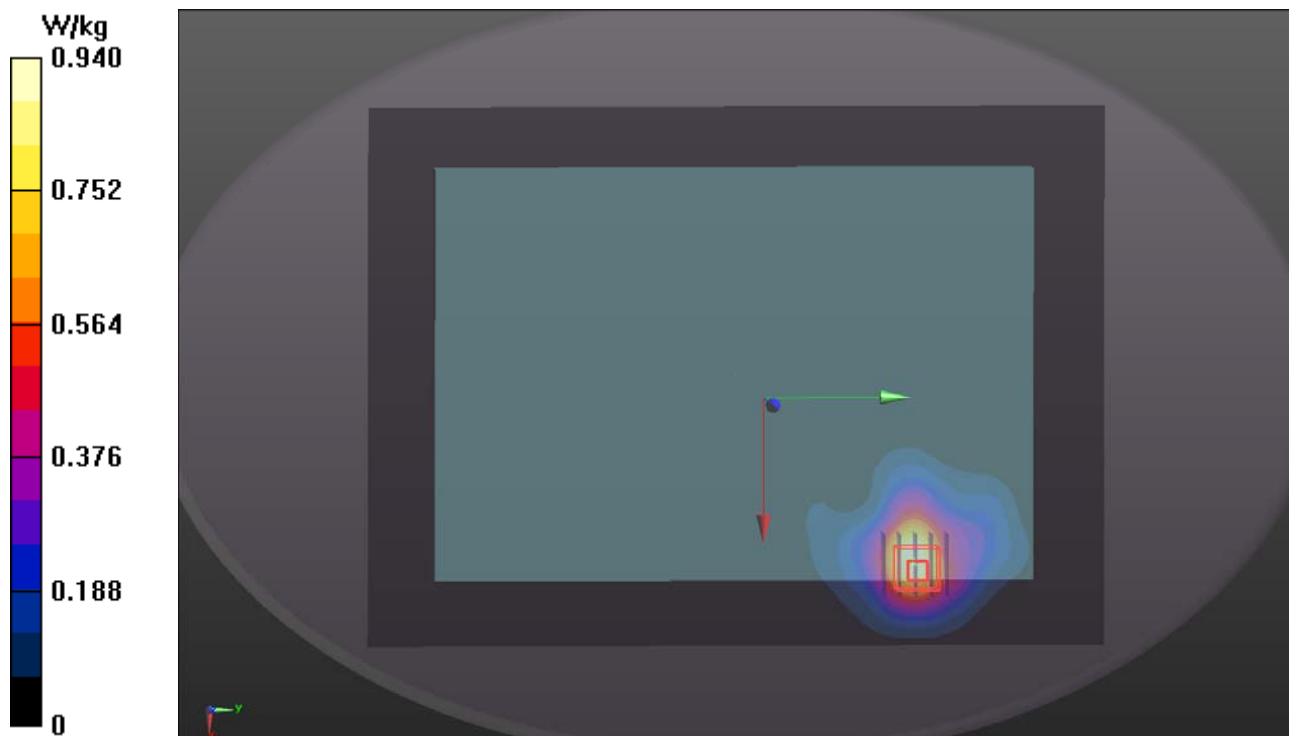

P02 WCDMA IV_RMC12.2K_Rear Face_0cm_Ch1413_Sample2_w_o_Battery1

DUT: 160512C18

Communication System: WCDMA; Frequency: 1732.6 MHz; Duty Cycle: 1:1

Medium: B16T20N2_1208 Medium parameters used: $f = 1733$ MHz; $\sigma = 1.418$ S/m; $\epsilon_r = 51.578$; $\rho = 1000$ kg/m³

Ambient Temperature : 23.7 °C ; Liquid Temperature : 23.5 °C

DASY5 Configuration:

- Probe: ET3DV6 - SN1790; ConvF(4.94, 4.94, 4.94); Calibrated: 2016/06/24;
- Sensor-Surface: 4mm (Mechanical Surface Detection)
- Electronics: DAE4 Sn1277; Calibrated: 2016/07/22
- Phantom: ELI Phantom_1206; Type: QDOVA;
- Measurement SW: DASY52, Version 52.8 (8); SEMCAD X Version 14.6.10 (7373)

- **Area Scan (191x251x1):** Interpolated grid: dx=1.500 mm, dy=1.500 mm
Maximum value of SAR (interpolated) = 1.00 W/kg

- **Zoom Scan (5x5x7)/Cube 0:** Measurement grid: dx=8mm, dy=8mm, dz=5mm
Reference Value = 28.04 V/m; Power Drift = -0.10 dB

Peak SAR (extrapolated) = 1.79 W/kg

SAR(1 g) = 1.08 W/kg; SAR(10 g) = 0.669 W/kg

Maximum value of SAR (measured) = 1.25 W/kg

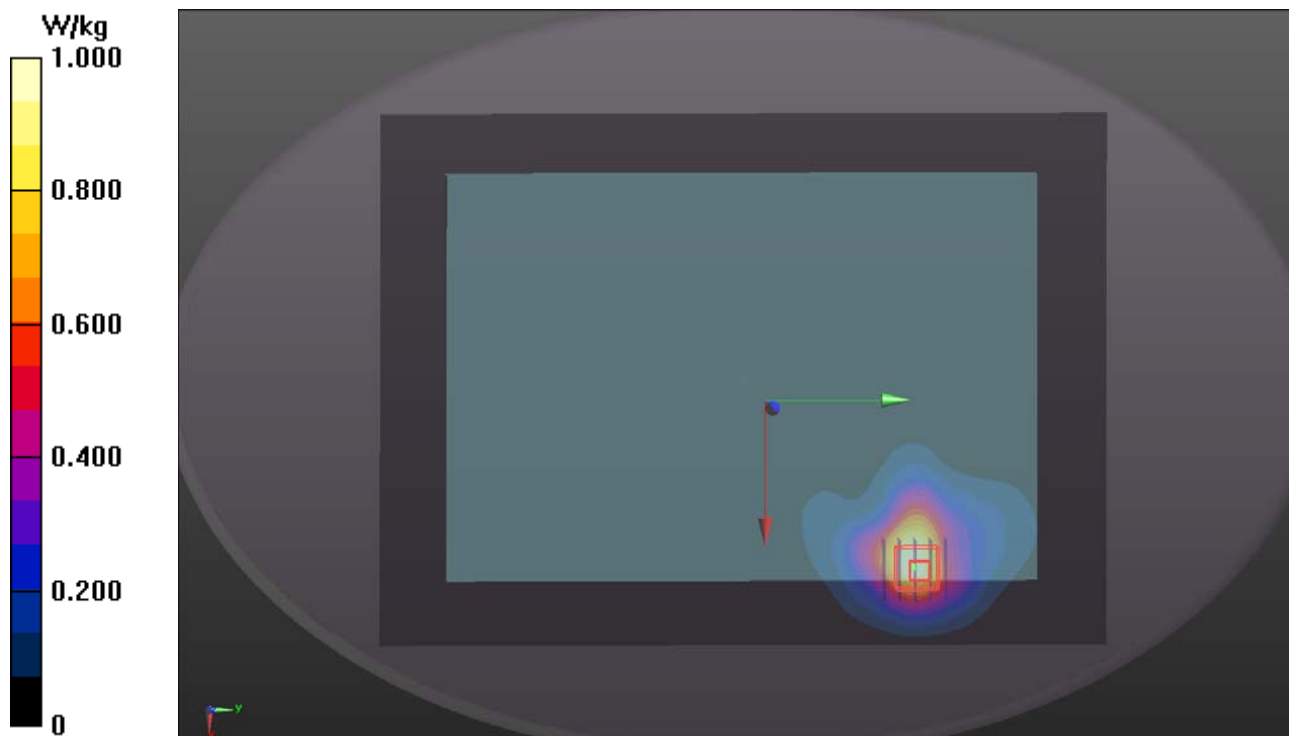

P03 WCDMA V_RMC12.2K_Top Side_0cm_Ch4132_Sample1_Sensor_w_Battery2

DUT: 160512C18

Communication System: WCDMA; Frequency: 826.4 MHz; Duty Cycle: 1:1

Medium: B07T10N3_1209 Medium parameters used: $f = 826.4 \text{ MHz}$; $\sigma = 1.007 \text{ S/m}$; $\epsilon_r = 56.185$; $\rho = 1000 \text{ kg/m}^3$

Ambient Temperature : 23.8 °C ; Liquid Temperature : 23.5 °C

DASY5 Configuration:

- Probe: ET3DV6 - SN1790; ConvF(6.37, 6.37, 6.37); Calibrated: 2016/06/24;
- Sensor-Surface: 4mm (Mechanical Surface Detection)
- Electronics: DAE4 Sn1277; Calibrated: 2016/07/22
- Phantom: ELI Phantom_1206; Type: QDOVA;
- Measurement SW: DASY52, Version 52.8 (8); SEMCAD X Version 14.6.10 (7373)

- **Area Scan (61x231x1):** Interpolated grid: $dx=1.500 \text{ mm}$, $dy=1.500 \text{ mm}$

Maximum value of SAR (interpolated) = 0.924 W/kg

- **Zoom Scan (5x5x7)/Cube 0:** Measurement grid: $dx=8\text{mm}$, $dy=8\text{mm}$, $dz=5\text{mm}$

Reference Value = 31.52 V/m; Power Drift = -0.10 dB

Peak SAR (extrapolated) = 1.53 W/kg

SAR(1 g) = 0.805 W/kg; SAR(10 g) = 0.441 W/kg

Maximum value of SAR (measured) = 0.936 W/kg

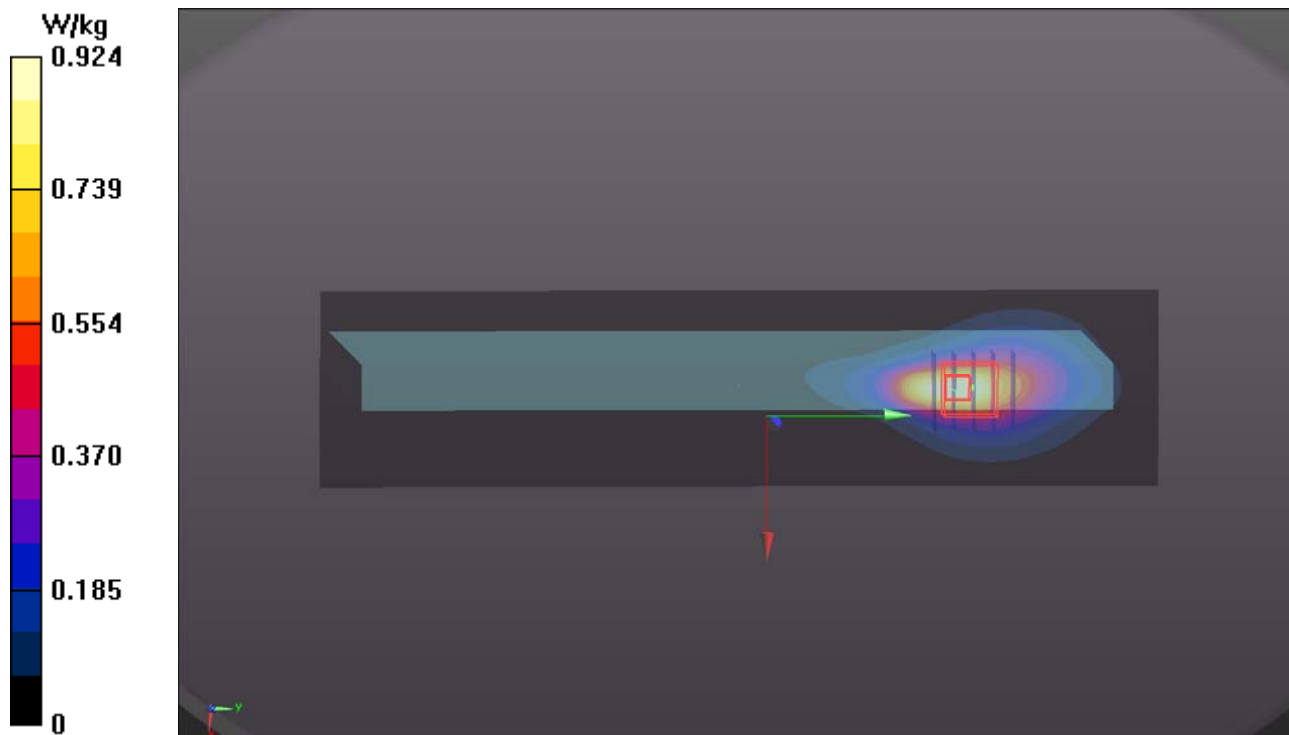

P04 LTE 2_QPSK20M_Top Side_0cm_Ch18700_Sample2_w_Battery1_1RB_OS0

DUT: 160512C18

Communication System: LTE; Frequency: 1860 MHz; Duty Cycle: 1:1

Medium: B16T20N2_1208 Medium parameters used: $f = 1860$ MHz; $\sigma = 1.535$ S/m; $\epsilon_r = 51.206$; $\rho = 1000$ kg/m³

Ambient Temperature : 23.7 °C ; Liquid Temperature : 23.5 °C

DASY5 Configuration:

- Probe: ET3DV6 - SN1790; ConvF(4.74, 4.74, 4.74); Calibrated: 2016/06/24;
- Sensor-Surface: 4mm (Mechanical Surface Detection)
- Electronics: DAE4 Sn1277; Calibrated: 2016/07/22
- Phantom: ELI Phantom_1206; Type: QDOVA;
- Measurement SW: DASY52, Version 52.8 (8); SEMCAD X Version 14.6.10 (7373)

- **Area Scan (51x251x1):** Interpolated grid: dx=1.500 mm, dy=1.500 mm

Maximum value of SAR (interpolated) = 0.801 W/kg

- **Zoom Scan (5x5x7)/Cube 0:** Measurement grid: dx=8mm, dy=8mm, dz=5mm

Reference Value = 22.00 V/m; Power Drift = -0.15 dB

Peak SAR (extrapolated) = 1.75 W/kg

SAR(1 g) = 1.06 W/kg; SAR(10 g) = 0.569 W/kg

Maximum value of SAR (measured) = 1.10 W/kg

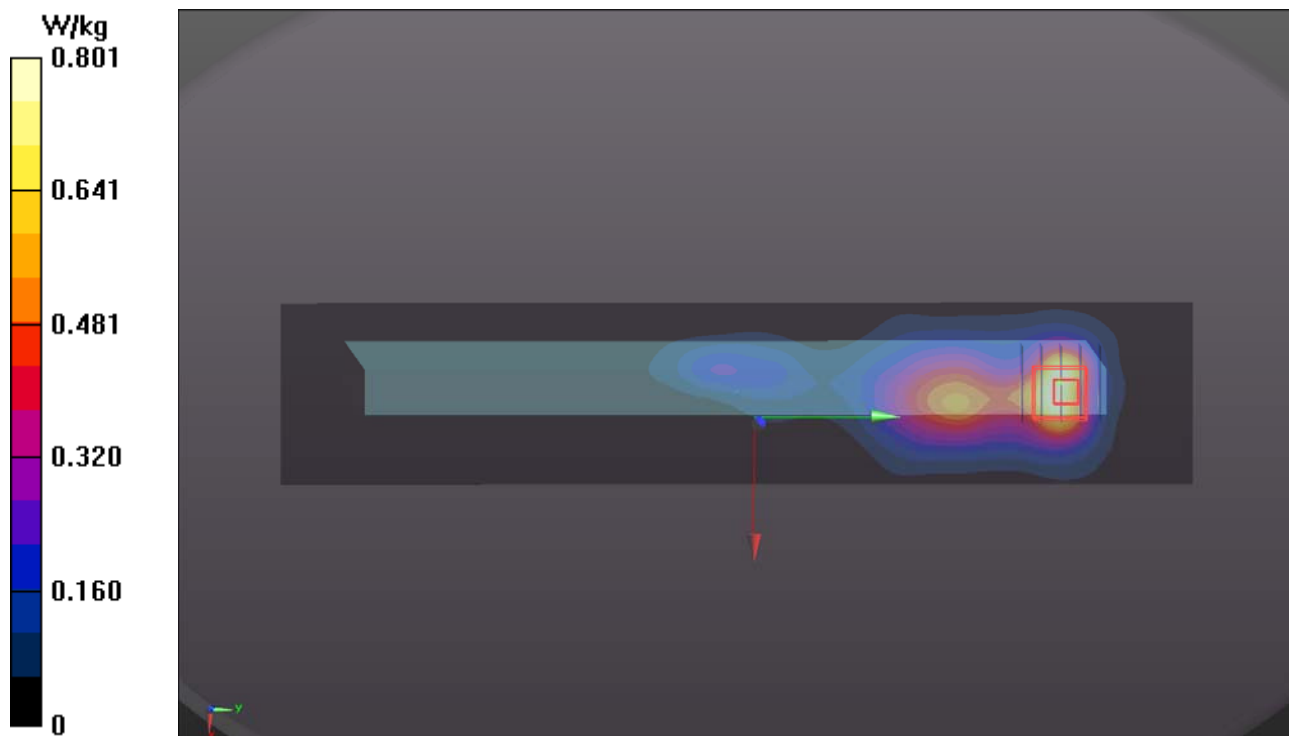

P05 LTE 4_QPSK20M_Top Side_0cm_Ch20050_Sample2_P-sensor_w_Battery1_1RB_OS0

DUT: 160512C18

Communication System: LTE; Frequency: 1720 MHz; Duty Cycle: 1:1

Medium: B16T20N2_1214 Medium parameters used: $f = 1720$ MHz; $\sigma = 1.421$ S/m; $\epsilon_r = 52.578$; $\rho = 1000$ kg/m³

Ambient Temperature : 23.8 °C ; Liquid Temperature : 23.5 °C

DASY5 Configuration:

- Probe: ET3DV6 - SN1790; ConvF(4.94, 4.94, 4.94); Calibrated: 2016/06/24;
- Sensor-Surface: 4mm (Mechanical Surface Detection)
- Electronics: DAE4 Sn1277; Calibrated: 2016/07/22
- Phantom: ELI Phantom_1204; Type: QDOVA;
- Measurement SW: DASY52, Version 52.8 (8); SEMCAD X Version 14.6.10 (7373)

- **Area Scan (41x231x1):** Interpolated grid: dx=1.500 mm, dy=1.500 mm

Maximum value of SAR (interpolated) = 0.858 W/kg

- **Zoom Scan (5x5x7)/Cube 0:** Measurement grid: dx=8mm, dy=8mm, dz=5mm

Reference Value = 24.94 V/m; Power Drift = 0.14 dB

Peak SAR (extrapolated) = 1.65 W/kg

SAR(1 g) = 0.955 W/kg; SAR(10 g) = 0.494 W/kg

Maximum value of SAR (measured) = 1.11 W/kg

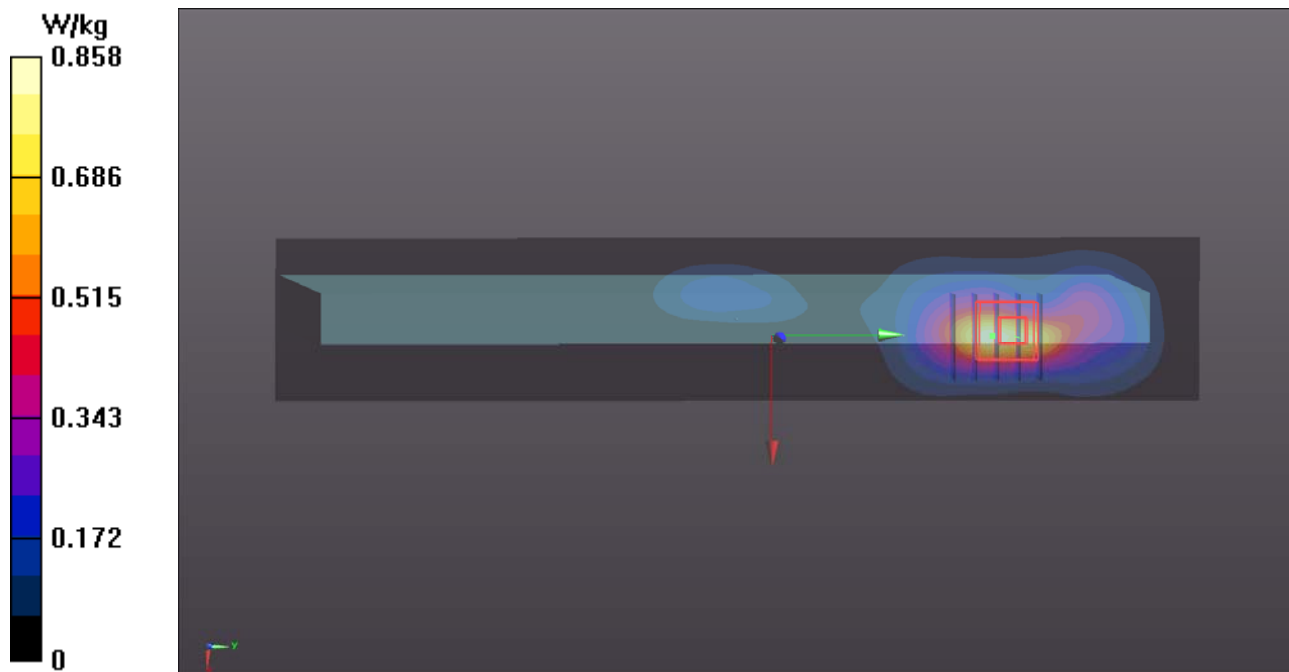

P06 LTE 5_QPSK10M_Top Side_0cm_Ch20450_Sample1_Sensor_w_Battery1_1RB_OS0

DUT: 160512C18

Communication System: LTE; Frequency: 829 MHz; Duty Cycle: 1:1

Medium: B07T10N3_1209 Medium parameters used: $f = 829 \text{ MHz}$; $\sigma = 1.01 \text{ S/m}$; $\epsilon_r = 56.159$; $\rho = 1000 \text{ kg/m}^3$

Ambient Temperature : $23.8 \text{ }^\circ\text{C}$; Liquid Temperature : $23.5 \text{ }^\circ\text{C}$

DASY5 Configuration:

- Probe: ET3DV6 - SN1790; ConvF(6.37, 6.37, 6.37); Calibrated: 2016/06/24;
- Sensor-Surface: 4mm (Mechanical Surface Detection)
- Electronics: DAE4 Sn1277; Calibrated: 2016/07/22
- Phantom: ELI Phantom_1206; Type: QDOVA;
- Measurement SW: DASY52, Version 52.8 (8); SEMCAD X Version 14.6.10 (7373)

- **Area Scan (61x231x1):** Interpolated grid: $dx=1.500 \text{ mm}$, $dy=1.500 \text{ mm}$

Maximum value of SAR (interpolated) = 1.29 W/kg

- **Zoom Scan (5x5x7)/Cube 0:** Measurement grid: $dx=8\text{mm}$, $dy=8\text{mm}$, $dz=5\text{mm}$

Reference Value = 37.80 V/m ; Power Drift = -0.02 dB

Peak SAR (extrapolated) = 2.17 W/kg

SAR(1 g) = 1.11 W/kg ; SAR(10 g) = 0.661 W/kg

Maximum value of SAR (measured) = 1.31 W/kg

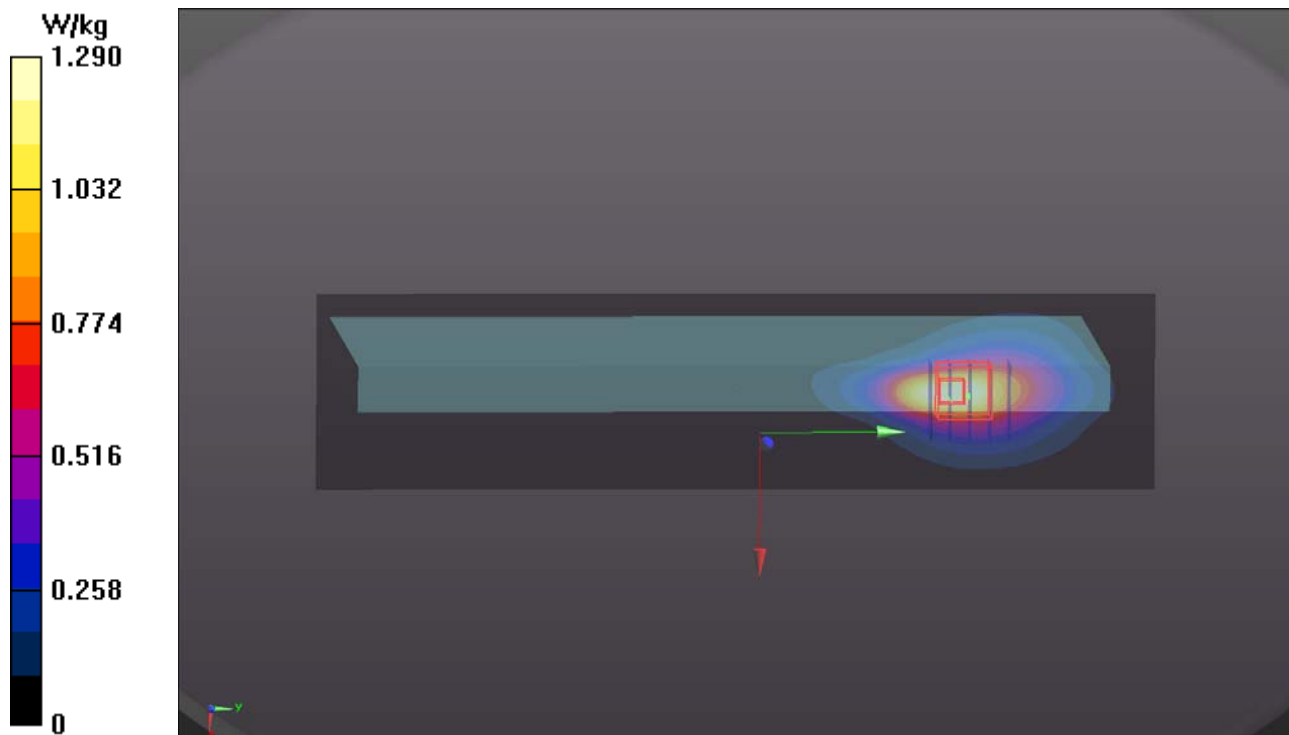

P07 LTE 7_QPSK20M_Top Side_0cm_Ch21100_Sample1_P-sensor_w_Battery1_1RB_OS0

DUT: 160512C18

Communication System: LTE; Frequency: 2535 MHz; Duty Cycle: 1:1

Medium: B19T27N3_1214 Medium parameters used: $f = 2535$ MHz; $\sigma = 2.146$ S/m; $\epsilon_r = 53.447$; $\rho = 1000$ kg/m³

Ambient Temperature : 23.8 °C ; Liquid Temperature : 23.5 °C

DASY5 Configuration:

- Probe: EX3DV4 - SN3971; ConvF(6.88, 6.88, 6.88); Calibrated: 2016/03/23;
- Sensor-Surface: 1.4mm (Mechanical Surface Detection)
- Electronics: DAE3 Sn579; Calibrated: 2016/09/05
- Phantom: ELI Phantom_1204; Type: QDOVA;
- Measurement SW: DASY52, Version 52.8 (8); SEMCAD X Version 14.6.10 (7373)

- **Area Scan (41x281x1):** Interpolated grid: dx=1.200 mm, dy=1.200 mm

Maximum value of SAR (interpolated) = 0.961 W/kg

- **Zoom Scan (5x5x7)/Cube 0:** Measurement grid: dx=8mm, dy=8mm, dz=5mm

Reference Value = 16.34 V/m; Power Drift = -0.13 dB

Peak SAR (extrapolated) = 1.31 W/kg

SAR(1 g) = 0.545 W/kg; SAR(10 g) = 0.246 W/kg

Maximum value of SAR (measured) = 1.01 W/kg

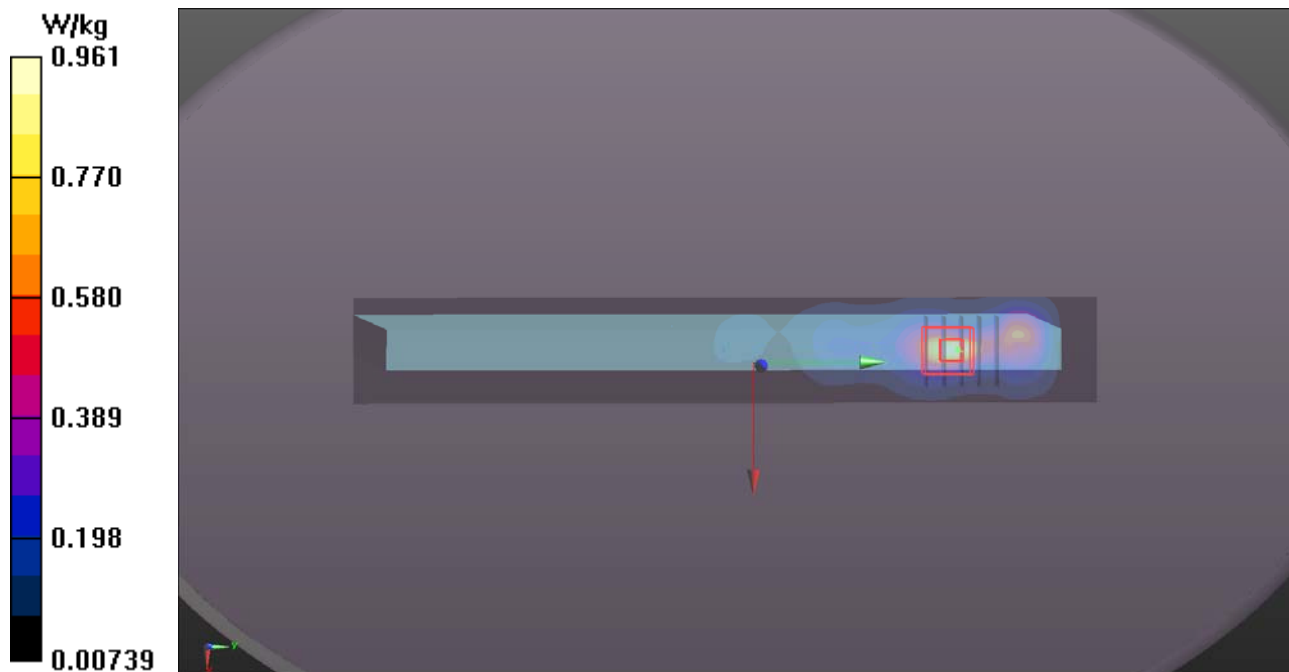

P08 LTE 12_QPSK10M_Top Side_0cm_Ch23130_Sample1_Sensor_w_Battery2_1RB_OS0

DUT: 160512C18

Communication System: LTE; Frequency: 711 MHz; Duty Cycle: 1:1

Medium: B06T09N1_1209 Medium parameters used: $f = 711 \text{ MHz}$; $\sigma = 0.924 \text{ S/m}$; $\epsilon_r = 54.886$; $\rho = 1000 \text{ kg/m}^3$

Ambient Temperature : 23.7 °C ; Liquid Temperature : 23.5 °C

DASY5 Configuration:

- Probe: ET3DV6 - SN1790; ConvF(6.44, 6.44, 6.44); Calibrated: 2016/06/24;
- Sensor-Surface: 4mm (Mechanical Surface Detection)
- Electronics: DAE4 Sn1277; Calibrated: 2016/07/22
- Phantom: ELI Phantom_1206; Type: QDOVA;
- Measurement SW: DASY52, Version 52.8 (8); SEMCAD X Version 14.6.10 (7373)

- **Area Scan (61x231x1):** Interpolated grid: $dx=1.500 \text{ mm}$, $dy=1.500 \text{ mm}$

Maximum value of SAR (interpolated) = 1.14 W/kg

- **Zoom Scan (5x5x7)/Cube 0:** Measurement grid: $dx=8\text{mm}$, $dy=8\text{mm}$, $dz=5\text{mm}$

Reference Value = 36.12 V/m; Power Drift = -0.06 dB

Peak SAR (extrapolated) = 1.87 W/kg

SAR(1 g) = 1.01 W/kg; SAR(10 g) = 0.558 W/kg

Maximum value of SAR (measured) = 1.15 W/kg

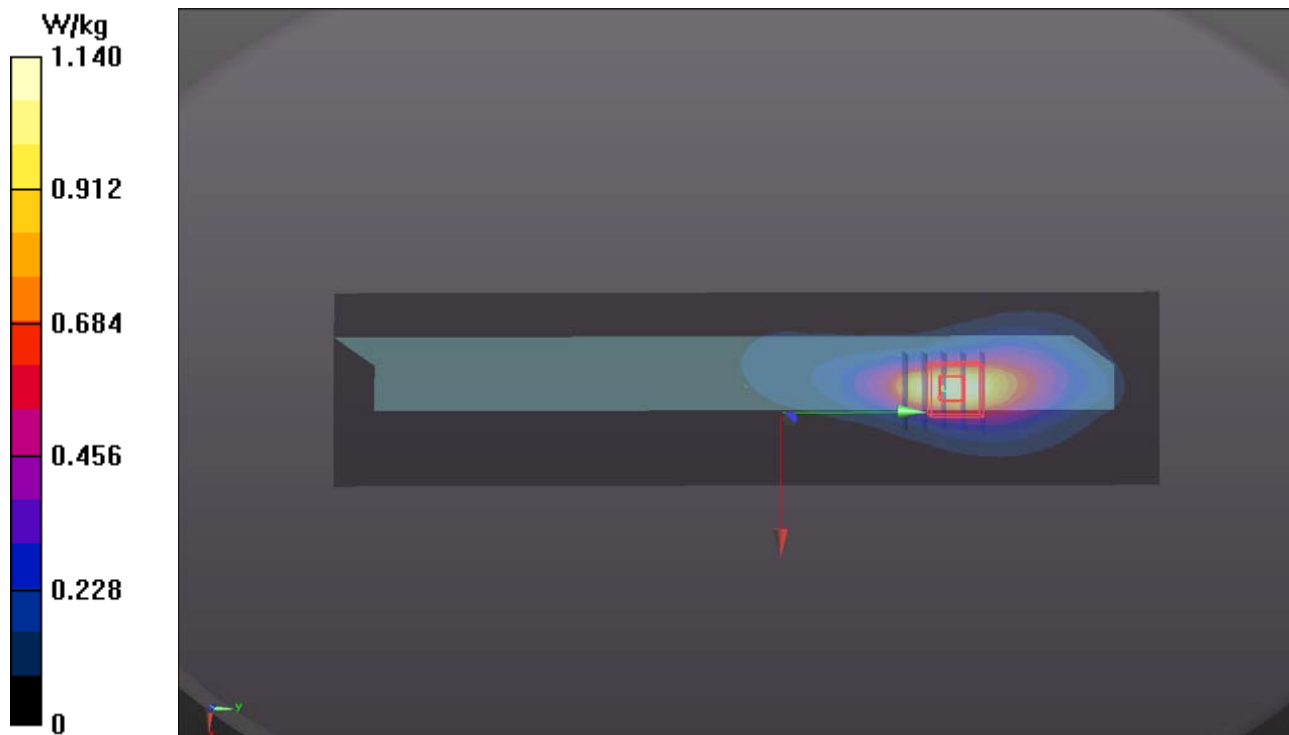

P09 LTE 13_QPSK10M_Top Side_0cm_Ch23230_Sample1_Sensor_w_Battery2_1RB_OS0

DUT: 160512C18

Communication System: LTE; Frequency: 782 MHz; Duty Cycle: 1:1

Medium: B06T09N1_1209 Medium parameters used: $f = 782 \text{ MHz}$; $\sigma = 0.99 \text{ S/m}$; $\epsilon_r = 54.147$; $\rho =$

1000 kg/m^3

Ambient Temperature : $23.7 \text{ }^\circ\text{C}$; Liquid Temperature : $23.5 \text{ }^\circ\text{C}$

DASY5 Configuration:

- Probe: ET3DV6 - SN1790; ConvF(6.44, 6.44, 6.44); Calibrated: 2016/06/24;
- Sensor-Surface: 4mm (Mechanical Surface Detection)
- Electronics: DAE4 Sn1277; Calibrated: 2016/07/22
- Phantom: ELI Phantom_1206; Type: QDOVA;
- Measurement SW: DASY52, Version 52.8 (8); SEMCAD X Version 14.6.10 (7373)

- **Area Scan (61x231x1):** Interpolated grid: $dx=1.500 \text{ mm}$, $dy=1.500 \text{ mm}$

Maximum value of SAR (interpolated) = 1.09 W/kg

- **Zoom Scan (5x5x7)/Cube 0:** Measurement grid: $dx=8\text{mm}$, $dy=8\text{mm}$, $dz=5\text{mm}$

Reference Value = 34.72 V/m ; Power Drift = -0.07 dB

Peak SAR (extrapolated) = 1.87 W/kg

SAR(1 g) = 0.984 W/kg ; SAR(10 g) = 0.542 W/kg

Maximum value of SAR (measured) = 1.13 W/kg

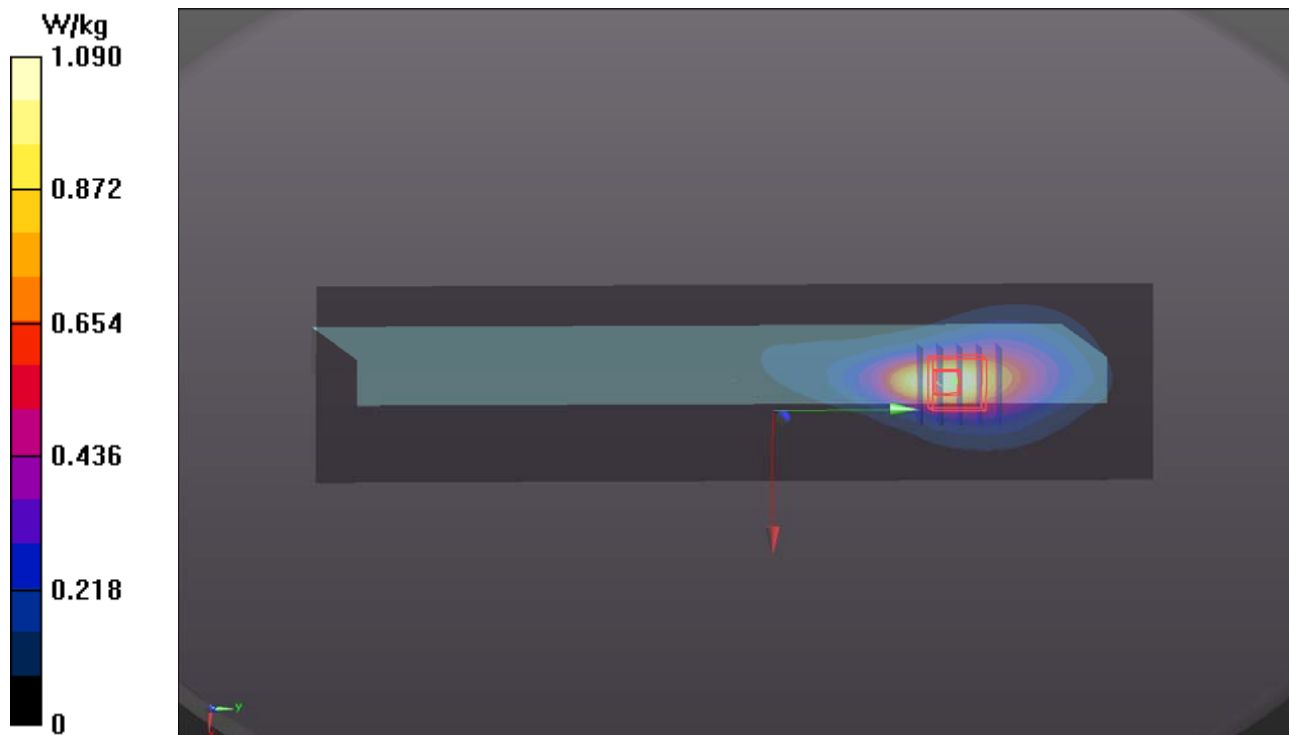

P10 LTE 25_QPSK20M_Rear Face_0cm_Ch26140_Sample1_Battery1_1RB_OS0

DUT: 160512C18

Communication System: LTE; Frequency: 1860 MHz; Duty Cycle: 1:1

Medium: B16T20N1_1202 Medium parameters used: $f = 1860$ MHz; $\sigma = 1.537$ S/m; $\epsilon_r = 51.43$; $\rho = 1000$ kg/m³

Ambient Temperature : 23.7 °C ; Liquid Temperature : 23.6 °C

DASY5 Configuration:

- Probe: ET3DV6 - SN1790; ConvF(4.74, 4.74, 4.74); Calibrated: 2016/06/24;
- Sensor-Surface: 4mm (Mechanical Surface Detection)
- Electronics: DAE4 Sn1277; Calibrated: 2016/07/22
- Phantom: ELI Phantom_1039; Type: QDOVA;
- Measurement SW: DASY52, Version 52.8 (8); SEMCAD X Version 14.6.10 (7373)

- **Area Scan (191x251x1):** Interpolated grid: dx=1.500 mm, dy=1.500 mm

Maximum value of SAR (interpolated) = 0.804 W/kg

- **Zoom Scan (5x5x7)/Cube 0:** Measurement grid: dx=8mm, dy=8mm, dz=5mm

Reference Value = 24.68 V/m; Power Drift = 0.00 dB

Peak SAR (extrapolated) = 1.11 W/kg

SAR(1 g) = 0.720 W/kg; SAR(10 g) = 0.448 W/kg

Maximum value of SAR (measured) = 0.803 W/kg

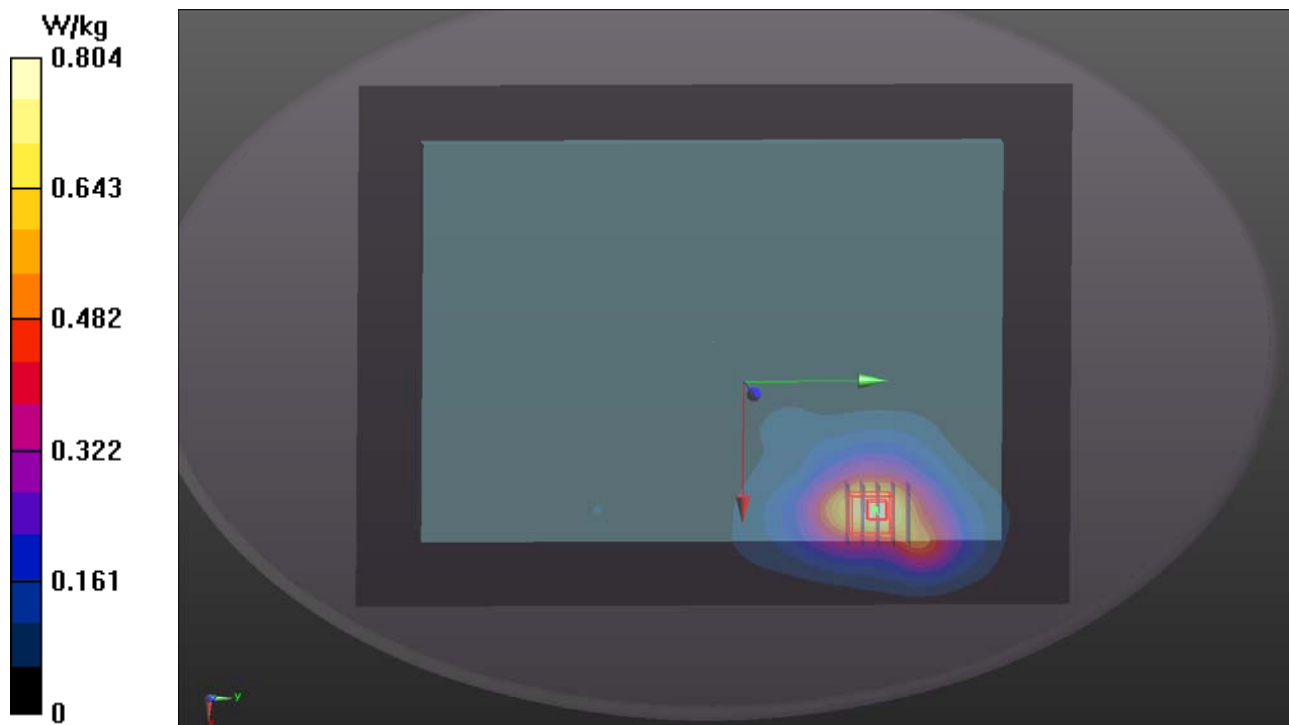

P11 LTE 26_QPSK15M_Rear Face_0cm_Ch26965_Sample1_Battery1_1RB_OS0

DUT: 160512C18

Communication System: LTE; Frequency: 841.5 MHz; Duty Cycle: 1:1

Medium: B07T10N3_1205 Medium parameters used: $f = 841.5$ MHz; $\sigma = 0.991$ S/m; $\epsilon_r = 52.97$; $\rho = 1000$ kg/m³

Ambient Temperature : 23.8 °C ; Liquid Temperature : 23.5 °C

DASY5 Configuration:

- Probe: ET3DV6 - SN1790; ConvF(6.37, 6.37, 6.37); Calibrated: 2016/06/24;
- Sensor-Surface: 4mm (Mechanical Surface Detection)
- Electronics: DAE4 Sn1277; Calibrated: 2016/07/22
- Phantom: ELI Phantom_1043; Type: QDOVA;
- Measurement SW: DASY52, Version 52.8 (8); SEMCAD X Version 14.6.10 (7373)

- **Area Scan (191x251x1):** Interpolated grid: dx=1.500 mm, dy=1.500 mm

Maximum value of SAR (interpolated) = 0.444 W/kg

- **Zoom Scan (5x5x7)/Cube 0:** Measurement grid: dx=8mm, dy=8mm, dz=5mm

Reference Value = 19.59 V/m; Power Drift = -0.01 dB

Peak SAR (extrapolated) = 0.736 W/kg

SAR(1 g) = 0.493 W/kg; SAR(10 g) = 0.308 W/kg

Maximum value of SAR (measured) = 0.515 W/kg

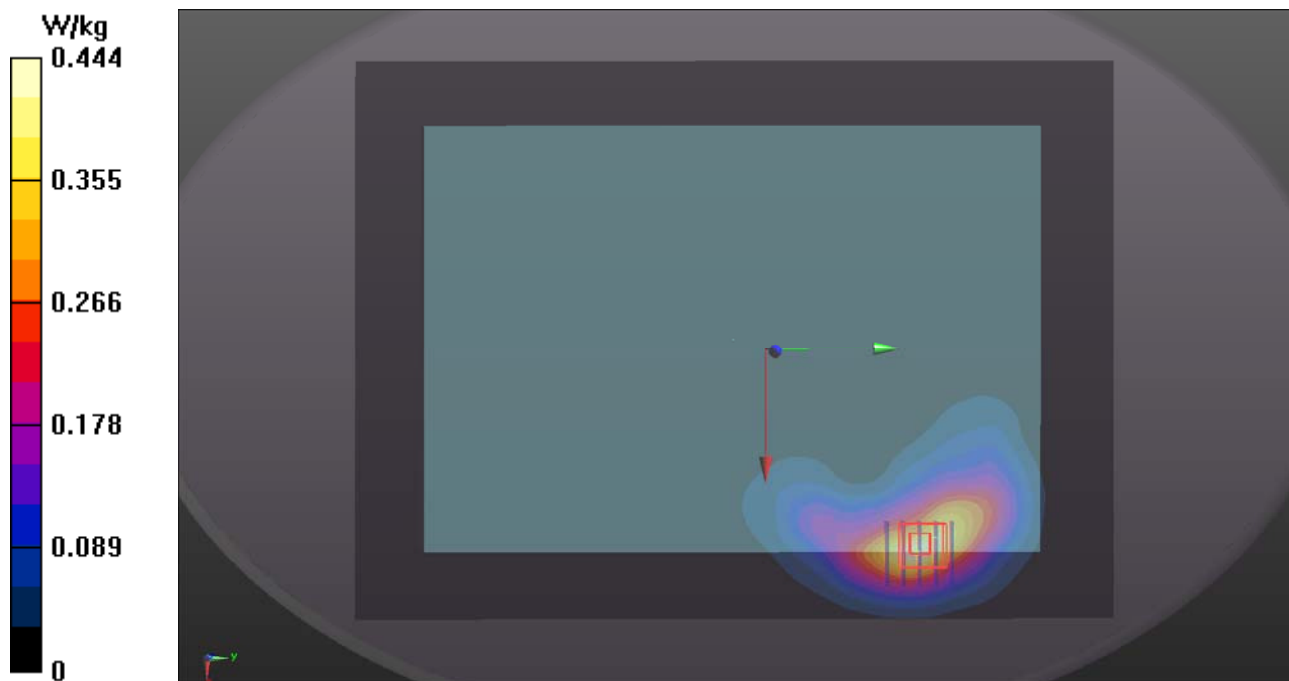

P12 LTE 41_QPSK20M_Top Side_0cm_Ch40185_Sample1_P-sensor_w_Battery1_1RB_OS0

DUT: 160512C18

Communication System: LTE TDD CF0; Frequency: 2549.5 MHz; Duty Cycle: 1:1.58

Medium: B19T27N3_1214 Medium parameters used: $f = 2550$ MHz; $\sigma = 2.104$ S/m; $\epsilon_r = 53.406$; $\rho =$

1000 kg/m³

Ambient Temperature : 23.8 °C ; Liquid Temperature : 23.5 °C

DASY5 Configuration:

- Probe: EX3DV4 - SN3971; ConvF(6.88, 6.88, 6.88); Calibrated: 2016/03/23;
- Sensor-Surface: 1.4mm (Mechanical Surface Detection)
- Electronics: DAE3 Sn579; Calibrated: 2016/09/05
- Phantom: ELI Phantom_1204; Type: QDOVA;
- Measurement SW: DASY52, Version 52.8 (8); SEMCAD X Version 14.6.10 (7373)

- **Area Scan (41x281x1):** Interpolated grid: dx=1.200 mm, dy=1.200 mm

Maximum value of SAR (interpolated) = 1.18 W/kg

- **Zoom Scan (5x5x7)/Cube 0:** Measurement grid: dx=8mm, dy=8mm, dz=5mm

Reference Value = 18.43 V/m; Power Drift = -0.06 dB

Peak SAR (extrapolated) = 1.55 W/kg

SAR(1 g) = 0.640 W/kg; SAR(10 g) = 0.278 W/kg

Maximum value of SAR (measured) = 1.21 W/kg

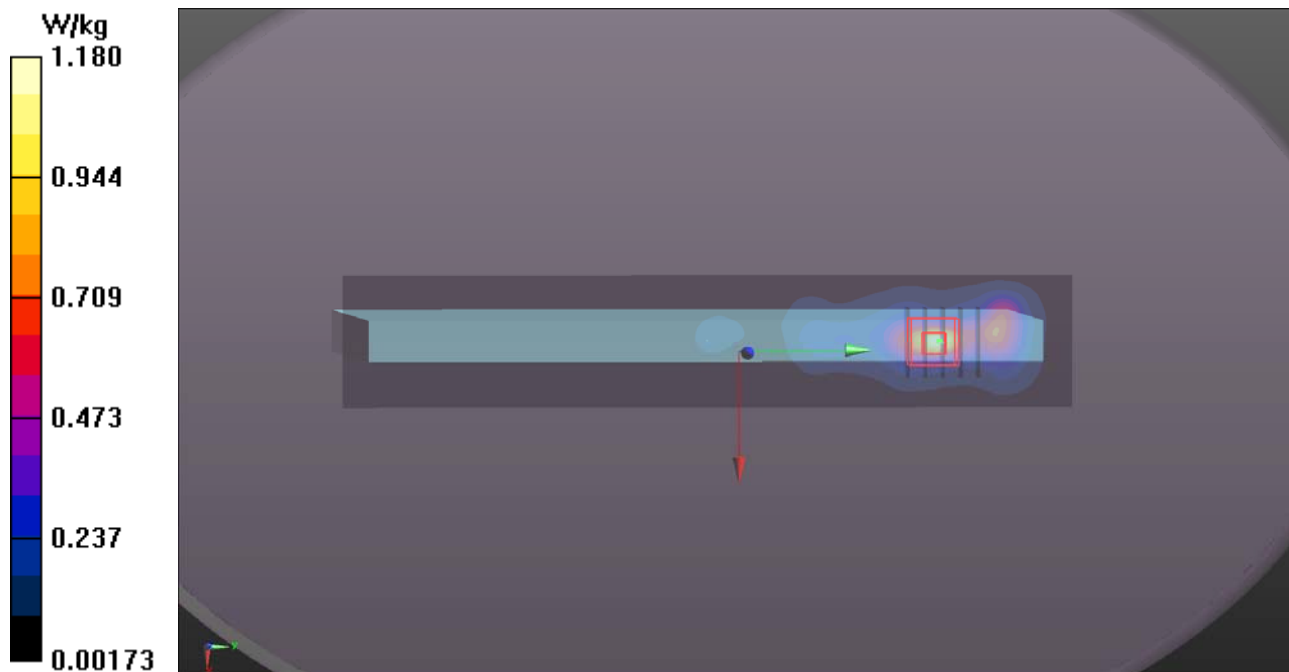

P13 2.4G WLAN_802.11b_Bottom Side_0cm_Ch6_Sample1_Ant1_Battery1

DUT: 160512C18

Communication System: WLAN_2.4G; Frequency: 2437 MHz; Duty Cycle: 1:1

Medium: B19T27N5_1212 Medium parameters used: $f = 2437$ MHz; $\sigma = 2.029$ S/m; $\epsilon_r = 53.643$; $\rho =$

1000 kg/m³

Ambient Temperature : 23.9 °C ; Liquid Temperature : 23.5 °C

DASY5 Configuration:

- Probe: EX3DV4 - SN3971; ConvF(7.24, 7.24, 7.24); Calibrated: 2016/03/23;
- Sensor-Surface: 1.4mm (Mechanical Surface Detection)
- Electronics: DAE3 Sn579; Calibrated: 2016/09/05
- Phantom: ELI Phantom_1204; Type: QDOVA;
- Measurement SW: DASY52, Version 52.8 (8); SEMCAD X Version 14.6.10 (7373)

- **Area Scan (71x291x1):** Interpolated grid: dx=1.200 mm, dy=1.200 mm

Maximum value of SAR (interpolated) = 0.329 W/kg

- **Zoom Scan (5x5x7)/Cube 0:** Measurement grid: dx=8mm, dy=8mm, dz=5mm

Reference Value = 10.30 V/m; Power Drift = -0.07 dB

Peak SAR (extrapolated) = 0.453 W/kg

SAR(1 g) = 0.178 W/kg; SAR(10 g) = 0.081 W/kg

Maximum value of SAR (measured) = 0.321 W/kg

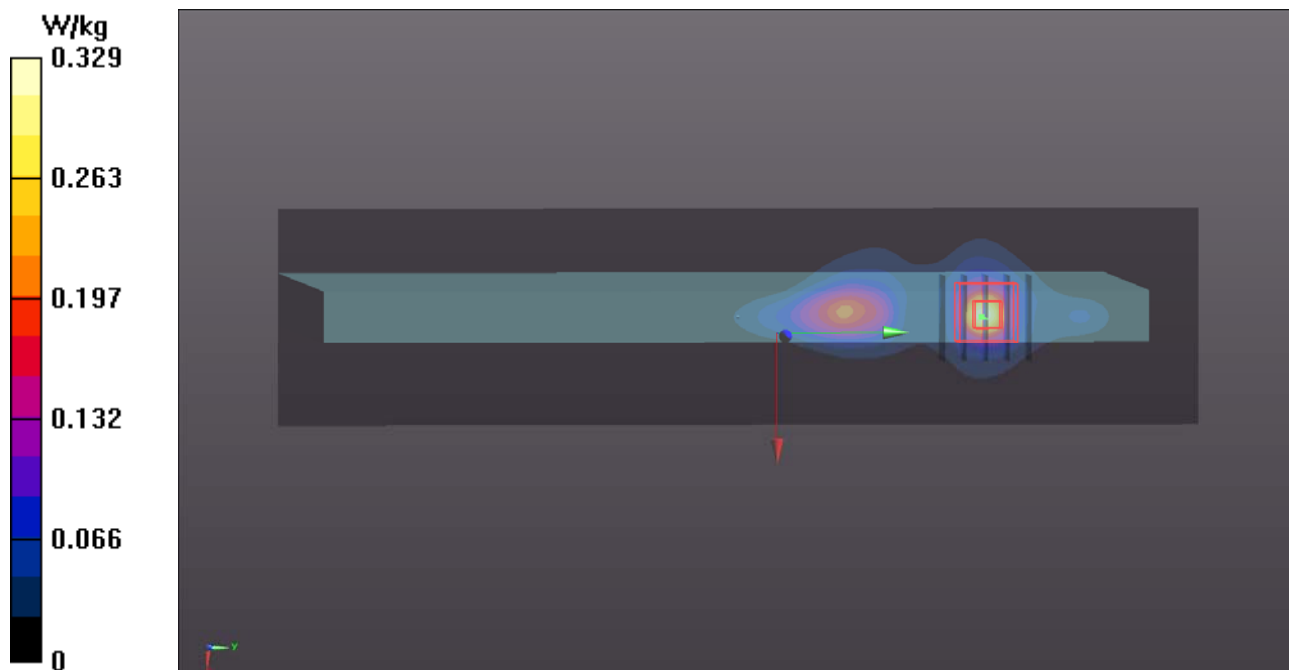

P14 5.3G WLAN_802.11 VH80_Bottom Side_0cm_Ch58_Sample1_2TX Ant1_Battery1

DUT: 160512C18

Communication System: WLAN_5G; Frequency: 5290 MHz; Duty Cycle: 1:1.29

Medium: B34T60N3_1213 Medium parameters used: $f = 5290$ MHz; $\sigma = 5.476$ S/m; $\epsilon_r = 48.459$; $\rho = 1000$ kg/m³

Ambient Temperature : 23.9 °C ; Liquid Temperature : 23.5 °C

DASY5 Configuration:

- Probe: EX3DV4 - SN3971; ConvF(4.26, 4.26, 4.26); Calibrated: 2016/03/23;
- Sensor-Surface: 1.4mm (Mechanical Surface Detection)
- Electronics: DAE3 Sn579; Calibrated: 2016/09/05
- Phantom: ELI Phantom_1204; Type: QDOVA;
- Measurement SW: DASY52, Version 52.8 (8); SEMCAD X Version 14.6.10 (7373)

- **Area Scan (81x341x1):** Interpolated grid: dx=1.000 mm, dy=1.000 mm

Maximum value of SAR (interpolated) = 1.61 W/kg

- **Zoom Scan (6x6x12)/Cube 0:** Measurement grid: dx=5mm, dy=5mm, dz=2mm

Reference Value = 11.04 V/m; Power Drift = -0.01 dB

Peak SAR (extrapolated) = 2.37 W/kg

SAR(1 g) = 0.475 W/kg; SAR(10 g) = 0.134 W/kg

Maximum value of SAR (measured) = 1.35 W/kg

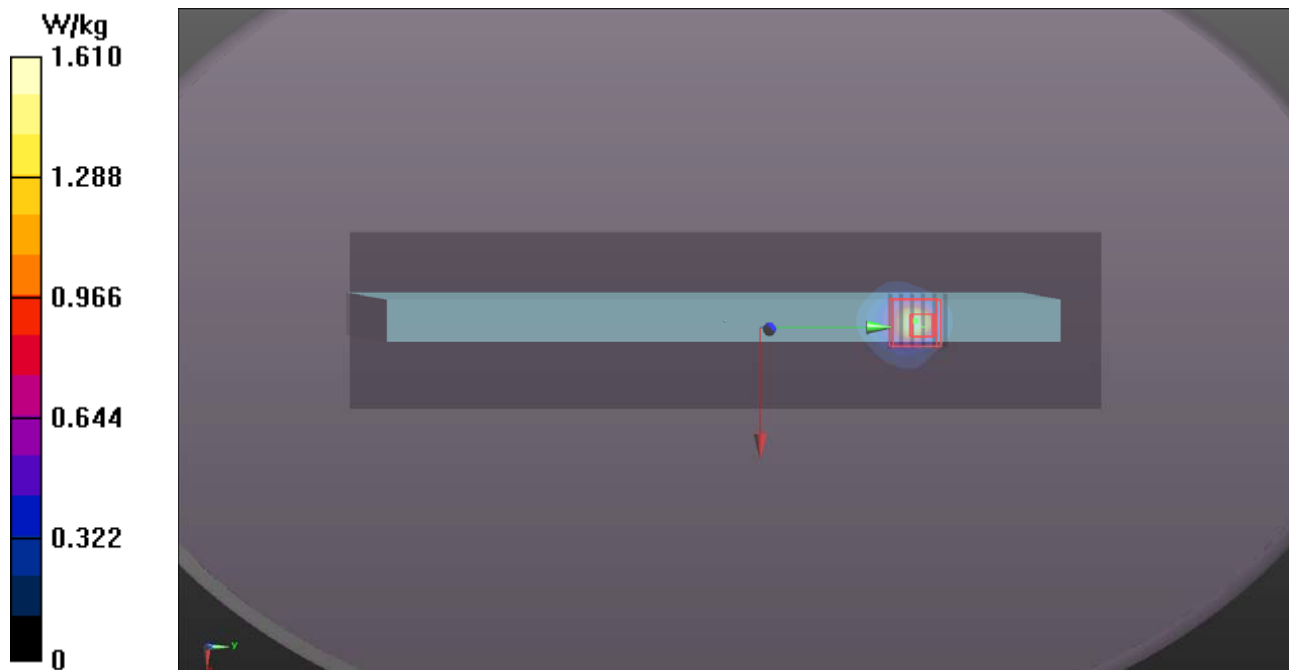

P15 5.6G WLAN_802.11 VH80_Top Side_0cm_Ch106_Sample1_Ant0_Battery1

DUT: 160512C18

Communication System: WLAN_5G; Frequency: 5530 MHz; Duty Cycle: 1:1.29

Medium: B34T60N3_1213 Medium parameters used: $f = 5530$ MHz; $\sigma = 5.844$ S/m; $\epsilon_r = 48.089$; $\rho = 1000$ kg/m³

Ambient Temperature : 23.9 °C ; Liquid Temperature : 23.5 °C

DASY5 Configuration:

- Probe: EX3DV4 - SN3971; ConvF(3.95, 3.95, 3.95); Calibrated: 2016/03/23;
- Sensor-Surface: 1.4mm (Mechanical Surface Detection)
- Electronics: DAE3 Sn579; Calibrated: 2016/09/05
- Phantom: ELI Phantom_1204; Type: QDOVA;
- Measurement SW: DASY52, Version 52.8 (8); SEMCAD X Version 14.6.10 (7373)

- **Area Scan (81x341x1):** Interpolated grid: dx=1.000 mm, dy=1.000 mm

Maximum value of SAR (interpolated) = 0.468 W/kg

- **Zoom Scan (6x6x12)/Cube 0:** Measurement grid: dx=5mm, dy=5mm, dz=2mm

Reference Value = 6.065 V/m; Power Drift = 0.05 dB

Peak SAR (extrapolated) = 1.74 W/kg

SAR(1 g) = 0.398 W/kg; SAR(10 g) = 0.107 W/kg

Maximum value of SAR (measured) = 0.952 W/kg

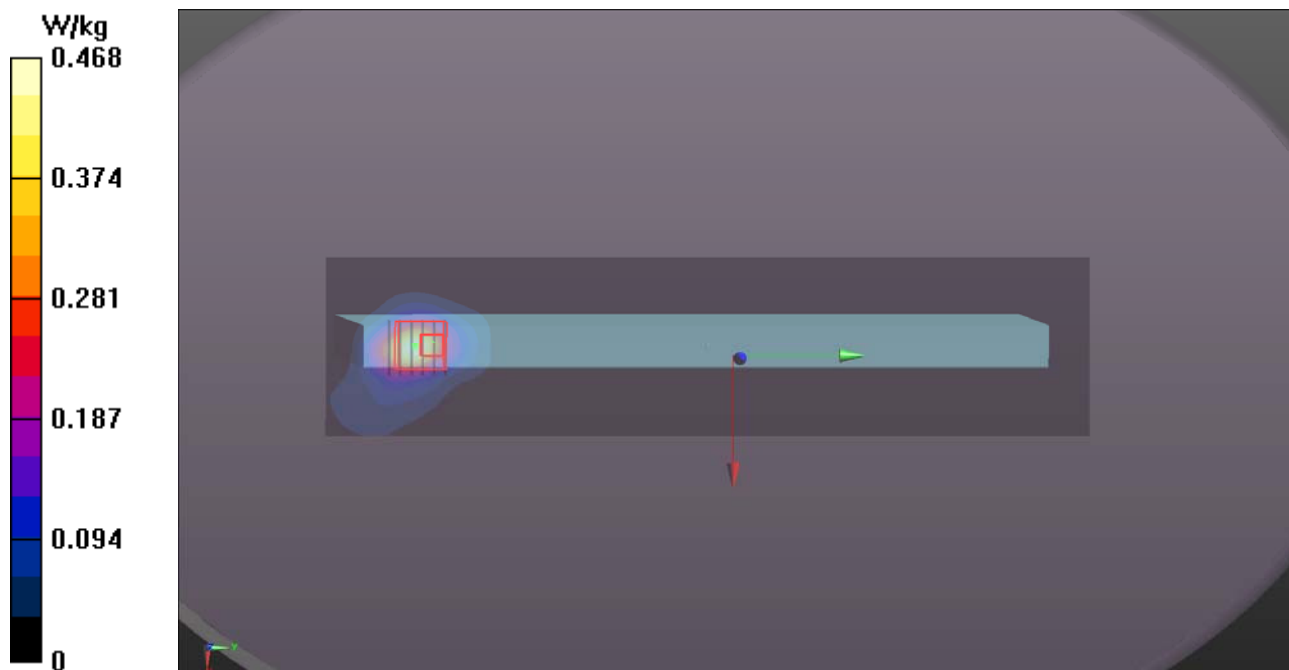

P16 5.8G WLAN_802.11n HT40_Top Side_0cm_Ch151_Sample1_Ant0_Battery1

DUT: 160512C18

Communication System: WLAN_5G; Frequency: 5755 MHz; Duty Cycle: 1:1.18

Medium: B34T60N3_1213 Medium parameters used: $f = 5755$ MHz; $\sigma = 6.178$ S/m; $\epsilon_r = 47.595$; $\rho = 1000$ kg/m³

Ambient Temperature : 23.8 °C ; Liquid Temperature : 23.5 °C

DASY5 Configuration:

- Probe: EX3DV4 - SN3971; ConvF(3.9, 3.9, 3.9); Calibrated: 2016/03/23;
- Sensor-Surface: 1.4mm (Mechanical Surface Detection)
- Electronics: DAE3 Sn579; Calibrated: 2016/09/05
- Phantom: ELI Phantom_1204; Type: QDOVA;
- Measurement SW: DASY52, Version 52.8 (8); SEMCAD X Version 14.6.10 (7373)

- **Area Scan (81x341x1):** Interpolated grid: dx=1.000 mm, dy=1.000 mm

Maximum value of SAR (interpolated) = 0.975 W/kg

- **Zoom Scan (6x6x12)/Cube 0:** Measurement grid: dx=5mm, dy=5mm, dz=2mm

Reference Value = 8.171 V/m; Power Drift = 0.10 dB

Peak SAR (extrapolated) = 2.88 W/kg

SAR(1 g) = 0.484 W/kg; SAR(10 g) = 0.129 W/kg

Maximum value of SAR (measured) = 1.29 W/kg

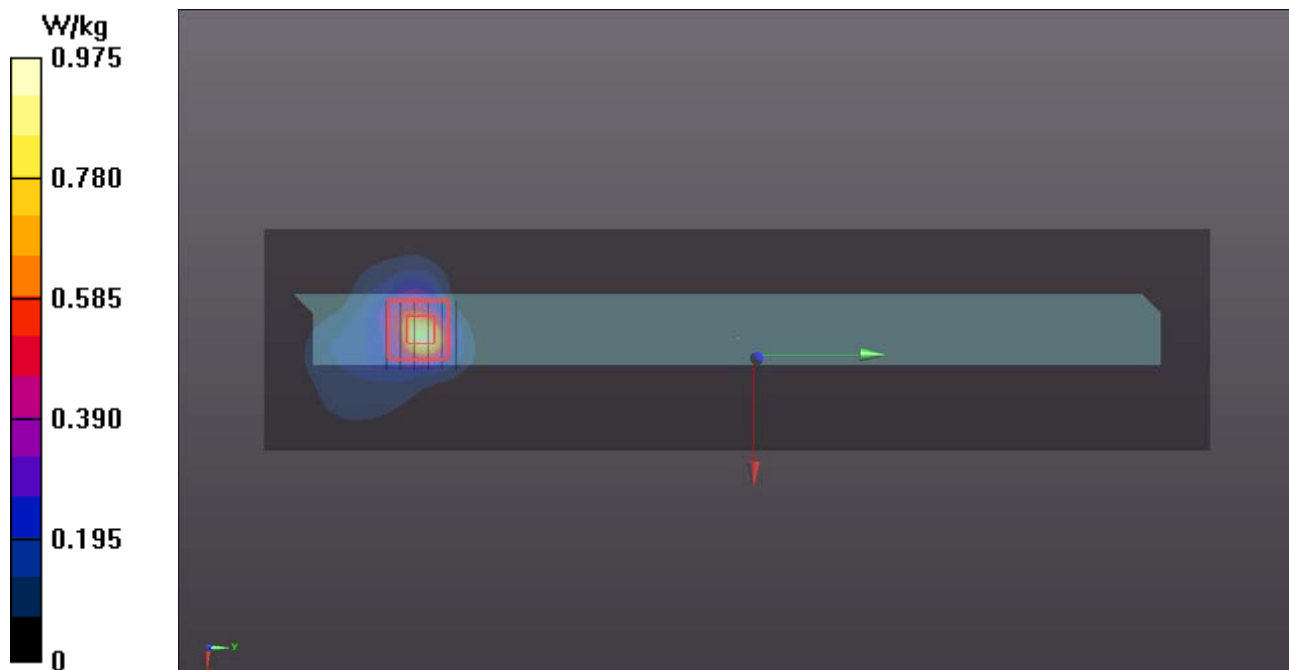

P17 2.4G WLAN_802.11b_Bottom Side_0cm_Ch6_Sample1_2TX Ant1_Battery1

DUT: 160512C18

Communication System: WLAN_2.4G; Frequency: 2437 MHz; Duty Cycle: 1:1

Medium: B19T27N5_1212 Medium parameters used: $f = 2437$ MHz; $\sigma = 2.029$ S/m; $\epsilon_r = 53.643$; $\rho = 1000$ kg/m³

Ambient Temperature : 23.9 °C ; Liquid Temperature : 23.5 °C

DASY5 Configuration:

- Probe: EX3DV4 - SN3971; ConvF(7.24, 7.24, 7.24); Calibrated: 2016/03/23;
- Sensor-Surface: 1.4mm (Mechanical Surface Detection)
- Electronics: DAE3 Sn579; Calibrated: 2016/09/05
- Phantom: ELI Phantom_1204; Type: QDOVA;
- Measurement SW: DASY52, Version 52.8 (8); SEMCAD X Version 14.6.10 (7373)

- **Area Scan (211x301x1):** Interpolated grid: dx=1.200 mm, dy=1.200 mm

Maximum value of SAR (interpolated) = 0.0394 W/kg

- **Zoom Scan (5x5x7)/Cube 0:** Measurement grid: dx=8mm, dy=8mm, dz=5mm

Reference Value = 2.623 V/m; Power Drift = -0.09 dB

Peak SAR (extrapolated) = 0.0420 W/kg

SAR(1 g) = 0.022 W/kg; SAR(10 g) = 0.011 W/kg

Maximum value of SAR (measured) = 0.0315 W/kg

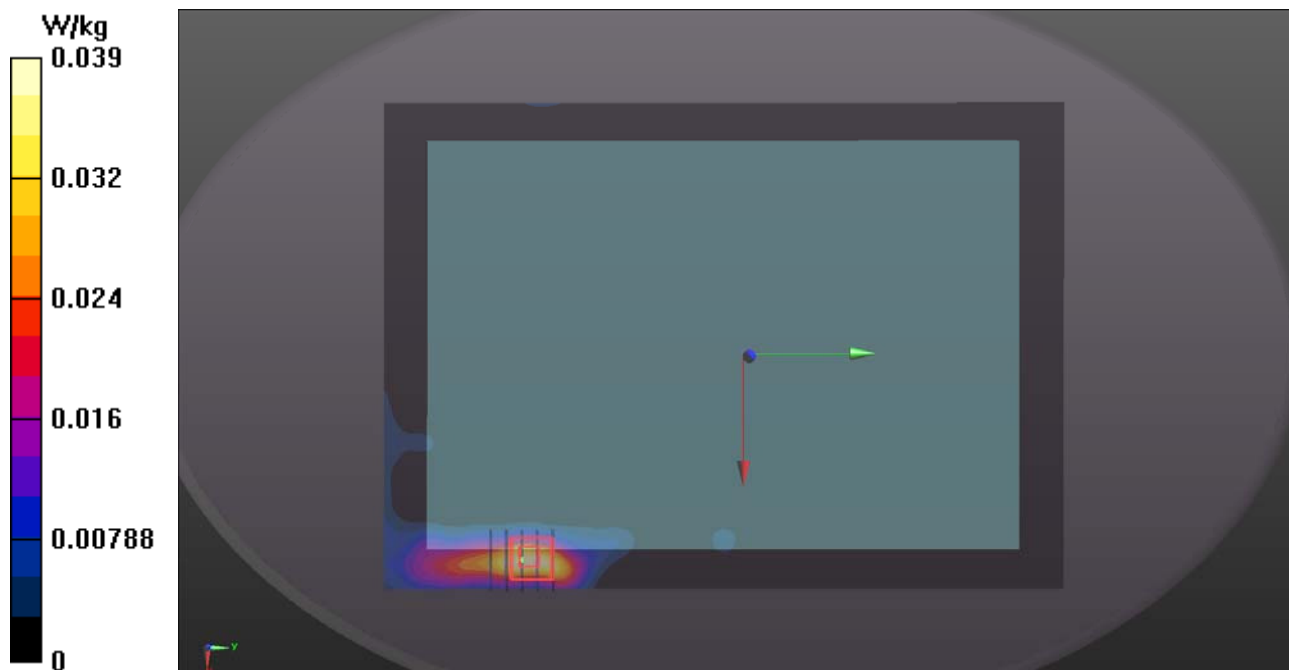

P33 5.3G WLAN_802.11 VH80_Top Side_2.5cm_Ch58_Sample1_Ant0_Battery1

DUT: 160512C18

Communication System: WLAN_5G; Frequency: 5290 MHz; Duty Cycle: 1:1.29

Medium: B34T60N3_1213 Medium parameters used: $f = 5290$ MHz; $\sigma = 5.476$ S/m; $\epsilon_r = 48.459$; $\rho = 1000$ kg/m³

Ambient Temperature : 23.9 °C ; Liquid Temperature : 23.5 °C

DASY5 Configuration:

- Probe: EX3DV4 - SN3971; ConvF(4.26, 4.26, 4.26); Calibrated: 2016/03/23;
- Sensor-Surface: 1.4mm (Mechanical Surface Detection)
- Electronics: DAE3 Sn579; Calibrated: 2016/09/05
- Phantom: ELI Phantom_1204; Type: QDOVA;
- Measurement SW: DASY52, Version 52.8 (8); SEMCAD X Version 14.6.10 (7373)

- **Area Scan (81x341x1):** Interpolated grid: dx=1.000 mm, dy=1.000 mm

Maximum value of SAR (interpolated) = 0.0643 W/kg

- **Zoom Scan (6x6x12)/Cube 0:** Measurement grid: dx=5mm, dy=5mm, dz=2mm

Reference Value = 2.602 V/m; Power Drift = -0.08 dB

Peak SAR (extrapolated) = 0.102 W/kg

SAR(1 g) = 0.032 W/kg; SAR(10 g) = 0.015 W/kg

Maximum value of SAR (measured) = 0.0650 W/kg

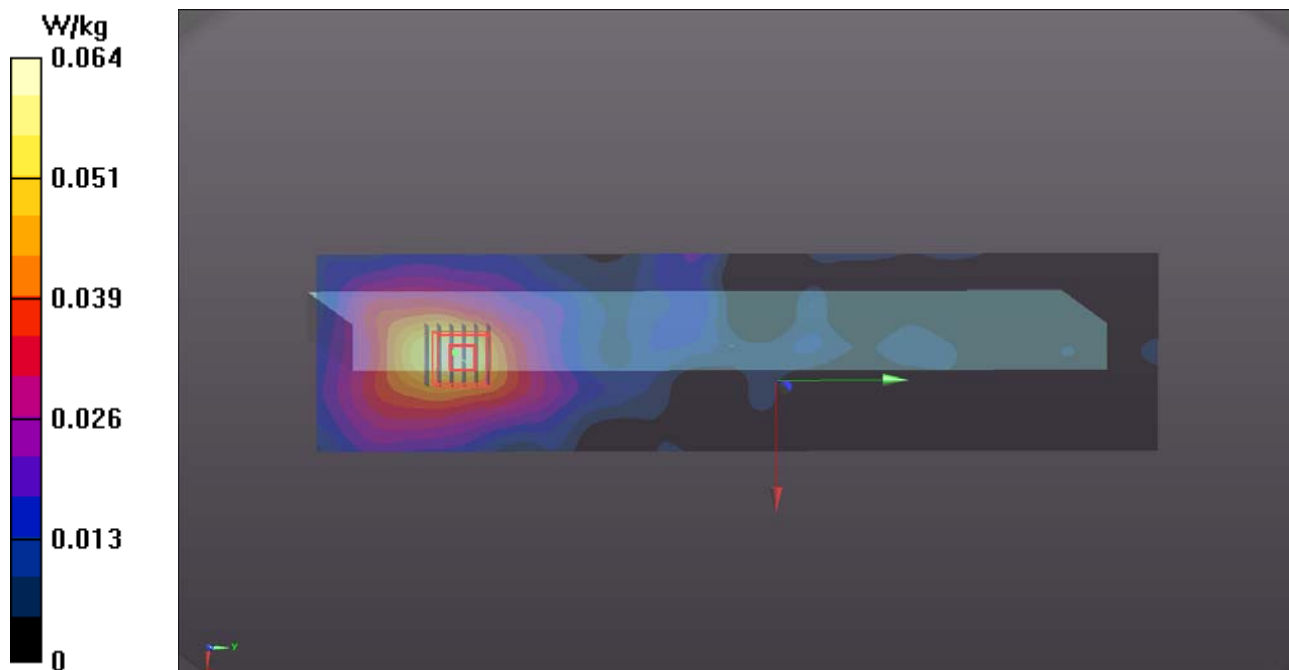

P18 5.6G WLAN_802.11ac VH80_Bottom Side_0cm_Ch106_Sample1_Ant1_Battery1

DUT: 160512C18

Communication System: WLAN_5G; Frequency: 5530 MHz; Duty Cycle: 1:1.29

Medium: B34T60N3_1222 Medium parameters used: $f = 5530$ MHz; $\sigma = 5.806$ S/m; $\epsilon_r = 46.932$; $\rho = 1000$ kg/m³

Ambient Temperature : 23.8 °C ; Liquid Temperature : 23.5 °C

DASY5 Configuration:

- Probe: EX3DV4 - SN3650; ConvF(4.01, 4.01, 4.01); Calibrated: 2016/07/25;
- Sensor-Surface: 1.4mm (Mechanical Surface Detection)
- Electronics: DAE4 Sn861; Calibrated: 2016/06/16
- Phantom: ELI Phantom_1204; Type: QDOVA;
- Measurement SW: DASY52, Version 52.8 (8); SEMCAD X Version 14.6.10 (7373)

- **Area Scan (251x351x1):** Interpolated grid: dx=1.000 mm, dy=1.000 mm

Maximum value of SAR (interpolated) = 0.108 W/kg

- **Zoom Scan (6x6x12)/Cube 0:** Measurement grid: dx=5mm, dy=5mm, dz=2mm

Reference Value = 3.161 V/m; Power Drift = 0.02 dB

Peak SAR (extrapolated) = 0.186 W/kg

SAR(1 g) = 0.031 W/kg; SAR(10 g) = 0.0085 W/kg

Maximum value of SAR (measured) = 0.145 W/kg

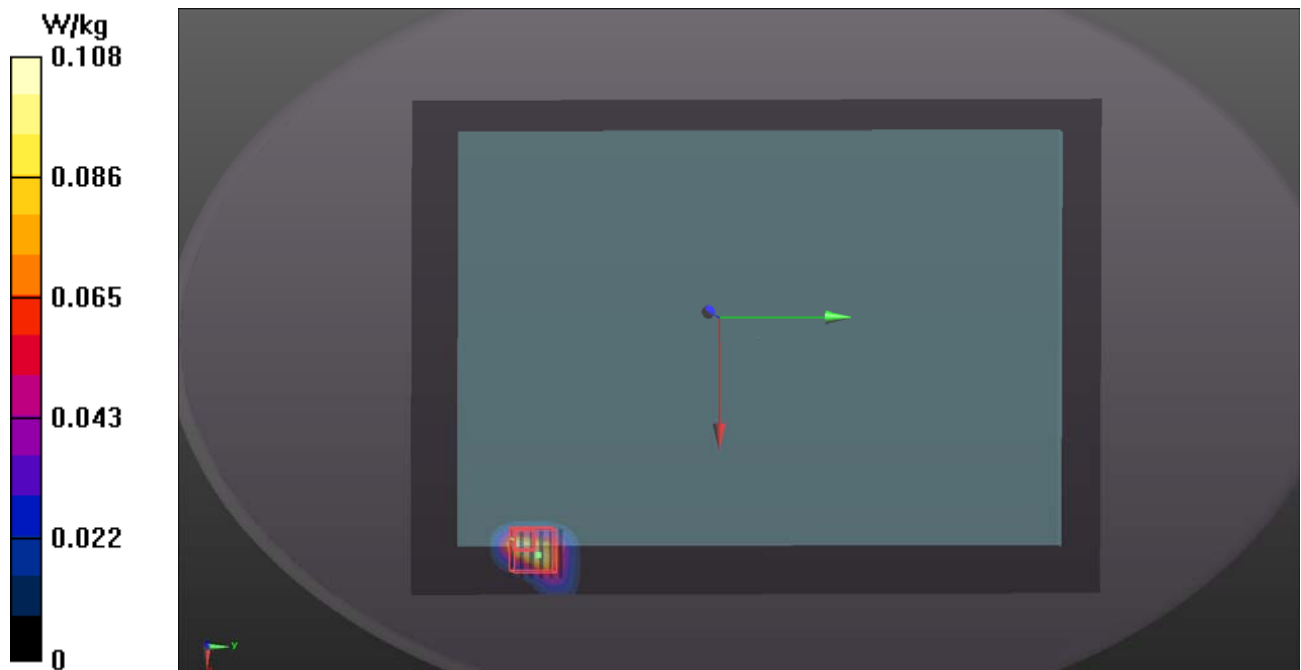

P19 5.8G WLAN_802.11n HT40_Bottom Side_0cm_Ch159_Sample1_Ant1_Battery1

DUT: 160512C18

Communication System: WLAN_5G; Frequency: 5795 MHz; Duty Cycle: 1:1.18

Medium: B34T60N3_1222 Medium parameters used: $f = 5795$ MHz; $\sigma = 6.166$ S/m; $\epsilon_r = 46.436$; $\rho = 1000$ kg/m³

Ambient Temperature : 23.8 °C ; Liquid Temperature : 23.5 °C

DASY5 Configuration:

- Probe: EX3DV4 - SN3650; ConvF(4.36, 4.36, 4.36); Calibrated: 2016/07/25;
- Sensor-Surface: 1.4mm (Mechanical Surface Detection)
- Electronics: DAE4 Sn861; Calibrated: 2016/06/16
- Phantom: ELI Phantom_1204; Type: QDOVA;
- Measurement SW: DASY52, Version 52.8 (8); SEMCAD X Version 14.6.10 (7373)

- **Area Scan (251x351x1):** Interpolated grid: dx=1.000 mm, dy=1.000 mm

Maximum value of SAR (interpolated) = 0.0755 W/kg

- **Zoom Scan (6x6x12)/Cube 0:** Measurement grid: dx=5mm, dy=5mm, dz=2mm

Reference Value = 2.130 V/m; Power Drift = 0.18 dB

Peak SAR (extrapolated) = 0.166 W/kg

SAR(1 g) = 0.033 W/kg; SAR(10 g) = 0.00653 W/kg

Maximum value of SAR (measured) = 0.0959 W/kg

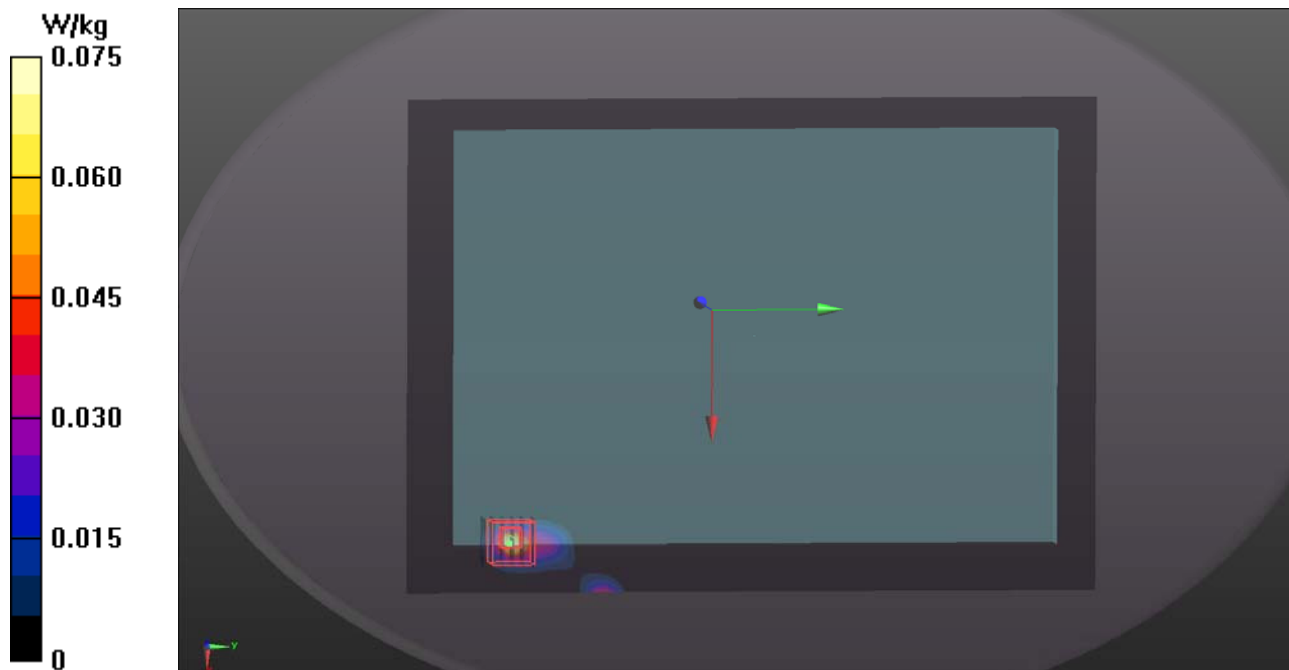



Appendix C. Calibration Certificate for Probe and Dipole

The SPEAG calibration certificates are shown as follows.



Appendix D. Photographs of EUT and Setup