



FCC SAR Test Report

Report No. : SA160129C01
 Applicant : Sierra Wireless Inc.
 Address : 13811 Wireless Way, Richmond, BC, Canada
 Product : Radio Module
 FCC ID : N7NEM7355-D5
 Brand : Sierra Wireless
 Model No. : EM7355
 Standards : FCC 47 CFR Part 2 (2.1093) / IEEE C95.1:1992 / IEEE Std 1528:2013
 KDB 865664 D01 v01r04 / KDB 865664 D02 v01r02
 KDB 447498 D01 v06 / KDB 616217 D04 v01r02
 KDB 941225 D01 v03r01 / KDB 941225 D05 v02r05
 Sample Received Date : Jan. 29, 2016
 Date of Testing : Mar. 08, 2016 ~ Apr. 07, 2016

CERTIFICATION: The above equipment have been tested by **Bureau Veritas Consumer Products Services (H.K.) Ltd., Taoyuan Branch – Lin Kou Laboratories**, and found compliance with the requirement of the above standards. The test record, data evaluation & Equipment Under Test (EUT) configurations represented herein are true and accurate accounts of the measurements of the sample’s SAR characteristics under the conditions specified in this report. It should not be reproduced except in full, without the written approval of our laboratory. The client should not use it to claim product certification, approval, or endorsement by TAF or any government agencies.

Prepared By : Rona Chen
 Rona Chen / Specialist

Approved By : Eli Hsu
 Eli Hsu / Supervisor



This report is for your exclusive use. Any copying or replication of this report to or for any other person or entity, or use of our name or trademark, is permitted only with our prior written permission. This report sets forth our findings solely with respect to the test samples identified herein. The results set forth in this report are not indicative or representative of the quality or characteristics of the lot from which a test sample was taken or any similar or identical product unless specifically and expressly noted. Our report includes all of the tests requested by you and the results thereof based upon the information that you provided to us. You have 60 days from date of issuance of this report to notify us of any material error or omission caused by our negligence, provided, however, that such notice shall be in writing and shall specifically address the issue you wish to raise. A failure to raise such issue within the prescribed time shall constitute your unqualified acceptance of the completeness of this report, the tests conducted and the correctness of the report contents. Unless specific mention, the uncertainty of measurement has been explicitly taken into account to declare the compliance or non-compliance to the specification.



Table of Contents

Release Control Record 3

1. Summary of Maximum SAR Value 4

2. Description of Equipment Under Test 5

3. SAR Measurement System 8

3.1 Definition of Specific Absorption Rate (SAR) 8

3.2 SPEAG DASY System 8

3.2.1 Robot 9

3.2.2 Probes 10

3.2.3 Data Acquisition Electronics (DAE) 10

3.2.4 Phantoms 11

3.2.5 Device Holder 12

3.2.6 System Validation Dipoles 12

3.2.7 Tissue Simulating Liquids 13

3.3 SAR System Verification 16

3.4 SAR Measurement Procedure 17

3.4.1 Area & Zoom Scan Procedure 17

3.4.2 Volume Scan Procedure 17

3.4.3 Power Drift Monitoring 18

3.4.4 Spatial Peak SAR Evaluation 18

3.4.5 SAR Averaged Methods 18

4. SAR Measurement Evaluation 19

4.1 EUT Configuration and Setting 19

4.2 EUT Testing Position 27

4.2.1 Body Exposure Conditions 27

4.2.2 SAR Test Exclusion Evaluations 28

4.2.3 Simultaneous Transmission Possibilities 29

4.3 Tissue Verification 30

4.4 System Validation 30

4.5 System Verification 31

4.6 Maximum Output Power 32

4.6.1 Maximum Conducted Power 32

4.6.2 Measured Conducted Power Result 34

4.7 SAR Testing Results 49

4.7.1 SAR Test Reduction Considerations 49

4.7.2 SAR Results for Body Exposure Condition 50

<Tablet PC> 50

<Laptop PC> 53

4.7.3 SAR Measurement Variability 54

4.7.4 Simultaneous Multi-band Transmission Evaluation 55

5. Calibration of Test Equipment 68

6. Measurement Uncertainty 69

7. Information on the Testing Laboratories 71

- Appendix A. SAR Plots of System Verification**
- Appendix B. SAR Plots of SAR Measurement**
- Appendix C. Calibration Certificate for Probe and Dipole**
- Appendix D. Photographs of EUT and Setup**



Release Control Record

Report No.	Reason for Change	Date Issued
SA160129C01	Initial release	Apr. 18, 2016

FCC SAR Test Report

1. Summary of Maximum SAR Value

Equipment Class	Mode	Tablet PC Highest Reported Body SAR _{1g} (W/kg)	Laptop PC Highest Reported Body SAR _{1g} (W/kg)
PCB	GSM850	1.08	0.59
	GSM1900	1.24	0.68
	WCDMA II	1.08	0.53
	WCDMA IV	0.99	0.37
	WCDMA V	0.89	0.55
	CDMA BC0	1.01	0.60
	CDMA BC1	1.09	0.44
	CDMA BC10	0.97	0.52
	LTE 2	1.08	0.60
	LTE 4	1.12	0.53
	LTE 5	1.11	0.72
	LTE 13	1.16	0.44
	LTE 17	1.20	0.47
LTE 25	1.03	0.51	
DXX	NFC	N/A	N/A
Highest Simultaneous Transmission SAR		Body (W/kg)	Body (W/kg)
PCB + DTS + DSS		1.24	0.90
PCB + NII + DSS		1.25	0.90

Note:

- The SAR limit (**Head & Body: SAR_{1g} 1.6 W/kg, Extremity: SAR_{10g} 4.0 W/kg**) for general population / uncontrolled exposure is specified in FCC 47 CFR part 2 (2.1093) and ANSI/IEEE C95.1-1992.

FCC SAR Test Report

2. Description of Equipment Under Test

EUT Type	Radio Module
FCC ID	N7NEM7355-D5
Brand Name	Sierra Wireless
Model Name	EM7355
Tx Frequency Bands (Unit: MHz)	GSM850 : 824.2 ~ 848.8 GSM1900 : 1850.2 ~ 1909.8 WCDMA Band II : 1852.4 ~ 1907.6 WCDMA Band IV : 1712.4 ~ 1752.6 WCDMA Band V : 826.4 ~ 846.6 CDMA BC0 : 824.7 ~ 848.31 CDMA BC1 : 1851.25 ~ 1908.75 CDMA BC10 : 817.9 ~ 823.1 LTE Band 2 : 1850.7 ~ 1909.3 (1.4M), 1851.5 ~ 1908.5 (3M), 1852.5 ~ 1907.5 (5M), 1855 ~ 1905 (10M), 1857.5 ~ 1902.5 (15M), 1860 ~ 1900 (20M) LTE Band 4 : 1710.7 ~ 1754.3 (1.4M), 1711.5 ~ 1753.5 (3M), 1712.5 ~ 1752.5 (5M), 1715 ~ 1750 (10M), 1717.5 ~ 1747.5 (15M), 1720 ~ 1745 (20M) LTE Band 5 : 824.7 ~ 848.3 (1.4M), 825.5 ~ 847.5 (3M), 826.5 ~ 846.5 (5M), 829 ~ 844 (10M) LTE Band 13 : 779.5 ~ 784.5 (5M), 782 (10M) LTE Band 17 : 706.5 ~ 713.5 (5M), 709 ~ 711 (10M) LTE Band 25 : 1850.7 ~ 1914.3 (1.4M), 1851.5 ~ 1913.5 (3M), 1852.5 ~ 1912.5 (5M), 1855 ~ 1910 (10M), 1857.5 ~ 1907.5 (15M), 1860 ~ 1905 (20M) NFC : 13.56
Uplink Modulations	GSM & GPRS : GMSK EDGE : 8PSK WCDMA : QPSK CDMA : QPSK LTE : QPSK, 16QAM NFC : ASK
Maximum Tune-up Conducted Power (Unit: dBm)	Please refer to section 4.6.1.
Antenna Type	Fixed Internal Antenna
EUT Stage	Engineering Sample

Note:

- The EUT is authorized for use in specific End-product. Please refer to below table for more details.

Item	Brand Name	Model Name
Notebook Computer	DELL	Regulatory model name (RMN) : P18T / Regulatory type name (RTN) : P18T002

- The above EUT information is declared by manufacturer and for more detailed features description please refers to the manufacturer's specifications or User's Manual.

List of Accessory of End-product:

BT/WLAN Module	Brand Name	INTEL
	Model Name	8260NGW
	FCC ID	PD98260NGU
NFC Module	Brand Name	DELL
	Model Name	DWRFID1601
Battery	Brand Name	DELL
	Model Name	NJTCH
	Power Rating	7.4Vdc, 7600mAh, 56Wh
	Type	Li-ion



FCC SAR Test Report

Item	Description						
Frequency range, Channel Bandwidth, Numbers and Frequencies	Band 2	Frequency range: 1850 - 1910 MHz					
		Channel Bandwidth					
		20 MHz	15 MHz	10 MHz	5 MHz	3 MHz	1.4 MHz
	Low	18700/ 1860	18675/ 1857.5	18650/ 1855	18625/ 1852.5	18615/ 1851.5	18607/ 1850.7
	Mid	18900/ 1880	18900/ 1880	18900/ 1880	18900/ 1880	18900/ 1880	18900/ 1880
	High	19100/ 1900	19125/ 1902.5	19150/ 1905	19175/ 1907.5	19185/ 1908.5	19193/ 1909.3
	Band 4	Frequency range: 1710 - 1755 MHz					
		Channel Bandwidth					
		20 MHz	15 MHz	10 MHz	5 MHz	3 MHz	1.4 MHz
	Low	20050/ 1720	20025/ 1717.5	20000/ 1715	19975/ 1712.5	19965/ 1711.5	19957/ 1710.7
	Mid	20175/ 1732.5	20175/ 1732.5	20175/ 1732.5	20175/ 1732.5	20175/ 1732.5	20175/ 1732.5
	High	20300/ 1745	20325/ 1747.5	20350/ 1750	20375/ 1752.5	20385/ 1753.5	20393/ 1754.3
	Band 5	Frequency range: 824 - 849 MHz					
		Channel Bandwidth					
		20 MHz	15 MHz	10 MHz	5 MHz	3 MHz	1.4 MHz
	Low			20450/ 829	20425/ 826.5	20415/ 825.5	20407/ 824.7
	Mid			20525/ 836.5	20525/ 836.5	20525/ 836.5	20525/ 836.5
	High			20600/ 844	20625/ 846.5	20635/ 847.5	20643/ 848.3
	Band 13	Frequency range: 777 - 787 MHz					
		Channel Bandwidth					
		20 MHz	15 MHz	10 MHz	5 MHz	3 MHz	1.4 MHz
Low				23205/ 779.5			
Mid			23230/ 782	23230/ 782			
High				23255/ 784.5			
Frequency range, Channel Bandwidth, Numbers and Frequencies	Band 17	Frequency range: 704 - 716 MHz					
		Channel Bandwidth					
		20 MHz	15 MHz	10 MHz	5 MHz	3 MHz	1.4 MHz
	Low			23780/ 709	23755/ 706.5		
	Mid			23790/ 710	23790/ 710		
	High			23800/ 711	23825/ 713.5		
	Band 25	Frequency range: 1850 - 1915 MHz					
		Channel Bandwidth					
		20 MHz	15 MHz	10 MHz	5 MHz	3 MHz	1.4 MHz
	Low	26140/ 1860	26115/ 1857.5	26090/ 1855	26065/ 1852.5	26055/ 1851.5	26047/ 1850.7
	Mid	26365/ 1882.5	26365/ 1882.5	26365/ 1882.5	26365/ 1882.5	26365/ 1882.5	26365/ 1882.5
High	26590/ 1905	26615/ 1907.5	26640/ 1910	26665/ 1912.5	26675/ 1913.5	26683/ 1914.3	

FCC SAR Test Report

Item	Description																																						
LTE transmitter and antenna implementation	Refer to Appendix D.																																						
Maximum power reduction (MPR)	<p align="center">Table 6.2.3-1: Maximum Power Reduction (MPR) for Power Class 3</p> <table border="1"> <thead> <tr> <th rowspan="2">Modulation</th> <th colspan="6">Channel bandwidth / Transmission bandwidth (RB)</th> <th rowspan="2">MPR (dB)</th> </tr> <tr> <th>1.4 MHz</th> <th>3.0 MHz</th> <th>5 MHz</th> <th>10 MHz</th> <th>15 MHz</th> <th>20 MHz</th> </tr> </thead> <tbody> <tr> <td>QPSK</td> <td>> 5</td> <td>> 4</td> <td>> 8</td> <td>> 12</td> <td>> 16</td> <td>> 18</td> <td>≤ 1</td> </tr> <tr> <td>16 QAM</td> <td>≤ 5</td> <td>≤ 4</td> <td>≤ 8</td> <td>≤ 12</td> <td>≤ 16</td> <td>≤ 18</td> <td>≤ 1</td> </tr> <tr> <td>16 QAM</td> <td>> 5</td> <td>> 4</td> <td>> 8</td> <td>> 12</td> <td>> 16</td> <td>> 18</td> <td>≤ 2</td> </tr> </tbody> </table> <p>MPR Built-in by design A-MPR (additional MPR) was disabled during SAR testing</p>	Modulation	Channel bandwidth / Transmission bandwidth (RB)						MPR (dB)	1.4 MHz	3.0 MHz	5 MHz	10 MHz	15 MHz	20 MHz	QPSK	> 5	> 4	> 8	> 12	> 16	> 18	≤ 1	16 QAM	≤ 5	≤ 4	≤ 8	≤ 12	≤ 16	≤ 18	≤ 1	16 QAM	> 5	> 4	> 8	> 12	> 16	> 18	≤ 2
Modulation	Channel bandwidth / Transmission bandwidth (RB)						MPR (dB)																																
	1.4 MHz	3.0 MHz	5 MHz	10 MHz	15 MHz	20 MHz																																	
QPSK	> 5	> 4	> 8	> 12	> 16	> 18	≤ 1																																
16 QAM	≤ 5	≤ 4	≤ 8	≤ 12	≤ 16	≤ 18	≤ 1																																
16 QAM	> 5	> 4	> 8	> 12	> 16	> 18	≤ 2																																
Power reduction	Refer to section 4.6																																						
Spectrum plots for RB configurations	A properly configured base station simulator was used for the SAR and power measurements; therefore, spectrum plots for each RB allocation and offset configuration are not included in the SAR report.																																						

3. SAR Measurement System

3.1 Definition of Specific Absorption Rate (SAR)

SAR is related to the rate at which energy is absorbed per unit mass in an object exposed to a radio field. The SAR distribution in a biological body is complicated and is usually carried out by experimental techniques or numerical modeling. The standard recommends limits for two tiers of groups, occupational/controlled and general population/uncontrolled, based on a person's awareness and ability to exercise control over his or her exposure. In general, occupational/controlled exposure limits are higher than the limits for general population/uncontrolled.

The SAR definition is the time derivative (rate) of the incremental energy (dW) absorbed by (dissipated in) an incremental mass (dm) contained in a volume element (dv) of a given density (ρ). The equation description is as below:

$$\text{SAR} = \frac{d}{dt} \left(\frac{dW}{dm} \right) = \frac{d}{dt} \left(\frac{dW}{\rho dv} \right)$$

SAR is expressed in units of Watts per kilogram (W/kg)

SAR measurement can be related to the electrical field in the tissue by

$$\text{SAR} = \frac{\sigma |E|^2}{\rho}$$

Where: σ is the conductivity of the tissue, ρ is the mass density of the tissue and E is the RMS electrical field strength.

3.2 SPEAG DASY System

DASY system consists of high precision robot, probe alignment sensor, phantom, robot controller, controlled measurement server and near-field probe. The robot includes six axes that can move to the precision position of the DASY4/5 software defined. The DASY software can define the area that is detected by the probe. The robot is connected to controlled box. Controlled measurement server is connected to the controlled robot box. The DAE includes amplifier, signal multiplexing, AD converter, offset measurement and surface detection. It is connected to the Electro-optical coupler (ECO). The ECO performs the conversion from the optical into digital electric signal of the DAE and transfers data to the PC.

FCC SAR Test Report

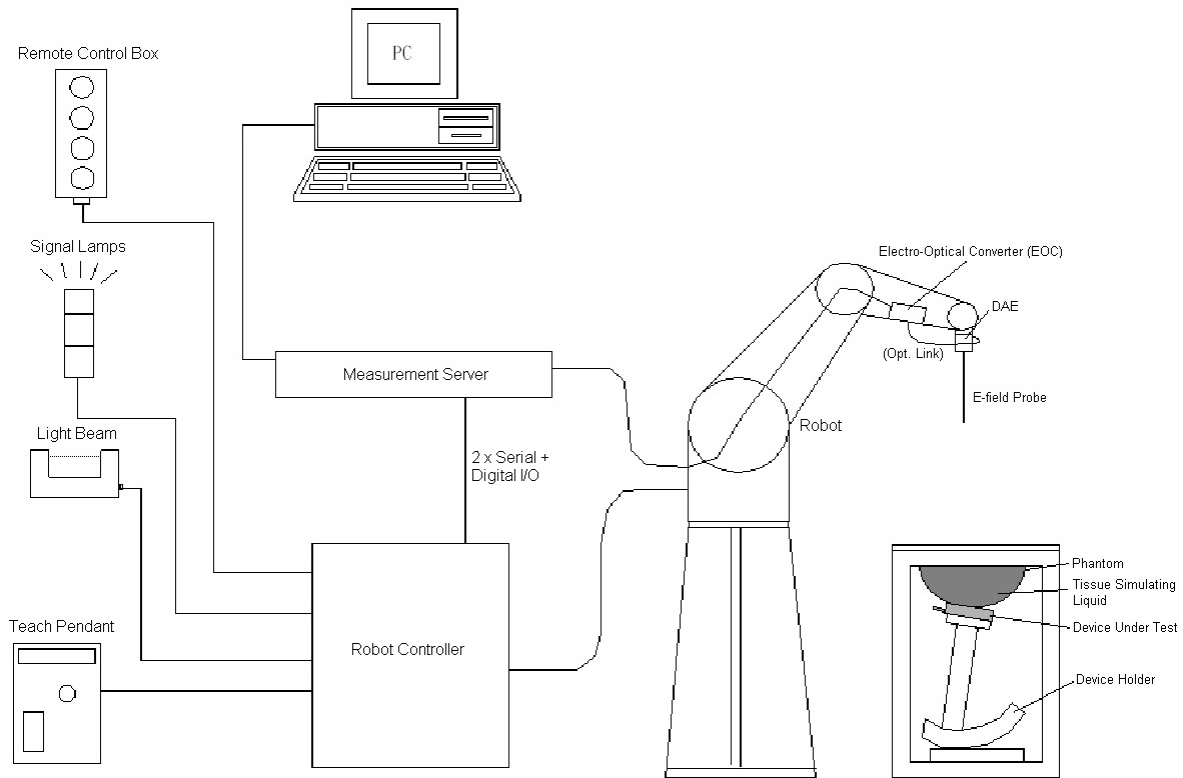

Fig-3.1 SPEAG DASY52 System Setup

3.2.1 Robot

The SPEAG DASY52 systems use the high precision robots from Stäubli SA (France). For the 6-axis controller system, the robot controller version (CS8c) from Stäubli is used. The Stäubli robot series have many features that are important for our application:

- High precision (repeatability ± 0.035 mm)
- High reliability (industrial design)
- Jerk-free straight movements
- Low ELF interference (the closed metallic construction shields against motor control fields)





Fig-3.2 SPEAG DASY52 System

FCC SAR Test Report

3.2.2 Probes

The SAR measurement is conducted with the dosimetric probe. The probe is specially designed and calibrated for use in liquid with high permittivity. The dosimetric probe has special calibration in liquid at different frequency.

Model	EX3DV4	
Construction	Symmetrical design with triangular core. Built-in shielding against static charges. PEEK enclosure material (resistant to organic solvents, e.g., DGBE).	
Frequency	10 MHz to 6 GHz Linearity: ± 0.2 dB	
Directivity	± 0.3 dB in HSL (rotation around probe axis) ± 0.5 dB in tissue material (rotation normal to probe axis)	
Dynamic Range	10 μ W/g to 100 mW/g Linearity: ± 0.2 dB (noise: typically $< 1 \mu$ W/g)	
Dimensions	Overall length: 337 mm (Tip: 20 mm) Tip diameter: 2.5 mm (Body: 12 mm) Typical distance from probe tip to dipole centers: 1 mm	

Model	ES3DV3	
Construction	Symmetrical design with triangular core. Interleaved sensors. Built-in shielding against static charges. PEEK enclosure material (resistant to organic solvents, e.g., DGBE).	
Frequency	10 MHz to 4 GHz Linearity: ± 0.2 dB	
Directivity	± 0.2 dB in HSL (rotation around probe axis) ± 0.3 dB in tissue material (rotation normal to probe axis)	
Dynamic Range	5 μ W/g to 100 mW/g Linearity: ± 0.2 dB	
Dimensions	Overall length: 337 mm (Tip: 20 mm) Tip diameter: 3.9 mm (Body: 12 mm) Distance from probe tip to dipole centers: 2.0 mm	

3.2.3 Data Acquisition Electronics (DAE)

Model	DAE3, DAE4	
Construction	Signal amplifier, multiplexer, A/D converter and control logic. Serial optical link for communication with DASY embedded system (fully remote controlled). Two step probe touch detector for mechanical surface detection and emergency robot stop.	
Measurement Range	-100 to +300 mV (16 bit resolution and two range settings: 4mV, 400mV)	
Input Offset Voltage	$< 5 \mu$ V (with auto zero)	
Input Bias Current	< 50 fA	
Dimensions	60 x 60 x 68 mm	

FCC SAR Test Report

3.2.4 Phantoms

Model	Twin SAM	
Construction	The shell corresponds to the specifications of the Specific Anthropomorphic Mannequin (SAM) phantom defined in IEEE 1528 and IEC 62209-1. It enables the dosimetric evaluation of left and right hand phone usage as well as body mounted usage at the flat phantom region. A cover prevents evaporation of the liquid. Reference markings on the phantom allow the complete setup of all predefined phantom positions and measurement grids by teaching three points with the robot.	
Material	Vinylester, glass fiber reinforced (VE-GF)	
Shell Thickness	2 ± 0.2 mm (6 ± 0.2 mm at ear point)	
Dimensions	Length: 1000 mm Width: 500 mm Height: adjustable feet	
Filling Volume	approx. 25 liters	

Model	ELI	
Construction	Phantom for compliance testing of handheld and body-mounted wireless devices in the frequency range of 30 MHz to 6 GHz. ELI is fully compatible with the IEC 62209-2 standard and all known tissue simulating liquids. ELI has been optimized regarding its performance and can be integrated into our standard phantom tables. A cover prevents evaporation of the liquid. Reference markings on the phantom allow installation of the complete setup, including all predefined phantom positions and measurement grids, by teaching three points. The phantom is compatible with all SPEAG dosimetric probes and dipoles.	
Material	Vinylester, glass fiber reinforced (VE-GF)	
Shell Thickness	2.0 ± 0.2 mm (bottom plate)	
Dimensions	Major axis: 600 mm Minor axis: 400 mm	
Filling Volume	approx. 30 liters	

FCC SAR Test Report

3.2.5 Device Holder

Model	Mounting Device	
Construction	In combination with the Twin SAM Phantom or ELI4, the Mounting Device enables the rotation of the mounted transmitter device in spherical coordinates. Rotation point is the ear opening point. Transmitter devices can be easily and accurately positioned according to IEC, IEEE, FCC or other specifications. The device holder can be locked for positioning at different phantom sections (left head, right head, flat).	
Material	POM	

Model	Laptop Extensions Kit	
Construction	Simple but effective and easy-to-use extension for Mounting Device that facilitates the testing of larger devices according to IEC 62209-2 (e.g., laptops, cameras, etc.). It is lightweight and fits easily on the upper part of the Mounting Device in place of the phone positioner.	
Material	POM, Acrylic glass, Foam	

3.2.6 System Validation Dipoles

Model	D-Serial	
Construction	Symmetrical dipole with 1/4 balun. Enables measurement of feed point impedance with NWA. Matched for use near flat phantoms filled with tissue simulating solutions.	
Frequency	750 MHz to 5800 MHz	
Return Loss	> 20 dB	
Power Capability	> 100 W (f < 1GHz), > 40 W (f > 1GHz)	

FCC SAR Test Report

3.2.7 Tissue Simulating Liquids

For SAR measurement of the field distribution inside the phantom, the phantom must be filled with homogeneous tissue simulating liquid to a depth of at least 15 cm. For head SAR testing, the liquid height from the ear reference point (ERP) of the phantom to the liquid top surface is larger than 15 cm. For body SAR testing, the liquid height from the center of the flat phantom to the liquid top surface is larger than 15 cm. The nominal dielectric values of the tissue simulating liquids in the phantom and the tolerance of 5% are listed in Table-3.1.

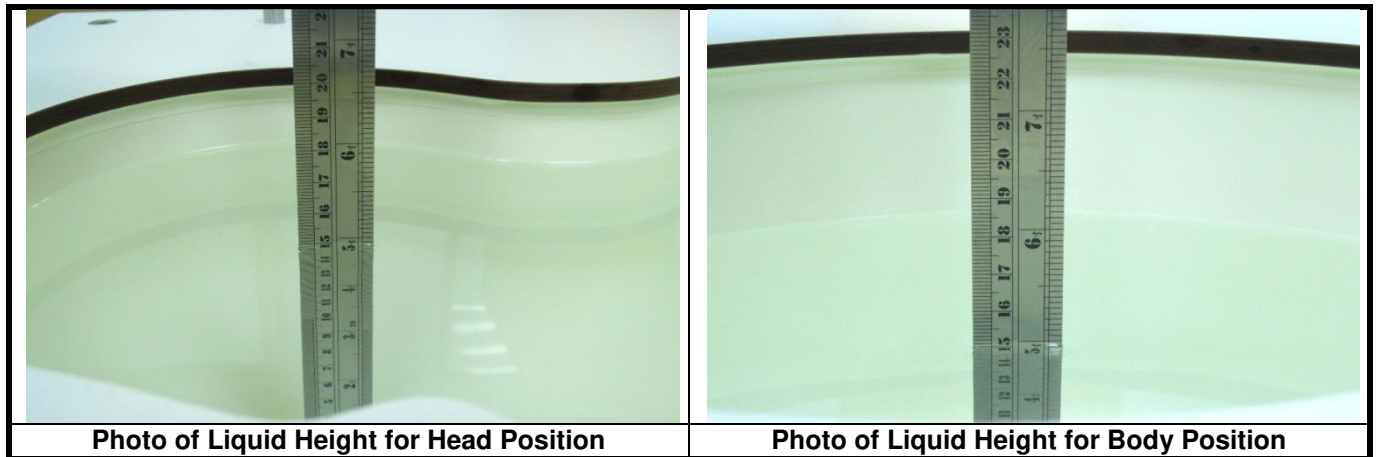

The dielectric properties of the head tissue simulating liquids are defined in IEEE 1528, and KDB 865664 D01 Appendix A. For the body tissue simulating liquids, the dielectric properties are defined in KDB 865664 D01 Appendix A. The dielectric properties of the tissue simulating liquids were verified prior to the SAR evaluation using a dielectric assessment kit and a network analyzer.



FCC SAR Test Report

Table-3.1 Targets of Tissue Simulating Liquid

Frequency (MHz)	Target Permittivity	Range of $\pm 5\%$	Target Conductivity	Range of $\pm 5\%$
For Head				
750	41.9	39.8 ~ 44.0	0.89	0.85 ~ 0.93
835	41.5	39.4 ~ 43.6	0.90	0.86 ~ 0.95
900	41.5	39.4 ~ 43.6	0.97	0.92 ~ 1.02
1450	40.5	38.5 ~ 42.5	1.20	1.14 ~ 1.26
1640	40.3	38.3 ~ 42.3	1.29	1.23 ~ 1.35
1750	40.1	38.1 ~ 42.1	1.37	1.30 ~ 1.44
1800	40.0	38.0 ~ 42.0	1.40	1.33 ~ 1.47
1900	40.0	38.0 ~ 42.0	1.40	1.33 ~ 1.47
2000	40.0	38.0 ~ 42.0	1.40	1.33 ~ 1.47
2300	39.5	37.5 ~ 41.5	1.67	1.59 ~ 1.75
2450	39.2	37.2 ~ 41.2	1.80	1.71 ~ 1.89
2600	39.0	37.1 ~ 41.0	1.96	1.86 ~ 2.06
3500	37.9	36.0 ~ 39.8	2.91	2.76 ~ 3.06
5200	36.0	34.2 ~ 37.8	4.66	4.43 ~ 4.89
5300	35.9	34.1 ~ 37.7	4.76	4.52 ~ 5.00
5500	35.6	33.8 ~ 37.4	4.96	4.71 ~ 5.21
5600	35.5	33.7 ~ 37.3	5.07	4.82 ~ 5.32
5800	35.3	33.5 ~ 37.1	5.27	5.01 ~ 5.53
For Body				
750	55.5	52.7 ~ 58.3	0.96	0.91 ~ 1.01
835	55.2	52.4 ~ 58.0	0.97	0.92 ~ 1.02
900	55.0	52.3 ~ 57.8	1.05	1.00 ~ 1.10
1450	54.0	51.3 ~ 56.7	1.30	1.24 ~ 1.37
1640	53.8	51.1 ~ 56.5	1.40	1.33 ~ 1.47
1750	53.4	50.7 ~ 56.1	1.49	1.42 ~ 1.56
1800	53.3	50.6 ~ 56.0	1.52	1.44 ~ 1.60
1900	53.3	50.6 ~ 56.0	1.52	1.44 ~ 1.60
2000	53.3	50.6 ~ 56.0	1.52	1.44 ~ 1.60
2300	52.9	50.3 ~ 55.5	1.81	1.72 ~ 1.90
2450	52.7	50.1 ~ 55.3	1.95	1.85 ~ 2.05
2600	52.5	49.9 ~ 55.1	2.16	2.05 ~ 2.27
3500	51.3	48.7 ~ 53.9	3.31	3.14 ~ 3.48
5200	49.0	46.6 ~ 51.5	5.30	5.04 ~ 5.57
5300	48.9	46.5 ~ 51.3	5.42	5.15 ~ 5.69
5500	48.6	46.2 ~ 51.0	5.65	5.37 ~ 5.93
5600	48.5	46.1 ~ 50.9	5.77	5.48 ~ 6.06
5800	48.2	45.8 ~ 50.6	6.00	5.70 ~ 6.30

FCC SAR Test Report

The following table gives the recipes for tissue simulating liquids.

Table-3.2 Recipes of Tissue Simulating Liquid

Tissue Type	Bactericide	DGBE	HEC	NaCl	Sucrose	Triton X-100	Water	Diethylene Glycol Mono-hexylether
H750	0.2	-	0.2	1.5	56.0	-	42.1	-
H835	0.2	-	0.2	1.5	57.0	-	41.1	-
H900	0.2	-	0.2	1.4	58.0	-	40.2	-
H1450	-	43.3	-	0.6	-	-	56.1	-
H1640	-	45.8	-	0.5	-	-	53.7	-
H1750	-	47.0	-	0.4	-	-	52.6	-
H1800	-	44.5	-	0.3	-	-	55.2	-
H1900	-	44.5	-	0.2	-	-	55.3	-
H2000	-	44.5	-	0.1	-	-	55.4	-
H2300	-	44.9	-	0.1	-	-	55.0	-
H2450	-	45.0	-	0.1	-	-	54.9	-
H2600	-	45.1	-	0.1	-	-	54.8	-
H3500	-	8.0	-	0.2	-	20.0	71.8	-
H5G	-	-	-	-	-	17.2	65.5	17.3
B750	0.2	-	0.2	0.8	48.8	-	50.0	-
B835	0.2	-	0.2	0.9	48.5	-	50.2	-
B900	0.2	-	0.2	0.9	48.2	-	50.5	-
B1450	-	34.0	-	0.3	-	-	65.7	-
B1640	-	32.5	-	0.3	-	-	67.2	-
B1750	-	31.0	-	0.2	-	-	68.8	-
B1800	-	29.5	-	0.4	-	-	70.1	-
B1900	-	29.5	-	0.3	-	-	70.2	-
B2000	-	30.0	-	0.2	-	-	69.8	-
B2300	-	31.0	-	0.1	-	-	68.9	-
B2450	-	31.4	-	0.1	-	-	68.5	-
B2600	-	31.8	-	0.1	-	-	68.1	-
B3500	-	28.8	-	0.1	-	-	71.1	-
B5G	-	-	-	-	-	10.7	78.6	10.7

3.3 SAR System Verification

The system check verifies that the system operates within its specifications. It is performed daily or before every SAR measurement. The system check uses normal SAR measurements in the flat section of the phantom with a matched dipole at a specified distance. The system verification setup is shown as below.

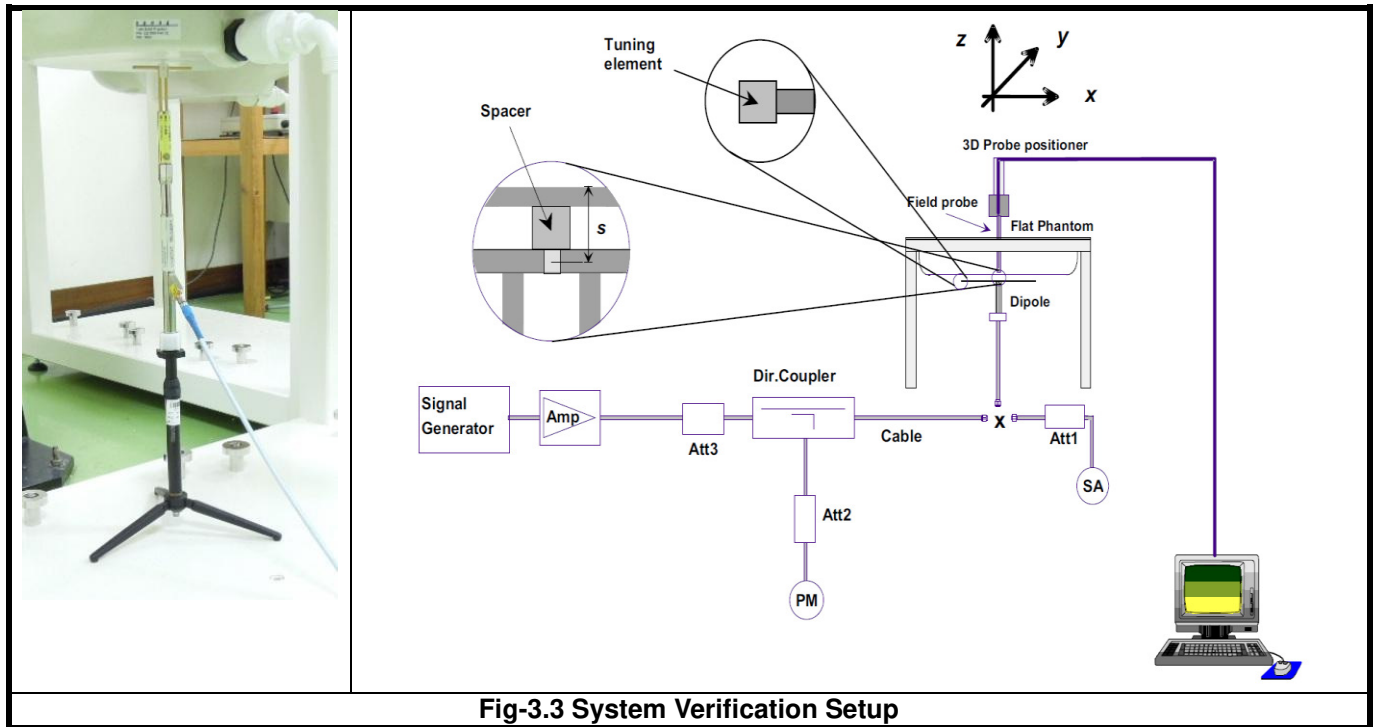

Fig-3.3 System Verification Setup

The validation dipole is placed beneath the flat phantom with the specific spacer in place. The distance spacer is touch the phantom surface with a light pressure at the reference marking and be oriented parallel to the long side of the phantom. The spectrum analyzer measures the forward power at the location of the system check dipole connector. The signal generator is adjusted for the desired forward power (250 mW is used for 700 MHz to 3 GHz, 100 mW is used for 3.5 GHz to 6 GHz) at the dipole connector and the power meter is read at that level. After connecting the cable to the dipole, the signal generator is readjusted for the same reading at power meter.

After system check testing, the SAR result will be normalized to 1W forward input power and compared with the reference SAR value derived from validation dipole certificate report. The deviation of system check should be within 10 %.

3.4 SAR Measurement Procedure

According to the SAR test standard, the recommended procedure for assessing the peak spatial-average SAR value consists of the following steps:

- (a) Power reference measurement
- (b) Area scan
- (c) Zoom scan
- (d) Power drift measurement

The SAR measurement procedures for each of test conditions are as follows:

- (a) Make EUT to transmit maximum output power
- (b) Measure conducted output power through RF cable
- (c) Place the EUT in the specific position of phantom
- (d) Perform SAR testing steps on the DASY system
- (e) Record the SAR value

3.4.1 Area & Zoom Scan Procedure

First Area Scan is used to locate the approximate location(s) of the local peak SAR value(s). The measurement grid within an Area Scan is defined by the grid extent, grid step size and grid offset. Next, in order to determine the EM field distribution in a three-dimensional spatial extension, Zoom Scan is required. The Zoom Scan is performed around the highest E-field value to determine the averaged SAR-distribution over 10 g. According to KDB 865664 D01, the resolution for Area and Zoom scan is specified in the table below.

Items	<= 2 GHz	2-3 GHz	3-4 GHz	4-5 GHz	5-6 GHz
Area Scan ($\Delta x, \Delta y$)	<= 15 mm	<= 12 mm	<= 12 mm	<= 10 mm	<= 10 mm
Zoom Scan ($\Delta x, \Delta y$)	<= 8 mm	<= 5 mm	<= 5 mm	<= 4 mm	<= 4 mm
Zoom Scan (Δz)	<= 5 mm	<= 5 mm	<= 4 mm	<= 3 mm	<= 2 mm
Zoom Scan Volume	>= 30 mm	>= 30 mm	>= 28 mm	>= 25 mm	>= 22 mm

Note:

When zoom scan is required and report SAR is <= 1.4 W/kg, the zoom scan resolution of $\Delta x / \Delta y$ (2-3GHz: <= 8 mm, 3-4GHz: <= 7 mm, 4-6GHz: <= 5 mm) may be applied.

3.4.2 Volume Scan Procedure

The volume scan is used for assess overlapping SAR distributions for antennas transmitting in different frequency bands. It is equivalent to an oversized zoom scan used in standalone measurements. The measurement volume will be used to enclose all the simultaneous transmitting antennas. For antennas transmitting simultaneously in different frequency bands, the volume scan is measured separately in each frequency band. In order to sum correctly to compute the 1g aggregate SAR, the EUT remain in the same test position for all measurements and all volume scan use the same spatial resolution and grid spacing. When all volume scan were completed, the software, SEMCAD postprocessor can combine and subsequently superpose these measurement data to calculating the multiband SAR.

FCC SAR Test Report

3.4.3 Power Drift Monitoring

All SAR testing is under the EUT install full charged battery and transmit maximum output power. In DASY measurement software, the power reference measurement and power drift measurement procedures are used for monitoring the power drift of EUT during SAR test. Both these procedures measure the field at a specified reference position before and after the SAR testing. The software will calculate the field difference in dB. If the power drift more than 5%, the SAR will be retested.

3.4.4 Spatial Peak SAR Evaluation

The procedure for spatial peak SAR evaluation has been implemented according to the test standard. It can be conducted for 1g and 10g, as well as for user-specific masses. The DASY software includes all numerical procedures necessary to evaluate the spatial peak SAR value.

The base for the evaluation is a "cube" measurement. The measured volume must include the 1g and 10g cubes with the highest averaged SAR values. For that purpose, the center of the measured volume is aligned to the interpolated peak SAR value of a previously performed area scan.

The entire evaluation of the spatial peak values is performed within the post-processing engine (SEMCAD). The system always gives the maximum values for the 1g and 10g cubes. The algorithm to find the cube with highest averaged SAR is divided into the following stages:

- (a) Extraction of the measured data (grid and values) from the Zoom Scan
- (b) Calculation of the SAR value at every measurement point based on all stored data (A/D values and measurement parameters)
- (c) Generation of a high-resolution mesh within the measured volume
- (d) Interpolation of all measured values from the measurement grid to the high-resolution grid
- (e) Extrapolation of the entire 3-D field distribution to the phantom surface over the distance from sensor to surface
- (f) Calculation of the averaged SAR within masses of 1g and 10g

3.4.5 SAR Averaged Methods

In DASY, the interpolation and extrapolation are both based on the modified Quadratic Shepard's method. The interpolation scheme combines a least-square fitted function method and a weighted average method which are the two basic types of computational interpolation and approximation.

Extrapolation routines are used to obtain SAR values between the lowest measurement points and the inner phantom surface. The extrapolation distance is determined by the surface detection distance and the probe sensor offset. The uncertainty increases with the extrapolation distance. To keep the uncertainty within 1% for the 1 g and 10 g cubes, the extrapolation distance should not be larger than 5 mm.

4. SAR Measurement Evaluation

4.1 EUT Configuration and Setting

<Considerations Related to Proximity Sensor>

The device supports WWAN, WLAN, and Bluetooth capabilities. It is designed with a proximity sensor which can trigger/not trigger power reduction for GSM, WCDMA, CDMA, and LTE on Rear Face and Bottom Side of EUT for SAR compliance. Others RF capability (WLAN and Bluetooth) have no power reduction. The power levels for all wireless technologies and the power reduction please refer to section 4.6 of this report.

Proximity Sensor Triggering Distances (KDB 616217 D04 §6.2)

The proximity sensor triggering distance was determined per KDB 616217 for rear face and applicable edge. Summary for power verification per distance was tabulated in the below table.

Output Power Verification in dBm for EUT Rear Face											
Distance (mm)	37	38	39	40	41	42	43	44	45	46	47
GSM850. GPRS 1Tx	31.0	30.6	30.6	30.9	31.0	30.5	31.7	31.5	31.8	31.8	31.6
GSM850. GPRS 2Tx	27.5	27.5	27.9	28.0	27.8	27.9	31.5	31.5	31.5	31.6	31.7
GSM850. EDGE 1Tx	26.8	26.7	26.5	26.5	26.6	26.9	26.5	26.9	27.0	26.5	26.7
GSM850. EDGE 2Tx	26.7	26.7	26.5	27.0	26.7	27.0	26.9	27.0	26.5	26.7	26.8
GSM850. EDGE 3Tx	26.0	25.8	25.6	25.8	25.8	25.8	26.2	26.3	26.3	26.2	26.5
GSM850. EDGE 4Tx	24.2	24.1	24.0	24.3	24.5	24.0	26.0	26.5	26.5	26.4	26.3
GSM1900. GPRS 1Tx	28.0	27.9	27.6	27.9	27.8	27.5	28.5	28.5	29.0	29.0	28.9
GSM1900. GPRS 2Tx	25.0	24.8	24.5	24.7	24.5	24.8	28.7	28.8	29.0	29.0	28.7
GSM1900. EDGE 1Tx	24.5	24.6	24.8	24.5	24.5	24.9	25.0	25.4	25.3	25.3	25.5
GSM1900. EDGE 2Tx	24.8	25.0	24.5	24.6	24.8	24.9	24.9	24.5	24.6	25.0	24.9
GSM1900. EDGE 3Tx	23.4	23.1	23.2	23.2	23.2	23.1	25.0	25.0	24.6	24.5	24.7
GSM1900. EDGE 4Tx	22.1	22.5	22.3	22.5	22.4	22.0	24.8	25.0	24.9	24.9	24.8
WCDMA II	18.9	18.7	19.0	19.0	18.6	18.9	22.7	22.7	23.0	23.0	22.7
WCDMA IV	18.1	18.5	18.5	18.1	18.0	18.3	22.3	22.3	22.3	22.1	22.2
WCDMA V	21.1	20.7	21.0	21.2	21.1	20.8	22.5	22.4	22.4	22.0	22.3
CDMA BC0	20.8	20.6	21.0	21.0	20.7	21.0	22.9	23.0	22.9	22.7	23.2
CDMA BC1	18.5	19.0	18.5	18.9	18.6	18.8	23.2	23.0	23.0	22.9	23.0
CDMA BC10	20.6	21.0	20.8	20.6	21.0	21.0	23.6	23.4	23.3	23.2	23.5
LTE 2	19.2	19.2	19.5	19.4	19.5	19.4	22.8	22.9	22.9	23.0	22.9
LTE 4	19.8	19.9	19.8	19.6	19.9	19.8	22.7	22.9	22.9	22.9	22.7
LTE 5	21.0	21.1	21.0	21.1	21.5	21.5	22.9	22.6	23.0	22.8	22.5
LTE 13	20.8	20.9	20.9	20.9	21.2	20.8	22.8	22.8	23.3	23.1	23.2
LTE 17	21.8	21.4	21.6	21.8	21.7	21.4	22.5	22.5	22.3	22.3	22.4
LTE 25	18.0	18.5	18.5	18.5	18.3	18.0	22.9	22.9	23.0	22.6	22.9

Output Power Verification in dBm for EUT Bottom Edge											
Distance (mm)	27	28	29	30	31	32	33	34	35	36	37
GSM850, GPRS 1Tx	30.5	30.7	30.8	30.8	30.7	30.7	32.0	31.7	31.5	31.5	31.8
GSM850, GPRS 2Tx	27.6	27.9	27.7	27.6	28.0	27.6	32.0	31.9	31.7	31.8	32.0
GSM850, EDGE 1Tx	26.6	26.7	26.5	26.5	26.9	27.0	26.5	26.9	26.9	26.5	26.8
GSM850, EDGE 2Tx	26.6	26.6	26.8	26.7	26.7	27.0	26.8	26.5	26.9	26.5	27.0
GSM850, EDGE 3Tx	25.6	26.0	25.6	26.0	25.9	26.0	26.2	26.2	26.1	26.3	26.4
GSM850, EDGE 4Tx	24.1	24.3	24.3	24.1	24.5	24.4	26.2	26.2	26.2	26.0	26.2
GSM1900, GPRS 1Tx	27.7	28.0	27.6	27.9	27.8	27.7	29.0	29.0	29.0	28.6	28.9
GSM1900, GPRS 2Tx	24.7	24.9	24.6	24.5	24.6	24.8	28.8	28.8	28.8	28.9	29.0
GSM1900, EDGE 1Tx	24.7	24.5	24.8	24.8	24.6	24.9	25.4	25.0	25.1	25.3	25.4
GSM1900, EDGE 2Tx	24.6	24.5	24.9	24.9	25.0	24.5	24.9	24.7	25.0	24.8	24.6
GSM1900, EDGE 3Tx	23.4	23.2	23.5	23.0	23.1	23.0	24.6	24.5	25.0	24.8	25.0
GSM1900, EDGE 4Tx	22.3	22.1	22.2	22.1	22.3	22.2	25.0	24.6	24.8	24.5	24.8
WCDMA II	18.9	18.6	18.8	18.6	18.6	19.0	22.5	22.8	23.0	22.9	23.0
WCDMA IV	18.2	18.4	18.1	18.4	18.1	18.0	22.2	22.1	22.5	22.5	22.2
WCDMA V	20.8	20.9	20.7	20.9	20.7	20.9	22.5	22.1	22.1	22.4	22.1
CDMA BC0	21.0	20.7	20.9	20.9	20.6	20.9	23.2	22.8	23.2	22.9	22.9
CDMA BC1	18.5	19.0	18.6	18.8	18.5	18.7	23.2	22.9	22.8	23.2	22.7
CDMA BC10	20.6	20.6	20.9	20.5	20.8	20.7	23.1	23.1	23.6	23.4	23.1
LTE 2	19.3	19.0	19.4	19.5	19.1	19.1	22.8	23.0	22.9	22.8	22.9
LTE 4	20.0	19.7	19.9	20.0	19.5	19.7	22.7	22.8	22.8	22.9	22.7
LTE 5	21.1	21.1	21.5	21.0	21.3	21.0	22.8	23.0	23.0	22.6	22.7
LTE 13	20.9	21.2	21.2	21.0	21.2	20.9	23.2	22.8	23.2	23.2	22.8
LTE 17	21.7	21.7	21.6	21.4	21.4	21.4	22.6	22.3	22.7	22.7	22.5
LTE 25	18.5	18.1	18.2	18.1	18.0	18.5	22.9	23.0	22.9	23.0	23.0

Proximity Sensor Coverage (KDB 616217 D04 §6.3)

Since the proximity sensor is collocated with antenna in one component, the procedure for proximity sensor coverage is not required.

Proximity Sensor Tilt Angle Influences (KDB 616217 D04 §6.4)

The proximity sensor tilt angle influence was determined per KDB 616217 for applicable edge. Summary for proximity sensor tilt angle influence is shown in below.

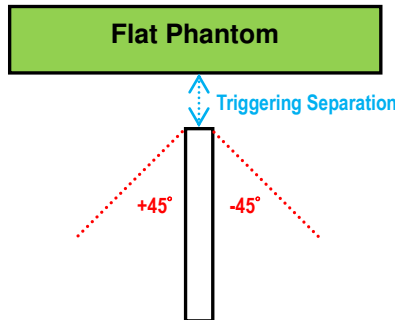

Orientation	Separation Distance (mm)	Tilt Angle										
		-45°	-40°	-30°	-20°	-10°	0°	10°	20°	30°	40°	45°
Bottom Edge	32	On	On	On	On	On	On	On	On	On	On	On

FCC SAR Test Report

Summary for Proximity Sensor Triggering Test

According to the procedures noticed in KDB 616217 D04, the proximity sensor triggering distance is 42 mm for EUT Rear Face, and 32 mm for Bottom Side. The separation distance of 32 mm determined by the smallest triggering distance on Bottom Side is used to access the tilt angle influence and the sensor does not release during ± 45 degree. Therefore, the smallest separation distance for tilt angle influence is 32 mm for the Bottom Side. The conservation triggering distances based on the separation distance for the sensor trigger / not triggered as EUT with power reduction at 0 mm, and EUT without power reduction at 6 mm for EUT Rear Face, and 10 mm for Bo Side were used to test SAR.

The power reduction is depends on the proximity sensor input. For a steady SAR test, the power reduction was enabled or disabled manually by engineering software during SAR testing.

<Connections between EUT and System Simulator>

For WWAN SAR testing, the EUT was linked and controlled by base station emulator (Agilent E5515C is used for GSM/WCDMA/CDMA, and Anritsu MT8820C is used for LTE). Communication between the EUT and the emulator was established by air link. The distance between the EUT and the communicating antenna of the emulator is larger than 50 cm and the output power radiated from the emulator antenna is at least 30 dB smaller than the output power of EUT. The EUT was set from the emulator to radiate maximum output power during SAR testing.

<Considerations Related to GSM / GPRS / EDGE for Setup and Testing>

The maximum multi-slot capability supported by this device is as below.

1. This EUT is class B device
2. This EUT supports GPRS multi-slot class 10 (max. uplink: 2, max. downlink: 4, total timeslots: 5)
3. This EUT supports EDGE multi-slot class 12 (max. uplink: 4, max. downlink: 4, total timeslots: 5)

For GSM850 frequency band, the power control level is set to 5 for GSM mode and GPRS (GMSK: CS1), and set to 8 for EDGE (GMSK: MCS1, 8PSK: MCS9). For GSM1900 frequency band, the power control level is set to 0 for GSM mode and GPRS (GMSK: CS1), and set to 2 for EDGE (GMSK: MCS1, 8PSK: MCS9).

SAR test reduction for GPRS and EDGE modes is determined by the source-based time-averaged output power specified for production units, including tune-up tolerance. The data mode with highest specified time-averaged output power should be tested for SAR compliance in the applicable exposure conditions. For modes with the same specified maximum output power and tolerance, the higher number time-slot configuration should be tested.

FCC SAR Test Report

<Considerations Related to WCDMA for Setup and Testing>

Release 5 HSDPA Data Devices

The 3G SAR test reduction procedure is applied to body SAR with 12.2 kbps RMC as the primary mode. Otherwise, body SAR for HSDPA is measured using an FRC with H-Set 1 in Sub-test 1 and a 12.2 kbps RMC configured in Test Loop Mode 1, for the highest reported SAR configuration in 12.2 kbps RMC without HSDPA. HSDPA is configured according to the applicable UE category of a test device. The number of HS-DSCH / HS-PDSCHs, HARQ processes, minimum inter-TTI interval, transport block sizes and RV coding sequence are defined by the H-set. To maintain a consistent test configuration and stable transmission conditions, QPSK is used in the H-set for SAR testing. HS-DPCCH should be configured with a CQI feedback cycle of 4 ms and a CQI repetition factor of 2 to maintain a constant rate of active CQI slots. DPCCH and DPDCH gain factors (β_c , β_d), and HS-DPCCH power offset parameters (Δ_{ACK} , Δ_{NACK} , Δ_{CQI}) are set according to values indicated in below. The CQI value is determined by the UE category, transport block size, number of HS-PDSCHs and modulation used in the H-set.

Sub-test	β_c	β_d	β_d (SF)	β_c / β_d	$\beta_{hs}^{(1)}$	CM (dB) ⁽²⁾	MPR
1	2 / 15	15 / 15	64	2 / 15	4 / 15	0.0	0
2	12 / 15 ⁽³⁾	15 / 15 ⁽³⁾	64	12 / 15 ⁽³⁾	24 / 15	1.0	0
3	15 / 15	8 / 15	64	15 / 8	30 / 15	1.5	0.5
4	15 / 15	4 / 15	64	15 / 4	30 / 15	1.5	0.5

Note 1: Δ_{ACK} , Δ_{NACK} and $\Delta_{CQI} = 8 \Leftrightarrow A_{hs} = \beta_{hs} / \beta_c = 30 / 15 \Leftrightarrow \beta_{hs} = 30 / 15 * \beta_c$.

Note 2: CM = 1 for $\beta_c / \beta_d = 12 / 15$, $\beta_{hs} / \beta_c = 24 / 15$.

Note 3: For subtest 2 the β_c / β_d ratio of 12 / 15 for the TFC during the measurement period (TF1, TF0) is achieved by setting the signaled gain factors for the reference TFC (TF1, TF1) to $\beta_c = 11 / 15$ and $\beta_d = 15 / 15$.

FCC SAR Test Report

Release 6 HSUPA Data Devices

The 3G SAR test reduction procedure is applied to body SAR with 12.2 kbps RMC as the primary mode. Otherwise, body SAR for HSPA is measured with E-DCH Sub-test 5, using H-Set 1 and QPSK for FRC and a 12.2 kbps RMC configured in Test Loop Mode 1 and power control algorithm 2, according to the highest reported body SAR configuration in 12.2 kbps RMC without HSPA. When VOIP applies to head exposure, the 3G SAR test reduction procedure is applied with 12.2 kbps RMC as the primary mode. Otherwise, the same HSPA configuration used for body SAR measurements are applied to head exposure testing. Due to inner loop power control requirements in HSPA, a communication test set is required for output power and SAR tests. The 12.2 kbps RMC, FRC H-set 1 and E-DCH configurations for HSPA are configured according to the β values indicated in below.

Sub-test	β_c	β_d	β_d (SF)	β_c / β_d	$\beta_{hs}^{(1)}$	β_{ec}	β_{ed}	β_{ed} (SF)	β_{ed} (codes)	CM ⁽²⁾ (dB)	MPR (dB)	AG ⁽⁴⁾ Index	E-TFCI
1	11 / 15 ⁽³⁾	15 / 15 ⁽³⁾	64	11 / 15 ⁽³⁾	22 / 15	209 / 225	1039 / 225	4	1	1.0	0.0	20	75
2	6 / 15	15 / 15	64	6 / 15	12 / 15	12 / 15	94 / 75	4	1	3.0	2.0	12	67
3	15 / 15	9 / 15	64	15 / 9	30 / 15	30 / 15	$\beta_{ed1}: 47/15$ $\beta_{ed2}: 47/15$	4	2	2.0	1.0	15	92
4	2 / 15	15 / 15	64	2 / 15	4 / 15	2 / 15	56 / 75	4	1	3.0	2.0	17	71
5	15 / 15 ⁽⁴⁾	15 / 15 ⁽⁴⁾	64	15 / 15 ⁽⁴⁾	30 / 15	24 / 15	134 / 15	4	1	1.0	0.0	21	81

Note 1: $\Delta_{ACK}, \Delta_{NACK}$ and $\Delta_{CQI} = 8 \Leftrightarrow A_{hs} = \beta_{hs} / \beta_c = 30 / 15 \Leftrightarrow \beta_{hs} = 30 / 15 * \beta_c$
 Note 2: CM = 1 for $\beta_c / \beta_d = 12 / 15, \beta_{hs} / \beta_c = 24 / 15$. For all other combinations of DPDCH, DPCCH, HS-DPCCH, E-DPDCH and E-DPCCH the MPR is based on the relative CM difference.
 Note 3: For subtest 1 the β_c / β_d ratio of 11 / 15 for the TFC during the measurement period (TF1, TF0) is achieved by setting the signaled gain factors for the reference TFC (TF1, TF1) to $\beta_c = 10 / 15$ and $\beta_d = 15 / 15$.
 Note 4: For subtest 5 the β_c / β_d ratio of 15 / 15 for the TFC during the measurement period (TF1, TF0) is achieved by setting the signaled gain factors for the reference TFC (TF1, TF1) to $\beta_c = 14 / 15$ and $\beta_d = 15 / 15$.
 Note 5: Testing UE using E-DPDCH Physical Layer category 1 Sub-test 3 is not required according to TS 25.306 Table 5.1g.
 Note 6: β_{ed} cannot be set directly; it is set by Absolute Grant Value.

HSPA+ SAR Guidance

The 3G SAR test reduction procedure is applied to HSPA+ (uplink) with 12.2 kbps RMC as the primary mode. Otherwise, when SAR is required for Rel. 6 HSPA, SAR is required for Rel. 7 HSPA+. Power is measured for HSPA+ that supports uplink 16QAM according to configurations in Table C.11.1.4 of 3GPP TS 34.121-1 to determine SAR test reduction.

DC-HSDPA SAR Guidance

The 3G SAR test reduction procedure is applied to DC-HSDPA with 12.2 kbps RMC as the primary mode. Otherwise, when SAR is required for Rel. 5 HSDPA, SAR is required for Rel. 8 DC-HSDPA. Power is measured for DC-HSDPA according to the H-Set 12, FRC configuration in Table C.8.1.12 of 3GPP TS 34.121-1 to determine SAR test reduction. A primary and a secondary serving HS-DSCH Cell are required to perform the power measurement and for the results to be acceptable.



FCC SAR Test Report

<Considerations Related to CDMA for Setup and Testing>

EV-DO Data Devices

SAR is measured using the F/R TAP configurations required for Rev. 0, Rev. A and Rev. B. The AT is tested with a Reverse Data Channel rate of 153.6 kbps in Subtype 0/1 Physical Layer configurations. A Reverse Data Channel payload size of 4096 bits and Termination Target of 16 slots are used for Subtype 2 and 3. FTAP, FETAP and FMCTAP are all configured with a Forward Traffic Channel data rate corresponding to the 2-slot version of 307.2 kbps with ACK Channel transmitting in all slots. AT power control is in "All Bits Up" conditions for the TAP / ETAP / MCTAP. Body-worn and other body SAR are measured using Subtype 0/1 Physical Layer configurations for Rev. 0. The 3G SAR test reduction procedure is applied to Rev. A, Subtype 2 Physical layer configuration, with Rev. 0 as the primary mode. Otherwise, SAR is measured for Rev. A using the highest reported SAR configuration for body-worn exposure in Rev. 0. SAR is required for Rev. B, Subtype 3; it is measured by applying both the "test 2" and "test 3" configurations used for power measurement.

EV-DO Data Devices Support 1xRTT

The 3G SAR test reduction procedure is applied to 1xRTT RC3 and RC1 with EV-DO Rev. 0, Rev. A and Rev. B as the respective primary modes. Otherwise, the "CDMA 1xRTT Handsets Body-worn SAR" procedures are applied.

1x-Advanced SAR Guidance

The 3G SAR test reduction procedure is applied to 1x-Advanced with 1xRTT RC3 as the primary mode. When SAR measurement is required, the 1x-Advanced power measurement configurations are used. The 1x Advanced SAR procedures are applied separately to head, body-worn and other exposure conditions.

<Considerations Related to LTE for Setup and Testing>

This device contains LTE transmitter which follows 3GPP standards, is category 3, supports both QPSK and 16QAM modulations, and supported LTE band and channel bandwidth is listed in below. The output power was tested per 3GPP TS 36.521-1 maximum transmit procedures for both QPSK and 16QAM modulation. The results please refer to section 4.6 of this report.

EUT Supported LTE Band and Channel Bandwidth						
LTE Band	BW 1.4 MHz	BW 3 MHz	BW 5 MHz	BW 10 MHz	BW 15 MHz	BW 20 MHz
2	V	V	V	V	V	V
4	V	V	V	V	V	V
5	V	V	V	V		
13			V	V		
17			V	V		
25	V	V	V	V	V	V

The LTE maximum power reduction (MPR) in accordance with 3GPP TS 36.101 is active all times during LTE operation. The allowed MPR for the maximum output power is specified in below.

FCC SAR Test Report

Modulation	Channel Bandwidth / RB Configurations						LTE MPR Setting (dB)
	BW 1.4 MHz	BW 3 MHz	BW 5 MHz	BW 10 MHz	BW 15 MHz	BW 20 MHz	
QPSK	> 5	> 4	> 8	> 12	> 16	> 18	1
16QAM	<= 5	<= 4	<= 8	<= 12	<= 16	<= 18	1
16QAM	> 5	> 4	> 8	> 12	> 16	> 18	2

Note: MPR is according to the standard and implemented in the circuit (mandatory).

In addition, the device is compliant with additional maximum power reduction (A-MPR) requirements defined in 3GPP TS 36.101 section 6.2.4 that was disabled for all FCC compliance testing.

During LTE SAR testing, the related parameters of operating band, channel bandwidth, uplink channel number, modulation type, and RB was set in base station simulator. When the EUT has registered and communicated to base station simulator, the simulator set to make EUT transmitting the maximum radiated power.

<Considerations Related to WLAN for Setup and Testing>

In general, various vendor specific external test software and chipset based internal test modes are typically used for SAR measurement. These chipset based test mode utilities are generally hardware and manufacturer dependent, and often include substantial flexibility to reconfigure or reprogram a device. A Wi-Fi device must be configured to transmit continuously at the required data rate, channel bandwidth and signal modulation, using the highest transmission duty factor supported by the test mode tools for SAR measurement. The test frequencies established using test mode must correspond to the actual channel frequencies. When 802.11 frame gaps are accounted for in the transmission, a maximum transmission duty factor of 92 - 96% is typically achievable in most test mode configurations. A minimum transmission duty factor of 85% is required to avoid certain hardware and device implementation issues related to wide range SAR scaling. In addition, a periodic transmission duty factor is required for current generation SAR systems to measure SAR correctly. The reported SAR must be scaled to 100% transmission duty factor to determine compliance at the maximum tune-up tolerance limit.

According to KDB 248227 D01, this device has installed WLAN engineering testing software which can provide continuous transmitting RF signal. During WLAN SAR testing, this device was operated to transmit continuously at the maximum transmission duty with specified transmission mode, operating frequency, lowest data rate, and maximum output power.

Initial Test Configuration

An initial test configuration is determined for OFDM transmission modes in 2.4 GHz and 5 GHz bands according to the channel bandwidth, modulation and data rate combination(s) with the highest maximum output power specified for production units in each standalone and aggregated frequency band. When the same maximum power is specified for multiple transmission modes in a frequency band, the largest channel bandwidth, lowest order modulation, lowest data rate and lowest order 802.11a/g/n/ac mode is used for SAR measurement, on the highest measured output power channel in the initial test configuration, for each frequency band.

FCC SAR Test Report

Subsequent Test Configuration

SAR measurement requirements for the remaining 802.11 transmission mode configurations that have not been tested in the initial test configuration are determined separately for each standalone and aggregated frequency band, in each exposure condition, according to the maximum output power specified for production units. Additional power measurements may be required to determine if SAR measurements are required for subsequent highest output power channels in a subsequent test configuration. When the highest reported SAR for the initial test configuration according to the initial test position or fixed exposure position requirements, is adjusted by the ratio of the subsequent test configuration to initial test configuration specified maximum output power and the adjusted SAR is ≤ 1.2 W/kg, SAR is not required for that subsequent test configuration.

SAR Test Configuration and Channel Selection

When multiple channel bandwidth configurations in a frequency band have the same specified maximum output power, the initial test configuration is using largest channel bandwidth, lowest order modulation, lowest data rate, and lowest order 802.11 mode (i.e., 802.11a is chosen over 802.11n then 802.11ac or 802.11g is chosen over 802.11n). After an initial test configuration is determined, if multiple test channels have the same measured maximum output power, the channel chosen for SAR measurement is determined according to the following.

- 1) The channel closest to mid-band frequency is selected for SAR measurement.
- 2) For channels with equal separation from mid-band frequency; for example, high and low channels or two mid-band channels, the higher frequency (number) channel is selected for SAR measurement.

Test Reduction for U-NII-1 (5.2 GHz) and U-NII-2A (5.3 GHz) Bands

For devices that operate in both U-NII bands using the same transmitter and antenna(s), SAR test reduction is determined according to the following.

- 1) When the same maximum output power is specified for both bands, begin SAR measurement in U-NII-2A band by applying the OFDM SAR requirements. If the highest reported SAR for a test configuration is ≤ 1.2 W/kg, SAR is not required for U-NII-1 band for that configuration (802.11 mode and exposure condition).
- 2) When different maximum output power is specified for the bands, begin SAR measurement in the band with higher specified maximum output power. The highest reported SAR for the tested configuration is adjusted by the ratio of lower to higher specified maximum output power for the two bands. When the adjusted SAR is ≤ 1.2 W/kg, SAR is not required for the band with lower maximum output power in that test configuration.

<Considerations Related to Bluetooth for Setup and Testing>

This device has installed Bluetooth engineering testing software which can provide continuous transmitting RF signal. During Bluetooth SAR testing, this device was operated to transmit continuously at the maximum transmission duty with specified transmission mode, operating frequency, lowest data rate, and maximum output power.

4.2 EUT Testing Position

4.2.1 Body Exposure Conditions

For laptop PC, according to KDB 616217 D04, SAR evaluation is required for the bottom surface of the keyboard. This EUT was tested in the base of EUT directly against the flat phantom. The required minimum test separation distance for incorporating transmitters and antennas into laptop computer display is determined with the display screen opened at an angle of 90° to the keyboard compartment.

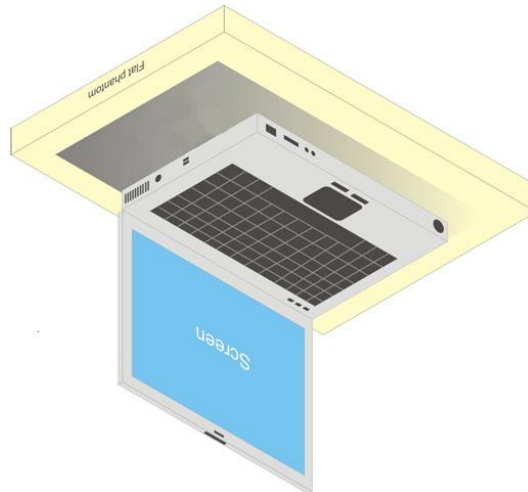

Fig-4.1 Illustration for Laptop Setup

For full-size tablet, according to KDB 616217 D04, SAR evaluation is required for back surface and edges of the devices. The back surface and edges of the tablet are tested with the tablet touching the phantom. Exposures from antennas through the front surface of the display section of a tablet are generally limited to the user's hands. Exposures to hands for typical consumer transmitters used in tablets are not expected to exceed the extremity SAR limit; therefore, SAR evaluation for the front surface of tablet display screens are generally not necessary. When voice mode is supported on a tablet and it is limited to speaker mode or headset operations only, additional SAR testing for this type of voice use is not required.

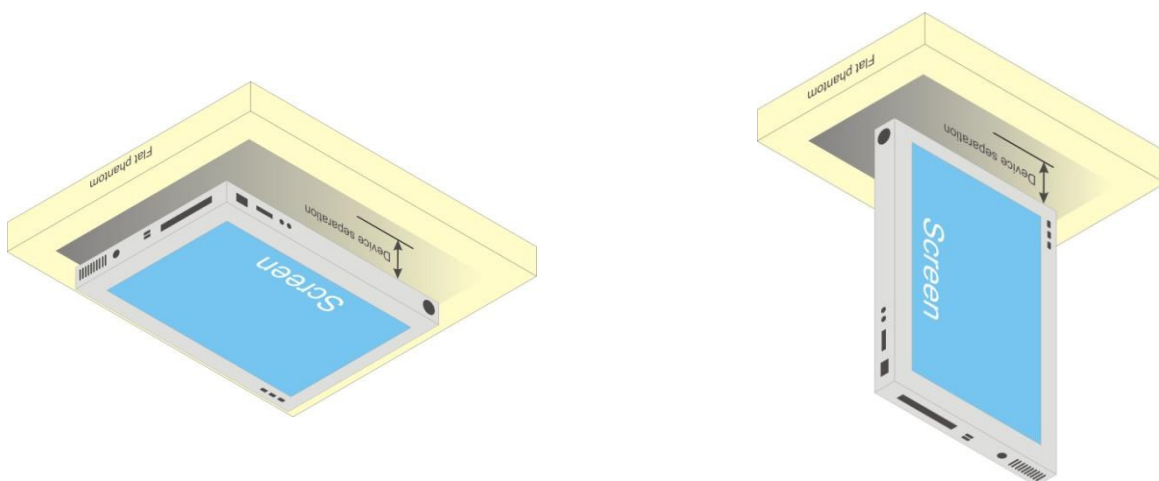

Fig-4.2 Illustration for Tablet Setup

FCC SAR Test Report

4.2.2 SAR Test Exclusion Evaluations

According to KDB 447498 D01, the SAR test exclusion condition is based on source-based time-averaged maximum conducted output power, adjusted for tune-up tolerance, and the minimum test separation distance required for the exposure conditions. The SAR exclusion threshold is determined by the following formula.

- For the test separation distance ≤ 50 mm

$$\frac{\text{Max. Tune up Power}_{(mW)}}{\text{Min. Test Separation Distance}_{(mm)}} \times \sqrt{f_{(GHz)}} \leq 3.0 \text{ for SAR-1g, } \leq 7.5 \text{ for SAR-10g}$$

When the minimum test separation distance is < 5 mm, a distance of 5 mm is applied to determine SAR test exclusion.

- For the test separation distance > 50 mm, and the frequency at 100 MHz to 1500 MHz

$$\left[(\text{Threshold at 50 mm in Step 1}) + (\text{Test Separation Distance} - 50 \text{ mm}) \times \left(\frac{f_{(MHz)}}{150} \right) \right]_{(mW)}$$

- For the test separation distance > 50 mm, and the frequency at > 1500 MHz to 6 GHz

$$[(\text{Threshold at 50 mm in Step 1}) + (\text{Test Separation Distance} - 50 \text{ mm}) \times 10]_{(mW)}$$

<For WWAN Ant-0>

Mode	Max. Tune-up Power (dBm)	Max. Tune-up Power (mW)	Rear Face			Left Side			Right Side			Top Side			Bottom Side		
			Ant. to Surface (mm)	Calculated Result	Require SAR Testing?	Ant. to Surface (mm)	Calculated Result	Require SAR Testing?	Ant. to Surface (mm)	Calculated Result	Require SAR Testing?	Ant. to Surface (mm)	Calculated Result	Require SAR Testing?	Ant. to Surface (mm)	Calculated Result	Require SAR Testing?
GSM 850	27.0	501.19	5	92.4	YES	115.49	533 mW	No	17.1	27	YES	274.3	1432 mW	No	9.1	50.7	YES
GSM 1900	24.0	251.19	5	69.4	YES	115.49	763 mW	No	17.1	20.3	YES	274.3	2352 mW	No	9.1	38.1	YES
WCDMA II	24.0	251.19	5	69.4	YES	115.49	763 mW	No	17.1	20.3	YES	274.3	2352 mW	No	9.1	38.1	YES
WCDMA IV	24.0	251.19	5	66.5	YES	115.49	768 mW	No	17.1	19.4	YES	274.3	2356 mW	No	9.1	36.5	YES
WCDMA V	24.0	251.19	5	46.2	YES	115.49	533 mW	No	17.1	13.5	YES	274.3	1430 mW	No	9.1	25.4	YES
CDMA BC0	24.5	281.84	5	51.9	YES	115.49	533 mW	No	17.1	15.2	YES	274.3	1431 mW	No	9.1	28.5	YES
CDMA BC1	24.5	281.84	5	77.9	YES	115.49	763 mW	No	17.1	22.8	YES	274.3	2352 mW	No	9.1	42.8	YES
CDMA BC10	24.5	281.84	5	51.1	YES	115.49	525 mW	No	17.1	15	YES	274.3	1396 mW	No	9.1	28.1	YES
LTE 2	24.0	251.19	5	69.4	YES	115.49	763 mW	No	17.1	20.3	YES	274.3	2352 mW	No	9.1	38.1	YES
LTE 4	24.0	251.19	5	66.5	YES	115.49	768 mW	No	17.1	19.4	YES	274.3	2356 mW	No	9.1	36.5	YES
LTE 5	24.0	251.19	5	46.2	YES	115.49	533 mW	No	17.1	13.5	YES	274.3	1430 mW	No	9.1	25.4	YES
LTE 13	24.0	251.19	5	44.5	YES	115.49	512 mW	No	17.1	13	YES	274.3	1343 mW	No	9.1	24.5	YES
LTE 17	24.0	251.19	5	42.5	YES	115.49	489 mW	No	17.1	12.4	YES	274.3	1245 mW	No	9.1	23.3	YES
LTE 25	24.0	251.19	5	69.5	YES	115.49	763 mW	No	17.1	20.3	YES	274.3	2351 mW	No	9.1	38.2	YES

Note:

- When separation distance ≤ 50 mm and the calculated result shown in above table is ≤ 3.0 for SAR-1g exposure condition, or ≤ 7.5 for SAR-10g exposure condition, the SAR testing exclusion is applied.
- When separation distance > 50 mm and the device output power is less than the calculated result (power threshold, mW) shown in above table, the SAR testing exclusion is applied.
- Since GSM has multi-slot operation, the maximum tune-up power shown in above table for GSM is source-based time-averaged maximum power.



FCC SAR Test Report

4.2.3 Simultaneous Transmission Possibilities

The simultaneous transmission possibilities for this device are listed as below.

Simultaneous TX Combination	Capable Transmit Configurations	Body Exposure Condition
1	GSM850 (Voice / Data) + WLAN (Data) + BT (Data)	Yes
2	GSM1900 (Voice / Data) + WLAN (Data) + BT (Data)	Yes
3	WCDMA II (Voice / Data) + WLAN (Data) + BT (Data)	Yes
4	WCDMA IV (Voice / Data) + WLAN (Data) + BT (Data)	Yes
5	WCDMA V (Voice / Data) + WLAN (Data) + BT (Data)	Yes
6	CDMA BC0 (Voice / Data) + WLAN (Data) + BT (Data)	Yes
7	CDMA BC1 (Voice / Data) + WLAN (Data) + BT (Data)	Yes
8	CDMA BC10 (Voice / Data) + WLAN (Data) + BT (Data)	Yes
9	LTE 2 (Data) + WLAN (Data) + BT (Data)	Yes
10	LTE 4 (Data) + WLAN (Data) + BT (Data)	Yes
11	LTE 5 (Data) + WLAN (Data) + BT (Data)	Yes
12	LTE 13 (Data) + WLAN (Data) + BT (Data)	Yes
13	LTE 17 (Data) + WLAN (Data) + BT (Data)	Yes
14	LTE 25 (Data) + WLAN (Data) + BT (Data)	Yes

Note :

- 1. The 2.4G WLAN and 5G WLAN cannot transmit simultaneously.
- 2. The WWAN transmitter can only use either CDMA or LTE at a time.

FCC SAR Test Report

4.3 Tissue Verification

The measuring results for tissue simulating liquid are shown as below.

Test Date	Tissue Type	Frequency (MHz)	Liquid Temp. (°C)	Measured Conductivity (σ)	Measured Permittivity (ϵ_r)	Target Conductivity (σ)	Target Permittivity (ϵ_r)	Conductivity Deviation (%)	Permittivity Deviation (%)
Mar. 12, 2016	Body	750	23.1	0.969	56.228	0.96	55.5	0.94	1.31
Mar. 25, 2016	Body	750	23.2	0.975	55.099	0.96	55.5	1.56	-0.72
Mar. 09, 2016	Body	835	23.6	0.969	54.978	0.97	55.2	-0.10	-0.40
Mar. 24, 2016	Body	835	23.2	0.979	56.083	0.97	55.2	0.93	1.60
Mar. 25, 2016	Body	835	23.2	0.979	56.094	0.97	55.2	0.93	1.62
Mar. 26, 2016	Body	835	23.2	0.979	56.088	0.97	55.8	0.93	0.52
Mar. 14, 2016	Body	1750	23.1	1.434	52.025	1.49	53.4	-3.76	-2.57
Mar. 25, 2016	Body	1750	23.2	1.439	51.297	1.49	53.4	-3.42	-3.94
Mar. 26, 2016	Body	1750	23.2	1.440	51.300	1.49	53.4	-3.36	-3.93
Mar. 12, 2016	Body	1900	23.1	1.584	51.623	1.52	53.3	4.21	-3.15
Mar. 24, 2016	Body	1900	23.2	1.582	50.842	1.52	53.3	4.08	-4.61
Mar. 25, 2016	Body	1900	23.3	1.581	50.841	1.52	53.3	4.01	-4.61
Mar. 26, 2016	Body	1900	23.1	1.581	50.842	1.52	53.3	4.01	-4.61

Note:

The dielectric properties of the tissue simulating liquid must be measured within 24 hours before the SAR testing and within $\pm 5\%$ of the target values. Liquid temperature during the SAR testing must be within $\pm 2^\circ\text{C}$.

4.4 System Validation

The SAR measurement system was validated according to procedures in KDB 865664 D01. The validation status in tabulated summary is as below.

Test Date	Probe S/N	Calibration Point		Measured Conductivity (σ)	Measured Permittivity (ϵ_r)	Validation for CW			Validation for Modulation		
						Sensitivity Range	Probe Linearity	Probe Isotropy	Modulation Type	Duty Factor	PAR
Mar. 12, 2016	3864	Body	750	0.969	56.228	Pass	Pass	Pass	N/A	N/A	N/A
Mar. 25, 2016	3864	Body	750	0.975	55.099	Pass	Pass	Pass	N/A	N/A	N/A
Mar. 09, 2016	3650	Body	835	0.969	54.978	Pass	Pass	Pass	N/A	N/A	N/A
Mar. 24, 2016	3864	Body	835	0.979	56.083	Pass	Pass	Pass	GMSK	Pass	N/A
Mar. 25, 2016	3864	Body	835	0.979	56.094	Pass	Pass	Pass	N/A	N/A	N/A
Mar. 26, 2016	3864	Body	835	0.979	56.088	Pass	Pass	Pass	GMSK	Pass	N/A
Mar. 14, 2016	3864	Body	1750	1.434	52.025	Pass	Pass	Pass	N/A	N/A	N/A
Mar. 25, 2016	3864	Body	1750	1.439	51.297	Pass	Pass	Pass	N/A	N/A	N/A
Mar. 26, 2016	3864	Body	1750	1.440	51.300	Pass	Pass	Pass	N/A	N/A	N/A
Mar. 12, 2016	3864	Body	1900	1.584	51.623	Pass	Pass	Pass	N/A	N/A	N/A
Mar. 24, 2016	3864	Body	1900	1.582	50.842	Pass	Pass	Pass	GMSK	Pass	N/A
Mar. 25, 2016	3864	Body	1900	1.581	50.841	Pass	Pass	Pass	N/A	N/A	N/A
Mar. 26, 2016	3864	Body	1900	1.581	50.842	Pass	Pass	Pass	GMSK	Pass	N/A

FCC SAR Test Report

4.5 System Verification

The measuring result for system verification is tabulated as below.

Test Date	Mode	Frequency (MHz)	1W Target SAR-1g (W/kg)	Measured SAR-1g (W/kg)	Normalized to 1W SAR-1g (W/kg)	Deviation (%)	Dipole S/N	Probe S/N	DAE S/N
Mar. 12, 2016	Body	750	8.44	2.00	8.00	-5.21	1013	3864	861
Mar. 25, 2016	Body	750	8.44	2.17	8.68	2.84	1013	3864	861
Mar. 09, 2016	Body	835	9.20	2.18	8.72	-5.22	4d121	3650	1277
Mar. 24, 2016	Body	835	9.20	2.37	9.48	3.04	4d121	3864	861
Mar. 25, 2016	Body	835	9.20	2.30	9.20	0.00	4d121	3864	861
Mar. 26, 2016	Body	835	9.20	2.37	9.48	3.04	4d121	3864	861
Mar. 14, 2016	Body	1750	37.60	10.00	40.00	6.38	1055	3864	861
Mar. 25, 2016	Body	1750	37.60	9.21	36.84	-2.02	1055	3864	861
Mar. 26, 2016	Body	1750	37.60	9.36	37.44	-0.43	1055	3864	861
Mar. 12, 2016	Body	1900	40.70	9.50	38.00	-6.63	5d036	3864	861
Mar. 24, 2016	Body	1900	40.70	10.50	42.00	3.19	5036	3864	861
Mar. 25, 2016	Body	1900	40.70	10.40	41.60	2.21	5d036	3864	861
Mar. 26, 2016	Body	1900	40.70	10.30	41.20	1.23	5d036	3864	861

Note:

Comparing to the reference SAR value provided by SPEAG, the validation data should be within its specification of 10 %. The result indicates the system check can meet the variation criterion and the plots can be referred to Appendix A of this report.

FCC SAR Test Report

4.6 Maximum Output Power

4.6.1 Maximum Conducted Power

The maximum conducted average power (Unit: dBm) including tune-up tolerance is shown as below.

Mode	Maximum Burst-Averaged Output Power		Maximum Frame-Averaged Output Power		Power Reduction (dB)
	GSM850 (without Power Reduction)	GSM850 (with Power Reduction)	GSM850 (without Power Reduction)	GSM850 (without Power Reduction)	
GPRS (GMSK, 1Tx-slot)	33.0	31.5	24.0	22.5	1.5
GPRS (GMSK, 2Tx-slot)	33.0	29.0	27.0	23.0	4.0
EDGE (8PSK, 1Tx-slot)	28.0	28.0	19.0	19.0	0.0
EDGE (8PSK, 2Tx-slot)	28.0	28.0	22.0	22.0	0.0
EDGE (8PSK, 3Tx-slot)	28.0	27.0	23.7	22.7	1.0
EDGE (8PSK, 4Tx-slot)	28.0	25.5	25.0	22.5	2.5

Mode	Maximum Burst-Averaged Output Power		Maximum Frame-Averaged Output Power		Power Reduction (dB)
	GSM1900 (without Power Reduction)	GSM1900 (with Power Reduction)	GSM1900 (without Power Reduction)	GSM1900 (with Power Reduction)	
GPRS (GMSK, 1Tx-slot)	30.0	29.0	21.0	20.0	1.0
GPRS (GMSK, 2Tx-slot)	30.0	26.5	24.0	20.5	3.5
EDGE (8PSK, 1Tx-slot)	27.0	27.0	18.0	18.0	0.0
EDGE (8PSK, 2Tx-slot)	26.5	26.0	20.5	20.0	0.5
EDGE (8PSK, 3Tx-slot)	26.5	24.5	22.2	20.2	2.0
EDGE (8PSK, 4Tx-slot)	26.0	23.0	23.0	20.0	3.0

Note:

- SAR testing was performed on the maximum frame-averaged power mode.
- The frame-averaged power is linearly proportion to the slot number configured and it is linearly scaled the maximum burst-averaged power based on time slots. The calculated method is shown as below:

$$\text{Frame-averaged power} = 10 \times \log (\text{Burst-averaged power mW} \times \text{Slot used} / 8)$$

Mode	WCDMA Band II (without Power Reduction)	WCDMA Band II (with Power Reduction)	Power Reduction (dB)
RMC 12.2K	24.0	20.0	4.0
HSDPA	24.0	19.0	5.0
DC-HSDPA	24.0	19.0	5.0
HSUPA	24.0	18.5	5.5

Mode	WCDMA Band IV (without Power Reduction)	WCDMA Band IV (with Power Reduction)	Power Reduction (dB)
RMC 12.2K	24.0	20.0	4.0
HSDPA	24.0	19.0	5.0
DC-HSDPA	24.0	19.0	5.0
HSUPA	24.0	18.5	5.5

FCC SAR Test Report

Mode	WCDMA Band V (without Power Reduction)	WCDMA Band V (with Power Reduction)	Power Reduction (dB)
RMC 12.2K	24.0	22.0	2.0
HSDPA	24.0	21.0	3.0
DC-HSDPA	24.0	21.0	3.0
HSUPA	24.0	20.5	3.5

Mode	CDMA BC0 (without Power Reduction)	CDMA BC0 (with Power Reduction)	Power Reduction (dB)
1xRTT	24.5	22.0	2.5
1xEVDO Rev.0	24.5	22.0	2.5
1xEVDO Rev.A	24.5	22.0	2.5

Mode	CDMA BC1 (without Power Reduction)	CDMA BC1 (with Power Reduction)	Power Reduction (dB)
1xRTT	24.5	19.5	5.0
1xEVDO Rev.0	24.5	19.5	5.0
1xEVDO Rev.A	24.5	19.5	5.0

Mode	CDMA BC10 (without Power Reduction)	CDMA BC10 (with Power Reduction)	Power Reduction (dB)
1xRTT	24.5	22.0	2.5
1xEVDO Rev.0	24.5	22.0	2.5
1xEVDO Rev.A	24.5	22.0	2.5

Mode	LTE 2 (without Power Reduction)	LTE 2 (with Power Reduction)	Power Reduction (dB)
QPSK / 16QAM	24.0	20.5	3.5

Mode	LTE 4 (without Power Reduction)	LTE 4 (with Power Reduction)	Power Reduction (dB)
QPSK / 16QAM	24.0	21.0	3.0

Mode	LTE 5 (without Power Reduction)	LTE 5 (with Power Reduction)	Power Reduction (dB)
QPSK / 16QAM	24.0	22.5	1.5

Mode	LTE 13 (without Power Reduction)	LTE 13 (with Power Reduction)	Power Reduction (dB)
QPSK / 16QAM	24.0	22.5	1.5

Mode	LTE 17 (without Power Reduction)	LTE 17 (with Power Reduction)	Power Reduction (dB)
QPSK / 16QAM	24.0	23.0	1.0

Mode	LTE 25 (without Power Reduction)	LTE 25 (with Power Reduction)	Power Reduction (dB)
QPSK / 16QAM	24.0	19.5	4.5



FCC SAR Test Report

4.6.2 Measured Conducted Power Result

The measuring conducted average power (Unit: dBm) is shown as below.

Band	GSM850			GSM1900		
Channel	128	189	251	512	661	810
Frequency (MHz)	824.2	836.4	848.8	1850.2	1880.0	1909.8
EUT without Power Reduction (P-Sensor NOT Triggered)						
Maximum Burst-Averaged Output Power						
GPRS (GMSK, 1Tx-slot)	31.47	31.40	31.70	28.61	28.74	28.84
GPRS (GMSK, 2Tx-slot)	31.44	31.35	31.58	28.66	28.76	28.86
EDGE (8PSK, 1Tx-slot)	26.57	26.41	26.73	25.12	25.05	25.17
EDGE (8PSK, 2Tx-slot)	26.45	26.40	26.70	24.64	24.76	24.87
EDGE (8PSK, 3Tx-slot)	26.32	26.22	26.47	24.59	24.70	24.83
EDGE (8PSK, 4Tx-slot)	26.06	26.01	26.30	24.46	24.65	24.71
EUT with Power Reduction (P-Sensor Triggered)						
Maximum Burst-Averaged Output Power						
GPRS (GMSK, 1Tx-slot)	30.56	30.52	30.46	27.78	27.82	27.83
GPRS (GMSK, 2Tx-slot)	27.98	27.90	27.85	24.71	24.77	24.79
EDGE (8PSK, 1Tx-slot)	26.73	26.62	26.58	24.66	24.69	24.71
EDGE (8PSK, 2Tx-slot)	26.61	26.53	26.41	24.72	24.80	24.81
EDGE (8PSK, 3Tx-slot)	25.97	25.93	25.88	23.18	23.21	23.23
EDGE (8PSK, 4Tx-slot)	24.41	24.31	24.16	21.93	22.03	22.09

Band	WCDMA Band II			WCDMA Band IV			WCDMA Band V			3GPP MPR (dB)
Channel	9262	9400	9538	1312	1413	1513	4132	4182	4233	
Frequency (MHz)	1852.4	1880.0	1907.6	1712.4	1732.6	1752.6	826.4	836.4	846.6	
EUT without Power Reduction (P-Sensor NOT Triggered)										
RMC 12.2K	22.80	22.81	22.87	22.34	22.37	22.39	22.23	22.27	22.33	-
HSDPA Subtest-1	22.09	22.10	22.20	22.06	22.09	22.11	22.09	22.12	22.16	0
HSDPA Subtest-2	22.18	22.22	22.28	22.07	22.10	22.12	22.12	22.18	22.22	0
HSDPA Subtest-3	21.68	21.69	21.80	21.62	21.67	21.69	21.65	21.69	21.77	0.5
HSDPA Subtest-4	21.65	21.66	21.72	21.57	21.63	21.66	21.63	21.67	21.73	0.5
DC-HSDPA Subtest-1	22.02	22.06	22.11	22.03	22.06	22.08	22.06	22.09	22.13	0
DC-HSDPA Subtest-2	22.08	22.13	22.19	22.04	22.07	22.09	22.08	22.14	22.19	0
DC-HSDPA Subtest-3	21.59	21.65	21.74	21.57	21.63	21.66	21.62	21.66	21.73	0.5
DC-HSDPA Subtest-4	21.57	21.61	21.65	21.52	21.57	21.62	21.44	21.57	21.67	0.5
HSUPA Subtest-1	22.04	22.14	22.17	22.03	22.06	22.09	22.01	22.02	22.08	0
HSUPA Subtest-2	20.12	20.48	20.20	20.41	20.49	20.48	20.93	20.96	21.07	2
HSUPA Subtest-3	21.19	21.25	21.32	21.22	21.25	21.28	21.02	21.13	21.18	1
HSUPA Subtest-4	20.26	20.81	20.93	20.66	20.76	20.80	20.59	20.70	20.84	2
HSUPA Subtest-5	22.60	22.70	22.75	22.25	22.34	22.36	22.22	22.27	22.31	0
EUT with Power Reduction (P-Sensor Triggered)										
RMC 12.2K	18.80	18.72	19.02	18.14	18.30	18.31	20.93	21.01	20.87	-
HSDPA Subtest-1	18.57	18.51	18.84	17.91	17.95	17.94	19.93	20.12	19.88	0
HSDPA Subtest-2	18.49	18.35	18.73	18.05	18.01	18.04	20.02	20.13	19.90	0
HSDPA Subtest-3	17.96	17.80	18.15	17.49	17.49	17.50	19.57	19.59	19.36	0.5
HSDPA Subtest-4	17.83	17.79	18.05	17.48	17.59	17.49	19.52	19.67	19.37	0.5
DC-HSDPA Subtest-1	18.54	18.43	18.65	17.69	17.82	17.84	19.95	20.03	19.91	0
DC-HSDPA Subtest-2	18.25	18.22	18.58	17.70	17.88	17.89	19.99	20.09	19.94	0
DC-HSDPA Subtest-3	17.83	17.75	18.14	17.24	17.36	17.40	19.44	19.49	19.37	0.5
DC-HSDPA Subtest-4	17.73	17.70	17.93	17.35	17.47	17.48	19.58	19.62	19.49	0.5
HSUPA Subtest-1	17.74	17.69	18.00	17.93	17.61	17.53	19.68	19.92	19.27	0
HSUPA Subtest-2	16.62	16.52	16.88	16.67	16.56	16.56	18.54	18.66	18.51	2
HSUPA Subtest-3	17.08	17.03	17.26	16.75	16.77	16.83	18.67	18.72	18.53	1
HSUPA Subtest-4	17.26	17.13	17.51	16.97	17.04	17.03	19.18	19.08	18.95	2
HSUPA Subtest-5	18.24	18.20	18.48	18.20	18.20	18.10	20.05	20.21	20.03	0

FCC SAR Test Report

Band	CDMA BC0			CDMA BC1			CDMA BC10			
	Channel	1013	384	777	25	600	1175	476	580	684
Frequency (MHz)	824.70	836.52	848.31	1851.25	1880.00	1908.75	817.9	820.5	823.1	
EUT without Power Reduction (P-Sensor NOT Triggered)										
1xRTT RC1+SO55	22.84	23.10	22.91	23.12	23.19	23.08	23.54	23.56	23.53	
1xRTT RC3+SO55	22.91	23.15	22.98	23.25	23.34	23.23	23.57	23.69	23.56	
1xRTT RC3+SO32 (FCH)	22.86	23.13	22.93	22.97	23.05	22.93	23.67	23.59	23.66	
1xRTT RC3+SO32 (SCH)	22.79	23.08	22.91	22.91	22.95	22.86	23.64	23.66	23.63	
1xEVDO Rev.0 RTAP 153.6	22.56	22.91	22.74	23.13	23.20	23.02	23.61	23.63	23.60	
1xEVDO Rev.A RETAP 4096	22.70	22.98	22.79	22.57	22.64	22.55	23.6	23.62	23.59	
EUT with Power Reduction (P-Sensor Triggered)										
1xRTT RC1+SO55	20.91	21.03	20.82	18.81	18.94	18.91	20.84	20.91	20.87	
1xRTT RC3+SO55	21.06	21.18	20.94	18.84	18.99	18.95	20.9	20.97	20.94	
1xRTT RC3+SO32 (FCH)	20.87	20.97	20.77	18.70	18.83	18.79	20.82	20.89	20.84	
1xRTT RC3+SO32 (SCH)	20.82	20.95	20.74	18.71	18.84	18.81	20.83	20.9	20.86	
1xEVDO Rev.0 RTAP 153.6	20.86	20.96	20.77	18.66	18.79	18.73	20.8	20.87	20.82	
1xEVDO Rev.A RETAP 4096	20.92	21.04	20.87	18.69	18.81	18.78	20.85	20.92	20.89	

Band / BW	RB Size	RB Offset	QPSK			3GPP MPR (dB)	16QAM			3GPP MPR (dB)
			Low CH 18607	Mid CH 18900	High CH 19193		Low CH 18607	Mid CH 18900	High CH 19193	
			1850.7 MHz	1880.0 MHz	1909.3 MHz		1850.7 MHz	1880.0 MHz	1909.3 MHz	
EUT without Power Reduction (P-Sensor NOT Triggered)										
2 / 1.4M	1	0	22.56	22.80	22.51	0	21.59	21.86	21.55	1
	1	2	22.44	22.64	22.27	0	21.31	21.68	21.16	1
	1	5	22.06	22.34	22.01	0	21.07	21.35	21.02	1
	3	0	22.68	22.76	22.41	0	21.66	21.74	21.39	1
	3	1	22.51	22.71	22.10	0	21.49	21.69	21.08	1
	3	3	22.54	22.63	22.07	0	21.52	21.61	21.05	1
	6	0	21.04	21.15	21.01	1	20.08	20.15	20.05	2
EUT with Power Reduction (P-Sensor Triggered)										
2 / 1.4M	1	0	18.79	19.00	18.97	0	18.78	18.99	18.96	0
	1	2	18.59	18.92	18.88	0	18.58	18.91	18.87	0
	1	5	18.51	18.79	18.64	0	18.50	18.78	18.63	0
	3	0	18.60	18.85	18.84	0	18.59	18.84	18.83	0
	3	1	18.55	18.56	18.57	0	18.54	18.55	18.56	0
	3	3	18.51	18.54	18.55	0	18.50	18.53	18.54	0
	6	0	18.35	18.70	18.54	1	18.34	18.69	18.53	1



FCC SAR Test Report

A D T

Band / BW	RB Size	RB Offset	QPSK			3GPP MPR (dB)	16QAM			3GPP MPR (dB)
			Low CH 18615	Mid CH 18900	High CH 19185		Low CH 18615	Mid CH 18900	High CH 19185	
			1851.5 MHz	1880.0 MHz	1908.5 MHz		1851.5 MHz	1880.0 MHz	1908.5 MHz	
EUT without Power Reduction (P-Sensor NOT Triggered)										
2 / 3M	1	0	22.62	22.86	22.59	0	21.68	21.90	21.63	1
	1	7	22.49	22.68	22.31	0	21.45	21.73	21.36	1
	1	14	22.18	22.42	22.04	0	21.29	21.48	21.16	1
	8	0	21.11	21.31	21.08	1	20.12	20.35	20.06	2
	8	3	21.01	21.20	21.03	1	20.10	20.23	20.60	2
	8	7	21.05	21.18	21.01	1	20.03	20.20	20.01	2
	15	0	21.14	21.27	21.05	1	20.11	20.30	20.08	2
EUT with Power Reduction (P-Sensor Triggered)										
2 / 3M	1	0	18.84	19.05	18.99	0	18.82	19.03	18.97	0
	1	7	18.74	18.94	18.89	0	18.72	18.92	18.87	0
	1	14	18.57	18.84	18.80	0	18.55	18.82	18.78	0
	8	0	18.69	18.91	18.86	1	18.67	18.89	18.84	1
	8	3	18.40	18.65	18.59	1	18.38	18.63	18.57	1
	8	7	18.34	18.47	18.39	1	18.32	18.45	18.37	1
		15	0	18.54	18.77	18.63	1	18.52	18.75	18.61

Band / BW	RB Size	RB Offset	QPSK			3GPP MPR (dB)	16QAM			3GPP MPR (dB)
			Low CH 18625	Mid CH 18900	High CH 19175		Low CH 18625	Mid CH 18900	High CH 19175	
			1852.5 MHz	1880.0 MHz	1907.5 MHz		1852.5 MHz	1880.0 MHz	1907.5 MHz	
EUT without Power Reduction (P-Sensor NOT Triggered)										
2 / 5M	1	0	22.69	22.91	22.67	0	21.72	21.96	21.67	1
	1	12	22.56	22.75	22.41	0	21.48	21.79	21.43	1
	1	24	22.32	22.52	22.17	0	21.32	21.53	21.17	1
	12	0	21.19	21.39	21.05	1	20.17	20.41	20.10	2
	12	6	21.02	21.31	21.09	1	20.10	20.33	20.03	2
	12	13	21.10	21.28	21.06	1	20.04	20.30	20.02	2
		25	0	21.13	21.36	21.03	1	20.13	20.36	20.01
EUT with Power Reduction (P-Sensor Triggered)										
2 / 5M	1	0	18.91	19.09	19.06	0	18.88	19.06	19.03	0
	1	12	18.77	19.01	18.97	0	18.74	18.98	18.94	0
	1	24	18.67	18.91	18.87	0	18.64	18.88	18.84	0
	12	0	18.70	18.98	18.92	1	18.67	18.95	18.89	1
	12	6	18.53	18.80	18.77	1	18.50	18.77	18.74	1
	12	13	18.50	18.60	18.58	1	18.47	18.57	18.55	1
		25	0	18.55	18.83	18.80	1	18.52	18.80	18.77

Band / BW	RB Size	RB Offset	QPSK			3GPP MPR (dB)	16QAM			3GPP MPR (dB)
			Low CH 18650	Mid CH 18900	High CH 19150		Low CH 18650	Mid CH 18900	High CH 19150	
			1855.0 MHz	1880.0 MHz	1905.0 MHz		1855.0 MHz	1880.0 MHz	1905.0 MHz	
EUT without Power Reduction (P-Sensor NOT Triggered)										
2 / 10M	1	0	22.74	22.96	22.70	0	21.77	22.00	21.73	1
	1	24	22.60	22.80	22.42	0	21.62	21.82	21.51	1
	1	49	22.32	22.53	22.23	0	21.39	21.56	21.20	1
	25	0	21.23	21.48	21.16	1	20.18	20.45	20.12	2
	25	12	21.18	21.40	21.11	1	20.15	20.38	20.04	2
	25	25	21.12	21.39	21.09	1	20.06	20.36	20.03	2
	50	0	21.23	21.45	21.15	1	20.23	20.41	20.12	2
EUT with Power Reduction (P-Sensor Triggered)										
2 / 10M	1	0	19.01	19.15	19.13	0	18.97	19.11	19.09	0
	1	24	18.91	19.09	19.07	0	18.87	19.05	19.03	0
	1	49	18.83	19.01	18.97	0	18.79	18.97	18.93	0
	25	0	18.89	19.06	19.05	1	18.85	19.02	19.01	1
	25	12	18.72	18.91	18.87	1	18.68	18.87	18.83	1
	25	25	18.64	18.76	18.72	1	18.60	18.72	18.68	1
		50	0	18.78	18.98	18.94	1	18.74	18.94	18.90

Band / BW	RB Size	RB Offset	QPSK			3GPP MPR (dB)	16QAM			3GPP MPR (dB)
			Low CH 18675	Mid CH 18900	High CH 19125		Low CH 18675	Mid CH 18900	High CH 19125	
			1857.5 MHz	1880.0 MHz	1902.5 MHz		1857.5 MHz	1880.0 MHz	1902.5 MHz	
EUT without Power Reduction (P-Sensor NOT Triggered)										
2 / 15M	1	0	22.79	23.01	22.77	0	21.85	22.06	21.81	1
	1	37	22.63	22.85	22.49	0	21.75	21.90	21.53	1
	1	74	22.44	22.61	22.28	0	21.44	21.68	21.31	1
	36	0	21.42	21.56	21.28	1	20.37	20.59	20.29	2
	36	19	21.30	21.51	21.25	1	20.26	20.52	20.22	2
	36	39	21.26	21.49	21.23	1	20.22	20.49	20.18	2
		75	0	21.41	21.54	21.30	1	20.35	20.56	20.26
EUT with Power Reduction (P-Sensor Triggered)										
2 / 15M	1	0	19.08	19.20	19.19	0	19.07	19.19	19.18	0
	1	37	19.02	19.14	19.11	0	19.01	19.13	19.10	0
	1	74	18.94	19.08	19.06	0	18.93	19.07	19.05	0
	36	0	18.97	19.11	19.10	1	18.96	19.10	19.09	1
	36	19	18.83	19.02	18.94	1	18.82	19.01	18.93	1
	36	39	18.79	18.88	18.86	1	18.78	18.87	18.85	1
		75	0	18.91	19.06	18.99	1	18.90	19.05	18.98



FCC SAR Test Report

A D T

Band / BW	RB Size	RB Offset	QPSK			3GPP MPR (dB)	16QAM			3GPP MPR (dB)
			Low CH 18700	Mid CH 18900	High CH 19100		Low CH 18700	Mid CH 18900	High CH 19100	
			1860.0 MHz	1880.0 MHz	1900.0 MHz		1860.0 MHz	1880.0 MHz	1900.0 MHz	
EUT without Power Reduction (P-Sensor NOT Triggered)										
2 / 20M	1	0	22.85	23.06	22.83	0	21.87	22.10	21.85	1
	1	50	22.70	22.90	22.63	0	21.75	21.92	21.58	1
	1	99	22.54	22.70	22.39	0	21.48	21.71	21.45	1
	50	0	21.54	21.67	21.43	1	20.49	20.66	20.40	2
	50	25	21.42	21.62	21.40	1	20.37	20.60	20.36	2
	50	50	21.39	21.61	21.38	1	20.35	20.58	20.34	2
	100	0	21.51	21.65	21.42	1	20.43	20.64	20.39	2
EUT with Power Reduction (P-Sensor Triggered)										
2 / 20M	1	0	19.16	19.25	19.24	0	19.14	19.23	19.22	0
	1	50	19.12	19.20	19.19	0	19.10	19.18	19.17	0
	1	99	19.07	19.16	19.15	0	19.05	19.14	19.13	0
	50	0	19.09	19.18	19.17	1	19.07	19.16	19.15	1
	50	25	18.99	19.11	19.07	1	18.97	19.09	19.05	1
	50	50	18.93	19.02	19.00	1	18.91	19.00	18.98	1
	100	0	19.05	19.14	19.13	1	19.03	19.12	19.11	1

Band / BW	RB Size	RB Offset	QPSK			3GPP MPR (dB)	16QAM			3GPP MPR (dB)
			Low CH 19957	Mid CH 20175	High CH 20393		Low CH 19957	Mid CH 20175	High CH 20393	
			1710.7 MHz	1732.5 MHz	1754.3 MHz		1710.7 MHz	1732.5 MHz	1754.3 MHz	
EUT without Power Reduction (P-Sensor NOT Triggered)										
4 / 1.4M	1	0	22.26	22.33	22.38	0	21.25	21.32	21.40	1
	1	2	22.42	22.48	22.54	0	21.44	21.53	21.58	1
	1	5	22.02	22.08	22.14	0	21.02	21.06	21.10	1
	3	0	22.18	22.13	22.15	0	21.15	21.10	21.12	1
	3	1	22.30	22.22	22.34	0	21.27	21.19	21.31	1
	3	3	22.06	22.04	22.01	0	21.05	21.03	21.01	1
	6	0	21.01	21.11	21.14	1	20.01	20.05	20.09	2
EUT with Power Reduction (P-Sensor Triggered)										
4 / 1.4M	1	0	19.08	19.12	19.17	0	19.07	19.11	19.16	0
	1	2	19.33	19.37	19.41	0	19.32	19.36	19.40	0
	1	5	19.03	19.04	19.02	0	19.02	19.03	19.01	0
	3	0	19.01	19.05	19.01	0	19.00	19.04	19.00	0
	3	1	19.02	19.04	19.06	0	19.01	19.03	19.05	0
	3	3	19.03	19.02	19.08	0	19.02	19.01	19.07	0
	6	0	19.02	19.08	19.12	1	19.01	19.07	19.11	1



FCC SAR Test Report

A D T

Band / BW	RB Size	RB Offset	QPSK			3GPP MPR (dB)	16QAM			3GPP MPR (dB)
			Low CH 19965	Mid CH 20175	High CH 20385		Low CH 19965	Mid CH 20175	High CH 20385	
			1711.5 MHz	1732.5 MHz	1753.5 MHz		1711.5 MHz	1732.5 MHz	1753.5 MHz	
EUT without Power Reduction (P-Sensor NOT Triggered)										
4 / 3M	1	0	22.27	22.36	22.46	0	21.33	21.41	21.51	1
	1	7	22.41	22.54	22.58	0	21.51	21.61	21.63	1
	1	14	22.02	22.08	22.20	0	21.01	21.15	21.23	1
	8	0	21.02	21.04	21.06	1	20.01	20.03	20.05	2
	8	3	21.07	21.10	21.12	1	20.06	20.09	20.11	2
	8	7	21.01	21.03	21.05	1	20.01	20.02	20.04	2
	15	0	21.04	21.09	21.12	1	20.08	20.16	20.21	2
EUT with Power Reduction (P-Sensor Triggered)										
4 / 3M	1	0	19.17	19.21	19.24	0	19.15	19.19	19.22	0
	1	7	19.39	19.45	19.48	0	19.37	19.43	19.46	0
	1	14	19.04	19.05	19.07	0	19.02	19.03	19.05	0
	8	0	18.92	18.95	19.03	1	18.90	18.93	19.01	1
	8	3	19.03	19.12	19.17	1	19.01	19.10	19.15	1
	8	7	18.94	19.01	19.07	1	18.92	18.99	19.05	1
	15	0	19.12	19.17	19.21	1	19.10	19.15	19.19	1

Band / BW	RB Size	RB Offset	QPSK			3GPP MPR (dB)	16QAM			3GPP MPR (dB)
			Low CH 19975	Mid CH 20175	High CH 20375		Low CH 19975	Mid CH 20175	High CH 20375	
			1712.5 MHz	1732.5 MHz	1752.5 MHz		1712.5 MHz	1732.5 MHz	1752.5 MHz	
EUT without Power Reduction (P-Sensor NOT Triggered)										
4 / 5M	1	0	22.37	22.45	22.51	0	21.39	21.46	21.53	1
	1	12	22.48	22.58	22.63	0	21.53	21.63	21.69	1
	1	24	22.06	22.21	22.31	0	21.06	21.22	21.30	1
	12	0	21.03	21.10	21.15	1	20.02	20.08	20.16	2
	12	6	21.04	21.18	21.21	1	20.03	20.12	20.21	2
	12	13	21.01	21.06	21.11	1	20.01	20.01	20.09	2
	25	0	21.18	21.23	21.25	1	20.08	20.23	20.27	2
EUT with Power Reduction (P-Sensor Triggered)										
4 / 5M	1	0	19.27	19.29	19.34	0	19.24	19.26	19.31	0
	1	12	19.47	19.53	19.55	0	19.44	19.50	19.52	0
	1	24	19.06	19.12	19.18	0	19.03	19.09	19.15	0
	12	0	19.05	19.09	19.15	1	19.02	19.06	19.12	1
	12	6	19.12	19.21	19.27	1	19.09	19.18	19.24	1
	12	13	19.06	19.12	19.18	1	19.03	19.09	19.15	1
	25	0	19.21	19.27	19.29	1	19.18	19.24	19.26	1



FCC SAR Test Report

A D T

Band / BW	RB Size	RB Offset	QPSK			3GPP MPR (dB)	16QAM			3GPP MPR (dB)
			Low CH 20000	Mid CH 20175	High CH 20350		Low CH 20000	Mid CH 20175	High CH 20350	
			1715.0 MHz	1732.5 MHz	1750.0 MHz		1715.0 MHz	1732.5 MHz	1750.0 MHz	
EUT without Power Reduction (P-Sensor NOT Triggered)										
4 / 10M	1	0	22.47	22.54	22.59	0	21.51	21.59	21.63	1
	1	24	22.56	22.66	22.68	0	21.57	21.70	21.73	1
	1	49	22.26	22.33	22.45	0	21.26	21.36	21.47	1
	25	0	21.16	21.23	21.28	1	20.10	20.23	20.27	2
	25	12	21.22	21.29	21.34	1	20.14	20.30	20.34	2
	25	25	21.12	21.20	21.25	1	20.08	20.18	20.25	2
	50	0	21.25	21.37	21.40	1	20.23	20.35	20.40	2
EUT with Power Reduction (P-Sensor Triggered)										
4 / 10M	1	0	19.35	19.38	19.41	0	19.31	19.34	19.37	0
	1	24	19.56	19.60	19.62	0	19.52	19.56	19.58	0
	1	49	19.19	19.25	19.30	0	19.15	19.21	19.26	0
	25	0	19.18	19.22	19.28	1	19.14	19.18	19.24	1
	25	12	19.28	19.32	19.35	1	19.24	19.28	19.31	1
	25	25	19.19	19.25	19.30	1	19.15	19.21	19.26	1
		50	0	19.32	19.35	19.38	1	19.28	19.31	19.34

Band / BW	RB Size	RB Offset	QPSK			3GPP MPR (dB)	16QAM			3GPP MPR (dB)
			Low CH 20025	Mid CH 20175	High CH 20325		Low CH 20025	Mid CH 20175	High CH 20325	
			1717.5 MHz	1732.5 MHz	1747.5 MHz		1717.5 MHz	1732.5 MHz	1747.5 MHz	
EUT without Power Reduction (P-Sensor NOT Triggered)										
4 / 15M	1	0	22.52	22.59	22.62	0	21.57	21.65	21.70	1
	1	37	22.60	22.69	22.72	0	21.70	21.76	21.78	1
	1	74	22.26	22.39	22.43	0	21.31	21.43	21.55	1
	36	0	21.29	21.36	21.39	1	20.26	20.38	20.41	2
	36	19	21.31	21.40	21.43	1	20.31	20.40	20.43	2
	36	39	21.27	21.33	21.40	1	20.23	20.34	20.36	2
		75	0	21.33	21.44	21.47	1	20.31	20.45	20.50
EUT with Power Reduction (P-Sensor Triggered)										
4 / 15M	1	0	19.44	19.47	19.49	0	19.40	19.43	19.45	0
	1	37	19.61	19.67	19.69	0	19.57	19.63	19.65	0
	1	74	19.32	19.36	19.40	0	19.28	19.32	19.36	0
	36	0	19.31	19.34	19.37	1	19.27	19.30	19.33	1
	36	19	19.36	19.41	19.44	1	19.32	19.37	19.40	1
	36	39	19.32	19.36	19.40	1	19.28	19.32	19.36	1
		75	0	19.41	19.44	19.47	1	19.37	19.40	19.43

Band / BW	RB Size	RB Offset	QPSK			3GPP MPR (dB)	16QAM			3GPP MPR (dB)
			Low CH 20050	Mid CH 20175	High CH 20300		Low CH 20050	Mid CH 20175	High CH 20300	
			1720.0 MHz	1732.5 MHz	1745.0 MHz		1720.0 MHz	1732.5 MHz	1745.0 MHz	
EUT without Power Reduction (P-Sensor NOT Triggered)										
4 / 20M	1	0	22.61	22.67	22.70	0	21.62	21.70	21.75	1
	1	50	22.67	22.76	22.79	0	21.68	21.81	21.83	1
	1	99	22.41	22.49	22.59	0	21.42	21.49	21.51	1
	50	0	21.44	21.50	21.53	1	20.39	20.47	20.51	2
	50	25	21.47	21.52	21.55	1	20.45	20.50	20.53	2
	50	50	21.43	21.48	21.51	1	20.37	20.45	20.50	2
	100	0	21.50	21.55	21.58	1	20.43	20.54	20.57	2
EUT with Power Reduction (P-Sensor Triggered)										
4 / 20M	1	0	19.52	19.53	19.56	0	19.50	19.51	19.54	0
	1	50	19.67	19.74	19.76	0	19.65	19.72	19.74	0
	1	99	19.46	19.47	19.51	0	19.44	19.45	19.49	0
	50	0	19.45	19.46	19.49	1	19.43	19.44	19.47	1
	50	25	19.53	19.54	19.57	1	19.51	19.52	19.55	1
	50	50	19.46	19.47	19.51	1	19.44	19.45	19.49	1
	100	0	19.50	19.51	19.53	1	19.48	19.49	19.51	1

Band / BW	RB Size	RB Offset	QPSK			3GPP MPR (dB)	16QAM			3GPP MPR (dB)
			Low CH 20407	Mid CH 20525	High CH 20643		Low CH 20407	Mid CH 20525	High CH 20643	
			824.7 MHz	836.5 MHz	848.3 MHz		824.7 MHz	836.5 MHz	848.3 MHz	
EUT without Power Reduction (P-Sensor NOT Triggered)										
5 / 1.4M	1	0	22.13	22.44	22.27	0	21.16	21.49	21.26	1
	1	2	22.08	22.38	22.20	0	21.08	21.42	21.20	1
	1	5	22.02	22.36	22.16	0	21.01	21.37	21.11	1
	3	0	22.08	22.10	22.05	0	21.07	21.09	21.04	3
	3	1	22.06	22.07	22.03	0	21.05	21.06	21.02	3
	3	3	22.02	22.05	22.01	0	21.01	21.04	21.01	3
	6	0	21.01	21.04	21.03	1	20.01	20.03	20.02	6
EUT with Power Reduction (P-Sensor Triggered)										
5 / 1.4M	1	0	20.95	20.96	20.77	0	20.94	20.95	20.76	0
	1	2	20.82	20.84	20.61	0	20.81	20.83	20.60	0
	1	5	20.75	20.77	20.56	0	20.74	20.76	20.55	0
	3	0	20.84	20.87	20.69	0	20.83	20.86	20.68	0
	3	1	20.78	20.80	20.58	0	20.77	20.79	20.57	0
	3	3	20.69	20.75	20.51	0	20.68	20.74	20.50	0
	6	0	20.57	20.60	20.43	1	20.56	20.59	20.42	1



FCC SAR Test Report

A D T

Band / BW	RB Size	RB Offset	QPSK			3GPP MPR (dB)	16QAM			3GPP MPR (dB)
			Low CH 20415	Mid CH 20525	High CH 20635		Low CH 20415	Mid CH 20525	High CH 20635	
			825.5 MHz	836.5 MHz	847.5 MHz		825.5 MHz	836.5 MHz	847.5 MHz	
EUT without Power Reduction (P-Sensor NOT Triggered)										
5 / 3M	1	0	22.21	22.50	22.32	0	21.24	21.55	21.34	1
	1	7	22.18	22.45	22.27	0	21.17	21.47	21.29	1
	1	14	22.07	22.43	22.24	0	21.10	21.45	21.21	1
	8	0	21.19	21.33	21.21	1	20.18	20.30	20.20	2
	8	3	21.08	21.28	21.18	1	20.07	20.25	20.17	2
	8	7	21.03	21.10	21.05	1	20.02	20.01	20.04	2
15	0	21.01	21.15	21.05	1	20.01	20.10	20.04	2	
EUT with Power Reduction (P-Sensor Triggered)										
5 / 3M	1	0	21.02	21.03	20.85	0	21.00	21.01	20.83	0
	1	7	20.89	20.92	20.74	0	20.87	20.90	20.72	0
	1	14	20.82	20.85	20.66	0	20.80	20.83	20.64	0
	8	0	20.91	20.94	20.78	1	20.89	20.92	20.76	1
	8	3	20.87	20.89	20.71	1	20.85	20.87	20.69	1
	8	7	20.77	20.84	20.63	1	20.75	20.82	20.61	1
15	0	20.64	20.71	20.53	1	20.62	20.69	20.51	1	

Band / BW	RB Size	RB Offset	QPSK			3GPP MPR (dB)	16QAM			3GPP MPR (dB)
			Low CH 20425	Mid CH 20525	High CH 20625		Low CH 20425	Mid CH 20525	High CH 20625	
			826.5 MHz	836.5 MHz	846.5 MHz		826.5 MHz	836.5 MHz	846.5 MHz	
EUT without Power Reduction (P-Sensor NOT Triggered)										
5 / 5M	1	0	22.31	22.55	22.39	0	21.33	21.59	21.42	1
	1	12	22.25	22.50	22.34	0	21.28	21.54	21.36	1
	1	24	22.15	22.49	22.30	0	21.25	21.52	21.34	1
	12	0	21.20	21.43	21.31	1	20.16	20.45	20.35	2
	12	6	21.03	21.40	21.19	1	20.05	20.42	20.23	2
	12	13	21.02	21.16	21.04	1	20.01	20.19	20.06	2
25	0	21.01	21.24	21.14	1	20.02	20.27	20.10	2	
EUT with Power Reduction (P-Sensor Triggered)										
5 / 5M	1	0	21.09	21.10	20.92	0	21.06	21.07	20.89	0
	1	12	20.96	20.98	20.81	0	20.93	20.95	20.78	0
	1	24	20.91	20.92	20.77	0	20.88	20.89	20.74	0
	12	0	20.98	21.01	20.87	1	20.95	20.98	20.84	1
	12	6	20.94	20.96	20.78	1	20.91	20.93	20.75	1
	12	13	20.88	20.91	20.72	1	20.85	20.88	20.69	1
25	0	20.77	20.79	20.66	1	20.74	20.76	20.63	1	



FCC SAR Test Report

A D T

Band / BW	RB Size	RB Offset	QPSK			3GPP MPR (dB)	16QAM			3GPP MPR (dB)
			Low CH 20450	Mid CH 20525	High CH 20600		Low CH 20450	Mid CH 20525	High CH 20600	
			829.0 MHz	836.5 MHz	844.0 MHz		829.0 MHz	836.5 MHz	844.0 MHz	
EUT without Power Reduction (P-Sensor NOT Triggered)										
5 / 10M	1	0	22.37	22.60	22.45	0	21.36	21.65	21.46	1
	1	24	22.32	22.55	22.42	0	21.32	21.60	21.42	1
	1	49	22.27	22.54	22.39	0	21.28	21.57	21.38	1
	25	0	21.30	21.51	21.43	1	20.25	20.50	20.42	2
	25	12	21.26	21.48	21.32	1	20.21	20.47	20.30	2
	25	25	21.08	21.29	21.12	1	20.02	20.26	20.07	2
	50	0	21.09	21.35	21.22	1	20.11	20.33	20.21	2
EUT with Power Reduction (P-Sensor Triggered)										
5 / 10M	1	0	21.16	21.17	21.01	0	21.14	21.15	20.99	0
	1	24	21.04	21.06	20.91	0	21.02	21.04	20.89	0
	1	49	21.00	21.01	20.87	0	20.98	20.99	20.85	0
	25	0	21.07	21.08	20.93	1	21.05	21.06	20.91	1
	25	12	21.02	21.04	20.88	1	21.00	21.02	20.86	1
	25	25	20.98	21.00	20.85	1	20.96	20.98	20.83	1
	50	0	20.85	20.89	20.77	1	20.83	20.87	20.75	1

Band / BW	RB Size	RB Offset	QPSK			3GPP MPR (dB)	16QAM			3GPP MPR (dB)
			Low CH 23205	Mid CH 23230	High CH 23255		Low CH 23205	Mid CH 23230	High CH 23255	
			779.5 MHz	782.0 MHz	784.5 MHz		779.5 MHz	782.0 MHz	784.5 MHz	
EUT without Power Reduction (P-Sensor NOT Triggered)										
13 / 5M	1	0	23.03	23.05	22.92	0	22.05	22.09	21.94	1
	1	12	22.54	22.58	22.41	0	21.57	21.59	21.45	1
	1	24	22.43	22.44	22.35	0	21.41	21.44	21.24	1
	12	0	21.39	21.45	21.30	1	20.38	20.46	20.33	2
	12	6	21.24	21.30	21.19	1	20.24	20.28	20.11	2
	12	13	21.38	21.40	21.25	1	20.41	20.43	20.28	2
	25	0	21.31	21.36	21.23	1	20.31	20.36	20.16	2
EUT with Power Reduction (P-Sensor Triggered)										
13 / 5M	1	0	20.85	20.97	20.94	0	20.83	20.95	20.92	0
	1	12	20.79	20.93	20.91	0	20.77	20.91	20.89	0
	1	24	20.74	20.86	20.82	0	20.72	20.84	20.80	0
	12	0	20.81	20.95	20.92	1	20.79	20.93	20.90	1
	12	6	20.78	20.91	20.86	1	20.76	20.89	20.84	1
	12	13	20.73	20.84	20.79	1	20.71	20.82	20.77	1
	25	0	20.69	20.80	20.76	1	20.67	20.78	20.74	1



FCC SAR Test Report

A D T

Band / BW	RB Size	RB Offset	QPSK		3GPP MPR (dB)	16QAM		3GPP MPR (dB)
			Mid CH 23230	782.0 MHz		Mid CH 23230	782.0 MHz	
EUT without Power Reduction (P-Sensor NOT Triggered)								
13 / 10M	1	0	23.10		0	22.15		1
	1	24	22.64		0	21.67		1
	1	49	22.50		0	21.51		1
	25	0	21.54		1	20.54		2
	25	12	21.43		1	20.40		2
	25	25	21.51		1	20.51		2
	50	0	21.48		1	20.46		2
EUT with Power Reduction (P-Sensor Triggered)								
13 / 10M	1	0	21.04		0	21.03		0
	1	24	21.00		0	20.99		0
	1	49	20.94		0	20.93		0
	25	0	21.02		1	21.01		1
	25	12	20.98		1	20.97		1
	25	25	20.92		1	20.91		1
	50	0	20.89		1	20.88		1

Band / BW	RB Size	RB Offset	QPSK			3GPP MPR (dB)	16QAM			3GPP MPR (dB)
			Low CH 23755 706.5 MHz	Mid CH 23790 710.0 MHz	High CH 23825 713.5 MHz		Low CH 23755 706.5 MHz	Mid CH 23790 710.0 MHz	High CH 23825 713.5 MHz	
EUT without Power Reduction (P-Sensor NOT Triggered)										
17 / 5M	1	0	22.32	22.35	22.47	0	21.34	21.37	21.51	1
	1	12	22.57	22.60	22.69	0	21.62	21.65	21.75	1
	1	24	22.51	22.53	22.63	0	21.49	21.57	21.67	1
	12	0	21.35	21.37	21.49	1	20.32	20.34	20.50	2
	12	6	21.46	21.48	21.58	1	20.44	20.48	20.58	2
	12	13	21.28	21.33	21.51	1	20.22	20.30	20.41	2
	25	0	21.22	21.24	21.39	1	20.18	20.20	20.28	2
EUT with Power Reduction (P-Sensor Triggered)										
17 / 5M	1	0	21.34	21.50	21.54	0	21.30	21.46	21.50	0
	1	12	21.56	21.69	21.71	0	21.52	21.65	21.67	0
	1	24	21.32	21.45	21.51	0	21.28	21.41	21.47	0
	12	0	21.29	21.44	21.47	1	21.25	21.40	21.43	1
	12	6	21.47	21.65	21.68	1	21.43	21.61	21.64	1
	12	13	21.32	21.47	21.52	1	21.28	21.43	21.48	1
	25	0	21.27	21.42	21.46	1	21.23	21.38	21.42	1



FCC SAR Test Report

A D T

Band / BW	RB Size	RB Offset	QPSK			3GPP MPR (dB)	16QAM			3GPP MPR (dB)
			Low CH 23780	Mid CH 23790	High CH 23800		Low CH 23780	Mid CH 23790	High CH 23800	
			709.0 MHz	710.0 MHz	711.0 MHz		709.0 MHz	710.0 MHz	711.0 MHz	
EUT without Power Reduction (P-Sensor NOT Triggered)										
17 / 10M	1	0	22.41	22.43	22.54	0	21.42	21.44	21.56	1
	1	24	22.61	22.65	22.76	0	21.65	21.70	21.79	1
	1	49	22.57	22.59	22.69	0	21.57	21.63	21.75	1
	25	0	21.47	21.49	21.56	1	20.43	20.47	20.64	2
	25	12	21.54	21.58	21.65	1	20.54	20.58	20.69	2
	25	25	21.41	21.46	21.54	1	20.37	20.42	20.54	2
	50	0	21.36	21.38	21.46	1	20.31	20.33	20.45	2
EUT with Power Reduction (P-Sensor Triggered)										
17 / 10M	1	0	21.44	21.58	21.61	0	21.41	21.55	21.58	0
	1	24	21.60	21.76	21.79	0	21.57	21.73	21.76	0
	1	49	21.40	21.54	21.59	0	21.37	21.51	21.56	0
	25	0	21.39	21.53	21.55	1	21.36	21.50	21.52	1
	25	12	21.57	21.72	21.74	1	21.54	21.69	21.71	1
	25	25	21.43	21.55	21.59	1	21.40	21.52	21.56	1
		50	0	21.38	21.51	21.54	1	21.35	21.48	21.51

Band / BW	RB Size	RB Offset	QPSK			3GPP MPR (dB)	16QAM			3GPP MPR (dB)
			Low CH 26047	Mid CH 26365	High CH 26683		Low CH 26047	Mid CH 26365	High CH 26683	
			1850.7 MHz	1882.5 MHz	1914.3 MHz		1850.7 MHz	1882.5 MHz	1914.3 MHz	
EUT without Power Reduction (P-Sensor NOT Triggered)										
25 / 1.4M	1	0	22.73	22.67	22.32	0	21.76	21.69	21.36	1
	1	2	22.55	22.51	22.20	0	21.58	21.51	21.21	1
	1	5	22.45	22.37	22.08	0	21.51	21.43	21.02	1
	3	0	22.16	22.05	22.03	0	21.15	21.04	21.03	1
	3	1	22.08	22.04	22.02	0	21.07	21.03	21.02	1
	3	3	22.03	22.02	22.01	0	21.03	21.02	21.01	1
		6	0	21.41	21.32	21.01	1	20.33	20.24	20.01
EUT with Power Reduction (P-Sensor Triggered)										
25 / 1.4M	1	0	17.88	17.85	17.74	0	17.86	17.83	17.72	0
	1	2	17.85	17.83	17.71	0	17.83	17.81	17.69	0
	1	5	17.77	17.74	17.60	0	17.75	17.72	17.58	0
	3	0	17.84	17.81	17.66	0	17.82	17.79	17.64	0
	3	1	17.74	17.66	17.53	0	17.72	17.64	17.51	0
	3	3	17.64	17.59	17.51	0	17.62	17.57	17.49	0
		6	0	17.56	17.51	17.45	1	17.54	17.49	17.43

Band / BW	RB Size	RB Offset	QPSK			3GPP MPR (dB)	16QAM			3GPP MPR (dB)
			Low CH 26055	Mid CH 26365	High CH 26675		Low CH 26055	Mid CH 26365	High CH 26675	
			1851.5 MHz	1882.5 MHz	1913.5 MHz		1851.5 MHz	1882.5 MHz	1913.5 MHz	
EUT without Power Reduction (P-Sensor NOT Triggered)										
25 / 3M	1	0	22.78	22.75	22.42	0	21.83	21.77	21.42	1
	1	7	22.66	22.57	22.26	0	21.66	21.60	21.31	1
	1	14	22.50	22.47	22.15	0	21.55	21.48	21.14	1
	8	0	21.22	21.17	21.07	1	20.32	20.11	20.05	2
	8	3	21.17	21.11	21.04	1	20.16	20.08	20.04	2
	8	7	21.08	21.07	21.02	1	20.07	20.06	20.03	2
	15	0	21.11	21.08	21.06	1	20.08	20.07	20.06	2
EUT with Power Reduction (P-Sensor Triggered)										
25 / 3M	1	0	17.95	17.90	17.78	0	17.94	17.89	17.77	0
	1	7	17.93	17.87	17.75	0	17.92	17.86	17.74	0
	1	14	17.86	17.78	17.68	0	17.85	17.77	17.67	0
	8	0	17.89	17.82	17.71	1	17.88	17.81	17.70	1
	8	3	17.79	17.71	17.63	1	17.78	17.70	17.62	1
	8	7	17.72	17.67	17.59	1	17.71	17.66	17.58	1
	15	0	17.66	17.62	17.54	1	17.65	17.61	17.53	1

Band / BW	RB Size	RB Offset	QPSK			3GPP MPR (dB)	16QAM			3GPP MPR (dB)
			Low CH 26065	Mid CH 26365	High CH 26665		Low CH 26065	Mid CH 26365	High CH 26665	
			1852.5 MHz	1882.5 MHz	1912.5 MHz		1852.5 MHz	1882.5 MHz	1912.5 MHz	
EUT without Power Reduction (P-Sensor NOT Triggered)										
25 / 5M	1	0	22.82	22.79	22.51	0	21.88	21.82	21.53	1
	1	12	22.74	22.65	22.38	0	21.75	21.67	21.44	1
	1	24	22.61	22.57	22.27	0	21.64	21.58	21.30	1
	12	0	21.41	21.28	21.05	1	20.41	20.30	20.05	2
	12	6	21.28	21.23	21.08	1	20.26	20.21	20.07	2
	12	13	21.09	21.05	21.03	1	20.13	20.04	20.02	2
	25	0	21.23	21.18	21.11	1	20.23	20.16	20.10	2
EUT with Power Reduction (P-Sensor Triggered)										
25 / 5M	1	0	18.02	17.98	17.89	0	18.00	17.96	17.87	0
	1	12	18.00	17.96	17.84	0	17.98	17.94	17.82	0
	1	24	17.92	17.89	17.79	0	17.90	17.87	17.77	0
	12	0	17.96	17.92	17.81	1	17.94	17.90	17.79	1
	12	6	17.90	17.81	17.70	1	17.88	17.79	17.68	1
	12	13	17.81	17.76	17.68	1	17.79	17.74	17.66	1
	25	0	17.74	17.72	17.65	1	17.72	17.70	17.63	1



FCC SAR Test Report

A D T

Band / BW	RB Size	RB Offset	QPSK			3GPP MPR (dB)	16QAM			3GPP MPR (dB)
			Low CH 26090	Mid CH 26365	High CH 26640		Low CH 26090	Mid CH 26365	High CH 26640	
			1855.0 MHz	1882.5 MHz	1910.0 MHz		1855.0 MHz	1882.5 MHz	1910.0 MHz	
EUT without Power Reduction (P-Sensor NOT Triggered)										
25 / 10M	1	0	22.88	22.85	22.61	0	21.93	21.89	21.60	1
	1	24	22.80	22.70	22.54	0	21.77	21.74	21.52	1
	1	49	22.71	22.65	22.41	0	21.70	21.66	21.37	1
	25	0	21.44	21.37	21.13	1	20.45	20.38	20.13	2
	25	12	21.39	21.34	21.07	1	20.42	20.34	20.06	2
	25	25	21.20	21.17	21.05	1	20.21	20.15	20.04	2
	50	0	21.34	21.29	21.10	1	20.35	20.29	20.11	2
EUT with Power Reduction (P-Sensor Triggered)										
25 / 10M	1	0	18.09	18.06	17.98	0	18.08	18.05	17.97	0
	1	24	18.07	18.04	17.93	0	18.06	18.03	17.92	0
	1	49	18.02	17.98	17.89	0	18.01	17.97	17.88	0
	25	0	18.05	18.02	17.91	1	18.04	18.01	17.90	1
	25	12	17.96	17.91	17.85	1	17.95	17.90	17.84	1
	25	25	17.92	17.86	17.79	1	17.91	17.85	17.78	1
	50	0	17.87	17.81	17.74	1	17.86	17.80	17.73	1

Band / BW	RB Size	RB Offset	QPSK			3GPP MPR (dB)	16QAM			3GPP MPR (dB)
			Low CH 26115	Mid CH 26365	High CH 26615		Low CH 26115	Mid CH 26365	High CH 26615	
			1857.5 MHz	1882.5 MHz	1907.5 MHz		1857.5 MHz	1882.5 MHz	1907.5 MHz	
EUT without Power Reduction (P-Sensor NOT Triggered)										
25 / 15M	1	0	22.93	22.90	22.69	0	21.97	21.94	21.71	1
	1	37	22.84	22.77	22.58	0	21.83	21.80	21.65	1
	1	74	22.77	22.73	22.41	0	21.79	21.76	21.46	1
	36	0	21.57	21.50	21.26	1	20.61	20.50	20.23	2
	36	19	21.48	21.45	21.15	1	20.51	20.46	20.13	2
	36	39	21.40	21.29	21.12	1	20.37	20.29	20.05	2
	75	0	21.45	21.43	21.14	1	20.46	20.41	20.16	2
EUT with Power Reduction (P-Sensor Triggered)										
25 / 15M	1	0	18.16	18.13	18.05	0	18.13	18.10	18.02	0
	1	37	18.14	18.11	18.00	0	18.11	18.08	17.97	0
	1	74	18.07	18.05	17.98	0	18.04	18.02	17.95	0
	36	0	18.11	18.08	17.99	1	18.08	18.05	17.96	1
	36	19	18.03	17.99	17.94	1	18.00	17.96	17.91	1
	36	39	17.98	17.95	17.87	1	17.95	17.92	17.84	1
	75	0	17.94	17.91	17.85	1	17.91	17.88	17.82	1



FCC SAR Test Report

A D T

Band / BW	RB Size	RB Offset	QPSK			3GPP MPR (dB)	16QAM			3GPP MPR (dB)
			Low CH 26140	Mid CH 26365	High CH 26590		Low CH 26140	Mid CH 26365	High CH 26590	
			1860.0 MHz	1882.5 MHz	1905.0 MHz		1860.0 MHz	1882.5 MHz	1905.0 MHz	
EUT without Power Reduction (P-Sensor NOT Triggered)										
25 / 20M	1	0	22.98	22.95	22.75	0	22.00	21.99	21.77	1
	1	50	22.88	22.83	22.65	0	21.92	21.86	21.70	1
	1	99	22.81	22.79	22.55	0	21.83	21.81	21.58	1
	50	0	21.61	21.59	21.40	1	20.68	20.59	20.44	2
	50	25	21.58	21.56	21.37	1	20.59	20.55	20.28	2
	50	50	21.46	21.43	21.23	1	20.44	20.41	20.23	2
	100	0	21.56	21.54	21.35	1	20.55	20.53	20.32	2
EUT with Power Reduction (P-Sensor Triggered)										
25 / 20M	1	0	18.23	18.20	18.13	0	18.20	18.17	18.10	0
	1	50	18.21	18.18	18.10	0	18.18	18.15	18.07	0
	1	99	18.17	18.13	18.07	0	18.14	18.10	18.04	0
	50	0	18.19	18.16	18.09	1	18.16	18.13	18.06	1
	50	25	18.12	18.08	18.03	1	18.09	18.05	18.00	1
	50	50	18.07	18.05	17.97	1	18.04	18.02	17.94	1
	100	0	18.03	18.01	17.94	1	18.00	17.98	17.91	1

4.7 SAR Testing Results

4.7.1 SAR Test Reduction Considerations

<KDB 447498 D01, General RF Exposure Guidance>

Testing of other required channels within the operating mode of a frequency band is not required when the reported SAR for the mid-band or highest output power channel is:

- (1) ≤ 0.8 W/kg or 2.0 W/kg, for 1-g or 10-g respectively, when the transmission band is ≤ 100 MHz
- (2) ≤ 0.6 W/kg or 1.5 W/kg, for 1-g or 10-g respectively, when the transmission band is between 100 MHz and 200 MHz
- (3) ≤ 0.4 W/kg or 1.0 W/kg, for 1-g or 10-g respectively, when the transmission band is ≥ 200 MHz

<KDB 941225 D01, 3G SAR Measurement Procedures>

The mode tested for SAR is referred to as the primary mode. The equivalent modes considered for SAR test reduction are denoted as secondary modes. Both primary and secondary modes must be in the same frequency band. When the maximum output power and tune-up tolerance specified for production units in a secondary mode is $\leq 1/4$ dB higher than the primary mode or when the highest reported SAR of the primary mode is scaled by the ratio of specified maximum output power and tune-up tolerance of secondary to primary mode and the adjusted SAR is ≤ 1.2 W/kg, SAR measurement is not required for the secondary mode.

<KDB 941225 D05, SAR Evaluation Considerations for LTE Devices>

- (1) QPSK with 1 RB and 50% RB allocation

Start with the largest channel bandwidth and measure SAR, using the RB offset and required test channel combination with the highest maximum output power among RB offsets at the upper edge, middle and lower edge of each required test channel. When the reported SAR is ≤ 0.8 W/kg, testing of the remaining RB offset configurations and required test channels is not required; otherwise, SAR is required for the remaining required test channels and only for the RB offset configuration with the highest output power for that channel. When the reported SAR of a required test channel is > 1.45 W/kg, SAR is required for all three RB offset configurations for that required test channel.

- (2) QPSK with 100% RB allocation

SAR is not required when the highest maximum output power for 100% RB allocation is less than the highest maximum output power in 50% and 1 RB allocations and the highest reported SAR for 1 RB and 50% RB allocation are ≤ 0.8 W/kg. Otherwise, SAR is measured for the highest output power channel; and if the reported SAR is > 1.45 W/kg, the remaining required test channels must also be tested.

- (3) Higher order modulations

SAR is required only when the highest maximum output power for the configuration in the higher order modulation is $> 1/2$ dB higher than the same configuration in QPSK or when the reported SAR for the QPSK configuration is > 1.45 W/kg.

- (4) Other channel bandwidth

SAR is required when the highest maximum output power of the smaller channel bandwidth is $> 1/2$ dB higher than the equivalent channel configurations in the largest channel bandwidth configuration or the reported SAR of a configuration for the largest channel bandwidth is > 1.45 W/kg.



FCC SAR Test Report

4.7.2 SAR Results for Body Exposure Condition

<Tablet PC>

Plot No.	Band	Mode	Test Position	Separation Distance (cm)	Ch.	Power Reduction	Max. Tune-up Power (dBm)	Measured Conducted Power (dBm)	Scaling Factor	Power Drift (dB)	Measured SAR-1g (W/kg)	Scaled SAR-1g (W/kg)
	GSM850	GPRS10	Rear Face	0	128	w/	29.0	27.98	1.26	-0.17	0.481	0.61
	GSM850	GPRS10	Rear Face	0.6	251	w/o	33.0	31.58	1.39	-0.05	0.629	0.87
	GSM850	GPRS10	Rear Face	0.6	128	w/o	33.0	31.44	1.43	0.1	0.407	0.58
	GSM850	GPRS10	Rear Face	0.6	189	w/o	33.0	31.35	1.46	0.05	0.452	0.66
	GSM850	GPRS10	Left Side	0	251	w/o	33.0	31.58	1.39	0.07	0.022	0.03
	GSM850	GPRS10	Right Side	0	251	w/o	33.0	31.58	1.39	0.13	0.366	0.51
	GSM850	GPRS10	Top Side	0	251	w/o	33.0	31.58	1.39	-0.11	0.084	0.12
	GSM850	GPRS10	Bottom Side	0	128	w/	29.0	27.98	1.26	0.1	0.782	0.99
	GSM850	GPRS10	Bottom Side	0	189	w/	29.0	27.90	1.29	0.12	0.826	1.06
01	GSM850	GPRS10	Bottom Side	0	251	w/	29.0	27.85	1.30	0.17	0.829	1.08
	GSM850	GPRS10	Bottom Side	0	251	w/	29.0	27.85	1.30	0.02	0.801	1.04
	GSM850	GPRS10	Bottom Side	1	251	w/o	33.0	31.58	1.39	0.09	0.529	0.73
	GSM1900	GPRS10	Rear Face	0	810	w/	26.5	24.79	1.48	0.15	0.505	0.75
	GSM1900	GPRS10	Rear Face	0.6	810	w/o	30.0	28.86	1.30	0.1	0.333	0.43
	GSM1900	GPRS10	Right Side	0	810	w/o	30.0	28.86	1.30	0.11	0.136	0.18
02	GSM1900	GPRS10	Bottom Side	0	810	w/	26.5	24.79	1.48	0.15	0.835	1.24
	GSM1900	GPRS10	Bottom Side	0	810	w/	26.5	24.79	1.48	0.11	0.806	1.19
	GSM1900	GPRS10	Bottom Side	0	512	w/	26.5	24.71	1.51	-0.01	0.622	0.94
	GSM1900	GPRS10	Bottom Side	0	661	w/	26.5	24.77	1.49	0.06	0.769	1.15
	GSM1900	GPRS10	Bottom Side	1	810	w/o	30.0	28.86	1.30	0.02	0.275	0.36
	WCDMA II	RMC12.2K	Rear Face	0	9538	w/	20.0	19.02	1.25	0.01	0.519	0.65
	WCDMA II	RMC12.2K	Rear Face	0.6	9538	w/o	24.0	22.87	1.30	0.03	0.287	0.37
	WCDMA II	RMC12.2K	Right Side	0	9538	w/o	24.0	22.87	1.30	0.07	0.122	0.16
	WCDMA II	RMC12.2K	Bottom Side	0	9538	w/	20.0	19.02	1.25	0.03	0.785	0.98
03	WCDMA II	RMC12.2K	Bottom Side	0	9262	w/	20.0	18.80	1.32	-0.03	0.821	1.08
	WCDMA II	RMC12.2K	Bottom Side	0	9262	w/	20.0	18.80	1.32	0.04	0.796	1.05
	WCDMA II	RMC12.2K	Bottom Side	0	9400	w/	20.0	18.72	1.34	0.12	0.797	1.07
	WCDMA II	RMC12.2K	Bottom Side	1	9538	w/o	24.0	22.87	1.30	0.01	0.209	0.27
	WCDMA IV	RMC12.2K	Rear Face	0	1513	w/	20.0	18.31	1.48	-0.16	0.266	0.39
	WCDMA IV	RMC12.2K	Rear Face	0.6	1513	w/o	24.0	22.39	1.45	-0.09	0.216	0.31
	WCDMA IV	RMC12.2K	Right Side	0	1513	w/o	24.0	22.39	1.45	0.04	0.042	0.06
	WCDMA IV	RMC12.2K	Bottom Side	0	1513	w/	20.0	18.31	1.48	0.02	0.650	0.96
	WCDMA IV	RMC12.2K	Bottom Side	0	1312	w/	20.0	18.14	1.53	0.06	0.640	0.98
04	WCDMA IV	RMC12.2K	Bottom Side	0	1413	w/	20.0	18.30	1.48	0.06	0.669	0.99
	WCDMA IV	RMC12.2K	Bottom Side	1	1513	w/o	24.0	22.39	1.45	0.02	0.187	0.27
	WCDMA V	RMC12.2K	Rear Face	0	4182	w/	22.0	21.01	1.26	0.05	0.407	0.51
	WCDMA V	RMC12.2K	Rear Face	0.6	4233	w/o	24.0	22.33	1.47	0.06	0.345	0.51
	WCDMA V	RMC12.2K	Left Side	0	4233	w/o	24.0	22.33	1.47	0.17	0.007	0.01
	WCDMA V	RMC12.2K	Right Side	0	4233	w/o	24.0	22.33	1.47	0.04	0.011	0.02
	WCDMA V	RMC12.2K	Top Side	0	4233	w/o	24.0	22.33	1.47	-0.12	0.049	0.07
	WCDMA V	RMC12.2K	Bottom Side	0	4182	w/	22.0	21.01	1.26	0.05	0.703	0.88
05	WCDMA V	RMC12.2K	Bottom Side	0	4132	w/	22.0	20.93	1.28	0.12	0.695	0.89
	WCDMA V	RMC12.2K	Bottom Side	0	4233	w/	22.0	20.87	1.30	0.09	0.680	0.88
	WCDMA V	RMC12.2K	Bottom Side	1	4233	w/o	24.0	22.33	1.47	0.16	0.310	0.46



FCC SAR Test Report

Plot No.	Band	Mode	Test Position	Separation Distance (cm)	Ch.	Power Reduction	Max. Tune-up Power (dBm)	Measured Conducted Power (dBm)	Scaling Factor	Power Drift (dB)	Measured SAR-1g (W/kg)	Scaled SAR-1g (W/kg)
	CDMA2000 BC0	RTAP 153.6	Rear Face	0	384	w/	22.0	20.96	1.27	0.12	0.490	0.62
	CDMA2000 BC0	RTAP 153.6	Rear Face	0.6	384	w/o	24.5	22.91	1.44	-0.07	0.382	0.55
	CDMA2000 BC0	RTAP 153.6	Left Side	0	384	w/o	24.5	22.91	1.44	-0.1	0.046	0.07
	CDMA2000 BC0	RTAP 153.6	Right Side	0	384	w/o	24.5	22.91	1.44	0.01	0.244	0.35
	CDMA2000 BC0	RTAP 153.6	Top Side	0	384	w/o	24.5	22.91	1.44	-0.01	0.016	0.02
	CDMA2000 BC0	RTAP 153.6	Bottom Side	0	384	w/	22.0	20.96	1.27	0.12	0.761	0.97
06	CDMA2000 BC0	RTAP 153.6	Bottom Side	0	1013	w/	22.0	20.86	1.30	0.13	0.773	1.01
	CDMA2000 BC0	RTAP 153.6	Bottom Side	0	777	w/	22.0	20.77	1.33	0.1	0.735	0.98
	CDMA2000 BC0	RTAP 153.6	Bottom Side	1	384	w/o	24.5	22.91	1.44	0.08	0.371	0.54
	CDMA2000 BC1	RTAP 153.6	Rear Face	0	600	w/	19.5	18.79	1.18	0.13	0.514	0.61
	CDMA2000 BC1	RTAP 153.6	Rear Face	0.6	600	w/o	24.5	23.20	1.35	0.06	0.319	0.43
	CDMA2000 BC1	RTAP 153.6	Left Side	0	600	w/o	24.5	23.20	1.35	-0.04	0.048	0.06
	CDMA2000 BC1	RTAP 153.6	Right Side	0	600	w/o	24.5	23.20	1.35	0.03	0.14	0.19
	CDMA2000 BC1	RTAP 153.6	Top Side	0	600	w/o	24.5	23.20	1.35	0.01	0.013	0.02
	CDMA2000 BC1	RTAP 153.6	Bottom Side	0	600	w/	19.5	18.79	1.18	0.02	0.856	1.01
07	CDMA2000 BC1	RTAP 153.6	Bottom Side	0	25	w/	19.5	18.66	1.21	0.06	0.901	1.09
	CDMA2000 BC1	RTAP 153.6	Bottom Side	0	25	w/	19.5	18.66	1.21	0.01	0.867	1.05
	CDMA2000 BC1	RTAP 153.6	Bottom Side	0	1175	w/	19.5	18.73	1.19	0.1	0.802	0.96
	CDMA2000 BC1	RTAP 153.6	Bottom Side	1	600	w/o	24.5	23.20	1.35	0.11	0.336	0.45
	CDMA2000 BC10	RTAP 153.6	Rear Face	0	580	w/	22.0	20.87	1.30	-0.02	0.416	0.54
	CDMA2000 BC10	RTAP 153.6	Rear Face	0.6	580	w/o	24.0	23.63	1.09	0.05	0.255	0.28
	CDMA2000 BC10	RTAP 153.6	Left Side	0	580	w/o	24.0	23.63	1.09	0.08	0.013	0.01
	CDMA2000 BC10	RTAP 153.6	Right Side	0	580	w/o	24.0	23.63	1.09	0.06	0.203	0.22
	CDMA2000 BC10	RTAP 153.6	Top Side	0	580	w/o	24.0	23.63	1.09	0.15	0.041	0.04
	CDMA2000 BC10	RTAP 153.6	Bottom Side	0	580	w/	22.0	20.87	1.30	0.08	0.737	0.96
	CDMA2000 BC10	RTAP 153.6	Bottom Side	0	476	w/	22.0	20.80	1.32	0.12	0.726	0.96
08	CDMA2000 BC10	RTAP 153.6	Bottom Side	0	684	w/	22.0	20.82	1.31	0.10	0.739	0.97
	CDMA2000 BC10	RTAP 153.6	Bottom Side	1	580	w/o	24.0	23.63	1.09	0.03	0.436	0.47



FCC SAR Test Report

A D T

Plot No.	Band	Mode	Test Position	Separation Distance (cm)	Ch.	Power Reduction	RB#	RB Offset	Max. Tune-up Power (dBm)	Measured Conducted Power (dBm)	Scaling Factor	Power Drift (dB)	Measured SAR-1g (W/kg)	Scaled SAR-1g (W/kg)
	LTE 2	QPSK20M	Rear Face	0	18900	w/	1	0	20.5	19.25	1.33	0.12	0.474	0.63
	LTE 2	QPSK20M	Rear Face	0	18900	w/	50	0	19.5	19.18	1.08	0.15	0.436	0.47
	LTE 2	QPSK20M	Rear Face	0.6	18900	w/o	1	0	24.0	23.06	1.24	-0.03	0.287	0.36
	LTE 2	QPSK20M	Rear Face	0.6	18900	w/o	50	0	23.0	21.67	1.36	-0.05	0.259	0.35
	LTE 2	QPSK20M	Right Side	0	18900	w/o	1	0	24.0	23.06	1.24	-0.01	0.146	0.18
	LTE 2	QPSK20M	Right Side	0	18900	w/o	50	0	23.0	21.67	1.36	-0.04	0.106	0.14
09	LTE 2	QPSK20M	Bottom Side	0	18900	w/	1	0	20.5	19.25	1.33	0.07	0.812	1.08
	LTE 2	QPSK20M	Bottom Side	0	18700	w/	1	0	20.5	19.16	1.36	0.11	0.757	1.03
	LTE 2	QPSK20M	Bottom Side	0	19100	w/	1	0	20.5	19.24	1.34	-0.08	0.686	0.92
	LTE 2	QPSK20M	Bottom Side	0	18900	w/	50	0	19.5	19.18	1.08	0.09	0.738	0.79
	LTE 2	QPSK20M	Bottom Side	0	18700	w/	50	0	19.5	19.09	1.10	0.04	0.961	1.06
	LTE 2	QPSK20M	Bottom Side	0	19100	w/	50	0	19.5	19.17	1.08	0.04	0.914	0.99
	LTE 2	QPSK20M	Bottom Side	0	18900	w/	100	0	19.5	19.14	1.09	0.01	0.968	1.05
	LTE 2	QPSK20M	Bottom Side	0	18900	w/	100	0	19.5	19.14	1.09	0.03	0.923	1.00
	LTE 2	QPSK20M	Bottom Side	1	18900	w/o	1	0	24.0	23.06	1.24	0.05	0.327	0.41
	LTE 2	QPSK20M	Bottom Side	1	18900	w/o	50	0	23.0	21.67	1.36	0.18	0.294	0.40
	LTE 4	QPSK20M	Rear Face	0	20300	w/	1	50	21.0	19.76	1.33	0.15	0.36	0.48
	LTE 4	QPSK20M	Rear Face	0	20300	w/	50	25	20.0	19.57	1.10	-0.01	0.351	0.39
	LTE 4	QPSK20M	Rear Face	0.6	20300	w/o	1	50	24.0	22.79	1.32	-0.09	0.24	0.32
	LTE 4	QPSK20M	Rear Face	0.6	20300	w/o	50	25	23.0	21.55	1.40	0.07	0.229	0.32
	LTE 4	QPSK20M	Right Side	0	20300	w/o	1	50	24.0	22.79	1.32	-0.02	0.055	0.07
	LTE 4	QPSK20M	Right Side	0	20300	w/o	50	25	23.0	21.55	1.40	-0.1	0.04	0.06
10	LTE 4	QPSK20M	Bottom Side	0	20300	w/	1	50	21.0	19.76	1.33	0	0.844	1.12
	LTE 4	QPSK20M	Bottom Side	0	20300	w/	1	50	21.0	19.76	1.33	0.01	0.778	1.04
	LTE 4	QPSK20M	Bottom Side	0	20050	w/	1	50	21.0	19.67	1.36	-0.03	0.764	1.04
	LTE 4	QPSK20M	Bottom Side	0	20175	w/	1	50	21.0	19.74	1.34	0.05	0.782	1.05
	LTE 4	QPSK20M	Bottom Side	0	20300	w/	50	25	20.0	19.57	1.10	0.02	0.791	0.87
	LTE 4	QPSK20M	Bottom Side	0	20050	w/	50	25	20.0	19.53	1.11	0.03	0.717	0.80
	LTE 4	QPSK20M	Bottom Side	0	20175	w/	50	25	20.0	19.54	1.11	0.02	0.734	0.82
	LTE 4	QPSK20M	Bottom Side	0	20300	w/	100	0	20.0	19.53	1.11	0	0.735	0.82
	LTE 4	QPSK20M	Bottom Side	1	20300	w/o	1	50	24.0	22.79	1.32	0.15	0.23	0.30
	LTE 4	QPSK20M	Bottom Side	1	20300	w/o	50	25	23.0	21.55	1.40	0.15	0.217	0.30
	LTE 5	QPSK10M	Rear Face	0	20525	w/	1	0	22.5	21.17	1.36	-0.16	0.504	0.68
	LTE 5	QPSK10M	Rear Face	0	20525	w/	25	0	21.5	21.08	1.10	0.09	0.507	0.56
	LTE 5	QPSK10M	Rear Face	0.6	20525	w/o	1	0	24.0	22.60	1.38	-0.14	0.293	0.40
	LTE 5	QPSK10M	Rear Face	0.6	20525	w/o	25	0	23.0	21.51	1.41	-0.08	0.237	0.33
	LTE 5	QPSK10M	Left Side	0	20525	w/o	1	0	24.0	22.60	1.38	-0.06	0.008	0.01
	LTE 5	QPSK10M	Left Side	0	20525	w/o	25	0	23.0	21.51	1.41	0.01	0.006	0.01
	LTE 5	QPSK10M	Right Side	0	20525	w/o	1	0	24.0	22.60	1.38	-0.01	0.193	0.27
	LTE 5	QPSK10M	Right Side	0	20525	w/o	25	0	23.0	21.51	1.41	-0.05	0.197	0.28
	LTE 5	QPSK10M	Top Side	0	20525	w/o	1	0	24.0	22.60	1.38	-0.03	0.043	0.06
	LTE 5	QPSK10M	Top Side	0	20525	w/o	25	0	23.0	21.51	1.41	0.04	0.033	0.05
	LTE 5	QPSK10M	Bottom Side	0	20525	w/	1	0	22.5	21.17	1.36	0.05	0.764	1.04
	LTE 5	QPSK10M	Bottom Side	0	20450	w/	1	0	22.5	21.16	1.36	0.15	0.788	1.07
11	LTE 5	QPSK10M	Bottom Side	0	20600	w/	1	0	22.5	21.01	1.41	0.11	0.786	1.11
	LTE 5	QPSK10M	Bottom Side	0	20525	w/	25	0	21.5	21.08	1.10	0.09	0.759	0.84
	LTE 5	QPSK10M	Bottom Side	0	20450	w/	25	0	21.5	21.07	1.10	0.12	0.753	0.83
	LTE 5	QPSK10M	Bottom Side	0	20600	w/	25	0	21.5	20.93	1.14	0.08	0.774	0.88
	LTE 5	QPSK10M	Bottom Side	0	20525	w/	50	0	21.5	20.89	1.15	0.06	0.75	0.86
	LTE 5	QPSK10M	Bottom Side	1	20525	w/o	1	0	24.0	22.60	1.38	0.06	0.334	0.46
	LTE 5	QPSK10M	Bottom Side	1	20525	w/o	25	0	23.0	21.51	1.41	0.11	0.334	0.47
	LTE 13	QPSK10M	Rear Face	0	23230	w/	1	0	22.5	21.04	1.40	0.04	0.347	0.49
	LTE 13	QPSK10M	Rear Face	0	23230	w/	25	0	21.5	21.02	1.40	0.09	0.316	0.44
	LTE 13	QPSK10M	Rear Face	0.6	23230	w/o	1	0	24.0	23.1	1.23	-0.11	0.187	0.23
	LTE 13	QPSK10M	Rear Face	0.6	23230	w/o	25	0	23.0	21.54	1.40	-0.08	0.234	0.33
	LTE 13	QPSK10M	Left Side	0	23230	w/o	1	0	24.0	23.1	1.23	-0.11	0.00509	0.01
	LTE 13	QPSK10M	Left Side	0	23230	w/o	25	0	23.0	21.54	1.40	-0.11	0.00464	0.01
	LTE 13	QPSK10M	Right Side	0	23230	w/o	1	0	24.0	23.1	1.23	-0.01	0.101	0.12
	LTE 13	QPSK10M	Right Side	0	23230	w/o	25	0	23.0	21.54	1.40	0.09	0.106	0.15
	LTE 13	QPSK10M	Top Side	0	23230	w/o	1	0	24.0	23.1	1.23	-0.03	0.028	0.03
	LTE 13	QPSK10M	Top Side	0	23230	w/o	25	0	23.0	21.54	1.40	-0.16	0.025	0.03
12	LTE 13	QPSK10M	Bottom Side	0	23230	w/	1	0	22.5	21.04	1.40	0.07	0.832	1.16
	LTE 13	QPSK10M	Bottom Side	0	23230	w/	1	0	22.5	21.04	1.40	0.07	0.804	1.13
	LTE 13	QPSK10M	Bottom Side	0	23230	w/	25	0	21.5	21.02	1.12	0.03	0.798	0.89
	LTE 13	QPSK10M	Bottom Side	1	23230	w/o	1	0	24.0	23.1	1.23	0.04	0.305	0.38
	LTE 13	QPSK10M	Bottom Side	1	23230	w/o	25	0	23.0	21.54	1.40	0.05	0.232	0.32



FCC SAR Test Report

A D T

Plot No.	Band	Mode	Test Position	Separation Distance (cm)	Ch.	Power Reduction	RB#	RB Offset	Max. Tune-up Power (dBm)	Measured Conducted Power (dBm)	Scaling Factor	Power Drift (dB)	Measured SAR-1g (W/kg)	Scaled SAR-1g (W/kg)
	LTE 17	QPSK10M	Rear Face	0	23800	w/	1	24	23.0	21.79	1.32	0.01	0.332	0.44
	LTE 17	QPSK10M	Rear Face	0	23800	w/	25	12	22.0	21.74	1.06	0.04	0.328	0.35
	LTE 17	QPSK10M	Rear Face	0.6	23800	w/o	1	24	24.0	22.76	1.33	-0.07	0.223	0.30
	LTE 17	QPSK10M	Rear Face	0.6	23800	w/o	25	12	23.0	21.65	1.36	0.07	0.178	0.24
	LTE 17	QPSK10M	Left Side	0	23800	w/o	1	24	24.0	22.76	1.33	0.15	0.014	0.02
	LTE 17	QPSK10M	Left Side	0	23800	w/o	25	12	23.0	21.65	1.36	0.08	0.011	0.02
	LTE 17	QPSK10M	Right Side	0	23800	w/o	1	24	24.0	22.76	1.33	-0.09	0.076	0.10
	LTE 17	QPSK10M	Right Side	0	23800	w/o	25	12	23.0	21.65	1.36	0.14	0.059	0.08
	LTE 17	QPSK10M	Top Side	0	23800	w/o	1	24	24.0	22.76	1.33	-0.11	0.026	0.03
	LTE 17	QPSK10M	Top Side	0	23800	w/o	25	12	23.0	21.65	1.36	-0.06	0.02	0.03
	LTE 17	QPSK10M	Bottom Side	0	23800	w/	1	24	23.0	21.79	1.32	0.09	0.851	1.12
13	LTE 17	QPSK10M	Bottom Side	0	23780	w/	1	24	23.0	21.6	1.38	0.02	0.870	1.20
	LTE 17	QPSK10M	Bottom Side	0	23790	w/	1	24	23.0	21.76	1.33	0.04	0.874	1.16
	LTE 17	QPSK10M	Bottom Side	0	23790	w/	1	24	23.0	21.76	1.33	0.03	0.859	1.14
	LTE 17	QPSK10M	Bottom Side	0	23800	w/	25	12	22.0	21.74	1.06	0.03	0.828	0.88
	LTE 17	QPSK10M	Bottom Side	0	23780	w/	25	12	22.0	21.57	1.10	0.07	0.846	0.93
	LTE 17	QPSK10M	Bottom Side	0	23790	w/	25	12	22.0	21.72	1.07	0.09	0.864	0.92
	LTE 17	QPSK10M	Bottom Side	0	23800	w/	50	0	22.0	21.54	1.11	0.05	0.811	0.90
	LTE 17	QPSK10M	Bottom Side	1	23800	w/o	1	24	24.0	22.76	1.33	0.08	0.235	0.31
	LTE 17	QPSK10M	Bottom Side	1	23800	w/o	25	12	23.0	21.65	1.36	0.08	0.19	0.26
	LTE 25	QPSK20M	Rear Face	0	26140	w/	1	0	19.5	18.23	1.34	0.02	0.395	0.53
	LTE 25	QPSK20M	Rear Face	0	26140	w/	50	0	18.5	18.19	1.07	-0.09	0.387	0.42
	LTE 25	QPSK20M	Rear Face	0.6	26140	w/o	1	0	24.0	22.98	1.26	0.08	0.318	0.40
	LTE 25	QPSK20M	Rear Face	0.6	26140	w/o	50	0	23.0	21.61	1.38	0	0.304	0.42
	LTE 25	QPSK20M	Right Side	0	26140	w/o	1	0	24.0	22.98	1.26	0.05	0.066	0.08
	LTE 25	QPSK20M	Right Side	0	26140	w/o	50	0	23.0	21.61	1.38	0.03	0.064	0.09
14	LTE 25	QPSK20M	Bottom Side	0	26140	w/	1	0	19.5	18.23	1.34	-0.04	0.771	1.03
	LTE 25	QPSK20M	Bottom Side	0	26365	w/	1	0	19.5	18.2	1.35	0.1	0.725	0.98
	LTE 25	QPSK20M	Bottom Side	0	26590	w/	1	0	19.5	18.13	1.37	0.05	0.684	0.94
	LTE 25	QPSK20M	Bottom Side	0	26140	w/	50	0	18.5	18.19	1.07	0.07	0.745	0.80
	LTE 25	QPSK20M	Bottom Side	0	26365	w/	50	0	18.5	18.16	1.08	0.1	0.673	0.73
	LTE 25	QPSK20M	Bottom Side	0	26590	w/	50	0	18.5	18.09	1.10	0.1	0.643	0.71
	LTE 25	QPSK20M	Bottom Side	0	26140	w/	100	0	18.5	18.03	1.11	0.1	0.698	0.78
	LTE 25	QPSK20M	Bottom Side	1	26140	w/o	1	0	24.0	22.98	1.26	0.17	0.304	0.38
	LTE 25	QPSK20M	Bottom Side	1	26140	w/o	50	0	23.0	21.61	1.38	0.08	0.289	0.40

<Laptop PC>

Plot No.	Band	Mode	Test Position	Separation Distance (cm)	Ch.	Power Reduction	Max. Tune-up Power (dBm)	Measured Conducted Power (dBm)	Scaling Factor	Power Drift (dB)	Measured SAR-1g (W/kg)	Scaled SAR-1g (W/kg)
20	GSM850	GPRS10	Bottom Side	0	128	w/	29.0	27.98	1.26	0.06	0.469	0.59
21	GSM1900	GPRS10	Bottom Side	0	810	w/	26.5	24.79	1.48	-0.02	0.458	0.68
22	WCDMA II	RMC12.2K	Bottom Side	0	9538	w/	20.0	19.02	1.25	-0.12	0.425	0.53
23	WCDMA IV	RMC12.2K	Bottom Side	0	1513	w/	20.0	18.31	1.48	0	0.251	0.37
24	WCDMA V	RMC12.2K	Bottom Side	0	4182	w/	22.0	21.01	1.26	-0.15	0.435	0.55
25	CDMA2000 BC0	RTAP 153.6	Bottom Side	0	384	w/	22.0	20.96	1.27	-0.01	0.473	0.60
26	CDMA2000 BC1	RTAP 153.6	Bottom Side	0	600	w/	19.5	18.79	1.18	0.11	0.374	0.44
27	CDMA2000 BC10	RTAP 153.6	Bottom Side	0	580	w/	22.0	20.87	1.30	0.09	0.399	0.52

Plot No.	Band	Mode	Test Position	Separation Distance (cm)	Ch.	Power Reduction	RB#	RB Offset	Max. Tune-up Power (dBm)	Measured Conducted Power (dBm)	Scaling Factor	Power Drift (dB)	Measured SAR-1g (W/kg)	Scaled SAR-1g (W/kg)
28	LTE 2	QPSK20M	Bottom Side	0	18900	w/	1	0	20.5	19.25	1.33	0.17	0.452	0.60
	LTE 2	QPSK20M	Bottom Side	0	18900	w/	50	0	20.5	19.18	1.36	-0.12	0.425	0.58
29	LTE 4	QPSK20M	Bottom Side	0	20300	w/	1	50	21.0	19.76	1.33	0	0.402	0.53
	LTE 4	QPSK20M	Bottom Side	0	20300	w/	50	25	20.0	19.57	1.10	0.04	0.375	0.41
30	LTE 5	QPSK10M	Bottom Side	0	20525	w/	1	0	22.5	21.17	1.36	0.15	0.533	0.72
	LTE 5	QPSK10M	Bottom Side	0	20525	w/	25	0	21.5	21.08	1.10	0.15	0.534	0.59
31	LTE 13	QPSK10M	Bottom Side	0	23230	w/	1	0	22.5	21.04	1.40	0.13	0.317	0.44
	LTE 13	QPSK10M	Bottom Side	0	23230	w/	25	0	21.5	21.02	1.12	-0.16	0.333	0.37
32	LTE 17	QPSK10M	Bottom Side	0	23800	w/	1	24	23.0	21.79	1.32	-0.11	0.354	0.47
	LTE 17	QPSK10M	Bottom Side	0	23800	w/	25	12	22.0	21.74	1.06	0.04	0.346	0.37
33	LTE 25	QPSK20M	Bottom Side	0	26140	w/	1	0	19.5	18.23	1.34	0.10	0.378	0.51
	LTE 25	QPSK20M	Bottom Side	0	26140	w/	50	0	18.5	18.19	1.07	0.12	0.366	0.39

FCC SAR Test Report

4.7.3 SAR Measurement Variability

According to KDB 865664 D01, SAR measurement variability was assessed for each frequency band, which is determined by the SAR probe calibration point and tissue-equivalent medium used for the device measurements. When both head and body tissue-equivalent media are required for SAR measurements in a frequency band, the variability measurement procedures should be applied to the tissue medium with the highest measured SAR, using the highest measured SAR configuration for that tissue-equivalent medium. Alternatively, if the highest measured SAR for both head and body tissue-equivalent media are ≤ 1.45 W/kg and the ratio of these highest SAR values, i.e., largest divided by smallest value, is ≤ 1.10 , the highest SAR configuration for either head or body tissue-equivalent medium may be used to perform the repeated measurement. These additional measurements are repeated after the completion of all measurements requiring the same head or body tissue-equivalent medium in a frequency band. The test device should be returned to ambient conditions (normal room temperature) with the battery fully charged before it is re-mounted on the device holder for the repeated measurement(s) to minimize any unexpected variations in the repeated results.

SAR repeated measurement procedure:

1. When the highest measured SAR is < 0.80 W/kg, repeated measurement is not required.
2. When the highest measured SAR is ≥ 0.80 W/kg, repeat that measurement once.
3. If the ratio of largest to smallest SAR for the original and first repeated measurements is > 1.20 , or when the original or repeated measurement is ≥ 1.45 W/kg, perform a second repeated measurement.
4. If the ratio of largest to smallest SAR for the original, first and second repeated measurements is > 1.20 , and the original, first or second repeated measurement is ≥ 1.5 W/kg, perform a third repeated measurement.

Band	Test Position	Ch.	Original Measured SAR-1g (W/kg)	1st Repeated SAR-1g (W/kg)	L/S Ratio	2nd Repeated SAR-1g (W/kg)	L/S Ratio	3rd Repeated SAR-1g (W/kg)	L/S Ratio
GSM850	Bottom Side	251	0.829	0.801	1.03	N/A	N/A	N/A	N/A
GSM1900	Bottom Side	810	0.835	0.806	1.04	N/A	N/A	N/A	N/A
WCDMA II	Bottom Side	9262	0.821	0.796	1.03	N/A	N/A	N/A	N/A
CDMA2000 BC1	Bottom Side	25	0.901	0.867	1.04	N/A	N/A	N/A	N/A
LTE 2	Bottom Side	18900	0.968	0.923	1.05	N/A	N/A	N/A	N/A
LTE 4	Bottom Side	20300	0.844	0.778	1.08	N/A	N/A	N/A	N/A
LTE 13	Bottom Side	23230	0.832	0.804	1.03	N/A	N/A	N/A	N/A
LTE 17	Bottom Side	23790	0.874	0.859	1.02	N/A	N/A	N/A	N/A

FCC SAR Test Report

4.7.4 Simultaneous Multi-band Transmission Evaluation

<Estimated SAR Calculation>

According to KDB 447498 D01, when standalone SAR test exclusion applies to an antenna that transmits simultaneously with other antennas, the standalone SAR was estimated according to following formula to result in substantially conservative SAR values of ≤ 0.4 W/kg to determine simultaneous transmission SAR test exclusion.

$$\text{Estimated SAR} = \frac{\text{Max. Tune up Power}_{(mW)}}{\text{Min. Test Separation Distance}_{(mm)}} \times \frac{\sqrt{f_{(GHz)}}}{7.5}$$

If the minimum test separation distance is < 5 mm, a distance of 5 mm is used for estimated SAR calculation. When the test separation distance is > 50 mm, the 0.4 W/kg is used for SAR-1g.

Mode / Band	Frequency (GHz)	Max. Tune-up Power (dBm)	Test Position	Separation Distance (mm)	Estimated SAR (W/kg)
GSM850	0.835	27.0	Body	5	0.40
GSM1900	1.909	24.0	Body	5	0.40
WCDMA II	1.907	24.0	Body	5	0.40
WCDMA VI	1.753	24.0	Body	5	0.40
WCDMA V	0.846	24.0	Body	5	0.40
CDMA BC0	0.848	24.5	Body	5	0.40
CDMA BC1	1.909	24.5	Body	5	0.40
CDMA BC10	0.823	24.5	Body	5	0.40
LTE 2	1.908	24.0	Body	5	0.40
LTE 4	1.752	24.0	Body	5	0.40
LTE 5	0.847	24.0	Body	5	0.40
LTE 13	0.785	24.0	Body	5	0.40
LTE 17	0.713	24.0	Body	5	0.40
LTE 25	1.913	24.0	Body	5	0.40
WLAN (DTS)	2.462	15.0	Body	5	0.40
WLAN (NII)	5.2	13.5	Body	5	0.40
WLAN (NII)	5.3	13.5	Body	5	0.40
WLAN (NII)	5.6	13.5	Body	5	0.40
WLAN (NII)	5.8	13.5	Body	5	0.40
BT (DSS)	2.48	5.0	Body	5	0.13

Note:

1. The separation distance is determined from the outer housing of the tablet to the user.
2. When standalone SAR testing is not required, an estimated SAR can be applied to determine simultaneous transmission SAR test exclusion.

FCC SAR Test Report

<SAR Summation Analysis>

Simultaneous transmission SAR test exclusion is determined for each operating configuration and exposure condition according to the reported standalone SAR of each applicable simultaneous transmitting antenna. When the sum of SAR_{1g} of all simultaneously transmitting antennas in an operating mode and exposure condition combination is within the SAR limit (SAR_{1g} 1.6 W/kg), the simultaneous transmission SAR is not required. When the sum of SAR_{1g} is greater than the SAR limit (SAR_{1g} 1.6 W/kg), SAR test exclusion is determined by the SPLSR.

SAR Summation Analysis is calculated by referring to BV ADT report no.: SA160129C01A for the SAR value of WLAN.

<Tablet PC>

No.	Conditions (SAR1 + SAR2)	Exposure Condition	Test Position	Max. SAR1	Max. SAR2	Max. SAR3	SAR Summation	SPLSR Analysis
1	GSM850 + WLAN (DTS) + BT (DSS)	Body	Rear Face	0.87	0.04	0.00	0.91	Σ SAR < 1.6, Not required
			Left Side	0.03	0.40	0.13	0.56	Σ SAR < 1.6, Not required
			Right Side	0.51	0.40	0.13	1.04	Σ SAR < 1.6, Not required
			Top Side	0.12	0.49	0.13	0.74	Σ SAR < 1.6, Not required
			Bottom Side	1.08	0.00	0.00	1.08	Σ SAR < 1.6, Not required
2	GSM850 + WLAN (NII) + BT (DSS)	Body	Rear Face	0.87	0.04	0.00	0.91	Σ SAR < 1.6, Not required
			Left Side	0.03	0.40	0.13	0.56	Σ SAR < 1.6, Not required
			Right Side	0.51	0.40	0.13	1.04	Σ SAR < 1.6, Not required
			Top Side	0.12	0.46	0.13	0.71	Σ SAR < 1.6, Not required
			Bottom Side	1.08	0.01	0.00	1.09	Σ SAR < 1.6, Not required

No.	Conditions (SAR1 + SAR2)	Exposure Condition	Test Position	Max. SAR1	Max. SAR2	Max. SAR3	SAR Summation	SPLSR Analysis
3	GSM1900 + WLAN (DTS) + BT (DSS)	Body	Rear Face	0.75	0.04	0.00	0.79	Σ SAR < 1.6, Not required
			Left Side	0.40	0.40	0.13	0.93	Σ SAR < 1.6, Not required
			Right Side	0.18	0.40	0.13	0.71	Σ SAR < 1.6, Not required
			Top Side	0.40	0.49	0.13	1.02	Σ SAR < 1.6, Not required
			Bottom Side	1.24	0.00	0.00	1.24	Σ SAR < 1.6, Not required
4	GSM1900 + WLAN (NII) + BT (DSS)	Body	Rear Face	0.75	0.04	0.00	0.79	Σ SAR < 1.6, Not required
			Left Side	0.40	0.40	0.13	0.93	Σ SAR < 1.6, Not required
			Right Side	0.18	0.40	0.13	0.71	Σ SAR < 1.6, Not required
			Top Side	0.40	0.46	0.13	0.99	Σ SAR < 1.6, Not required
			Bottom Side	1.24	0.01	0.00	1.25	Σ SAR < 1.6, Not required



FCC SAR Test Report

No.	Conditions (SAR1 + SAR2)	Exposure Condition	Test Position	Max. SAR1	Max. SAR2	Max. SAR3	SAR Summation	SPLSR Analysis
5	WCDMA II + WLAN (DTS) + BT (DSS)	Body	Rear Face	0.65	0.04	0.00	0.69	Σ SAR < 1.6, Not required
			Left Side	0.40	0.40	0.13	0.93	Σ SAR < 1.6, Not required
			Right Side	0.16	0.40	0.13	0.69	Σ SAR < 1.6, Not required
			Top Side	0.40	0.49	0.13	1.02	Σ SAR < 1.6, Not required
			Bottom Side	1.08	0.00	0.00	1.08	Σ SAR < 1.6, Not required
6	WCDMA II + WLAN (NII) + BT (DSS)	Body	Rear Face	0.65	0.04	0.00	0.69	Σ SAR < 1.6, Not required
			Left Side	0.40	0.40	0.13	0.93	Σ SAR < 1.6, Not required
			Right Side	0.16	0.40	0.13	0.69	Σ SAR < 1.6, Not required
			Top Side	0.40	0.46	0.13	0.99	Σ SAR < 1.6, Not required
			Bottom Side	1.08	0.01	0.00	1.09	Σ SAR < 1.6, Not required

No.	Conditions (SAR1 + SAR2)	Exposure Condition	Test Position	Max. SAR1	Max. SAR2	Max. SAR3	SAR Summation	SPLSR Analysis
7	WCDMA IV + WLAN (DTS) + BT (DSS)	Body	Rear Face	0.39	0.04	0.00	0.43	Σ SAR < 1.6, Not required
			Left Side	0.40	0.40	0.13	0.93	Σ SAR < 1.6, Not required
			Right Side	0.06	0.40	0.13	0.59	Σ SAR < 1.6, Not required
			Top Side	0.40	0.49	0.13	1.02	Σ SAR < 1.6, Not required
			Bottom Side	0.99	0.00	0.00	0.99	Σ SAR < 1.6, Not required
8	WCDMA IV + WLAN (NII) + BT (DSS)	Body	Rear Face	0.39	0.04	0.00	0.43	Σ SAR < 1.6, Not required
			Left Side	0.40	0.40	0.13	0.93	Σ SAR < 1.6, Not required
			Right Side	0.06	0.40	0.13	0.59	Σ SAR < 1.6, Not required
			Top Side	0.40	0.46	0.13	0.99	Σ SAR < 1.6, Not required
			Bottom Side	0.99	0.01	0.00	1.00	Σ SAR < 1.6, Not required



FCC SAR Test Report

No.	Conditions (SAR1 + SAR2)	Exposure Condition	Test Position	Max. SAR1	Max. SAR2	Max. SAR3	SAR Summation	SPLSR Analysis
9	WCDMA V + WLAN (DTS) + BT (DSS)	Body	Rear Face	0.51	0.04	0.00	0.55	Σ SAR < 1.6, Not required
			Left Side	0.01	0.40	0.13	0.54	Σ SAR < 1.6, Not required
			Right Side	0.02	0.40	0.13	0.55	Σ SAR < 1.6, Not required
			Top Side	0.07	0.49	0.13	0.69	Σ SAR < 1.6, Not required
			Bottom Side	0.89	0.00	0.00	0.89	Σ SAR < 1.6, Not required
10	WCDMA V + WLAN (NII) + BT (DSS)	Body	Rear Face	0.51	0.04	0.00	0.55	Σ SAR < 1.6, Not required
			Left Side	0.01	0.40	0.13	0.54	Σ SAR < 1.6, Not required
			Right Side	0.02	0.40	0.13	0.55	Σ SAR < 1.6, Not required
			Top Side	0.07	0.46	0.13	0.66	Σ SAR < 1.6, Not required
			Bottom Side	0.89	0.01	0.00	0.90	Σ SAR < 1.6, Not required

No.	Conditions (SAR1 + SAR2)	Exposure Condition	Test Position	Max. SAR1	Max. SAR2	Max. SAR3	SAR Summation	SPLSR Analysis
11	CDMA BC0 + WLAN (DTS) + BT (DSS)	Body	Rear Face	0.62	0.04	0.00	0.66	Σ SAR < 1.6, Not required
			Left Side	0.07	0.40	0.13	0.60	Σ SAR < 1.6, Not required
			Right Side	0.35	0.40	0.13	0.88	Σ SAR < 1.6, Not required
			Top Side	0.02	0.49	0.13	0.64	Σ SAR < 1.6, Not required
			Bottom Side	1.01	0.00	0.00	1.01	Σ SAR < 1.6, Not required
12	CDMA BC0 + WLAN (NII) + BT (DSS)	Body	Rear Face	0.62	0.04	0.00	0.66	Σ SAR < 1.6, Not required
			Left Side	0.07	0.40	0.13	0.60	Σ SAR < 1.6, Not required
			Right Side	0.35	0.40	0.13	0.88	Σ SAR < 1.6, Not required
			Top Side	0.02	0.46	0.13	0.61	Σ SAR < 1.6, Not required
			Bottom Side	1.01	0.01	0.00	1.02	Σ SAR < 1.6, Not required



FCC SAR Test Report

A D T

No.	Conditions (SAR1 + SAR2)	Exposure Condition	Test Position	Max. SAR1	Max. SAR2	Max. SAR3	SAR Summation	SPLSR Analysis
13	CDMA BC1 + WLAN (DTS) + BT (DSS)	Body	Rear Face	0.61	0.04	0.00	0.65	Σ SAR < 1.6, Not required
			Left Side	0.06	0.40	0.13	0.59	Σ SAR < 1.6, Not required
			Right Side	0.18	0.40	0.13	0.71	Σ SAR < 1.6, Not required
			Top Side	0.02	0.49	0.13	0.64	Σ SAR < 1.6, Not required
			Bottom Side	1.09	0.00	0.00	1.09	Σ SAR < 1.6, Not required
14	CDMA BC1 + WLAN (NII) + BT (DSS)	Body	Rear Face	0.61	0.04	0.00	0.65	Σ SAR < 1.6, Not required
			Left Side	0.06	0.40	0.13	0.59	Σ SAR < 1.6, Not required
			Right Side	0.18	0.40	0.13	0.71	Σ SAR < 1.6, Not required
			Top Side	0.02	0.46	0.13	0.61	Σ SAR < 1.6, Not required
			Bottom Side	1.09	0.01	0.00	1.10	Σ SAR < 1.6, Not required

No.	Conditions (SAR1 + SAR2)	Exposure Condition	Test Position	Max. SAR1	Max. SAR2	Max. SAR3	SAR Summation	SPLSR Analysis
15	CDMA BC10 + WLAN (DTS) + BT (DSS)	Body	Rear Face	0.54	0.04	0.00	0.58	Σ SAR < 1.6, Not required
			Left Side	0.01	0.40	0.13	0.54	Σ SAR < 1.6, Not required
			Right Side	0.22	0.40	0.13	0.75	Σ SAR < 1.6, Not required
			Top Side	0.04	0.49	0.13	0.66	Σ SAR < 1.6, Not required
			Bottom Side	0.97	0.00	0.00	0.97	Σ SAR < 1.6, Not required
16	CDMA BC10 + WLAN (NII) + BT (DSS)	Body	Rear Face	0.54	0.04	0.00	0.58	Σ SAR < 1.6, Not required
			Left Side	0.01	0.40	0.13	0.54	Σ SAR < 1.6, Not required
			Right Side	0.22	0.40	0.13	0.75	Σ SAR < 1.6, Not required
			Top Side	0.04	0.46	0.13	0.63	Σ SAR < 1.6, Not required
			Bottom Side	0.97	0.01	0.00	0.98	Σ SAR < 1.6, Not required



FCC SAR Test Report

A D T

No.	Conditions (SAR1 + SAR2)	Exposure Condition	Test Position	Max. SAR1	Max. SAR2	Max. SAR3	SAR Summation	SPLSR Analysis
17	LTE 2 + WLAN (DTS) + BT (DSS)	Body	Rear Face	0.63	0.04	0.00	0.67	Σ SAR < 1.6, Not required
			Left Side	0.40	0.40	0.13	0.93	Σ SAR < 1.6, Not required
			Right Side	0.18	0.40	0.13	0.71	Σ SAR < 1.6, Not required
			Top Side	0.40	0.49	0.13	1.02	Σ SAR < 1.6, Not required
			Bottom Side	1.08	0.00	0.00	1.08	Σ SAR < 1.6, Not required
18	LTE 2 + WLAN (NII) + BT (DSS)	Body	Rear Face	0.63	0.04	0.00	0.67	Σ SAR < 1.6, Not required
			Left Side	0.40	0.40	0.13	0.93	Σ SAR < 1.6, Not required
			Right Side	0.18	0.40	0.13	0.71	Σ SAR < 1.6, Not required
			Top Side	0.40	0.46	0.13	0.99	Σ SAR < 1.6, Not required
			Bottom Side	1.08	0.01	0.00	1.09	Σ SAR < 1.6, Not required

No.	Conditions (SAR1 + SAR2)	Exposure Condition	Test Position	Max. SAR1	Max. SAR2	Max. SAR3	SAR Summation	SPLSR Analysis
19	LTE 4 + WLAN (DTS) + BT (DSS)	Body	Rear Face	0.48	0.04	0.00	0.52	Σ SAR < 1.6, Not required
			Left Side	0.40	0.40	0.13	0.93	Σ SAR < 1.6, Not required
			Right Side	0.07	0.40	0.13	0.60	Σ SAR < 1.6, Not required
			Top Side	0.40	0.49	0.13	1.02	Σ SAR < 1.6, Not required
			Bottom Side	1.12	0.00	0.00	1.12	Σ SAR < 1.6, Not required
20	LTE 4 + WLAN (NII) + BT (DSS)	Body	Rear Face	0.48	0.04	0.00	0.52	Σ SAR < 1.6, Not required
			Left Side	0.40	0.40	0.13	0.93	Σ SAR < 1.6, Not required
			Right Side	0.07	0.40	0.13	0.60	Σ SAR < 1.6, Not required
			Top Side	0.40	0.46	0.13	0.99	Σ SAR < 1.6, Not required
			Bottom Side	1.12	0.01	0.00	1.13	Σ SAR < 1.6, Not required



FCC SAR Test Report

No.	Conditions (SAR1 + SAR2)	Exposure Condition	Test Position	Max. SAR1	Max. SAR2	Max. SAR3	SAR Summation	SPLSR Analysis
21	LTE 5 + WLAN (DTS) + BT (DSS)	Body	Rear Face	0.68	0.04	0.00	0.72	Σ SAR < 1.6, Not required
			Left Side	0.01	0.40	0.13	0.54	Σ SAR < 1.6, Not required
			Right Side	0.28	0.40	0.13	0.81	Σ SAR < 1.6, Not required
			Top Side	0.06	0.49	0.13	0.68	Σ SAR < 1.6, Not required
			Bottom Side	1.11	0.00	0.00	1.11	Σ SAR < 1.6, Not required
22	LTE 5 + WLAN (NII) + BT (DSS)	Body	Rear Face	0.68	0.04	0.00	0.72	Σ SAR < 1.6, Not required
			Left Side	0.01	0.40	0.13	0.54	Σ SAR < 1.6, Not required
			Right Side	0.28	0.40	0.13	0.81	Σ SAR < 1.6, Not required
			Top Side	0.06	0.46	0.13	0.65	Σ SAR < 1.6, Not required
			Bottom Side	1.11	0.01	0.00	1.12	Σ SAR < 1.6, Not required

No.	Conditions (SAR1 + SAR2)	Exposure Condition	Test Position	Max. SAR1	Max. SAR2	Max. SAR3	SAR Summation	SPLSR Analysis
23	LTE 13 + WLAN (DTS) + BT (DSS)	Body	Rear Face	0.49	0.04	0.00	0.53	Σ SAR < 1.6, Not required
			Left Side	0.01	0.40	0.13	0.54	Σ SAR < 1.6, Not required
			Right Side	0.15	0.40	0.13	0.68	Σ SAR < 1.6, Not required
			Top Side	0.03	0.49	0.13	0.65	Σ SAR < 1.6, Not required
			Bottom Side	1.16	0.00	0.00	1.16	Σ SAR < 1.6, Not required
24	LTE 13 + WLAN (NII) + BT (DSS)	Body	Rear Face	0.49	0.04	0.00	0.53	Σ SAR < 1.6, Not required
			Left Side	0.01	0.40	0.13	0.54	Σ SAR < 1.6, Not required
			Right Side	0.15	0.40	0.13	0.68	Σ SAR < 1.6, Not required
			Top Side	0.03	0.46	0.13	0.62	Σ SAR < 1.6, Not required
			Bottom Side	1.16	0.01	0.00	1.17	Σ SAR < 1.6, Not required



FCC SAR Test Report

No.	Conditions (SAR1 + SAR2)	Exposure Condition	Test Position	Max. SAR1	Max. SAR2	Max. SAR3	SAR Summation	SPLSR Analysis
25	LTE 17 + WLAN (DTS) + BT (DSS)	Body	Rear Face	0.44	0.04	0.00	0.48	Σ SAR < 1.6, Not required
			Left Side	0.02	0.40	0.13	0.55	Σ SAR < 1.6, Not required
			Right Side	0.10	0.40	0.13	0.63	Σ SAR < 1.6, Not required
			Top Side	0.03	0.49	0.13	0.65	Σ SAR < 1.6, Not required
			Bottom Side	1.20	0.00	0.00	1.20	Σ SAR < 1.6, Not required
26	LTE 17 + WLAN (NII) + BT (DSS)	Body	Rear Face	0.44	0.04	0.00	0.48	Σ SAR < 1.6, Not required
			Left Side	0.02	0.40	0.13	0.55	Σ SAR < 1.6, Not required
			Right Side	0.10	0.40	0.13	0.63	Σ SAR < 1.6, Not required
			Top Side	0.03	0.46	0.13	0.62	Σ SAR < 1.6, Not required
			Bottom Side	1.20	0.01	0.00	1.21	Σ SAR < 1.6, Not required

No.	Conditions (SAR1 + SAR2)	Exposure Condition	Test Position	Max. SAR1	Max. SAR2	Max. SAR3	SAR Summation	SPLSR Analysis
27	LTE 25 + WLAN (DTS) + BT (DSS)	Body	Rear Face	0.53	0.04	0.00	0.57	Σ SAR < 1.6, Not required
			Left Side	0.40	0.40	0.13	0.93	Σ SAR < 1.6, Not required
			Right Side	0.09	0.40	0.13	0.62	Σ SAR < 1.6, Not required
			Top Side	0.40	0.49	0.13	1.02	Σ SAR < 1.6, Not required
			Bottom Side	1.03	0.00	0.00	1.03	Σ SAR < 1.6, Not required
28	LTE 25 + WLAN (NII) + BT (DSS)	Body	Rear Face	0.53	0.04	0.00	0.57	Σ SAR < 1.6, Not required
			Left Side	0.40	0.40	0.13	0.93	Σ SAR < 1.6, Not required
			Right Side	0.09	0.40	0.13	0.62	Σ SAR < 1.6, Not required
			Top Side	0.40	0.46	0.13	0.99	Σ SAR < 1.6, Not required
			Bottom Side	1.03	0.01	0.00	1.04	Σ SAR < 1.6, Not required



FCC SAR Test Report

<Laptop PC>

No.	Conditions (SAR1 + SAR2)	Exposure Condition	Test Position	Max. SAR1	Max. SAR2	Max. SAR3	SAR Summation	SPLSR Analysis
29	GSM850 + WLAN (DTS) + BT (DSS)	Body	Bottom Side	0.59	0.05	0.13	0.77	Σ SAR < 1.6, Not required
			Top Side	0.40	0.00	0.00	0.40	Σ SAR < 1.6, Not required
			Back of Panel	0.40	0.02	0.13	0.55	Σ SAR < 1.6, Not required
30	GSM850 + WLAN (NII) + BT (DSS)	Body	Bottom Side	0.59	0.05	0.13	0.77	Σ SAR < 1.6, Not required
			Top Side	0.40	0.10	0.00	0.50	Σ SAR < 1.6, Not required
			Back of Panel	0.40	0.22	0.13	0.75	Σ SAR < 1.6, Not required

No.	Conditions (SAR1 + SAR2)	Exposure Condition	Test Position	Max. SAR1	Max. SAR2	Max. SAR3	SAR Summation	SPLSR Analysis
31	GSM1900 + WLAN (DTS) + BT (DSS)	Body	Bottom Side	0.68	0.05	0.13	0.86	Σ SAR < 1.6, Not required
			Top Side	0.40	0.00	0.00	0.40	Σ SAR < 1.6, Not required
			Back of Panel	0.40	0.02	0.13	0.55	Σ SAR < 1.6, Not required
32	GSM1900 + WLAN (NII) + BT (DSS)	Body	Bottom Side	0.68	0.05	0.13	0.86	Σ SAR < 1.6, Not required
			Top Side	0.40	0.10	0.00	0.50	Σ SAR < 1.6, Not required
			Back of Panel	0.40	0.22	0.13	0.75	Σ SAR < 1.6, Not required

No.	Conditions (SAR1 + SAR2)	Exposure Condition	Test Position	Max. SAR1	Max. SAR2	Max. SAR3	SAR Summation	SPLSR Analysis
33	WCDMA II + WLAN (DTS) + BT (DSS)	Body	Bottom Side	0.53	0.05	0.13	0.71	Σ SAR < 1.6, Not required
			Top Side	0.40	0.00	0.00	0.40	Σ SAR < 1.6, Not required
			Back of Panel	0.40	0.02	0.13	0.55	Σ SAR < 1.6, Not required
34	WCDMA II + WLAN (NII) + BT (DSS)	Body	Bottom Side	0.53	0.05	0.13	0.71	Σ SAR < 1.6, Not required
			Top Side	0.40	0.10	0.00	0.50	Σ SAR < 1.6, Not required
			Back of Panel	0.40	0.22	0.13	0.75	Σ SAR < 1.6, Not required



FCC SAR Test Report

No.	Conditions (SAR1 + SAR2)	Exposure Condition	Test Position	Max. SAR1	Max. SAR2	Max. SAR3	SAR Summation	SPLSR Analysis
35	WCDMA IV + WLAN (DTS) + BT (DSS)	Body	Bottom Side	0.37	0.05	0.13	0.55	Σ SAR < 1.6, Not required
			Top Side	0.40	0.00	0.00	0.40	Σ SAR < 1.6, Not required
			Back of Panel	0.40	0.02	0.13	0.55	Σ SAR < 1.6, Not required
36	WCDMA IV + WLAN (NII) + BT (DSS)	Body	Bottom Side	0.37	0.05	0.13	0.55	Σ SAR < 1.6, Not required
			Top Side	0.40	0.10	0.00	0.50	Σ SAR < 1.6, Not required
			Back of Panel	0.40	0.22	0.13	0.75	Σ SAR < 1.6, Not required

No.	Conditions (SAR1 + SAR2)	Exposure Condition	Test Position	Max. SAR1	Max. SAR2	Max. SAR3	SAR Summation	SPLSR Analysis
37	WCDMA V + WLAN (DTS) + BT (DSS)	Body	Bottom Side	0.55	0.05	0.13	0.73	Σ SAR < 1.6, Not required
			Top Side	0.40	0.00	0.00	0.40	Σ SAR < 1.6, Not required
			Back of Panel	0.40	0.02	0.13	0.55	Σ SAR < 1.6, Not required
38	WCDMA V + WLAN (NII) + BT (DSS)	Body	Bottom Side	0.55	0.05	0.13	0.73	Σ SAR < 1.6, Not required
			Top Side	0.40	0.10	0.00	0.50	Σ SAR < 1.6, Not required
			Back of Panel	0.40	0.22	0.13	0.75	Σ SAR < 1.6, Not required

No.	Conditions (SAR1 + SAR2)	Exposure Condition	Test Position	Max. SAR1	Max. SAR2	Max. SAR3	SAR Summation	SPLSR Analysis
39	CDMA BC0 + WLAN (DTS) + BT (DSS)	Body	Bottom Side	0.60	0.05	0.13	0.78	Σ SAR < 1.6, Not required
			Top Side	0.40	0.00	0.00	0.40	Σ SAR < 1.6, Not required
			Back of Panel	0.40	0.02	0.13	0.55	Σ SAR < 1.6, Not required
40	CDMA BC0 + WLAN (NII) + BT (DSS)	Body	Bottom Side	0.60	0.05	0.13	0.78	Σ SAR < 1.6, Not required
			Top Side	0.40	0.10	0.00	0.50	Σ SAR < 1.6, Not required
			Back of Panel	0.40	0.22	0.13	0.75	Σ SAR < 1.6, Not required



FCC SAR Test Report

No.	Conditions (SAR1 + SAR2)	Exposure Condition	Test Position	Max. SAR1	Max. SAR2	Max. SAR3	SAR Summation	SPLSR Analysis
41	CDMA BC1 + WLAN (DTS) + BT (DSS)	Body	Bottom Side	0.44	0.05	0.13	0.62	Σ SAR < 1.6, Not required
			Top Side	0.40	0.00	0.00	0.40	Σ SAR < 1.6, Not required
			Back of Panel	0.40	0.02	0.13	0.55	Σ SAR < 1.6, Not required
42	CDMA BC1 + WLAN (NII) + BT (DSS)	Body	Bottom Side	0.44	0.05	0.13	0.62	Σ SAR < 1.6, Not required
			Top Side	0.40	0.10	0.00	0.50	Σ SAR < 1.6, Not required
			Back of Panel	0.40	0.22	0.13	0.75	Σ SAR < 1.6, Not required

No.	Conditions (SAR1 + SAR2)	Exposure Condition	Test Position	Max. SAR1	Max. SAR2	Max. SAR3	SAR Summation	SPLSR Analysis
43	CDMA BC10 + WLAN (DTS) + BT (DSS)	Body	Bottom Side	0.52	0.05	0.13	0.70	Σ SAR < 1.6, Not required
			Top Side	0.40	0.00	0.00	0.40	Σ SAR < 1.6, Not required
			Back of Panel	0.40	0.02	0.13	0.55	Σ SAR < 1.6, Not required
44	CDMA BC10 + WLAN (NII) + BT (DSS)	Body	Bottom Side	0.52	0.05	0.13	0.70	Σ SAR < 1.6, Not required
			Top Side	0.40	0.10	0.00	0.50	Σ SAR < 1.6, Not required
			Back of Panel	0.40	0.22	0.13	0.75	Σ SAR < 1.6, Not required

No.	Conditions (SAR1 + SAR2)	Exposure Condition	Test Position	Max. SAR1	Max. SAR2	Max. SAR3	SAR Summation	SPLSR Analysis
45	LTE 2 + WLAN (DTS) + BT (DSS)	Body	Bottom Side	0.60	0.05	0.13	0.78	Σ SAR < 1.6, Not required
			Top Side	0.40	0.00	0.00	0.40	Σ SAR < 1.6, Not required
			Back of Panel	0.40	0.02	0.13	0.55	Σ SAR < 1.6, Not required
46	LTE 2 + WLAN (NII) + BT (DSS)	Body	Bottom Side	0.60	0.05	0.13	0.78	Σ SAR < 1.6, Not required
			Top Side	0.40	0.10	0.00	0.50	Σ SAR < 1.6, Not required
			Back of Panel	0.40	0.22	0.13	0.75	Σ SAR < 1.6, Not required



FCC SAR Test Report

No.	Conditions (SAR1 + SAR2)	Exposure Condition	Test Position	Max. SAR1	Max. SAR2	Max. SAR3	SAR Summation	SPLSR Analysis
47	LTE 4 + WLAN (DTS) + BT (DSS)	Body	Bottom Side	0.53	0.05	0.13	0.71	Σ SAR < 1.6, Not required
			Top Side	0.40	0.00	0.00	0.40	Σ SAR < 1.6, Not required
			Back of Panel	0.40	0.02	0.13	0.55	Σ SAR < 1.6, Not required
48	LTE 4 + WLAN (NII) + BT (DSS)	Body	Bottom Side	0.53	0.05	0.13	0.71	Σ SAR < 1.6, Not required
			Top Side	0.40	0.10	0.00	0.50	Σ SAR < 1.6, Not required
			Back of Panel	0.40	0.22	0.13	0.75	Σ SAR < 1.6, Not required

No.	Conditions (SAR1 + SAR2)	Exposure Condition	Test Position	Max. SAR1	Max. SAR2	Max. SAR3	SAR Summation	SPLSR Analysis
49	LTE 5 + WLAN (DTS) + BT (DSS)	Body	Bottom Side	0.72	0.05	0.13	0.90	Σ SAR < 1.6, Not required
			Top Side	0.40	0.00	0.00	0.40	Σ SAR < 1.6, Not required
			Back of Panel	0.40	0.02	0.13	0.55	Σ SAR < 1.6, Not required
50	LTE 5 + WLAN (NII) + BT (DSS)	Body	Bottom Side	0.72	0.05	0.13	0.90	Σ SAR < 1.6, Not required
			Top Side	0.40	0.10	0.00	0.50	Σ SAR < 1.6, Not required
			Back of Panel	0.40	0.22	0.13	0.75	Σ SAR < 1.6, Not required

No.	Conditions (SAR1 + SAR2)	Exposure Condition	Test Position	Max. SAR1	Max. SAR2	Max. SAR3	SAR Summation	SPLSR Analysis
51	LTE 13 + WLAN (DTS) + BT (DSS)	Body	Bottom Side	0.44	0.05	0.13	0.62	Σ SAR < 1.6, Not required
			Top Side	0.40	0.00	0.00	0.40	Σ SAR < 1.6, Not required
			Back of Panel	0.40	0.02	0.13	0.55	Σ SAR < 1.6, Not required
52	LTE 13 + WLAN (NII) + BT (DSS)	Body	Bottom Side	0.44	0.05	0.13	0.62	Σ SAR < 1.6, Not required
			Top Side	0.40	0.10	0.00	0.50	Σ SAR < 1.6, Not required
			Back of Panel	0.40	0.22	0.13	0.75	Σ SAR < 1.6, Not required



FCC SAR Test Report

No.	Conditions (SAR1 + SAR2)	Exposure Condition	Test Position	Max. SAR1	Max. SAR2	Max. SAR3	SAR Summation	SPLSR Analysis
53	LTE 17 + WLAN (DTS) + BT (DSS)	Body	Bottom Side	0.47	0.05	0.13	0.65	Σ SAR < 1.6, Not required
			Top Side	0.40	0.00	0.00	0.40	Σ SAR < 1.6, Not required
			Back of Panel	0.40	0.02	0.13	0.55	Σ SAR < 1.6, Not required
54	LTE 17 + WLAN (NII) + BT (DSS)	Body	Bottom Side	0.47	0.05	0.13	0.65	Σ SAR < 1.6, Not required
			Top Side	0.40	0.10	0.00	0.50	Σ SAR < 1.6, Not required
			Back of Panel	0.40	0.22	0.13	0.75	Σ SAR < 1.6, Not required

No.	Conditions (SAR1 + SAR2)	Exposure Condition	Test Position	Max. SAR1	Max. SAR2	Max. SAR3	SAR Summation	SPLSR Analysis
55	LTE 25 + WLAN (DTS) + BT (DSS)	Body	Bottom Side	0.51	0.05	0.13	0.69	Σ SAR < 1.6, Not required
			Top Side	0.40	0.00	0.00	0.40	Σ SAR < 1.6, Not required
			Back of Panel	0.40	0.02	0.13	0.55	Σ SAR < 1.6, Not required
56	LTE 25 + WLAN (NII) + BT (DSS)	Body	Bottom Side	0.51	0.05	0.13	0.69	Σ SAR < 1.6, Not required
			Top Side	0.40	0.10	0.00	0.50	Σ SAR < 1.6, Not required
			Back of Panel	0.40	0.22	0.13	0.75	Σ SAR < 1.6, Not required

Test Engineer : Mars Chang, and Willy Chang



5. Calibration of Test Equipment

Equipment	Manufacturer	Model	SN	Cal. Date	Cal. Interval
System Validation Dipole	SPEAG	D750V3	1013	Aug. 24, 2015	1 Year
System Validation Dipole	SPEAG	D835V2	4d121	Aug. 24, 2015	1 Year
System Validation Dipole	SPEAG	D1750V2	1055	Aug. 20, 2015	1 Year
System Validation Dipole	SPEAG	D1900V2	5d036	Jan. 22, 2016	1 Year
Dosimetric E-Field Probe	SPEAG	EX3DV4	3650	Jul. 23, 2015	1 Year
Dosimetric E-Field Probe	SPEAG	EX3DV4	3864	Jul. 23, 2015	1 Year
Data Acquisition Electronics	SPEAG	DAE4	861	Apr. 28, 2015	1 Year
Data Acquisition Electronics	SPEAG	DAE4	1277	Jul. 22, 2015	1 Year
Wireless Communication Test Set	Agilent	E5515C	MY50260642	Nov. 19, 2015	2 Years
Radio Communication Analyzer	Anritsu	MT8820C	6201300638	Jul. 29, 2015	1 Year
ENA Series Network Analyzer	Agilent	E5071C	MY46214281	Jun. 23, 2015	1 Year
EXA Spectrum Analyzer	Agilent	N9010A	MY52220314	Oct. 23, 2015	1 Year
MXG Analog Signal Generator	Agilent	N5181A	MY50143868	Jul. 06, 2015	1 Year
Power Meter	Anritsu	ML2495A	1218009	Jul. 06, 2015	1 Year
Power Sensor	Anritsu	MA2411B	1207252	Jul. 06, 2015	1 Year
Thermometer	YFE	YF-160A	130504579	Aug. 20, 2015	1 Year



FCC SAR Test Report

6. Measurement Uncertainty

Source of Uncertainty	Tolerance (± %)	Probability Distribution	Divisor	Ci (1g)	Ci (10g)	Standard Uncertainty (± %, 1g)	Standard Uncertainty (± %, 10g)	Vi
Measurement System								
Probe Calibration	6.0	Normal	1	1	1	6.0	6.0	∞
Axial Isotropy	4.7	Rectangular	√3	0.707	0.707	1.9	1.9	∞
Hemispherical Isotropy	9.6	Rectangular	√3	0.707	0.707	3.9	3.9	∞
Boundary Effect	1.0	Rectangular	√3	1	1	0.6	0.6	∞
Linearity	4.7	Rectangular	√3	1	1	2.7	2.7	∞
System Detection Limits	0.25	Rectangular	√3	1	1	0.14	0.14	∞
Readout Electronics	0.3	Normal	1	1	1	0.3	0.3	∞
Response Time	0.0	Rectangular	√3	1	1	0.0	0.0	∞
Integration Time	1.7	Rectangular	√3	1	1	1.0	1.0	∞
RF Ambient Conditions - Noise	3.0	Rectangular	√3	1	1	1.7	1.7	∞
RF Ambient Conditions - Reflections	3.0	Rectangular	√3	1	1	1.7	1.7	∞
Probe Positioner Mechanical Tolerance	0.4	Rectangular	√3	1	1	0.2	0.2	∞
Probe Positioning with Respect to Phantom Shell	2.9	Rectangular	√3	1	1	1.7	1.7	∞
Extrapolation, interpolation, and integration algorithms for max. SAR evaluation	2.0	Rectangular	√3	1	1	1.2	1.2	∞
Test Sample Related								
Test Sample Positioning	1.5 / 0.7	Normal	1	1	1	1.5	0.7	32
Device Holder Uncertainty	4.2 / 1.8	Normal	1	1	1	4.2	1.8	32
Output Power Variation - SAR Drift Measurement	5.0	Rectangular	√3	1	1	2.9	2.9	∞
Phantom and Tissue Parameters								
Phantom Uncertainty (Shape and Thickness Tolerances)	7.2	Rectangular	√3	1	1	4.2	4.2	∞
Liquid Conductivity - Deviation from Target Values	5.0	Rectangular	√3	0.64	0.43	1.8	1.2	∞
Liquid Conductivity - Measurement Uncertainty	1.0	Normal	1	0.64	0.43	0.6	0.4	25
Liquid Permittivity - Deviation from Target Values	5.0	Rectangular	√3	0.60	0.49	1.7	1.4	∞
Liquid Permittivity - Measurement Uncertainty	0.5	Normal	1	0.60	0.49	0.3	0.2	25
Combined Standard Uncertainty						± 11.2 %	± 10.4 %	
Expanded Uncertainty (K=2)						± 22.4 %	± 20.8 %	

Uncertainty budget for frequency range 300 MHz to 3 GHz



FCC SAR Test Report

A D T

Source of Uncertainty	Tolerance (± %)	Probability Distribution	Divisor	Ci (1g)	Ci (10g)	Standard Uncertainty (± %, 1g)	Standard Uncertainty (± %, 10g)	Vi
Measurement System								
Probe Calibration	6.55	Normal	1	1	1	6.55	6.55	∞
Axial Isotropy	4.7	Rectangular	√3	0.707	0.707	1.9	1.9	∞
Hemispherical Isotropy	9.6	Rectangular	√3	0.707	0.707	3.9	3.9	∞
Boundary Effect	2.0	Rectangular	√3	1	1	1.2	1.2	∞
Linearity	4.7	Rectangular	√3	1	1	2.7	2.7	∞
System Detection Limits	0.25	Rectangular	√3	1	1	0.14	0.14	∞
Readout Electronics	0.3	Normal	1	1	1	0.3	0.3	∞
Response Time	0.0	Rectangular	√3	1	1	0.0	0.0	∞
Integration Time	1.7	Rectangular	√3	1	1	1.0	1.0	∞
RF Ambient Conditions - Noise	3.0	Rectangular	√3	1	1	1.7	1.7	∞
RF Ambient Conditions - Reflections	3.0	Rectangular	√3	1	1	1.7	1.7	∞
Probe Positioner Mechanical Tolerance	0.4	Rectangular	√3	1	1	0.2	0.2	∞
Probe Positioning with Respect to Phantom Shell	6.7	Rectangular	√3	1	1	3.9	3.9	∞
Extrapolation, interpolation, and integration algorithms for max. SAR evaluation	4.0	Rectangular	√3	1	1	2.3	2.3	∞
Test Sample Related								
Test Sample Positioning	1.5 / 0.7	Normal	1	1	1	1.5	0.7	32
Device Holder Uncertainty	4.2 / 1.8	Normal	1	1	1	4.2	1.8	32
Output Power Variation - SAR Drift Measurement	5.0	Rectangular	√3	1	1	2.9	2.9	∞
Phantom and Tissue Parameters								
Phantom Uncertainty (Shape and Thickness Tolerances)	7.6	Rectangular	√3	1	1	4.4	4.4	∞
Liquid Conductivity - Deviation from Target Values	5.0	Rectangular	√3	0.64	0.43	1.8	1.2	∞
Liquid Conductivity - Measurement Uncertainty	1.0	Normal	1	0.64	0.43	0.6	0.4	25
Liquid Permittivity - Deviation from Target Values	5.0	Rectangular	√3	0.60	0.49	1.7	1.4	∞
Liquid Permittivity - Measurement Uncertainty	0.5	Normal	1	0.60	0.49	0.3	0.2	25
Combined Standard Uncertainty						± 12.3 %	± 11.5 %	
Expanded Uncertainty (K=2)						± 24.6 %	± 23.0 %	

Uncertainty budget for frequency range 3 GHz to 6 GHz



FCC SAR Test Report

7. Information on the Testing Laboratories

We, Bureau Veritas Consumer Products Services (H.K.) Ltd., Taoyuan Branch, were founded in 1988 to provide our best service in EMC, Radio, Telecom and Safety consultation. Our laboratories are accredited and approved according to ISO/IEC 17025.

If you have any comments, please feel free to contact us at the following:

Taiwan HwaYa EMC/RF/Safety Lab:

Add: No.19, Hwa Ya 2nd Rd., Wen Hwa Vil., Kwei Shan Dist., Taoyuan City 33383, Taiwan, R.O.C.

Tel: 886-3-318-3232

Fax: 886-3-327-0892

Taiwan LinKo EMC/RF Lab:

Add: No. 47-2, 14th Ling, Chia Pau Vil., Linkou Dist., New Taipei City 244, Taiwan, R.O.C.

Tel: 886-2-2605-2180

Fax: 886-2-2605-1924

Taiwan HsinChu EMC/RF/Telecom Lab:

Add: No. 81-1, Lu Liao Keng, 9th Ling, Wu Lung Vil., Chiung Lin Township, Hsinchu County 307, Taiwan, R.O.C.

Tel: 886-3-6668-565

Fax: 886-3-6668-323

Email: service.adt@tw.bureauveritas.com

Web Site: www.adt.com.tw

The road map of all our labs can be found in our web site also.

---END---



Appendix A. SAR Plots of System Verification

The plots for system verification with largest deviation for each SAR system combination are shown as follows.



Appendix B. SAR Plots of SAR Measurement

The SAR plots for highest measured SAR in each exposure configuration, wireless mode and frequency band combination, and measured SAR > 1.5 W/kg are shown as follows.



Appendix C. Calibration Certificate for Probe and Dipole

The SPEAG calibration certificates are shown as follows.



Appendix D. Photographs of EUT and Setup