

FCC SAR Test Report

APPLICANT : SIERRA WIRELESS INC.
EQUIPMENT : PCIe wireless WAN card
BRAND NAME : AirPrime
MODEL NAME : EM7355
FCC ID : N7NEM7355-D1
STANDARD : FCC 47 CFR Part 2 (2.1093)
ANSI/IEEE C95.1-1992
IEEE 1528-2003

The product was installed into Tablet PC (Brand Name: DELL, Model Name: T07G) during test.

We, SPORTON INTERNATIONAL INC., would like to declare that the tested sample has been evaluated in accordance with the procedures and shown the compliance with the applicable technical standards.

The test results in this report apply exclusively to the tested model / sample. Without written approval of SPORTON INTERNATIONAL INC., the test report shall not be reproduced except in full.

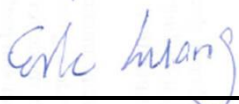

Reviewed by: Eric Huang / Deputy Manager



Approved by: Jones Tsai / Manager



SPORTON INTERNATIONAL INC.

No. 52, Hwa Ya 1st Rd., Hwa Ya Technology Park, Kwei-Shan Hsiang, Tao Yuan Hsien, Taiwan, R.O.C.



Table of Contents

1. Statement of Compliance 4
2. Administration Data 5
2.1 Testing Laboratory 5
2.2 Applicant 5
2.3 Application Details 5
3. General Information 6
3.1 Description of Equipment Under Test (EUT) 6
3.2 Maximum RF output power among production units 7
3.3 Applied Standard 12
3.4 Device Category and SAR Limits 12
3.5 Test Conditions 12
4. Specific Absorption Rate (SAR) 16
4.1 Introduction 16
4.2 SAR Definition 16
5. SAR Measurement System 17
5.1 E-Field Probe 18
5.2 Data Acquisition Electronics (DAE) 19
5.3 Robot 19
5.4 Measurement Server 19
5.5 Phantom 20
5.6 Device Holder 21
5.7 Data Storage and Evaluation 22
5.8 Test Equipment List 24
6. Tissue Simulating Liquids 25
7. System Verification Procedures 27
7.1 Purpose of System Performance check 27
7.2 System Setup 27
7.3 SAR System Verification Results 28
8. EUT Testing Position 29
9. Measurement Procedures 29
9.1 Spatial Peak SAR Evaluation 29
9.2 Power Reference Measurement 30
9.3 Area & Zoom Scan Procedures 30
9.4 Volume Scan Procedures 31
9.5 SAR Averaged Methods 31
9.6 Power Drift Monitoring 31
10. Conducted RF Output Power (Unit: dBm) 32
11. Antenna Location 58
12. SAR Test Results 60
12.1 Body SAR 60
12.2 Repeated SAR Measurement 65
13. Simultaneous Transmission Analysis 66
13.1 Body Exposure Conditions 67
13.2 SPLSR Evaluation and Analysis 73
14. Uncertainty Assessment 78
15. References 80
Appendix A. Plots of System Performance Check
Appendix B. Plots of High SAR Measurement
Appendix C. DASYS Calibration Certificate
Appendix D. Test Setup Photos



1. Statement of Compliance

The maximum results of Specific Absorption Rate (SAR) found during testing for **SIERRA WIRELESS INC. PCIe wireless WAN card, AirPrime** are as follows.

<Highest SAR Summary>

Exposure Position	Frequency Band	Reported 1g-SAR (W/kg)	Equipment Class	Highest Reported 1g-SAR (W/kg)
Body	GPRS850	1.05	PCB	1.17
	GPRS1900	1.15		
	WCDMA Band V	0.59		
	WCDMA Band IV	1.17		
	WCDMA Band II	1.15		
	CDMA 2000 BC10	0.92		
	CDMA 2000 BC0	0.95		
	CDMA 2000 BC1	1.16		
	LTE Band 17	0.57		
	LTE Band 13	0.78		
	LTE Band 5	0.97		
	LTE Band 4	1.00		
	LTE Band 2	1.14		
	LTE Band 25	1.10		

<Highest Simultaneous transmission SAR with PD97260NGU>

Exposure Position	Frequency Band	Equipment Class	Highest Reported Simultaneous Transmission 1g-SAR (W/kg)
Body	WCDMA IV	PCB	1.17
	Bluetooth	DSS	

Exposure Position	Frequency Band	Equipment Class	Highest Reported Simultaneous Transmission 1g-SAR (W/kg)
Body	WCDMA IV	PCB	1.59
	WLAN2.4GHz Band	DTS	

<Highest Simultaneous transmission SAR with PPD-QCSNFA282>

Exposure Position	Frequency Band	Equipment Class	Highest Reported Simultaneous Transmission 1g-SAR (W/kg)
Body	WCDMA IV	PCB	1.17
	Bluetooth	DSS	

Exposure Position	Frequency Band	Equipment Class	Highest Reported Simultaneous Transmission 1g-SAR (W/kg)
Body	LTE Band 4	PCB	1.59
	WLAN2.4GHz Band	DTS	

This device is in compliance with Specific Absorption Rate (SAR) for general population/uncontrolled exposure limits (1.6 W/kg) specified in FCC 47 CFR part 2 (2.1093) and ANSI/IEEE C95.1-1992, and had been tested in accordance with the measurement methods and procedures specified in IEEE 1528-2003 and published FCC KDB procedures.



2. Administration Data

2.1 Testing Laboratory

Test Site	SPORTON INTERNATIONAL INC.
Test Site Location	No. 52, Hwa Ya 1 st Rd., Hwa Ya Technology Park, Kwei-Shan Hsiang, Tao Yuan Hsien, Taiwan, R.O.C. TEL: +886-3-327-3456 FAX: +886-3-328-4978

2.2 Applicant

Company Name	SIERRA WIRELESS INC.
Address	13811 Wireless Way, Richmond, BC, Canada, V6V 3A4

2.3 Application Details

Date of Start during the Test	Sep. 16, 2013
Date of End during the Test	Sep. 27, 2013



3. General Information

3.1 Description of Equipment Under Test (EUT)

Product Feature & Specification	
EUT	PCIe wireless WAN card
Brand Name	AirPrime
Model Name	EM7355
FCC ID	N7NEM7355-D1
IMEI Code	356196050033907
Wireless Technology and Frequency Range	GSM850: 824.2 MHz ~ 848.8 MHz GSM1900: 1850.2 MHz ~ 1909.8 MHz WCDMA Band V: 826.4 MHz ~ 846.6 MHz WCDMA Band IV: 1712.4 MHz ~ 1752.6 MHz WCDMA Band II: 1852.4 MHz ~ 1907.6 MHz CDMA 2000 BC10: 817.9 MHz ~ 823.1 MHz CDMA 2000 BC0: 824.7 MHz ~ 848.31 MHz CDMA 2000 BC1: 1851.25 MHz ~ 1908.75 MHz LTE Band 17: 706.5 MHz ~ 713.5 MHz LTE Band 13: 779.5 MHz ~ 784.5 MHz LTE Band 5: 824.7 MHz ~ 848.3 MHz LTE Band 4: 1710.7 MHz ~ 1754.3 MHz LTE Band 2: 1850.7 MHz ~ 1909.3 MHz LTE Band 25: 1850.7 MHz ~ 1914.3 MHz
Mode	<ul style="list-style-type: none"> • GPRS/EGPRS • RMC 12.2Kbps Rel 99 • HSDPA Rel 7, Cat14 • HSUPA Rel 6, Cat6 • DC-HSDPA Rel 8 Cat24 • CDMA2000: 1xRTT/1xEv-Do(Rel.0)/1xEv-Do(Rev.A) • LTE: QPSK, 16QAM
EUT Stage	Production Unit
Remark: 1. The above EUT's information was declared by manufacturer. Refer to the specifications or user's manual for more detailed description. 2. Either WLAN/Bluetooth module of FCC ID: PD97260NGU or WLAN/Bluetooth module of FCC ID: PPD-QCSNFA282 would be integrated into this host, and the identical WLAN antenna is used for either one module integration 3. Intel 7260NGW, Bluetooth Power and WALN SAR testing data is referenced in SGS Report for FCC ID: PD97260NGU, Report No: EN/2013/80004. 4. Qualcomm Atheros QCSNFA282, Bluetooth Power and WALN SAR testing data is referenced in Sporton Report for FCC ID: PPD-QCSNFA282, Report No: FA383112 Rev.01	

Host Information	
Host Name	Tablet PC
Brand Name	Dell
Model Name	T07G
Wireless Technology	<ul style="list-style-type: none"> • 802.11 a/b/g/n HT20/HT40 • Bluetooth v2.1+EDR, Bluetooth v4.0+LE • NFC
Antenna Type	WWAN: PIFA Antenna WLAN: PIFA Antenna Bluetooth: PIFA Antenna NFC: Loop Antenna



3.2 Maximum RF output power among production units

Band	average power (dBm)			
	GSM 850		GSM 1900	
Output Power Status	Full power mode	Reduced Power mode	Full power mode	Reduced Power mode
GPRS (GMSK, 1 Tx slot)	33.50	30.00	30.50	27.50
GPRS (GMSK, 2 Tx slots)	33.00	27.00	30.00	24.50
EDGE (8PSK, 1 Tx slot)	28.00	28.00	27.00	23.00
EDGE (8PSK, 2 Tx slots)	27.00	27.00	26.00	22.00
EDGE (8PSK, 3 Tx slots)	27.00	25.00	26.00	22.00
EDGE (8PSK, 4 Tx slots)	27.00	24.00	26.00	21.50

Band	average power(dBm)					
	WCDMA Band V		WCDMA Band IV		WCDMA Band II	
Output Power Status	Full power mode	Reduced Power mode	Full power mode	Reduced Power mode	Full power mode	Reduced Power mode
RMC 12.2Kbps	24.00	18.50	24.00	18.00	24.00	18.00
HSDPA Subtest-1	24.00	18.50	24.00	18.00	24.00	18.00
DC-HSDPA Subtest-1	24.00	18.50	24.00	18.00	24.00	18.00
HSUPA Subtest-1	24.00	18.50	24.00	18.00	24.00	18.00

Band	average power(dBm)					
	CDMA BC10		CDMA BC0		CDMA BC1	
Output Power Status	Full power mode	Reduced Power mode	Full power mode	Reduced Power mode	Full power mode	Reduced Power mode
1xRTT RC1 SO55	24.50	20.50	24.50	20.50	24.50	18.00
1xRTT RC3 SO55	24.50	20.50	24.50	20.50	24.50	18.00
1xEV-DO Rev 0 (RTAP 153.6kbps)	24.50	20.50	24.50	20.50	24.50	18.00
1xEV-DO Rev A (RETAP 4096 bits)	24.50	20.50	24.50	20.50	24.50	18.00

LTE Band 13						
average power(dBm)						
Modulation	BW (MHz)	RB size	Full Power mode (MPR)	Full power mode	Reduced Power mode (MPR)	Reduced Power mode
QPSK	10	≤ 12	0	24.00	0	20.00
QPSK	10	> 12	1	23.00	0	20.00
16QAM	10	≤ 12	1	23.00	0	20.00
16QAM	10	> 12	2	22.00	0	20.00
QPSK	5	≤ 8	0	24.00	0	20.00
QPSK	5	> 8	1	23.00	0	20.00
16QAM	5	≤ 8	1	23.00	0	20.00
16QAM	5	> 8	2	22.00	0	20.00



LTE Band 17						
average power(dBm)						
Modulation	BW (MHz)	RB size	Full Power mode (MPR)	Full power mode	Reduced Power mode (MPR)	Reduced Power mode
QPSK	10	≤ 12	0	24.00	0	21.00
QPSK	10	> 12	1	23.00	0	21.00
16QAM	10	≤ 12	1	23.00	0	21.00
16QAM	10	> 12	2	22.00	0	21.00
QPSK	5	≤ 8	0	24.00	0	21.00
QPSK	5	> 8	1	23.00	0	21.00
16QAM	5	≤ 8	1	23.00	0	21.00
16QAM	5	> 8	2	22.00	0	21.00

LTE Band 5						
average power(dBm)						
Modulation	BW (MHz)	RB size	Full Power mode (MPR)	Full power mode	Reduced Power mode (MPR)	Reduced Power mode
QPSK	10	≤ 12	0	24.00	0	20.00
QPSK	10	> 12	1	23.00	0	20.00
16QAM	10	≤ 12	1	23.00	0	20.00
16QAM	10	> 12	2	22.00	0	20.00
QPSK	5	≤ 8	0	24.00	0	20.00
QPSK	5	> 8	1	23.00	0	20.00
16QAM	5	≤ 8	1	23.00	0	20.00
16QAM	5	> 8	2	22.00	0	20.00

LTE Band 4						
average power(dBm)						
Modulation	BW (MHz)	RB size	Full Power mode (MPR)	Full power mode	Reduced Power mode (MPR)	Reduced Power mode
QPSK	20	≤ 18	0	24.00	0	18.00
QPSK	20	> 18	1	23.00	0	18.00
16QAM	20	≤ 18	1	23.00	0	18.00
16QAM	20	> 18	2	22.00	0	18.00
QPSK	15	≤ 16	0	24.00	0	18.00
QPSK	15	> 16	1	23.00	0	18.00
16QAM	15	≤ 16	1	23.00	0	18.00
16QAM	15	> 16	2	22.00	0	18.00
QPSK	10	≤ 12	0	24.00	0	18.00
QPSK	10	> 12	1	23.00	0	18.00
16QAM	10	≤ 12	1	23.00	0	18.00
16QAM	10	> 12	2	22.00	0	18.00
QPSK	5	≤ 8	0	24.00	0	18.00
QPSK	5	> 8	1	23.00	0	18.00
16QAM	5	≤ 8	1	23.00	0	18.00
16QAM	5	> 8	2	22.00	0	18.00



LTE Band 2						
average power(dBm)						
Modulation	BW (MHz)	RB size	Full Power mode (MPR)	Full power mode	Reduced Power mode (MPR)	Reduced Power mode
QPSK	20	≤ 18	0	24.00	0	18.00
QPSK	20	> 18	1	23.00	0	18.00
16QAM	20	≤ 18	1	23.00	0	18.00
16QAM	20	> 18	2	22.00	0	18.00
QPSK	15	≤ 16	0	24.00	0	18.00
QPSK	15	> 16	1	23.00	0	18.00
16QAM	15	≤ 16	1	23.00	0	18.00
16QAM	15	> 16	2	22.00	0	18.00
QPSK	10	≤ 12	0	24.00	0	18.00
QPSK	10	> 12	1	23.00	0	18.00
16QAM	10	≤ 12	1	23.00	0	18.00
16QAM	10	> 12	2	22.00	0	18.00
QPSK	5	≤ 8	0	24.00	0	18.00
QPSK	5	> 8	1	23.00	0	18.00
16QAM	5	≤ 8	1	23.00	0	18.00
16QAM	5	> 8	2	22.00	0	18.00

LTE Band 25						
average power(dBm)						
Modulation	BW (MHz)	RB size	Full Power mode (MPR)	Full power mode	Reduced Power mode (MPR)	Reduced Power mode
QPSK	20	≤ 18	0	24.00	0	18.00
QPSK	20	> 18	1	23.00	0	18.00
16QAM	20	≤ 18	1	23.00	0	18.00
16QAM	20	> 18	2	22.00	0	18.00
QPSK	15	≤ 16	0	24.00	0	18.00
QPSK	15	> 16	1	23.00	0	18.00
16QAM	15	≤ 16	1	23.00	0	18.00
16QAM	15	> 16	2	22.00	0	18.00
QPSK	10	≤ 12	0	24.00	0	18.00
QPSK	10	> 12	1	23.00	0	18.00
16QAM	10	≤ 12	1	23.00	0	18.00
16QAM	10	> 12	2	22.00	0	18.00
QPSK	5	≤ 8	0	24.00	0	18.00
QPSK	5	> 8	1	23.00	0	18.00
16QAM	5	≤ 8	1	23.00	0	18.00
16QAM	5	> 8	2	22.00	0	18.00

Remark:

1. By design, maximum LTE RF power of smaller supported bandwidth does not exceed the RF power of largest supported bandwidth; the information is included in "tune-up procedure" exhibit



The table below summarized necessary items addressed in KDB 941225 D05 v02.

FCC ID	N7NEM7355-D1							
EUT	PCIe wireless WAN card							
Operating Frequency Range of each LTE transmission band	LTE Band 17: 706.5 MHz ~ 713.5 MHz LTE Band 13: 779.5 MHz ~ 784.5 MHz LTE Band 5: 824.7 MHz ~ 848.3 MHz LTE Band 4: 1710.7 MHz ~ 1754.3 MHz LTE Band 2: 1850.7 MHz ~ 1909.3 MHz LTE Band 25: 1850.7 MHz ~ 1914.3 MHz							
Channel Bandwidth	LTE Band 17: 5MHz, 10MHz LTE Band 13: 5MHz, 10MHz LTE Band 5: 5MHz, 10MHz LTE Band 4: 5MHz, 10MHz, 15MHz, 20MHz LTE Band 2: 5MHz, 10MHz, 15MHz, 20MHz LTE Band 25: 5MHz, 10MHz, 15MHz, 20MHz							
Transmission (H, M, L) channel numbers and frequencies in each LTE band								
Band 17								
	Bandwidth 5 MHz				Bandwidth 10 MHz			
	Channel #		Frequency (MHz)		Channel #		Frequency (MHz)	
L	23755		706.5		23780		709	
M	23790		710		23790		710	
H	23825		713.5		23800		711	
Band 13								
	Bandwidth 5 MHz				Bandwidth 10 MHz			
	Channel #		Frequency (MHz)		Channel #		Frequency (MHz)	
L	23205		779.5		23230		782	
M	23230		782					
H	23255		784.5					
LTE Band 5								
	Bandwidth 5 MHz				Bandwidth 10 MHz			
	Ch. #		Freq. (MHz)		Ch. #		Freq. (MHz)	
L	20425		826.5		20450		829	
M	20525		836.5		20525		836.5	
H	20625		846.5		20600		844	
LTE Band 4								
	Bandwidth 5 MHz		Bandwidth 10 MHz		Bandwidth 15 MHz		Bandwidth 20 MHz	
	Ch. #	Freq. (MHz)	Ch. #	Freq. (MHz)	Ch. #	Freq. (MHz)	Ch. #	Freq. (MHz)
L	19975	1712.5	20000	1715	20025	1717.5	20050	1720
M	20175	1732.5	20175	1732.5	20175	1732.5	20175	1732.5
H	20375	1752.5	20350	1750	20325	1747.5	20300	1745
LTE Band 2								
	Bandwidth 5 MHz		Bandwidth 10 MHz		Bandwidth 15 MHz		Bandwidth 20 MHz	
	Ch. #	Freq. (MHz)	Ch. #	Freq. (MHz)	Ch. #	Freq. (MHz)	Ch. #	Freq. (MHz)
L	18625	1852.5	18650	1855	18675	1857.5	18700	1860
M	18900	1880	18900	1880	18900	1880	18900	1880
H	19175	1907.5	19150	1905	19125	1902.5	19100	1900
LTE Band 25								
	Bandwidth 5 MHz		Bandwidth 10 MHz		Bandwidth 15 MHz		Bandwidth 20 MHz	
	Ch. #	Freq. (MHz)	Ch. #	Freq. (MHz)	Ch. #	Freq. (MHz)	Ch. #	Freq. (MHz)
L	26065	1852.5	26090	1855	26115	1857.5	26140	1860
M	26365	1882.5	26365	1882.5	26365	1882.5	26365	1882.5
H	26665	1912.5	26640	1910	26615	1907.5	26590	1905



LTE category, uplink modulations used	Category 3, QPSK, and 16QAM																																						
LTE transmitter and antenna implementation (standalone or sharing hardware components / antennas)	A primary antenna is used for LTE and other wireless interfaces (GSM/CDMA/WCDMA) for transmitting and receiving. LTE and other wireless interfaces (GSM/CDMA/WCDMA) share the same antenna, and cannot transmit simultaneously A 2 nd antenna is used for LTE and other wireless interfaces (GSM/CDMA/WCDMA) for receiving only																																						
LTE Voice / Data requirements	Data only																																						
LTE MPR permanently built-in by design	Yes, per 3GPP TS 36.101 v11.0.0 Table 6.2.3-1: Maximum Power Reduction (MPR) for Power Class 3 <table border="1"> <thead> <tr> <th rowspan="2">Modulation</th> <th colspan="6">Channel bandwidth / Transmission bandwidth (RB)</th> <th rowspan="2">MPR (dB)</th> </tr> <tr> <th>1.4 MHz</th> <th>3.0 MHz</th> <th>5 MHz</th> <th>10 MHz</th> <th>15 MHz</th> <th>20 MHz</th> </tr> </thead> <tbody> <tr> <td>QPSK</td> <td>> 5</td> <td>> 4</td> <td>> 8</td> <td>> 12</td> <td>> 16</td> <td>> 18</td> <td>≤ 1</td> </tr> <tr> <td>16 QAM</td> <td>≤ 5</td> <td>≤ 4</td> <td>≤ 8</td> <td>≤ 12</td> <td>≤ 16</td> <td>≤ 18</td> <td>≤ 1</td> </tr> <tr> <td>16 QAM</td> <td>> 5</td> <td>> 4</td> <td>> 8</td> <td>> 12</td> <td>> 16</td> <td>> 18</td> <td>≤ 2</td> </tr> </tbody> </table>	Modulation	Channel bandwidth / Transmission bandwidth (RB)						MPR (dB)	1.4 MHz	3.0 MHz	5 MHz	10 MHz	15 MHz	20 MHz	QPSK	> 5	> 4	> 8	> 12	> 16	> 18	≤ 1	16 QAM	≤ 5	≤ 4	≤ 8	≤ 12	≤ 16	≤ 18	≤ 1	16 QAM	> 5	> 4	> 8	> 12	> 16	> 18	≤ 2
Modulation	Channel bandwidth / Transmission bandwidth (RB)						MPR (dB)																																
	1.4 MHz	3.0 MHz	5 MHz	10 MHz	15 MHz	20 MHz																																	
QPSK	> 5	> 4	> 8	> 12	> 16	> 18	≤ 1																																
16 QAM	≤ 5	≤ 4	≤ 8	≤ 12	≤ 16	≤ 18	≤ 1																																
16 QAM	> 5	> 4	> 8	> 12	> 16	> 18	≤ 2																																
LTE A-MPR	In the base station simulator configuration, Network Setting value is set to NS_01 to disable A-MPR during SAR testing.																																						
Base station simulator used for Testing	Anritsu MT8820C																																						
Power reduction applied to satisfy SAR compliance	Yes, proximity sensor triggered power reduction implemented on the host, T07G.																																						



3.3 Applied Standard

The Specific Absorption Rate (SAR) testing specification, method, and procedure for this device is in accordance with the following standards:

- FCC 47 CFR Part 2 (2.1093)
- ANSI/IEEE C95.1-1992
- IEEE 1528-2003
- FCC KDB 865664 D01 v01r01
- FCC KDB 447498 D01 v05r01
- FCC KDB 616217 D04 v01r01
- FCC KDB 941225 D01 v02
- FCC KDB 941225 D02 v02r02
- FCC KDB 941225 D03 v01
- FCC KDB 941225 D05 v02r02

3.4 Device Category and SAR Limits

This device belongs to portable device category because its radiating structure is allowed to be used within 20 centimeters of the body of the user. Limit for General Population/Uncontrolled exposure should be applied for this device, it is 1.6 W/kg as averaged over any 1 gram of tissue.

3.5 Test Conditions

3.5.1 Ambient Condition

Ambient Temperature	20 to 24 °C
Humidity	< 60 %

3.5.2 Test Configuration

For WWAN SAR testing, the device was controlled by using a base station emulator. Communication between the device and the emulator was established by air link. The distance between the EUT and the antenna of the emulator is larger than 50 cm and the output power radiated from the emulator antenna is at least 30 dB smaller than the output power of EUT.



Target Power reduction applied for each wireless mode and orientation

Exposure Position / wireless mode	Bottom Face ⁽¹⁾	Edge 1 ⁽¹⁾	Edge 2	Edge 3	Edge 4
GSM850 GPRS (GMSK 1 Tx slot)	3.5 dB	3.5 dB	0 dB	0 dB	0 dB
GSM850 GPRS (GMSK 2 Tx slots)	6.0 dB	6.0 dB	0 dB	0 dB	0 dB
GSM850 EDGE (8PSK 1 Tx slot)	0.0 dB	0.0 dB	0 dB	0 dB	0 dB
GSM850 EDGE (8PSK 2 Tx slots)	0.0 dB	0.0 dB	0 dB	0 dB	0 dB
GSM850 EDGE (8PSK 3 Tx slots)	2.0 dB	2.0 dB	0 dB	0 dB	0 dB
GSM850 EDGE (8PSK 4 Tx slots)	3.0 dB	3.0 dB	0 dB	0 dB	0 dB
GSM1900 GPRS (GMSK 1 Tx slot)	3.0 dB	3.0 dB	0 dB	0 dB	0 dB
GSM1900 GPRS (GMSK 2 Tx slots)	5.5 dB	5.5 dB	0 dB	0 dB	0 dB
GSM1900 EDGE (8PSK 1 Tx slot)	4.0 dB	4.0 dB	0 dB	0 dB	0 dB
GSM1900 EDGE (8PSK 2 Tx slots)	4.0 dB	4.0 dB	0 dB	0 dB	0 dB
GSM1900 EDGE (8PSK 3 Tx slots)	4.0 dB	4.0 dB	0 dB	0 dB	0 dB
GSM1900 EDGE (8PSK 4 Tx slots)	4.5 dB	4.5 dB	0 dB	0 dB	0 dB
WCDMA Band V	5.5 dB	5.5 dB	0 dB	0 dB	0 dB
WCDMA Band IV	6.0 dB	6.0 dB	0 dB	0 dB	0 dB
WCDMA Band II	6.0 dB	6.0 dB	0 dB	0 dB	0 dB
CDMA2000 BC10	4.0 dB	4.0 dB	0 dB	0 dB	0 dB
CDMA2000 BC0	4.0 dB	4.0 dB	0 dB	0 dB	0 dB
CDMA2000 BC1	6.5 dB	6.5 dB	0 dB	0 dB	0 dB
LTE Band 13	4.0 dB	4.0 dB	0 dB	0 dB	0 dB
LTE Band 17	3.0 dB	3.0 dB	0 dB	0 dB	0 dB
LTE Band 5	4.0 dB	4.0 dB	0 dB	0 dB	0 dB
LTE Band 4	6.0 dB	6.0 dB	0 dB	0 dB	0 dB
LTE Band 2	6.0 dB	6.0 dB	0 dB	0 dB	0 dB
LTE Band 25	6.0 dB	6.0 dB	0 dB	0 dB	0 dB

Remark:

- 1. ⁽¹⁾: Reduced maximum limit applied by activation of proximity sensor.



Measurement on EUT:

Band/Mode	Ch #	Measured power reduction (dBm)		Reduction Level
		w/o power back-off	w/ power back-off	(dB)
GSM850 GPRS (GMSK 2 Tx slot)	189	31.25	26.88	4.37
GSM1900 GPRS (GMSK 2 Tx slot)	661	28.66	24.08	4.58
WCDMA Band V (RMC 12.2Kbps)	4182	22.06	18.29	3.77
WCDMA Band IV (RMC 12.2Kbps)	1413	22.37	18.39	3.98
WCDMA Band II (RMC 12.2Kbps)	9400	22.55	17.84	4.71
EVDO BC10 (RTAP 153.6Kbps)	580	23.35	20.36	2.99
EVDO BC0 (RTAP 153.6Kbps)	384	23.26	20.42	2.84
EVDO BC1 (RTAP 153.6Kbps)	600	23.86	17.96	5.90
LTE Band 17 1RB 0offset	23790	22.50	19.66	2.84
LTE Band 13 1RB 0offset	23230	22.43	19.40	3.03
LTE Band 5 1RB 0offset	20525	22.28	19.18	3.10
LTE Band 4 1RB 0offset	20175	22.63	17.80	4.83
LTE Band 2 1RB 99offset	18900	22.84	17.95	4.89
LTE Band 25 1RB 49offset	26365	22.73	17.81	4.92

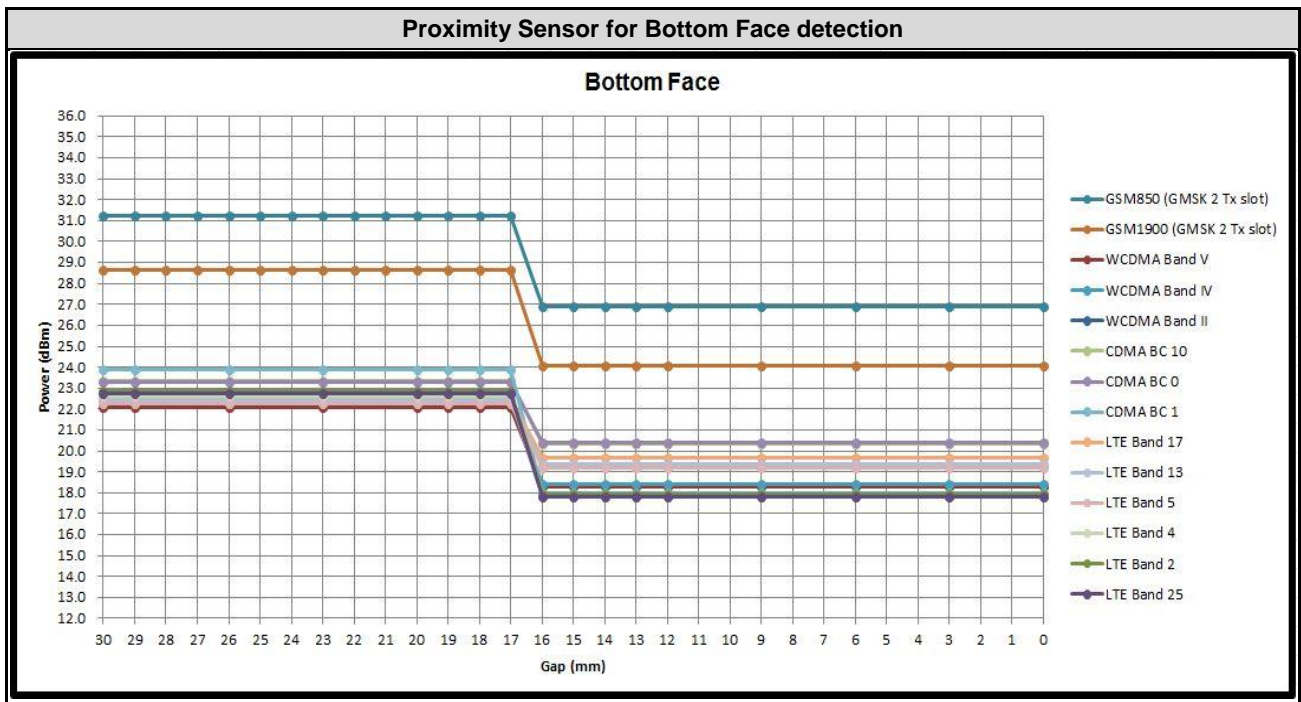

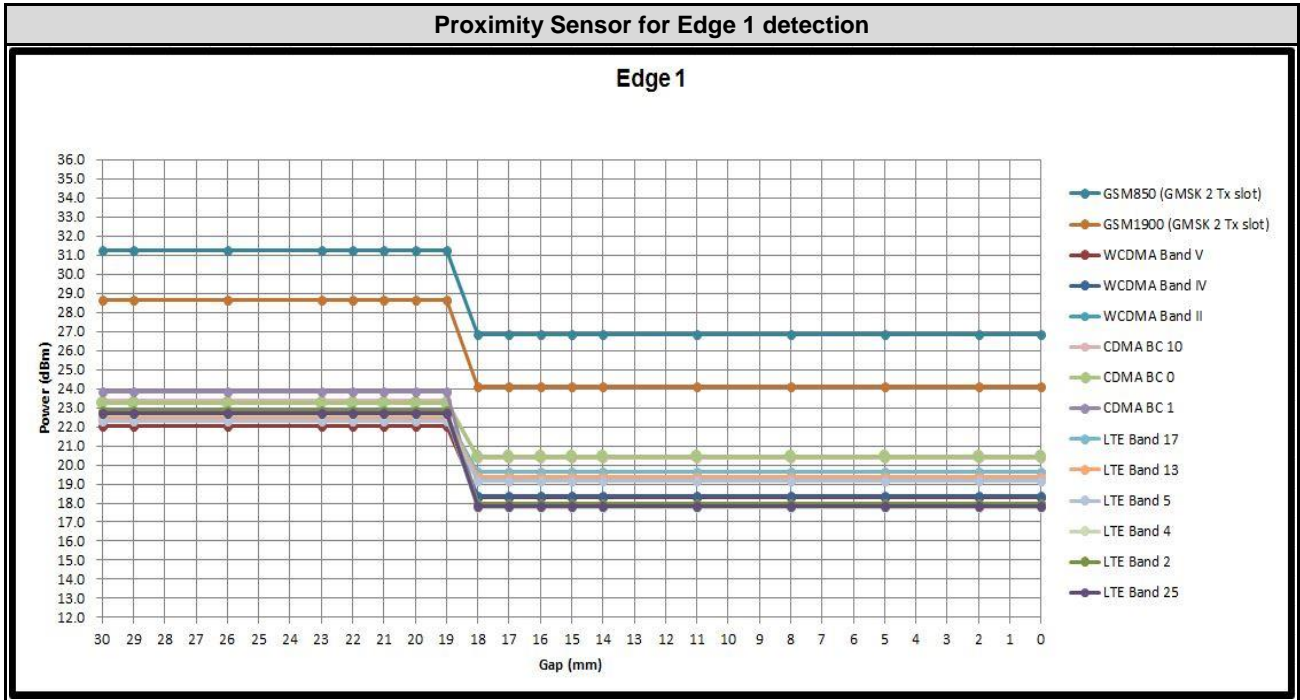

4. Specific Absorption Rate (SAR)

4.1 Introduction

SAR is related to the rate at which energy is absorbed per unit mass in an object exposed to a radio field. The SAR distribution in a biological body is complicated and is usually carried out by experimental techniques or numerical modeling. The standard recommends limits for two tiers of groups, occupational/controlled and general population/uncontrolled, based on a person's awareness and ability to exercise control over his or her exposure. In general, occupational/controlled exposure limits are higher than the limits for general population/uncontrolled.

4.2 SAR Definition

The SAR definition is the time derivative (rate) of the incremental energy (dW) absorbed by (dissipated in) an incremental mass (dm) contained in a volume element (dv) of a given density (ρ). The equation description is as below:

$$\text{SAR} = \frac{d}{dt} \left(\frac{dW}{dm} \right) = \frac{d}{dt} \left(\frac{dW}{\rho dv} \right)$$

SAR is expressed in units of Watts per kilogram (W/kg)

SAR measurement can be either related to the temperature elevation in tissue by

$$\text{SAR} = C \left(\frac{\delta T}{\delta t} \right)$$

Where: C is the specific heat capacity, δT is the temperature rise and δt is the exposure duration, or related to the electrical field in the tissue by

$$\text{SAR} = \frac{\sigma |E|^2}{\rho}$$

Where: σ is the conductivity of the tissue, ρ is the mass density of the tissue and E is the RMS electrical field strength.

However for evaluating SAR of low power transmitter, electrical field measurement is typically applied.

5. SAR Measurement System

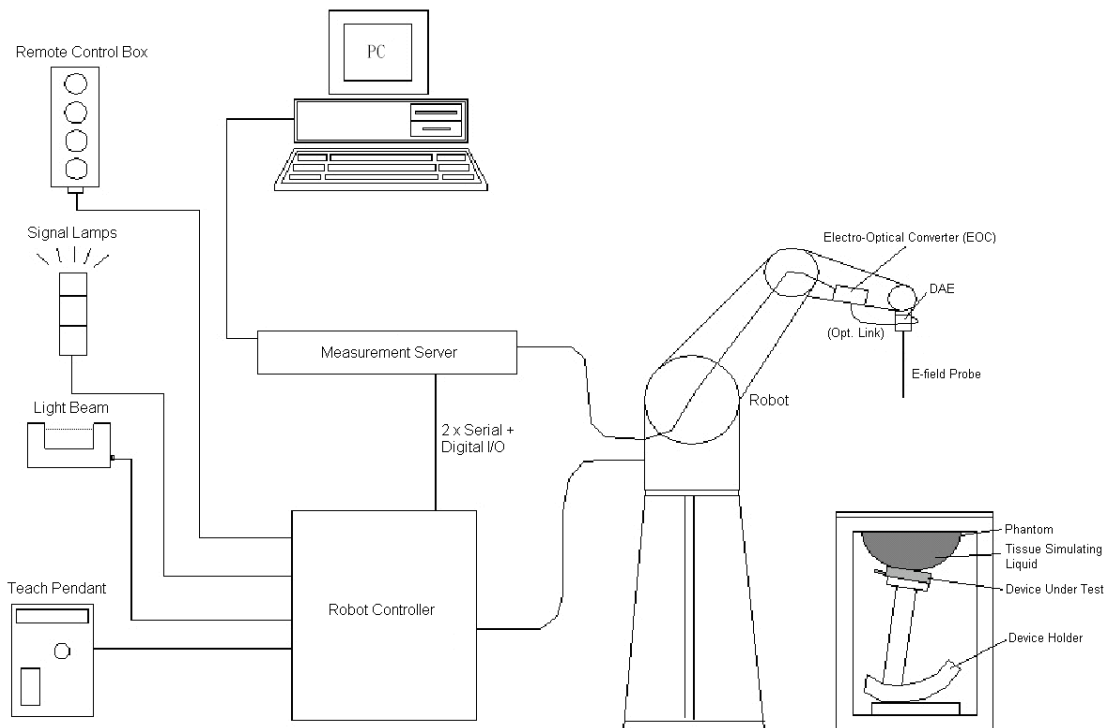

Fig 5.1 SPEAG DASY System Configurations

The DASY system for performance compliance tests is illustrated above graphically. This system consists of the following items:

- A standard high precision 6-axis robot with controller, a teach pendant and software
- A data acquisition electronic (DAE) attached to the robot arm extension
- A dosimetric probe equipped with an optical surface detector system
- The electro-optical converter (EOC) performs the conversion between optical and electrical signals
- A measurement server performs the time critical tasks such as signal filtering, control of the robot operation and fast movement interrupts.
- A probe alignment unit which improves the accuracy of the probe positioning
- A computer operating Windows XP
- DASY software
- Remote control with teach pendant and additional circuitry for robot safety such as warning lamps, etc.
- The SAM twin phantom
- A device holder
- Tissue simulating liquid
- Dipole for evaluating the proper functioning of the system

Component details are described in in the following sub-sections.

5.1 E-Field Probe

The SAR measurement is conducted with the dosimetric probe (manufactured by SPEAG). The probe is specially designed and calibrated for use in liquid with high permittivity. The dosimetric probe has special calibration in liquid at different frequency. This probe has a built in optical surface detection system to prevent from collision with phantom.

5.1.1 E-Field Probe Specification

<ET3DV6 Probe >

Construction	Symmetrical design with triangular core Built-in optical fiber for surface detection system. Built-in shielding against static charges. PEEK enclosure material (resistant to organic solvents, e.g., DGBE)	 <p>Fig 5.2 Photo of ET3DV6</p>
Frequency	10 MHz to 3 GHz; Linearity: ± 0.2 dB	
Directivity	± 0.2 dB in HSL (rotation around probe axis) ± 0.4 dB in HSL (rotation normal to probe axis)	
Dynamic Range	5 μ W/g to 100 mW/g; Linearity: ± 0.2 dB	
Dimensions	Overall length: 330 mm (Tip: 16 mm) Tip diameter: 6.8 mm (Body: 12 mm) Distance from probe tip to dipole centers: 2.7 mm	

<EX3DV4 Probe>

Construction	Symmetrical design with triangular core Built-in shielding against static charges PEEK enclosure material (resistant to organic solvents, e.g., DGBE)	 <p>Fig 5.3 Photo of EX3DV4/ES3DV4</p>
Frequency	10 MHz to 6 GHz; Linearity: ± 0.2 dB	
Directivity	± 0.3 dB in HSL (rotation around probe axis) ± 0.5 dB in tissue material (rotation normal to probe axis)	
Dynamic Range	10 μ W/g to 100 mW/g; Linearity: ± 0.2 dB (noise: typically < 1 μ W/g)	
Dimensions	Overall length: 330 mm (Tip: 20 mm) Tip diameter: 2.5 mm (Body: 12 mm) Typical distance from probe tip to dipole centers: 1 mm	

5.1.2 E-Field Probe Calibration

Each probe needs to be calibrated according to a dosimetric assessment procedure with accuracy better than $\pm 10\%$. The spherical isotropy shall be evaluated and within ± 0.25 dB. The sensitivity parameters (NormX, NormY, and NormZ), the diode compression parameter (DCP) and the conversion factor (ConvF) of the probe are tested. The calibration data can be referred to appendix C of this report.

5.2 Data Acquisition Electronics (DAE)

The data acquisition electronics (DAE) consists of a highly sensitive electrometer-grade preamplifier with auto-zeroing, a channel and gain-switching multiplexer, a fast 16 bit AD-converter and a command decoder and control logic unit. Transmission to the measurement server is accomplished through an optical downlink for data and status information as well as an optical uplink for commands and the clock. The input impedance of the DAE is 200 MOhm; the inputs are symmetrical and floating. Common mode rejection is above 80 dB.



Fig 5.4 Photo of DAE

5.3 Robot

The SPEAG DASY system uses the high precision robots (DASY4: RX90BL; DASY5: TX90XL) type from Stäubli SA (France). For the 6-axis controller system, the robot controller version (DASY4: CS7MB; DASY5: CS8c) from Stäubli is used. The Stäubli robot series have many features that are important for our application:

- High precision (repeatability ± 0.035 mm)
- High reliability (industrial design)
- Jerk-free straight movements
- Low ELF interference (the closed metallic construction shields against motor control fields)



Fig 5.5 Photo of DASY4



Fig 5.6 Photo of DASY5

5.4 Measurement Server

The measurement server is based on a PC/104 CPU board with CPU (DASY4: 166 MHz, Intel Pentium; DASY5: 400 MHz, Intel Celeron), chipdisk (DASY4: 32 MB; DASY5: 128 MB), RAM (DASY4: 64 MB, DASY5: 128 MB). The necessary circuits for communication with the DAE electronic box, as well as the 16 bit AD converter system for optical detection and digital I/O interface are contained on the DASY I/O board, which is directly connected to the PC/104 bus of the CPU board.

The measurement server performs all the real-time data evaluation for field measurements and surface detection, controls robot movements and handles safety operations.



Fig 5.7 Photo of Server for DASY4



Fig 5.8 Photo of Server for DASY5

5.5 Phantom

<SAM Twin Phantom>

Shell Thickness	2 ± 0.2 mm; Center ear point: 6 ± 0.2 mm
Filling Volume	Approx. 25 liters
Dimensions	Length: 1000 mm; Width: 500 mm; Height: adjustable feet
Measurement Areas	Left Hand, Right Hand, Flat Phantom



Fig 5.9 Photo of SAM Phantom

The bottom plate contains three pair of bolts for locking the device holder. The device holder positions are adjusted to the standard measurement positions in the three sections. A white cover is provided to tap the phantom during off-periods to prevent water evaporation and changes in the liquid parameters. On the phantom top, three reference markers are provided to identify the phantom position with respect to the robot.

<ELI4 Phantom>

Shell Thickness	2 ± 0.2 mm (sagging: <1%)
Filling Volume	Approx. 30 liters
Dimensions	Major ellipse axis: 600 mm Minor axis: 400 mm



Fig 5.10 Photo of ELI4 Phantom

The ELI4 phantom is intended for compliance testing of handheld and body-mounted wireless devices in the frequency range of 30 MHz to 6 GHz. ELI4 is fully compatible with standard and all known tissue simulating liquids.

5.6 Device Holder

<Device Holder for SAM Twin Phantom>

The SAR in the phantom is approximately inversely proportional to the square of the distance between the source and the liquid surface. For a source at 5 mm distance, a positioning uncertainty of ± 0.5 mm would produce a SAR uncertainty of ± 20 %. Accurate device positioning is therefore crucial for accurate and repeatable measurements. The positions in which the devices must be measured are defined by the standards.

The DASY device holder is designed to cope with different positions given in the standard. It has two scales for the device rotation (with respect to the body axis) and the device inclination (with respect to the line between the ear reference points). The rotation center for both scales is the ear reference point (ERP). Thus the device needs no repositioning when changing the angles.

The DASY device holder is constructed of low-loss POM material having the following dielectric parameters: relative permittivity $\epsilon = 3$ and loss tangent $\delta = 0.02$. The amount of dielectric material has been reduced in the closest vicinity of the device, since measurements have suggested that the influence of the clamp on the test results could thus be lowered.



Fig 5.11 Device Holder

<Laptop Extension Kit>

The extension is lightweight and made of POM, acrylic glass and foam. It fits easily on the upper part of the mounting device in place of the phone positioned. The extension is fully compatible with the SAM Twin and ELI phantoms.

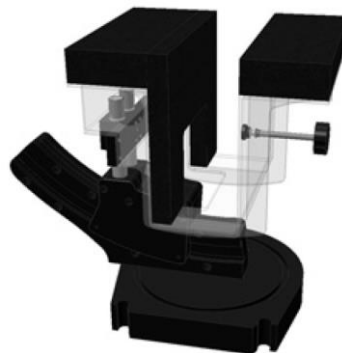

Fig 5.12 Laptop Extension Kit



5.7 Data Storage and Evaluation

5.7.1 Data Storage

The DASY software stores the assessed data from the data acquisition electronics as raw data (in microvolt readings from the probe sensors), together with all the necessary software parameters for the data evaluation (probe calibration data, liquid parameters and device frequency and modulation data) in measurement files. The post-processing software evaluates the desired unit and format for output each time the data is visualized or exported. This allows verification of the complete software setup even after the measurement and allows correction of erroneous parameter settings. For example, if a measurement has been performed with an incorrect crest factor parameter in the device setup, the parameter can be corrected afterwards and the data can be reevaluated.

The measured data can be visualized or exported in different units or formats, depending on the selected probe type (e.g., [V/m], [A/m], [mW/g]). Some of these units are not available in certain situations or give meaningless results, e.g., a SAR-output in a non-lose media, will always be zero. Raw data can also be exported to perform the evaluation with other software packages.

5.7.2 Data Evaluation

The DASY post-processing software (SEMCAD) automatically executes the following procedures to calculate the field units from the microvolt readings at the probe connector. The parameters used in the evaluation are stored in the configuration modules of the software :

Probe parameters :	- Sensitivity	Norm _i , a _{i0} , a _{i1} , a _{i2}
	- Conversion factor	ConvF _i
	- Diode compression point	dcp _i
Device parameters :	- Frequency	f
	- Crest factor	cf
Media parameters :	- Conductivity	σ
	- Density	ρ

These parameters must be set correctly in the software. They can be found in the component documents or they can be imported into the software from the configuration files issued for the DASY components. In the direct measuring mode of the multi-meter option, the parameters of the actual system setup are used. In the scan visualization and export modes, the parameters stored in the corresponding document files are used.

The first step of the evaluation is a linearization of the filtered input signal to account for the compression characteristics of the detector diode. The compensation depends on the input signal, the diode type and the DC-transmission factor from the diode to the evaluation electronics. If the exciting field is pulsed, the crest factor of the signal must be known to correctly compensate for peak power.

The formula for each channel can be given as :

$$V_i = U_i + U_i^2 \cdot \frac{cf}{dcp_i}$$

with V_i = compensated signal of channel i, (i = x, y, z)
 U_i = input signal of channel i, (i = x, y, z)
 cf = crest factor of exciting field (DASY parameter)
 dcp_i = diode compression point (DASY parameter)

From the compensated input signals, the primary field data for each channel can be evaluated :

$$\text{E-field Probes : } E_i = \sqrt{\frac{V_i}{\text{Norm}_i \cdot \text{ConvF}}}$$

$$\text{H-field Probes : } H_i = \sqrt{V_i \cdot \frac{a_{i0} + a_{i1}f + a_{i2}f^2}{f}}$$

with V_i = compensated signal of channel i, (i = x, y, z)
 Norm_i = sensor sensitivity of channel i, (i = x, y, z), $\mu\text{V}/(\text{V/m})^2$ for E-field Probes
 ConvF = sensitivity enhancement in solution
 a_{ij} = sensor sensitivity factors for H-field probes
 f = carrier frequency [GHz]
 E_i = electric field strength of channel i in V/m
 H_i = magnetic field strength of channel i in A/m

The RSS value of the field components gives the total field strength (Hermitian magnitude) :

$$E_{\text{tot}} = \sqrt{E_x^2 + E_y^2 + E_z^2}$$

The primary field data are used to calculate the derived field units.

$$\text{SAR} = E_{\text{tot}}^2 \cdot \frac{\sigma}{\rho \cdot 1000}$$

with SAR = local specific absorption rate in mW/g
 E_{tot} = total field strength in V/m
 σ = conductivity in [mho/m] or [Siemens/m]
 ρ = equivalent tissue density in g/cm^3

Note that the density is set to 1, to account for actual head tissue density rather than the density of the tissue simulating liquid.



5.8 Test Equipment List

Manufacturer	Name of Equipment	Type/Model	Serial Number	Calibration	
				Last Cal.	Due Date
SPEAG	750MHz System Validation Kit	D750V3	1012	May. 28, 2013	May. 27, 2014
SPEAG	835MHz System Validation Kit	D835V2	499	Mar. 18, 2013	Mar. 17, 2014
SPEAG	1750MHz System Validation Kit	D1750V2	1068	Jun. 20, 2012	Jun. 19, 2014
SPEAG	1900MHz System Validation Kit	D1900V2	5d041	Mar. 20, 2013	Mar. 19, 2014
SPEAG	Data Acquisition Electronics	DAE3	577	May. 08, 2013	May. 07, 2014
SPEAG	Data Acquisition Electronics	DAE4	778	Aug. 21, 2013	Aug. 20, 2014
SPEAG	Data Acquisition Electronics	DAE3	495	May. 08, 2013	May. 07, 2014
SPEAG	Data Acquisition Electronics	DAE4	1338	May. 28, 2013	May. 27, 2014
SPEAG	Dosimetric E-Field Probe	ET3DV6R	1788	Oct. 23, 2012	Oct. 22, 2013
SPEAG	Dosimetric E-Field Probe	EX3DV4	3801	Jun. 20, 2013	Jun. 19, 2014
SPEAG	Dosimetric E-Field Probe	EX3DV4	3792	Jun. 04, 2013	Jun. 03, 2014
SPEAG	Dosimetric E-Field Probe	EX3DV4	3925	Jun. 12, 2013	Jun. 11, 2014
Wisewind	Thermometer	ETP-101	TM560	Nov. 13, 2012	Nov. 12, 2013
Wisewind	Thermometer	ETP-101	TM685	Nov. 13, 2012	Nov. 12, 2013
Wisewind	Thermometer	HTC-1	TM642	Nov. 13, 2012	Nov. 12, 2013
Wisewind	Thermometer	HTC-1	TM281	Nov. 13, 2012	Nov. 12, 2013
Anritsu	Radio Communication Analyzer	MT8820C	6201074414	Dec. 11, 2012	Dec. 10, 2014
Agilent	Wireless Communication Test Set	E5515C	MY50266977	May. 06, 2013	May. 05, 2015
R&S	Radio communication Tester	CMW500	116160	Jan. 09, 2013	Jan. 08, 2014
SPEAG	Device Holder	N/A	N/A	NCR	NCR
Agilent	ESG Vector Series Signal Generator	E4438C	MY49070755	Oct. 02, 2012	Oct. 01, 2013
Agilent	ENA Network Analyzer	E5071C	MY46316648	Feb. 07, 2013	Feb. 06, 2014
SPEAG	Dielectric Probe Kit	DAK-3.5	1126	Jul. 23, 2013	Jul. 22, 2014
Anritsu	Power Meter	ML2495A	1218006	Oct. 22, 2012	Oct. 21, 2013
Anritsu	Power Sensor	MA2411B	1207363	Oct. 24, 2012	Oct. 23, 2013
Agilent	Dual Directional Coupler	778D	50422	Note 4	
Woken	Attenuator 1	WK0602-XX	N/A	Note 4	
PE	Attenuator 2	PE7005-10	N/A	Note 4	
PE	Attenuator 3	PE7005-3	N/A	Note 4	
AR	Power Amplifier	5S1G4M2	0328767	Note 5	
R&S	Spectrum Analyzer	FSP 7	101131	Jul. 09, 2013	Jul. 08, 2014

Table 5.1 Test Equipment List

Note:

- The calibration certificate of DASY can be referred to appendix C of this report.
- Referring to KDB 865664 D01v01r01, the dipole calibration interval can be extended to 3 years with justification. The dipoles are also not physically damaged, or repaired during the interval.
- The justification data of dipole D1750V2, SN: 1068 can be found in appendix C. The return loss is < -20dB, within 20% of prior calibration, the impedance is within 5 ohm of prior calibration.
- The Insertion Loss calibration of Dual Directional Coupler and Attenuator were characterized via the network analyzer and compensated during system check.
- In system check we need to monitor the level on the power meter, and adjust the power amplifier level to have precise power level to the dipole; the measured SAR will be normalized to 1W input power according to the ratio of 1W to the input power to the dipole. For system check, the calibration of the power amplifier is deemed not critically required for correct measurement; the power meter is critical and we do have calibration for it
- Attenuator 1 insertion loss is calibrated by the network Analyzer, which the calibration is valid, before system check.

6. Tissue Simulating Liquids

For the measurement of the field distribution inside the SAM phantom with DASY, the phantom must be filled with around 25 liters of homogeneous body tissue simulating liquid. For head SAR testing, the liquid height from the ear reference point (ERP) of the phantom to the liquid top surface is larger than 15 cm, which is shown in Fig. 6.1. For body SAR testing, the liquid height from the center of the flat phantom to the liquid top surface is larger than 15 cm, which is shown in Fig. 6.2.

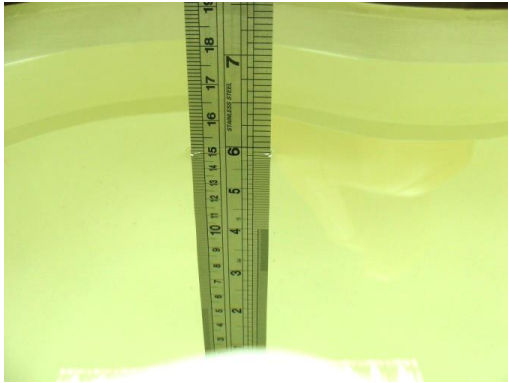

Fig 6.1 Photo of Liquid Height for Head SAR



Fig 6.2 Photo of Liquid Height for Body SAR

The following table gives the recipes for tissue simulating liquid.

Frequency (MHz)	Water (%)	Sugar (%)	Cellulose (%)	Salt (%)	Preventol (%)	DGBE (%)	Conductivity (σ)	Permittivity (ϵ_r)
For Head								
750	41.1	57.0	0.2	1.4	0.2	0	0.89	41.9
835	40.3	57.9	0.2	1.4	0.2	0	0.90	41.5
900	40.3	57.9	0.2	1.4	0.2	0	0.97	41.5
1800, 1900, 2000	55.2	0	0	0.3	0	44.5	1.40	40.0
2450	55.0	0	0	0	0	45.0	1.80	39.2
For Body								
750	51.7	47.2	0	0.9	0.1	0	0.96	55.5
835	50.8	48.2	0	0.9	0.1	0	0.97	55.2
900	50.8	48.2	0	0.9	0.1	0	1.05	55.0
1800, 1900, 2000	70.2	0	0	0.4	0	29.4	1.52	53.3
2450	68.6	0	0	0	0	31.4	1.95	52.7

Table 6.1 Recipes of Tissue Simulating Liquid

Simulating Liquid for 5G, Manufactured by SPEAG

Ingredients	(% by weight)
Water	64~78%
Mineral oil	11~18%
Emulsifiers	9~15%
Additives and Salt	2~3%



The dielectric parameters of the liquids were verified prior to the SAR evaluation using an SPEAG DAK-3.5 Dielectric Probe Kit and an Agilent Network Analyzer.

The following table shows the measuring results for simulating liquid.

Frequency (MHz)	Liquid Type	Liquid Temp. (°C)	Conductivity (σ)	Permittivity (ϵ_r)	Conductivity Target (σ)	Permittivity Target (ϵ_r)	Delta (σ) (%)	Delta (ϵ_r) (%)	Limit (%)	Date
750	Body	22.3	0.970	54.642	0.96	55.5	1.04	-1.55	±5	2013/9/24
750	Body	22.8	0.973	54.284	0.96	55.5	1.35	-2.19	±5	2013/9/27
835	Body	22.3	0.985	54.535	0.97	55.2	1.55	-1.20	±5	2013/9/20
835	Body	22.3	0.963	54.529	0.97	55.2	-0.72	-1.22	±5	2013/9/24
835	Body	22.5	0.997	55.120	0.97	55.2	2.78	-0.14	±5	2013/9/26
1750	Body	22.5	1.545	51.722	1.52	53.30	1.64	-2.96	±5	2013/9/19
1750	Body	22.3	1.509	52.010	1.52	53.30	-0.72	-2.42	±5	2013/9/26
1900	Body	22.4	1.532	52.506	1.52	53.30	0.79	-1.49	±5	2013/9/16
1900	Body	22.4	1.532	52.328	1.52	53.30	0.79	-1.82	±5	2013/9/18
1900	Body	22.3	1.533	51.572	1.52	53.30	0.86	-3.24	±5	2013/9/26

Table 6.2 Measuring Results for Simulating Liquid

7. System Verification Procedures

Each DASY system is equipped with one or more system validation kits. These units, together with the predefined measurement procedures within the DASY software, enable the user to conduct the system performance check and system validation. System validation kit includes a dipole, tripod holder to fix it underneath the flat phantom and a corresponding distance holder.

7.1 Purpose of System Performance check

The system performance check verifies that the system operates within its specifications. System and operator errors can be detected and corrected. It is recommended that the system performance check be performed prior to any usage of the system in order to guarantee reproducible results. The system performance check uses normal SAR measurements in a simplified setup with a well characterized source. This setup was selected to give a high sensitivity to all parameters that might fail or vary over time. The system check does not intend to replace the calibration of the components, but indicates situations where the system uncertainty is exceeded due to drift or failure.

7.2 System Setup

In the simplified setup for system evaluation, the EUT is replaced by a calibrated dipole and the power source is replaced by a continuous wave that comes from a signal generator. The calibrated dipole must be placed beneath the flat phantom section of the SAM twin phantom with the correct distance holder. The distance holder should touch the phantom surface with a light pressure at the reference marking and be oriented parallel to the long side of the phantom. The equipment setup is shown below:

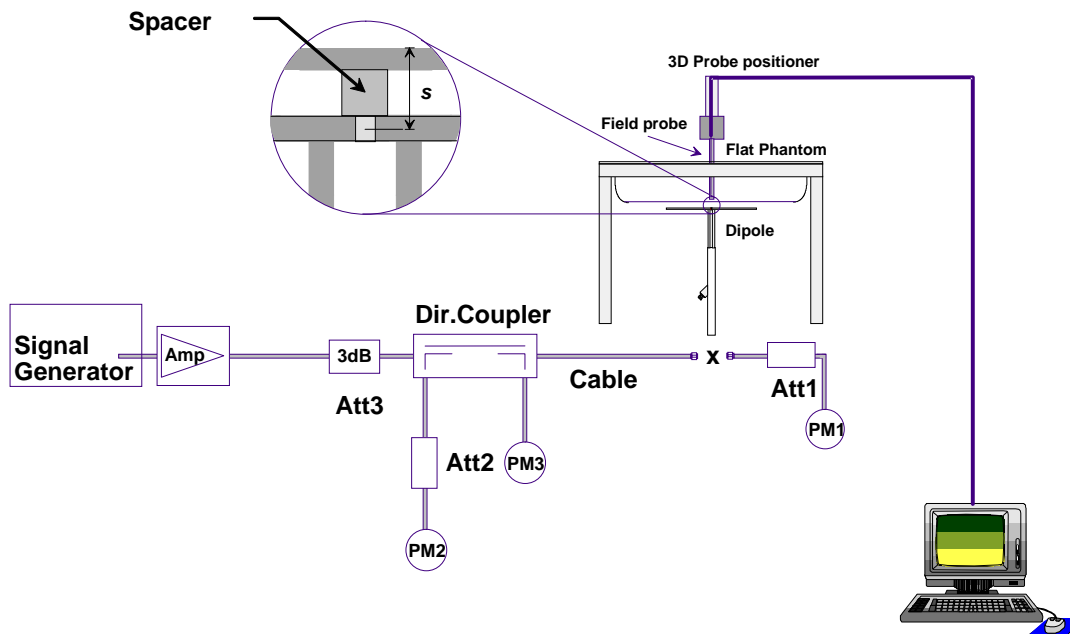

Fig 7.1 System Setup for System Evaluation

1. Signal Generator
2. Amplifier
3. Directional Coupler
4. Power Meter
5. Calibrated Dipole



Fig 7.2 Photo of Dipole Setup

7.3 SAR System Verification Results

Comparing to the original SAR value provided by SPEAG, the verification data should be within its specification of 10 %. Table 7.1 shows the target SAR and measured SAR after normalized to 1W input power. The table below indicates the system performance check can meet the variation criterion and the plots can be referred to Appendix A of this report.

Date	Frequency (MHz)	Liquid Type	Input Power (mW)	Dipole S/N	Probe S/N	DAE S/N	Measured SAR (W/kg)	Targeted SAR (W/kg)	Normalized SAR (W/kg)	Deviation (%)
2013/9/24	750	Body	250	1012	3801	778	2.07	8.83	8.28	-6.23
2013/9/27	750	Body	250	1012	3925	495	2.29	8.83	9.16	3.74
2013/9/20	835	Body	250	499	1788	577	2.39	9.63	9.56	-0.73
2013/9/24	835	Body	250	499	3801	778	2.55	9.63	10.20	5.92
2013/9/26	835	Body	250	499	3801	778	2.48	9.63	9.92	3.01
2013/9/19	1750	Body	250	1068	1788	577	8.76	36.8	35.04	-4.78
2013/9/26	1750	Body	250	1068	3801	778	9.55	36.8	38.20	3.80
2013/9/16	1900	Body	250	5d041	3792	1388	10.5	40.6	42.00	3.45
2013/9/18	1900	Body	250	5d041	1788	577	10.1	40.6	40.40	-0.49
2013/9/26	1900	Body	250	5d041	3801	778	10.0	40.6	40.00	-1.48

Table 7.1 Target and Measurement SAR after Normalized



8. EUT Testing Position

Please refer to Appendix D for the test setup photos.

9. Measurement Procedures

The measurement procedures are as follows:

<Conducted power measurement>

- (a) For WWAN power measurement, use base station simulator to configure EUT WWAN transmission in conducted connection with RF cable, at maximum power in each supported wireless interface and frequency band.
- (b) Read the WWAN RF power level from the base station simulator.
- (c) For WLAN/BT power measurement, use engineering software to configure EUT WLAN/BT continuously transmission, at maximum RF power in each supported wireless interface and frequency band
- (d) Connect EUT RF port through RF cable to the power meter, and measure WLAN/BT output power

<SAR measurement>

- (a) Use base station simulator to configure EUT WWAN transmission in radiated connection, and engineering software to configure EUT WLAN/BT continuously transmission, at maximum RF power, in the highest power channel.
- (b) Place the EUT in the positions as Appendix D demonstrates.
- (c) Set scan area, grid size and other setting on the DASY software.
- (d) Measure SAR results for the highest power channel on each testing position.
- (e) Find out the largest SAR result on these testing positions of each band
- (f) Measure SAR results for other channels in worst SAR testing position if the reported SAR of highest power channel is larger than 0.8 W/kg

According to the test standard, the recommended procedure for assessing the peak spatial-average SAR value consists of the following steps:

- (a) Power reference measurement
- (b) Area scan
- (c) Zoom scan
- (d) Power drift measurement

9.1 Spatial Peak SAR Evaluation

The procedure for spatial peak SAR evaluation has been implemented according to the test standard. It can be conducted for 1g and 10g, as well as for user-specific masses. The DASY software includes all numerical procedures necessary to evaluate the spatial peak SAR value.

The base for the evaluation is a "cube" measurement. The measured volume must include the 1g and 10g cubes with the highest averaged SAR values. For that purpose, the center of the measured volume is aligned to the interpolated peak SAR value of a previously performed area scan.

The entire evaluation of the spatial peak values is performed within the post-processing engine (SEMCAD). The system always gives the maximum values for the 1g and 10g cubes. The algorithm to find the cube with highest averaged SAR is divided into the following stages:

- (a) Extraction of the measured data (grid and values) from the Zoom Scan
- (b) Calculation of the SAR value at every measurement point based on all stored data (A/D values and measurement parameters)
- (c) Generation of a high-resolution mesh within the measured volume
- (d) Interpolation of all measured values from the measurement grid to the high-resolution grid
- (e) Extrapolation of the entire 3-D field distribution to the phantom surface over the distance from sensor to surface
- (f) Calculation of the averaged SAR within masses of 1g and 10g

9.2 Power Reference Measurement

The Power Reference Measurement and Power Drift Measurements are for monitoring the power drift of the device under test in the batch process. The minimum distance of probe sensors to surface determines the closest measurement point to phantom surface. This distance cannot be smaller than the distance of sensor calibration points to probe tip as defined in the probe properties.

9.3 Area & Zoom Scan Procedures

First Area Scan is used to locate the approximate location(s) of the local peak SAR value(s). The measurement grid within an Area Scan is defined by the grid extent, grid step size and grid offset. Next, in order to determine the EM field distribution in a three-dimensional spatial extension, Zoom Scan is required. The Zoom Scan is performed around the highest E-field value to determine the averaged SAR-distribution over 10 g. Area scan and zoom scan resolution setting follows KDB 865664 D01v01r01 quoted below.

When the 1-g SAR of the highest peak is within 2 dB of the SAR limit, additional zoom scans are required for other peaks within 2 dB of the highest peak that have not been included in any zoom scan to ensure there is no increase in SAR.

		≤ 3 GHz	> 3 GHz	
Maximum distance from closest measurement point (geometric center of probe sensors) to phantom surface		5 ± 1 mm	½·δ·ln(2) ± 0.5 mm	
Maximum probe angle from probe axis to phantom surface normal at the measurement location		30° ± 1°	20° ± 1°	
Maximum area scan spatial resolution: Δx _{Area} , Δy _{Area}		≤ 2 GHz: ≤ 15 mm 2 – 3 GHz: ≤ 12 mm	3 – 4 GHz: ≤ 12 mm 4 – 6 GHz: ≤ 10 mm	
		When the x or y dimension of the test device, in the measurement plane orientation, is smaller than the above, the measurement resolution must be ≤ the corresponding x or y dimension of the test device with at least one measurement point on the test device.		
Maximum zoom scan spatial resolution: Δx _{Zoom} , Δy _{Zoom}		≤ 2 GHz: ≤ 8 mm 2 – 3 GHz: ≤ 5 mm*	3 – 4 GHz: ≤ 5 mm* 4 – 6 GHz: ≤ 4 mm*	
Maximum zoom scan spatial resolution, normal to phantom surface	uniform grid: Δz _{Zoom} (n)	≤ 5 mm	3 – 4 GHz: ≤ 4 mm 4 – 5 GHz: ≤ 3 mm 5 – 6 GHz: ≤ 2 mm	
	graded grid	Δz _{Zoom} (1): between 1 st two points closest to phantom surface	≤ 4 mm	3 – 4 GHz: ≤ 3 mm 4 – 5 GHz: ≤ 2.5 mm 5 – 6 GHz: ≤ 2 mm
		Δz _{Zoom} (n>1): between subsequent points	≤ 1.5·Δz _{Zoom} (n-1)	
Minimum zoom scan volume	x, y, z	≥ 30 mm	3 – 4 GHz: ≥ 28 mm 4 – 5 GHz: ≥ 25 mm 5 – 6 GHz: ≥ 22 mm	
<p>Note: δ is the penetration depth of a plane-wave at normal incidence to the tissue medium; see draft standard IEEE P1528-2011 for details.</p> <p>* When zoom scan is required and the <i>reported</i> SAR from the area scan based 1-g SAR estimation procedures of KDB 447498 is ≤ 1.4 W/kg, ≤ 8 mm, ≤ 7 mm and ≤ 5 mm zoom scan resolution may be applied, respectively, for 2 GHz to 3 GHz, 3 GHz to 4 GHz and 4 GHz to 6 GHz.</p>				



9.4 Volume Scan Procedures

The volume scan is used for assess overlapping SAR distributions for antennas transmitting in different frequency bands. It is equivalent to an oversized zoom scan used in standalone measurements. The measurement volume will be used to enclose all the simultaneous transmitting antennas. For antennas transmitting simultaneously in different frequency bands, the volume scan is measured separately in each frequency band. In order to sum correctly to compute the 1g aggregate SAR, the EUT remain in the same test position for all measurements and all volume scan use the same spatial resolution and grid spacing. When all volume scan were completed, the software, SEMCAD postprocessor can combine and subsequently superpose these measurement data to calculating the multiband SAR.

9.5 SAR Averaged Methods

In DASYS, the interpolation and extrapolation are both based on the modified Quadratic Shepard's method. The interpolation scheme combines a least-square fitted function method and a weighted average method which are the two basic types of computational interpolation and approximation.

Extrapolation routines are used to obtain SAR values between the lowest measurement points and the inner phantom surface. The extrapolation distance is determined by the surface detection distance and the probe sensor offset. The uncertainty increases with the extrapolation distance. To keep the uncertainty within 1% for the 1 g and 10 g cubes, the extrapolation distance should not be larger than 5 mm.

9.6 Power Drift Monitoring

All SAR testing is under the EUT install full charged battery and transmit maximum output power. In DASYS measurement software, the power reference measurement and power drift measurement procedures are used for monitoring the power drift of EUT during SAR test. Both these procedures measure the field at a specified reference position before and after the SAR testing. The software will calculate the field difference in dB. If the power drifts more than 5%, the SAR will be retested.

10. Conducted RF Output Power (Unit: dBm)

<GSM Conducted Power>

Note:

1. Per KDB 447498 D01v05r01, the maximum output power channel is used for SAR testing and for further SAR test reduction.
2. According to KDB 941225 D03v01, for Body SAR testing, the EUT operating without power back-off was set in GPRS (2 Tx slots) and the EUT operating with power back-off was set in GPRS (2 Tx slots) due to its highest frame-average power.

Full Power mode (Proximity Sensor Inactive)

Band GSM850 TX Channel	Burst Average Power (dBm)			Tune-up Limit (dBm)	Frame-Average Power (dBm)			Tune-up Limit (dBm)
	128	189	251		128	189	251	
Frequency (MHz)	824.2	836.4	848.8		824.2	836.4	848.8	
GPRS (GMSK, 1 Tx slot) – CS1	31.63	31.59	31.55	33.50	22.63	22.59	22.55	24.50
GPRS (GMSK, 2 Tx slots) – CS1	31.25	31.22	31.16	33.00	25.25	25.22	25.16	27.00
EDGE (8PSK, 1 Tx slot) – MCS5	26.28	26.42	26.48	28.00	17.28	17.42	17.48	19.00
EDGE (8PSK, 2 Tx slots) – MCS5	26.35	26.40	26.32	27.00	20.35	20.40	20.32	21.00
EDGE (8PSK, 3 Tx slots) – MCS5	26.20	26.33	26.35	27.00	21.94	22.07	22.09	22.74
EDGE (8PSK, 4 Tx slots) – MCS5	26.17	26.18	26.16	27.00	23.17	23.18	23.16	24.00

Remark: The frame-averaged power is linearly scaled the maximum burst averaged power over 8 time slots.

The calculated method are shown as below:

- Frame-averaged power = Maximum burst averaged power (1 Tx Slot) - 9 dB
- Frame-averaged power = Maximum burst averaged power (2 Tx Slots) - 6 dB
- Frame-averaged power = Maximum burst averaged power (3 Tx Slots) - 4.26 dB
- Frame-averaged power = Maximum burst averaged power (4 Tx Slots) - 3 dB

Reduced Power Mode (Proximity Sensor active)

Band GSM850 TX Channel	Burst Average Power (dBm)			Tune-up Limit (dBm)	Frame-Average Power (dBm)			Tune-up Limit (dBm)
	128	189	251		128	189	251	
Frequency (MHz)	824.2	836.4	848.8		824.2	836.4	848.8	
GPRS (GMSK, 1 Tx slot) – CS1	29.62	29.08	29.18	30.00	20.62	20.08	20.18	21.00
GPRS (GMSK, 2 Tx slots) – CS1	26.88	26.87	26.91	27.00	20.88	20.87	20.91	21.00
EDGE (8PSK, 1 Tx slot) – MCS5	26.28	26.42	26.48	28.00	17.28	17.42	17.48	19.00
EDGE (8PSK, 2 Tx slots) – MCS5	26.35	26.40	26.32	27.00	20.35	20.40	20.32	21.00
EDGE (8PSK, 3 Tx slots) – MCS5	24.33	24.40	24.42	25.00	20.07	20.14	20.16	20.74
EDGE (8PSK, 4 Tx slots) – MCS5	23.31	23.36	23.38	24.00	20.31	20.36	20.38	21.00

Remark: The frame-averaged power is linearly scaled the maximum burst averaged power over 8 time slots.

The calculated method are shown as below:

- Frame-averaged power = Maximum burst averaged power (1 Tx Slot) - 9 dB
- Frame-averaged power = Maximum burst averaged power (2 Tx Slots) - 6 dB
- Frame-averaged power = Maximum burst averaged power (3 Tx Slots) - 4.26 dB
- Frame-averaged power = Maximum burst averaged power (4 Tx Slots) - 3 dB



Full Power mode (Proximity Sensor Inactive)

Band GSM1900 TX Channel Frequency (MHz)	Burst Average Power (dBm)			Tune-up Limit (dBm)	Frame-Average Power (dBm)			Tune-up Limit (dBm)
	512	661	810		512	661	810	
	1850.2	1880	1909.8		1850.2	1880	1909.8	
GPRS (GMSK, 1 Tx slot) – CS1	28.55	28.74	28.57	30.50	19.55	19.74	19.57	21.50
GPRS (GMSK, 2 Tx slots) – CS1	28.48	28.66	28.47	30.00	22.48	22.66	22.47	24.00
EDGE (8PSK, 1 Tx slot) – MCS5	25.13	25.15	25.22	27.00	16.13	16.15	16.22	18.00
EDGE (8PSK, 2 Tx slots) – MCS5	25.08	25.06	25.10	26.00	19.08	19.06	19.10	20.00
EDGE (8PSK, 3 Tx slots) – MCS5	24.93	25.03	25.07	26.00	20.67	20.77	20.81	21.74
EDGE (8PSK, 4 Tx slots) – MCS5	24.89	24.90	24.91	26.00	21.89	21.90	21.91	23.00

Remark: The frame-averaged power is linearly scaled the maximum burst averaged power over 8 time slots.
 The calculated method are shown as below:
 Frame-averaged power = Maximum burst averaged power (1 Tx Slot) - 9 dB
 Frame-averaged power = Maximum burst averaged power (2 Tx Slots) - 6 dB
 Frame-averaged power = Maximum burst averaged power (3 Tx Slots) - 4.26 dB
 Frame-averaged power = Maximum burst averaged power (4 Tx Slots) - 3 dB

Reduced Power Mode (Proximity Sensor active)

Band GSM1900 TX Channel Frequency (MHz)	Burst Average Power (dBm)			Tune-up Limit (dBm)	Frame-Average Power (dBm)			Tune-up Limit (dBm)
	512	661	810		512	661	810	
	1850.2	1880	1909.8		1850.2	1880	1909.8	
GPRS (GMSK, 1 Tx slot) – CS1	27.08	27.06	27.01	27.50	18.08	18.06	18.01	18.50
GPRS (GMSK, 2 Tx slots) – CS1	24.06	24.08	24.19	24.50	18.06	18.08	18.19	18.50
EDGE (8PSK, 1 Tx slot) – MCS5	21.13	21.16	21.08	23.00	12.13	12.16	12.08	14.00
EDGE (8PSK, 2 Tx slots) – MCS5	20.70	20.68	20.74	22.00	14.70	14.68	14.74	16.00
EDGE (8PSK, 3 Tx slots) – MCS5	20.62	20.65	20.67	22.00	16.36	16.39	16.41	17.74
EDGE (8PSK, 4 Tx slots) – MCS5	20.55	20.50	20.59	21.50	17.55	17.50	17.59	18.50

Remark: The frame-averaged power is linearly scaled the maximum burst averaged power over 8 time slots.
 The calculated method are shown as below:
 Frame-averaged power = Maximum burst averaged power (1 Tx Slot) - 9 dB
 Frame-averaged power = Maximum burst averaged power (2 Tx Slots) - 6 dB
 Frame-averaged power = Maximum burst averaged power (3 Tx Slots) - 4.26 dB
 Frame-averaged power = Maximum burst averaged power (4 Tx Slots) - 3 dB

<WCDMA Conducted Power>

The following tests were conducted according to the test requirements outlines in 3GPP TS 34.121 specification.

A summary of these settings are illustrated below:

HSDPA Setup Configuration:

- a. The EUT was connected to Base Station Agilent E5515C referred to the Setup Configuration.
- b. The RF path losses were compensated into the measurements.
- c. A call was established between EUT and Base Station with following setting:
 - i. Set Gain Factors (β_c and β_d) and parameters were set according to each
 - ii. Specific sub-test in the following table, C10.1.4, quoted from the TS 34.121
 - iii. Set RMC 12.2Kbps + HSDPA mode.
 - iv. Set Cell Power = -86 dBm
 - v. Set HS-DSCH Configuration Type to FRC (H-set 1, QPSK)
 - vi. Select HSDPA Uplink Parameters
 - vii. Set Delta ACK, Delta NACK and Delta CQI = 8
 - viii. Set Ack-Nack Repetition Factor to 3
 - ix. Set CQI Feedback Cycle (k) to 4 ms
 - x. Set CQI Repetition Factor to 2
 - xi. Power Ctrl Mode = All Up bits
- d. The transmitted maximum output power was recorded.

Table C.10.1.4: β values for transmitter characteristics tests with HS-DPCCH

Sub-test	β_c	β_d	β_d (SF)	β_c/β_d	β_{HS} (Note 1, Note 2)	CM (dB) (Note 3)	MPR (dB) (Note 3)
1	2/15	15/15	64	2/15	4/15	0.0	0.0
2	12/15 (Note 4)	15/15 (Note 4)	64	12/15 (Note 4)	24/15	1.0	0.0
3	15/15	8/15	64	15/8	30/15	1.5	0.5
4	15/15	4/15	64	15/4	30/15	1.5	0.5

Note 1: $\Delta_{ACK}, \Delta_{NACK}$ and $\Delta_{CQI} = 30/15$ with $\beta_{HS} = 30/15 * \beta_c$.

Note 2: For the HS-DPCCH power mask requirement test in clause 5.2C, 5.7A, and the Error Vector Magnitude (EVM) with HS-DPCCH test in clause 5.13.1A, and HSDPA EVM with phase discontinuity in clause 5.13.1AA, Δ_{ACK} and $\Delta_{NACK} = 30/15$ with $\beta_{HS} = 30/15 * \beta_c$, and $\Delta_{CQI} = 24/15$ with $\beta_{HS} = 24/15 * \beta_c$.

Note 3: CM = 1 for $\beta_c/\beta_d = 12/15, \beta_{HS}/\beta_c = 24/15$. For all other combinations of DPDCH, DPCCH and HS-DPCCH the MPR is based on the relative CM difference. This is applicable for only UEs that support HSDPA in release 6 and later releases.

Note 4: For subtest 2 the β_c/β_d ratio of 12/15 for the TFC during the measurement period (TF1, TF0) is achieved by setting the signalled gain factors for the reference TFC (TF1, TF1) to $\beta_c = 11/15$ and $\beta_d = 15/15$.

Setup Configuration

HSUPA Setup Configuration:

- a. The EUT was connected to Base Station Agilent E5515C referred to the Setup Configuration.
- b. The RF path losses were compensated into the measurements.
- c. A call was established between EUT and Base Station with following setting * :
 - i. Call Configs = 5.2B, 5.9B, 5.10B, and 5.13.2B with QPSK
 - ii. Set the Gain Factors (β_c and β_d) and parameters (AG Index) were set according to each specific sub-test in the following table, C11.1.3, quoted from the TS 34.121
 - iii. Set Cell Power = -86 dBm
 - iv. Set Channel Type = 12.2k + HSPA
 - v. Set UE Target Power
 - vi. Power Ctrl Mode= Alternating bits
 - vii. Set and observe the E-TFCl
 - viii. Confirm that E-TFCl is equal to the target E-TFCl of 75 for sub-test 1, and other subtest's E-TFCl
- d. The transmitted maximum output power was recorded.

Table C.11.1.3: β values for transmitter characteristics tests with HS-DPCCH and E-DCH

Sub-test	β_c	β_d	β_d (SF)	β_c/β_d	β_{HS} (Note 1)	β_{ec}	β_{ed} (Note 5) (Note 6)	β_{ed} (SF)	β_{ed} (Codes)	CM (dB) (Note 2)	MPR (dB) (Note 2)	AG Index (Note 6)	E-TFCl
1	11/15 (Note 3)	15/15 (Note 3)	64	11/15 (Note 3)	22/15	209/225	1309/225	4	1	1.0	0.0	20	75
2	6/15	15/15	64	6/15	12/15	12/15	94/75	4	1	3.0	2.0	12	67
3	15/15	9/15	64	15/9	30/15	30/15	$\beta_{ed1}: 47/15$ $\beta_{ed2}: 47/15$	4	2	2.0	1.0	15	92
4	2/15	15/15	64	2/15	4/15	2/15	56/75	4	1	3.0	2.0	17	71
5	15/15 (Note 4)	15/15 (Note 4)	64	15/15 (Note 4)	30/15	24/15	134/15	4	1	1.0	0.0	21	81

Note 1: $\Delta_{ACK}, \Delta_{NACK}$ and $\Delta_{CQI} = 30/15$ with $\beta_{hs} = 30/15 * \beta_c$.

Note 2: CM = 1 for $\beta_c/\beta_d = 12/15, \beta_{hs}/\beta_c = 24/15$. For all other combinations of DPDCH, DPCCH, HS-DPCCH, E-DPDCH and E-DPCCH the MPR is based on the relative CM difference.

Note 3: For subtest 1 the β_c/β_d ratio of 11/15 for the TFC during the measurement period (TF1, TF0) is achieved by setting the signalled gain factors for the reference TFC (TF1, TF1) to $\beta_c = 10/15$ and $\beta_d = 15/15$.

Note 4: For subtest 5 the β_c/β_d ratio of 15/15 for the TFC during the measurement period (TF1, TF0) is achieved by setting the signalled gain factors for the reference TFC (TF1, TF1) to $\beta_c = 14/15$ and $\beta_d = 15/15$.

Note 5: In case of testing by UE using E-DPDCH Physical Layer category 1, Sub-test 3 is omitted according to TS25.306 Table 5.1g.

Note 6: β_{ed} can not be set directly, it is set by Absolute Grant Value.

Setup Configuration

DC-HSDPA 3GPP release 8 Setup Configuration:

- a. The EUT was connected to Base Station Agilent E5515C referred to the Setup Configuration below
- b. The RF path losses were compensated into the measurements.
- c. A call was established between EUT and Base Station with following setting:
 - i. Set RMC 12.2Kbps + HSDPA mode.
 - ii. Set Cell Power = -25 dBm
 - iii. Set HS-DSCH Configuration Type to FRC (H-set 12, QPSK)
 - iv. Select HSDPA Uplink Parameters
 - v. Set Gain Factors (β_c and β_d) and parameters were set according to each Specific sub-test in the following table, C10.1.4, quoted from the TS 34.121
 - a). Subtest 1: $\beta_c/\beta_d=2/15$
 - b). Subtest 2: $\beta_c/\beta_d=12/15$
 - c). Subtest 3: $\beta_c/\beta_d=15/8$
 - d). Subtest 4: $\beta_c/\beta_d=15/4$
 - vi. Set Delta ACK, Delta NACK and Delta CQI = 8
 - vii. Set Ack-Nack Repetition Factor to 3
 - viii. Set CQI Feedback Cycle (k) to 4 ms
 - ix. Set CQI Repetition Factor to 2
 - x. Power Ctrl Mode = All Up bits
- d. The transmitted maximum output power was recorded.

The following tests were conducted according to the test requirements outlines in 3GPP TS 34.121 specification. A summary of these settings are illustrated below:

C.8.1.12 Fixed Reference Channel Definition H-Set 12

Table C.8.1.12: Fixed Reference Channel H-Set 12

Parameter	Unit	Value
Nominal Avg. Inf. Bit Rate	kbps	60
Inter-TTI Distance	TTI's	1
Number of HARQ Processes	Processes	6
Information Bit Payload (N_{INF})	Bits	120
Number Code Blocks	Blocks	1
Binary Channel Bits Per TTI	Bits	960
Total Available SML's in UE	SML's	19200
Number of SML's per HARQ Proc.	SML's	3200
Coding Rate		0.15
Number of Physical Channel Codes	Codes	1
Modulation		QPSK
Note 1: The RMC is intended to be used for DC-HSDPA mode and both cells shall transmit with identical parameters as listed in the table. Note 2: Maximum number of transmission is limited to 1, i.e., retransmission is not allowed. The redundancy and constellation version 0 shall be used.		

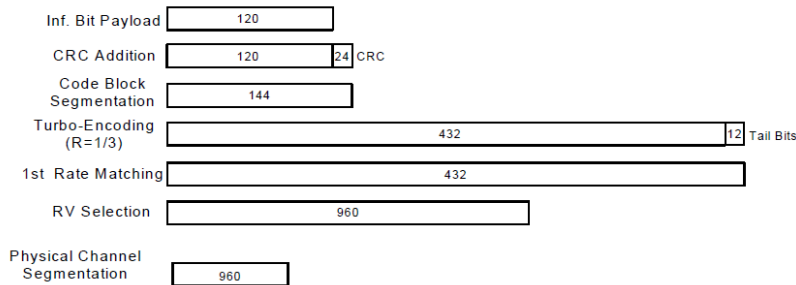

Figure C.8.19: Coding rate for Fixed reference Channel H-Set 12 (QPSK)

Setup Configuration



<WCDMA Conducted Power>

Note:

- Per KDB 941225 D02v02r02, RMC 12.2kbps setting is used to evaluate SAR. If HSDPA/HSUPA/DC-HSDPA output power is < 0.25dB higher than RMC12.2Kbps, or reported SAR with RMC 12.2kbps setting is ≤ 1.2W/kg, HSDPA/HSUPA/DC-HSDPA SAR evaluation can be excluded.

Full Power Mode (Proximity Sensor Inactive)

Band		WCDMA V			Tune-up Limit (dBm)	WCDMA II			Tune-up Limit (dBm)	WCDMA IV			Tune-up Limit (dBm)	
TX Channel		4132	4182	4233		9262	9400	9538		1312	1413	1513		
Rx Channel		4357	4407	4458	9662	9800	9938	1537	1638	1738				
Frequency (MHz)		826.4	836.4	846.6	1852.4	1880	1907.6	1712.4	1732.6	1752.6				
MPR (dB)	3GPP Rel 99	RMC 12.2Kbps	22.22	22.18	22.06	24.00	22.51	22.55	22.54	24.00	22.18	22.37	22.24	24.00
0	3GPP Rel 6	HSDPA Subtest-1	22.20	22.13	22.01	24.00	22.48	22.53	22.51	24.00	22.16	22.35	22.23	24.00
0	3GPP Rel 6	HSDPA Subtest-2	22.16	22.08	22.00	24.00	22.37	22.46	22.42	24.00	22.15	22.34	22.20	24.00
0.5	3GPP Rel 6	HSDPA Subtest-3	22.13	22.05	21.94	23.50	22.31	22.42	22.38	23.50	21.65	21.82	21.70	23.50
0.5	3GPP Rel 6	HSDPA Subtest-4	22.07	22.00	21.89	23.50	22.25	22.39	22.32	23.50	21.60	21.80	21.65	23.50
0	3GPP Rel 8	DC-HSDPA Subtest-1	22.10	22.03	22.01	24.00	22.08	22.13	22.11	24.00	22.15	22.33	22.22	24.00
0	3GPP Rel 8	DC-HSDPA Subtest-2	22.06	22.01	22.01	24.00	22.00	22.06	22.02	24.00	22.13	22.30	22.20	24.00
0.5	3GPP Rel 8	DC-HSDPA Subtest-3	21.83	21.75	21.64	23.50	21.86	21.97	21.93	23.50	21.64	21.80	21.66	23.50
0.5	3GPP Rel 8	DC-HSDPA Subtest-4	21.77	21.70	21.59	23.50	21.80	21.94	21.87	23.50	21.61	21.75	21.64	23.50
0	3GPP Rel 6	HSUPA Subtest-1	22.20	22.20	22.12	24.00	22.49	22.50	22.52	24.00	22.14	22.32	22.20	24.00
2	3GPP Rel 6	HSUPA Subtest-2	20.56	20.53	20.48	22.00	20.76	20.79	20.96	22.00	20.60	20.85	20.76	22.00
1	3GPP Rel 6	HSUPA Subtest-3	21.42	21.38	21.34	23.00	21.88	21.98	21.92	23.00	21.16	21.38	21.30	23.00
2	3GPP Rel 6	HSUPA Subtest-4	20.29	20.25	20.21	22.00	20.86	20.72	20.93	22.00	20.50	20.79	20.69	22.00
0	3GPP Rel 6	HSUPA Subtest-5	22.21	22.19	22.10	24.00	22.52	22.54	22.54	24.00	22.16	22.35	22.23	24.00

Reduced Power Mode (Proximity Sensor active)

Band		WCDMA V			Tune-up Limit (dBm)	WCDMA II			Tune-up Limit (dBm)	WCDMA IV			Tune-up Limit (dBm)	
TX Channel		4132	4182	4233		9262	9400	9538		1312	1413	1513		
Rx Channel		4357	4407	4458	9662	9800	9938	1537	1638	1738				
Frequency (MHz)		826.4	836.4	846.6	1852.4	1880	1907.6	1712.4	1732.6	1752.6				
MPR (dB)	3GPP Rel 99	RMC 12.2Kbps	18.26	18.21	18.29	18.50	17.71	17.84	17.78	18.00	17.92	17.99	17.74	18.00
0	3GPP Rel 6	HSDPA Subtest-1	17.85	17.68	17.61	18.50	17.56	17.78	17.66	18.00	17.91	17.74	17.67	18.00
0	3GPP Rel 6	HSDPA Subtest-2	17.76	17.69	17.74	18.50	17.23	17.34	17.31	18.00	17.82	17.75	17.80	18.00
0.5	3GPP Rel 6	HSDPA Subtest-3	17.28	17.24	17.19	18.50	16.77	16.89	16.82	18.00	17.34	17.30	17.25	18.00
0.5	3GPP Rel 6	HSDPA Subtest-4	17.33	17.24	17.18	18.50	16.76	16.84	16.82	18.00	17.39	17.30	17.24	18.00
0	3GPP Rel 8	DC-HSDPA Subtest-1	17.25	17.31	17.18	18.50	16.77	17.37	16.81	18.00	17.31	17.37	17.24	18.00
0	3GPP Rel 8	DC-HSDPA Subtest-2	17.37	17.27	17.13	18.50	16.55	16.75	16.75	18.00	17.43	17.33	17.19	18.00
0.5	3GPP Rel 8	DC-HSDPA Subtest-3	17.30	17.22	17.08	18.50	16.61	16.57	16.71	18.00	17.36	17.28	17.14	18.00
0.5	3GPP Rel 8	DC-HSDPA Subtest-4	17.36	17.32	17.11	18.50	16.59	16.76	16.80	18.00	17.42	17.38	17.17	18.00
0	3GPP Rel 6	HSUPA Subtest-1	17.56	17.20	17.12	18.50	17.05	16.84	16.91	18.00	17.62	17.26	17.18	18.00
2	3GPP Rel 6	HSUPA Subtest-2	17.66	17.13	17.19	18.50	16.78	16.93	17.07	18.00	17.72	17.19	17.25	18.00
1	3GPP Rel 6	HSUPA Subtest-3	17.35	17.19	17.25	18.50	16.74	16.98	17.07	18.00	17.41	17.25	17.31	18.00
2	3GPP Rel 6	HSUPA Subtest-4	17.67	18.02	17.48	18.50	16.83	16.62	16.82	18.00	17.73	18.08	17.54	18.00
0	3GPP Rel 6	HSUPA Subtest-5	17.70	17.68	17.75	18.50	17.25	17.36	17.32	18.00	17.76	17.74	17.81	18.00



<CDMA2000 Conducted Power>

Note:

- Referring to KDB 941225 D01v02, the data device SAR is tested with Ev-Do Rev 0 (RTAP 153.6kbps). If 1xRTT and Ev-Do Rev A (RETAP 4096 bits) power is less than 1/4dB higher than Re v0, SAR tests with those settings are not necessary.

Full Power Mode (Proximity Sensor Inactive)

Band	CDMA2000 BC10			Tune-up Limit (dBm)	CDMA2000 BC0			Tune-up Limit (dBm)	CDMA2000 BC1			Tune-up Limit (dBm)
	TX Channel	476	580		684	1013	384		777	25	600	
Frequency (MHz)	817.9	820.5	823.1		824.7	836.52	848.31		1851.25	1880	1908.75	
1xRTT RC1 SO55	23.34	23.31	23.29	24.50	23.21	23.19	23.00	24.50	23.85	23.68	23.69	24.50
1xRTT RC3 SO55	23.17	23.25	23.34	24.50	23.23	23.20	23.02	24.50	23.84	23.74	23.75	24.50
1xEVDO RTAP 153.6Kbps	23.35	23.26	23.31	24.50	23.26	23.23	23.03	24.50	23.86	23.72	23.78	24.50
1xEVDO RETAP 4096Bits	23.16	23.17	23.33	24.50	23.21	23.20	23.20	24.50	23.84	23.74	23.79	24.50

Reduced Power Mode (Proximity Sensor active)

Band	CDMA2000 BC10			Tune-up Limit (dBm)	CDMA2000 BC0			Tune-up Limit (dBm)	CDMA2000 BC1			Tune-up Limit (dBm)
	TX Channel	476	580		684	1013	384		777	25	600	
Frequency (MHz)	817.9	820.5	823.1		824.7	836.52	848.31		1851.25	1880	1908.75	
1xRTT RC1 SO55	20.34	20.31	20.29	20.50	20.37	20.30	20.11	20.50	17.91	17.18	17.80	18.00
1xRTT RC3 SO55	20.20	20.30	20.31	20.50	20.41	20.34	20.15	20.50	17.82	17.10	17.89	18.00
1xEVDO RTAP 153.6Kbps	20.36	20.22	20.28	20.50	20.42	20.37	20.19	20.50	17.96	17.25	17.92	18.00
1xEVDO RETAP 4096Bits	20.35	20.28	20.34	20.50	20.36	20.35	20.22	20.50	17.90	17.24	17.85	18.00



<LTE Conducted Power>

Note:

1. Anritsu MT8820C base station simulator was used to setup the connection with EUT; the frequency band, channel bandwidth, RB allocation configuration, modulation type are set in the base station simulator to configure EUT transmitting at maximum power and at different configurations which are requested to be reported to FCC, for conducted power measurement and SAR testing.
2. Per KDB 941225 D05v02r02, when a properly configured base station simulator is used for the SAR and power measurements, spectrum plots for each RB allocation and offset configuration is not required.
3. Per KDB 941225 D05v02r02, start with the largest channel bandwidth and measure SAR for QPSK with 1 RB allocation, using the RB offset and required test channel combination with the highest maximum output power for RB offsets at the upper edge, middle and lower edge of each required test channel.
4. Per KDB 941225 D05v02r02, 50% RB allocation for QPSK SAR testing follows 1RB QPSK allocation procedure.
5. Per KDB 941225 D05v02r02, when reported SAR of 1RB and 50%RB allocation for QPSK $\leq 0.8\text{W/kg}$, and 100%RB with QPSK output power is less than 1RB and 50%RB, 100%RB allocation for QPSK is not required.
6. Per KDB 941225 D05v02r02, when reported SAR of 1RB and 50%RB allocation for QPSK $> 0.8\text{W/kg}$ for any exposure position, SAR testing of 100%RB allocation for QPSK is performed at the highest power channel.
7. 16QAM output power for each RB allocation configuration is $>$ not $\frac{1}{2}$ dB higher than the same configuration in QPSK and the reported SAR for the QPSK configuration is $\leq 1.45\text{ W/kg}$; Per KDB 941225 D05v02, 16QAM SAR testing is not required.
8. Smaller bandwidth output power for each RB allocation configuration is $>$ not $\frac{1}{2}$ dB higher than the same configuration in the largest supported bandwidth, and the reported SAR for the largest supported bandwidth is $\leq 1.45\text{ W/kg}$; Per KDB 941225 D05v02r02, smaller bandwidth SAR testing is not required.



<LTE Band 17 Conducted Power>

Full Power Mode (Proximity Sensor Inactive)

BW [MHz]	Modulation	RB Size	RB Offset	Power Low Ch. / Freq.	Power Middle Ch. / Freq.	Power High Ch. / Freq.	Tune up Limit (dBm)	MPR (dB)
Channel				23780	23790	23800		
Frequency (MHz)				709	710	711		
10	QPSK	1	0	22.17	22.42	22.55	24.00	0
10	QPSK	1	24	22.53	22.37	22.51		
10	QPSK	1	49	22.20	22.25	22.13		
10	QPSK	25	0	21.49	21.34	21.43	23.00	1
10	QPSK	25	12	21.38	21.33	21.45		
10	QPSK	25	24	21.53	21.21	21.07		
10	QPSK	50	0	21.26	21.16	21.14		
10	16QAM	1	0	21.13	21.31	21.45	23.00	1
10	16QAM	1	24	21.48	21.44	21.59		
10	16QAM	1	49	21.22	21.11	21.20		
10	16QAM	25	0	20.42	20.32	20.34	22.00	2
10	16QAM	25	12	20.34	20.12	20.29		
10	16QAM	25	24	20.31	20.32	20.12		
10	16QAM	50	0	20.21	20.37	20.19		
Channel				23755	23790	23825		
Frequency (MHz)				706.5	710	713.5		
5	QPSK	1	0	22.46	22.37	22.34	24.00	0
5	QPSK	1	12	22.42	22.39	22.12		
5	QPSK	1	24	22.44	22.29	22.11		
5	QPSK	12	0	21.48	21.48	21.24	23.00	1
5	QPSK	12	6	21.67	21.53	21.20		
5	QPSK	12	11	21.45	21.53	21.12		
5	QPSK	25	0	21.39	21.38	21.11		
5	16QAM	1	0	21.33	21.33	21.32	23.00	1
5	16QAM	1	12	21.59	21.41	21.23		
5	16QAM	1	24	21.52	21.35	21.14		
5	16QAM	12	0	20.55	20.43	20.51	22.00	2
5	16QAM	12	6	20.53	20.51	20.10		
5	16QAM	12	11	20.46	20.50	20.21		
5	16QAM	25	0	20.40	20.35	20.03		



<LTE Band 17 Conducted Power>

Reduced Power Mode (Proximity Sensor active)

BW [MHz]	Modulation	RB Size	RB Offset	Power Low Ch. / Freq.	Power Middle Ch. / Freq.	Power High Ch. / Freq.	Tune up Limit (dBm)	MPR (dB)
Channel				23780	23790	23800		
Frequency (MHz)				709	710	711		
10	QPSK	1	0	19.25	19.48	19.66	21.00	0
10	QPSK	1	24	19.59	19.55	19.46		
10	QPSK	1	49	19.26	19.21	19.13		
10	QPSK	25	0	19.51	19.48	19.56	21.00	0
10	QPSK	25	12	19.49	19.40	19.41		
10	QPSK	25	24	19.41	19.28	19.17		
10	QPSK	50	0	19.39	19.30	19.24		
10	16QAM	1	0	19.15	19.51	19.58	21.00	0
10	16QAM	1	24	19.64	19.54	19.49		
10	16QAM	1	49	19.29	19.27	19.13		
10	16QAM	25	0	19.43	19.46	19.52	21.00	0
10	16QAM	25	12	19.43	19.43	19.38		
10	16QAM	25	24	19.38	19.28	19.10		
10	16QAM	50	0	19.33	19.23	19.22		
Channel				23755	23790	23825		
Frequency (MHz)				706.5	710	713.5		
5	QPSK	1	0	19.26	19.61	19.35	21.00	0
5	QPSK	1	12	19.54	19.54	19.13		
5	QPSK	1	24	19.58	19.28	19.16		
5	QPSK	12	0	19.39	19.58	19.33	21.00	0
5	QPSK	12	6	19.50	19.57	19.18		
5	QPSK	12	11	19.52	19.54	19.25		
5	QPSK	25	0	19.43	19.38	19.08	21.00	0
5	16QAM	1	0	19.28	19.48	19.37		
5	16QAM	1	12	19.61	19.63	19.21		
5	16QAM	1	24	19.57	19.35	19.31	21.00	0
5	16QAM	12	0	19.45	19.60	19.35		
5	16QAM	12	6	19.60	19.57	19.13		
5	16QAM	12	11	19.51	19.60	19.14		
5	16QAM	25	0	19.42	19.42	19.27		



<LTE Band 13 Conducted Power>

Full Power Mode (Proximity Sensor Inactive)

BW [MHz]	Modulation	RB Size	RB Offset	Power Low Ch. / Freq.	Power Middle Ch. / Freq.	Power High Ch. / Freq.	Tune up Limit (dBm)	MPR (dB)
Channel					23230			
Frequency (MHz)					782			
10	QPSK	1	0		22.43		24.00	0
10	QPSK	1	24		22.36			
10	QPSK	1	49		22.31			
10	QPSK	25	0		21.22		23.00	1
10	QPSK	25	12		21.23			
10	QPSK	25	24		21.12			
10	QPSK	50	0		21.21		23.00	1
10	16QAM	1	0		21.41			
10	16QAM	1	24		21.34			
10	16QAM	1	49		21.16		22.00	2
10	16QAM	25	0		20.07			
10	16QAM	25	12		20.11			
10	16QAM	25	24		20.06		22.00	2
10	16QAM	50	0		20.14			
Channel				23205	23230	23255		
Frequency (MHz)				779.5	782	784.5		
5	QPSK	1	0	22.14	22.13	22.22	24.00	0
5	QPSK	1	12	22.34	22.24	22.13		
5	QPSK	1	24	22.38	22.12	22.04		
5	QPSK	12	0	21.33	21.19	21.29	23.00	1
5	QPSK	12	6	21.25	21.23	21.16		
5	QPSK	12	11	21.32	21.26	21.14		
5	QPSK	25	0	21.12	21.17	21.13	23.00	1
5	16QAM	1	0	21.15	21.21	21.23		
5	16QAM	1	12	21.25	21.40	21.08		
5	16QAM	1	24	21.19	21.17	21.18	22.00	2
5	16QAM	12	0	20.03	20.21	20.20		
5	16QAM	12	6	20.12	20.22	20.30		
5	16QAM	12	11	20.23	20.22	20.03	22.00	2
5	16QAM	25	0	20.08	20.12	20.04		



<LTE Band 13 Conducted Power>

Reduced Power Mode (Proximity Sensor active)

BW [MHz]	Modulation	RB Size	RB Offset	Power Low Ch. / Freq.	Power Middle Ch. / Freq.	Power High Ch. / Freq.	Tune up Limit (dBm)	MPR (dB)
Channel					23230			
Frequency (MHz)					782			
10	QPSK	1	0		19.40		20.00	0
10	QPSK	1	24		19.34			
10	QPSK	1	49		19.23			
10	QPSK	25	0		19.18		20.00	0
10	QPSK	25	12		19.17			
10	QPSK	25	24		19.20			
10	QPSK	50	0		19.15		20.00	0
10	16QAM	1	0		19.35			
10	16QAM	1	24		19.30			
10	16QAM	1	49		19.28		20.00	0
10	16QAM	25	0		19.25			
10	16QAM	25	12		19.21			
10	16QAM	25	24		19.22		20.00	0
10	16QAM	50	0		19.11			
Channel				23205	23230	23255		
Frequency (MHz)				779.5	782	784.5		
5	QPSK	1	0	19.00	19.11	19.34	20.00	0
5	QPSK	1	12	19.09	19.23	19.11		
5	QPSK	1	24	19.35	19.14	19.24		
5	QPSK	12	0	19.34	19.18	19.25	20.00	0
5	QPSK	12	6	19.28	19.23	19.15		
5	QPSK	12	11	19.16	19.30	19.01		
5	QPSK	25	0	19.03	19.16	19.11	20.00	0
5	16QAM	1	0	19.28	19.19	19.29		
5	16QAM	1	12	19.25	19.31	19.05		
5	16QAM	1	24	19.31	19.11	19.12	20.00	0
5	16QAM	12	0	19.18	19.25	19.23		
5	16QAM	12	6	19.04	19.29	19.30		
5	16QAM	12	11	19.19	19.28	19.08	20.00	0
5	16QAM	25	0	19.20	19.21	19.29		



<LTE Band 5 Conducted Power>

Full Power Mode (Proximity Sensor Inactive)

BW [MHz]	Modulation	RB Size	RB Offset	Power Low Ch. / Freq.	Power Middle Ch. / Freq.	Power High Ch. / Freq.	Tune up Limit (dBm)	MPR (dB)
Channel				20450	20525	20600		
Frequency (MHz)				829	836.5	844		
10	QPSK	1	0	22.16	22.11	22.28	24.00	0
10	QPSK	1	24	22.24	22.16	22.11		
10	QPSK	1	49	22.22	22.06	22.23		
10	QPSK	25	0	21.26	21.14	21.21	23.00	1
10	QPSK	25	12	21.16	21.00	21.15		
10	QPSK	25	24	21.20	21.23	21.18		
10	QPSK	50	0	21.22	21.32	21.20		
10	16QAM	1	0	21.03	21.15	21.01	23.00	1
10	16QAM	1	24	21.21	21.17	21.03		
10	16QAM	1	49	21.29	21.13	21.06		
10	16QAM	25	0	20.17	20.28	20.04	22.00	2
10	16QAM	25	12	20.05	20.08	20.04		
10	16QAM	25	24	20.27	20.01	20.10		
10	16QAM	50	0	20.14	20.03	20.11		
Channel				20425	20525	20625		
Frequency (MHz)				826.5	836.5	846.5		
5	QPSK	1	0	22.14	22.11	22.10	24.00	0
5	QPSK	1	12	22.12	22.06	22.03		
5	QPSK	1	24	22.27	22.09	22.08		
5	QPSK	12	0	21.13	21.11	21.12	23.00	1
5	QPSK	12	6	21.19	21.07	21.15		
5	QPSK	12	11	21.13	21.06	21.04		
5	QPSK	25	0	21.11	21.07	21.01		
5	16QAM	1	0	21.21	21.08	21.07	23.00	1
5	16QAM	1	12	21.21	21.27	21.06		
5	16QAM	1	24	21.28	21.05	21.11		
5	16QAM	12	0	20.09	20.08	20.20	22.00	2
5	16QAM	12	6	20.11	20.04	20.14		
5	16QAM	12	11	20.11	20.05	20.22		
5	16QAM	25	0	20.01	20.09	20.04		



<LTE Band 5 Conducted Power>

Reduced Power Mode (Proximity Sensor active)

BW [MHz]	Modulation	RB Size	RB Offset	Power Low Ch. / Freq.	Power Middle Ch. / Freq.	Power High Ch. / Freq.	Tune up Limit (dBm)	MPR (dB)
Channel				20450	20525	20600		
Frequency (MHz)				829	836.5	844		
10	QPSK	1	0	19.39	19.14	19.18	20.00	0
10	QPSK	1	24	19.27	19.22	19.21		
10	QPSK	1	49	19.17	19.06	19.10		
10	QPSK	25	0	19.10	19.29	19.08	20.00	0
10	QPSK	25	12	19.18	19.08	19.11		
10	QPSK	25	24	19.33	19.01	19.17		
10	QPSK	50	0	19.06	19.01	19.19		
10	16QAM	1	0	19.36	19.18	19.13	20.00	0
10	16QAM	1	24	19.32	19.25	19.22		
10	16QAM	1	49	19.33	19.11	19.06		
10	16QAM	25	0	19.02	19.07	19.05	20.00	0
10	16QAM	25	12	19.13	19.15	19.03		
10	16QAM	25	24	19.11	19.12	19.02		
10	16QAM	50	0	19.04	19.09	19.02		
Channel				20425	20525	20625		
Frequency (MHz)				826.5	836.5	846.5		
5	QPSK	1	0	19.30	19.18	19.15	20.00	0
5	QPSK	1	12	19.19	19.22	19.09		
5	QPSK	1	24	19.22	19.11	19.18		
5	QPSK	12	0	19.20	19.17	19.04	20.00	0
5	QPSK	12	6	19.19	19.12	19.14		
5	QPSK	12	11	19.27	19.18	19.14		
5	QPSK	25	0	19.19	19.05	19.04	20.00	0
5	16QAM	1	0	19.19	19.25	19.14		
5	16QAM	1	12	19.22	19.28	19.25		
5	16QAM	1	24	19.26	19.11	19.10	20.00	0
5	16QAM	12	0	19.19	19.22	19.10		
5	16QAM	12	6	19.20	19.20	19.16		
5	16QAM	12	11	19.30	19.15	19.11		
5	16QAM	25	0	19.18	19.02	19.20		



<LTE Band 4 Conducted Power>

Full Power Mode (Proximity Sensor Inactive)

BW [MHz]	Modulation	RB Size	RB Offset	Power Low Ch. / Freq.	Power Middle Ch. / Freq.	Power High Ch. / Freq.	Tune up Limit (dBm)	MPR (dB)
Channel				20050	20175	20300		
Frequency (MHz)				1720	1732.5	1745		
20	QPSK	1	0	22.50	22.45	22.63	24.00	0
20	QPSK	1	49	22.39	22.52	22.44		
20	QPSK	1	99	22.37	22.42	22.27		
20	QPSK	50	0	21.25	21.30	21.23	23.00	1
20	QPSK	50	24	21.35	21.26	21.19		
20	QPSK	50	49	21.14	21.15	21.12		
20	QPSK	100	0	21.35	21.24	21.21		
20	16QAM	1	0	21.53	21.47	21.71	23.00	1
20	16QAM	1	49	21.52	21.49	21.64		
20	16QAM	1	99	21.43	21.43	21.41		
20	16QAM	50	0	20.15	20.14	20.32	22.00	2
20	16QAM	50	24	20.18	20.16	20.21		
20	16QAM	50	49	20.10	20.13	20.27		
20	16QAM	100	0	20.22	20.19	20.22		
Channel				20025	20175	20325		
Frequency (MHz)				1717.5	1732.5	1747.5		
15	QPSK	1	0	22.48	22.47	22.54	24.00	0
15	QPSK	1	37	22.36	22.49	22.60		
15	QPSK	1	74	22.33	22.33	22.29		
15	QPSK	36	0	21.28	21.26	21.37	23.00	1
15	QPSK	36	18	21.30	21.34	21.34		
15	QPSK	36	37	21.22	21.38	21.30		
15	QPSK	75	0	21.30	21.26	21.28		
15	16QAM	1	0	21.56	21.43	21.51	23.00	1
15	16QAM	1	37	21.55	21.70	21.53		
15	16QAM	1	74	21.44	21.49	21.36		
15	16QAM	36	0	20.28	20.29	20.34	22.00	2
15	16QAM	36	18	20.20	20.29	20.37		
15	16QAM	36	37	20.12	20.22	20.28		
15	16QAM	75	0	20.13	20.22	20.32		
Channel				20000	20175	20350		
Frequency (MHz)				1715	1732.5	1750		
10	QPSK	1	0	22.47	22.52	22.49	24.00	0
10	QPSK	1	24	22.49	22.41	22.49		
10	QPSK	1	49	22.39	22.48	22.35		
10	QPSK	25	0	21.52	21.45	21.53	23.00	1
10	QPSK	25	12	21.48	21.42	21.42		
10	QPSK	25	24	21.35	21.52	21.43		
10	QPSK	50	0	21.21	21.33	21.21		
10	16QAM	1	0	21.49	21.49	21.54	23.00	1
10	16QAM	1	24	21.44	21.55	21.67		
10	16QAM	1	49	21.51	21.44	21.36		
10	16QAM	25	0	20.36	20.29	20.50	22.00	2
10	16QAM	25	12	20.30	20.34	20.37		
10	16QAM	25	24	20.39	20.52	20.32		
10	16QAM	50	0	20.19	20.23	20.25		



Channel				19975	20175	20375	Tune up Limit (dBm)	MPR (dB)
Frequency (MHz)				1712.5	1732.5	1752.5		
5	QPSK	1	0	22.58	22.47	22.62	24.00	0
5	QPSK	1	12	22.53	22.53	22.50		
5	QPSK	1	24	22.53	22.53	22.38		
5	QPSK	12	0	21.57	21.57	21.52	23.00	1
5	QPSK	12	6	21.49	21.57	21.61		
5	QPSK	12	11	21.50	21.60	21.50		
5	QPSK	25	0	21.53	21.50	21.47		
5	16QAM	1	0	21.52	21.47	21.57	23.00	1
5	16QAM	1	12	21.62	21.64	21.58		
5	16QAM	1	24	21.58	21.62	21.42		
5	16QAM	12	0	20.51	20.65	20.64	22.00	2
5	16QAM	12	6	20.58	20.56	20.59		
5	16QAM	12	11	20.61	20.59	20.47		
5	16QAM	25	0	20.47	20.37	20.48		



<LTE Band 4 Conducted Power>

Reduced Power Mode (Proximity Sensor active)

BW [MHz]	Modulation	RB Size	RB Offset	Power Low Ch. / Freq.	Power Middle Ch. / Freq.	Power High Ch. / Freq.	Tune up Limit (dBm)	MPR (dB)
Channel				20050	20175	20300		
Frequency (MHz)				1720	1732.5	1745		
20	QPSK	1	0	17.71	17.67	17.80	18.00	0
20	QPSK	1	49	17.59	17.61	17.75		
20	QPSK	1	99	17.78	17.58	17.68		
20	QPSK	50	0	17.42	17.47	17.56	18.00	0
20	QPSK	50	24	17.55	17.50	17.46		
20	QPSK	50	49	17.54	17.46	17.41		
20	QPSK	100	0	17.64	17.45	17.52		
20	16QAM	1	0	17.65	17.60	17.76	18.00	0
20	16QAM	1	49	17.51	17.65	17.71		
20	16QAM	1	99	17.62	17.63	17.63		
20	16QAM	50	0	17.39	17.35	17.61	18.00	0
20	16QAM	50	24	17.42	17.39	17.50		
20	16QAM	50	49	17.32	17.40	17.43		
20	16QAM	100	0	17.49	17.40	17.44		
Channel				20025	20175	20325		
Frequency (MHz)				1717.5	1732.5	1747.5		
15	QPSK	1	0	17.61	17.65	17.78	18.00	0
15	QPSK	1	37	17.51	17.63	17.73		
15	QPSK	1	74	17.50	17.59	17.53		
15	QPSK	36	0	17.42	17.45	17.51	18.00	0
15	QPSK	36	18	17.48	17.53	17.58		
15	QPSK	36	37	17.33	17.44	17.73		
15	QPSK	75	0	17.60	17.50	17.49		
15	16QAM	1	0	17.60	17.60	17.73	18.00	0
15	16QAM	1	37	17.59	17.66	17.76		
15	16QAM	1	74	17.52	17.59	17.54		
15	16QAM	36	0	17.54	17.53	17.55	18.00	0
15	16QAM	36	18	17.44	17.49	17.53		
15	16QAM	36	37	17.30	17.42	17.51		
15	16QAM	75	0	17.35	17.39	17.48		
Channel				20000	20175	20350		
Frequency (MHz)				1715	1732.5	1750		
10	QPSK	1	0	17.48	17.62	17.69	18.00	0
10	QPSK	1	24	17.47	17.60	17.67		
10	QPSK	1	49	17.64	17.79	17.51		
10	QPSK	25	0	17.43	17.56	17.67	18.00	0
10	QPSK	25	12	17.50	17.55	17.53		
10	QPSK	25	24	17.47	17.60	17.57		
10	QPSK	50	0	17.42	17.42	17.45		
10	16QAM	1	0	17.66	17.65	17.73	18.00	0
10	16QAM	1	24	17.60	17.68	17.70		
10	16QAM	1	49	17.65	17.63	17.55		
10	16QAM	25	0	17.54	17.58	17.61	18.00	0
10	16QAM	25	12	17.59	17.52	17.52		
10	16QAM	25	24	17.44	17.60	17.50		
10	16QAM	50	0	17.33	17.41	17.46		



Channel				19975	20175	20375	Tune up Limit (dBm)	MPR (dB)
Frequency (MHz)				1712.5	1732.5	1752.5		
5	QPSK	1	0	17.49	17.67	17.77	18.00	0
5	QPSK	1	12	17.60	17.72	17.71		
5	QPSK	1	24	17.51	17.66	17.50		
5	QPSK	12	0	17.60	17.72	17.64	18.00	0
5	QPSK	12	6	17.67	17.75	17.71		
5	QPSK	12	11	17.48	17.67	17.54		
5	QPSK	25	0	17.61	17.60	17.55		
5	16QAM	1	0	17.59	17.76	17.75	18.00	0
5	16QAM	1	12	17.63	17.65	17.69		
5	16QAM	1	24	17.65	17.66	17.61		
5	16QAM	12	0	17.64	17.61	17.66	18.00	0
5	16QAM	12	6	17.60	17.62	17.67		
5	16QAM	12	11	17.64	17.64	17.57		
5	16QAM	25	0	17.58	17.49	17.55		



<LTE Band 2 Conducted Power>

Full Power Mode (Proximity Sensor Inactive)

BW [MHz]	Modulation	RB Size	RB Offset	Power Low Ch. / Freq.	Power Middle Ch. / Freq.	Power High Ch. / Freq.	Tune up Limit (dBm)	MPR (dB)
Channel				18700	18900	19100		
Frequency (MHz)				1860	1880	1900		
20	QPSK	1	0	22.60	22.49	22.50	24.00	0
20	QPSK	1	49	22.55	22.51	22.44		
20	QPSK	1	99	22.37	22.34	22.84		
20	QPSK	50	0	21.44	21.52	21.53	23.00	1
20	QPSK	50	24	21.39	21.35	21.24		
20	QPSK	50	49	21.23	21.11	21.32		
20	QPSK	100	0	21.43	21.30	21.35		
20	16QAM	1	0	21.56	21.46	21.31	23.00	1
20	16QAM	1	49	21.44	21.44	21.46		
20	16QAM	1	99	21.39	21.17	21.61		
20	16QAM	50	0	20.31	20.32	20.50	22.00	2
20	16QAM	50	24	20.29	20.16	20.21		
20	16QAM	50	49	20.15	20.04	20.18		
20	16QAM	100	0	20.25	20.17	20.23		
Channel				18675	18900	19125		
Frequency (MHz)				1857.5	1880	1902.5		
15	QPSK	1	0	22.44	22.58	22.35	24.00	0
15	QPSK	1	37	22.52	22.44	22.20		
15	QPSK	1	74	22.34	22.27	22.18		
15	QPSK	36	0	21.29	21.39	21.15	23.00	1
15	QPSK	36	18	21.38	21.30	21.29		
15	QPSK	36	37	21.27	21.09	21.30		
15	QPSK	75	0	21.32	21.19	21.26	23.00	1
15	16QAM	1	0	21.41	21.61	21.39		
15	16QAM	1	37	21.52	21.40	21.46		
15	16QAM	1	74	21.36	21.28	21.53		
15	16QAM	36	0	20.43	20.36	20.24	22.00	2
15	16QAM	36	18	20.30	20.23	20.29		
15	16QAM	36	37	20.16	20.06	20.31		
15	16QAM	75	0	20.22	20.22	20.18		
Channel				18650	18900	19150		
Frequency (MHz)				1855	1880	1905		
10	QPSK	1	0	22.68	22.77	22.58	24.00	0
10	QPSK	1	24	22.68	22.70	22.70		
10	QPSK	1	49	22.70	22.61	22.78		
10	QPSK	25	0	21.70	21.78	21.63	23.00	1
10	QPSK	25	12	21.71	21.61	21.75		
10	QPSK	25	24	21.66	21.47	21.56		
10	QPSK	50	0	21.48	21.43	21.39	23.00	1
10	16QAM	1	0	21.65	21.81	21.60		
10	16QAM	1	24	21.62	21.83	21.68		
10	16QAM	1	49	21.60	21.54	21.82		
10	16QAM	25	0	20.65	20.72	20.59	22.00	2
10	16QAM	25	12	20.50	20.49	20.52		
10	16QAM	25	24	20.57	20.47	20.55		
10	16QAM	50	0	20.36	20.43	20.46		



Channel				18625	18900	19175	Tune up Limit (dBm)	MPR (dB)
Frequency (MHz)				1852.5	1880	1907.5		
5	QPSK	1	0	22.64	22.70	22.69	24.00	0
5	QPSK	1	12	22.61	22.57	22.68		
5	QPSK	1	24	22.62	22.40	22.80		
5	QPSK	12	0	21.55	21.69	21.69	23.00	1
5	QPSK	12	6	21.65	21.64	21.61		
5	QPSK	12	11	21.71	21.57	21.69		
5	QPSK	25	0	21.53	21.53	21.60		
5	16QAM	1	0	21.62	21.79	21.66	23.00	1
5	16QAM	1	12	21.66	21.63	21.70		
5	16QAM	1	24	21.61	21.47	21.81		
5	16QAM	12	0	20.76	20.60	20.76	22.00	2
5	16QAM	12	6	20.64	20.71	20.77		
5	16QAM	12	11	20.68	20.47	20.77		
5	16QAM	25	0	20.66	20.41	20.56		



<LTE Band 2 Conducted Power>

Reduced Power Mode (Proximity Sensor active)

BW [MHz]	Modulation	RB Size	RB Offset	Power Low Ch. / Freq.	Power Middle Ch. / Freq.	Power High Ch. / Freq.	Tune up Limit (dBm)	MPR (dB)
Channel				18700	18900	19100		
Frequency (MHz)				1860	1880	1900		
20	QPSK	1	0	17.62	17.77	17.56	18.00	0
20	QPSK	1	49	17.55	17.80	17.95		
20	QPSK	1	99	17.52	17.52	17.84		
20	QPSK	50	0	17.59	17.81	17.54	18.00	0
20	QPSK	50	24	17.58	17.52	17.53		
20	QPSK	50	49	17.45	17.51	17.57		
20	QPSK	100	0	17.60	17.60	17.61		
20	16QAM	1	0	17.81	17.80	17.95	18.00	0
20	16QAM	1	49	17.86	17.73	17.89		
20	16QAM	1	99	17.83	17.65	17.84		
20	16QAM	50	0	17.65	17.76	17.53	18.00	0
20	16QAM	50	24	17.53	17.64	17.49		
20	16QAM	50	49	17.40	17.32	17.49		
20	16QAM	100	0	17.50	17.43	17.51		
Channel				18675	18900	19125		
Frequency (MHz)				1857.5	1880	1902.5		
15	QPSK	1	0	17.73	17.76	17.52	18.00	0
15	QPSK	1	37	17.82	17.69	17.79		
15	QPSK	1	74	17.60	17.55	17.84		
15	QPSK	36	0	17.56	17.62	17.47	18.00	0
15	QPSK	36	18	17.61	17.50	17.62		
15	QPSK	36	37	17.42	17.35	17.58		
15	QPSK	75	0	17.69	17.50	17.48		
15	16QAM	1	0	17.43	17.75	17.61	18.00	0
15	16QAM	1	37	17.85	17.69	17.86		
15	16QAM	1	74	17.67	17.48	17.85		
15	16QAM	36	0	17.60	17.64	17.53	18.00	0
15	16QAM	36	18	17.76	17.50	17.59		
15	16QAM	36	37	17.65	17.32	17.52		
15	16QAM	75	0	17.53	17.41	17.43		
Channel				18650	18900	19150		
Frequency (MHz)				1855	1880	1905		
10	QPSK	1	0	17.73	17.80	17.56	18.00	0
10	QPSK	1	24	17.78	17.84	17.88		
10	QPSK	1	49	17.66	17.56	17.82		
10	QPSK	25	0	17.79	17.73	17.69	18.00	0
10	QPSK	25	12	17.54	17.56	17.65		
10	QPSK	25	24	17.62	17.41	17.65		
10	QPSK	50	0	17.45	17.54	17.50		
10	16QAM	1	0	17.60	17.77	17.72	18.00	0
10	16QAM	1	24	17.59	17.65	17.82		
10	16QAM	1	49	17.66	17.56	17.84		
10	16QAM	25	0	17.56	17.75	17.63	18.00	0
10	16QAM	25	12	17.50	17.62	17.60		
10	16QAM	25	24	17.57	17.42	17.60		
10	16QAM	50	0	17.43	17.62	17.53		



Channel				18625	18900	19175	Tune up Limit (dBm)	MPR (dB)
Frequency (MHz)				1852.5	1880	1907.5		
5	QPSK	1	0	17.62	17.87	17.84	18.00	0
5	QPSK	1	12	17.63	17.63	17.81		
5	QPSK	1	24	17.86	17.75	17.82		
5	QPSK	12	0	17.87	17.63	17.64	18.00	0
5	QPSK	12	6	17.51	17.67	17.72		
5	QPSK	12	11	17.68	17.51	17.90		
5	QPSK	25	0	17.84	17.82	17.73		
5	16QAM	1	0	17.68	17.76	17.77	18.00	0
5	16QAM	1	12	17.69	17.82	17.76		
5	16QAM	1	24	17.64	17.53	17.84		
5	16QAM	12	0	17.70	17.69	17.81	18.00	0
5	16QAM	12	6	17.70	17.73	17.77		
5	16QAM	12	11	17.75	17.74	17.78		
5	16QAM	25	0	17.63	17.75	17.66		



<LTE Band 25 Conducted Power>

Full Power Mode (Proximity Sensor Inactive)

BW [MHz]	Modulation	RB Size	RB Offset	Power Low Ch. / Freq.	Power Middle Ch. / Freq.	Power High Ch. / Freq.	Tune up Limit (dBm)	MPR (dB)
Channel				26140	26365	26590		
Frequency (MHz)				1860	1882.5	1905		
20	QPSK	1	0	22.57	22.51	22.41	24.00	0
20	QPSK	1	49	22.73	22.49	22.36		
20	QPSK	1	99	22.46	22.38	22.30		
20	QPSK	50	0	21.43	21.25	21.35	23.00	1
20	QPSK	50	24	21.40	21.17	21.32		
20	QPSK	50	49	21.42	21.07	21.39		
20	QPSK	100	0	21.41	21.28	21.29	23.00	1
20	16QAM	1	0	21.59	21.52	21.57		
20	16QAM	1	49	21.54	21.46	21.57		
20	16QAM	1	99	21.51	21.33	21.64	22.00	2
20	16QAM	50	0	20.25	20.19	20.20		
20	16QAM	50	24	20.33	20.14	20.28		
20	16QAM	50	49	20.36	20.07	20.34	22.00	2
20	16QAM	100	0	20.37	20.34	20.32		
20	16QAM	100	0	20.37	20.34	20.32		
Channel				26115	26365	26615		
Frequency (MHz)				1857.5	1882.5	1907.5		
15	QPSK	1	0	22.69	22.72	22.55	24.00	0
15	QPSK	1	37	22.51	22.49	22.59		
15	QPSK	1	74	22.63	22.41	22.65		
15	QPSK	36	0	21.46	21.45	21.27	23.00	1
15	QPSK	36	18	21.34	21.40	21.46		
15	QPSK	36	37	21.43	21.25	21.62		
15	QPSK	75	0	21.33	21.18	21.42	23.00	1
15	16QAM	1	0	21.71	21.67	21.50		
15	16QAM	1	37	21.47	21.50	21.54		
15	16QAM	1	74	21.55	21.32	21.67	22.00	2
15	16QAM	36	0	20.31	20.34	20.24		
15	16QAM	36	18	20.30	20.27	20.39		
15	16QAM	36	37	20.50	20.20	20.59	22.00	2
15	16QAM	75	0	20.27	20.29	20.23		
15	16QAM	75	0	20.27	20.29	20.23		
Channel				26090	26365	26640		
Frequency (MHz)				1855	1882.5	1910		
10	QPSK	1	0	22.63	22.66	22.49	24.00	0
10	QPSK	1	24	22.56	22.50	22.61		
10	QPSK	1	49	22.56	22.41	22.66		
10	QPSK	25	0	21.53	21.53	21.57	23.00	1
10	QPSK	25	12	21.37	21.45	21.59		
10	QPSK	25	24	21.32	21.38	21.57		
10	QPSK	50	0	21.39	21.20	21.41	23.00	1
10	16QAM	1	0	21.60	21.69	21.50		
10	16QAM	1	24	21.60	21.56	21.68		
10	16QAM	1	49	21.59	21.34	21.68	22.00	2
10	16QAM	25	0	20.53	20.44	20.60		
10	16QAM	25	12	20.40	20.41	20.60		
10	16QAM	25	24	20.29	20.24	20.50	22.00	2
10	16QAM	50	0	20.22	20.19	20.36		



Channel				26065	26365	26665	Tune up Limit (dBm)	MPR (dB)
Frequency (MHz)				1852.5	1882.5	1912.5		
5	QPSK	1	0	22.58	22.50	22.59	24.00	0
5	QPSK	1	12	22.52	22.47	22.64		
5	QPSK	1	24	22.51	22.42	22.62		
5	QPSK	12	0	21.54	21.54	21.69	23.00	1
5	QPSK	12	6	21.54	21.56	21.74		
5	QPSK	12	11	21.42	21.43	21.70		
5	QPSK	25	0	21.45	21.34	21.58		
5	16QAM	1	0	21.58	21.48	21.58	23.00	1
5	16QAM	1	12	21.45	21.49	21.74		
5	16QAM	1	24	21.41	21.50	21.71		
5	16QAM	12	0	20.43	20.62	20.58	22.00	2
5	16QAM	12	6	20.48	20.42	20.64		
5	16QAM	12	11	20.53	20.49	20.59		
5	16QAM	25	0	20.42	20.30	20.64		



<LTE Band 25 Conducted Power>

Reduced Power Mode (Proximity Sensor active)

BW [MHz]	Modulation	RB Size	RB Offset	Power Low Ch. / Freq.	Power Middle Ch. / Freq.	Power High Ch. / Freq.	Tune up Limit (dBm)	MPR (dB)
Channel				26140	26365	26590		
Frequency (MHz)				1860	1882.5	1905		
20	QPSK	1	0	17.69	17.57	17.56	18.00	0
20	QPSK	1	49	17.81	17.51	17.63		
20	QPSK	1	99	17.48	17.49	17.95		
20	QPSK	50	0	17.49	17.48	17.66	18.00	0
20	QPSK	50	24	17.64	17.42	17.46		
20	QPSK	50	49	17.55	17.29	17.47		
20	QPSK	100	0	17.51	17.42	17.48	18.00	0
20	16QAM	1	0	17.77	17.79	17.81		
20	16QAM	1	49	17.90	17.59	17.64		
20	16QAM	1	99	17.54	17.42	17.82	18.00	0
20	16QAM	50	0	17.59	17.41	17.52		
20	16QAM	50	24	17.46	17.38	17.44		
20	16QAM	50	49	17.44	17.24	17.48	18.00	0
20	16QAM	100	0	17.43	17.37	17.42		
Channel				26115	26365	26615		
Frequency (MHz)				1857.5	1882.5	1907.5		
15	QPSK	1	0	17.81	17.76	17.59	18.00	0
15	QPSK	1	37	17.66	17.60	17.69		
15	QPSK	1	74	17.85	17.44	17.82		
15	QPSK	36	0	17.44	17.44	17.47	18.00	0
15	QPSK	36	18	17.43	17.43	17.55		
15	QPSK	36	37	17.44	17.38	17.65		
15	QPSK	75	0	17.45	17.40	17.46	18.00	0
15	16QAM	1	0	17.81	17.88	17.53		
15	16QAM	1	37	17.58	17.87	17.66		
15	16QAM	1	74	17.61	17.43	17.79	18.00	0
15	16QAM	36	0	17.41	17.62	17.44		
15	16QAM	36	18	17.55	17.42	17.55		
15	16QAM	36	37	17.69	17.35	17.74	18.00	0
15	16QAM	75	0	17.43	17.52	17.47		
Channel				26090	26365	26640		
Frequency (MHz)				1855	1882.5	1910		
10	QPSK	1	0	17.68	17.77	17.67	18.00	0
10	QPSK	1	24	17.74	17.66	17.80		
10	QPSK	1	49	17.81	17.37	17.78		
10	QPSK	25	0	17.61	17.48	17.66	18.00	0
10	QPSK	25	12	17.60	17.47	17.75		
10	QPSK	25	24	17.42	17.38	17.64		
10	QPSK	50	0	17.63	17.32	17.65	18.00	0
10	16QAM	1	0	17.64	17.65	17.74		
10	16QAM	1	24	17.57	17.75	17.75		
10	16QAM	1	49	17.58	17.63	17.67	18.00	0
10	16QAM	25	0	17.70	17.41	17.65		
10	16QAM	25	12	17.51	17.41	17.67		
10	16QAM	25	24	17.39	17.36	17.70	18.00	0
10	16QAM	50	0	17.41	17.32	17.61		



Channel				26065	26365	26665	Tune up Limit (dBm)	MPR (dB)
Frequency (MHz)				1852.5	1882.5	1912.5		
5	QPSK	1	0	17.54	17.66	17.68	18.00	0
5	QPSK	1	12	17.62	17.64	17.76		
5	QPSK	1	24	17.50	17.45	17.69		
5	QPSK	12	0	17.48	17.48	17.69	18.00	0
5	QPSK	12	6	17.38	17.47	17.65		
5	QPSK	12	11	17.58	17.48	17.72		
5	QPSK	25	0	17.49	17.41	17.69		
5	16QAM	1	0	17.64	17.54	17.69	18.00	0
5	16QAM	1	12	17.72	17.53	17.80		
5	16QAM	1	24	17.48	17.45	17.78		
5	16QAM	12	0	17.55	17.53	17.65	18.00	0
5	16QAM	12	6	17.78	17.49	17.73		
5	16QAM	12	11	17.47	17.50	17.69		
5	16QAM	25	0	17.41	17.41	17.71		

11. Antenna Location

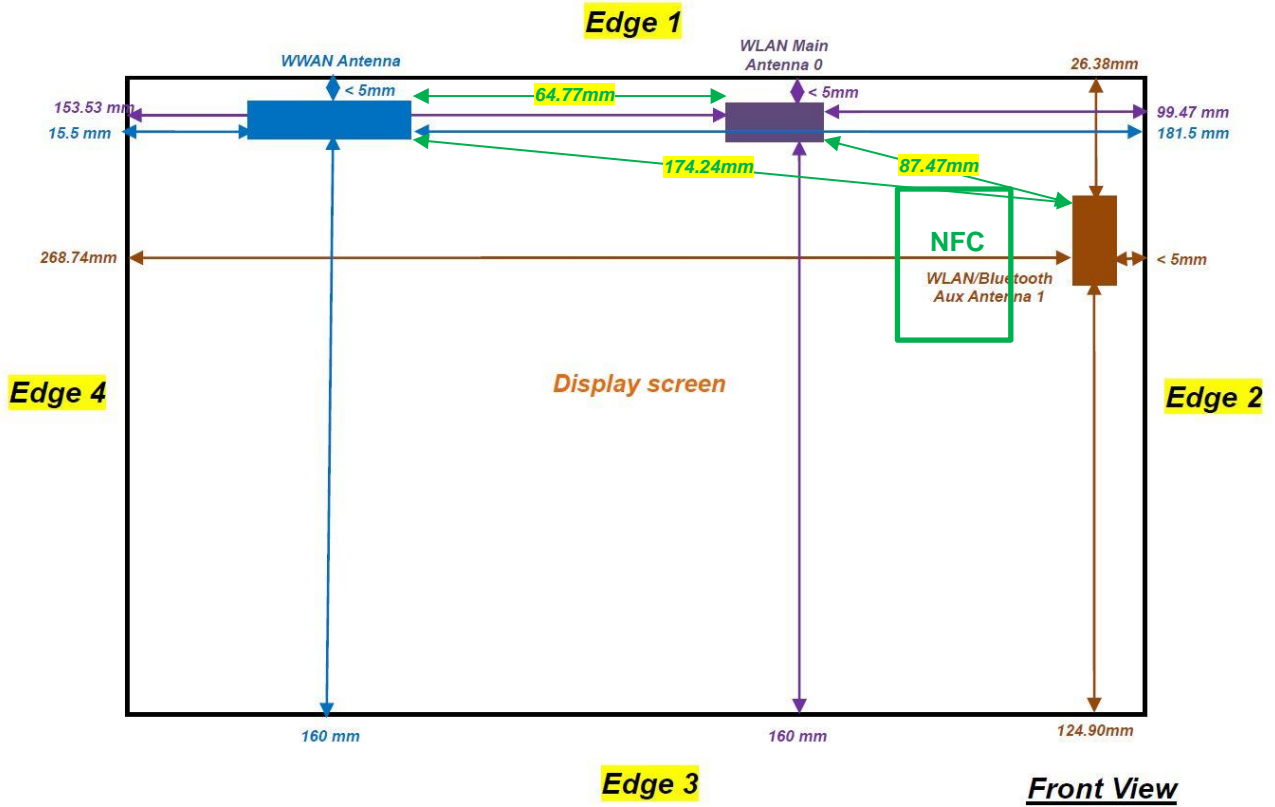



<SAR test exclusion table>

Exposure Position	Wireless Interface	GPRS 850	GPRS 1900	WCDMA Band V	WCDMA Band IV	WCDMA Band II	CDMA 2000 BC10	CDMA 2000 BC0	CDMA 2000 BC1	LTE Band 17	LTE Band 13	LTE Band 5	LTE Band 4	LTE Band 2	LTE Band 25
		Class10	Class10												
Exposure Position	Maximum power	27	24	24	24	24	24.5	24.5	24.5	24	24	24	24	24	24
	Maximum rated power(mW)	501.00	251.00	251.00	251.00	251.00	282.00	282.00	282.00	251.00	251.00	251.00	251.00	251.00	251.00
Bottom Face	Antenna to user (mm)	5													
	SAR exclusion threshold	92.27	69.36	46.17	66.41	69.32	51.88	51.94	77.89	42.39	44.45	46.23	66.48	69.36	69.45
	SAR testing required?	Yes	Yes	Yes	Yes	Yes	Yes	Yes	Yes	Yes	Yes	Yes	Yes	Yes	Yes
Edge 1	Antenna to user (mm)	5													
	SAR exclusion threshold	92.27	69.36	46.17	66.41	69.32	51.88	51.94	77.89	42.39	44.45	46.23	66.48	69.36	69.45
	SAR testing required?	Yes	Yes	Yes	Yes	Yes	Yes	Yes	Yes	Yes	Yes	Yes	Yes	Yes	Yes
Edge 2	Antenna to user (mm)	181.5													
	SAR exclusion threshold	906.30	1423.56	904.74	1428.39	1423.62	904.74	906.3	1423.62	802.71	856.71	906.3	1428.26	1423.56	1423.42
	SAR testing required?	No	No	No	No	No	No	No	No	No	No	No	No	No	No
Edge 3	Antenna to user (mm)	160													
	SAR exclusion threshold	784.76	1208.56	783.48	1213.39	1208.62	783.48	784.76	1208.62	700.51	744.34	784.76	1213.26	1208.56	1208.42
	SAR testing required?	No	No	No	No	No	No	No	No	No	No	No	No	No	No
Edge 4	Antenna to user (mm)	15.5													
	SAR exclusion threshold	29.76	22.37	14.89	21.42	22.36	16.73	16.75	25.12	13.67	14.34	14.91	21.45	22.37	22.4
	SAR testing required?	Yes	Yes	Yes	Yes	Yes	Yes	Yes	Yes	Yes	Yes	Yes	Yes	Yes	Yes

Note:

- Maximum power is the source-based time-average power and represents the maximum RF output power among production units
- Per KDB 447498 D01v05r01, for larger devices, the test separation distance of adjacent edge configuration is determined by the closest separation between the antenna and the user.
- Per KDB 447498 D01v05r01, standalone SAR test exclusion threshold is applied; If the distance of the antenna to the user is < 5mm, 5mm is used to determine SAR exclusion threshold
- Per KDB 447498 D01v05r01, the 1-g and 10-g SAR test exclusion thresholds for 100 MHz to 6 GHz at test separation distances ≤ 50 mm are determined by:

$$[(\text{max. power of channel, including tune-up tolerance, mW}) / (\text{min. test separation distance, mm})] \cdot [\sqrt{f(\text{GHz})}] \leq 3.0$$
 for 1-g SAR and ≤ 7.5 for 10-g extremity SAR
 - f(GHz) is the RF channel transmit frequency in GHz
 - Power and distance are rounded to the nearest mW and mm before calculation
 - The result is rounded to one decimal place for comparison
- Per KDB 447498 D01v05r01, at 100 MHz to 6 GHz and for test separation distances > 50 mm, the SAR test exclusion threshold is determined according to the following
 - Threshold at 50 mm in step 1) + (test separation distance - 50 mm) · (f(MHz)/150)] mW, at 100 MHz to 1500 MHz
 - Threshold at 50 mm in step 1) + (test separation distance - 50 mm) · 10] mW at > 1500 MHz and ≤ 6 GHz

12. SAR Test Results

Note:

1. Per KDB 447498 D01v05r01, the reported SAR is the measured SAR value adjusted for maximum tune-up tolerance.
 - a. Tune-up scaling Factor = tune-up limit power (mW) / EUT RF power (mW), where tune-up limit is the maximum rated power among all production units.
 - b. For WWAN: Reported SAR(W/kg)= Measured SAR(W/kg)*Tune-up Scaling Factor
2. Per KDB 447498 D01v05r01, for each exposure position, if the highest output channel reported SAR ≤0.8W/kg, other channels SAR testing is not necessary.
3. For the exposure positions that proximity sensor power reduction is applied for SAR compliance, additional SAR testing with EUT transmitting full power in normal mode was performed; 1cm for Bottom Face, 1.1cm for Edge 1.
4. Per KDB 616217 D04v01r01, the additional separation introduced by the contour against a flat phantom is < 5 mm and reported SAR is < 1.2 W/kg, a curved or contoured back surface or edge SAR is not required, more detail information please refer to the setup photo.
5. Per KDB 941225 D02v02r02, RMC 12.2kbps setting is used to evaluate SAR. If HSDPA/HSUPA output power is < 0.25dB higher than RMC12.2Kbps, or reported SAR with RMC 12.2kbps setting is ≤ 1.2W/kg, HSDPA/HSUPA SAR evaluation can be excluded.
6. Per KDB 941225 D05v02r02, when reported SAR of 1RB and 50%RB allocation for QPSK ≤0.8W/kg, and 100%RB with QPSK output power is less than 1RB and 50%RB, 100%RB allocation for QPSK is not required.
7. Per KDB 941225 D05v02r02, when reported SAR of 1RB and 50%RB allocation for QPSK >0.8W/kg for any exposure position, SAR testing of 100%RB allocation for QPSK is performed at the highest power channel.
8. 16QAM output power for each RB allocation configuration is > not ½ dB higher than the same configuration in QPSK and the reported SAR for the QPSK configuration is ≤ 1.45 W/kg; Per KDB 941225 D05v02, 16QAM SAR testing is not required.
9. Smaller bandwidth output power for each RB allocation configuration is > not ½ dB higher than the same configuration in the largest supported bandwidth, and the reported SAR for the largest supported bandwidth is ≤ 1.45 W/kg; Per KDB 941225 D05v02r02, smaller bandwidth SAR testing is not required.

12.1 Body SAR

<GSM SAR>

Plot No.	Band	Mode	Test Position	Gap (cm)	Ch.	Freq. (MHz)	Power Back-off	Average Power (dBm)	Tune-Up Limit (dBm)	Tune-up Scaling Factor	Power Drift (dB)	Measured 1g SAR (W/kg)	Reported 1g SAR (W/kg)
	GSM850	GPRS (2 Tx slots)	Bottom Face	1cm	128	824.2	OFF	31.25	33	1.496	0.02	0.427	0.639
	GSM850	GPRS (2 Tx slots)	Edge 1	1.1cm	128	824.2	OFF	31.25	33	1.496	0.02	0.445	0.666
	GSM850	GPRS (2 Tx slots)	Edge 4	0cm	128	824.2	OFF	31.25	33	1.496	0.08	0.271	0.405
	GSM850	GPRS (2 Tx slots)	Bottom Face	0cm	251	848.8	ON	26.91	27	1.021	-0.12	0.765	0.781
01	GSM850	GPRS (2 Tx slots)	Edge 1	0cm	251	848.8	ON	26.91	27	1.021	-0.01	1.030	1.052
	GSM850	GPRS (2 Tx slots)	Edge 1	0cm	128	824.2	ON	26.88	27	1.028	-0.08	0.873	0.897
	GSM850	GPRS (2 Tx slots)	Edge 1	0cm	189	836.4	ON	26.87	27	1.030	-0.04	0.928	0.956
	GSM1900	GPRS (2 Tx slots)	Bottom Face	1cm	661	1880	OFF	28.66	30	1.361	-0.01	0.431	0.587
	GSM1900	GPRS (2 Tx slots)	Edge 1	1.1cm	661	1880	OFF	28.66	30	1.361	-0.08	0.590	0.803
	GSM1900	GPRS (2 Tx slots)	Edge 1	1.1cm	512	1850.2	OFF	28.48	30	1.419	-0.05	0.557	0.790
	GSM1900	GPRS (2 Tx slots)	Edge 1	1.1cm	810	1909.8	OFF	28.47	30	1.422	-0.01	0.557	0.792
	GSM1900	GPRS (2 Tx slots)	Edge 4	0cm	661	1880	OFF	28.66	30	1.361	0.06	0.378	0.515
	GSM1900	GPRS (2 Tx slots)	Bottom Face	0cm	810	1909.8	ON	24.19	24.5	1.074	-0.03	0.652	0.700
02	GSM1900	GPRS (2 Tx slots)	Edge 1	0cm	810	1909.8	ON	24.19	24.5	1.074	-0.03	1.070	1.149
	GSM1900	GPRS (2 Tx slots)	Edge 1	0cm	512	1850.2	ON	24.06	24.5	1.107	-0.06	0.862	0.954
	GSM1900	GPRS (2 Tx slots)	Edge 1	0cm	661	1880	ON	24.08	24.5	1.102	-0.12	0.954	1.051



<WCDMA SAR>

Plot No.	Band	Mode	Test Position	Gap (cm)	Ch.	Freq. (MHz)	Power Back-off	Average Power (dBm)	Tune-Up Limit (dBm)	Tune-up Scaling Factor	Power Drift (dB)	Measured 1g SAR (W/kg)	Reported 1g SAR (W/kg)
	WCDMA V	RMC12.2Kbps	Bottom Face	1cm	4132	826.4	OFF	22.22	24	1.507	-0.12	0.243	0.366
	WCDMA V	RMC12.2Kbps	Edge 1	1.1cm	4132	826.4	OFF	22.22	24	1.507	-0.16	0.233	0.351
	WCDMA V	RMC12.2Kbps	Edge 4	0cm	4132	826.4	OFF	22.22	24	1.507	-0.02	0.137	0.206
	WCDMA V	RMC12.2Kbps	Bottom Face	0cm	4233	846.6	ON	18.29	18.5	1.050	0.02	0.427	0.448
03	WCDMA V	RMC12.2Kbps	Edge 1	0cm	4233	846.6	ON	18.29	18.5	1.050	0.14	0.561	0.589
	WCDMA IV	RMC12.2Kbps	Bottom Face	1cm	1413	1732.6	OFF	22.37	24	1.455	-0.16	0.703	1.023
	WCDMA IV	RMC12.2Kbps	Bottom Face	1cm	1312	1712.4	OFF	22.18	24	1.521	-0.01	0.739	1.124
	WCDMA IV	RMC12.2Kbps	Bottom Face	1cm	1513	1752.6	OFF	22.24	24	1.500	-0.05	0.684	1.026
	WCDMA IV	RMC12.2Kbps	Edge 1	1.1cm	1413	1732.6	OFF	22.37	24	1.455	-0.19	0.490	0.713
	WCDMA IV	RMC12.2Kbps	Edge 4	0cm	1413	1732.6	OFF	22.37	24	1.455	0.11	0.689	1.003
	WCDMA IV	RMC12.2Kbps	Edge 4	0cm	1312	1712.4	OFF	22.18	24	1.521	-0.11	0.664	1.010
	WCDMA IV	RMC12.2Kbps	Edge 4	0cm	1513	1752.6	OFF	22.24	24	1.500	-0.15	0.624	0.936
	WCDMA IV	RMC12.2Kbps	Bottom Face	0cm	1413	1732.6	ON	17.99	18	1.002	0.01	1.050	1.052
	WCDMA IV	RMC12.2Kbps	Bottom Face	0cm	1312	1712.4	ON	17.92	18	1.019	-0.09	1.070	1.090
	WCDMA IV	RMC12.2Kbps	Bottom Face	0cm	1513	1752.6	ON	17.74	18	1.062	-0.02	0.891	0.946
	WCDMA IV	RMC12.2Kbps	Edge 1	0cm	1413	1732.6	ON	17.99	18	1.002	-0.1	1.110	1.113
	WCDMA IV	RMC12.2Kbps	Edge 1	0cm	1312	1712.4	ON	17.92	18	1.019	-0.12	1.040	1.059
04	WCDMA IV	RMC12.2Kbps	Edge 1	0cm	1513	1752.6	ON	17.74	18	1.062	-0.05	1.100	1.168
	WCDMA II	RMC 12.2Kbps	Bottom Face	1cm	9400	1880	OFF	22.55	24	1.396	0.06	0.509	0.711
	WCDMA II	RMC 12.2Kbps	Edge 1	1.1cm	9400	1880	OFF	22.55	24	1.396	0.07	0.704	0.983
	WCDMA II	RMC 12.2Kbps	Edge 1	1.1cm	9262	1852.4	OFF	22.51	24	1.409	-0.02	0.701	0.988
	WCDMA II	RMC 12.2Kbps	Edge 1	1.1cm	9538	1907.6	OFF	22.54	24	1.400	-0.03	0.660	0.924
	WCDMA II	RMC 12.2Kbps	Edge 4	0cm	9400	1880	OFF	22.55	24	1.396	-0.07	0.455	0.635
	WCDMA II	RMC 12.2Kbps	Bottom Face	0cm	9400	1880	ON	17.84	18	1.038	-0.12	0.755	0.783
	WCDMA II	RMC 12.2Kbps	Edge 1	0cm	9400	1880	ON	17.84	18	1.038	-0.11	1.030	1.069
	WCDMA II	RMC 12.2Kbps	Edge 1	0cm	9262	1852.4	ON	17.71	18	1.069	-0.07	0.960	1.026
05	WCDMA II	RMC 12.2Kbps	Edge 1	0cm	9538	1907.6	ON	17.78	18	1.052	-0.04	1.090	1.147



<CDMA SAR>

Plot No.	Band	Mode	Test Position	Gap (cm)	Ch.	Freq. (MHz)	Power Back-off	Average Power (dBm)	Tune-Up Limit (dBm)	Tune-up Scaling Factor	Power Drift (dB)	Measured 1g SAR (W/kg)	Reported 1g SAR (W/kg)
	CDMA BC10	RTAP 153.6Kbps	Bottom Face	1cm	476	817.9	OFF	23.35	24.5	1.303	0.04	0.374	0.487
	CDMA BC10	RTAP 153.6Kbps	Edge 1	1.1cm	476	817.9	OFF	23.35	24.5	1.303	0.04	0.317	0.413
	CDMA BC10	RTAP 153.6Kbps	Edge 4	0cm	476	817.9	OFF	23.35	24.5	1.303	-0.03	0.097	0.126
	CDMA BC10	RTAP 153.6Kbps	Bottom Face	0cm	476	817.9	ON	20.36	20.5	1.033	-0.02	0.672	0.694
	CDMA BC10	RTAP 153.6Kbps	Edge 1	0cm	476	817.9	ON	20.36	20.5	1.033	-0.02	0.817	0.844
	CDMA BC10	RTAP 153.6Kbps	Edge 1	0cm	580	820.5	ON	20.22	20.5	1.067	0.03	0.830	0.885
06	CDMA BC10	RTAP 153.6Kbps	Edge 1	0cm	684	823.1	ON	20.28	20.5	1.052	0.02	0.870	0.915
	CDMA BC0	RTAP 153.6Kbps	Bottom Face	1cm	1013	824.7	OFF	23.26	24.5	1.330	0.01	0.372	0.495
	CDMA BC0	RTAP 153.6Kbps	Edge 1	1.1cm	1013	824.7	OFF	23.26	24.5	1.330	-0.1	0.355	0.472
	CDMA BC0	RTAP 153.6Kbps	Edge 4	0cm	1013	824.7	OFF	23.26	24.5	1.330	0.04	0.178	0.237
	CDMA BC0	RTAP 153.6Kbps	Bottom Face	0cm	1013	824.7	ON	20.42	20.5	1.019	-0.07	0.692	0.705
	CDMA BC0	RTAP 153.6Kbps	Edge 1	0cm	1013	824.7	ON	20.42	20.5	1.019	-0.05	0.900	0.917
	CDMA BC0	RTAP 153.6Kbps	Edge 1	0cm	384	836.52	ON	20.37	20.5	1.030	0.06	0.899	0.926
07	CDMA BC0	RTAP 153.6Kbps	Edge 1	0cm	777	848.31	ON	20.19	20.5	1.074	0.04	0.880	0.945
	CDMA BC1	RTAP 153.6Kbps	Bottom Face	1cm	25	1851.25	OFF	23.86	24.5	1.159	-0.07	0.639	0.740
	CDMA BC1	RTAP 153.6Kbps	Edge 1	1.1cm	25	1851.25	OFF	23.86	24.5	1.159	-0.03	0.913	1.058
	CDMA BC1	RTAP 153.6Kbps	Edge 1	1.1cm	600	1880	OFF	23.72	24.5	1.197	-0.01	0.856	1.024
	CDMA BC1	RTAP 153.6Kbps	Edge 1	1.1cm	1175	1908.75	OFF	23.78	24.5	1.180	-0.07	0.817	0.964
	CDMA BC1	RTAP 153.6Kbps	Edge 4	0cm	25	1851.25	OFF	23.86	24.5	1.159	-0.09	0.583	0.676
	CDMA BC1	RTAP 153.6Kbps	Bottom Face	0cm	25	1851.25	ON	17.96	18	1.009	0.14	0.737	0.744
	CDMA BC1	RTAP 153.6Kbps	Edge 1	0cm	25	1851.25	ON	17.96	18	1.009	-0.02	1.010	1.019
	CDMA BC1	RTAP 153.6Kbps	Edge 1	0cm	600	1880	ON	17.25	18	1.189	-0.04	0.962	1.143
08	CDMA BC1	RTAP 153.6Kbps	Edge 1	0cm	1175	1908.75	ON	17.92	18	1.019	-0.13	1.140	1.161



<LTE SAR>

Plot No.	Band	BW (MHz)	Modulation	RB Size	RB offset	Test Position	Gap (cm)	Ch.	Freq. (MHz)	Power Back-off	Average Power (dBm)	Tune-Up Limit (dBm)	Tune-up Scaling Factor	Power Drift (dB)	Measured 1g SAR (W/kg)	Reported 1g SAR (W/kg)
	LTE Band 17	10M	QPSK	1	0	Bottom Face	1cm	23800	711	OFF	22.55	24	1.396	0.03	0.175	0.244
	LTE Band 17	10M	QPSK	25	24	Bottom Face	1cm	23780	709	OFF	21.53	23	1.403	0.05	0.135	0.189
	LTE Band 17	10M	QPSK	1	0	Edge 1	1.1cm	23800	711	OFF	22.55	24	1.396	0.18	0.113	0.158
	LTE Band 17	10M	QPSK	25	24	Edge 1	1.1cm	23780	709	OFF	21.53	23	1.403	-0.11	0.099	0.139
	LTE Band 17	10M	QPSK	1	0	Edge 4	0cm	23800	711	OFF	22.55	24	1.396	0.14	0.096	0.134
	LTE Band 17	10M	QPSK	25	24	Edge 4	0cm	23780	709	OFF	21.53	23	1.403	0.19	0.075	0.105
	LTE Band 17	10M	QPSK	1	0	Bottom Face	0cm	23800	711	ON	19.66	21	1.361	-0.14	0.389	0.530
	LTE Band 17	10M	QPSK	25	0	Bottom Face	0cm	23800	711	ON	19.56	21	1.393	0.19	0.381	0.531
	LTE Band 17	10M	QPSK	1	0	Edge 1	0cm	23800	711	ON	19.66	21	1.361	0.14	0.403	0.549
09	LTE Band 17	10M	QPSK	25	0	Edge 1	0cm	23800	711	ON	19.56	21	1.393	-0.17	0.408	0.568
	LTE Band 13	10M	QPSK	1	0	Bottom Face	1cm	23230	782	OFF	22.43	24	1.435	0.04	0.177	0.254
	LTE Band 13	10M	QPSK	25	12	Bottom Face	1cm	23230	782	OFF	21.23	23	1.503	0.05	0.138	0.207
	LTE Band 13	10M	QPSK	1	0	Edge 1	1.1cm	23230	782	OFF	22.43	24	1.435	-0.08	0.110	0.158
	LTE Band 13	10M	QPSK	25	12	Edge 1	1.1cm	23230	782	OFF	21.23	23	1.503	-0.12	0.119	0.179
	LTE Band 13	10M	QPSK	1	0	Edge 4	0cm	23230	782	OFF	22.43	24	1.435	-0.01	0.075	0.108
	LTE Band 13	10M	QPSK	25	12	Edge 4	0cm	23230	782	OFF	21.23	23	1.503	-0.01	0.117	0.176
	LTE Band 13	10M	QPSK	1	0	Bottom Face	0cm	23230	782	ON	19.4	20	1.148	0.12	0.405	0.465
	LTE Band 13	10M	QPSK	25	24	Bottom Face	0cm	23230	782	ON	19.2	20	1.202	0.08	0.431	0.518
10	LTE Band 13	10M	QPSK	1	0	Edge 1	0cm	23230	782	ON	19.4	20	1.148	-0.15	0.681	0.782
	LTE Band 13	10M	QPSK	25	24	Edge 1	0cm	23230	782	ON	19.2	20	1.202	-0.04	0.626	0.753
	LTE Band 5	10M	QPSK	1	0	Bottom Face	1cm	20600	844	OFF	22.28	24	1.486	-0.19	0.253	0.376
	LTE Band 5	10M	QPSK	25	0	Bottom Face	1cm	20450	829	OFF	21.26	23	1.493	-0.11	0.198	0.296
	LTE Band 5	10M	QPSK	1	0	Edge 1	1.1cm	20600	844	OFF	22.28	24	1.486	0	0.272	0.404
	LTE Band 5	10M	QPSK	25	0	Edge 1	1.1cm	20450	829	OFF	21.26	23	1.493	-0.12	0.183	0.273
	LTE Band 5	10M	QPSK	1	0	Edge 4	0cm	20600	844	OFF	22.28	24	1.486	-0.02	0.145	0.215
	LTE Band 5	10M	QPSK	25	0	Edge 4	0cm	20450	829	OFF	21.26	23	1.493	0.01	0.126	0.188
	LTE Band 5	10M	QPSK	1	0	Bottom Face	0cm	20450	829	ON	19.39	20	1.151	0.06	0.507	0.583
	LTE Band 5	10M	QPSK	25	24	Bottom Face	0cm	20450	829	ON	19.33	20	1.167	0.08	0.499	0.582
	LTE Band 5	10M	QPSK	1	0	Edge 1	0cm	20450	829	ON	19.39	20	1.151	0.11	0.698	0.803
	LTE Band 5	10M	QPSK	1	0	Edge 1	0cm	20525	836.5	ON	19.14	20	1.219	0.04	0.759	0.925
	LTE Band 5	10M	QPSK	1	0	Edge 1	0cm	20600	844	ON	19.18	20	1.208	-0.12	0.756	0.913
	LTE Band 5	10M	QPSK	25	24	Edge 1	0cm	20450	829	ON	19.33	20	1.167	0.04	0.758	0.884
11	LTE Band 5	10M	QPSK	25	24	Edge 1	0cm	20525	836.5	ON	19.01	20	1.256	-0.16	0.770	0.967
	LTE Band 5	10M	QPSK	25	24	Edge 1	0cm	20600	844	ON	19.17	20	1.211	-0.03	0.738	0.893
	LTE Band 5	10M	QPSK	50	0	Edge 1	0cm	20600	844	ON	19.19	20	1.205	0.03	0.723	0.871



FCC SAR Test Report

Report No. : FA390721

Plot No.	Band	BW (MHz)	Modulation	RB Size	RB offset	Test Position	Gap (cm)	Ch.	Freq. (MHz)	Power Back-off	Average Power (dBm)	Tune-Up Limit (dBm)	Tune-up Scaling Factor	Power Drift (dB)	Measured 1g SAR (W/kg)	Reported 1g SAR (W/kg)
	LTE Band 4	20M	QPSK	1	0	Bottom Face	1cm	20300	1745	OFF	22.63	24	1.371	-0.11	0.634	0.869
	LTE Band 4	20M	QPSK	1	0	Bottom Face	1cm	20050	1720	OFF	22.5	24	1.413	0.05	0.655	0.925
	LTE Band 4	20M	QPSK	1	0	Bottom Face	1cm	20175	1732.5	OFF	22.45	24	1.429	0.01	0.657	0.939
	LTE Band 4	20M	QPSK	50	24	Bottom Face	1cm	20050	1720	OFF	21.35	23	1.462	-0.03	0.494	0.722
	LTE Band 4	20M	QPSK	100	0	Bottom Face	1cm	20050	1720	OFF	21.35	23	1.462	-0.1	0.494	0.722
	LTE Band 4	20M	QPSK	1	0	Edge 1	1.1cm	20300	1745	OFF	22.63	24	1.371	-0.01	0.489	0.670
	LTE Band 4	20M	QPSK	50	24	Edge 1	1.1cm	20050	1720	OFF	21.35	23	1.462	0	0.350	0.512
	LTE Band 4	20M	QPSK	1	0	Edge 4	0cm	20300	1745	OFF	22.63	24	1.371	0.13	0.572	0.784
	LTE Band 4	20M	QPSK	50	24	Edge 4	0cm	20050	1720	OFF	21.35	23	1.462	0	0.425	0.621
	LTE Band 4	20M	QPSK	1	0	Bottom Face	0cm	20300	1745	ON	17.8	18	1.047	0.1	0.889	0.931
	LTE Band 4	20M	QPSK	1	0	Bottom Face	0cm	20050	1720	ON	17.71	18	1.069	-0.13	0.886	0.947
	LTE Band 4	20M	QPSK	1	0	Bottom Face	0cm	20175	1732.5	ON	17.67	18	1.079	0	0.874	0.943
	LTE Band 4	20M	QPSK	50	24	Bottom Face	0cm	20050	1720	ON	17.55	18	1.109	-0.18	0.867	0.962
	LTE Band 4	20M	QPSK	50	24	Bottom Face	0cm	20175	1732.5	ON	17.5	18	1.122	0.09	0.848	0.951
	LTE Band 4	20M	QPSK	50	24	Bottom Face	0cm	20300	1745	ON	17.46	18	1.132	0.02	0.827	0.936
	LTE Band 4	20M	QPSK	100	0	Bottom Face	0cm	20050	1720	ON	17.64	18	1.086	0.13	0.869	0.944
	LTE Band 4	20M	QPSK	1	0	Edge 1	0cm	20300	1745	ON	17.8	18	1.047	-0.03	0.922	0.965
	LTE Band 4	20M	QPSK	1	0	Edge 1	0cm	20050	1720	ON	17.71	18	1.069	-0.04	0.846	0.904
	LTE Band 4	20M	QPSK	1	0	Edge 1	0cm	20175	1732.5	ON	17.67	18	1.079	-0.02	0.857	0.925
	LTE Band 4	20M	QPSK	50	24	Edge 1	0cm	20050	1720	ON	17.55	18	1.109	-0.12	0.869	0.964
12	LTE Band 4	20M	QPSK	50	24	Edge 1	0cm	20175	1732.5	ON	17.5	18	1.122	-0.06	0.887	0.995
	LTE Band 4	20M	QPSK	50	24	Edge 1	0cm	20300	1745	ON	17.46	18	1.132	-0.18	0.864	0.978
	LTE Band 4	20M	QPSK	100	0	Edge 1	0cm	20300	1745	ON	17.64	18	1.086	0.04	0.841	0.914
	LTE Band 2	20M	QPSK	1	99	Bottom Face	1cm	19100	1900	OFF	22.84	24	1.306	0.01	0.551	0.720
	LTE Band 2	20M	QPSK	50	0	Bottom Face	1cm	19100	1900	OFF	21.53	23	1.403	-0.08	0.197	0.276
	LTE Band 2	20M	QPSK	1	99	Edge 1	1.1cm	19100	1900	OFF	22.84	24	1.306	0	0.678	0.886
	LTE Band 2	20M	QPSK	1	99	Edge 1	1.1cm	18700	1860	OFF	22.37	24	1.455	0.04	0.634	0.923
	LTE Band 2	20M	QPSK	1	99	Edge 1	1.1cm	18900	1880	OFF	22.34	24	1.466	0	0.594	0.871
	LTE Band 2	20M	QPSK	50	0	Edge 1	1.1cm	19100	1900	OFF	21.53	23	1.403	-0.02	0.225	0.316
	LTE Band 2	20M	QPSK	100	0	Edge 1	1.1cm	18700	1860	OFF	21.43	23	1.435	-0.09	0.436	0.626
	LTE Band 2	20M	QPSK	1	99	Edge 4	0cm	19100	1900	OFF	22.84	24	1.306	-0.02	0.418	0.546
	LTE Band 2	20M	QPSK	50	0	Edge 4	0cm	19100	1900	OFF	21.53	23	1.403	0.03	0.312	0.438
	LTE Band 2	20M	QPSK	1	49	Bottom Face	0cm	19100	1900	ON	17.95	18	1.012	-0.03	0.803	0.812
	LTE Band 2	20M	QPSK	1	49	Bottom Face	0cm	18700	1860	ON	17.55	18	1.109	-0.07	0.843	0.935
	LTE Band 2	20M	QPSK	1	49	Bottom Face	0cm	18900	1880	ON	17.8	18	1.047	0.01	0.794	0.831
	LTE Band 2	20M	QPSK	50	0	Bottom Face	0cm	18900	1880	ON	17.81	18	1.045	0.04	0.802	0.838
	LTE Band 2	20M	QPSK	50	0	Bottom Face	0cm	18700	1860	ON	17.59	18	1.099	0.02	0.820	0.901
	LTE Band 2	20M	QPSK	50	0	Bottom Face	0cm	19100	1900	ON	17.54	18	1.112	-0.06	0.757	0.842
	LTE Band 2	20M	QPSK	100	0	Bottom Face	0cm	19100	1900	ON	17.61	18	1.094	0.03	0.803	0.878
	LTE Band 2	20M	QPSK	1	49	Edge 1	0cm	19100	1900	ON	17.95	18	1.012	0.12	1.020	1.032
	LTE Band 2	20M	QPSK	1	49	Edge 1	0cm	18700	1860	ON	17.55	18	1.109	0.16	0.936	1.038
	LTE Band 2	20M	QPSK	1	49	Edge 1	0cm	18900	1880	ON	17.8	18	1.047	-0.09	0.955	1.000
	LTE Band 2	20M	QPSK	50	0	Edge 1	0cm	18900	1880	ON	17.81	18	1.045	-0.17	0.952	0.995
	LTE Band 2	20M	QPSK	50	0	Edge 1	0cm	18700	1860	ON	17.59	18	1.099	-0.06	0.914	1.004
	LTE Band 2	20M	QPSK	50	0	Edge 1	0cm	19100	1900	ON	17.54	18	1.112	-0.11	0.957	1.064
13	LTE Band 2	20M	QPSK	100	0	Edge 1	0cm	19100	1900	ON	17.61	18	1.094	-0.17	1.040	1.138



Plot No.	Band	BW (MHz)	Modulation	RB Size	RB offset	Test Position	Gap (cm)	Ch.	Freq. (MHz)	Power Back-off	Average Power (dBm)	Tune-Up Limit (dBm)	Tune-up Scaling Factor	Power Drift (dB)	Measured 1g SAR (W/kg)	Reported 1g SAR (W/kg)
	LTE Band 25	20M	QPSK	1	49	Bottom Face	1cm	26140	1860	OFF	22.73	24	1.340	0.06	0.506	0.678
	LTE Band 25	20M	QPSK	50	0	Bottom Face	1cm	26140	1860	OFF	21.43	23	1.435	0.01	0.374	0.537
	LTE Band 25	20M	QPSK	1	49	Edge 1	1.1cm	26140	1860	OFF	22.73	24	1.340	-0.09	0.611	0.819
	LTE Band 25	20M	QPSK	1	49	Edge 1	1.1cm	26365	1882.5	OFF	22.49	24	1.416	-0.14	0.579	0.820
	LTE Band 25	20M	QPSK	1	49	Edge 1	1.1cm	26590	1905	OFF	22.36	24	1.459	-0.09	0.572	0.834
	LTE Band 25	20M	QPSK	50	0	Edge 1	1.1cm	26140	1860	OFF	21.43	23	1.435	0.09	0.432	0.620
	LTE Band 25	20M	QPSK	100	0	Edge 1	1.1cm	26140	1860	OFF	21.41	23	1.442	-0.11	0.433	0.624
	LTE Band 25	20M	QPSK	1	49	Edge 4	0cm	26140	1860	OFF	22.73	24	1.340	-0.08	0.462	0.619
	LTE Band 25	20M	QPSK	50	0	Edge 4	0cm	26140	1860	OFF	21.43	23	1.435	0.14	0.455	0.653
	LTE Band 25	20M	QPSK	1	99	Bottom Face	0cm	26590	1905	ON	17.95	18	1.012	-0.02	0.637	0.644
	LTE Band 25	20M	QPSK	50	0	Bottom Face	0cm	26590	1905	ON	17.66	18	1.081	0.04	0.694	0.751
	LTE Band 25	20M	QPSK	1	99	Edge 1	0cm	26590	1905	ON	17.95	18	1.012	0.01	1.040	1.052
	LTE Band 25	20M	QPSK	1	99	Edge 1	0cm	26140	1860	ON	17.48	18	1.127	-0.01	0.902	1.017
	LTE Band 25	20M	QPSK	1	99	Edge 1	0cm	26365	1882.5	ON	17.49	18	1.125	-0.17	0.929	1.045
14	LTE Band 25	20M	QPSK	50	0	Edge 1	0cm	26590	1905	ON	17.66	18	1.081	-0.02	1.020	1.103
	LTE Band 25	20M	QPSK	50	0	Edge 1	0cm	26140	1860	ON	17.49	18	1.125	0.06	0.886	0.996
	LTE Band 25	20M	QPSK	50	0	Edge 1	0cm	26365	1882.5	ON	17.48	18	1.127	0.15	0.924	1.042
	LTE Band 25	20M	QPSK	100	0	Edge 1	0cm	26140	1860	ON	17.51	18	1.119	-0.11	0.865	0.968

12.2 Repeated SAR Measurement

No	Band	Mode	Test Position	Gap (cm)	Ch.	Freq. (MHz)	Power Back-off	Average Power (dBm)	Tune-Up Limit (dBm)	Tune-up Scaling Factor	Power Drift (dB)	Measured 1g SAR (W/kg)	Ratio	Reported 1g SAR (W/kg)
1st	GSM850	GPRS (2 Tx slots)	Edge 1	0cm	251	848.8	ON	26.91	27	1.021	-0.01	1.030	-	1.052
2nd	GSM850	GPRS (2 Tx slots)	Edge 1	0cm	251	848.8	ON	26.91	27	1.021	-0.03	0.999	1.03	1.020
1st	WCDMA IV	RMC12.2Kbps	Edge 1	0cm	1413	1732.6	ON	18.39	18.5	1.026	-0.1	1.110	-	1.138
2nd	WCDMA IV	RMC12.2Kbps	Edge 1	0cm	1413	1732.6	ON	18.39	18.5	1.026	-0.07	1.090	1.02	1.118
1st	CDMA BC1	RTAP 153.6Kbps	Edge 1	0cm	1175	1908.75	ON	17.92	18	1.019	-0.13	1.140	-	1.161
2nd	CDMA BC1	RTAP 153.6Kbps	Edge 1	0cm	1175	1908.75	ON	17.92	18	1.019	-0.04	1.130	1.01	1.151

Note:

- Per KDB 865664 D01v01r01, for each frequency band, repeated SAR measurement is required only when the measured SAR is $\geq 0.8W/kg$
- Per KDB 865664 D01v01r01, if the ratio among the repeated measurement is ≤ 1.2 and the measured SAR $< 1.45W/kg$, only one repeated measurement is required.
- The ratio is the largest SAR to the smallest SAR among original and repeated measurement.
- All measurement SAR result is scaled-up to account for tune-up tolerance and is compliant.

13. Simultaneous Transmission Analysis

NO.	Simultaneous Transmission Configurations	Portable Tablet	Note
		Body	
1.	GPRS/EDGE(Data) + WLAN2.4GHz(data)	Yes	2.4GHz Hotspot
2.	WCDMA(Data) + WLAN2.4GHz(data)	Yes	2.4GHz Hotspot
3.	CDMA(Data) + WLAN2.4GHz(data)	Yes	2.4GHz Hotspot
4.	LTE(Data) + WLAN2.4GHz(data)	Yes	2.4GHz Hotspot
5.	GPRS/EDGE(Data) + Bluetooth(data)	Yes	
6.	WCDMA(Data) + Bluetooth(data)	Yes	
7.	CDMA(Data) + Bluetooth(data)	Yes	
8.	LTE(Data) + Bluetooth(data)	Yes	
9.	GPRS/EDGE(data) + WLAN5GHz(data)	No	
10.	WCDMA(data) + WLAN5GHz(data)	No	
11.	CDMA(data) + WLAN5 GHz(data)	No	
12.	LTE(data) + WLAN5GHz(data)	No	

Note:

- Intel 7260NGW, Bluetooth Power and WALN SAR test data is referenced in SGS Report for FCC ID: PD97260NGU, Report No: EN/2013/80004.
- Qualcomm Atheros QCSNFA282, Bluetooth Power and WALN SAR test data is referenced in Sporton Report for FCC ID: PPD-QCSNFA282, Report No: FA383112 Rev.01.
- For simultaneous transmission analysis for exposure position of bottom face at 1cm and Edge1 at 1.1cm, WLAN SAR tested at 0mm separation testing results are used for conservative SAR summation.
- According to the section11 antenna location, the minimum distances between each antenna were used for conservative SPLSR calculation.
- For co-location analysis:
 - The WWAN SAR testing was performed on bottom face, Edge1 and Edge4, according to KDB 447498 D01v05r01 exclusion thresholds which can be referred to page59.
 - For Intel 7260NGW, WLAN SAR testing was performed on bottom face, Edge1 and Edge2, according to KDB 447498 D01v05r01 exclusion thresholds which can be referred to SGS Report for FCC ID: PD97260NGU, Report No: EN/2013/80004 page25.
 - For Qualcomm Atheros QCSNFA282, WLAN SAR testing was performed on bottom face, Edge1 and Edge2, according to KDB 447498 D01v05r01 exclusion thresholds which can be referred to Sporton Report for FCC ID: PPD-QCSNFA282, Report No: FA383112 Rev.01 page35.
 - For co-location analysis was performed at the same exposure positions, which are bottom face and Edge1, where both WWAN standalone SAR and WLAN standalone SAR was assessed.
- Per KDB 447498 D01v05r01, simultaneous transmission SAR is compliant if,
 - Scalar SAR summation < 1.6W/kg.
 - $SPLSR = (SAR_1 + SAR_2)^{1.5} / (min. separation distance, mm)$. If $SPLSR \leq 0.04$, simultaneously transmission SAR measurement is not necessary
 - Simultaneously transmission SAR measurement, and the reported multi-band SAR < 1.6W/kg
 - The SPLSR calculated results please refer to section 13.2.
- For simultaneous transmission analysis, Bluetooth SAR is estimated per KDB 447498 D01v05r01 based on the formula below.
 - $(max. power of channel, including tune-up tolerance, mW)/(min. test separation distance, mm)[\sqrt{f(GHz)/x}] W/kg$ for test separation distances ≤ 50 mm; where $x = 7.5$ for 1-g SAR, and $x = 18.75$ for 10-g SAR.
 - When the minimum separation distance is < 5mm, the distance is used 5mm to determine SAR test exclusion.
 - 0.4 W/kg for 1-g SAR and 1.0 W/kg for 10-g SAR, when the test separation distances is > 50 mm.
 - Bluetooth estimated SAR is conservatively determined by 5mm separation, for all applicable exposure positions.

Intel 7260NGW			Qualcomm Atheros QCSNFA282		
Bluetooth Max Power	Exposure Position	All Position	Bluetooth Max Power	Exposure Position	All Position
7.69 dBm	Estimated SAR (W/kg)	0.252 W/kg	8.56 dBm	Estimated SAR (W/kg)	0.294 W/kg



13.1 Body Exposure Conditions

<Colocation with PD97260NGU, WWAN + WLAN2.4GHz>

Position	WWAN		WLAN Ant 0	WLAN Ant 1	Summed SAR (W/kg)	SPLSR Results	Case No
	Band	SAR (W/kg)	SAR (W/kg)	SAR (W/kg)			
Bottom Face At 1 cm	GSM850	0.639	0.320	0.210	1.17		
	GSM1900	0.587	0.320	0.210	1.12		
	WCDMA V	0.366	0.320	0.210	0.90		
	WCDMA IV	1.124	0.320	0.210	1.65	0.03	Case1
	WCDMA II	0.711	0.320	0.210	1.24		
	CDMA BC0	0.495	0.320	0.210	1.03		
	CDMA BC10	0.487	0.320	0.210	1.02		
	CDMA BC1	0.740	0.320	0.210	1.27		
	LTE Band 17	0.244	0.320	0.210	0.77		
	LTE Band 13	0.254	0.320	0.210	0.78		
	LTE Band 5	0.376	0.320	0.210	0.91		
	LTE Band 4	0.939	0.320	0.210	1.47		
	LTE Band 2	0.720	0.320	0.210	1.25		
LTE Band 25	0.678	0.320	0.210	1.21			
Bottom Face At 0cm	GSM850	0.781	0.320	0.210	1.31		
	GSM1900	0.700	0.320	0.210	1.23		
	WCDMA V	0.448	0.320	0.210	0.98		
	WCDMA IV	1.090	0.320	0.210	1.62	0.03	Case2
	WCDMA II	0.783	0.320	0.210	1.31		
	CDMA BC0	0.705	0.320	0.210	1.24		
	CDMA BC10	0.694	0.320	0.210	1.22		
	CDMA BC1	0.744	0.320	0.210	1.27		
	LTE Band 17	0.531	0.320	0.210	1.06		
	LTE Band 13	0.518	0.320	0.210	1.05		
	LTE Band 5	0.583	0.320	0.210	1.11		
	LTE Band 4	0.962	0.320	0.210	1.49		
	LTE Band 2	0.935	0.320	0.210	1.47		
LTE Band 25	0.751	0.320	0.210	1.28			
Edge 1 At 1.1cm	GSM850	0.666	0.420		1.09		
	GSM1900	0.803	0.420		1.22		
	WCDMA V	0.351	0.420		0.77		
	WCDMA IV	0.713	0.420		1.13		
	WCDMA II	0.988	0.420		1.41		
	CDMA BC0	0.472	0.420		0.89		
	CDMA BC10	0.413	0.420		0.83		
	CDMA BC1	1.058	0.420		1.48		
	LTE Band 17	0.158	0.420		0.58		
	LTE Band 13	0.179	0.420		0.60		
	LTE Band 5	0.404	0.420		0.82		
	LTE Band 4	0.670	0.420		1.09		
	LTE Band 2	0.923	0.420		1.34		
LTE Band 25	0.834	0.420		1.25			



Position	WWAN		WLAN Ant 0	WLAN Ant 1	Summed SAR (W/kg)	SPLSR Results	Case No
	Band	SAR (W/kg)	SAR (W/kg)	SAR (W/kg)			
Edge 1 At 0cm	GSM850	1.052	0.420		1.47		
	GSM1900	1.149	0.420		1.57		
	WCDMA V	0.589	0.420		1.01		
	WCDMA IV	1.168	0.420		1.59		
	WCDMA II	1.147	0.420		1.57		
	CDMA BC0	0.945	0.420		1.37		
	CDMA BC10	0.915	0.420		1.34		
	CDMA BC1	1.161	0.420		1.58		
	LTE Band 17	0.568	0.420		0.99		
	LTE Band 13	0.782	0.420		1.20		
	LTE Band 5	0.967	0.420		1.39		
	LTE Band 4	0.995	0.420		1.42		
	LTE Band 2	1.138	0.420		1.56		
LTE Band 25	1.103	0.420		1.52			

<Colocation with PD97260NGU, WWAN + Bluetooth>

Position	WWAN		Bluetooth	Summed SAR (W/kg)	SPLSR Results	Case No
	Band	SAR (W/kg)	Estimated SAR (W/kg)			
Bottom Face At 1 cm	GSM850	0.639	0.252	0.89		
	GSM1900	0.587	0.252	0.84		
	WCDMA V	0.366	0.252	0.62		
	WCDMA IV	1.124	0.252	1.38		
	WCDMA II	0.711	0.252	0.96		
	CDMA BC0	0.495	0.252	0.75		
	CDMA BC10	0.487	0.252	0.74		
	CDMA BC1	0.740	0.252	0.99		
	LTE Band 17	0.244	0.252	0.50		
	LTE Band 13	0.254	0.252	0.51		
	LTE Band 5	0.376	0.252	0.63		
	LTE Band 4	0.939	0.252	1.19		
	LTE Band 2	0.720	0.252	0.97		
LTE Band 25	0.678	0.252	0.93			
Bottom Face At 0cm	GSM850	0.781	0.252	1.03		
	GSM1900	0.700	0.252	0.95		
	WCDMA V	0.448	0.252	0.70		
	WCDMA IV	1.090	0.252	1.34		
	WCDMA II	0.783	0.252	1.04		
	CDMA BC0	0.705	0.252	0.96		
	CDMA BC10	0.694	0.252	0.95		
	CDMA BC1	0.744	0.252	1.00		
	LTE Band 17	0.531	0.252	0.78		
	LTE Band 13	0.518	0.252	0.77		
	LTE Band 5	0.583	0.252	0.84		
	LTE Band 4	0.962	0.252	1.21		
	LTE Band 2	0.935	0.252	1.19		
LTE Band 25	0.751	0.252	1.00			



Position	WWAN		Bluetooth	Summed SAR (W/kg)	SPLSR Results	Case No
	Band	SAR (W/kg)	Estimated SAR (W/kg)			
Edge 1 At 1.1cm	GSM850	0.666	0.252	0.92		
	GSM1900	0.803	0.252	1.06		
	WCDMA V	0.351	0.252	0.60		
	WCDMA IV	0.713	0.252	0.97		
	WCDMA II	0.988	0.252	1.24		
	CDMA BC0	0.472	0.252	0.72		
	CDMA BC10	0.413	0.252	0.67		
	CDMA BC1	1.058	0.252	1.31		
	LTE Band 17	0.158	0.252	0.41		
	LTE Band 13	0.179	0.252	0.43		
	LTE Band 5	0.404	0.252	0.66		
	LTE Band 4	0.670	0.252	0.92		
	LTE Band 2	0.923	0.252	1.18		
LTE Band 25	0.834	0.252	1.09			
Edge 1 At 0cm	GSM850	1.052	0.252	1.30		
	GSM1900	1.149	0.252	1.40		
	WCDMA V	0.589	0.252	0.84		
	WCDMA IV	1.168	0.252	1.42		
	WCDMA II	1.147	0.252	1.40		
	CDMA BC0	0.945	0.252	1.20		
	CDMA BC10	0.915	0.252	1.17		
	CDMA BC1	1.161	0.252	1.41		
	LTE Band 17	0.568	0.252	0.82		
	LTE Band 13	0.782	0.252	1.03		
	LTE Band 5	0.967	0.252	1.22		
	LTE Band 4	0.995	0.252	1.25		
	LTE Band 2	1.138	0.252	1.39		
LTE Band 25	1.103	0.252	1.36			
Edge 4 At 0cm	GSM850	0.405	0.252	0.66		
	GSM1900	0.515	0.252	0.77		
	WCDMA V	0.206	0.252	0.46		
	WCDMA IV	1.010	0.252	1.26		
	WCDMA II	0.635	0.252	0.89		
	CDMA BC0	0.237	0.252	0.49		
	CDMA BC10	0.126	0.252	0.38		
	CDMA BC1	0.676	0.252	0.93		
	LTE Band 17	0.134	0.252	0.39		
	LTE Band 13	0.176	0.252	0.43		
	LTE Band 5	0.215	0.252	0.47		
	LTE Band 4	0.784	0.252	1.04		
	LTE Band 2	0.546	0.252	0.80		
LTE Band 25	0.653	0.252	0.91			



< Colocation with PPD-QCSNFA282, WWAN + WLAN2.4GHz >

Position	WWAN		WLAN Ant 0	WLAN Ant 1	Summed SAR (W/kg)	SPLSR Results	Case No
	Band	SAR (W/kg)	SAR (W/kg)	SAR (W/kg)			
Bottom Face At 1 cm	GSM850	0.639	0.366	0.289	1.29		
	GSM1900	0.587	0.366	0.289	1.24		
	WCDMA V	0.366	0.366	0.289	1.02		
	WCDMA IV	1.124	0.366	0.289	1.78	0.03	Case 3
	WCDMA II	0.711	0.366	0.289	1.37		
	CDMA BC0	0.495	0.366	0.289	1.15		
	CDMA BC10	0.487	0.366	0.289	1.14		
	CDMA BC1	0.740	0.366	0.289	1.40		
	LTE Band 17	0.244	0.366	0.289	0.90		
	LTE Band 13	0.254	0.366	0.289	0.91		
	LTE Band 5	0.376	0.366	0.289	1.03		
	LTE Band 4	0.939	0.366	0.289	1.59		
LTE Band 2	0.720	0.366	0.289	1.38			
LTE Band 25	0.678	0.366	0.289	1.33			
Bottom Face At 0cm	GSM850	0.781	0.366	0.289	1.44		
	GSM1900	0.700	0.366	0.289	1.36		
	WCDMA V	0.448	0.366	0.289	1.10		
	WCDMA IV	1.090	0.366	0.289	1.75	0.03	Case 4
	WCDMA II	0.783	0.366	0.289	1.44		
	CDMA BC0	0.705	0.366	0.289	1.36		
	CDMA BC10	0.694	0.366	0.289	1.35		
	CDMA BC1	0.744	0.366	0.289	1.40		
	LTE Band 17	0.531	0.366	0.289	1.19		
	LTE Band 13	0.518	0.366	0.289	1.17		
	LTE Band 5	0.583	0.366	0.289	1.24		
	LTE Band 4	0.962	0.366	0.289	1.62	0.02	Case 5
LTE Band 2	0.935	0.366	0.289	1.59			
LTE Band 25	0.751	0.366	0.289	1.41			
Edge1 At 1.1cm	GSM850	0.666	0.507		1.17		
	GSM1900	0.803	0.507		1.31		
	WCDMA V	0.351	0.507		0.86		
	WCDMA IV	0.713	0.507		1.22		
	WCDMA II	0.988	0.507		1.50		
	CDMA BC0	0.472	0.507		0.98		
	CDMA BC10	0.413	0.507		0.92		
	CDMA BC1	1.058	0.507		1.57		
	LTE Band 17	0.158	0.507		0.67		
	LTE Band 13	0.179	0.507		0.69		
	LTE Band 5	0.404	0.507		0.91		
	LTE Band 4	0.670	0.507		1.18		
LTE Band 2	0.923	0.507		1.43			
LTE Band 25	0.834	0.507		1.34			



Position	WWAN		WLAN Ant 0	WLAN Ant 1	Summed SAR (W/kg)	SPLSR Results	Case No
	Band	SAR (W/kg)	SAR (W/kg)	SAR (W/kg)			
Edge1 At 0cm	GSM850	1.052	0.507		1.56		
	GSM1900	1.149	0.507		1.66	0.03	Case 6
	WCDMA V	0.589	0.507		1.10		
	WCDMA IV	1.168	0.507		1.68	0.03	Case 7
	WCDMA II	1.147	0.507		1.65	0.03	Case 8
	CDMA BC0	0.945	0.507		1.45		
	CDMA BC10	0.915	0.507		1.42		
	CDMA BC1	1.161	0.507		1.67	0.03	Case 9
	LTE Band 17	0.568	0.507		1.08		
	LTE Band 13	0.782	0.507		1.29		
	LTE Band 5	0.967	0.507		1.47		
	LTE Band 4	0.995	0.507		1.50		
	LTE Band 2	1.138	0.507		1.65	0.03	Case 10
LTE Band 25	1.103	0.507		1.61	0.03	Case 11	

<Colocation with PPD-QCSNFA282, WWAN + Bluetooth>

Position	WWAN		Bluetooth	Summed SAR (W/kg)	SPLSR Results	Case No
	Band	SAR (W/kg)	Estimated SAR (W/kg)			
Bottom Face At 1 cm	GSM850	0.639	0.294	0.93		
	GSM1900	0.587	0.294	0.88		
	WCDMA V	0.366	0.294	0.66		
	WCDMA IV	1.124	0.294	1.42		
	WCDMA II	0.711	0.294	1.01		
	CDMA BC0	0.495	0.294	0.79		
	CDMA BC10	0.487	0.294	0.78		
	CDMA BC1	0.740	0.294	1.03		
	LTE Band 17	0.244	0.294	0.54		
	LTE Band 13	0.254	0.294	0.55		
	LTE Band 5	0.376	0.294	0.67		
	LTE Band 4	0.939	0.294	1.23		
	LTE Band 2	0.720	0.294	1.01		
LTE Band 25	0.678	0.294	0.97			
Bottom Face At 0cm	GSM850	0.781	0.294	1.08		
	GSM1900	0.700	0.294	0.99		
	WCDMA V	0.448	0.294	0.74		
	WCDMA IV	1.090	0.294	1.38		
	WCDMA II	0.783	0.294	1.08		
	CDMA BC0	0.705	0.294	1.00		
	CDMA BC10	0.694	0.294	0.99		
	CDMA BC1	0.744	0.294	1.04		
	LTE Band 17	0.531	0.294	0.83		
	LTE Band 13	0.518	0.294	0.81		
	LTE Band 5	0.583	0.294	0.88		
	LTE Band 4	0.962	0.294	1.26		
	LTE Band 2	0.935	0.294	1.23		
LTE Band 25	0.751	0.294	1.05			



FCC SAR Test Report

Report No. : FA390721

Position	WWAN		Bluetooth	Summed SAR (W/kg)	SPLSR Results	Case No
	Band	SAR (W/kg)	Estimated SAR (W/kg)			
Edge1 At 1.1cm	GSM850	0.666	0.294	0.96		
	GSM1900	0.803	0.294	1.10		
	WCDMA V	0.351	0.294	0.65		
	WCDMA IV	0.713	0.294	1.01		
	WCDMA II	0.988	0.294	1.28		
	CDMA BC0	0.472	0.294	0.77		
	CDMA BC10	0.413	0.294	0.71		
	CDMA BC1	1.058	0.294	1.35		
	LTE Band 17	0.158	0.294	0.45		
	LTE Band 13	0.179	0.294	0.47		
	LTE Band 5	0.404	0.294	0.70		
	LTE Band 4	0.670	0.294	0.96		
	LTE Band 2	0.923	0.294	1.22		
	LTE Band 25	0.834	0.294	1.13		
Edge1 At 0cm	GSM850	1.052	0.294	1.35		
	GSM1900	1.149	0.294	1.44		
	WCDMA V	0.589	0.294	0.88		
	WCDMA IV	1.168	0.294	1.46		
	WCDMA II	1.147	0.294	1.44		
	CDMA BC0	0.945	0.294	1.24		
	CDMA BC10	0.915	0.294	1.21		
	CDMA BC1	1.161	0.294	1.46		
	LTE Band 17	0.568	0.294	0.86		
	LTE Band 13	0.782	0.294	1.08		
	LTE Band 5	0.967	0.294	1.26		
	LTE Band 4	0.995	0.294	1.29		
	LTE Band 2	1.138	0.294	1.43		
	LTE Band 25	1.103	0.294	1.40		
Edge 4 At 0cm	GSM850	0.405	0.294	0.70		
	GSM1900	0.515	0.294	0.81		
	WCDMA V	0.206	0.294	0.50		
	WCDMA IV	1.010	0.294	1.30		
	WCDMA II	0.635	0.294	0.93		
	CDMA BC0	0.237	0.294	0.53		
	CDMA BC10	0.126	0.294	0.42		
	CDMA BC1	0.676	0.294	0.97		
	LTE Band 17	0.134	0.294	0.43		
	LTE Band 13	0.176	0.294	0.47		
	LTE Band 5	0.215	0.294	0.51		
	LTE Band 4	0.784	0.294	1.08		
	LTE Band 2	0.546	0.294	0.84		
	LTE Band 25	0.653	0.294	0.95		

13.2 SPLSR Evaluation and Analysis

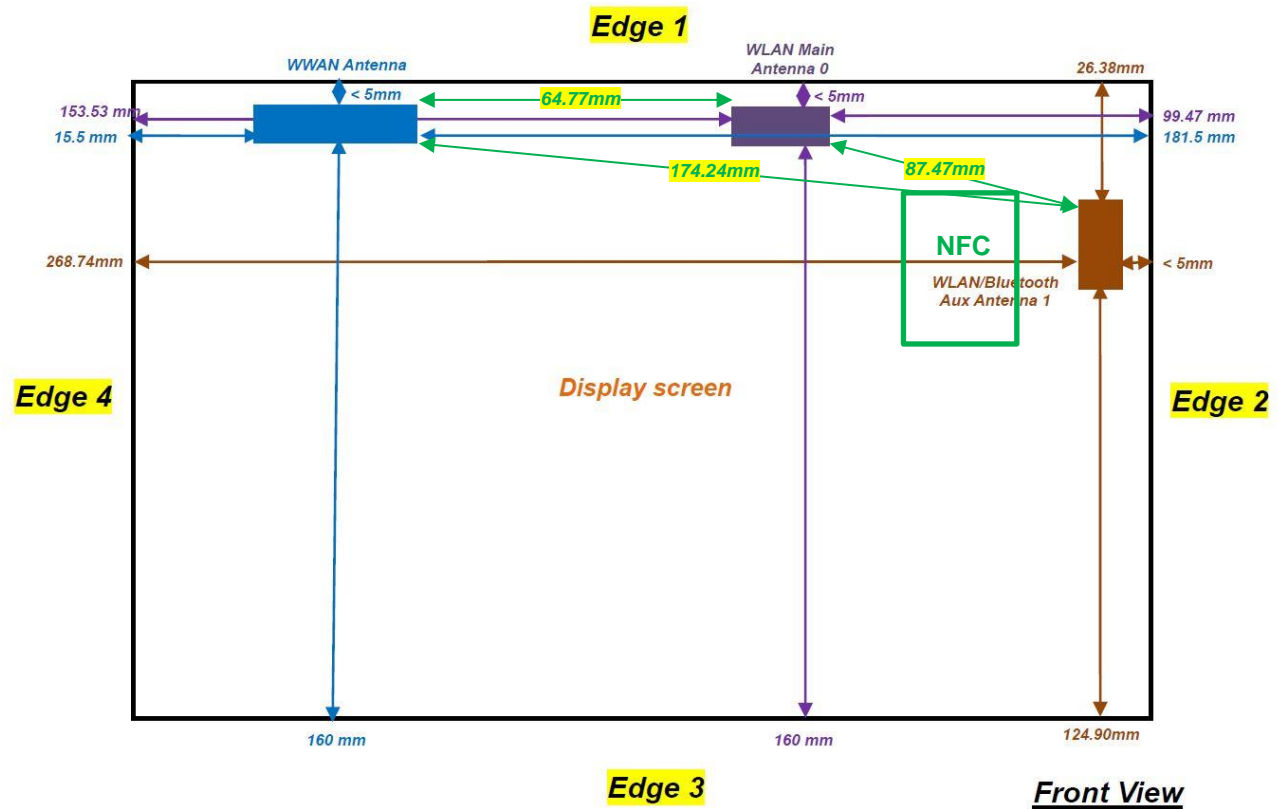

Note:

1. Either WLAN/Bluetooth module of FCC ID: PD97260NGU or WLAN/Bluetooth module of FCC ID: PPD-QCSNFA282 would be integrated into this host, and the identical WLAN antenna is used for either one module integration
2. For SPLSR analysis of colocation with PD97260NGU, the minimum distances between each antenna pair was used for conservative SPLSR calculation. This is justified to compare the SAR peak separation in SPLSR analysis case 1 and 2 with SPLSR analysis case 3 and 4
3. $SPLSR = (SAR_1 + SAR_2)^{1.5} / (\text{min. separation distance, mm})$. If $SPLSR \leq 0.04$, simultaneously transmission SAR measurement is not necessary

Case 1	Position	Band	SAR (W/kg)	Gap	Minimum Distance (mm)	Pair SAR sum (W/kg)	SPLSR Calculated	Simultaneous SAR
				(cm)				
Bottom Face	WCDMA IV	1.124	1	64.77	1.44	0.03	Not required	
		WLAN2.4GHz(Ant 0)	0.320					0
	WCDMA IV	1.124	1	174.24	1.33	0.01		
		WLAN2.4GHz(Ant 1)	0.210					0
	WLAN2.4GHz(Ant 0)	0.320	0	87.47	0.53	0.00		
		WLAN2.4GHz(Ant 1)	0.210					0

Case 2	Position	Band	SAR (W/kg)	Gap	Minimum Distance (mm)	Pair SAR sum (W/kg)	SPLSR Calculated	Simultaneous SAR
				(cm)				
Bottom Face	WCDMA IV	1.090	0	64.77	1.41	0.03	Not required	
		WLAN2.4GHz(Ant 0)	0.320					0
	WCDMA IV	1.090	0	174.24	1.30	0.01		
		WLAN2.4GHz(Ant 1)	0.210					0
	WLAN2.4GHz(Ant 0)	0.320	0	87.47	0.53	0.00		
		WLAN2.4GHz(Ant 1)	0.210					0

Case 3	Position	Band	SAR (W/kg)	Gap (cm)	SAR peak location (m)			3D distance (mm)	Pair SAR sum (W/kg)	SPLSR Calculated	Simultaneous SAR
					X	Y	Z				
Bottom Face	WCDMA IV	1.124	1	0.079	-0.0845	-0.18	108.5	1.49	0.02	Not required	
		WLAN2.4GHz(Ant 0)	0.366	0	0.0781	0.024					-0.177
	WCDMA IV	1.124	1	0.079	-0.0845	-0.18	207.4	1.41	0.01		
		WLAN2.4GHz(Ant 1)	0.289	0	0.03	0.117					-0.178
	WLAN2.4GHz(Ant 0)	0.366	0	0.0781	0.024	-0.177	104.7	0.66	0.01		
		WLAN2.4GHz(Ant 1)	0.289	0	0.03	0.117					-0.178

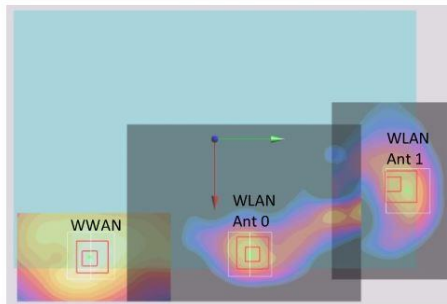

Case 4	Position	Band	SAR (W/kg)	Gap (cm)	SAR peak location (m)			3D distance (mm)	Pair SAR sum (W/kg)	SPLSR Calculated	Simultaneous SAR
					X	Y	Z				
Bottom Face	WCDMA IV	WCDMA IV	1.090	0	0.0855	-0.0955	-0.182	119.8	1.46	0.01	Not required
		WLAN2.4GHz(Ant 0)	0.366	0	0.0781	0.024	-0.177				
	WCDMA IV	WCDMA IV	1.090	0	0.0855	-0.0955	-0.182	219.7	1.38	0.01	Not required
		WLAN2.4GHz(Ant 1)	0.289	0	0.03	0.117	-0.178				
	WLAN2.4GHz(Ant 0)	WLAN2.4GHz(Ant 0)	0.366	0	0.0781	0.024	-0.177	104.7	0.66	0.01	Not required
		WLAN2.4GHz(Ant 1)	0.289	0	0.03	0.117	-0.178				

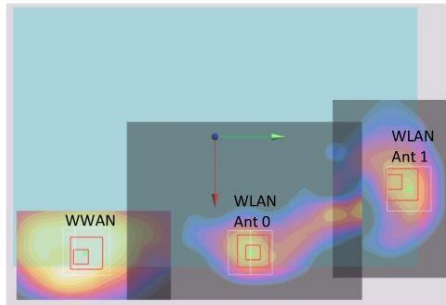

Case 5	Position	Band	SAR (W/kg)	Gap (cm)	SAR peak location (m)			3D distance (mm)	Pair SAR sum (W/kg)	SPLSR Calculated	Simultaneous SAR
					X	Y	Z				
Bottom Face	LTE Band 4	LTE Band 4	0.962	0	0.081	-0.089	-0.179	113.1	1.33	0.01	Not required
		WLAN2.4GHz(Ant 0)	0.366	0	0.0781	0.024	-0.177				
	LTE Band 4	LTE Band 4	0.962	0	0.081	-0.089	-0.179	212.2	1.25	0.01	Not required
		WLAN2.4GHz(Ant 1)	0.289	0	0.03	0.117	-0.178				
	WLAN2.4GHz(Ant 0)	WLAN2.4GHz(Ant 0)	0.366	0	0.0781	0.024	-0.177	104.7	0.66	0.01	Not required
		WLAN2.4GHz(Ant 1)	0.289	0	0.03	0.117	-0.178				

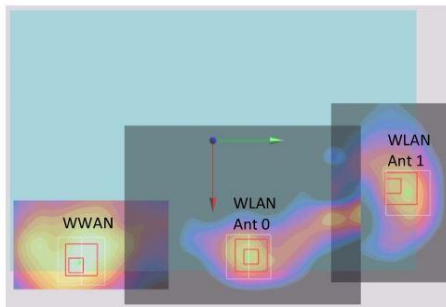

Case 6	Position	Band	SAR (W/kg)	Gap (cm)	SAR peak location (m)			3D distance (mm)	Pair SAR sum (W/kg)	SPLSR Calculated	Simultaneous SAR
					X	Y	Z				
Edge 1		GSM1900	1.149	0	0.002	-0.097	-0.182	126.1	1.66	0.02	Not required
		WLAN2.4GHz(Ant 0)	0.507	0	-0.000941	0.029	-0.178				

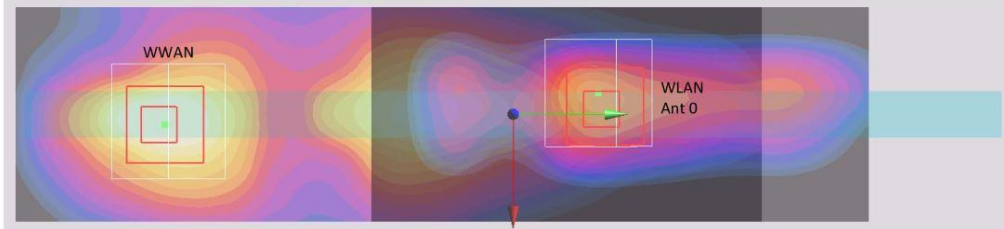

Case 7	Position	Band	SAR (W/kg)	Gap (cm)	SAR peak location (m)			3D distance (mm)	Pair SAR sum (W/kg)	SPLSR Calculated	Simultaneous SAR
					X	Y	Z				
Edge 1		WCDMA IV	1.168	0	0.002	-0.106	-0.183	135.1	1.68	0.02	Not required
		WLAN2.4GHz(Ant 0)	0.507	0	-0.000941	0.029	-0.178				

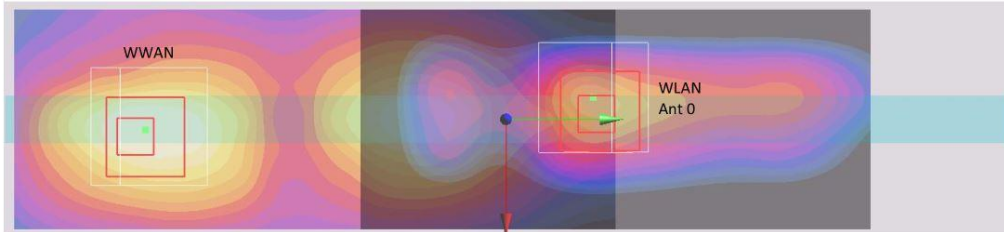

Case 8	Position	Band	SAR (W/kg)	Gap (cm)	SAR peak location (m)			3D distance (mm)	Pair SAR sum (W/kg)	SPLSR Calculated	Simultaneous SAR
					X	Y	Z				
Edge 1		WCDMA II	1.147	0	-0.001	-0.103	-0.181	132.0	1.65	0.02	Not required
		WLAN2.4GHz(Ant 0)	0.507	0	-0.000941	0.029	-0.178				

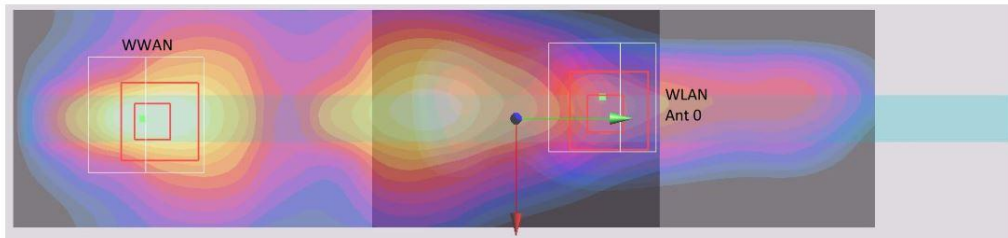

Case 9	Position	Band	SAR (W/kg)	Gap (cm)	SAR peak location (m)			3D distance (mm)	Pair SAR sum (W/kg)	SPLSR Calculated	Simultaneous SAR
					X	Y	Z				
Edge 1		CDMA BC1	1.161	0	0.002	-0.098	-0.183	127.1	1.67	0.02	Not required
		WLAN2.4GHz(Ant 0)	0.507	0	-0.000941	0.029	-0.178				

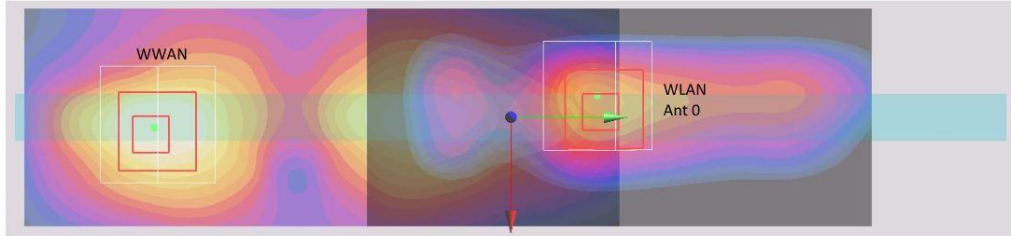

Case 10	Position	Band	SAR (W/kg)	Gap (cm)	SAR peak location (m)			3D distance (mm)	Pair SAR sum (W/kg)	SPLSR Calculated	Simultaneous SAR
					X	Y	Z				
Edge 1		LTE Band 2	1.138	0	0.002	-0.0955	-0.183	124.6	1.65	0.02	Not required
		WLAN2.4GHz(Ant 0)	0.507	0	-0.000941	0.029	-0.178				

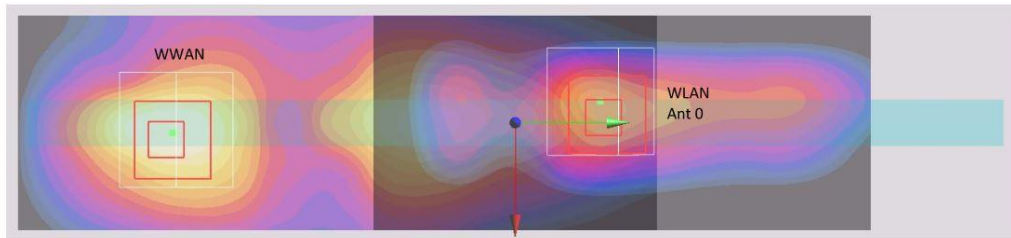

Case 11	Position	Band	SAR (W/kg)	Gap (cm)	SAR peak location (m)			3D distance (mm)	Pair SAR sum (W/kg)	SPLSR Calculated	Simultaneous SAR
					X	Y	Z				
Edge 1		LTE Band 25	1.103	0	0.0005	-0.102	-0.18	131.0	1.61	0.02	Not required
		WLAN2.4GHz(Ant 0)	0.507	0	-0.000941	0.029	-0.178				

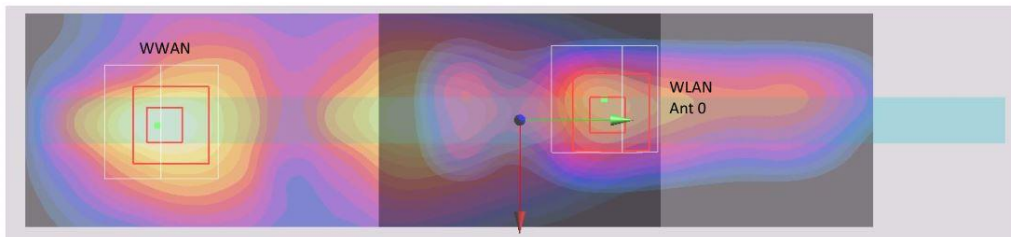

Test Engineer : Aaron Chen, Nick Yu, Frank Wu, Bevis Chang, Angelo Chang, Tom Jiang, Ken Lin and Galen Zhang

14. Uncertainty Assessment

The component of uncertainty may generally be categorized according to the methods used to evaluate them. The evaluation of uncertainty by the statistical analysis of a series of observations is termed a Type A evaluation of uncertainty. The evaluation of uncertainty by means other than the statistical analysis of a series of observation is termed a Type B evaluation of uncertainty. Each component of uncertainty, however evaluated, is represented by an estimated standard deviation, termed standard uncertainty, which is determined by the positive square root of the estimated variance.

A Type A evaluation of standard uncertainty may be based on any valid statistical method for treating data. This includes calculating the standard deviation of the mean of a series of independent observations; using the method of least squares to fit a curve to the data in order to estimate the parameter of the curve and their standard deviations; or carrying out an analysis of variance in order to identify and quantify random effects in certain kinds of measurement.

A type B evaluation of standard uncertainty is typically based on scientific judgment using all of the relevant information available. These may include previous measurement data, experience, and knowledge of the behavior and properties of relevant materials and instruments, manufacture’s specification, data provided in calibration reports and uncertainties assigned to reference data taken from handbooks. Broadly speaking, the uncertainty is either obtained from an outdoor source or obtained from an assumed distribution, such as the normal distribution, rectangular or triangular distributions indicated in Table 14.1

Uncertainty Distributions	Normal	Rectangular	Triangular	U-Shape
Multi-plying Factor ^(a)	1/k ^(b)	1/√3	1/√6	1/√2

(a) standard uncertainty is determined as the product of the multiplying factor and the estimated range of variations in the measured quantity

(b) κ is the coverage factor

Table 14.1. Standard Uncertainty for Assumed Distribution

The combined standard uncertainty of the measurement result represents the estimated standard deviation of the result. It is obtained by combining the individual standard uncertainties of both Type A and Type B evaluation using the usual “root-sum-squares” (RSS) methods of combining standard deviations by taking the positive square root of the estimated variances.

Expanded uncertainty is a measure of uncertainty that defines an interval about the measurement result within which the measured value is confidently believed to lie. It is obtained by multiplying the combined standard uncertainty by a coverage factor. Typically, the coverage factor ranges from 2 to 3. Using a coverage factor allows the true value of a measured quantity to be specified with a defined probability within the specified uncertainty range. For purpose of this document, a coverage factor two is used, which corresponds to confidence interval of about 95 %. The DASY uncertainty Budget is shown in the following tables.



Error Description	Uncertainty Value (±%)	Probability Distribution	Divisor	Ci (1g)	Ci (10g)	Standard Uncertainty (1g)	Standard Uncertainty (10g)
Measurement System							
Probe Calibration	6.0	Normal	1	1	1	± 6.0 %	± 6.0 %
Axial Isotropy	4.7	Rectangular	√3	0.7	0.7	± 1.9 %	± 1.9 %
Hemispherical Isotropy	9.6	Rectangular	√3	0.7	0.7	± 3.9 %	± 3.9 %
Boundary Effects	1.0	Rectangular	√3	1	1	± 0.6 %	± 0.6 %
Linearity	4.7	Rectangular	√3	1	1	± 2.7 %	± 2.7 %
System Detection Limits	1.0	Rectangular	√3	1	1	± 0.6 %	± 0.6 %
Readout Electronics	0.3	Normal	1	1	1	± 0.3 %	± 0.3 %
Response Time	0.8	Rectangular	√3	1	1	± 0.5 %	± 0.5 %
Integration Time	2.6	Rectangular	√3	1	1	± 1.5 %	± 1.5 %
RF Ambient Noise	3.0	Rectangular	√3	1	1	± 1.7 %	± 1.7 %
RF Ambient Reflections	3.0	Rectangular	√3	1	1	± 1.7 %	± 1.7 %
Probe Positioner	0.4	Rectangular	√3	1	1	± 0.2 %	± 0.2 %
Probe Positioning	2.9	Rectangular	√3	1	1	± 1.7 %	± 1.7 %
Max. SAR Eval.	1.0	Rectangular	√3	1	1	± 0.6 %	± 0.6 %
Test Sample Related							
Device Positioning	2.9	Normal	1	1	1	± 2.9 %	± 2.9 %
Device Holder	3.6	Normal	1	1	1	± 3.6 %	± 3.6 %
Power Drift	5.0	Rectangular	√3	1	1	± 2.9 %	± 2.9 %
Phantom and Setup							
Phantom Uncertainty	4.0	Rectangular	√3	1	1	± 2.3 %	± 2.3 %
Liquid Conductivity (Target)	5.0	Rectangular	√3	0.64	0.43	± 1.8 %	± 1.2 %
Liquid Conductivity (Meas.)	2.5	Normal	1	0.64	0.43	± 1.6 %	± 1.1 %
Liquid Permittivity (Target)	5.0	Rectangular	√3	0.6	0.49	± 1.7 %	± 1.4 %
Liquid Permittivity (Meas.)	2.5	Normal	1	0.6	0.49	± 1.5 %	± 1.2 %
Combined Standard Uncertainty						± 11.0 %	± 10.8 %
Coverage Factor for 95 %						K=2	
Expanded Uncertainty						± 22.0 %	± 21.5 %

Table 14.2. Uncertainty Budget for frequency range 300 MHz to 3 GHz



15. References

- [1] FCC 47 CFR Part 2 "Frequency Allocations and Radio Treaty Matters; General Rules and Regulations"
- [2] ANSI/IEEE Std. C95.1-1992, "IEEE Standard for Safety Levels with Respect to Human Exposure to Radio Frequency Electromagnetic Fields, 3 kHz to 300 GHz", September 1992
- [3] IEEE Std. 1528-2003, "Recommended Practice for Determining the Peak Spatial-Average Specific Absorption Rate (SAR) in the Human Head from Wireless Communications Devices: Measurement Techniques", December 2003
- [4] SPEAG DASY System Handbook
- [5] FCC KDB 447498 D01 v05r01, "Mobile and Portable Device RF Exposure Procedures and Equipment Authorization Policies", May 2013.
- [6] FCC KDB 941225 D03 v01, "Recommended SAR Test Reduction Procedures for GSM / GPRS / EDGE", December 2008
- [7] FCC KDB 941225 D05 v02r02, "SAR Evaluation Considerations for LTE Devices", May 2013
- [8] FCC KDB 941225 D01 v02, "SAR Measurement Procedures for 3G Devices – CDMA 2000 / Ev-Do / WCDMA / HSDPA / HSPA", October 2007
- [9] FCC KDB 941225 D02 v02r02, "SAR Guidance for HSPA, HSPA+, DC-HSDPA and 1x-Advanced", May 2013.
- [10] FCC KDB 616217 D04 v01r01, "SAR Evaluation Considerations for Laptop, Notebook, Netbook and Tablet Computers", May 2013
- [11] FCC KDB 865664 D01 v01r01, "SAR Measurement Requirements for 100 MHz to 6 GHz", May 2013.