

FCC Test Report

Product Name : Module
Trade Name : AirPrime
Model No. : AR7592
FCC ID. : N7NAR7592
IC ID. : 2417C-AR7592

Applicant : Sierra Wireless Inc.

Address : 13811 Wireless Way, Richmond, BC, V6V 3A4 Canada

Date of Receipt : Nov. 09, 2016
Issued Date : Dec. 15, 2016
Report No. : 16B0260R-HPUSP45V00
Report Version : V5.0



The test results relate only to the samples tested.

The test report shall not be reproduced except in full without the written approval of DEKRA Testing and Certification Co., Ltd..

Test Report Certification

Issued Date : Dec. 15, 2016

Report No. :16B0260R-HPUSP45V00



Product Name : Module

Applicant : Sierra Wireless Inc.

Address : 13811 Wireless Way, Richmond, BC, V6V 3A4 Canada

Manufacturer : Sierra Wireless Inc.

Model No. : AR7592

FCC ID. : N7NAR7592

IC ID. : 2417C-AR7592

EUT Voltage : DC 3.7V

Testing Voltage : DC 3.7V

Trade Name : AirPrime

Applicable Standard : FCC CFR Title 47 Part 2
 FCC CFR Title 47 Part 27 Subpart M
 ANSI/TIA-603-D-2010
 RSS Gen issue 4
 RSS 139 issue 3

Test Lab : Hsin Chu Laboratory

Test Result : Complied

The test results relate only to the samples tested.

The test report shall not be reproduced except in full without the written approval of DEKRA Testing and Certification Co., Ltd..

Documented By : Lyla Yang
 (Lyla Yang / Engineering Adm. Assistant)

Tested By : JuBo Shen
 (JuBo Shen / Senior Engineer)

Approved By : Roy Wang
 (Roy Wang / Director)

Revision History

Report No.	Version	Description	Issued Date
16B0260R-HPUSP45V00	V5.0	Initial issue of report.	Dec. 15, 2016

Laboratory Information

We, **DEKRA Testing and Certification Co., Ltd.**, are an independent RF consultancy that was established the whole facility in our laboratories. The test facility has been accredited/ accepted (audited or listed) by the following related bodies in compliance with ISO 17025 specified testing scopes:

Taiwan R.O.C. : TAF, Accreditation Number: 3024

USA : FCC, Registration Number: 834100

Canada : IC, Submission No: 181665 / IC Registration Number: 4075C-4

The related certificate for our laboratories about the test site and management system can be downloaded from DEKRA Testing and Certification Co., Ltd. Web Site:

<http://www.dekra.com.tw/english/about/certificates.aspx?bval=5>

The address and introduction of DEKRA Testing and Certification Co., Ltd. laboratories can be founded in our Web site : http://www.dekra.com.tw/index_en.aspx

If you have any comments, Please don't hesitate to contact us. Our contact information is as below:

Hsin Chu Laboratory :

No. 75-2, 3rd Lin, WangYe Keng, Yonghxing Tsuen, Qionglin Shiang, Hsinchu County 307, Taiwan (R.O.C.)

TEL:+886-3-592-8858 / FAX:+886-3-592-8859 E-Mail : info.tw@dekra.com

No.372, Sec. 4, Zhongxing Rd., Zhudong Township, Hsinchu County 310, Taiwan

No.372-2, Sec. 4, Zhongxing Rd., Zhudong Township, Hsinchu County 310, Taiwan

TEL:+886-3-582-8001 / FAX:+886-3- 582 8958 E-Mail : info.tw@dekra.com

Lin Kou Laboratory :

No. 5-22, Ruishukeng, Linkou Dist., New Taipei City 24451, Taiwan (R.O.C.)

TEL : +886-2-8601-3788 / FAX : +886-2-8601-3789 E-Mail : info.tw@dekra.com

TABLE OF CONTENTS

Description	Page
1. General Information	7
1.1. EUT Description	7
1.2. Test Mode.....	8
1.3. Tested System Details.....	9
1.4. Configuration of tested System	10
1.5. EUT Exercise Software	10
2. Technical Test.....	11
2.1. Summary of Test Result	11
2.2. Test Environment	11
3. Peak Output Power	12
3.1. Test Equipment	12
3.2. Test Setup	12
3.3. Limits.....	14
3.4. Test Procedure	14
3.5. Uncertainty	14
3.6. Test Result	15
4. Occupied Bandwidth.....	18
4.1. Test Equipment	18
4.2. Test Setup	18
4.3. Limits.....	18
4.4. Test Procedure	18
4.5. Uncertainty	18
4.6. Test Result	19
5. Band Edge	23
5.1. Test Equipment	23
5.2. Test Setup	23
5.3. Limits.....	23
5.4. Test Procedure	24
5.5. Uncertainty	24
5.6. Test Result	25
6. Conducted Spurious Emission.....	26
6.1. Test Equipment	26
6.2. Test Setup	26
6.3. Limits.....	27
6.4. Test Procedure	27
6.5. Uncertainty	27
6.6. Test Result	28
7. Radiated Spurious Emission.....	30
7.1. Test Equipment	30
7.2. Test Setup	30

7.3.	Limits	31
7.4.	Test Procedure	32
7.5.	Uncertainty	32
7.6.	Test Result	33
8.	Frequency Stability Over Temperatures Variation	49
8.1.	Test Equipment	49
8.2.	Test Setup	49
8.3.	Limits	49
8.4.	Test Procedure	49
8.5.	Uncertainty	49
8.6.	Test Result	50
9.	Frequency Stability Over Voltage Variation	52
9.1.	Test Equipment	52
9.2.	Test Setup	52
9.3.	Limits	52
9.4.	Test Procedure	53
9.5.	Uncertainty	53
9.6.	Test Result	54
Attachment 1	55
	Test Setup Photograph.....	55
Attachment 2	59
	EUT Photograph.....	59

1. General Information

1.1. EUT Description

Product Name	Module
Model No.	AR7592
Trade Name	AirPrime
Tx Frequency Range/Channel number	WCDMA Band 4: 1712.4-1752.6 MHz
Rx Frequency Range/Channel number	WCDMA Band 4: 2112.4-2152.6 MHz
Type of Modulation	WCDMA: QPSK (Uplink); HSDPA: QPSK (Uplink)
HW Version	1.0
SW Version	SWI9X40A_01.02.02.00

Antenna Information	
Antenna Gain	2dBi
Antenna Type	Dipole

Note: This Module included GSM 850, DCS 1900, WCDMA Band 2, WCDMA Band 4 and WCDMA Band 5 transmitting and receiving function.

1.2. Test Mode

DEKRA has verified the construction and function in typical operation. The preliminary tests were performed in different data rate, and to find the worst condition, which was shown in this test report. The following table is the final test mode.

Pre-Test Mode	
EMI	Mode 1: WCDMA Band 4_Link mode Mode 2: WCDMA Band 4_Idle mode
Final Test Model	
TX	Mode 1: WCDMA Band 4_Link mode Mode 2: WCDMA Band 4_Idle mode

1.3. Tested System Details

The types for all equipments, plus descriptions of all cables used in the tested system (including inserted cards) are:

Product	Manufacturer	Model No.	Serial No.	FCC ID	Power Cord
1 Horn Antenna	Schwarzbeck	BBHA9120	D639	DoC	--
2 Base Station Simulator	Japan radio	NJZ-2000	ET00477	DoC	--

1.4. Configuration of tested System

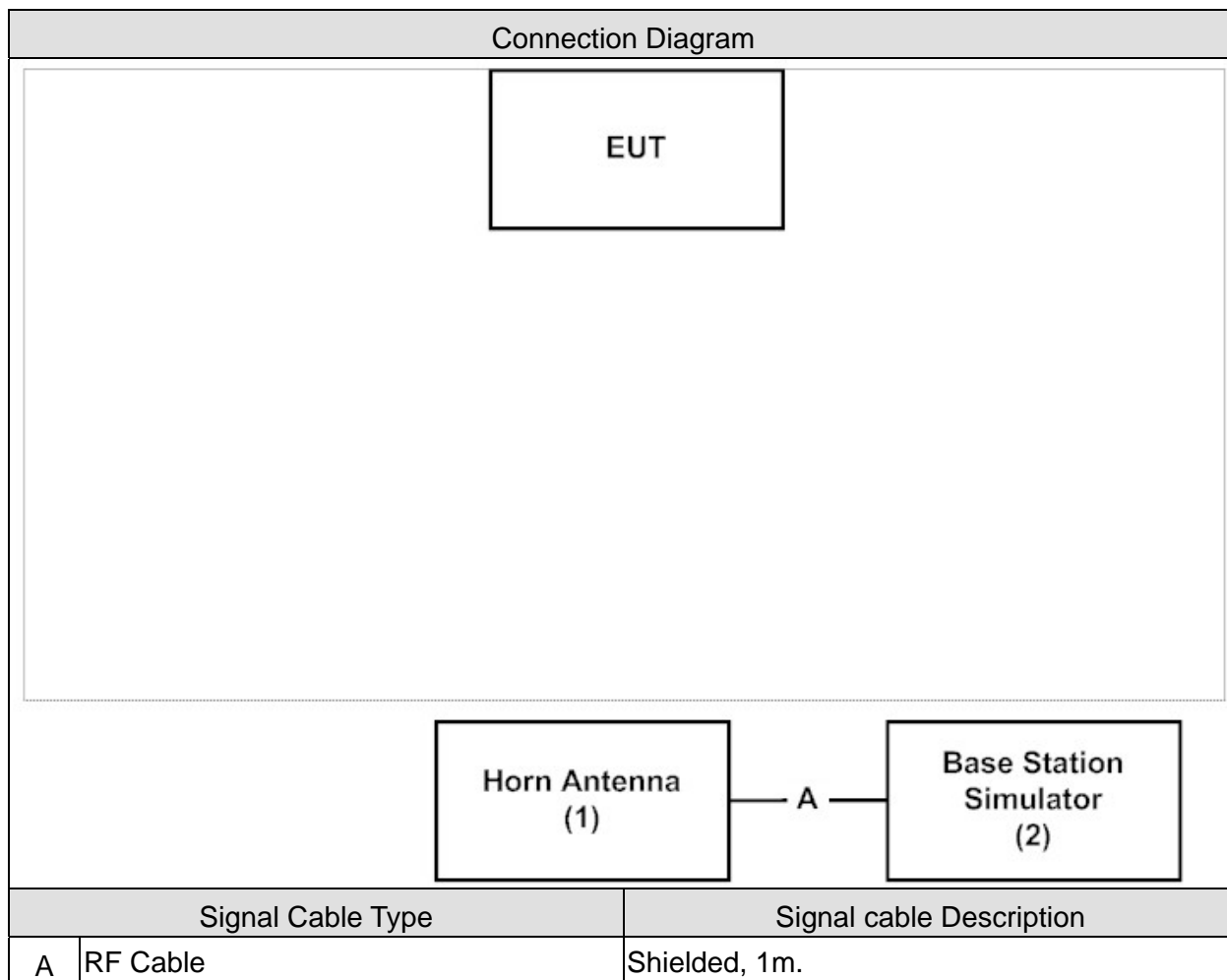

1.5. EUT Exercise Software

1	Setup the EUT as shown in section 1.4.
2	Turn on the EUT power.
3	The EUT will continue transmit through base station simulator
4	Repeat the above procedure.

2. Technical Test

2.1. Summary of Test Result

Performed Item	FCC References	IC References	Result
Peak Output Power	FCC PART 2.1046 and PART 27.50(h)(2)	RSS-139 §6.5	Pass
Occupied Bandwidth	FCC PART 2.1049 and PART 27.53(l)(6)	RSS-Gen §6.6	Pass
Spurious Emission At Antenna Terminals (+/- 1MHz)	FCC PART 2.1051 and PART 27.53(l)(4)(6)	RSS-139 §6.6	Pass
Spurious Emission	FCC PART 2.1051 and PART 27.53(l)(4)(6)	RSS-139 §6.6	Pass
Frequency Stability Under Temperature & Voltage Variations	FCC PART 2.1055(a)(l) and PART 27.54	RSS-139 §6.4	Pass

2.2. Test Environment

Items	Required (IEC 68-1)	Actual
Temperature (°C)	15-35	23
Humidity (%RH)	25-75	52
Barometric pressure (mbar)	860-1060	950-1000

3. Peak Output Power

3.1. Test Equipment

The following test equipments are used during the test:

Peak Output Power - Conducted Measurement /SR10-H

Instrument	Manufacturer	Model No.	Serial No	Next Cal. Date
Signal & Spectrum Analyzer	R&S	FSVA40	101455	2017/11/27
Multisystem UE Tester	Japan radio	NJZ-2000	ET00477	2017/09/19
Directional coupler	Agilent	778D	20402	2017/10/06

Note: All equipments are calibrated with traceable calibrations. Each calibration is traceable to the national or international standards.

Peak Output Power - Radiated Measurement /CB4-H

Instrument	Manufacturer	Model No.	Serial No	Next Cal. Date
Bilog Antenna	Schaffner	CBL6112B	2891	2017/08/14
Horn Antenna	Schwarzbeck	BBHA 9120	D312	2017/10/25
Pre-Amplifier	EMCI	EMC0031835	980233	2017/01/26
Pre-Amplifier	Schwarzbeck	DBL-1840N506	013	2017/09/29
Pre-Amplifier	Miteq	JS41-001040000-58-5P	1573954	2017/10/04
Horn Antenna	Schwarzbeck	BBHA 9170	203	2017/08/28
Signal & Spectrum Analyzer	R&S	FSV40	101049	2018/01/05

3.2. Test Setup

RF Conducted Measurement:

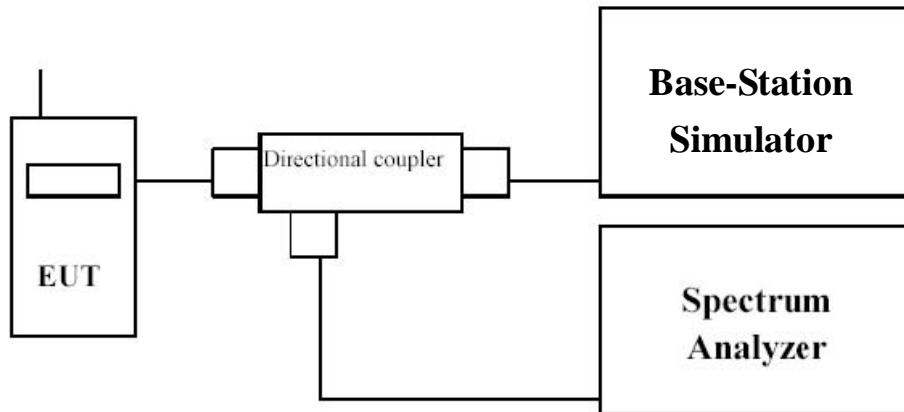

RF Radiated Measurement:

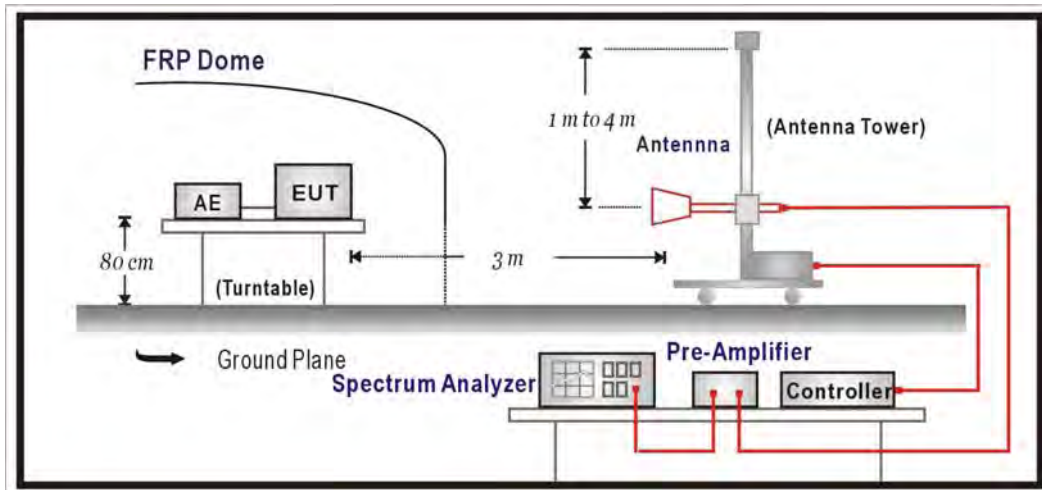

Substitution Measurement Setup:

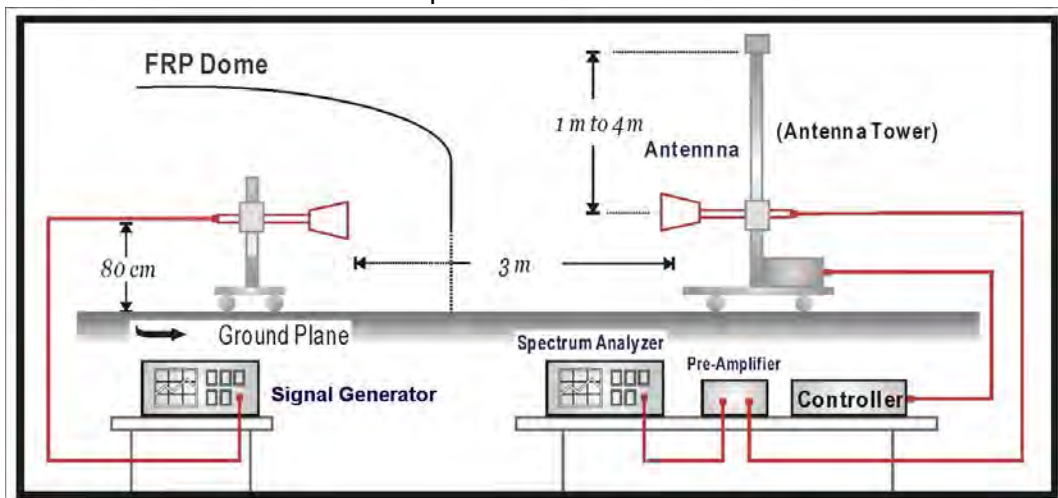

3.3. Limits

- (1) Main, Booster and Base Stations: Maximum E.I.R.P shall not exceed $33 \text{ dBW} + 10\log(X/Y)$ dBW, where X is the actual channel width in MHz and Y is either 6 MHz if prior to transition or the station is in the MBS following transition or 5.5 MHz if the station is in the LBS and UBS following transition.
- (2) Mobile and Other User Stations: 2.0 Watts EIRP.

3.4. Test Procedure

The conducted peak output power is measured using R&S Spectrum Analyzer. The EUT was set up for the rated peak power. All measurements were done at 3 channels: low, middle and high operational frequency range.

For measuring E.I.R.P peak power, EUT was placed on the turn-table which was rotated around 360 degrees to search the maximum radiation power and receiver antenna was rotated vertical and horizontal polarization to find the maximum polarization radiated power.

The EUT is replaced by a horn antenna connected to a signal generator tuned to the frequency of emission and level of signal generator adjusted to same level of emission. Both horizontal and vertical polarization of the antenna are set on measurement.

The radiated E.I.R.P power was calculated via the Correct factor, Reading Level, and Antenna gain as follows:

$$\text{E.I.R.P} = \text{Reading Level} + \text{Correct Factor} = \text{S.G.} - \text{Cable Loss} + \text{Antenna Gain}$$

3.5. Uncertainty

The measurement uncertainty is defined as $\pm 1.27 \text{ dB}$

3.6. Test Result

Product	Module		
Test Item	Peak Output Power		
Test Mode	Mode 1: WCDMA Band 4_Link mode		
Date of Test	2016/12/07	Test Site	SR10-H

Frequency (MHz)	Peak Power		Average Power	Limit (dBm)
	Reading Level (dBm)	Measure Level (dBm)	Measure Level (dBm)	
1712.4	27.86	29.86	27.77	30
1732.6	25.61	27.61	25.54	30
1752.6	26.00	28.00	25.92	30

1712.4 MHz

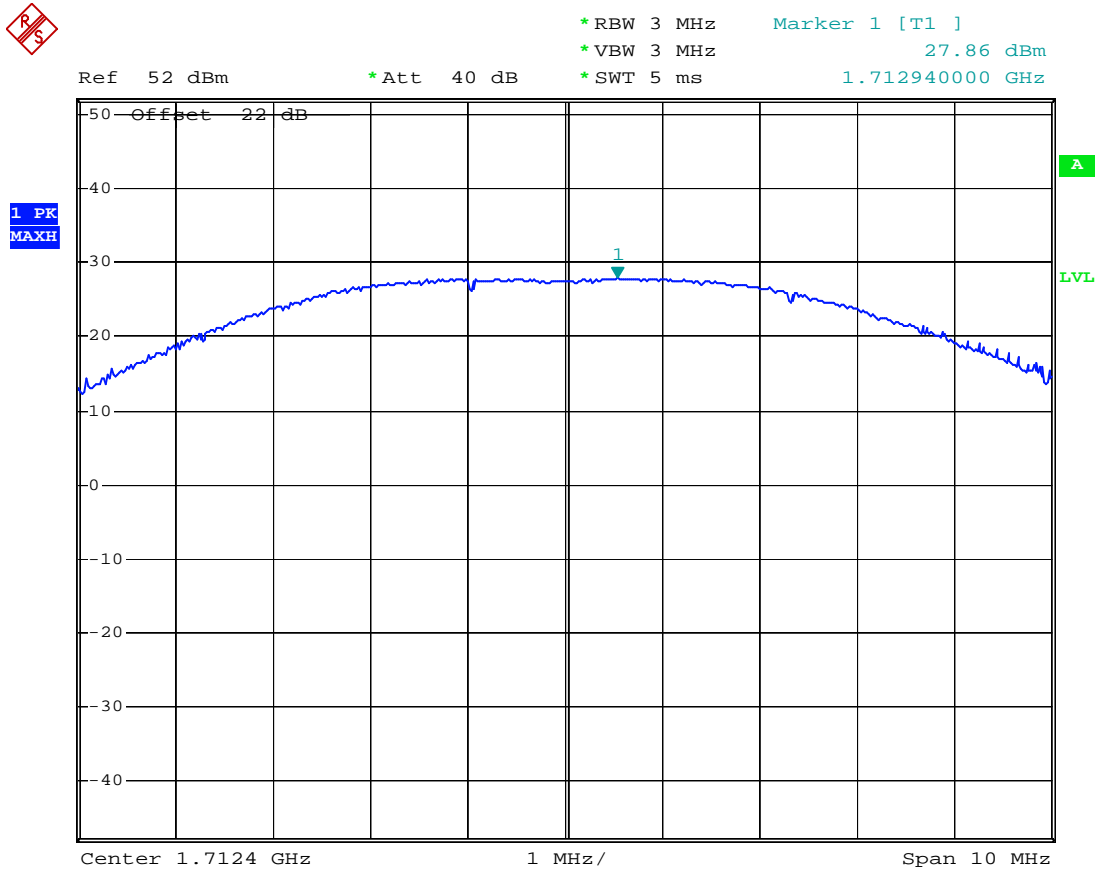

1732.6 MHz

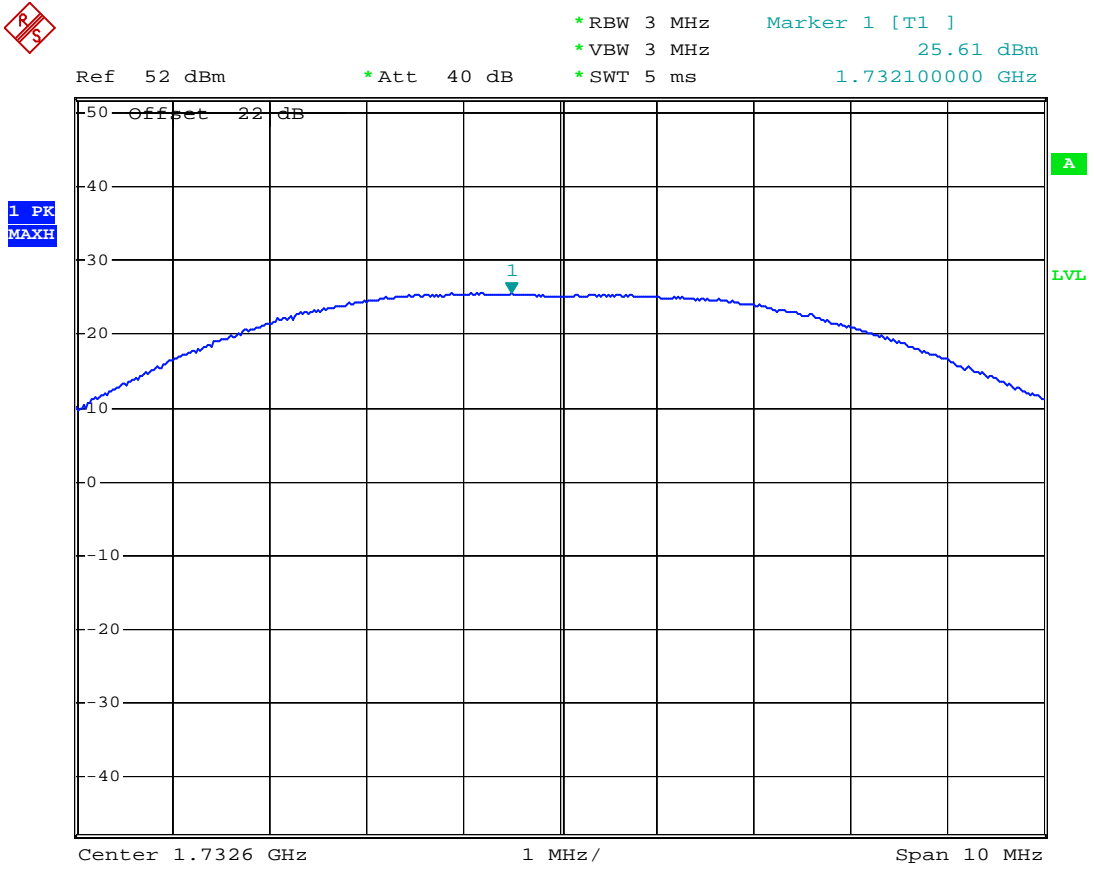

1752.6 MHz

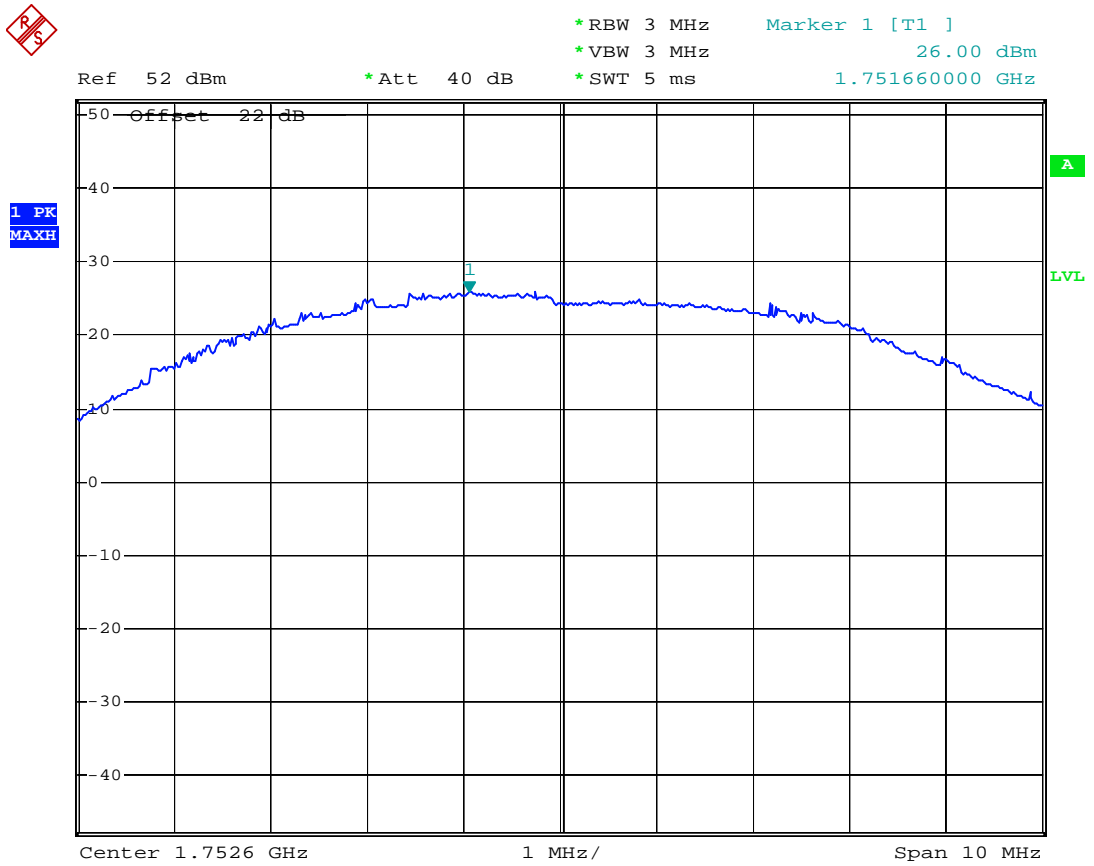

Product	Module		
Test Item	Peak Output Power_ Radiated		
Test Mode	Mode 1: WCDMA Band 4_Link mode		
Date of Test	2016/12/07	Test Site	SR10-H

Frequency (MHz)	Measure Level (dBm)	Limit (dBm)
824.2	25.06	30
836.6	24.74	30
848.8	24.95	30

4. Occupied Bandwidth

4.1. Test Equipment

The following test equipments are used during the test:

Occupied Bandwidth/ SR10-H

Instrument	Manufacturer	Model No.	Serial No.	Next Cal. Date
Signal & Spectrum Analyzer	R&S	FSV40	101049	2017/01/05
Multisystem UE Tester	Japan radio	NJZ-2000	ET00477	2017/09/19
Directional coupler	Agilent	778D-012	50550	2017/01/06

Note: All equipments are calibrated with traceable calibrations.

Each calibration is traceable to the national or international standards.

4.2. Test Setup

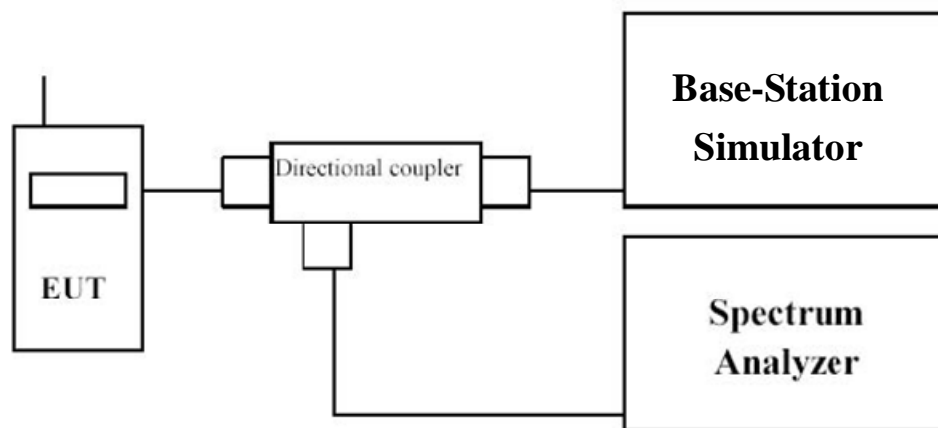

4.3. Limits

The emission bandwidth is defined as the width of the signal between two points, one below the carrier center frequency and one above the carrier center frequency, outside of which all emissions are attenuated at least 26 dB below the transmitter power.

4.4. Test Procedure

The occupied bandwidth is measured using R&S Spectrum Analyzer with a resolution bandwidth of 100 kHz, video bandwidth of 300 kHz and span of 10 MHz. The EUT was set up for the rated peak power under transmission mode and specific channel frequency. The standards required a measurement bandwidth is the fundamental emission below 26dB bandwidth.

4.5. Uncertainty

The measurement uncertainty is defined as ± 50 KHz

4.6. Test Result

Product	Module		
Test Item	Occupied Bandwidth		
Test Mode	Mode 1: WCDMA Band 4_Link mode		
Date of Test	2016/12/08	Test Site	SR10-H

Frequency (MHz)	-26dB BW Measure Level (KHz)	99% BW Measure Level (KHz)	Limit (MHz)
1712.4	4511.5	4138.9	N/A
1732.6	4461.6	4138.9	N/A
1752.6	4478.6	4124.4	N/A

1712.4 MHz (-26dB BW)

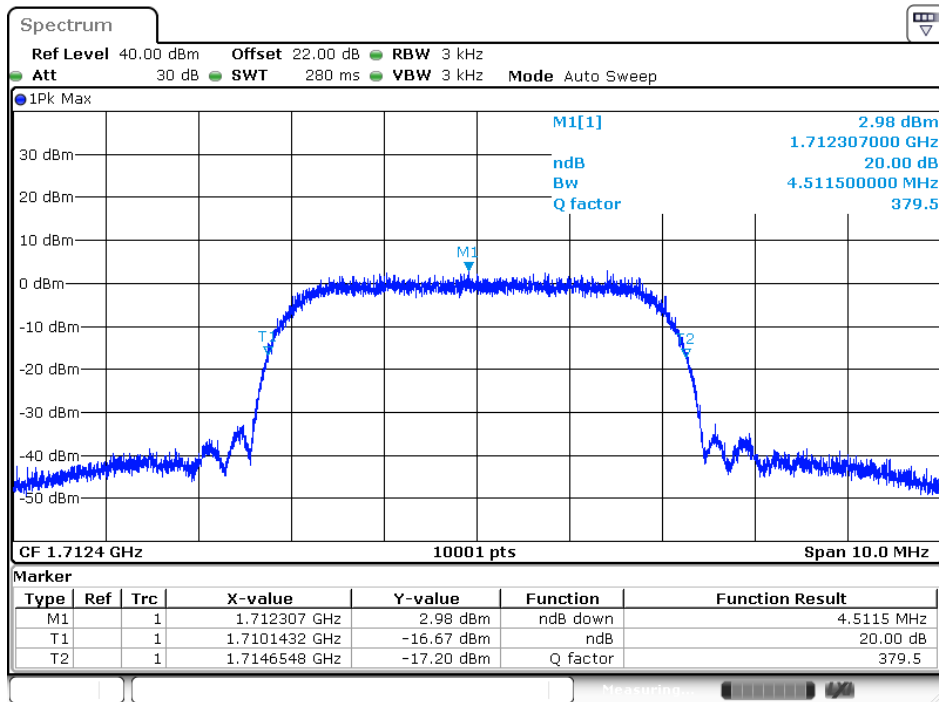

Date: 8 DEC 2016 12:36:52

1712.4 MHz (99% BW)

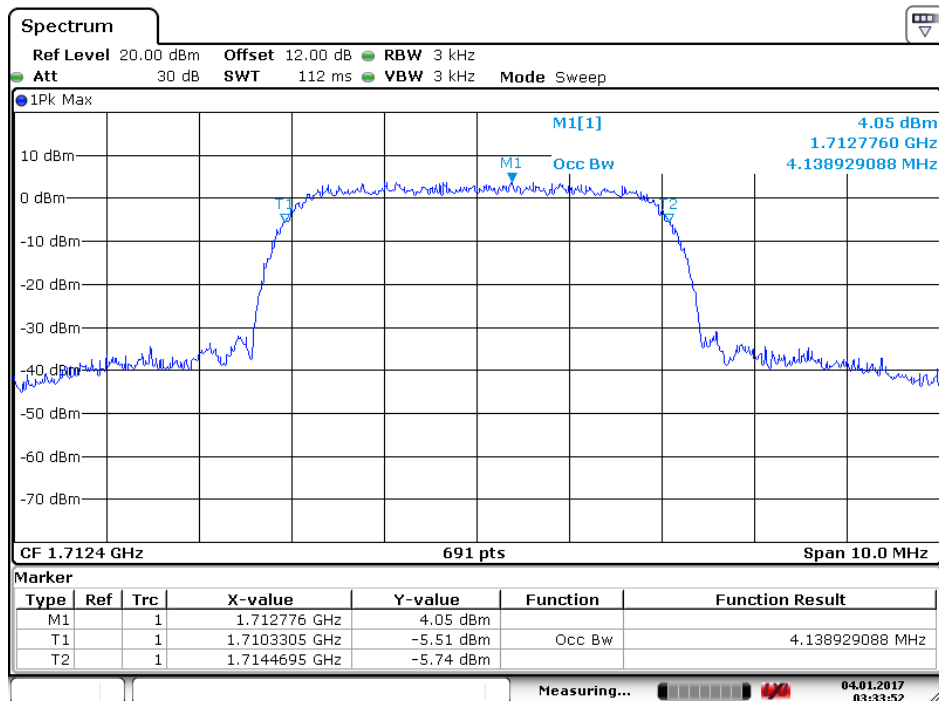

Date: 4 JAN 2017 03:33:53

1732.6 MHz (-26dB BW)

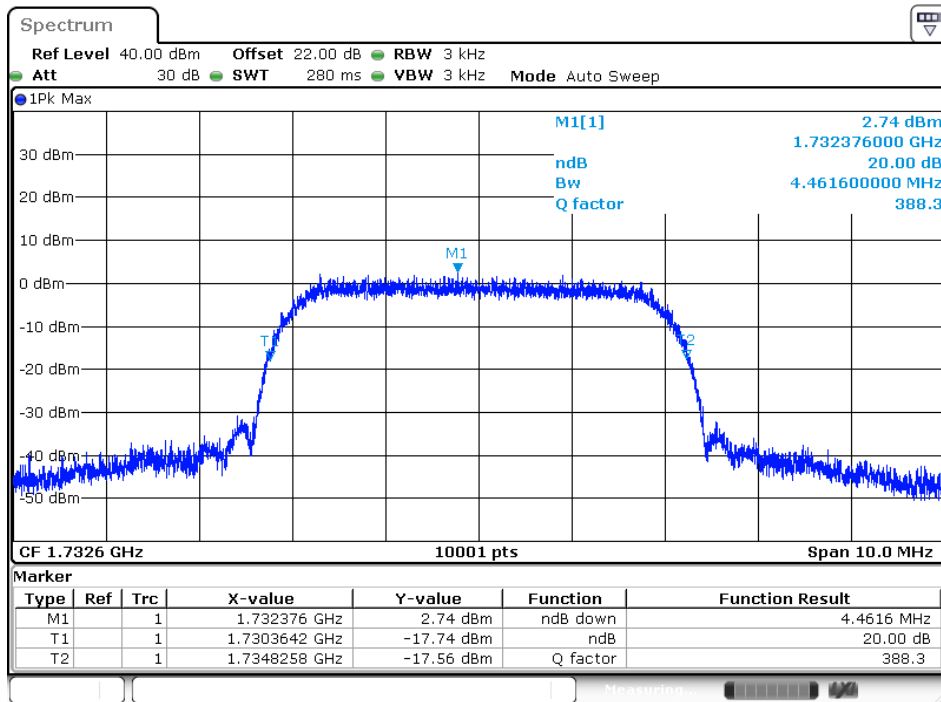

Date: 8 DEC 2016 12:39:30

1732.6 MHz (99% BW)

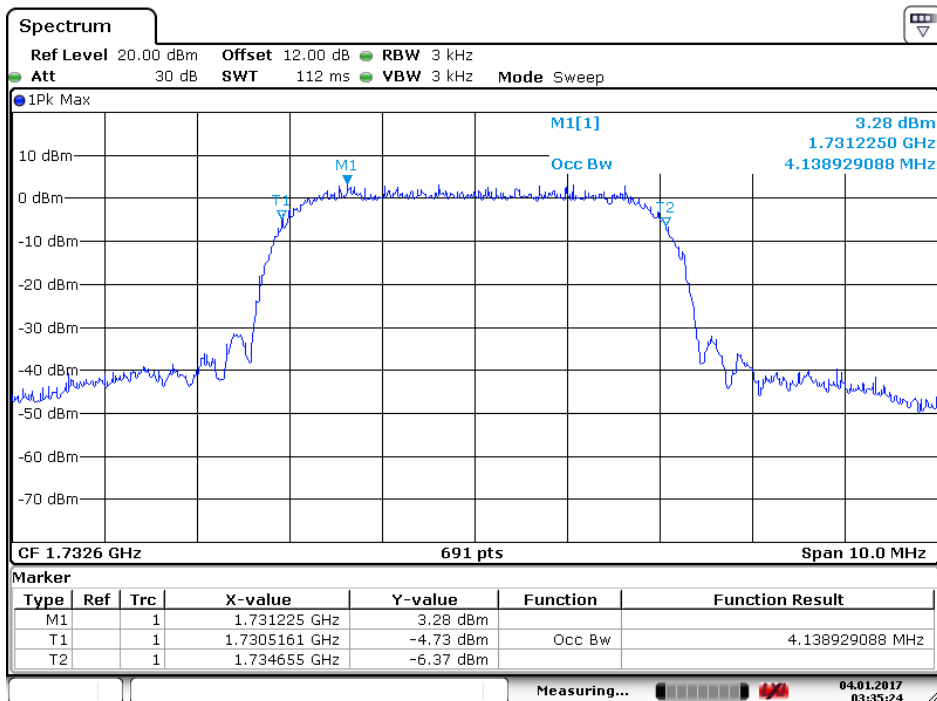

Date: 4 JAN 2017 03:35:25

1752.6MHz (-26dB BW)

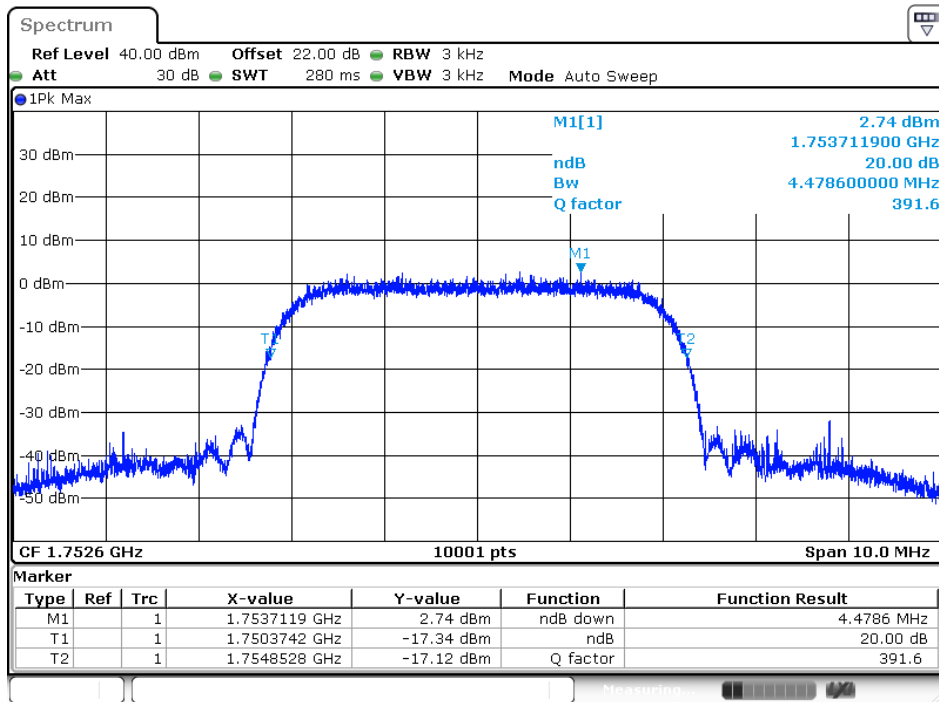

Date: 8 DEC 2016 12:41:39

1752.6MHz (99% BW)

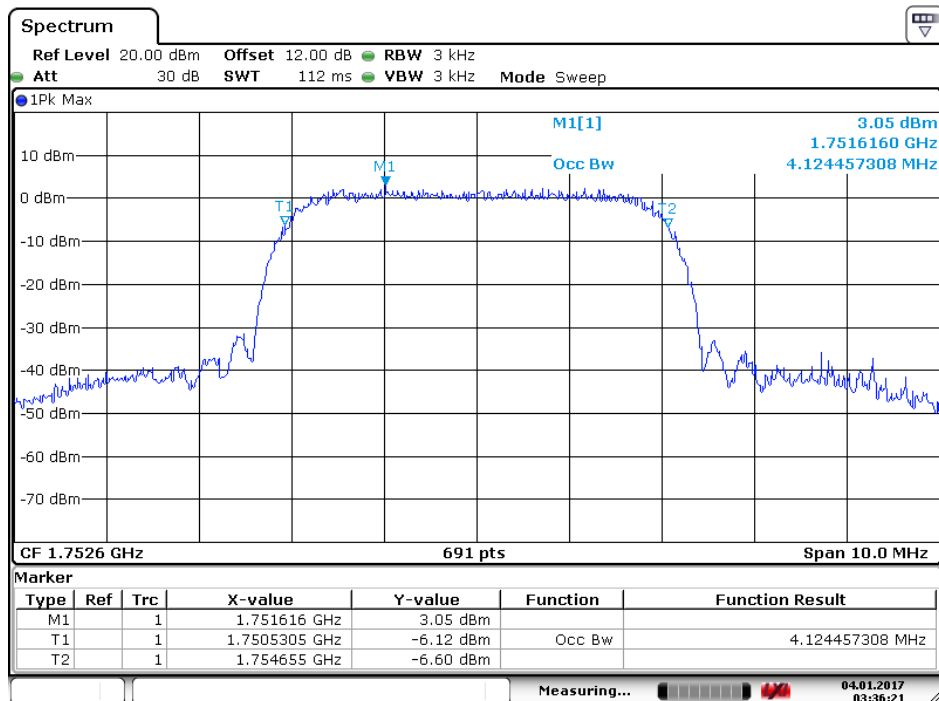

Date: 4 JAN 2017 03:36:22

5. Band Edge

5.1. Test Equipment

The following test equipments are used during the test:

Band edge / SR10-H

Instrument	Manufacturer	Model No.	Serial No.	Next Cal. Date
Signal & Spectrum Analyzer	R&S	FSV40	101049	2017/01/05
Multisystem UE Tester	Japan radio	NJZ-2000	ET00477	2017/09/19
Directional coupler	Agilent	778D-012	50550	2017/01/06

Note: All equipments that need to calibrate are with calibration period of 1 year.

5.2. Test Setup

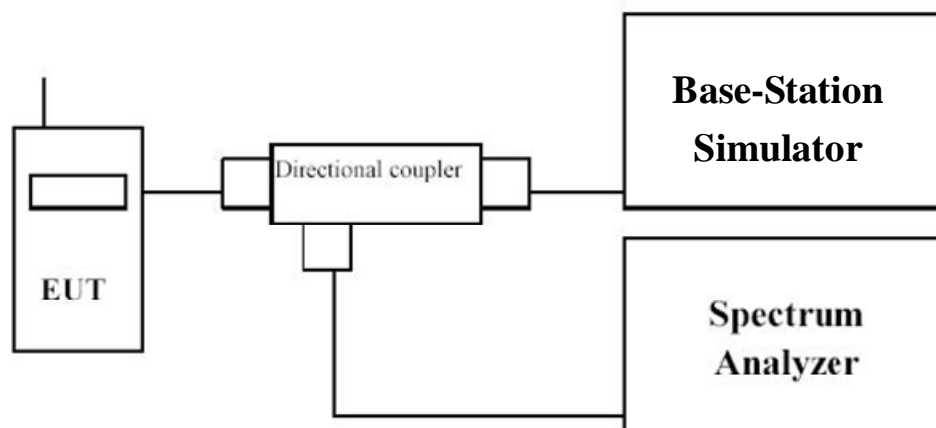

5.3. Limits

- (1) Fixed and Temporary Fixed Digital Stations: not less than $43 + \log (P)$ dB
- (2) Mobile Digital Stations: not less than $43 + \log (P)$ dB at the channel edge and $55 + \log (P)$ dB at 5.5 MHz from the channel edges

Sample Calculation:

Assume the EUT Output Power is $2\text{ W} = 33\text{ dBm}$

$$43 + \log (P) \text{ dB}$$

$$43 + \log (2) = 46 \text{ dB}$$

$$33 \text{ dBm} - 46 \text{ dB} = -13 \text{ dBm}$$

$$55 + \log (2) = 58 \text{ dB}$$

$$33 \text{ dBm} - 58 \text{ dB} = -25 \text{ dBm}$$

5.4. Test Procedure

Conducted Measurement :

The EUT was set up for the rated peak power. The band edge was measured with Spectrum Analyzer with a resolution bandwidth of 100 kHz and video bandwidth of 300 kHz. All measurements were done at 2 channels: low and high operational frequency range.

The center frequency of spectrum is the band edge frequency and span is 7.5 MHz for test mode 1 (5 MHz bandwidth) and 15 MHz for test mode 2 (10 MHz bandwidth). The resolution bandwidth of spectrum is 100 kHz and video bandwidth of spectrum is 300 kHz.

Record the max trace plot into the test report.

Radiated Measurement :

EUT was placed on the turn-table which was rotated around 360 degrees to search the maximum radiation power and receiver antenna was rotated vertical and horizontal polarization to find the maximum polarization radiated power.

The EUT is replaced by a horn antenna connected to a signal generator tuned to the frequency of emission and level of signal generator adjusted to same level of emission. Both horizontal and vertical polarization of the antenna are set on measurement.

On any frequency, the limits shown are based on measuring equipment employing a peak detector function. The resolution bandwidth of spectrum analyzer is 100KHz. and video bandwidth is 300KHz.

The radiated band edge emission was calculated via the Correct factor, Reading Level, and Antenna gain as follows:

Emission Level = Reading Level + Correct Factor = S.G. – Cable Loss + Antenna Gain

5.5. Uncertainty

The measurement uncertainty

Conducted is defined as $\pm 1.27\text{dB}$

Radiated is defined as $\pm 3.9\text{dB}$

5.6. Test Result

Product	Module		
Test Item	Band Edge		
Test Mode	Mode 1: WCDMA Band 4_Link mode		
Date of Test	2016/12/08	Test Site	SR10-H

Low Channel (1712.4 MHz)

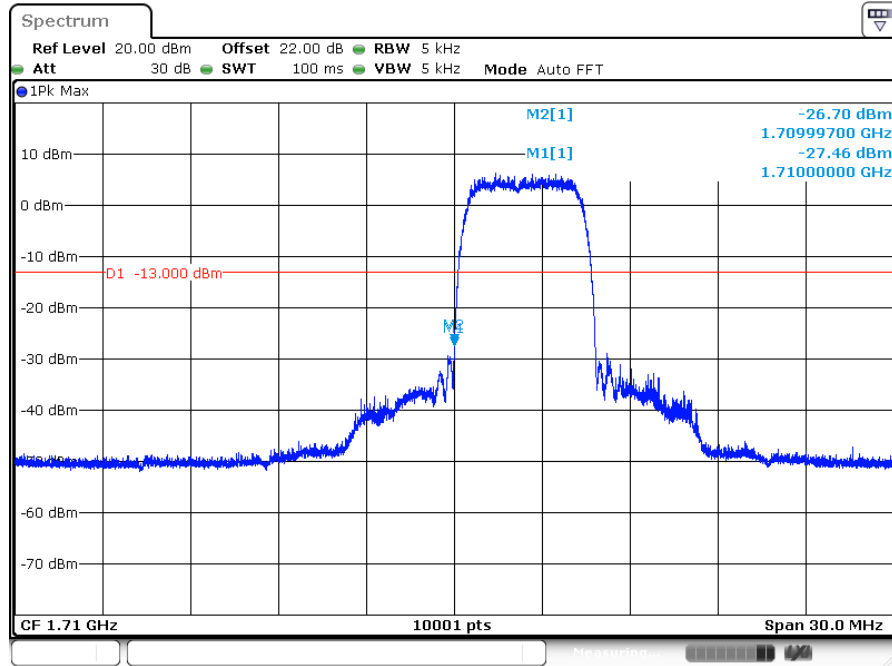

Date: 8 DEC 2016 17:49:08

High Channel (1752.6 MHz)

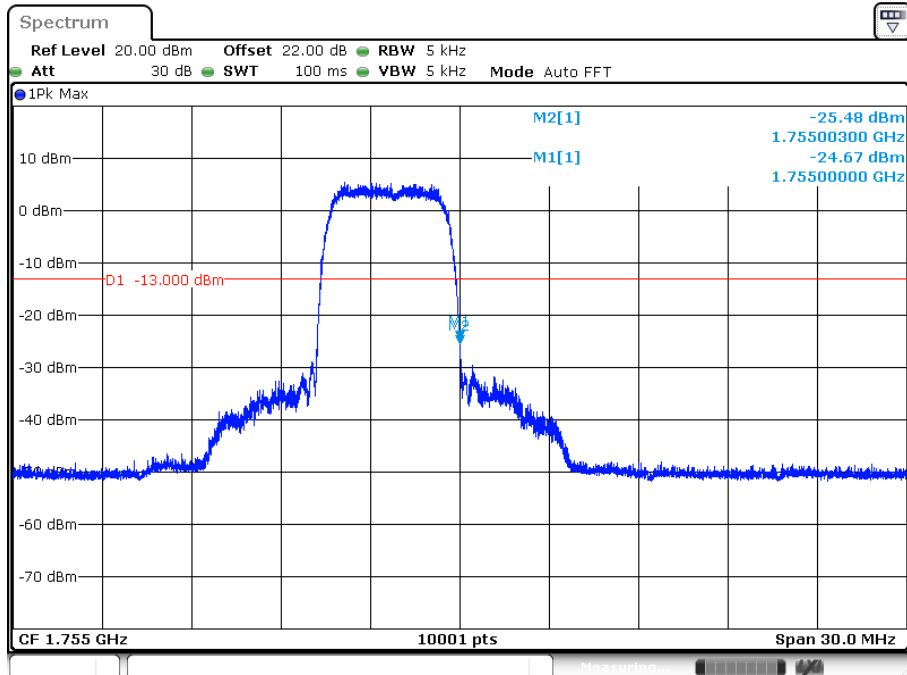

Date: 8 DEC 2016 17:51:02

6. Conducted Spurious Emission

6.1. Test Equipment

The following test equipments are used during the test:

Conducted Spurious Emission / SR10-H

Instrument	Manufacturer	Model No.	Serial No.	Next Cal. Date
Signal & Spectrum Analyzer	R&S	FSV40	101049	2017/01/05
Multisystem UE Tester	Japan radio	NJZ-2000	ET00477	2017/09/19
Directional coupler	Agilent	778D-012	50550	2017/01/06

Note: All equipments are calibrated with traceable calibrations. Each calibration is traceable to the national or international standards.

6.2. Test Setup

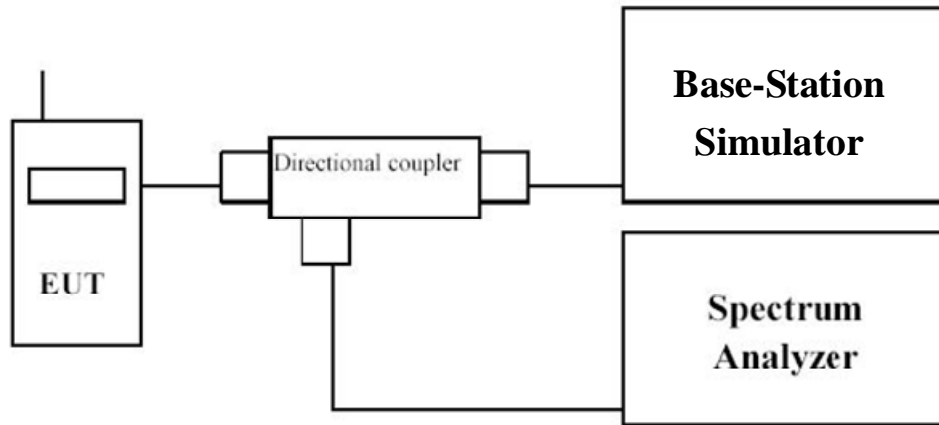

6.3. Limits

- (1) Fixed and Temporary Fixed Digital Stations: not less than $43 + \log (P)$ dB
- (2) Mobile Digital Stations: not less than $43 + \log (P)$ dB at the channel edge and $55 + \log (P)$ dB at 5.5 MHz from the channel edges

Sample Calculation:

Assume the EUT Output Power is $2 \text{ W} = 33 \text{ dBm}$

$43 + \log (P)$ dB

$43 + \log (2) = 46 \text{ dB}$

$33 \text{ dBm} - 46 \text{ dB} = -13 \text{ dBm}$

$55 + \log (2) = 58 \text{ dB}$

$33 \text{ dBm} - 58 \text{ dB} = -25 \text{ dBm}$

6.4. Test Procedure

The EUT was set up for the rated peak power. The power was measured with R&S Spectrum Analyzer. All measurements were done at 3 channels: low, middle and high operational frequency range.

When the spectrum scanned from 30MHz to 27GHz, it connected to the 10dB attenuator to the carried frequency. The spectrum set RBW = 1MHz, VBW = 3MHz. and using peak detection mode.

6.5. Uncertainty

The measurement uncertainty is defined as $\pm 1.27 \text{ dB}$

6.6. Test Result

Product	Module		
Test Item	Conducted Spurious Emission		
Test Mode	Mode 1: WCDMA Band 4_Link mode		
Date of Test	2016/12/08	Test Site	SR10-H

1712.4 MHz

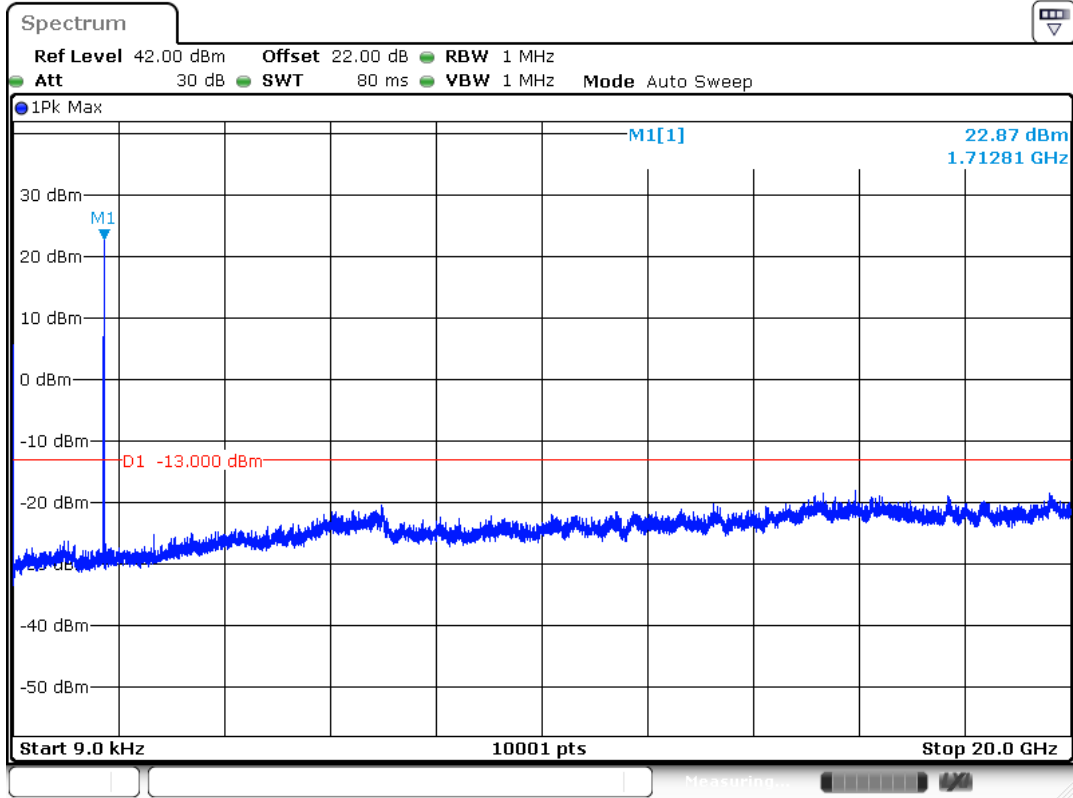

1732.6 MHz

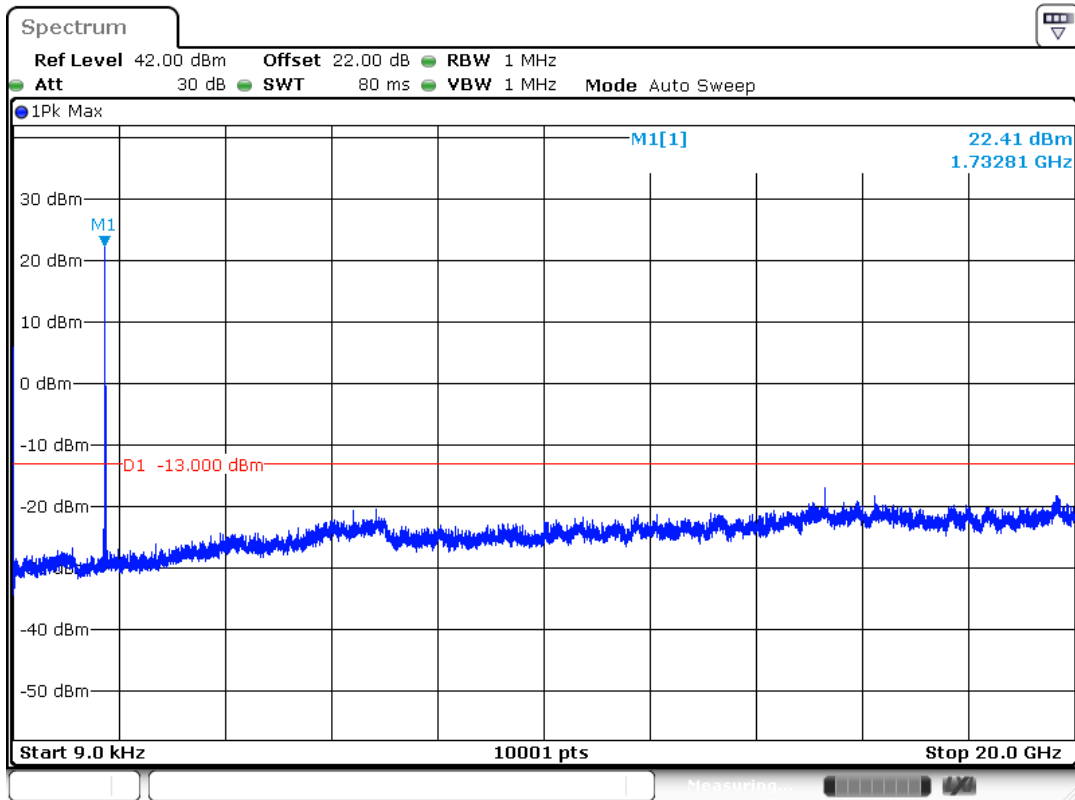

Date: 8 DEC. 2016 16:53:36

1752.6 MHz

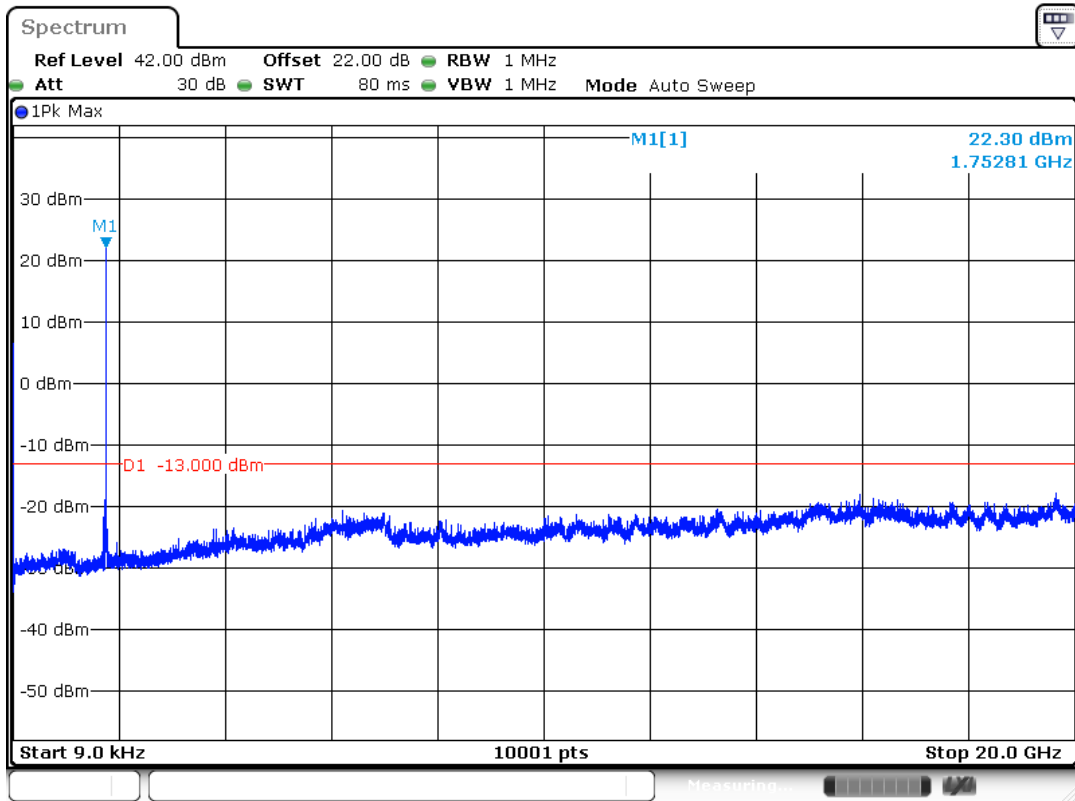

Date: 8 DEC. 2016 15:47:32

7. Radiated Spurious Emission

7.1. Test Equipment

The following test equipments are used during the test:

Radiated Emission / CB4-H

Instrument	Manufacturer	Model No.	Serial No	Next Cal. Date
Test Receiver	R&S	ESCS 30	100122	2017/01/21
Multisystem UE Tester	Japan radio	NJZ-2000	ET00477	2017/09/19
Signal & Spectrum Analyzer	R&S	FSV40	101049	2017/01/05
Pre-Amplifier	DEKRA	AP-025C	CHM-0706049	2017/01/03
Bilog Antenna	Schaffner	CBL6112B	2797	2017/08/14
Pre-Amplifier	EMCI	EMC0031835	980233	2017/01/26
Horn Antenna	Schwarzbeck	BBHA 9120	D639	2017/06/29

Note: All equipment that need to calibrate are with calibration period of 1 year.

7.2. Test Setup

Under 1GHz Test Setup:

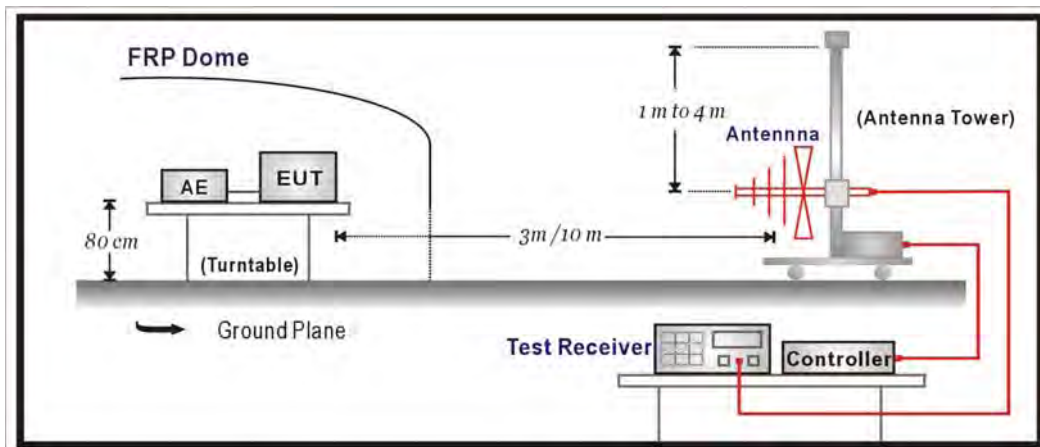

Above 1GHz Test Setup:

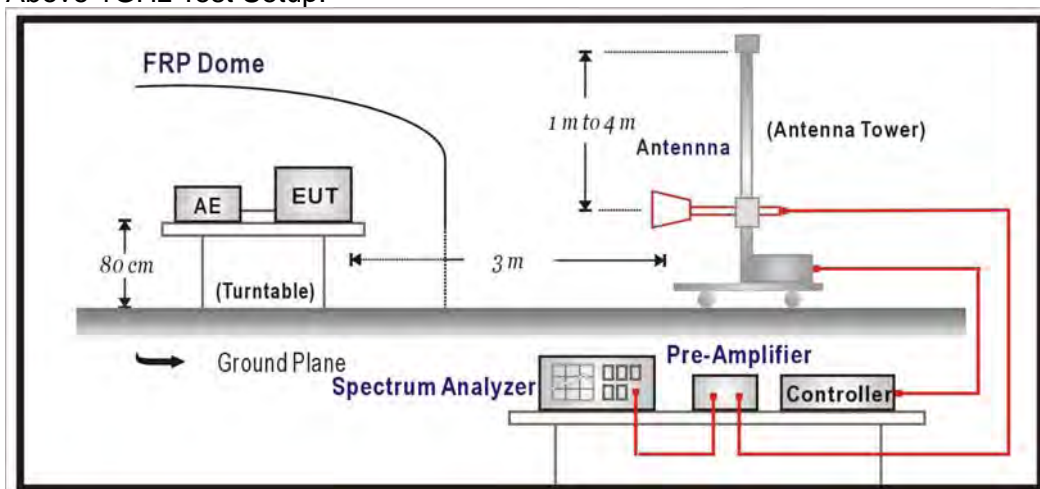

Substitution Measurement Setup:

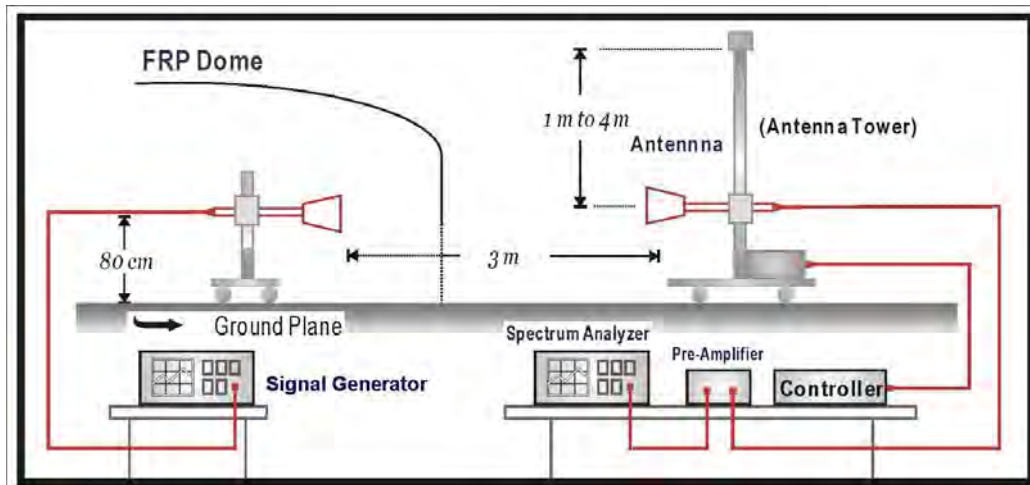

7.3. Limits

- (1) Fixed and Temporary Fixed Digital Stations: not less than $43 + \log(P)$ dB.
- (2) Mobile Digital Stations: not less than $43 + \log(P)$ dB at the channel edge and $55 + \log(P)$ dB at 5.5 MHz from the channel edges.

Sample Calculation:

Assume the EUT Output Power is $2\text{ W} = 33\text{ dBm}$

$$43 + \log(P)\text{ dB}$$

$$43 + \log(2) = 46\text{ dB}$$

$$33\text{ dBm} - 46\text{ dB} = -13\text{ dBm}$$

$$55 + \log(2) = 58\text{ dB}$$

$$33\text{ dBm} - 58\text{ dB} = -25\text{ dBm}$$

7.4. Test Procedure

For measuring E.I.R.P peak power, EUT was placed on the turn-table which was rotated around 360 degrees to search the maximum radiation power and receiver antenna was rotated vertical and horizontal polarization to find the maximum polarization radiated power.

The EUT is replaced by a horn antenna connected to a signal generator tuned to the frequency of emission and level of signal generator adjusted to same level of emission. Both horizontal and vertical polarization of the antenna are set on measurement.

On any frequency, the limits shown are based on measuring equipment employing a peak detector function. The resolution bandwidth of spectrum analyzer is 1MHz. and video bandwidth is 3MHz.

The radiated E.I.R.P power was calculated via the Correct factor, Reading Level, and Antenna gain as follows:

$$\text{E.I.R.P} = \text{Reading Level} + \text{Correct Factor} = \text{S.G.} - \text{Cable Loss} + \text{Antenna Gain}$$

7.5. Uncertainty

The measurement uncertainty

30MHz~1GHz as $\pm 3.19\text{dB}$

1GHz~27GHz as $\pm 3.9\text{dB}$

7.6. Test Result

30 MHz - 1 GHz Spurious:

Site : CB4-H	Time : 2016/11/22 - 17:36
Limit : FCC_CLASS_B_03M_QP	Margin : 6
Probe : CB4-H_FCC_EFS_30M-1GHz - HORIZONTAL	Power : DC 3.7V
EUT : Module	Note : Mode 1: WCDMA Band 4_Link mode_ CH:1638

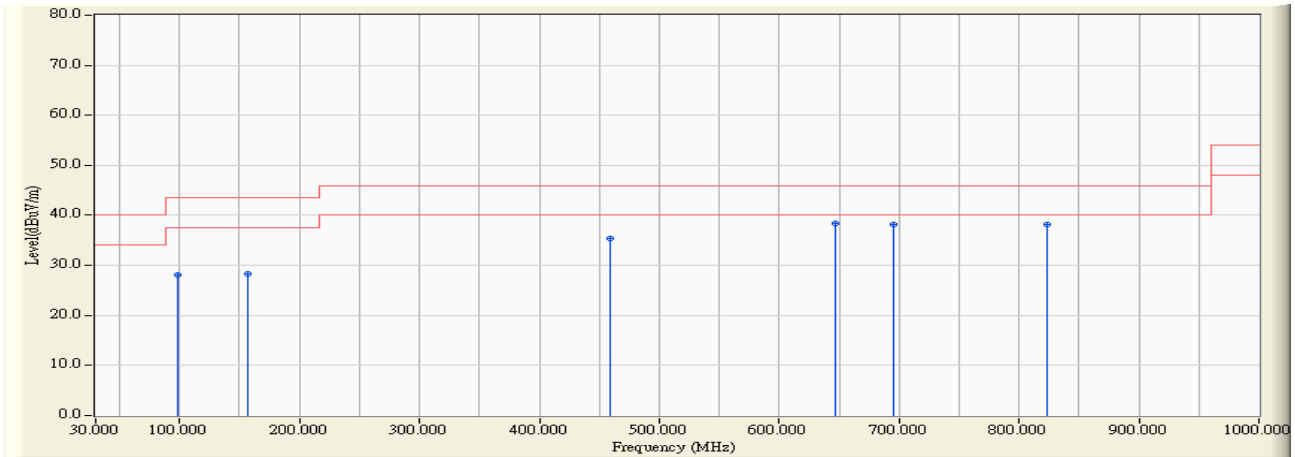

	Frequency (MHz)	Correct Factor (dB)	Reading Level (dBuV)	Measure Level (dBuV/m)	Margin (dB)	Limit (dBuV/m)	Detector Type
1	98.870	18.599	9.484	28.084	-15.416	43.500	QUASPEAK
2	157.070	19.385	8.945	28.330	-15.170	43.500	QUASPEAK
3	459.225	26.693	8.630	35.324	-10.676	46.000	QUASPEAK
4	* 647.405	29.042	9.390	38.433	-7.567	46.000	QUASPEAK
5	695.420	29.485	8.697	38.182	-7.818	46.000	QUASPEAK
6	823.460	30.967	7.214	38.181	-7.819	46.000	QUASPEAK

Note:

1. All Reading Levels are Quasi-Peak value.
2. “ * ”, means this data is the worst emission level.
3. Measurement Level = Reading Level + Correct Factor.

Site : CB4-H	Time : 2016/11/22 - 17:30
Limit : FCC_CLASS_B_03M_QP	Margin : 6
Probe : CB4-H_FCC_EFS_30M-1GHz - VERTICAL	Power : DC 3.7V
EUT : Module	Note : Mode 1: WCDMA Band 4_Link mode_ CH:1638

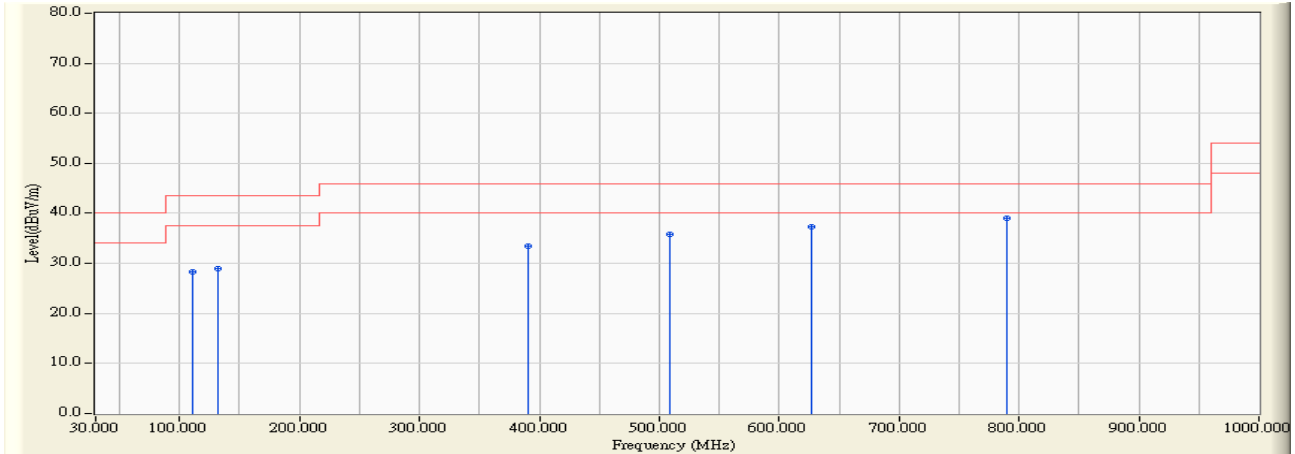

	Frequency (MHz)	Correct Factor (dB)	Reading Level (dBuV)	Measure Level (dBuV/m)	Margin (dB)	Limit (dBuV/m)	Detector Type
1	110.510	19.920	8.331	28.251	-15.249	43.500	QUASPEAK
2	132.335	20.580	8.390	28.970	-14.530	43.500	QUASPEAK
3	390.840	25.333	8.175	33.509	-12.491	46.000	QUASPEAK
4	508.210	27.495	8.408	35.903	-10.097	46.000	QUASPEAK
5	627.035	28.852	8.551	37.404	-8.596	46.000	QUASPEAK
6	* 789.995	30.578	8.362	38.940	-7.060	46.000	QUASPEAK

Note:

1. All Reading Levels are Quasi-Peak value.
2. “ * ”, means this data is the worst emission level.
3. Measurement Level = Reading Level + Correct Factor.

Site : CB4-H	Time : 2016/11/22 - 17:41
Limit : FCC_CLASS_B_03M_QP	Margin : 6
Probe : CB4-H_FCC_EFS_30M-1GHz - HORIZONTAL	Power : DC 3.7V
EUT : Module	Note : Mode 2: WCDMA Band 4_Idle mode_ CH:1638

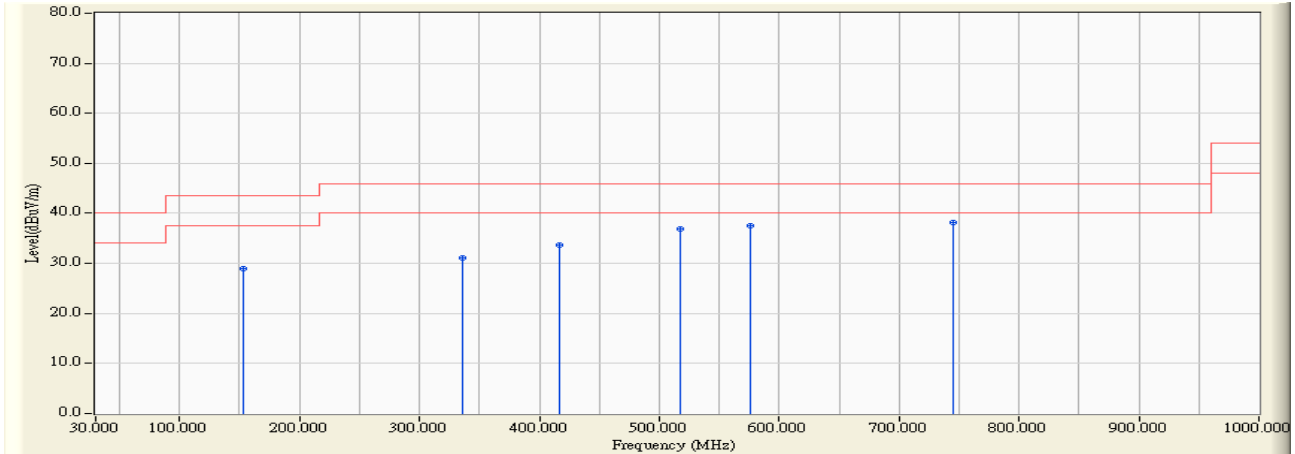

	Frequency (MHz)	Correct Factor (dB)	Reading Level (dBuV)	Measure Level (dBuV/m)	Margin (dB)	Limit (dBuV/m)	Detector Type
1	153.675	19.586	9.316	28.903	-14.597	43.500	QUASPEAK
2	336.520	23.597	7.505	31.102	-14.898	46.000	QUASPEAK
3	416.545	25.927	7.717	33.644	-12.356	46.000	QUASPEAK
4	517.425	27.607	9.283	36.889	-9.111	46.000	QUASPEAK
5	576.110	28.315	9.163	37.478	-8.522	46.000	QUASPEAK
6	* 744.890	30.038	8.175	38.213	-7.787	46.000	QUASPEAK

Note:

1. All Reading Levels are Quasi-Peak value.
2. “ * ”, means this data is the worst emission level.
3. Measurement Level = Reading Level + Correct Factor.

Site : CB4-H	Time : 2016/11/22 - 17:45
Limit : FCC_CLASS_B_03M_QP	Margin : 6
Probe : CB4-H_FCC_EFS_30M-1GHz - VERTICAL	Power : DC 3.7V
EUT : Module	Note : Mode 2: WCDMA Band 4_Idle mode_ CH:1638

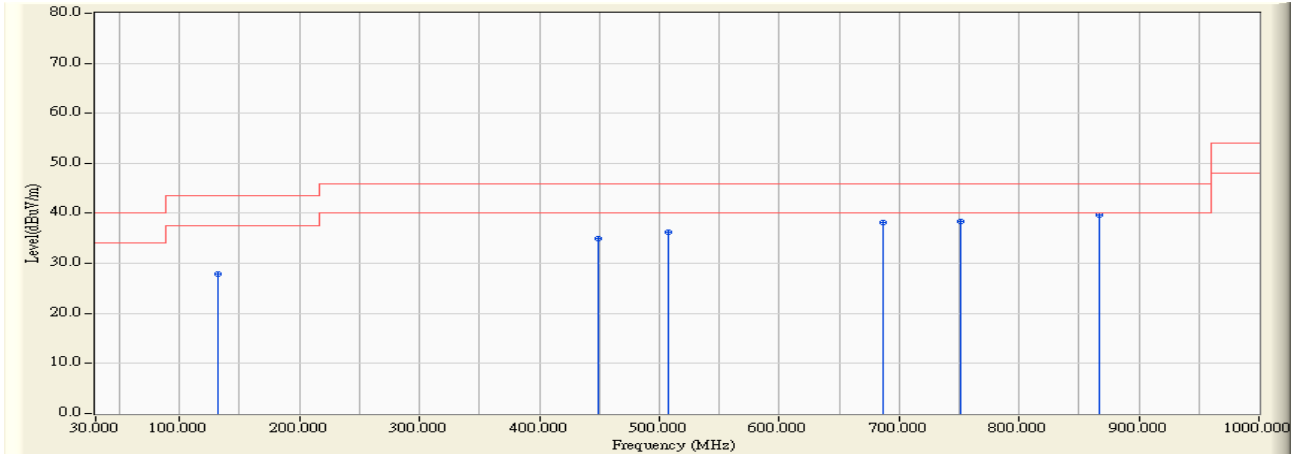

	Frequency (MHz)	Correct Factor (dB)	Reading Level (dBuV)	Measure Level (dBuV/m)	Margin (dB)	Limit (dBuV/m)	Detector Type
1	131.850	20.592	7.218	27.810	-15.690	43.500	QUASPEAK
2	448.555	26.510	8.403	34.913	-11.087	46.000	QUASPEAK
3	507.725	27.489	8.734	36.223	-9.777	46.000	QUASPEAK
4	686.205	29.400	8.683	38.083	-7.917	46.000	QUASPEAK
5	750.710	30.103	8.273	38.376	-7.624	46.000	QUASPEAK
6	* 867.110	31.468	8.213	39.681	-6.319	46.000	QUASPEAK

Note:

1. All Reading Levels are Quasi-Peak value.
2. “ * ”, means this data is the worst emission level.
3. Measurement Level = Reading Level + Correct Factor.

Harmonic & Spurious:

Site : CB4-H	Time : 2016/12/01 - 17:58
Limit : FCC_Part27(outband)_00M_PK	Margin : 6
Probe : CB4-H_CE_Sub_B432_1-18GHz_3M_1116 - HORIZONTAL	Power : DC 3.7V
EUT : Module	Note : Mode 1: WCDMA Band 4_Link mode_ CH:1312

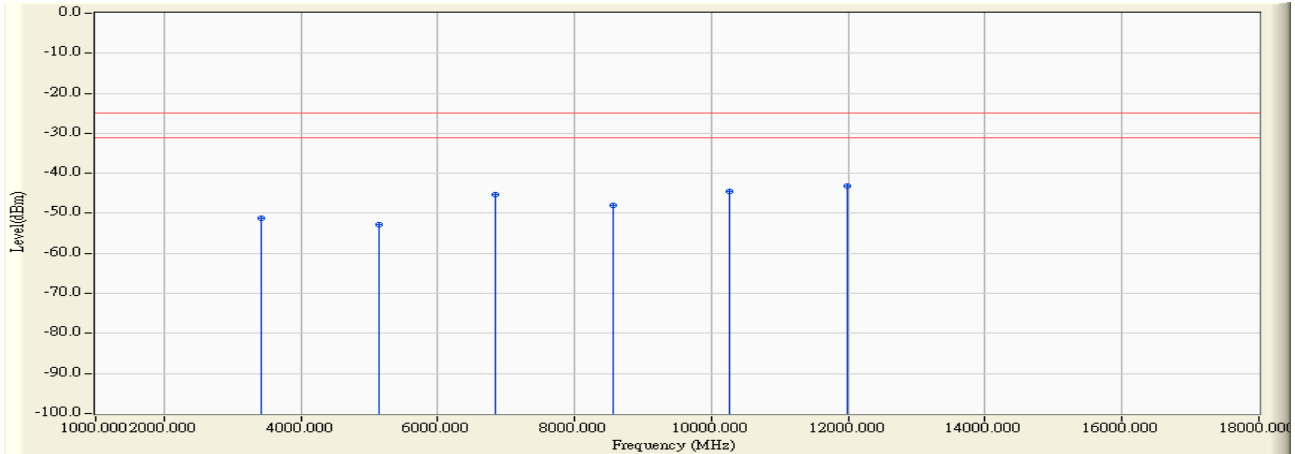

	Frequency (MHz)	Correct Factor (dB)	Reading Level (dBm)	Measure Level (dBm)	Margin (dB)	Limit (dBm)	Detector Type
1	3424.000	11.375	-62.470	-51.095	-26.095	-25.000	PEAK
2	5136.000	13.087	-65.770	-52.682	-27.682	-25.000	PEAK
3	6848.000	18.476	-63.870	-45.394	-20.394	-25.000	PEAK
4	8560.000	21.261	-69.300	-48.039	-23.039	-25.000	PEAK
5	10272.000	24.125	-68.590	-44.465	-19.465	-25.000	PEAK
6	* 11984.000	26.779	-69.810	-43.031	-18.031	-25.000	PEAK

Note:

1. All readings above 1GHz are performed with peak and/or average measurements as necessary.
2. Peak measurements: RBW = 1MHz, VBW = 1MHz, Sweep: Auto.
3. Average measurements: RBW = 1MHz, VBW = 10 Hz, Sweep: Auto.
4. " * ", means this data is the worst emission level.
5. Measurement Level = Reading Level + Correct Factor.
6. The average measurement was not performed when the peak measured data under the limit of average detection.
7. The Emission above 18GHz were not included is because their levels are too low.

Site : CB4-H	Time : 2016/12/01 - 18:03
Limit : FCC_Part27(outband)_00M_PK	Margin : 6
Probe : CB4-H_CE_Sub_B432_1-18GHz_3M_1116 - VERTICAL	Power : DC 3.7V
EUT : Module	Note : Mode 1: WCDMA Band 4_Link mode_ CH:1312

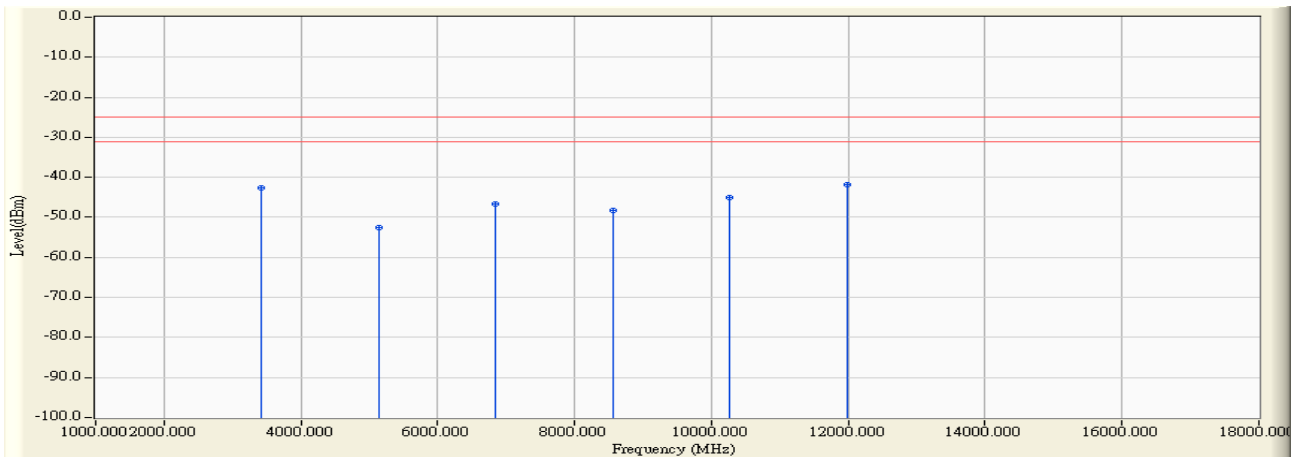

	Frequency (MHz)	Correct Factor (dB)	Reading Level (dBm)	Measure Level (dBm)	Margin (dB)	Limit (dBm)	Detector Type
1	3424.000	12.108	-54.760	-42.652	-17.652	-25.000	PEAK
2	5136.000	12.777	-65.300	-52.522	-27.522	-25.000	PEAK
3	6848.000	17.228	-63.770	-46.542	-21.542	-25.000	PEAK
4	8560.000	21.370	-69.570	-48.199	-23.199	-25.000	PEAK
5	10272.000	24.063	-69.050	-44.987	-19.987	-25.000	PEAK
6	* 11984.000	28.183	-69.890	-41.708	-16.708	-25.000	PEAK

Note:

1. All readings above 1GHz are performed with peak and/or average measurements as necessary.
2. Peak measurements: RBW = 1MHz, VBW = 1MHz, Sweep: Auto.
3. Average measurements: RBW = 1MHz, VBW = 10 Hz, Sweep: Auto.
4. “ * ”, means this data is the worst emission level.
5. Measurement Level = Reading Level + Correct Factor.
6. The average measurement was not performed when the peak measured data under the limit of average detection.
7. The Emission above 18GHz were not included is because their levels are too low.

Site : CB4-H	Time : 2016/12/01 - 18:18
Limit : FCC_Part27(outband)_00M_PK	Margin : 6
Probe : CB4-H_CE_Sub_B432_1-18GHz_3M_1116 - HORIZONTAL	Power : DC 3.7V
EUT : Module	Note : Mode 1: WCDMA Band 4_Link mode_ CH:1413

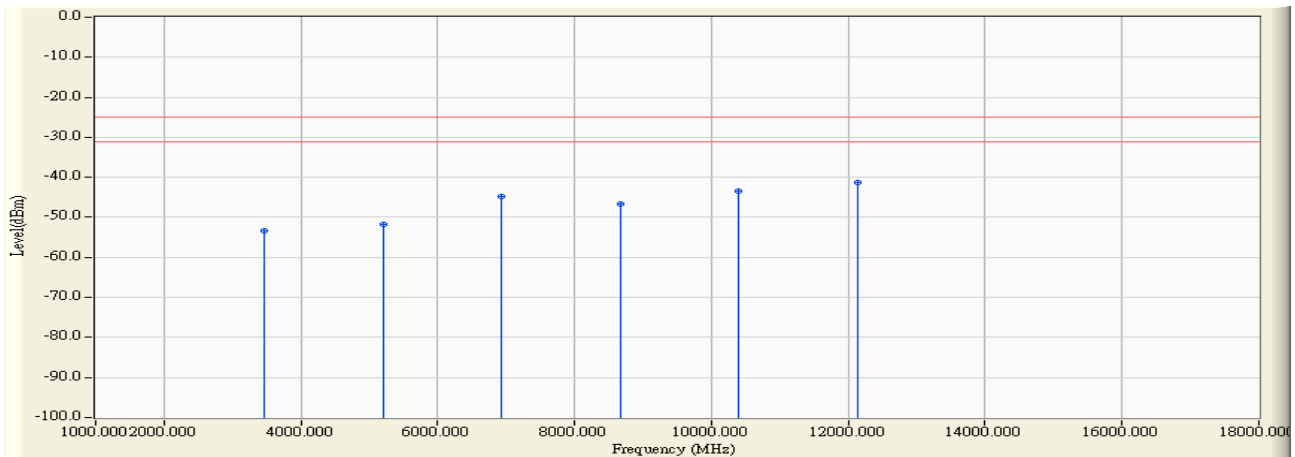

	Frequency (MHz)	Correct Factor (dB)	Reading Level (dBm)	Measure Level (dBm)	Margin (dB)	Limit (dBm)	Detector Type
1	3465.200	11.450	-64.820	-53.370	-28.370	-25.000	PEAK
2	5197.800	13.114	-64.810	-51.696	-26.696	-25.000	PEAK
3	6930.400	18.788	-63.680	-44.891	-19.891	-25.000	PEAK
4	8663.000	21.633	-68.380	-46.747	-21.747	-25.000	PEAK
5	10395.600	24.245	-67.780	-43.536	-18.536	-25.000	PEAK
6	* 12128.200	27.186	-68.490	-41.304	-16.304	-25.000	PEAK

Note:

1. All readings above 1GHz are performed with peak and/or average measurements as necessary.
2. Peak measurements: RBW = 1MHz, VBW = 1MHz, Sweep: Auto.
3. Average measurements: RBW = 1MHz, VBW = 10 Hz, Sweep: Auto.
4. “ * ”, means this data is the worst emission level.
5. Measurement Level = Reading Level + Correct Factor.
6. The average measurement was not performed when the peak measured data under the limit of average detection.
7. The Emission above 18GHz were not included is because their levels are too low.

Site : CB4-H	Time : 2016/12/01 - 18:25
Limit : FCC_Part27(outband)_00M_PK	Margin : 6
Probe : CB4-H_CE_Sub_B432_1-18GHz_3M_1116 - VERTICAL	Power : DC 3.7V
EUT : Module	Note : Mode 1: WCDMA Band 4_Link mode_ CH:1413

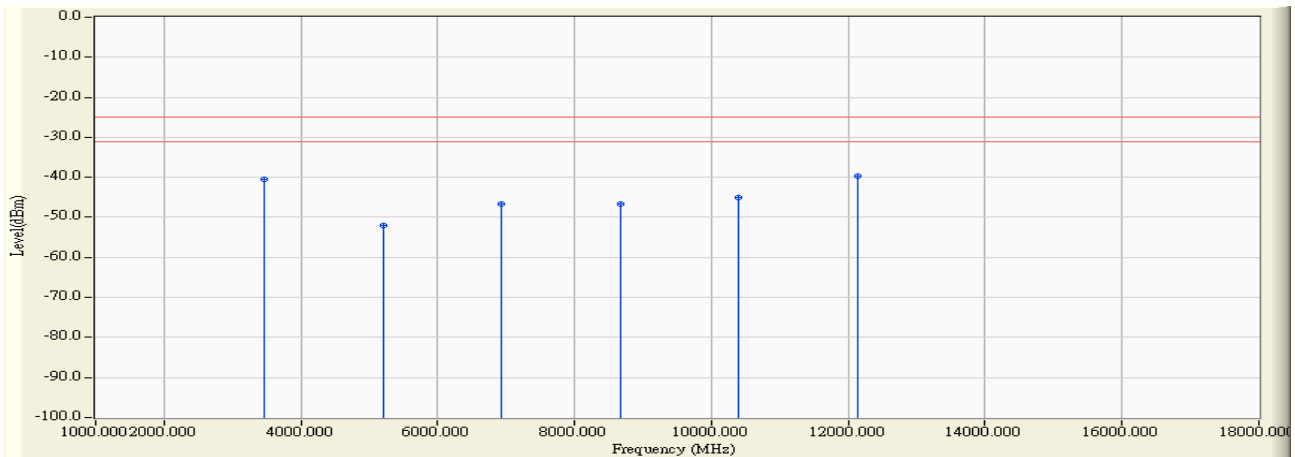

	Frequency (MHz)	Correct Factor (dB)	Reading Level (dBm)	Measure Level (dBm)	Margin (dB)	Limit (dBm)	Detector Type
1	3465.200	12.232	-52.740	-40.507	-15.507	-25.000	PEAK
2	5197.800	12.831	-64.930	-52.099	-27.099	-25.000	PEAK
3	6930.400	17.366	-63.900	-46.534	-21.534	-25.000	PEAK
4	8663.000	21.930	-68.560	-46.631	-21.631	-25.000	PEAK
5	10395.600	23.804	-68.930	-45.126	-20.126	-25.000	PEAK
6	* 12128.200	28.701	-68.490	-39.790	-14.790	-25.000	PEAK

Note:

1. All readings above 1GHz are performed with peak and/or average measurements as necessary.
2. Peak measurements: RBW = 1MHz, VBW = 1MHz, Sweep: Auto.
3. Average measurements: RBW = 1MHz, VBW = 10 Hz, Sweep: Auto.
4. “ * ”, means this data is the worst emission level.
5. Measurement Level = Reading Level + Correct Factor.
6. The average measurement was not performed when the peak measured data under the limit of average detection.
7. The Emission above 18GHz were not included is because their levels are too low.

Site : CB4-H	Time : 2016/12/01 - 18:48
Limit : FCC_Part27(outband)_00M_PK	Margin : 6
Probe : CB4-H_CE_Sub_B432_1-18GHz_3M_1116 - HORIZONTAL	Power : DC 3.7V
EUT : Module	Note : Mode 1: WCDMA Band 4_Link mode_ CH:1513

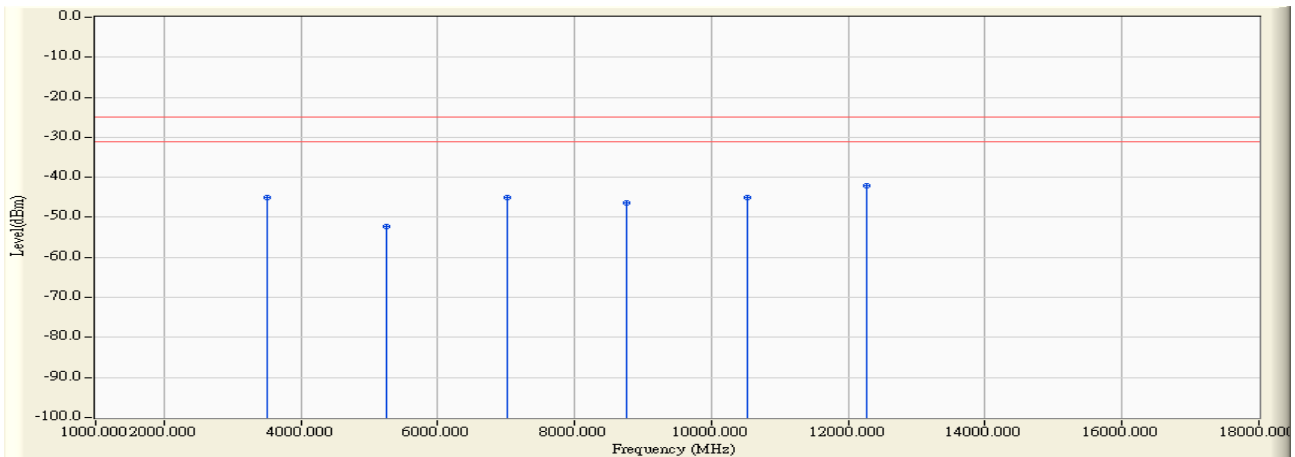

	Frequency (MHz)	Correct Factor (dB)	Reading Level (dBm)	Measure Level (dBm)	Margin (dB)	Limit (dBm)	Detector Type
1	3505.200	11.525	-56.460	-44.934	-19.934	-25.000	PEAK
2	5257.800	13.147	-65.540	-52.394	-27.394	-25.000	PEAK
3	7010.400	19.065	-64.090	-45.025	-20.025	-25.000	PEAK
4	8763.000	21.982	-68.490	-46.509	-21.509	-25.000	PEAK
5	10515.600	24.385	-69.540	-45.155	-20.155	-25.000	PEAK
6	* 12268.200	27.614	-69.630	-42.016	-17.016	-25.000	PEAK

Note:

1. All readings above 1GHz are performed with peak and/or average measurements as necessary.
2. Peak measurements: RBW = 1MHz, VBW = 1MHz, Sweep: Auto.
3. Average measurements: RBW = 1MHz, VBW = 10 Hz, Sweep: Auto.
4. “ * ”, means this data is the worst emission level.
5. Measurement Level = Reading Level + Correct Factor.
6. The average measurement was not performed when the peak measured data under the limit of average detection.
7. The Emission above 18GHz were not included is because their levels are too low.

Site : CB4-H	Time : 2016/12/01 - 18:56
Limit : FCC_Part27(outband)_00M_PK	Margin : 6
Probe : CB4-H_CE_Sub_B432_1-18GHz_3M_1116 - VERTICAL	Power : DC 3.7V
EUT : Module	Note : Mode 1: WCDMA Band 4_Link mode_ CH:1513

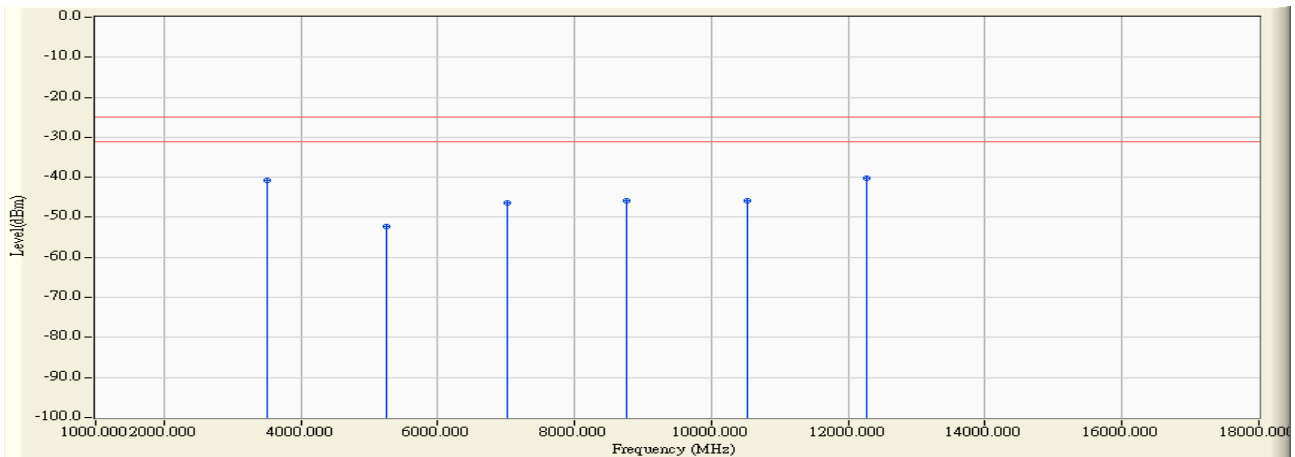

	Frequency (MHz)	Correct Factor (dB)	Reading Level (dBm)	Measure Level (dBm)	Margin (dB)	Limit (dBm)	Detector Type
1	3505.200	12.348	-53.040	-40.691	-15.691	-25.000	PEAK
2	5257.800	12.890	-65.120	-52.230	-27.230	-25.000	PEAK
3	7014.400	17.547	-63.860	-46.312	-21.312	-25.000	PEAK
4	8763.000	22.460	-68.330	-45.870	-20.870	-25.000	PEAK
5	10515.600	23.605	-69.320	-45.715	-20.715	-25.000	PEAK
6	* 12268.200	29.198	-69.470	-40.272	-15.272	-25.000	PEAK

Note:

1. All readings above 1GHz are performed with peak and/or average measurements as necessary.
2. Peak measurements: RBW = 1MHz, VBW = 1MHz, Sweep: Auto.
3. Average measurements: RBW = 1MHz, VBW = 10 Hz, Sweep: Auto.
4. " * ", means this data is the worst emission level.
5. Measurement Level = Reading Level + Correct Factor.
6. The average measurement was not performed when the peak measured data under the limit of average detection.
7. The Emission above 18GHz were not included is because their levels are too low.

Site : CB4-H	Time : 2016/12/01 - 18:08
Limit : FCC_Part27(outband)_00M_PK	Margin : 6
Probe : CB4-H_CE_Sub_B432_1-18GHz_3M_1116 - HORIZONTAL	Power : DC 3.7V
EUT : Module	Note : Mode 2: WCDMA Band 4_Idle mode_ CH:1312

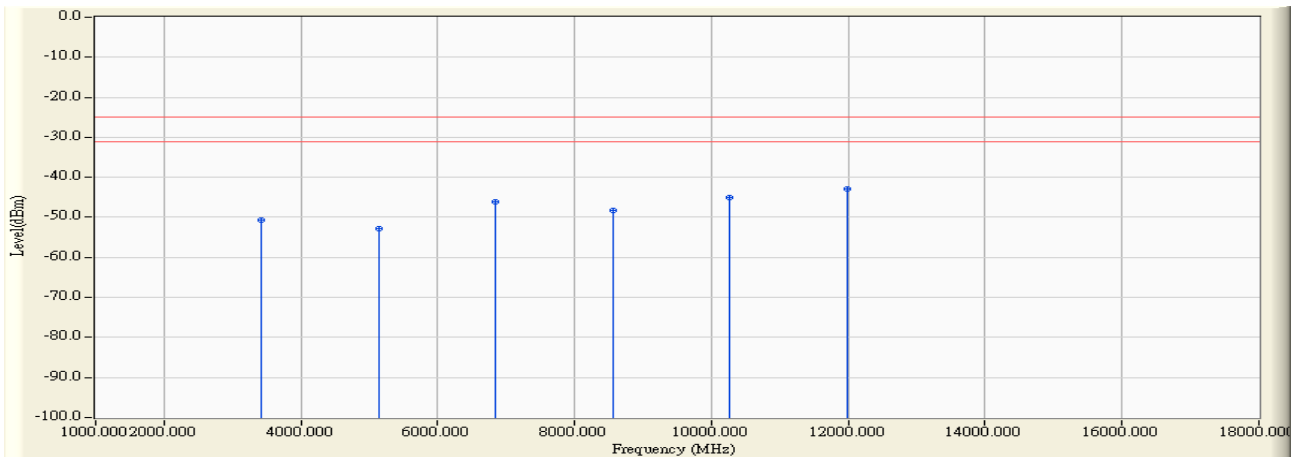

	Frequency (MHz)	Correct Factor (dB)	Reading Level (dBm)	Measure Level (dBm)	Margin (dB)	Limit (dBm)	Detector Type
1	3424.000	11.375	-62.030	-50.655	-25.655	-25.000	PEAK
2	5136.000	13.087	-65.980	-52.892	-27.892	-25.000	PEAK
3	6848.000	18.476	-64.490	-46.014	-21.014	-25.000	PEAK
4	8560.000	21.261	-69.650	-48.389	-23.389	-25.000	PEAK
5	10272.000	24.125	-69.130	-45.005	-20.005	-25.000	PEAK
6	* 11984.000	26.779	-69.550	-42.771	-17.771	-25.000	PEAK

Note:

1. All readings above 1GHz are performed with peak and/or average measurements as necessary.
2. Peak measurements: RBW = 1MHz, VBW = 1MHz, Sweep: Auto.
3. Average measurements: RBW = 1MHz, VBW = 10 Hz, Sweep: Auto.
4. “ * ”, means this data is the worst emission level.
5. Measurement Level = Reading Level + Correct Factor.
6. The average measurement was not performed when the peak measured data under the limit of average detection.
7. The Emission above 18GHz were not included is because their levels are too low.

Site : CB4-H	Time : 2016/12/01 - 18:06
Limit : FCC_Part27(outband)_00M_PK	Margin : 6
Probe : CB4-H_CE_Sub_B432_1-18GHz_3M_1116 - VERTICAL	Power : DC 3.7V
EUT : Module	Note : Mode 2: WCDMA Band 4_Idle mode_ CH:1312

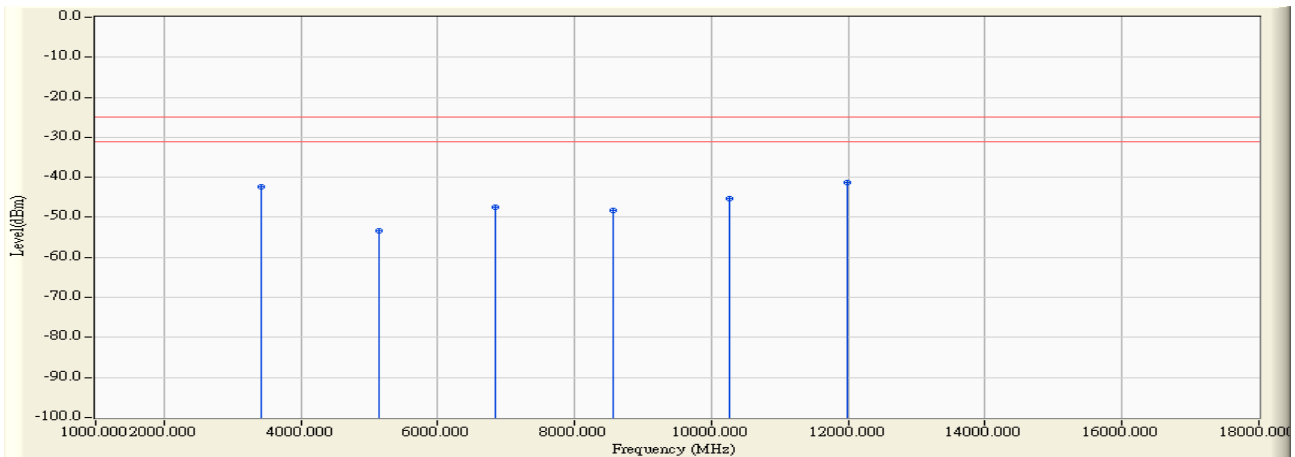

	Frequency (MHz)	Correct Factor (dB)	Reading Level (dBm)	Measure Level (dBm)	Margin (dB)	Limit (dBm)	Detector Type
1	3424.000	12.108	-54.380	-42.272	-17.272	-25.000	PEAK
2	5136.000	12.777	-66.180	-53.402	-28.402	-25.000	PEAK
3	6848.000	17.228	-64.560	-47.332	-22.332	-25.000	PEAK
4	8560.000	21.370	-69.560	-48.189	-23.189	-25.000	PEAK
5	10272.000	24.063	-69.430	-45.367	-20.367	-25.000	PEAK
6	* 11984.000	28.183	-69.420	-41.238	-16.238	-25.000	PEAK

Note:

1. All readings above 1GHz are performed with peak and/or average measurements as necessary.
2. Peak measurements: RBW = 1MHz, VBW = 1MHz, Sweep: Auto.
3. Average measurements: RBW = 1MHz, VBW = 10 Hz, Sweep: Auto.
4. “ * ”, means this data is the worst emission level.
5. Measurement Level = Reading Level + Correct Factor.
6. The average measurement was not performed when the peak measured data under the limit of average detection.
7. The Emission above 18GHz were not included is because their levels are too low.

Site : CB4-H	Time : 2016/12/01 - 18:36
Limit : FCC_Part27(outband)_00M_PK	Margin : 6
Probe : CB4-H_CE_Sub_B432_1-18GHz_3M_1116 - HORIZONTAL	Power : DC 3.7V
EUT : Module	Note : Mode 2: WCDMA Band 4_Idle mode_ CH:1413

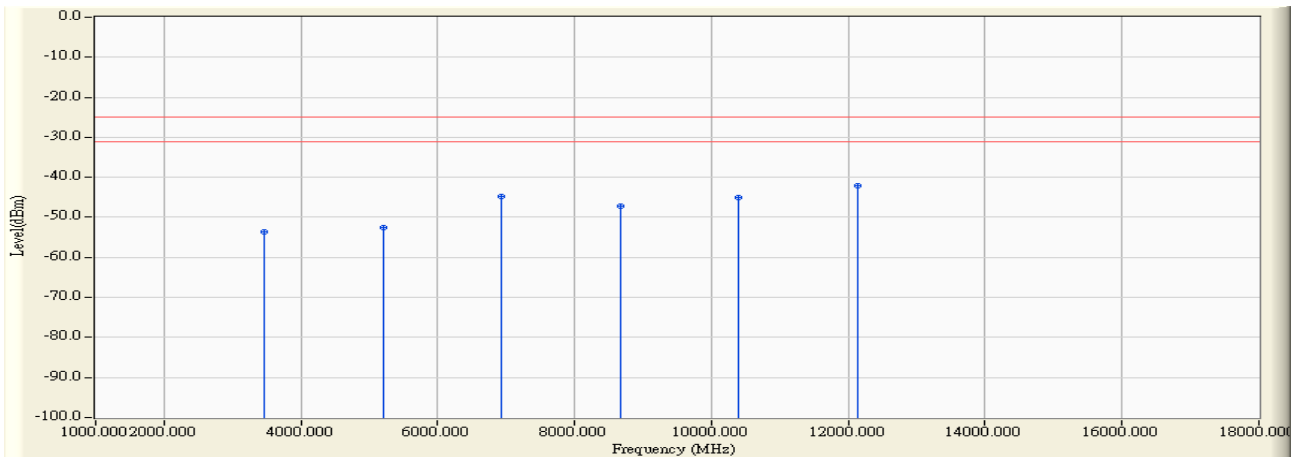

	Frequency (MHz)	Correct Factor (dB)	Reading Level (dBm)	Measure Level (dBm)	Margin (dB)	Limit (dBm)	Detector Type
1	3465.200	11.450	-65.010	-53.560	-28.560	-25.000	PEAK
2	5197.800	13.114	-65.750	-52.636	-27.636	-25.000	PEAK
3	6930.400	18.788	-63.630	-44.841	-19.841	-25.000	PEAK
4	8663.000	21.633	-68.760	-47.127	-22.127	-25.000	PEAK
5	10395.600	24.245	-69.160	-44.916	-19.916	-25.000	PEAK
6	* 12128.200	27.186	-69.380	-42.194	-17.194	-25.000	PEAK

Note:

1. All readings above 1GHz are performed with peak and/or average measurements as necessary.
2. Peak measurements: RBW = 1MHz, VBW = 1MHz, Sweep: Auto.
3. Average measurements: RBW = 1MHz, VBW = 10 Hz, Sweep: Auto.
4. “ * ”, means this data is the worst emission level.
5. Measurement Level = Reading Level + Correct Factor.
6. The average measurement was not performed when the peak measured data under the limit of average detection.
7. The Emission above 18GHz were not included is because their levels are too low.

Site : CB4-H	Time : 2016/12/01 - 18:31
Limit : FCC_Part27(outband)_00M_PK	Margin : 6
Probe : CB4-H_CE_Sub_B432_1-18GHz_3M_1116 - VERTICAL	Power : DC 3.7V
EUT : Module	Note : Mode 2: WCDMA Band 4_Idle mode_ CH:1413

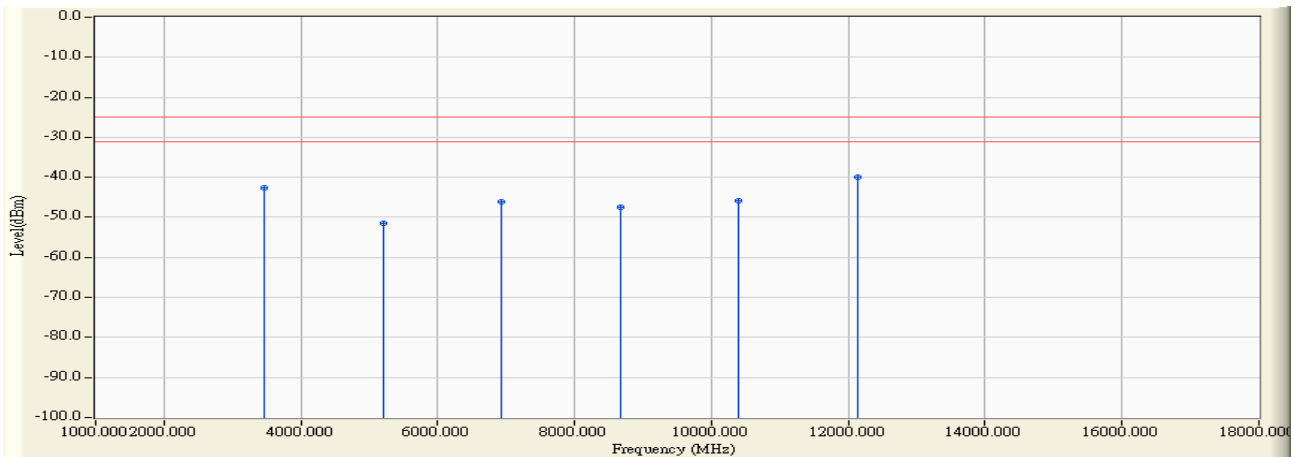

	Frequency (MHz)	Correct Factor (dB)	Reading Level (dBm)	Measure Level (dBm)	Margin (dB)	Limit (dBm)	Detector Type
1	3465.200	12.232	-54.810	-42.577	-17.577	-25.000	PEAK
2	5197.800	12.831	-64.410	-51.579	-26.579	-25.000	PEAK
3	6930.400	17.366	-63.530	-46.164	-21.164	-25.000	PEAK
4	8663.000	21.930	-69.400	-47.471	-22.471	-25.000	PEAK
5	10395.600	23.804	-69.640	-45.836	-20.836	-25.000	PEAK
6	* 12128.200	28.701	-68.720	-40.020	-15.020	-25.000	PEAK

Note:

1. All readings above 1GHz are performed with peak and/or average measurements as necessary.
2. Peak measurements: RBW = 1MHz, VBW = 1MHz, Sweep: Auto.
3. Average measurements: RBW = 1MHz, VBW = 10 Hz, Sweep: Auto.
4. “ * ”, means this data is the worst emission level.
5. Measurement Level = Reading Level + Correct Factor.
6. The average measurement was not performed when the peak measured data under the limit of average detection.
7. The Emission above 18GHz were not included is because their levels are too low.

Site : CB4-H	Time : 2016/12/01 - 19:03
Limit : FCC_Part27(outband)_00M_PK	Margin : 6
Probe : CB4-H_CE_Sub_B432_1-18GHz_3M_1116 - HORIZONTAL	Power : DC 3.7V
EUT : Module	Note : Mode 2: WCDMA Band 4_Idle mode_ CH:1513

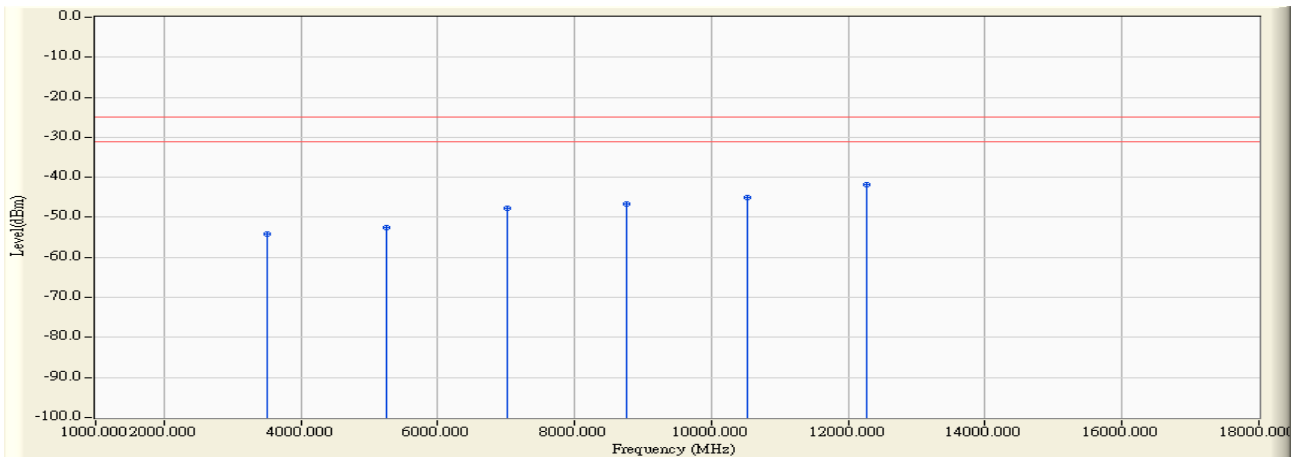

	Frequency (MHz)	Correct Factor (dB)	Reading Level (dBm)	Measure Level (dBm)	Margin (dB)	Limit (dBm)	Detector Type
1	3505.200	11.525	-65.700	-54.174	-29.174	-25.000	PEAK
2	5257.800	13.147	-65.640	-52.494	-27.494	-25.000	PEAK
3	7010.400	19.065	-66.730	-47.665	-22.665	-25.000	PEAK
4	8763.000	21.982	-68.640	-46.659	-21.659	-25.000	PEAK
5	10515.600	24.385	-69.410	-45.025	-20.025	-25.000	PEAK
6	* 12268.200	27.614	-69.510	-41.896	-16.896	-25.000	PEAK

Note:

1. All readings above 1GHz are performed with peak and/or average measurements as necessary.
2. Peak measurements: RBW = 1MHz, VBW = 1MHz, Sweep: Auto.
3. Average measurements: RBW = 1MHz, VBW = 10 Hz, Sweep: Auto.
4. “ * ”, means this data is the worst emission level.
5. Measurement Level = Reading Level + Correct Factor.
6. The average measurement was not performed when the peak measured data under the limit of average detection.
7. The Emission above 18GHz were not included is because their levels are too low.

Site : CB4-H	Time : 2016/12/01 - 19:00
Limit : FCC_Part27(outband)_00M_PK	Margin : 6
Probe : CB4-H_CE_Sub_B432_1-18GHz_3M_1116 - VERTICAL	Power : DC 3.7V
EUT : Module	Note : Mode 2: WCDMA Band 4_Idle mode_ CH:1513

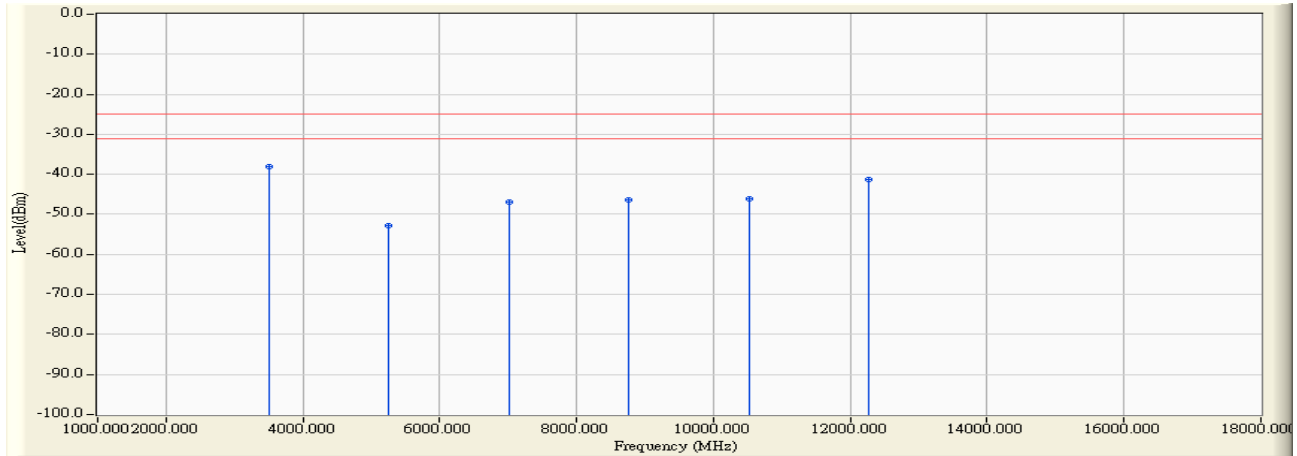

		Frequency (MHz)	Correct Factor (dB)	Reading Level (dBm)	Measure Level (dBm)	Margin (dB)	Limit (dBm)	Detector Type
1	*	3505.200	12.348	-50.550	-38.201	-13.201	-25.000	PEAK
2		5257.800	12.890	-65.610	-52.720	-27.720	-25.000	PEAK
3		7010.400	17.530	-64.370	-46.840	-21.840	-25.000	PEAK
4		8763.000	22.460	-68.820	-46.360	-21.360	-25.000	PEAK
5		10515.600	23.605	-69.660	-46.055	-21.055	-25.000	PEAK
6		12268.200	29.198	-70.490	-41.292	-16.292	-25.000	PEAK

Note:

1. All readings above 1GHz are performed with peak and/or average measurements as necessary.
2. Peak measurements: RBW = 1MHz, VBW = 1MHz, Sweep: Auto.
3. Average measurements: RBW = 1MHz, VBW = 10 Hz, Sweep: Auto.
4. “ * ”, means this data is the worst emission level.
5. Measurement Level = Reading Level + Correct Factor.
6. The average measurement was not performed when the peak measured data under the limit of average detection.
7. The Emission above 18GHz were not included is because their levels are too low.

8. Frequency Stability Over Temperatures Variation

8.1. Test Equipment

The following test equipments are used during the test:

Frequency Stability Over Temperatures Variation / SR10-H

Instrument	Manufacturer	Model No.	Serial No	Next Cal. Date
Signal & Spectrum Analyzer	R&S	FSV40	101049	2016/01/19
Temperature & Humidity Chamber	WIT	TH-1S-B	1082101	2016/01/22

Note: All equipments that need to calibrate are with calibration period of 1 year.

8.2. Test Setup

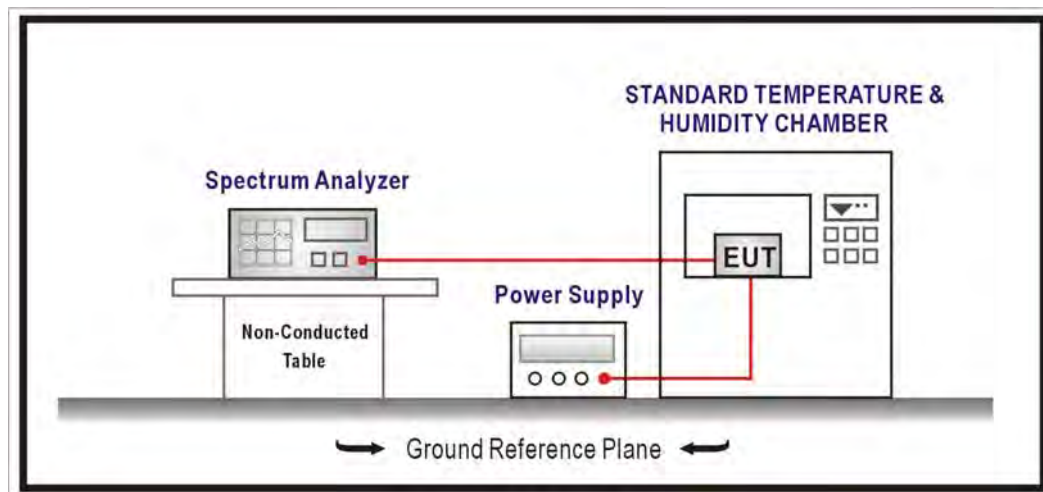

8.3. Limits

The frequency stability shall be measured with variation of ambient temperature as follows: From -30° to $+50^{\circ}$ centigrade for all equipment. Frequency measurements shall be made at the extremes of the specified temperature range and at intervals of not more than 10° centigrade through the range.

8.4. Test Procedure

Power must be turned off when changing from one temperature to another. Power warm up is at least 15 min and power applied should perform before recording frequency error. The temperature range step is 10 degrees in this test items. All temperature levels shall be holding the $\pm 0.5^{\circ}\text{C}$ during the measurement testing. The each temperature step shall be at least 0.5 hours, consider the EUT could be test under the stability condition.

8.5. Uncertainty

The measurement uncertainty is defined as $\pm 100\text{KHz}$

8.6. Test Result

Product	Module		
Test Item	Frequency Stability Over Temperatures Variation		
Test Mode	Mode 1: WCDMA Band 4_Link mode		
Date of Test	2016/12/06	Test Site	SR10-H

1712.4 MHz

Frequency Error Over Temperatures		
Temp. (°C)	Frequency (MHz)	Frequency Error (ppm)
-30	-10	0.0059
-20	-11	0.0063
-10	-10	0.0061
0	-17	0.0099
+10	-9	0.0055
+20	8	-0.0046
+30	-11	0.0065
+40	16	-0.0095
+50	18	-0.0104

1732.6 MHz

Frequency Error Over Temperatures		
Temp. (°C)	Frequency (MHz)	Frequency Error (ppm)
-30	-10	0.0059
-20	13	-0.0078
-10	-9	0.0051
0	-8	0.0046
+10	-11	0.0061
+20	-7	0.0042
+30	-20	0.0118
+40	-6	0.0037
+50	-6	0.0036

1752.6 MHz

Frequency Error Over Temperatures		
Temp. ($^{\circ}C$)	Frequency (MHz)	Frequency Error (ppm)
-30	12	-0.0067
-20	11	-0.0065
-10	10	-0.0058
0	11	-0.0062
+10	8	-0.0047
+20	-5	0.0028
+30	-14	0.0077
+40	-20	0.0117
+50	-20	0.0112

9. Frequency Stability Over Voltage Variation

9.1. Test Equipment

The following test equipments are used during the test:

Frequency Stability Over Voltage Variation / SR10-H

Instrument	Manufacturer	Model No.	Serial No	Next Cal. Date
Signal & Spectrum Analyzer	R&S	FSV40	101049	2016/01/19
Temperature & Humidity Chamber	WIT	TH-1S-B	1082101	2016/01/22

Note: All equipments that need to calibrate are with calibration period of 1 year.

9.2. Test Setup

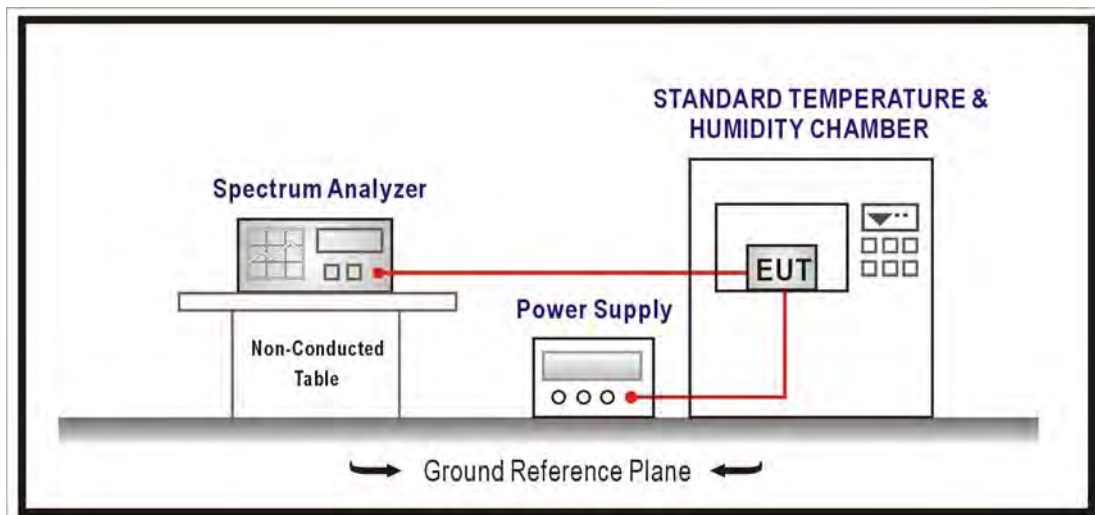

9.3. Limits

The frequency stability shall be measured with variation of primary supply voltage as follows:

- (1) Vary primary supply voltage from 85 to 115 percent of the nominal value for other than hand carried battery equipment.
- (2) For hand carried, battery powered equipment, reduce primary supply voltage to the battery operating end point which shall be specified by the manufacturer.
- (3) The supply voltage shall be measured at the input to the cable normally provided with the equipment, or at the power supply terminals if cables are not normally provided. Effects on frequency of transmitter keying (except for broadcast transmitters) and any heating element cycling at the nominal supply voltage and at each extreme also shall be shown.

9.4. Test Procedure

Power must be removed when changing from one voltage to another voltage. Power warm up is at least 15 min and power applied should perform before recording frequency error.

EUT is connected the external power supply to control the DC input power. The various Volts set from the minimum 4.5 Volts to 5.5 Volts. Each step shall be record the frequency error rate.

9.5. Uncertainty

The measurement uncertainty is defined as $\pm 100\text{KHz}$.

9.6. Test Result

Product	Module		
Test Item	Frequency Stability Over Voltage Variation		
Test Mode	Mode 1: WCDMA Band 4_Link mode		
Date of Test	2016/12/06	Test Site	SR10-H

1712.4 MHz

Frequency Error Over Voltage		
Voltage (Volts)	Frequency (MHz)	Frequency Error (ppm)
4.2	-13	0.0076
3.7	-11	0.0065
3.4	-13	0.0076

1712.4 MHz

Frequency Error Over Voltage		
Voltage (Volts)	Frequency (MHz)	Frequency Error (ppm)
4.2	-21	0.0121
3.7	-20	0.0118
3.4	-21	0.0121

1712.4 MHz

Frequency Error Over Voltage		
Voltage (Volts)	Frequency (MHz)	Frequency Error (ppm)
4.2	-15	0.0086
3.7	-14	0.0077
3.4	-15	0.0086