

# FCC Part22H&24E Test Report

Product Name : Wireless Module  
Model No. : AR7558  
FCC ID : N7NAR7558  
IC : 2417C-AR7558

Applicant : Sierra Wireless Inc.  
Address : 13811 Wireless Way Richmond, British Columbia,  
Canada, V6V 3A4.

Date of Receipt : Jan. 14, 2015  
Test Date : Jan. 14, 2015~ Feb. 02, 2015  
Issued Date : Mar. 16, 2015  
Report No. : 1510280R-HP-US-P07V02  
Report Version : V 1.1



The test results relate only to the samples tested.

The test results shown in the test report are traceable to the national/international standard through the calibration of the equipment and evaluated measurement uncertainty herein.

This report must not be used to claim product endorsement by TAF or any agency of the government.

The test report shall not be reproduced without the written approval of QuieTek Corporation.

## Test Report Certification

Issued Date : Mar. 16, 2015

Report No. : 1510280R-HP-US-P07V02



Product Name : Wireless Module  
Applicant : Sierra Wireless Inc.  
Address : 13811 Wireless Way Richmond, British Columbia, Canada,  
V6V 3A4.  
Manufacturer : Sierra Wireless Inc.  
Address : 13811 Wireless Way Richmond, British Columbia, Canada,  
V6V 3A4.  
Model No. : AR7558  
FCC ID : N7NAR7558  
IC : 2417C-AR7558  
EUT Voltage : Low: 3.4V, High: 4.2V, Normal: 3.7V  
Brand Name : AirPrime  
Applicable Standard : FCC CFR Title 47 Part 2, TIA/EIA 603-C  
FCC Part22 Subpart H, FCC Part24 Subpart E  
Industry Canada RSS-132, Issue 3  
Industry Canada RSS-133, Issue 6  
Test Result : Complied  
Performed Location : Suzhou EMC Laboratory  
No.99 Hongye Rd., Suzhou Industrial Park Loufeng Hi-Tech  
Development Zone., Suzhou, China  
TEL: +86-512-6251-5088 / FAX: +86-512-6251-5098  
FCC Registration Number: 800392; IC Lab Code: 4075B

Documented By : Alice Ni  
Reviewed By : Dream Cao  
Approved By : Jeff Chen

**Laboratory Information**

We, **QuietTek Corporation**, are an independent EMC and safety consultancy that was established the whole facility in our laboratories. The test facility has been accredited/accepted(audited or listed) by the following related bodies in compliance with ISO 17025, EN 45001 and specified testing scope:

<b>Taiwan R.O.C.</b>	<b>:</b>	<b>BSMI, NCC, TAF</b>
<b>Germany</b>	<b>:</b>	<b>TUV Rheinland</b>
<b>Norway</b>	<b>:</b>	<b>Nemko, DNV</b>
<b>USA</b>	<b>:</b>	<b>FCC</b>
<b>Japan</b>	<b>:</b>	<b>VCCI</b>

The related certificate for our laboratories about the test site and management system can be downloaded from QuietTek Corporation's Web Site :<http://www.quietek.com/tw/ctg/cts/accreditations.htm>

The address and introduction of QuietTek Corporation's laboratories can be founded in our Web site :  
<http://www.quietek.com/>

If you have any comments, Please don't hesitate to contact us. Our contact information is as below:

**HsinChu Testing Laboratory :**

No.75-2, 3rd Lin, Wangye Keng, Yonghxing Tsuen, Qionglin Shiang, Hsinchu County 307, Taiwan, R.O.C.  
TEL:+886-3-592-8858 / FAX:+886-3-592-8859                      E-Mail : [service@quietek.com](mailto:service@quietek.com)

**LinKou Testing Laboratory :**

No.5-22, Ruishukeng, Linkou Dist., New Taipei City 24451, Taiwan, R.O.C.  
TEL : 886-2-8601-3788 / FAX : 886-2-8601-3789                      E-Mail : [service@quietek.com](mailto:service@quietek.com)

**Suzhou Testing Laboratory :**

No.99 Hongye Rd., Suzhou Industrial Park Loufeng Hi-Tech Development Zone., SuZhou, China  
TEL : +86-512-6251-5088 / FAX : 86-512-6251-5098                      E-Mail : [service@quietek.com](mailto:service@quietek.com)

**TABLE OF CONTENTS**

Description	Page
1. General Information.....	7
1.1. EUT Description .....	7
1.2. Mode of Operation.....	9
1.3. Tested System Details .....	10
1.4. Configuration of Tested System.....	11
1.5. EUT Exercise Software.....	12
2. Technical Test .....	13
2.1. Summary of Test Result.....	13
2.2. Test Environment.....	15
3. Maximum Output Power and Effective Isotropic Radiated Power Measurement.....	16
3.1. Test Equipment.....	16
3.2. Test Setup.....	17
3.3. Test Procedure .....	17
3.4. Uncertainty .....	19
3.5. Test Result.....	20
4. Modulation Characteristic .....	24
4.1. Test Equipment.....	24
4.2. Test Setup.....	24
4.3. Uncertainty .....	24
4.4. Test Result.....	24
5. Occupied Bandwidth.....	25
5.1. Test Equipment.....	25
5.2. Test Setup.....	25
5.3. Test Procedure .....	25
5.4. Uncertainty .....	25
5.5. Test Result.....	26
6. Conducted Band Edge .....	38
6.1. Test Equipment.....	38
6.2. Test Setup.....	38
6.3. Test Procedure .....	38
6.4. Uncertainty .....	39
6.5. Test Result.....	40
7. Spurious Emission .....	46
7.1. Test Equipment.....	46
7.2. Test Setup.....	47
7.3. Test Procedure .....	49

7.4. Uncertainty .....	49
7.5. Test Result.....	50
8. Frequency Stability Under Temperature & Voltage Variations.....	74
8.1. Test Equipment.....	74
8.2. Test Setup.....	74
8.3. Test Procedure .....	75
8.4. Uncertainty .....	75
8.5. Test Result.....	76

**History of This Test Report**

REPORT NO.	VERSION	DESCRIPTION	ISSUED DATE
1510280R-HP-US-P07V02	V1.0	Initial Issued Report Mod	Feb. 03, 2015
1510280R-HP-US-P07V02	V1.1	Modified the description of GPRS and EDGE test mode.	Mar. 16, 2015

**1. General Information**

**1.1. EUT Description**

Product Name	Wireless Module
Model No.	AR7558
Brand Name	AirPrime
EUT Voltage	Low: 3.4V, High: 4.2V, Normal: 3.7V
<b>2G</b>	
Support Band	GSM850/PCS1900
GPRS Class	Class 12
Uplink	GSM 850: 824~849MHz PCS 1900: 1850~1910MHz
Downlink	GSM 850: 869~894MHz PCS 1900: 1930~1990MHz
Type of modulation	GMSK for GPRS; 8PSK for EDGE
Antenna Type	Dipole
Antenna Gain	GSM 850: 1.2dBi PCS1900: 1.3dBi
<b>CDMA</b>	
Support Band	BC0/BC1
Uplink	BC0: 824~849MHz BC1: 1850~1910MHz
Downlink	BC0: 869~894MHz BC1: 1930~1990MHz
Type of Modulation	QPSK
Antenna Type	Dipole
Peak Antenna Gain	BC0: 1.2dBi BC1: 1.3dBi
<b>3G</b>	
Support Band	WCDMA Band 2/WCDMA Band 5
Uplink	WCDMA Band 2: 1850~1910MHz WCDMA Band 5: 824~849MHz
Downlink	WCDMA Band 2: 1930~1990MHz WCDMA Band 5: 869~894MHz
Type of modulation	QPSK for Uplink
Antenna Type	Dipole

Antenna Gain	Band 2: 1.3dBi Band 5: 1.2dBi
<b>1XEVDO</b>	
Support Band	BC0/BC1
Uplink	BC0: 824~849MHz BC1: 1850~1910MHz
Downlink	BC0: 869~894MHz BC1: 1930~1990MHz
Release Version	Rel-A
Type of Modulation	QPSK
Antenna Type	Dipole
Peak Antenna Gain	BC0: 1.2dBi BC1: 1.3dBi
<b>4G</b>	
Support Band	LTE Band 4/25/26/41
Uplink	Band 4: 1710~1755MHz Band 25: 1850~1915MHz Band 26: 814~849MHz Band 41: 2496~2690MHz
Downlink	Band 4: 2110~2155MHz Band 25: 1930~1995MHz Band 26: 859~894MHz Band 41: 2496~2690MHz
Type of modulation	QPSK, 16QAM
Antenna Type	Dipole
Antenna Gain	Band 4: 1.3dBi Band 25: 1.3dBi Band 26: 1.2dBi Band 41: 4.2dBi



**1.2. Mode of Operation**

QuieTek has verified the construction and function in typical operation. All the test modes were carried out with the EUT in normal operation, which was shown in this test report and defined as:

Test Mode
Mode 1: GSM 850 Link
Mode 2: PCS 1900 Link
Mode 3: EDGE 850 Link
Mode 4: EDGE 1900 Link
Mode 5: WCDMA Band II Link
Mode 6: WCDMA Band V Link

Note:

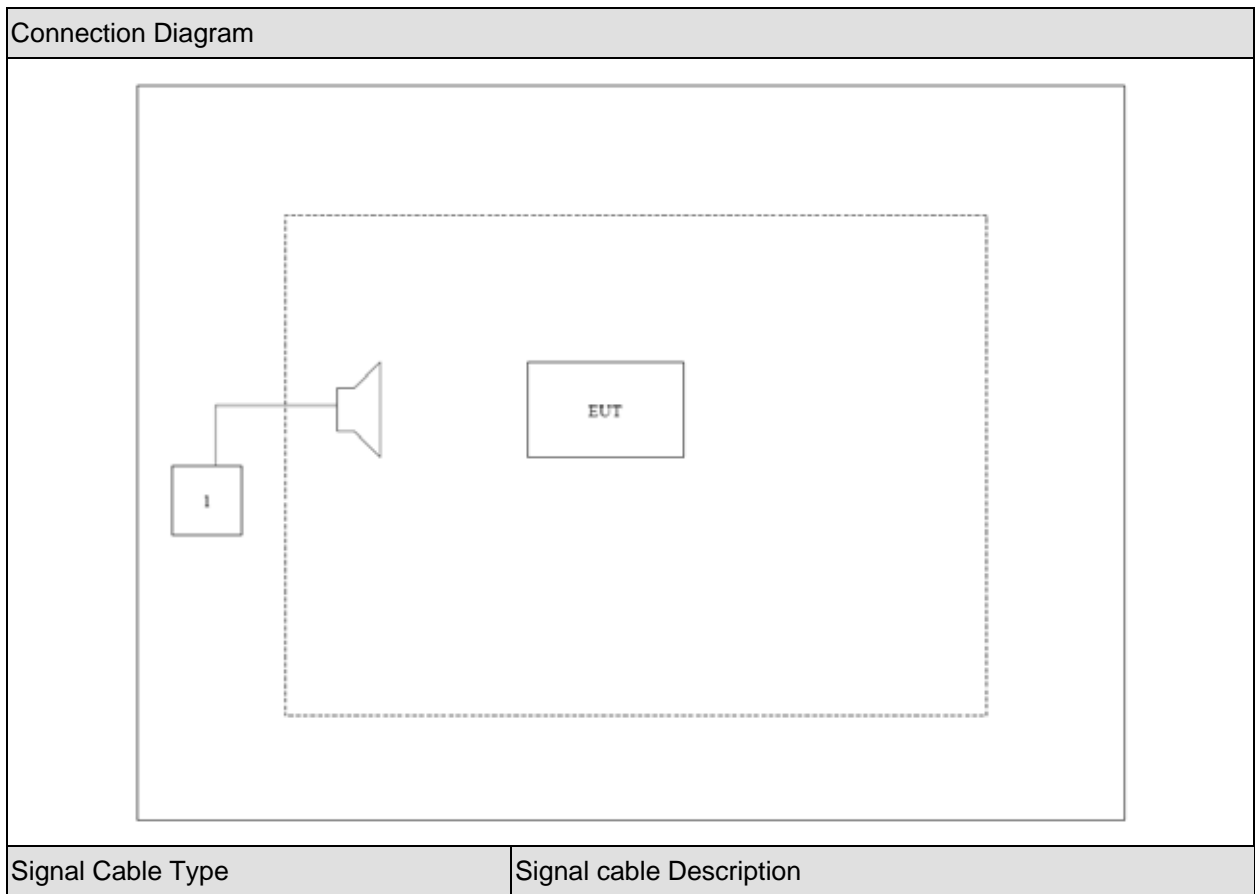
1. Regards to the frequency band operation: the lowest, middle and highest frequency of channel were selected to perform the test, then shown on this report.
2. For the ERP/EIRP and radiated emission test, every axis (X, Y, Z) was verified, and show the worst result on this report.
3. The maximum power level of GSM or GPRS mode for GMSK link, EDGE mode for 8PSK link, (The maximum power of GPRS and EDGE of all multi-slot modes are GPRS-1slot and EDGE-1slot.) RMC 12.2Kbps Mode for WCDMA band V & II, only these modes were used for all tests.

**1.3. Tested System Details**

The types for all equipments, plus descriptions of all cables used in the tested system (including inserted cards) are:

	Product	Manufacturer	Model No.	Serial No.	Power Cord
1	Radio Communication Tester	R&S	CMU 200	106388	N/A

### 1.4. Configuration of Tested System



## 1.5. EUT Exercise Software

1	Setup the EUT and simulators as shown on above.
2	Turn on the power of all equipment.
3	EUT Communicate with CMU200, then select channel to test.

**2. Technical Test**

**2.1. Summary of Test Result**

- No deviations from the test standards
- Deviations from the test standards as below description:

**For GSM 850/EDGE850/WCDMA Band V**

**(FCC Part 22 Subpart H, Industry Canada RSS-132, Issue 3, Industry Canada RSS-GEN )**

Performed Item	FCC Rule	IC Rule	Limit	Result
Maximum Output Power	§2.1033 §2.1046 §22.913	§5.4	< 7 Watts	Pass
Equivalent Isotropic Radiated Power	§22.913	§5.4	< 7 Watts	Pass
Modulation characteristics	§2.1047	§5.2	N/A	Pass
Occupied Bandwidth	§2.1049	RSS-GEN §4.2	N/A	Pass
Conducted Band Edge Emissions	§22.917	§5.5	< -13dBm	Pass
Field Strength of Spurious Radiation	§2.1053 §§22.917	§5.5	< -13dBm	Pass
Frequency Stability Under Temperature & Voltage Variations	§2.1055 §22.335	§5.3	< 2.5 ppm	Pass

**For PCS1900/EDGE1900/WCDMA Band II**
**(FCC Part 24 Subpart E, Industry Canada RSS-133, Issue 6, Industry Canada RSS-GEN )**

Performed Item	FCC Rule	IC Rule	Limit	Result
Maximum Output Power	§2.1033 §2.1046 §24.232	§6.4	< 2 Watts	Pass
Equivalent Isotropic Radiated Power	§24.232	§6.4	< 2 Watts	Pass
Modulation characteristics	§2.1047	§6.2	N/A	Pass
Occupied Bandwidth	§2.1049	RSS-GEN §4.2	N/A	Pass
Conducted Band Edge Emissions	§27.238	§6.5	< -13dBm	Pass
Field Strength of Spurious Radiation	§2.1053 §24.238	§6.5	< -13dBm	Pass
Frequency Stability Under Temperature & Voltage Variations	§2.1055 §24.235	§6.3	< 2.5 ppm	Pass

**2.2. Test Environment**

Items	Required (IEC 68-1)	Actual
Temperature (°C)	15-35	23
Humidity (%RH)	25-75	52
Barometric pressure (mbar)	860-1060	950-1000

### 3. Maximum Output Power and Effective Isotropic Radiated Power Measurement

#### 3.1. Test Equipment

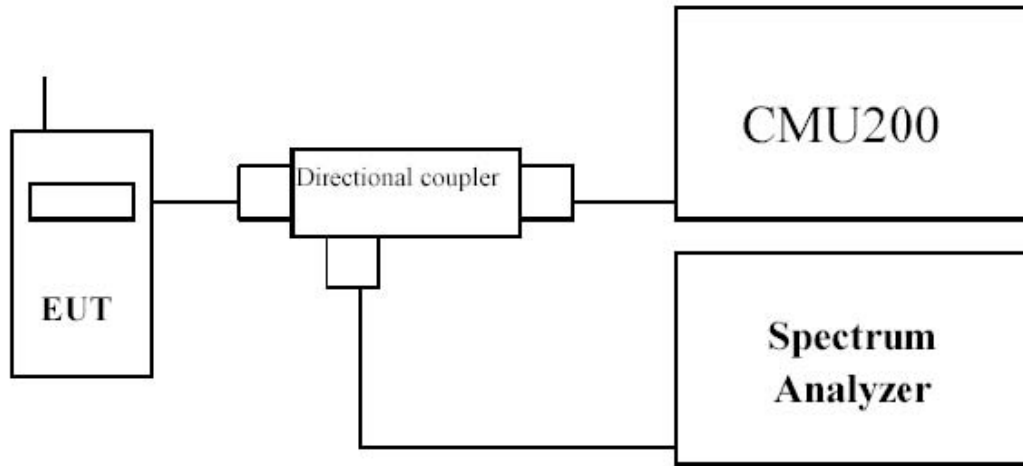
Spurious Emission / AC-5

Instrument	Manufacturer	Type No.	Serial No	Cali. Due Date
PSA Series Spectrum Analyzer	Agilent	E4440A	MY49420184	2015.03.28
Radio Communication Tester	R&S	CMU 200	117088	2015.03.28
Dual Directional Coupler	Agilent	778D	20160	2015.03.28
10dB Coaxial Coupler	Agilent	87300C	MY44300299	2015.03.28
PSG Analog Signal Generator	Agilent	E8257D	MY44321116	2015.03.28
Preamplifier	QuieTek	AP-025C	CHM-0503006	2015.04.11
Preamplifier	Miteq	NSP1800-25	1364185	2015.05.03
Bilog Antenna	Teseq GmbH	CBL6112D	27612	2015.10.15
Half Wave Tuned Dipole Antenna	COM-POWER	AD-100	40137	2016.02.26
Broad-Band Horn Antenna	Schwarzbeck	BBHA9120D	737	2016.02.26
Broad-Band Horn Antenna	Schwarzbeck	BBHA9120D	499	2015.06.08
DRG Horn	ETS-Lindgren	3117	00123988	2016.01.07
Temperature/Humidity Meter	Zhicheng	ZC1-2	AC5-TH	2016.01.07

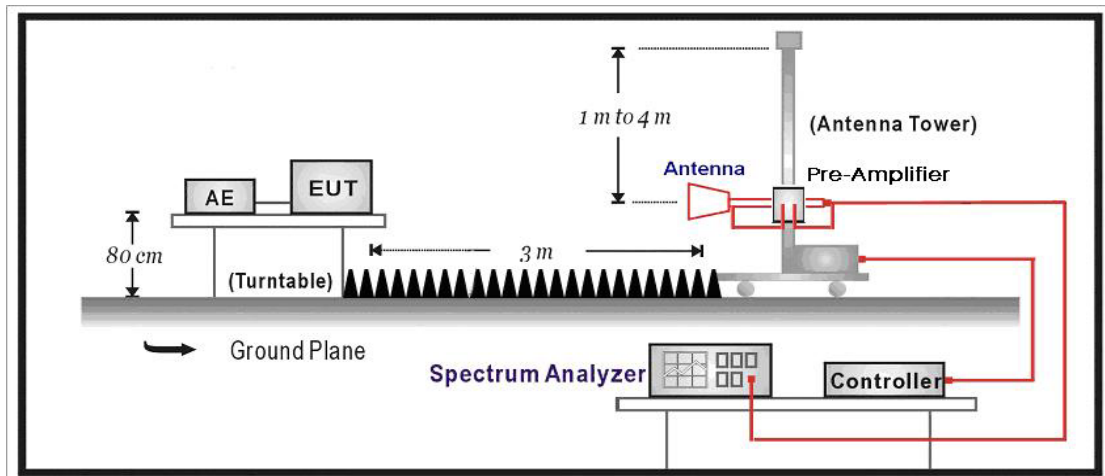


### 3.2. Test Setup

Conducted Power Measurement:



Radiated Power Measurement:



### 3.3. Test Procedure

**For Conducted Power Measurement:**

- a) The RF output of the transmitter was connected to base station simulator.
- b) The RF output of EUT was connected to the spectrum analyzer by RF cable and attenuator. The path loss was compensated to the results for each measurement..
- c) Set EUT at maximum average power by base station simulator.
- d) Measure lowest, middle, and highest channels for each bandwidth and different modulation.

**For Effective Isotropic Radiated Power Measurement:**

**Radiated Power Measurement:**

- a) The EUT shall be placed at the specified height on a support, and in the position closest to normal use as declared by provider.
- b) The test antenna shall be oriented initially for vertical polarization and shall be chosen to correspond to the frequency of the transmitter
- c) The output of the test antenna shall be connected to the measuring receiver.
- d) The transmitter shall be switched on and the measuring receiver shall be tuned to the frequency of the transmitter under test.
- e) The test antenna shall be raised and lowered through the specified range of height until a maximum signal level is detected by the measuring receiver.
- f) The transmitter shall then be rotated through 360° in the horizontal plane, until the maximum signal level is detected by the measuring receiver.
- g) The test antenna shall be raised and lowered again through the specified range of height until a maximum signal level is detected by the measuring receiver.
- h) The maximum signal level detected by the measuring receiver shall be noted.
- i) The transmitter shall be replaced by a substitution antenna.
- j) The substitution antenna shall be orientated for vertical polarization and the length of the substitution antenna shall be adjusted to correspond to the frequency of the transmitter.
- k) The substitution antenna shall be connected to a calibrated signal generator.
- l) If necessary, the input attenuator setting of the measuring receiver shall be adjusted in order to increase the sensitivity of the measuring receiver.
- m) The test antenna shall be raised and lowered through the specified range of height to ensure that the maximum signal is received.
- n) The input signal to the substitution antenna shall be adjusted to the level that produces a level detected by the measuring receiver, that is equal to the level noted while the transmitter radiated power was measured, corrected for the change of input attenuator setting of the measuring receiver.
- o) The measurement shall be repeated with the test antenna and the substitution antenna orientated for horizontal polarization.
- p) The measure of the effective radiated power is the larger of the two levels recorded at the input to the substitution antenna, corrected for gain of the substitution antenna if necessary.
- q) Test site anechoic chamber refer to ANSI C63.4: 2009.

### **3.4. Uncertainty**

The measurement uncertainty is defined as for Conducted Power Measurement  $\pm 1.2$  dB, for Radiated Power Measurement  $\pm 3.2$  dB

3.5. Test Result

Product	Wireless Module		
Test Item	Maximum Output Power		
Date of Test	2014/12/23	Test Site	TR-8

**GSM/GPRS/EDGE**

Band	Channel No.	Frequency (MHz)	Modulation	Conducted Power (dBm)
GSM850	128	824.2	GMSK	32.65
	189	836.4	GMSK	32.98
	251	848.8	GMSK	32.88
GSM1900	512	1850.2	GMSK	29.31
	661	1880.0	GMSK	29.40
	810	1909.8	GMSK	29.83
GPRS850	128	824.2	GMSK	32.64
	189	836.4	GMSK	32.97
	251	848.8	GMSK	32.86
GPRS1900	512	1850.2	GMSK	29.30
	661	1880.0	GMSK	29.39
	810	1909.8	GMSK	29.80
EDGE850	128	824.2	8PSK	26.95
	189	836.4	8PSK	27.06
	251	848.8	8PSK	27.01
EDGE1900	512	1850.2	8PSK	26.24
	661	1880.0	8PSK	26.49
	810	1909.8	8PSK	26.64

Note: The maximum PAR for GPRS1900 is 8.3dB less than 13 dB, and the maximum PAR for EDGE1900 is 8.4dB less than 13 dB.

WCDMA/HSDPA/HSUPA/HSPA+

Mode	3GPP Subtest	Band II (1900MHz) Channel			MPR
		Conducted Power (dBm)			
		9262	9400	9538	
WCDMA R99	1	23.67	23.43	23.70	N/A
Rel5 HSDPA	1	23.38	23.34	23.53	0
	2	23.32	23.25	23.41	0
	3	22.81	22.73	22.94	0.5
	4	22.80	22.71	22.91	0.5
Rel6 HSUPA	1	22.69	22.61	22.93	0.0
	2	20.53	20.60	20.91	2.0
	3	21.65	21.58	21.94	1.0
	4	20.51	20.59	20.89	2.0
	5	22.68	22.59	22.92	0.0
Rel7 HSPA+	1	21.95	21.89	22.01	N/A

Note: The maximum PAR for WCDMA Band II is 8.5dB less than 13 dB.

Mode	3GPP Subtest	Band V (850MHz) Channel			MPR
		Conducted Power (dBm)			
		4132	4182	4233	
WCDMA R99	1	23.80	23.86	23.90	N/A
Rel5 HSDPA	1	23.32	23.34	23.37	0
	2	23.29	23.31	23.36	0
	3	22.71	22.73	22.79	0.5
	4	22.70	22.71	22.75	0.5
Rel6 HSUPA	1	22.63	22.65	22.67	0.0
	2	20.61	20.63	20.64	2.0
	3	21.59	21.62	21.67	1.0
	4	20.58	20.63	20.69	2.0
	5	22.58	22.61	22.64	0.0
Rel7 HSPA+	1	21.89	21.93	21.99	N/A

Note: All conducted measurements are based on a RMS detector.

Product	Wireless Module		
Test Item	Effective Isotropic Radiated Power		
Date of Test	2014/12/23	Test Site	AC-5

Radiated Power EIRP/ERP				
Band	Modulation	Freq. (MHz)	EIRP (dBm)	H/V
GSM850	GMSK	824.2	31.13	H
		836.4	31.33	H
		848.8	31.27	H
		824.2	33.51	V
		836.4	33.88	V
		848.8	33.69	V
PCS1900	GMSK	1850.2	25.56	H
		1880.0	25.71	H
		1909.8	25.83	H
		1850.2	30.34	V
		1880.0	30.39	V
		1909.8	30.66	V
GPRS850	GMSK	824.2	31.01	H
		836.4	31.18	H
		848.8	31.07	H
		824.2	33.11	V
		836.4	33.45	V
		848.8	33.24	V
GPRS1900	GMSK	1850.2	25.06	H
		1880.0	25.29	H
		1909.8	25.35	H
		1850.2	30.11	V
		1880.0	30.14	V
		1909.8	30.29	V

EDGE850	8PSK	824.2	23.39	H
		836.4	23.77	H
		848.8	23.44	H
		824.2	28.01	V
		836.4	28.15	V
		848.8	28.09	V
EDGE1900	8PSK	1850.2	24.32	H
		1880.0	24.44	H
		1909.8	24.75	H
		1850.2	27.11	V
		1880.0	27.43	V
		1909.8	27.56	V
WCDMA Band 2	QPSK	1852.4	23.77	H
		1880.0	23.62	H
		1907.6	23.80	H
		1852.4	24.62	V
		1880.0	24.77	V
		1907.6	24.81	V
WCDMA Band 5	QPSK	826.4	23.41	H
		836.4	23.19	H
		846.6	23.28	H
		826.4	24.89	V
		836.4	24.56	V
		846.6	24.75	V

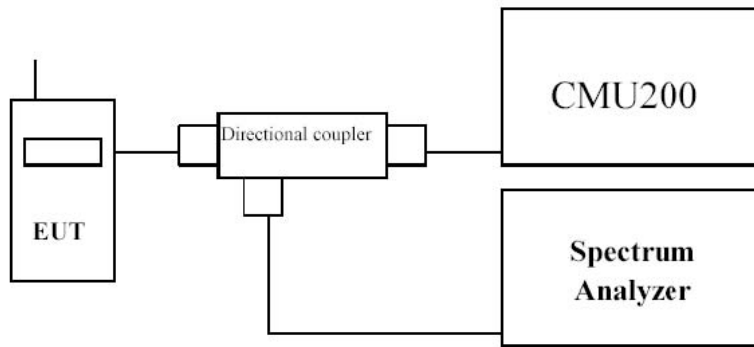
**4. Modulation Characteristic**

**4.1. Test Equipment**

Modulation Characteristic / AC-6

Instrument	Manufacturer	Type No.	Serial No	Cal. Date
PSA Series Spectrum Analyzer	Agilent	E4440A	MY49420184	2015.03.28
Radio Communication Tester	R&S	CMU 200	117088	2015.03.28
Dual Directional Coupler	Agilent	778D	20160	2015.03.28
10dB Coaxial Coupler	Agilent	87300C	MY44300299	2015.03.28
Temperature/Humidity Meter	Zhicheng	ZC1-2	AC6-TH	2016.01.07

**4.2. Test Setup**



**4.3. Uncertainty**

The measurement uncertainty is defined as 0.1%

**4.4. Test Result**

The modulation of GSM/WCDMA was verified and confirmed compliance with requirement.



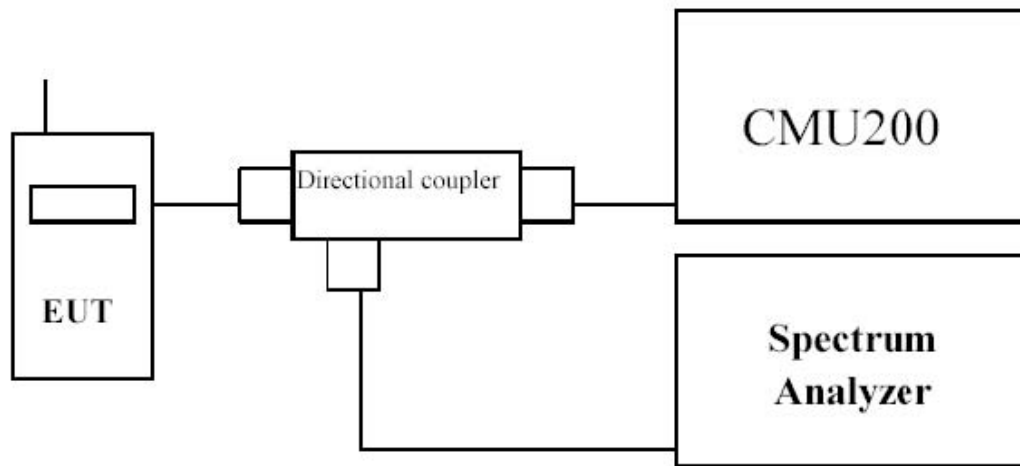
**5. Occupied Bandwidth**

**5.1. Test Equipment**

Occupied Bandwidth / AC-6

Instrument	Manufacturer	Type No.	Serial No	Cali. Due Date
PSA Series Spectrum Analyzer	Agilent	E4440A	MY49420184	2015.03.28
Radio Communication Tester	R&S	CMU 200	117088	2015.03.28
Dual Directional Coupler	Agilent	778D	20160	2015.03.28
10dB Coaxial Coupler	Agilent	87300C	MY44300299	2015.03.28
Temperature/Humidity Meter	Zhicheng	ZC1-2	AC6-TH	2016.01.07

**5.2. Test Setup**



**5.3. Test Procedure**

1. The EUT was connected to Spectrum Analyzer and Base Station via power divider.
2. The RF output of EUT was connected to the spectrum analyzer by RF cable and attenuator. The path loss was compensated to the results for each measurement.
3. The 99% occupied bandwidth and 26 dB bandwidth of the low & middle & high channel for the highest RF powers were measured.

**5.4. Uncertainty**

The measurement uncertainty is defined as  $\pm 10$  Hz

## 5.5. Test Result

Product	Wireless Module		
Test Item	Occupied Bandwidth		
Test Mode	Mode 1: GSM 850 Link		
Date of Test	2014/12/29	Test Site	AC6

Channel No.	Frequency (MHz)	-26dB Occupied Bandwidth (kHz)	99% Occupied Bandwidth (kHz)
128	824.20	306.567	241.955
189	836.40	312.650	243.884
251	848.80	314.244	244.371

Figure Channel 128 (824.20MHz)

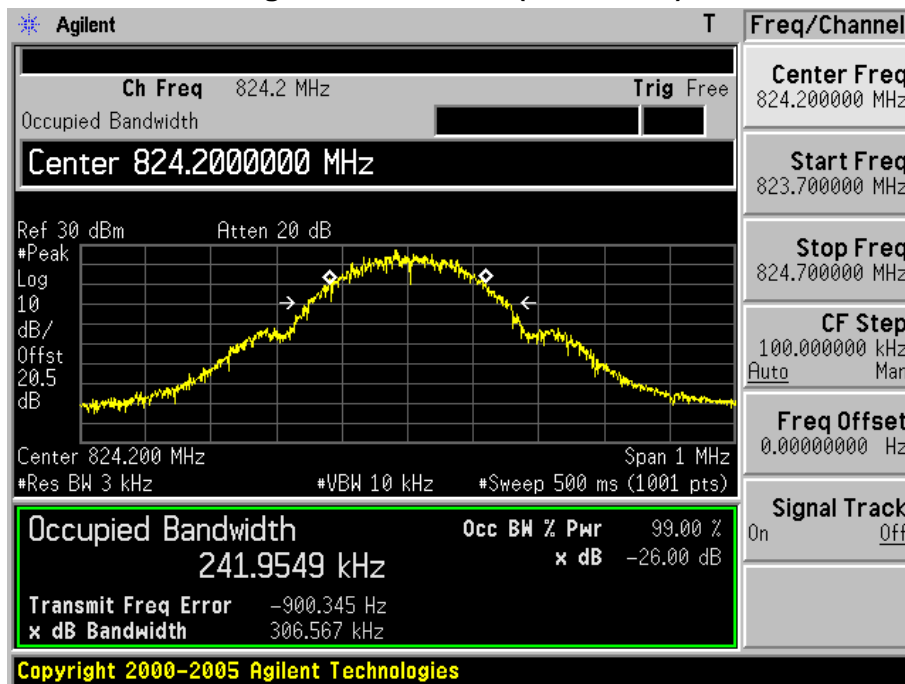


Figure Channel 189 (836.40MHz)

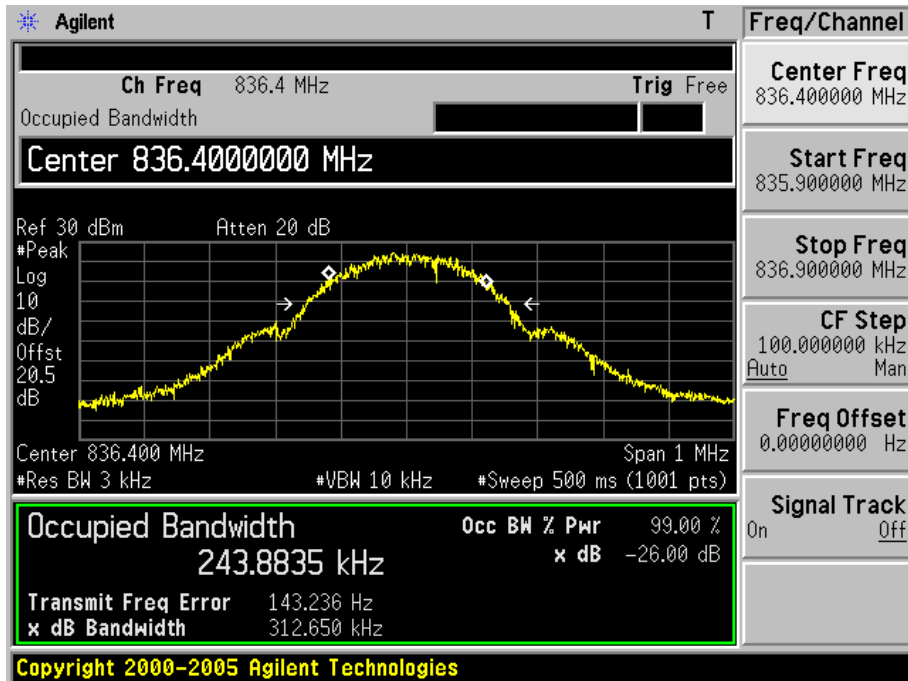
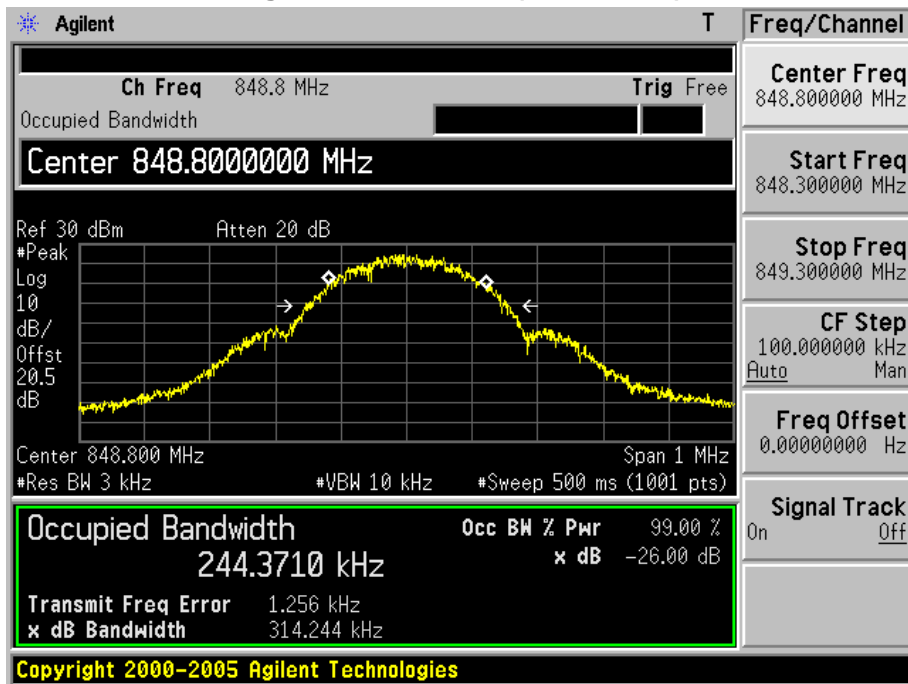


Figure Channel 251 (848.80MHz)



Product	Wireless Module		
Test Item	Occupied Bandwidth		
Test Mode	Mode 2: PCS 1900 Link		
Date of Test	2014/12/29	Test Site	AC6

Channel No.	Frequency (MHz)	-26dB Occupied Bandwidth (kHz)	99% Occupied Bandwidth (kHz)
512	1850.20	319.605	245.780
661	1880.00	314.930	243.757
810	1909.80	318.707	242.893

**Figure Channel 512 (1850.20MHz)**

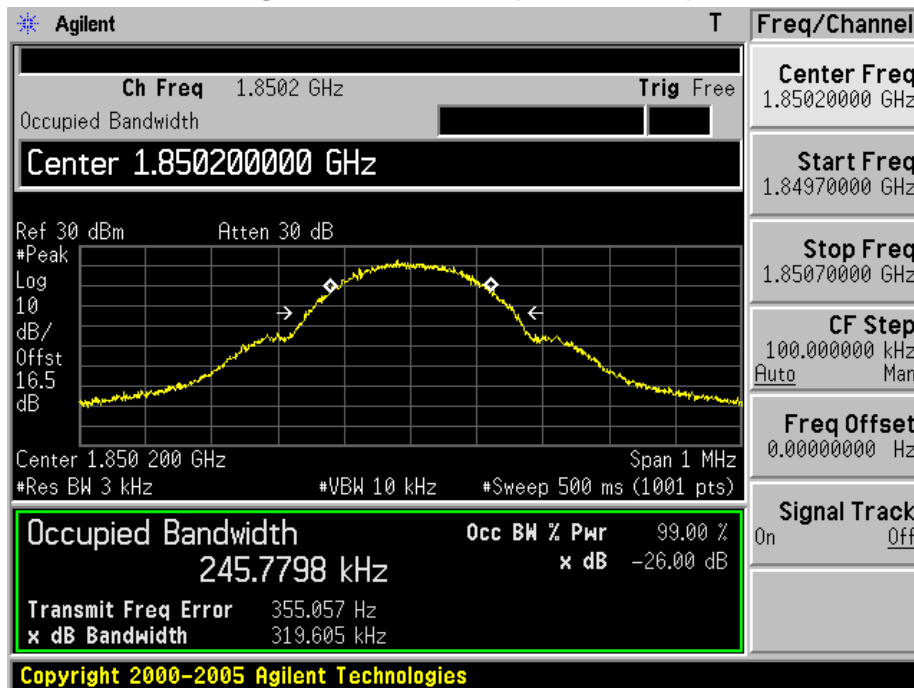


Figure Channel 661 (1880.00MHz)

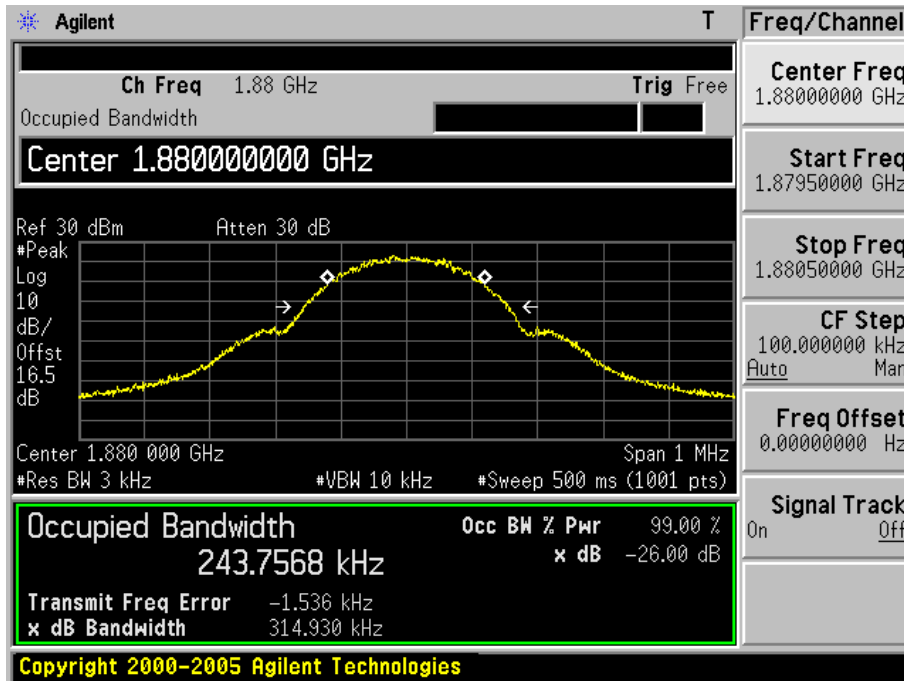
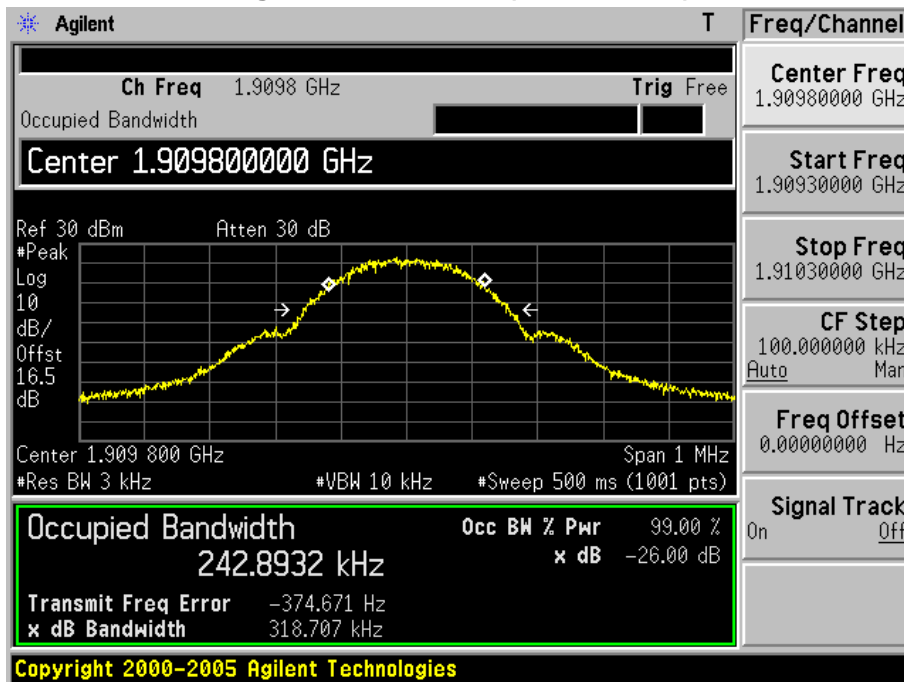


Figure Channel 810 (1909.80MHz)



Product	Wireless Module		
Test Item	Occupied Bandwidth		
Test Mode	Mode 3: EDGE 850 Link		
Date of Test	2014/12/29	Test Site	AC6

Channel No.	Frequency (MHz)	-26dB Occupied Bandwidth (kHz)	99% Occupied Bandwidth (kHz)
128	824.20	305.801	239.063
189	836.40	317.538	245.885
251	848.80	292.724	241.133

**Figure Channel 128 (824.20MHz)**

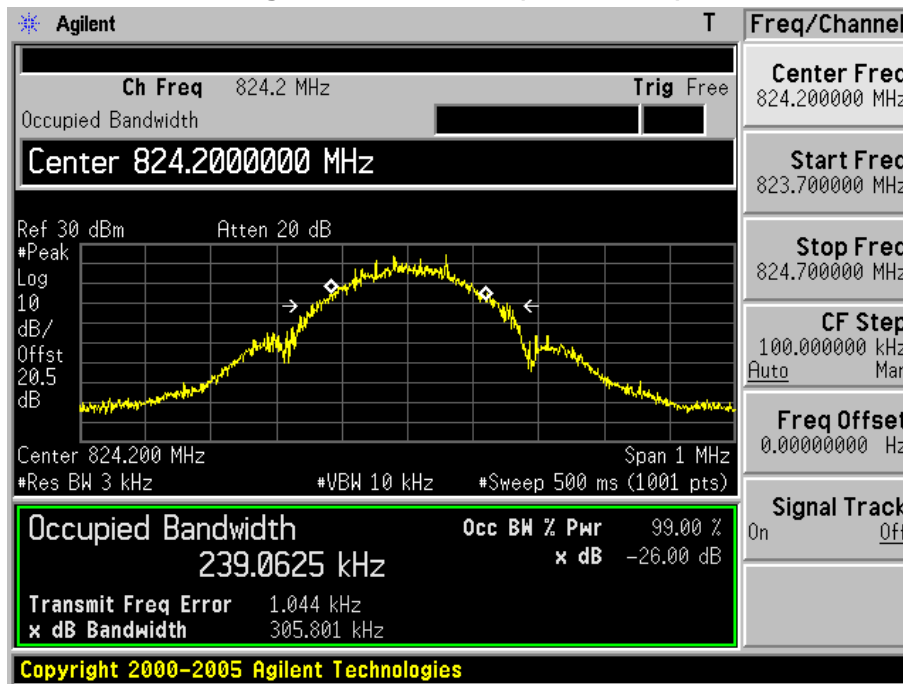


Figure Channel 189 (836.40MHz)

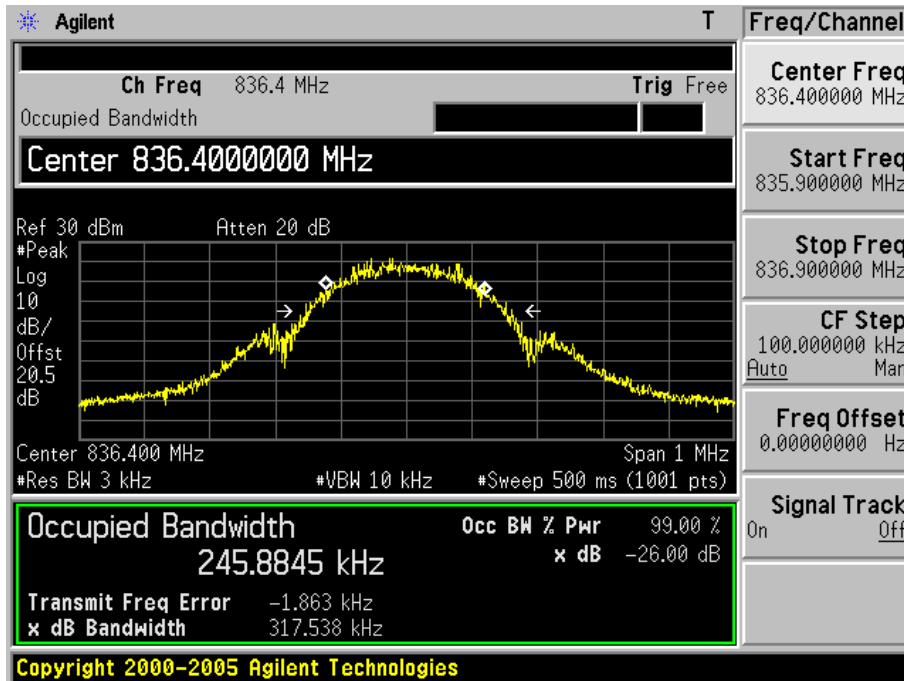
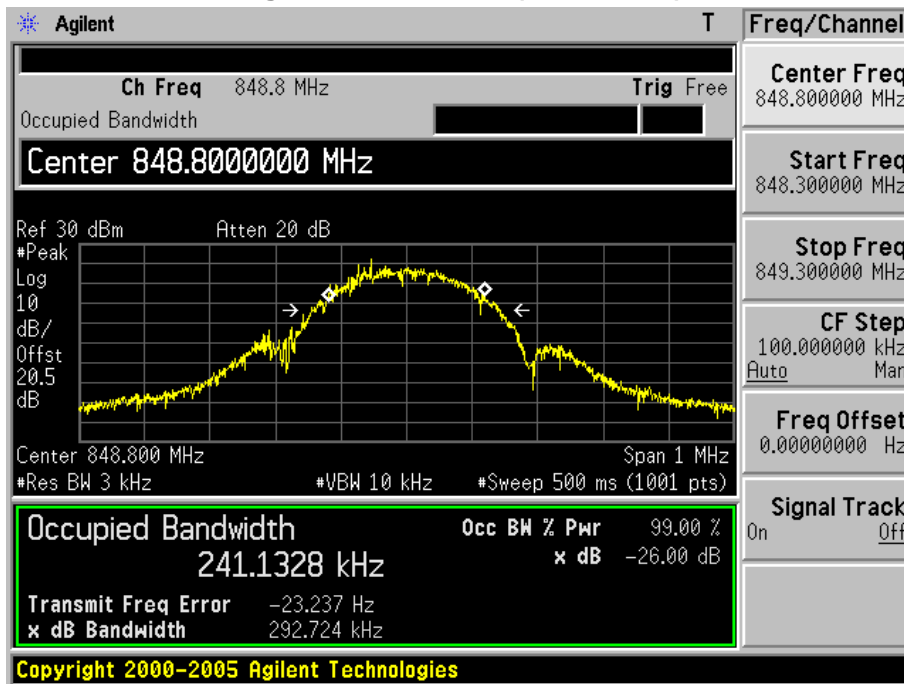


Figure Channel 251 (848.80MHz)



Product	Wireless Module		
Test Item	Occupied Bandwidth		
Test Mode	Mode 4: EDGE 1900 Link		
Date of Test	2014/12/29	Test Site	AC6

Channel No.	Frequency (MHz)	-26dB Occupied Bandwidth (kHz)	99% Occupied Bandwidth (kHz)
512	1850.20	317.441	247.204
661	1880.00	301.871	246.979
810	1909.80	308.863	242.683

**Figure Channel 512 (1850.20MHz)**

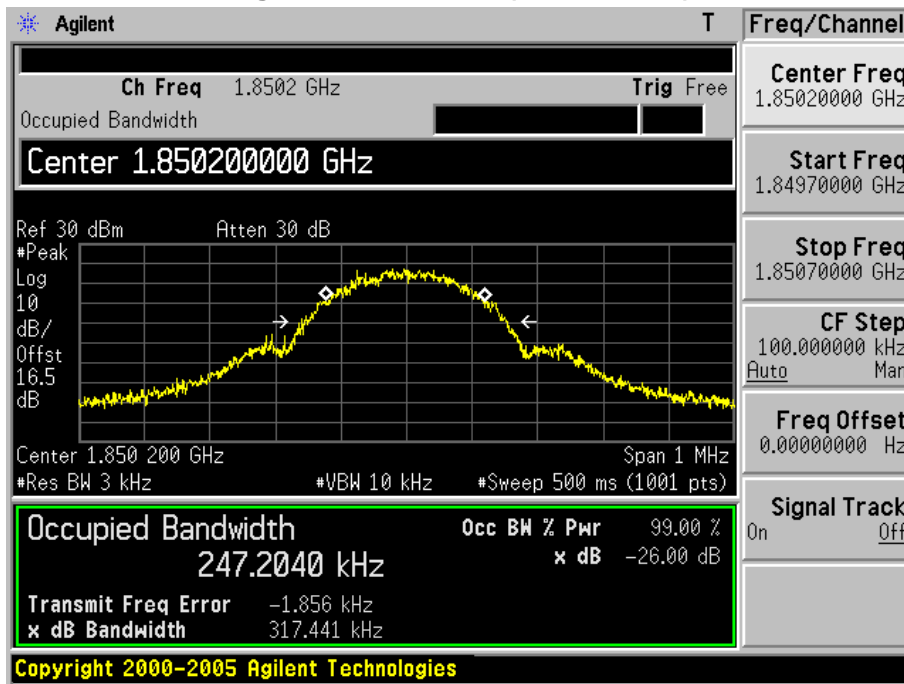




Figure Channel 661 (1880.00MHz)

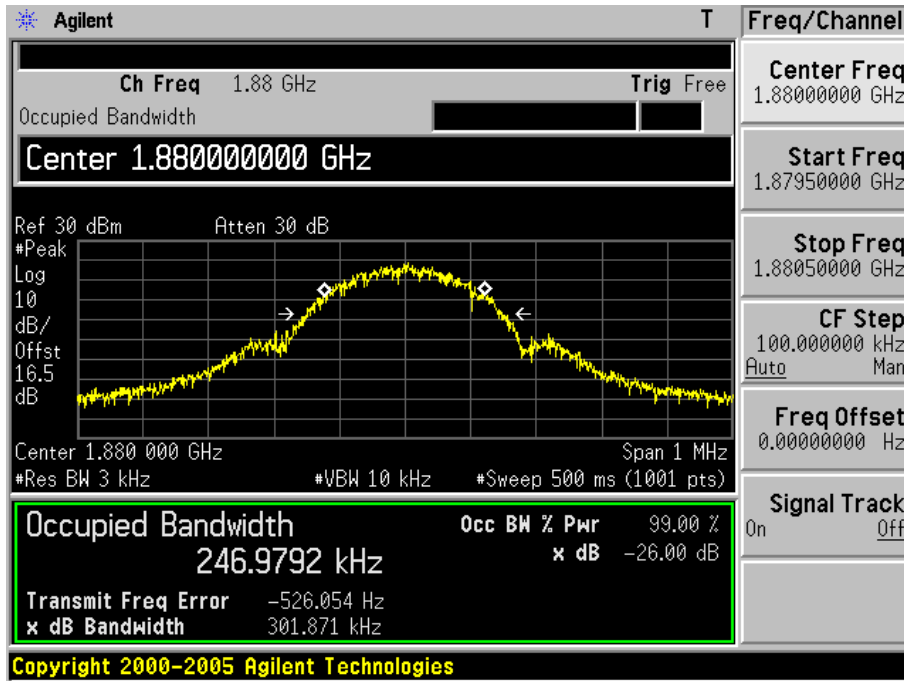
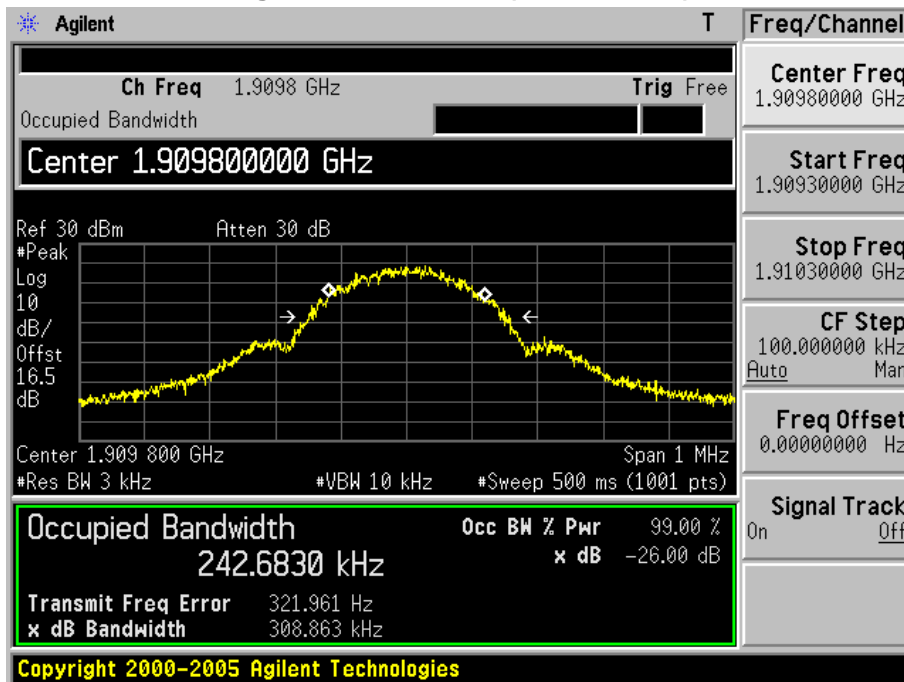


Figure Channel 810 (1909.80MHz)



Product	Wireless Module		
Test Item	Occupied Bandwidth		
Test Mode	Mode 5: WCDMA Band II Link		
Date of Test	2014/12/29	Test Site	AC6

Channel No.	Frequency (MHz)	-26dB Occupied Bandwidth (kHz)	99% Occupied Bandwidth (kHz)
9262	1852.4	4637.0	4156.8
9400	1880.0	4623.0	4155.2
9538	1907.6	4626.0	4145.2

**Figure Channel 9262 (1852.40MHz)**

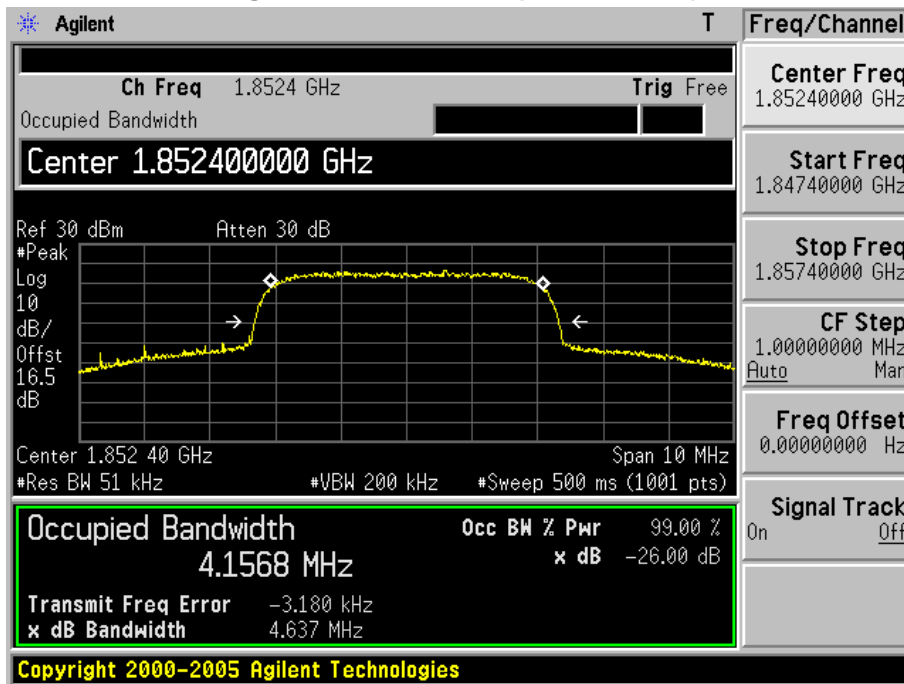


Figure Channel 9400 (1880.0MHz)

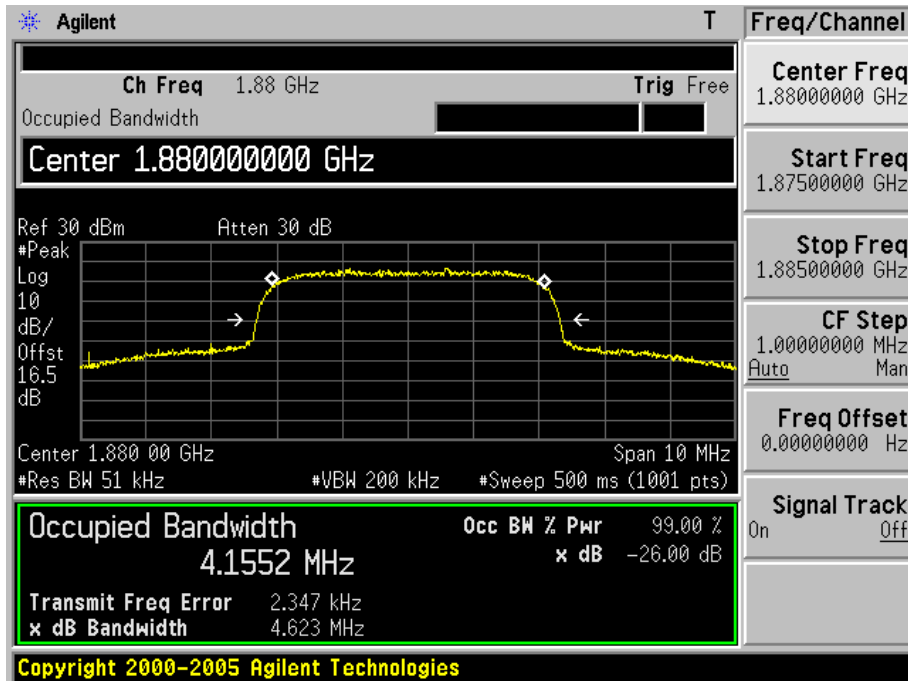
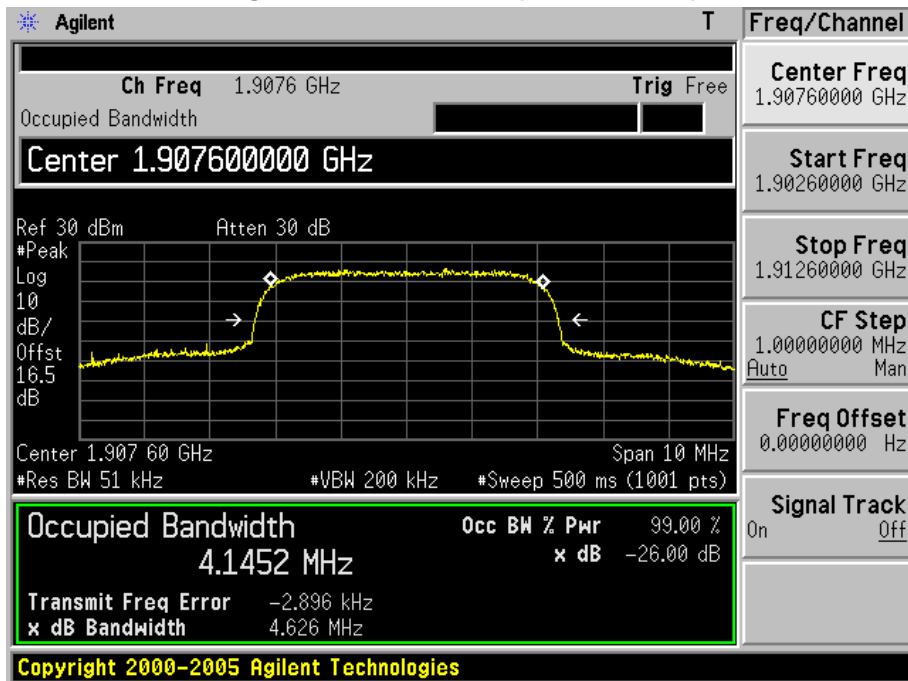


Figure Channel 9538 (1907.60MHz)



Product	Wireless Module		
Test Item	Occupied Bandwidth		
Test Mode	Mode 6: WCDMA Band V Link		
Date of Test	2014/12/29	Test Site	AC6

Channel No.	Frequency (MHz)	-26dB Occupied Bandwidth (kHz)	99% Occupied Bandwidth (kHz)
4132	826.4	4621.0	4150.3
4182	836.4	4617.0	4149.2
4233	846.6	4618.0	4148.0

**Figure Channel 4132 (826.40MHz)**

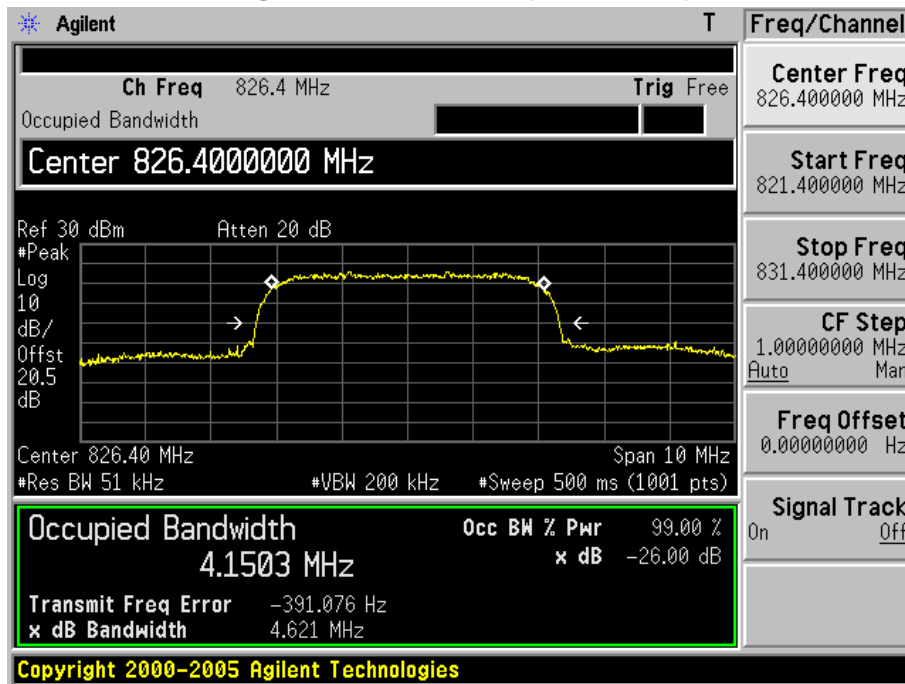


Figure Channel 4182 (836.40MHz)

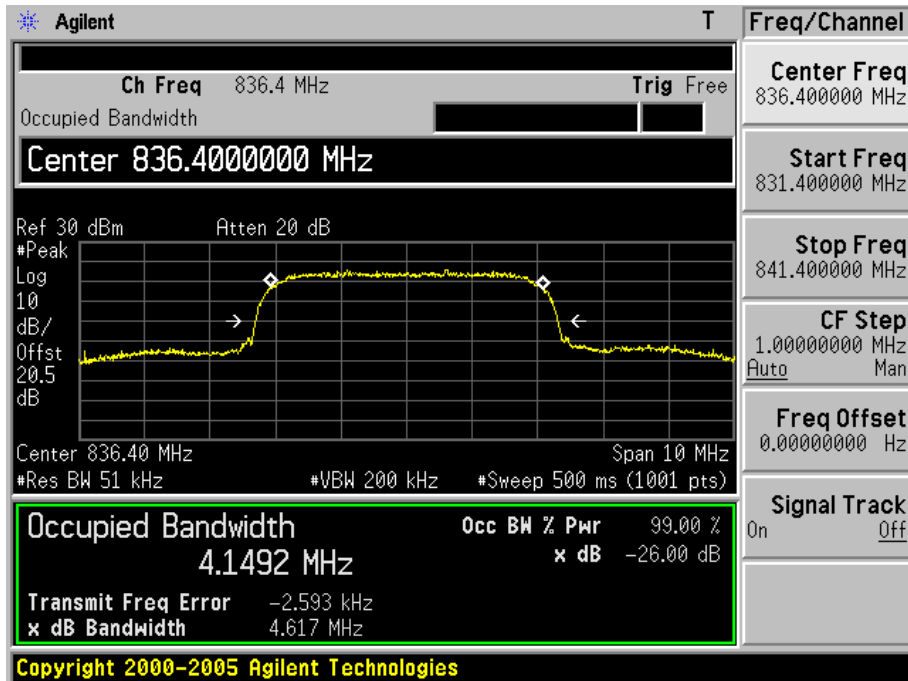
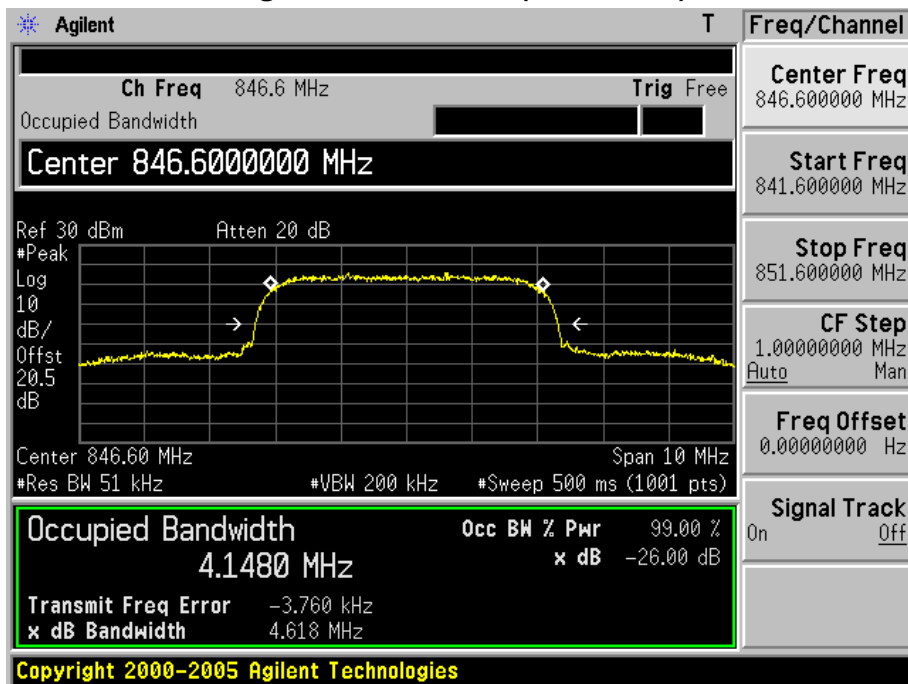


Figure Channel 4233(846.60MHz)



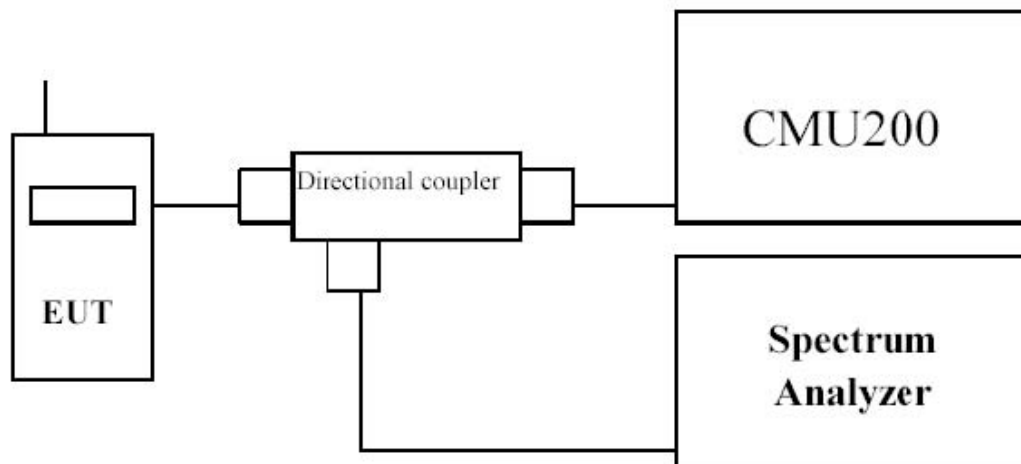
## 6. Conducted Band Edge

### 6.1. Test Equipment

Conducted Band Edge / AC-6

Instrument	Manufacturer	Type No.	Serial No	Cali. Due Date
PSA Series Spectrum Analyzer	Agilent	E4440A	MY49420184	2015.03.28
Radio Communication Tester	R&S	CMU 200	117088	2015.03.28
Dual Directional Coupler	Agilent	778D	20160	2015.03.28
10dB Coaxial Coupler	Agilent	87300C	MY44300299	2015.03.28
Temperature/Humidity Meter	Zhicheng	ZC1-2	AC6-TH	2016.01.07

### 6.2. Test Setup



### 6.3. Test Procedure

1. The EUT was connected to spectrum analyzer and System Simulator via power divider.
2. The RF output of EUT was connected to the spectrum analyzer by RF cable and attenuator. The path loss was compensated to the results for each measurement.
3. The conducted spurious emission for the whole frequency range was taken.
4. In the 1MHz bands immediately outside and adjacent to the frequency block a resolution bandwidth of at least one percent of the emission bandwidth of the fundamental emission of the transmitter may be employed to measure the out of band Emissions.

**6.4. Uncertainty**

The measurement uncertainty is defined as  $\pm 1.2$  dB.

## 6.5. Test Result

Product	Wireless Module		
Test Item	Conducted Band Edge		
Test Mode	Mode 1: GSM 850 Link		
Date of Test	2014/12/28	Test Site	AC6

Figure Channel 128 (824.20MHz)

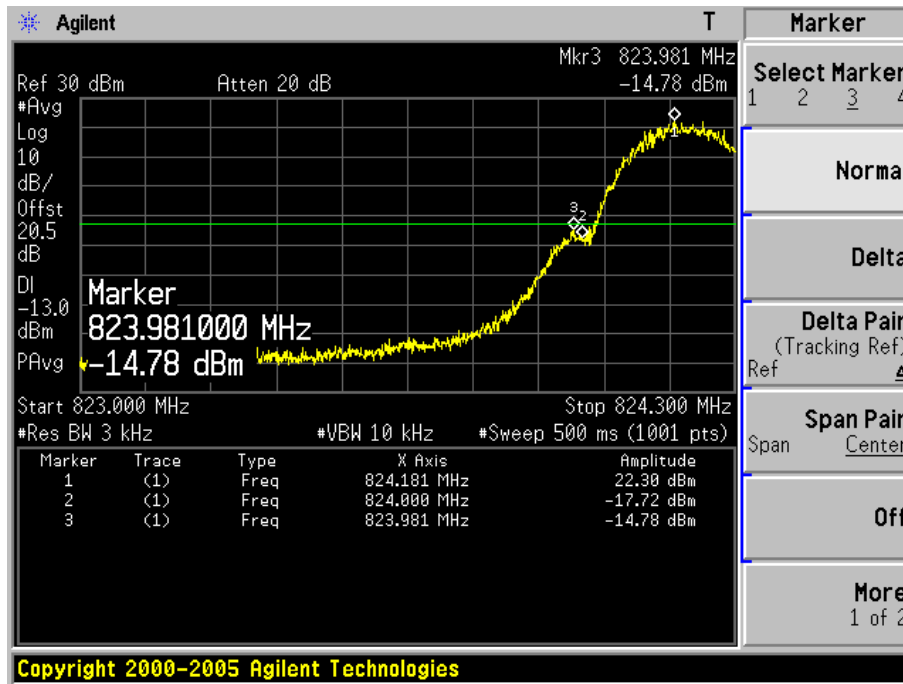
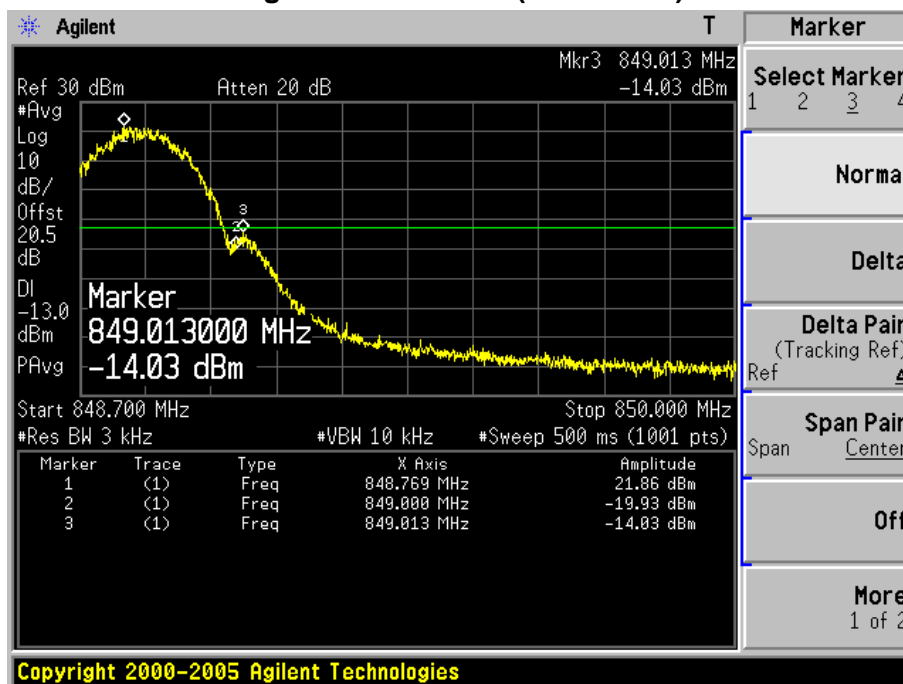


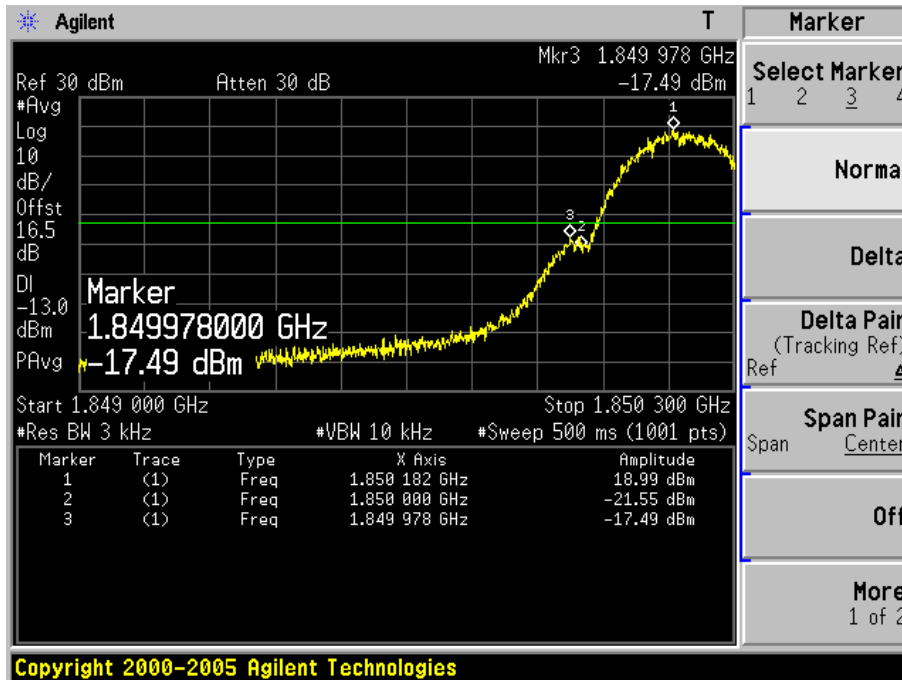
Figure Channel 251 (848.80MHz)



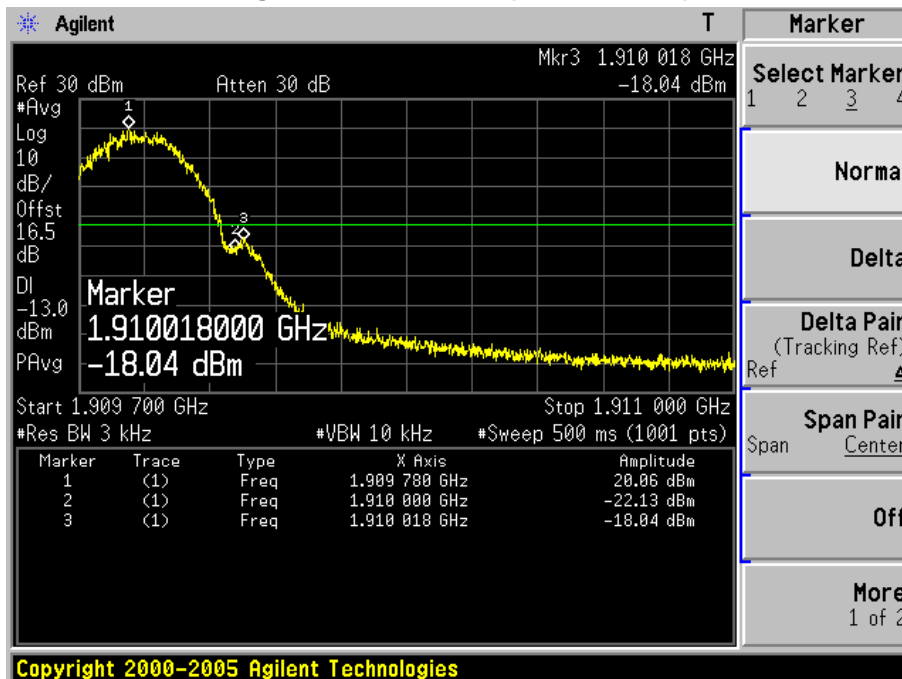


Product	Wireless Module		
Test Item	Conducted Band Edge		
Test Mode	Mode 2: PCS1900 Link		
Date of Test	2014/12/28	Test Site	AC6

**Figure Channel 512 (1850.20MHz)**

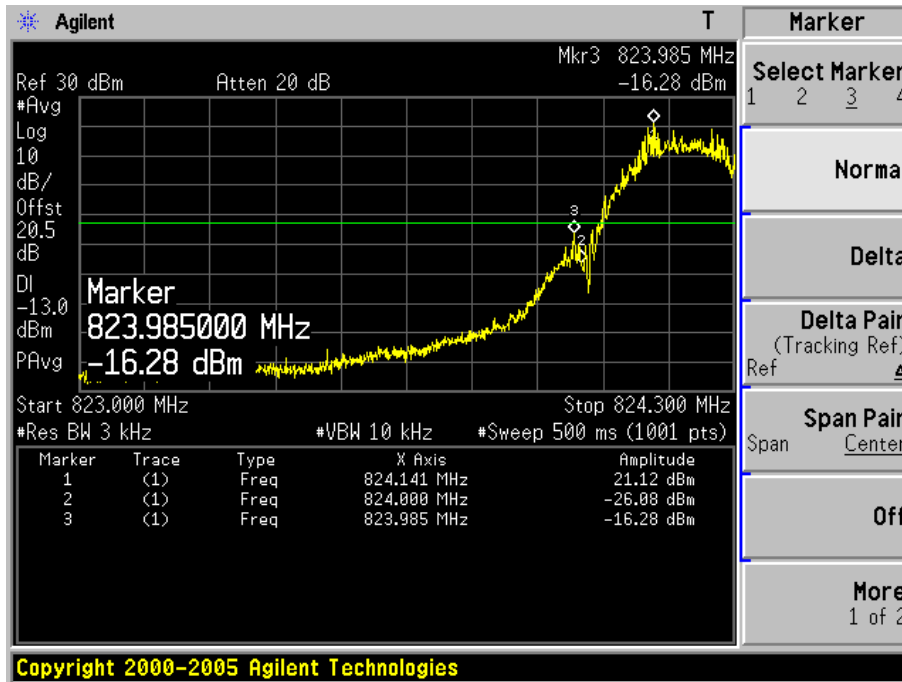


**Figure Channel 810 (1909.80MHz)**

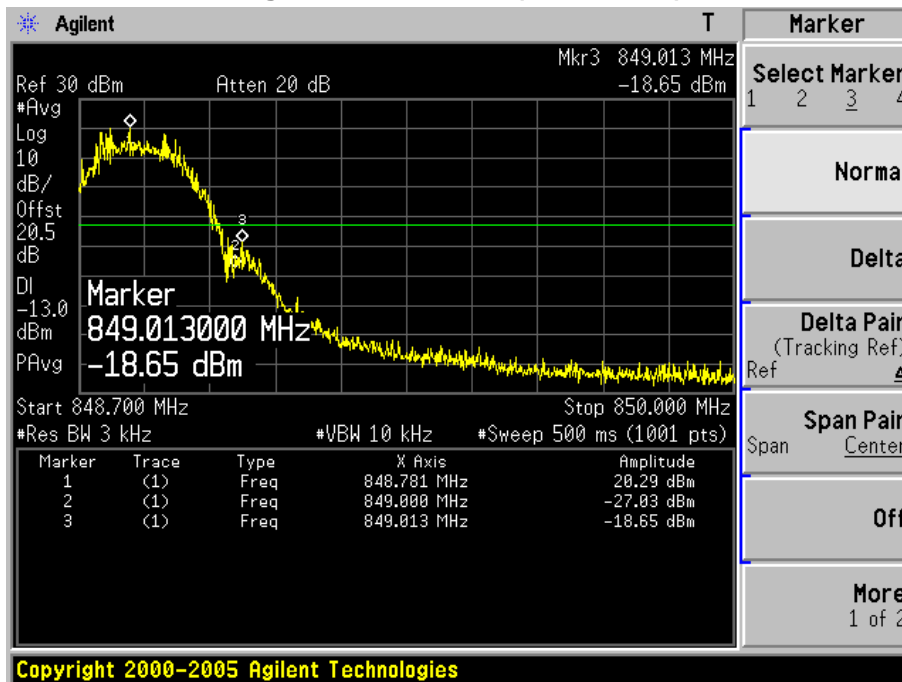


Product	Wireless Module		
Test Item	Conducted Band Edge		
Test Mode	Mode 3: EDGE 850 Link		
Date of Test	2014/12/28	Test Site	AC6

**Figure Channel 128 (824.20MHz)**

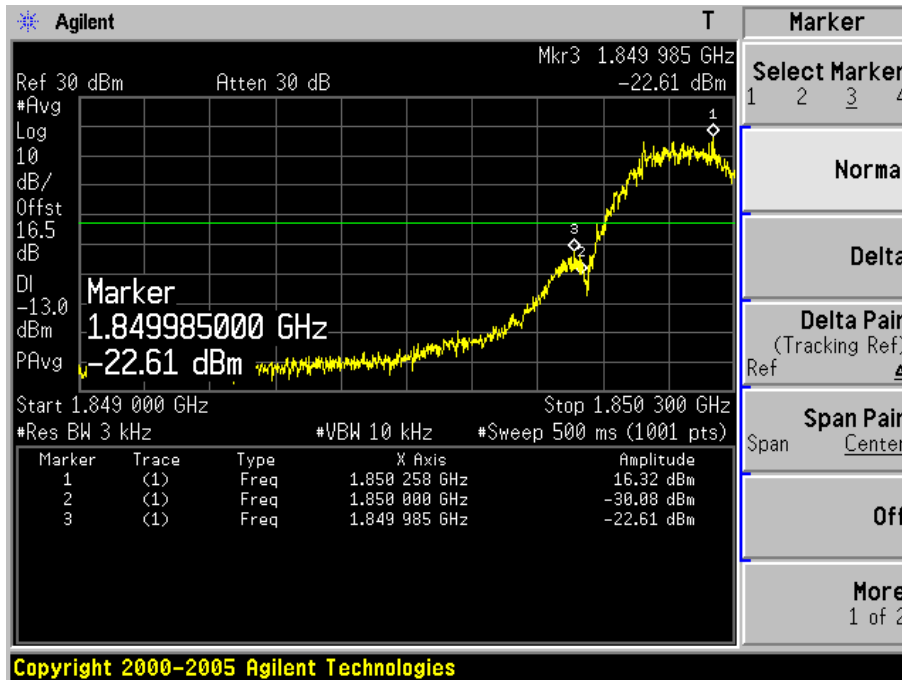


**Figure Channel 251 (848.80MHz)**

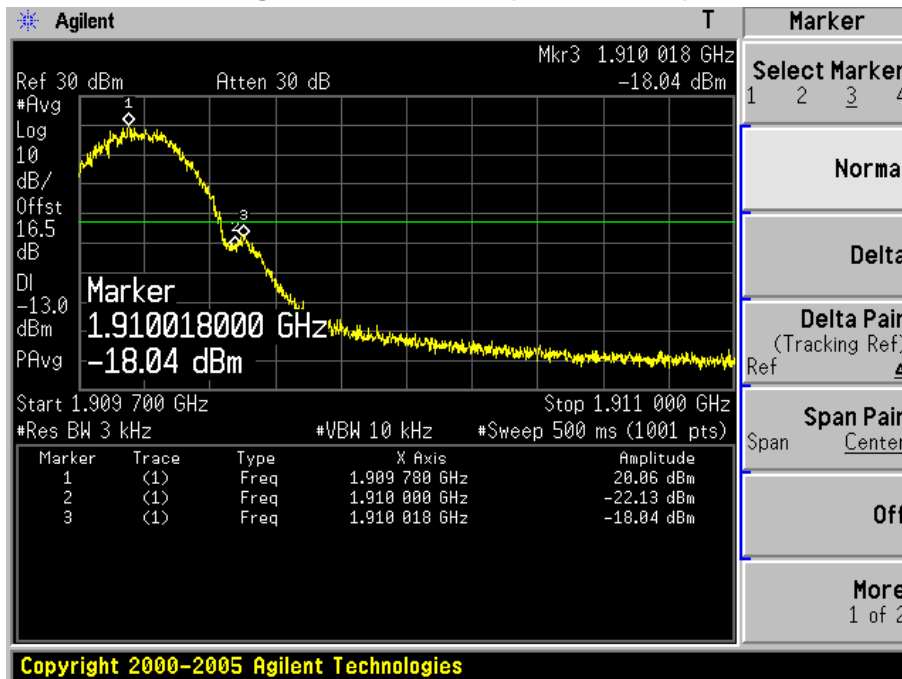


Product	Wireless Module		
Test Item	Conducted Band Edge		
Test Mode	Mode 4: EDGE1900 Link		
Date of Test	2014/12/28	Test Site	AC6

**Figure Channel 512 (1850.20MHz)**

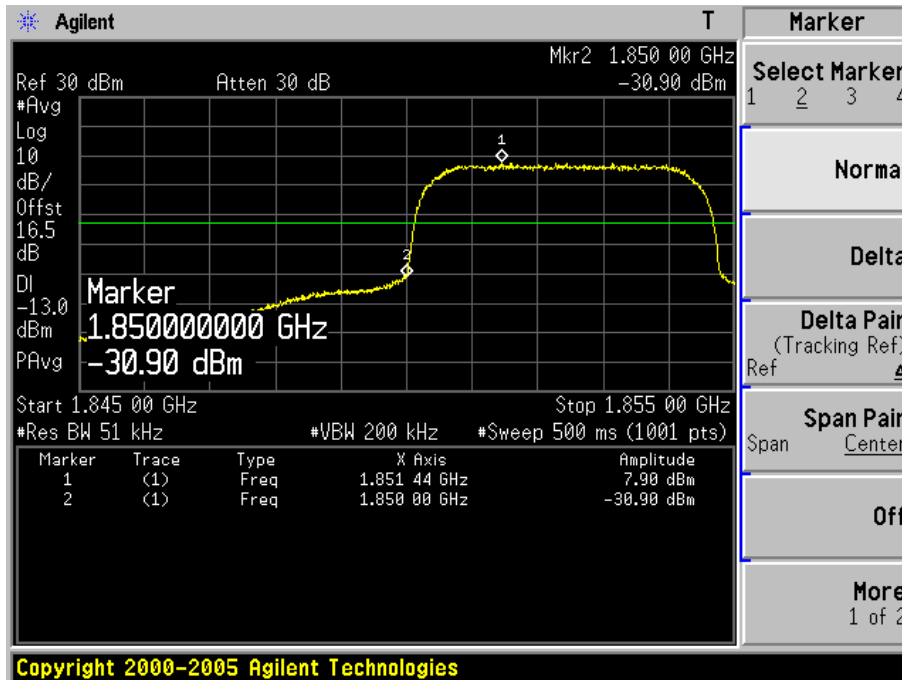


**Figure Channel 810 (1909.80MHz)**

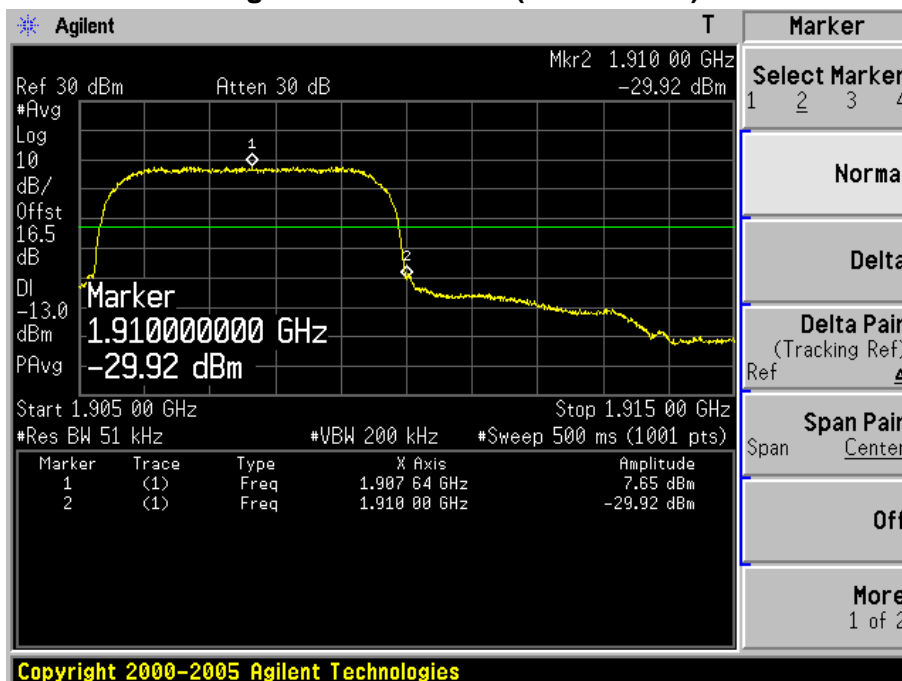


Product	Wireless Module		
Test Item	Conducted Band Edge		
Test Mode	Mode 5: WCDMA Band II Link		
Date of Test	2014/12/28	Test Site	AC6

**Figure Channel 9262 (1852.40MHz)**

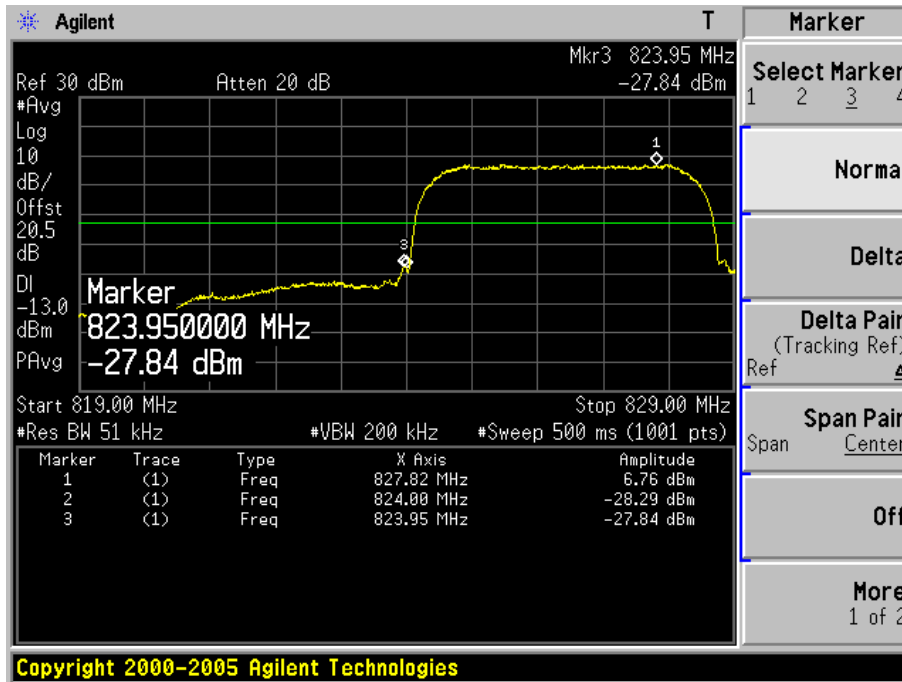


**Figure Channel 9538 (1907.60MHz)**

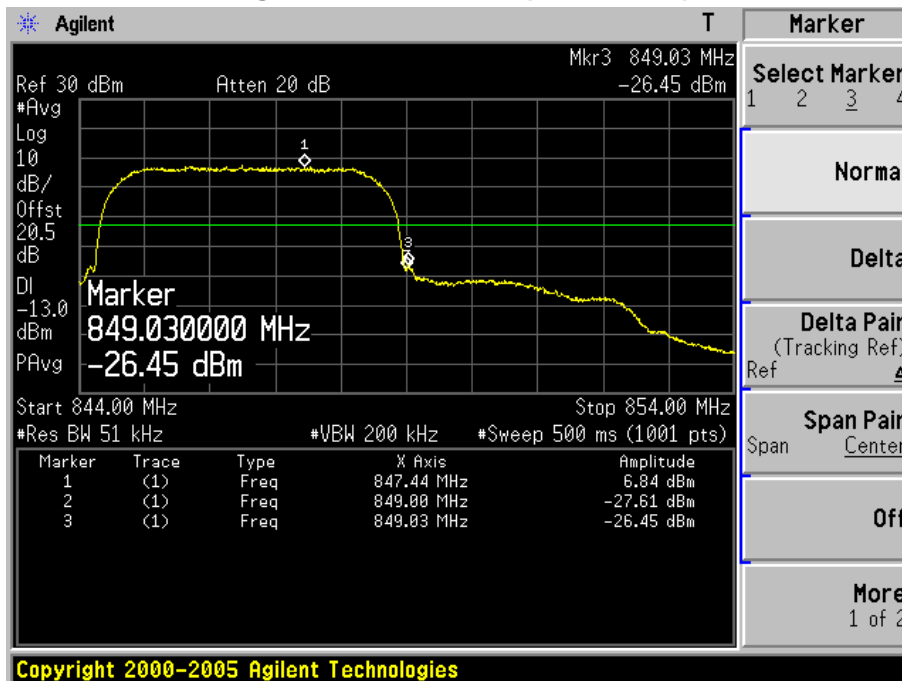


Product	Wireless Module		
Test Item	Conducted Band Edge		
Test Mode	Mode 6: WCDMA Band V Link		
Date of Test	2014/12/28	Test Site	AC6

**Figure Channel 4132 (826.40MHz)**



**Figure Channel 4233 (846.60MHz)**



**7. Spurious Emission**

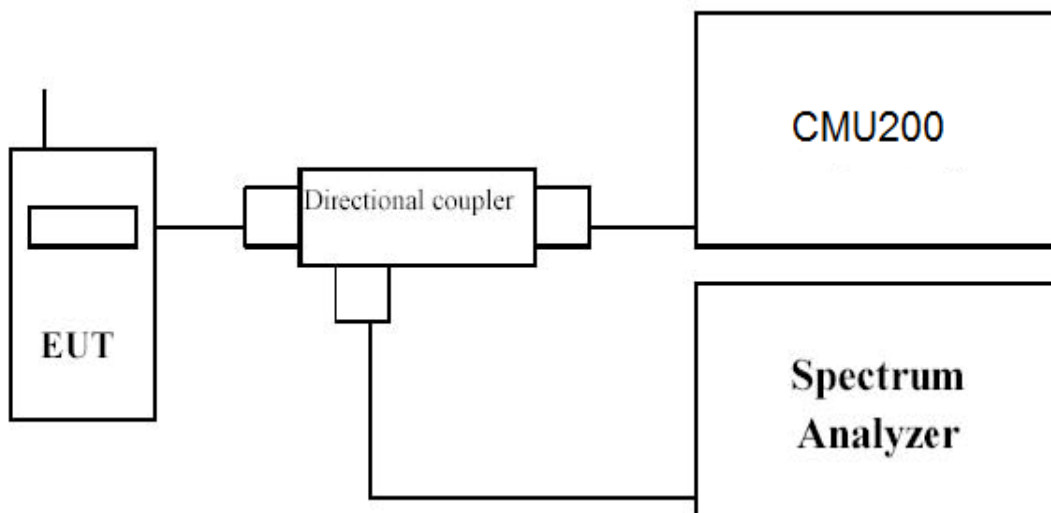
**7.1. Test Equipment**

Spurious Emission / AC-5

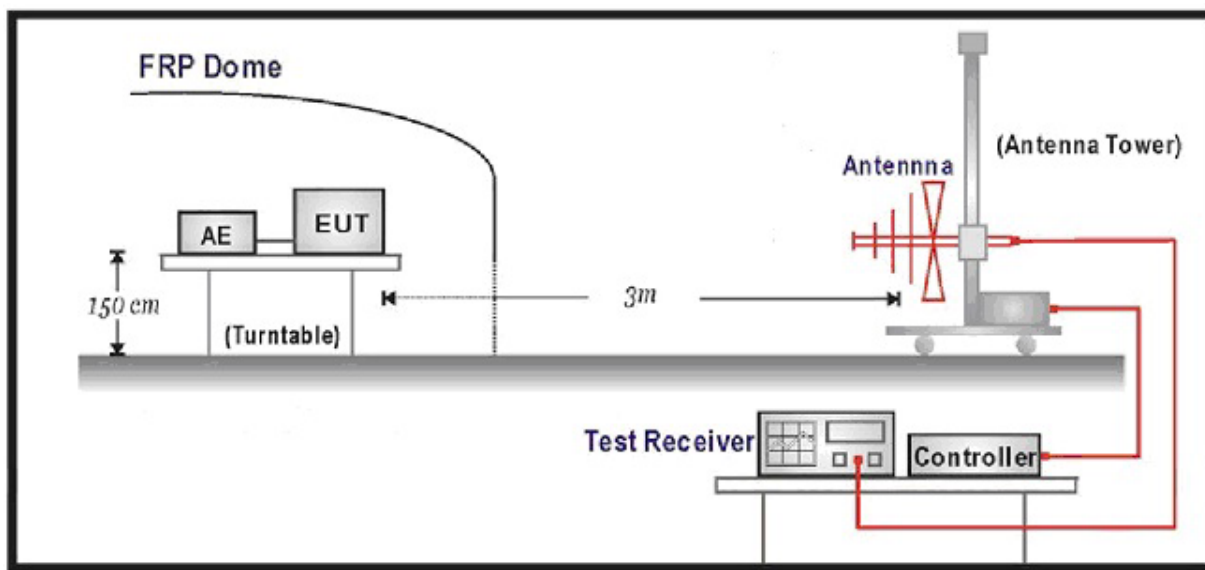
Instrument	Manufacturer	Type No.	Serial No	Cali. Due Date
PSA Series Spectrum Analyzer	Agilent	E4440A	MY49420184	2015.03.28
Radio Communication Tester	R&S	CMU 200	117088	2015.03.28
Dual Directional Coupler	Agilent	778D	20160	2015.03.28
10dB Coaxial Coupler	Agilent	87300C	MY44300299	2015.03.28
PSG Analog Signal Generator	Agilent	E8257D	MY44321116	2015.03.28
Preamplifier	QuieTek	AP-025C	CHM-0503006	2015.04.11
Preamplifier	Miteq	NSP1800-25	1364185	2015.05.03
Bilog Antenna	Teseq GmbH	CBL6112D	27612	2015.10.15
Half Wave Tuned Dipole Antenna	COM-POWER	AD-100	40137	2016.02.26
Broad-Band Horn Antenna	Schwarzbeck	BBHA9120D	737	2016.02.26
Broad-Band Horn Antenna	Schwarzbeck	BBHA9120D	499	2015.06.08
Temperature/Humidity Meter	Zhicheng	ZC1-2	AC5-TH	2016.01.07

### 7.2. Test Setup

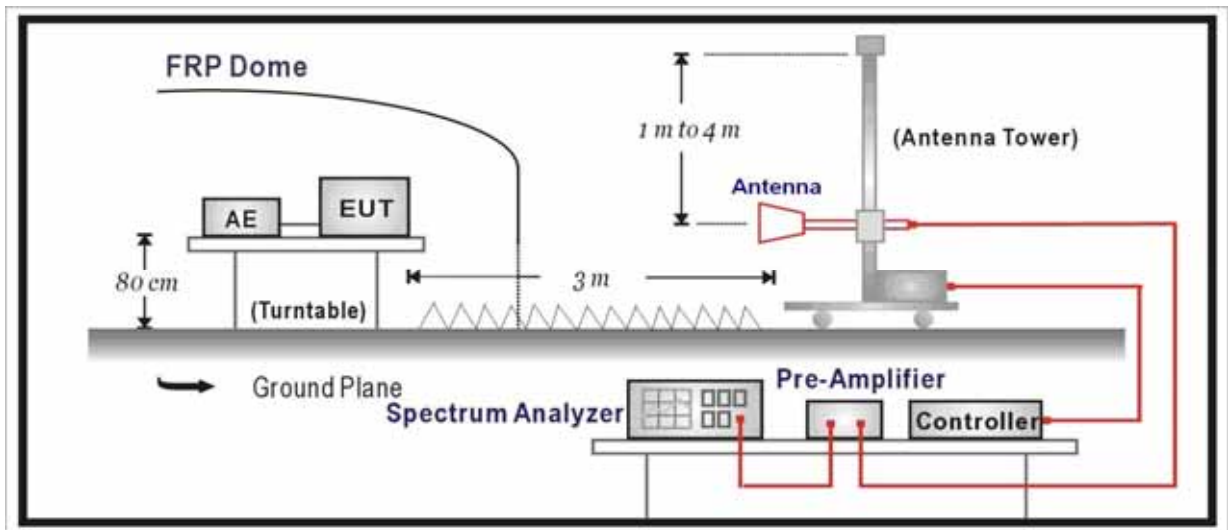
Conducted Spurious Measurement: below 1GHz



Radiated Spurious Measurement: below 1GHz



## Radiated Spurious Measurement: above 1GHz





### 7.3. Test Procedure

#### Conducted Spurious Measurement:

- a) Place the EUT on a bench and set it in transmitting mode.
- b) Connect a low loss RF cable from the antenna port to a spectrum analyzer and CMU200 by a Directional Couple.
- c) EUT Communicate with CMU200, then select a channel for testing.
- d) Add a correction factor to the display of spectrum, and then test.
- e) The resolution bandwidth of the spectrum analyzer was set at 1 MHz, sufficient scans were taken to show the out of band Emission if any up to 10<sup>th</sup> harmonic.

#### Radiated Spurious Measurement:

- f) The EUT was placed on a rotatable wooden table with 1.5 meter above ground.
- g) The EUT was set 3 meters from the receiving antenna, which was mounted on the antenna tower.
- h) The table was rotated 360 degrees to determine the position of the highest spurious emission.
- i) The height of the receiving antenna is varied between one meter and four meters to search the maximum spurious emission for both horizontal and vertical polarizations.
- j) Make the measurement with the spectrum analyzer's RBW = 1MHz, VBW = 1MHz, Sweep 500ms, Taking the record of maximum spurious emission.
- k) A horn antenna was substituted in place of the EUT and was driven by a signal generator.
- l) Tune the output power of signal generator to the same emission level with EUT maximum spurious emission.
- m) Taking the record of output power at antenna port
- n) Repeat step 7 to step 8 for another polarization. I receiver.
- o)  $EIRP = SG - \text{Cable loss} + \text{Antenna Gain}$

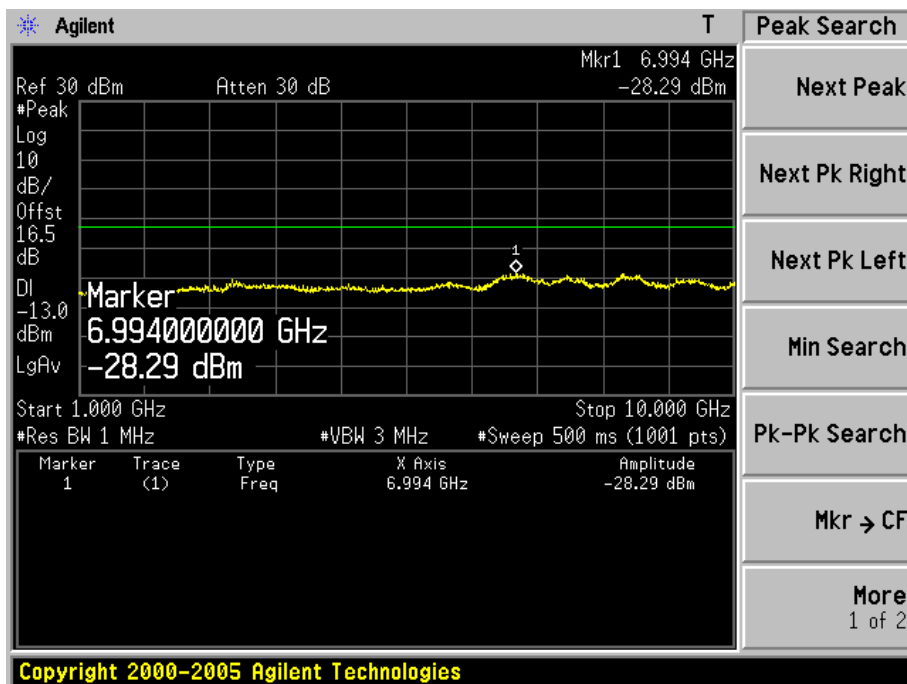
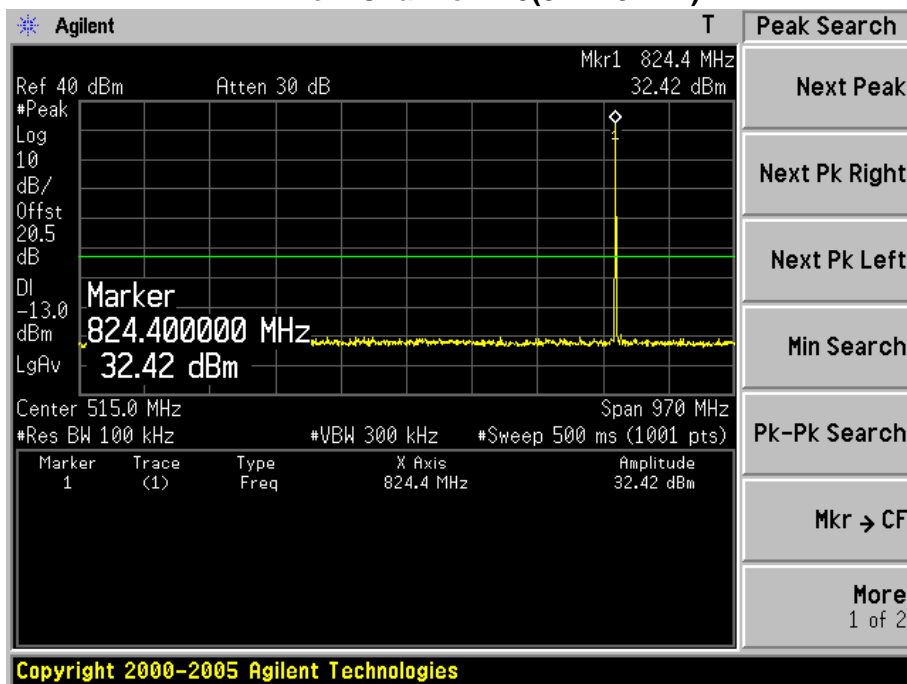
### 7.4. Uncertainty

The measurement uncertainty is defined as 3.2 dB for Radiated Power Measurement.

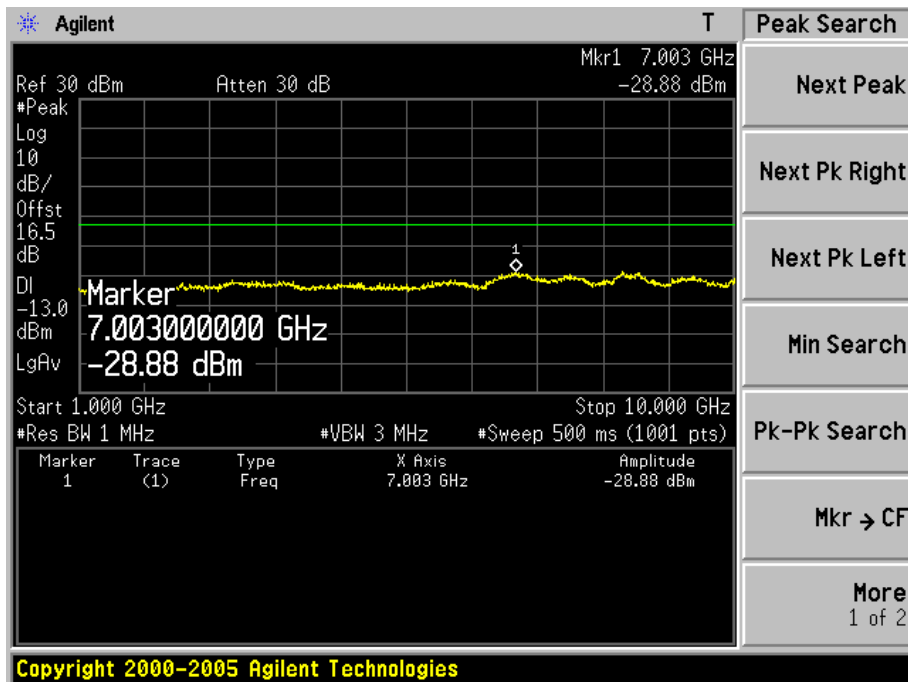
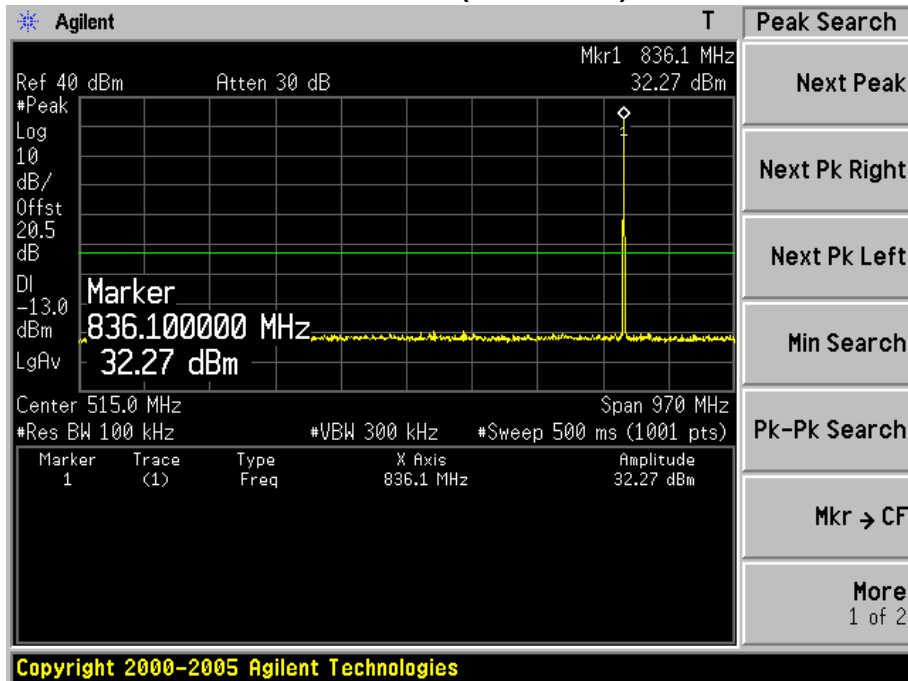
## 7.5. Test Result

Product	Wireless Module		
Test Item	Conducted Spurious Emission		
Test Mode	Mode 1: GSM 850 Link		
Date of Test	2014/12/28	Test Site	TR8

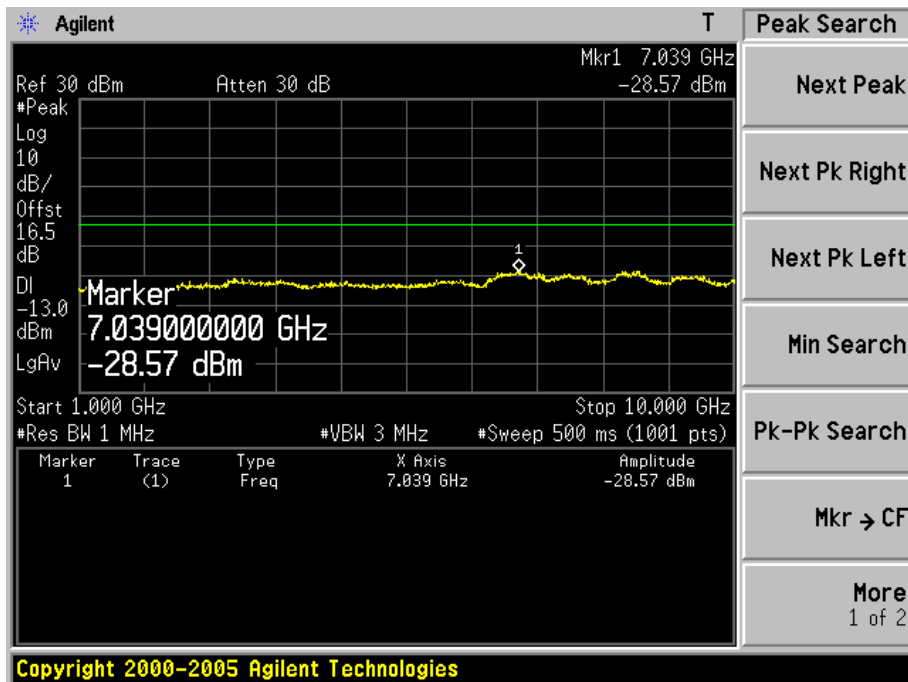
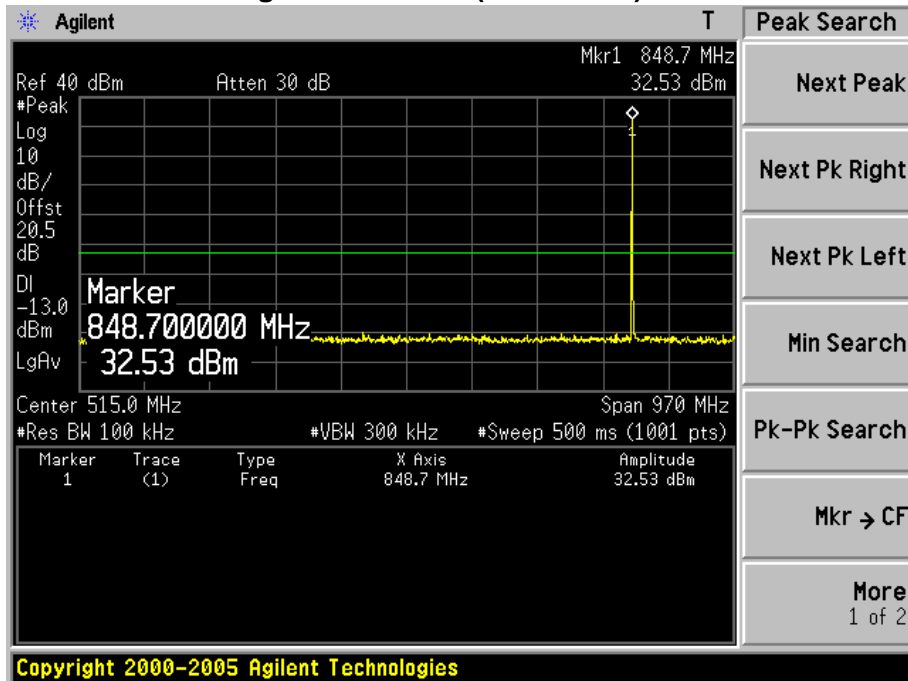
Low Channel 128(824.20MHz)



Mid Channel 189(836.40MHz)

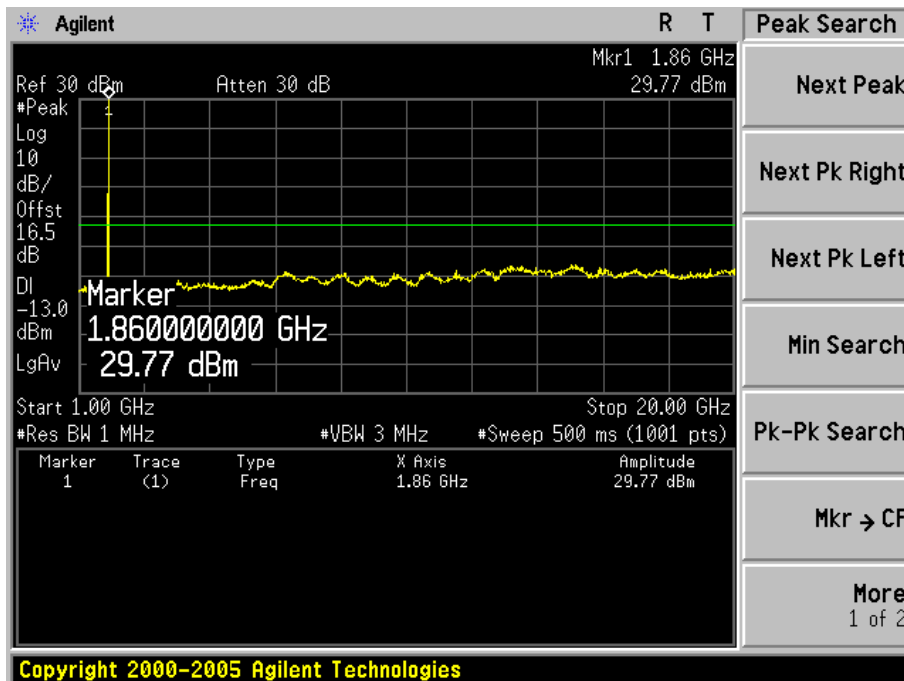
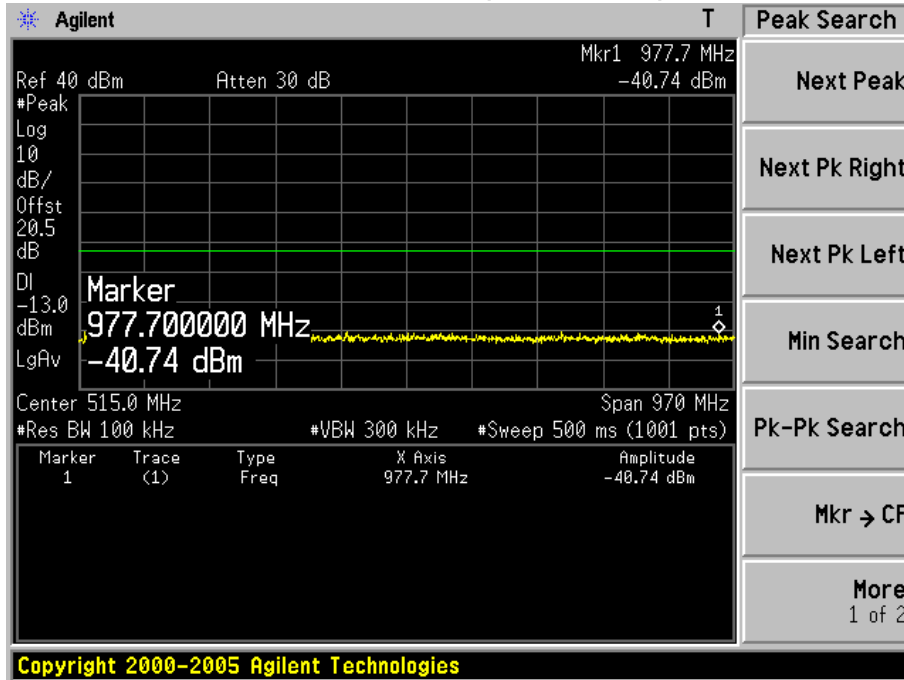


High Channel 251(848.80MHz)

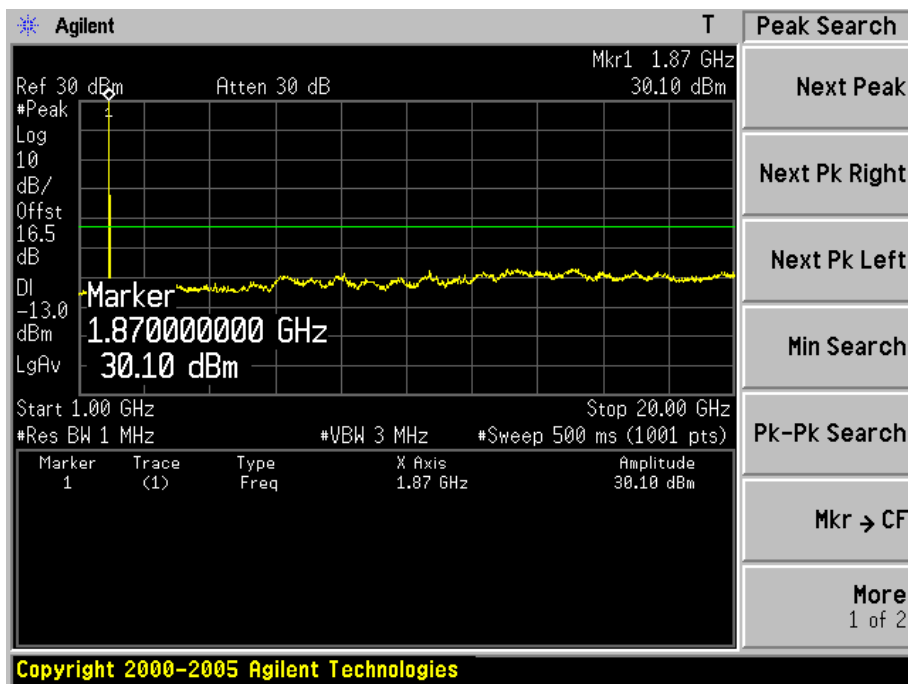
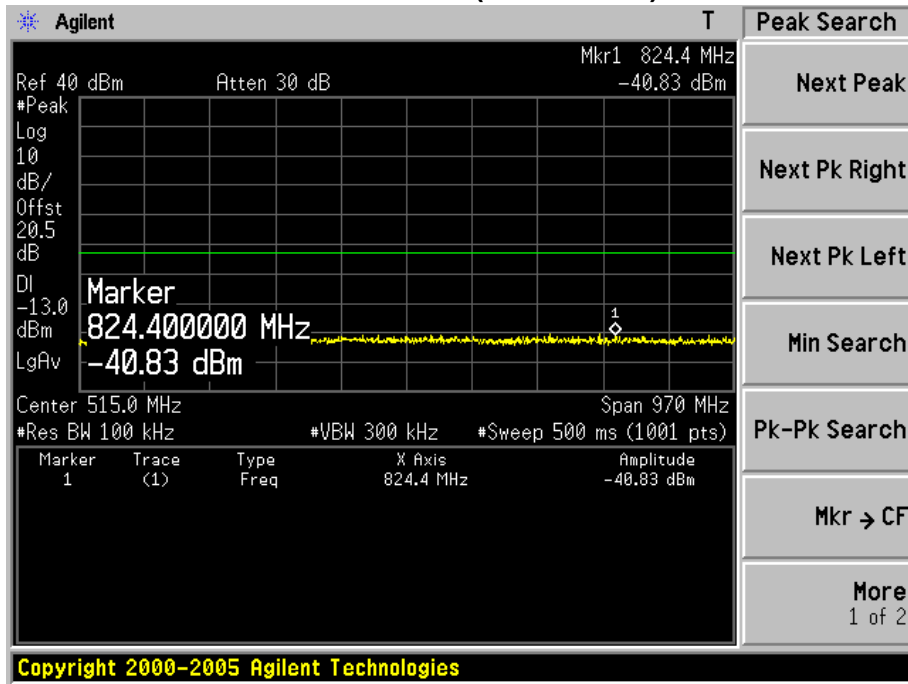


Product	Wireless Module		
Test Item	Conducted Spurious Emission		
Test Mode	Mode 2: PCS1900 Link		
Date of Test	2014/12/28	Test Site	TR8

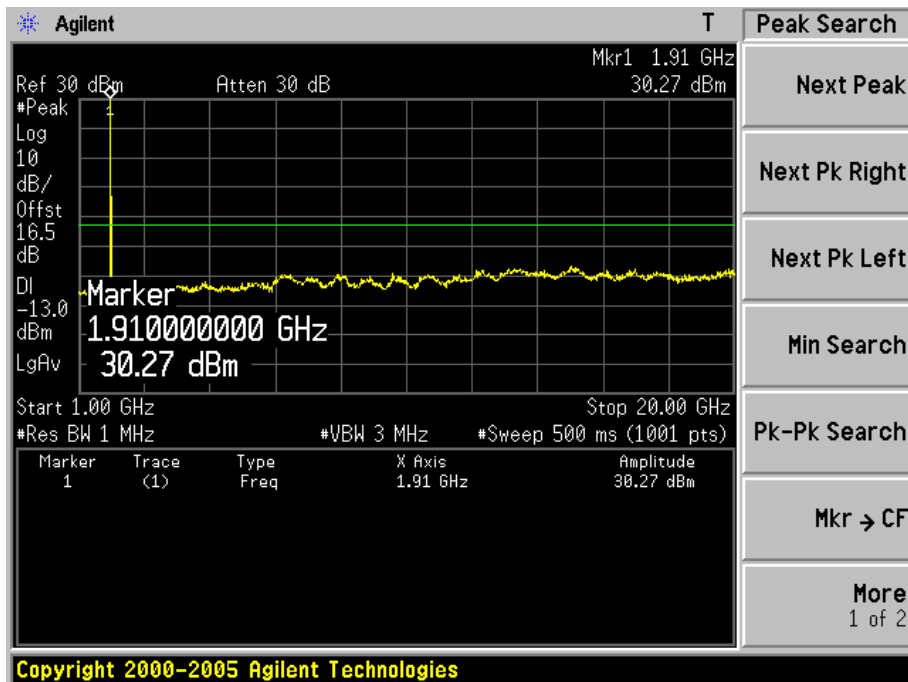
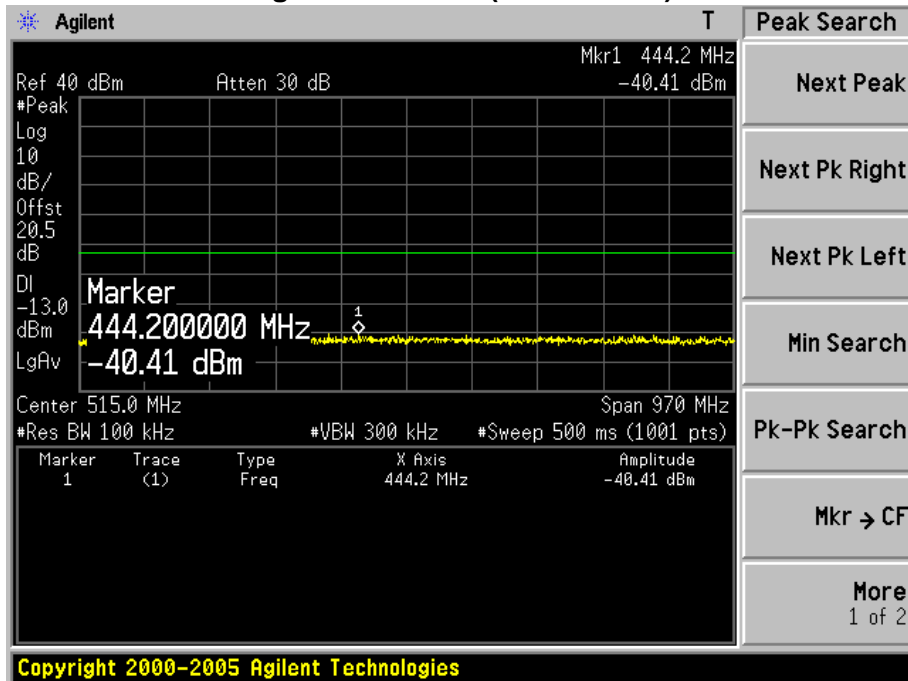
### Low Channel 512(1850.20MHz)



Mid Channel 661(1880.00MHz)

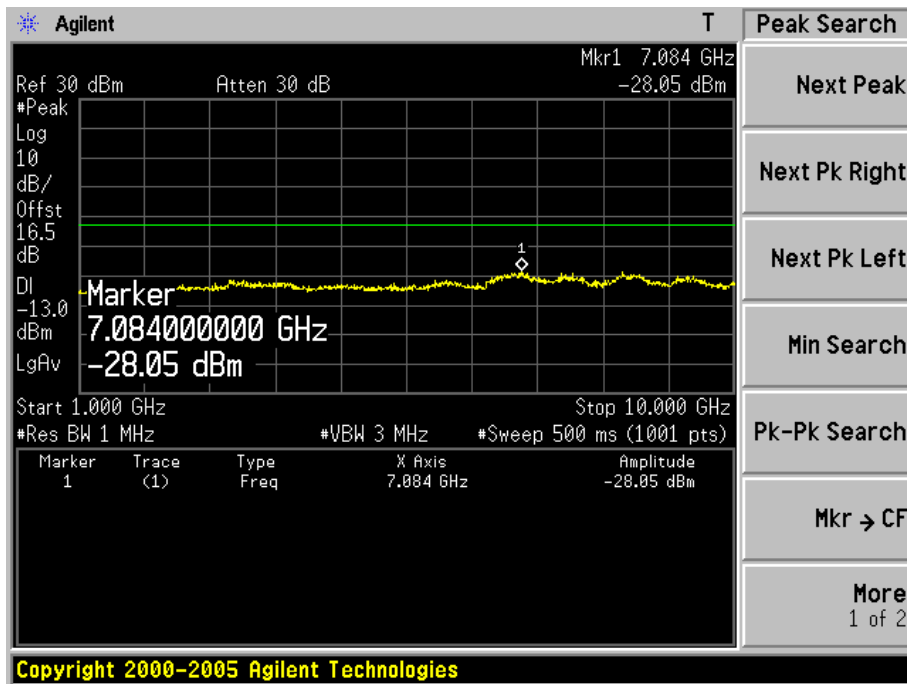
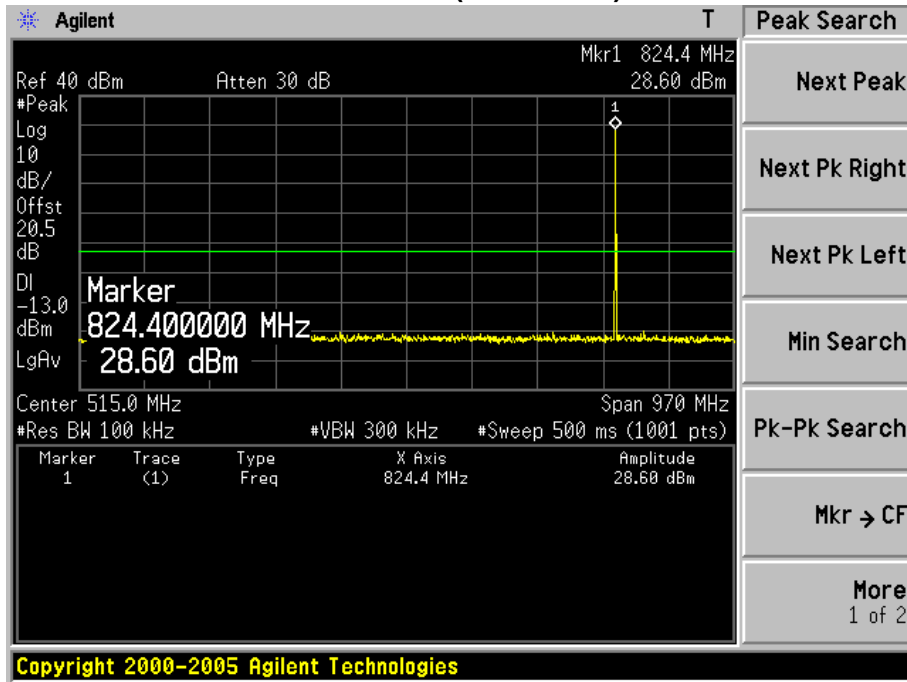


High Channel 810(1909.80MHz)



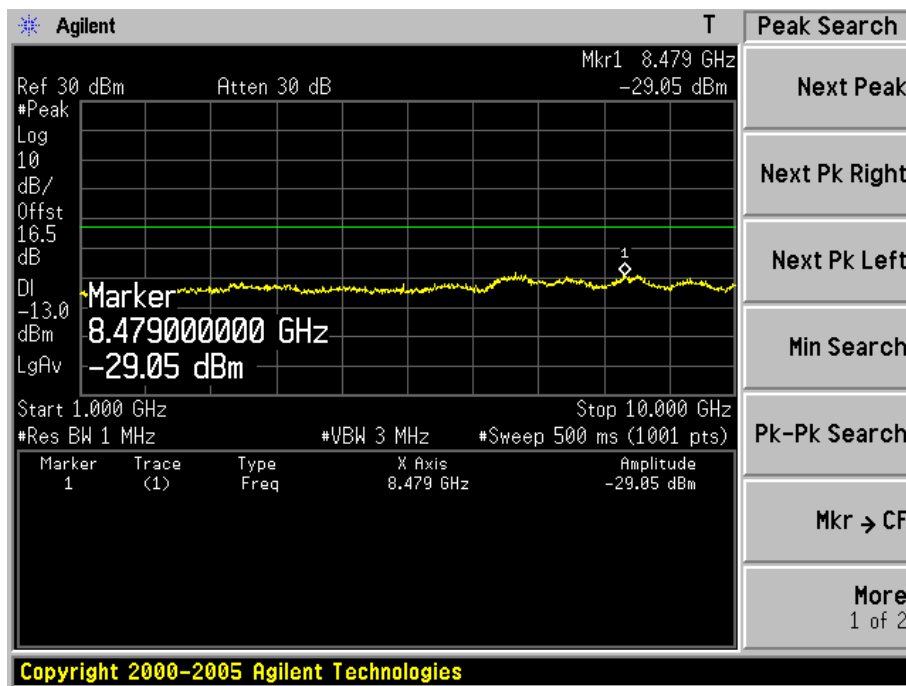
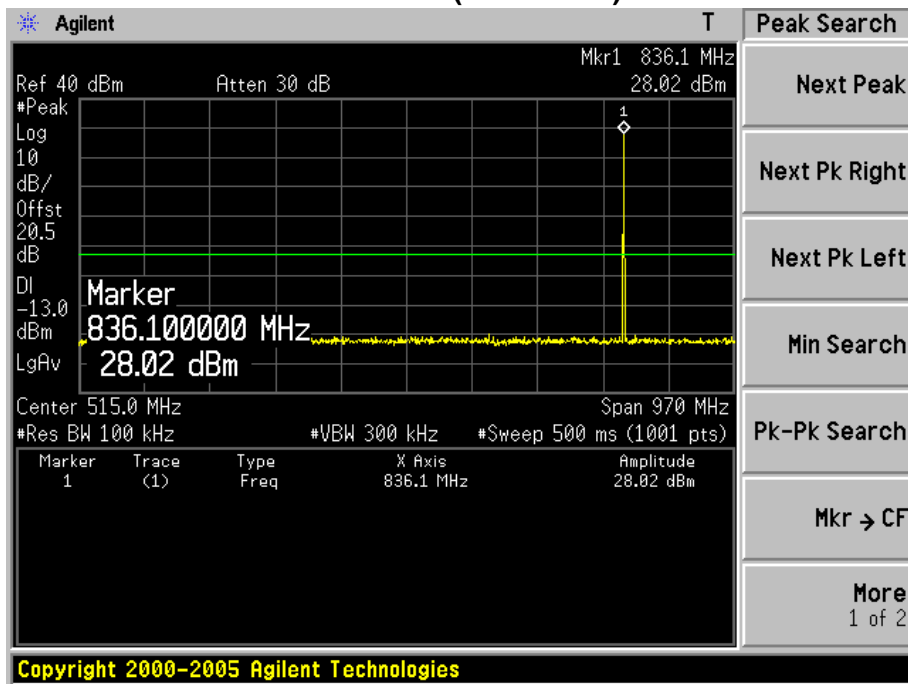
Product	Wireless Module		
Test Item	Conducted Spurious Emission		
Test Mode	Mode 3: EDGE 850 Link		
Date of Test	2014/12/28	Test Site	TR8

### Low Channel 128(824.20MHz)

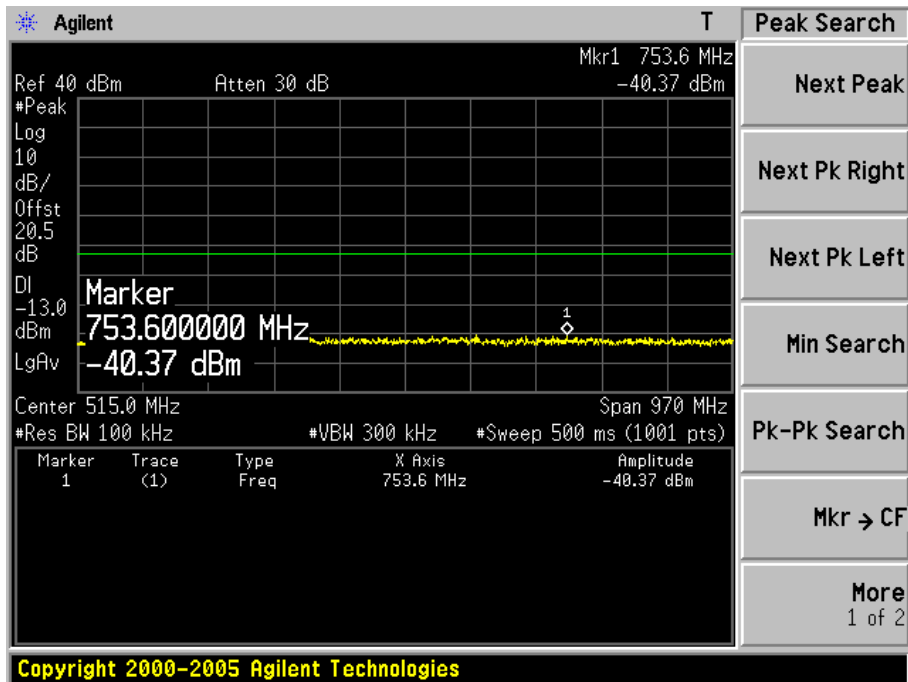
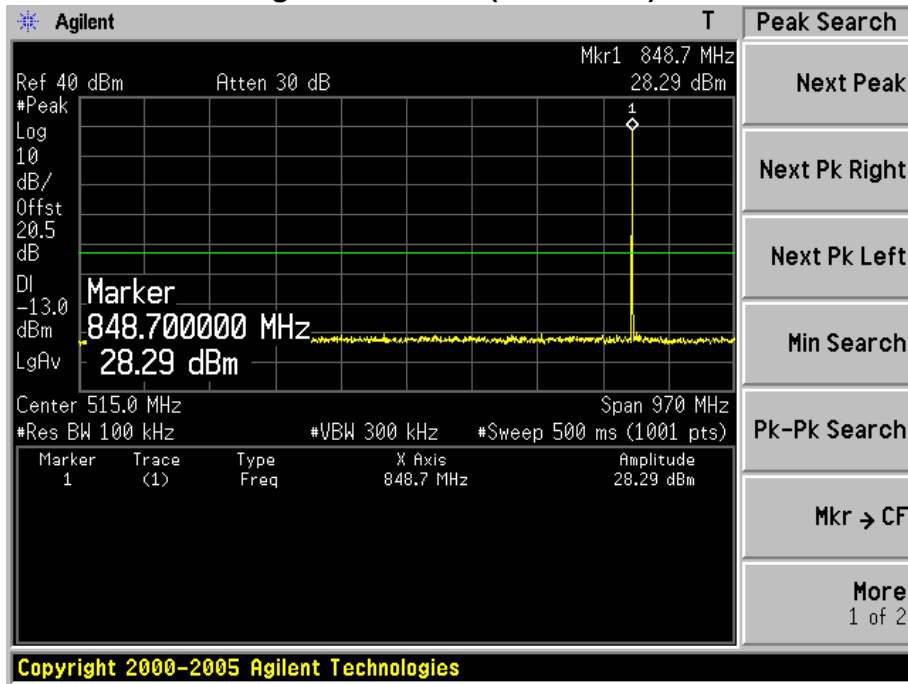




Mid Channel 189(836.40MHz)

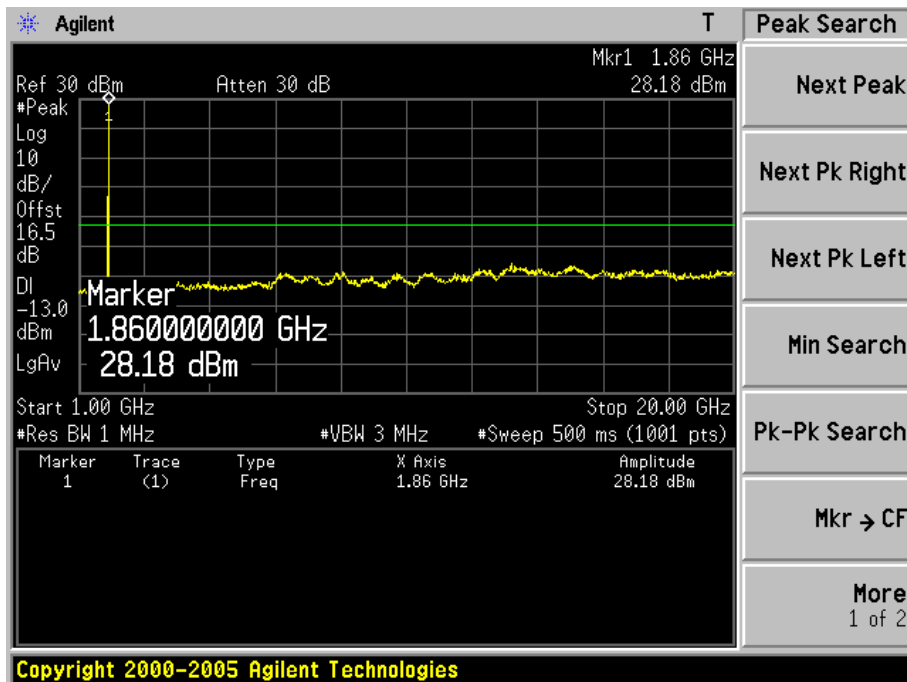
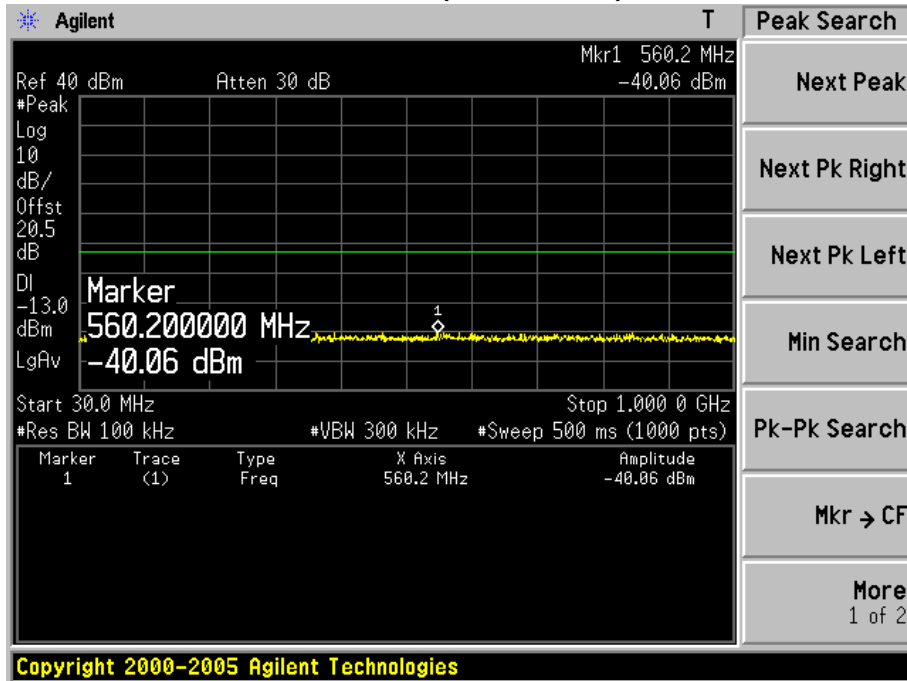


High Channel 251(848.80MHz)

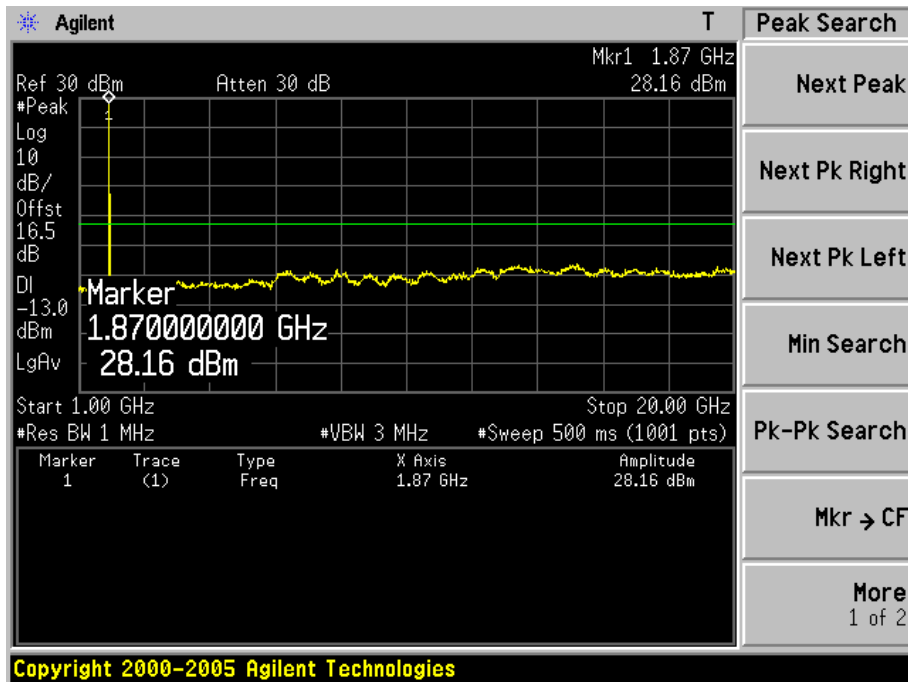
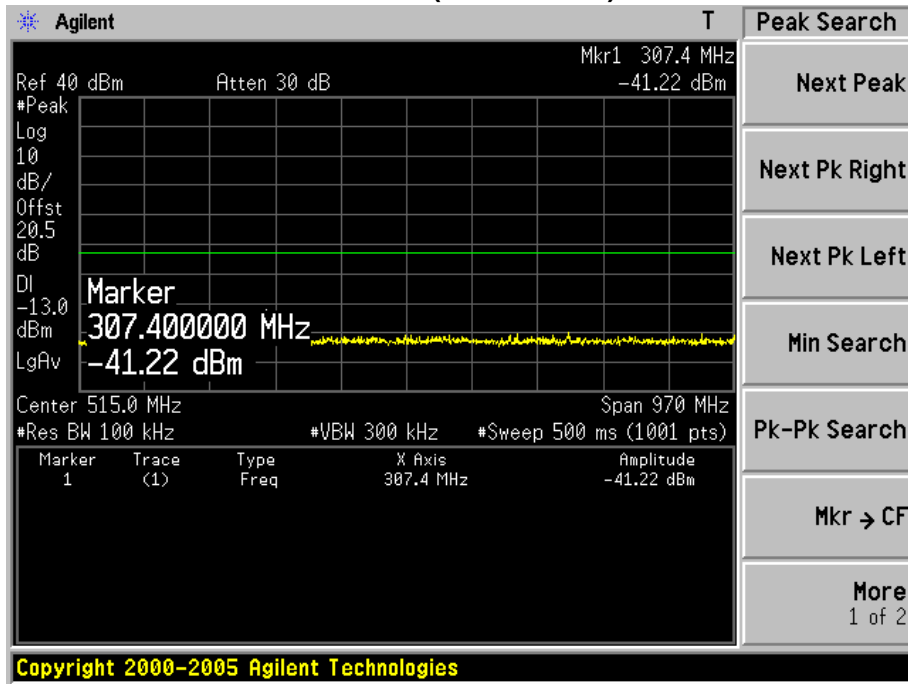


Product	Wireless Module		
Test Item	Conducted Spurious Emission		
Test Mode	Mode 4: EDGE1900 Link		
Date of Test	2014/12/28	Test Site	TR8

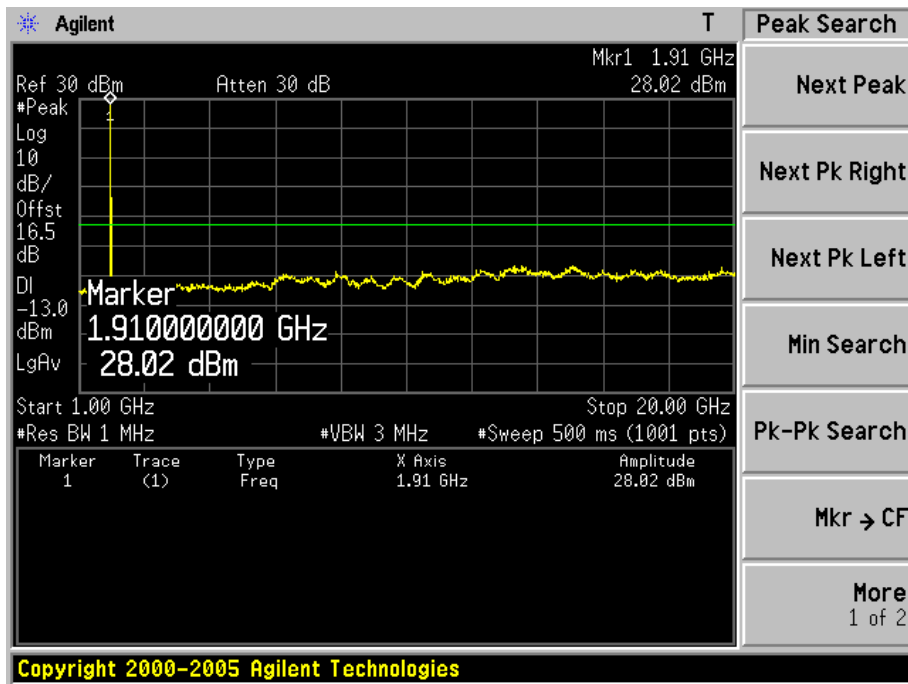
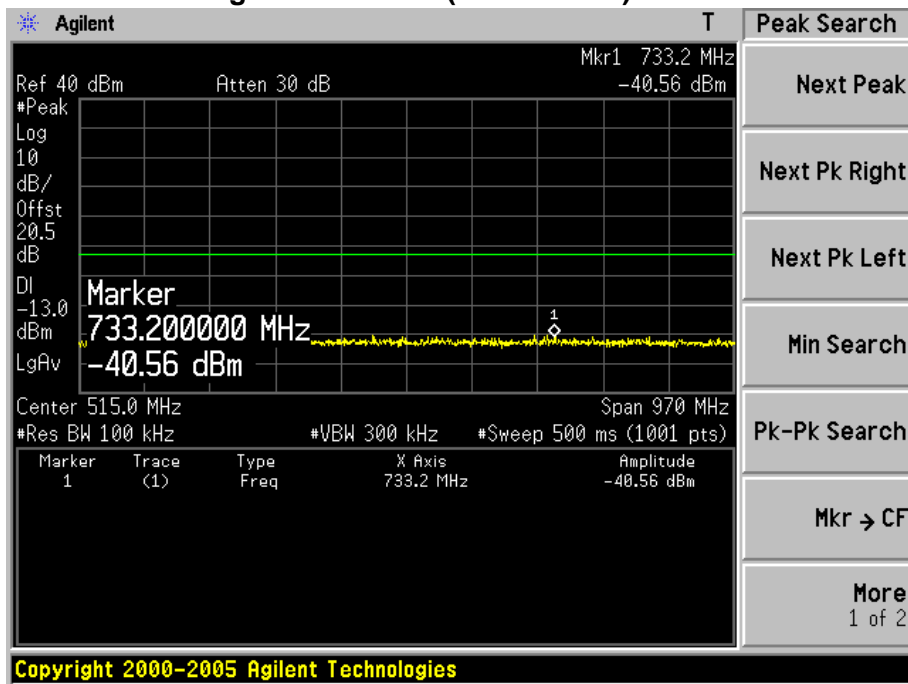
### Low Channel 512(1850.20MHz)



Mid Channel 661(1880.00MHz)

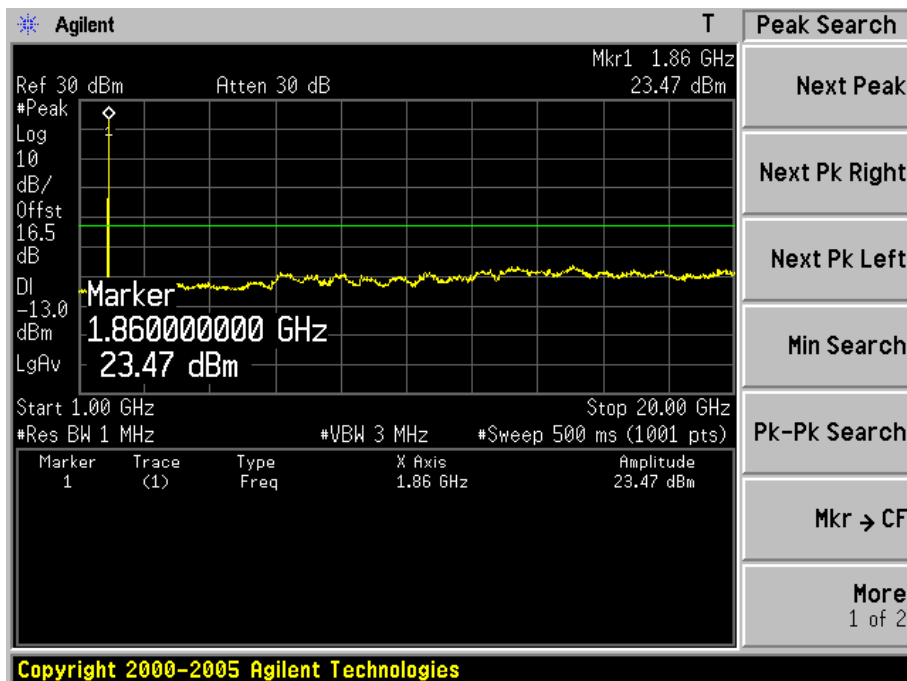
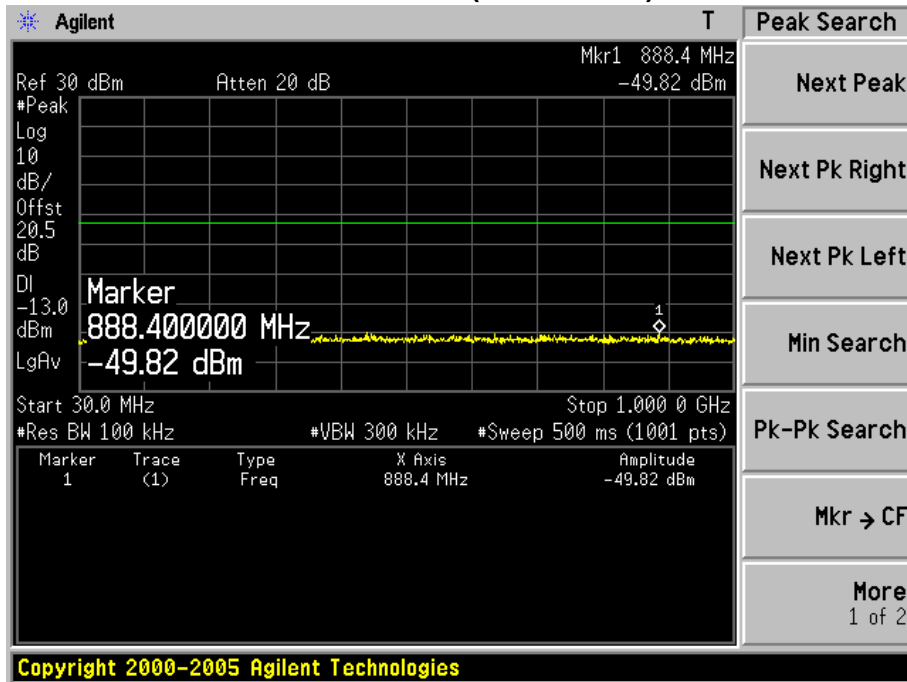


High Channel 810(1909.80MHz)

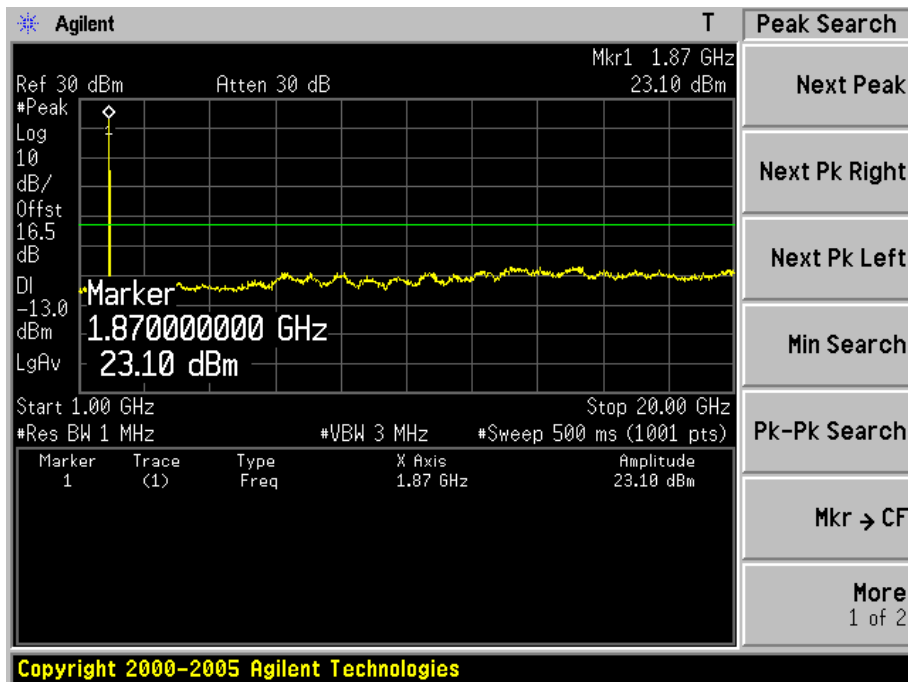
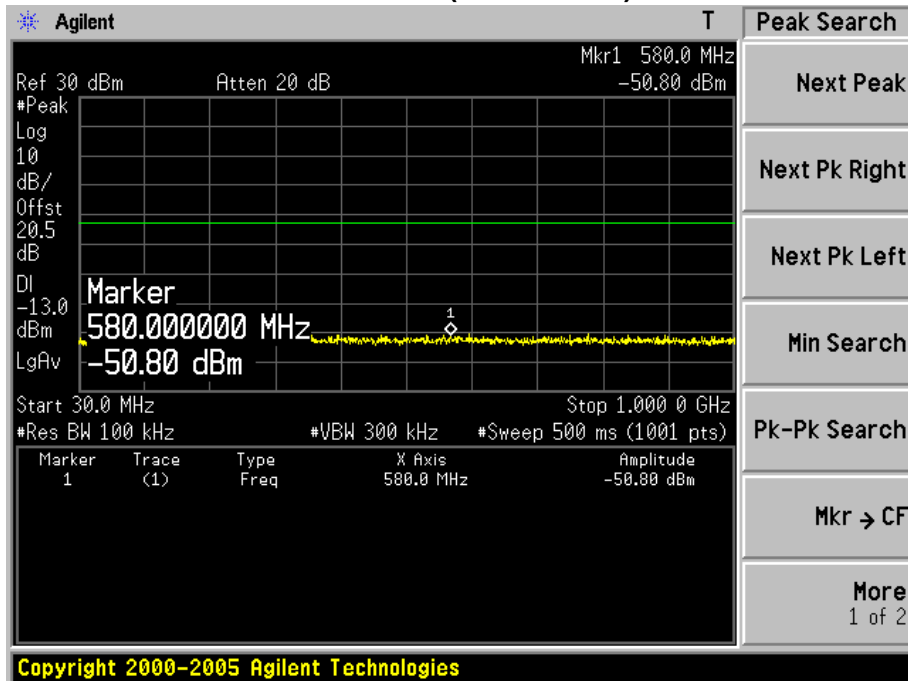


Product	Wireless Module		
Test Item	Conducted Spurious Emission		
Test Mode	Mode 5: WCDMA Band II Link		
Date of Test	2014/12/28	Test Site	TR8

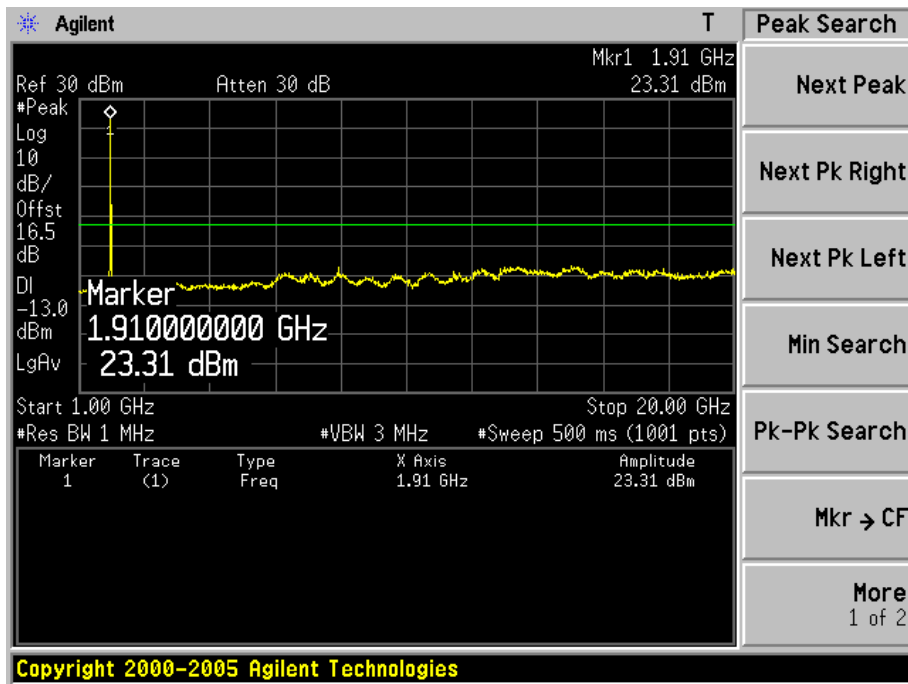
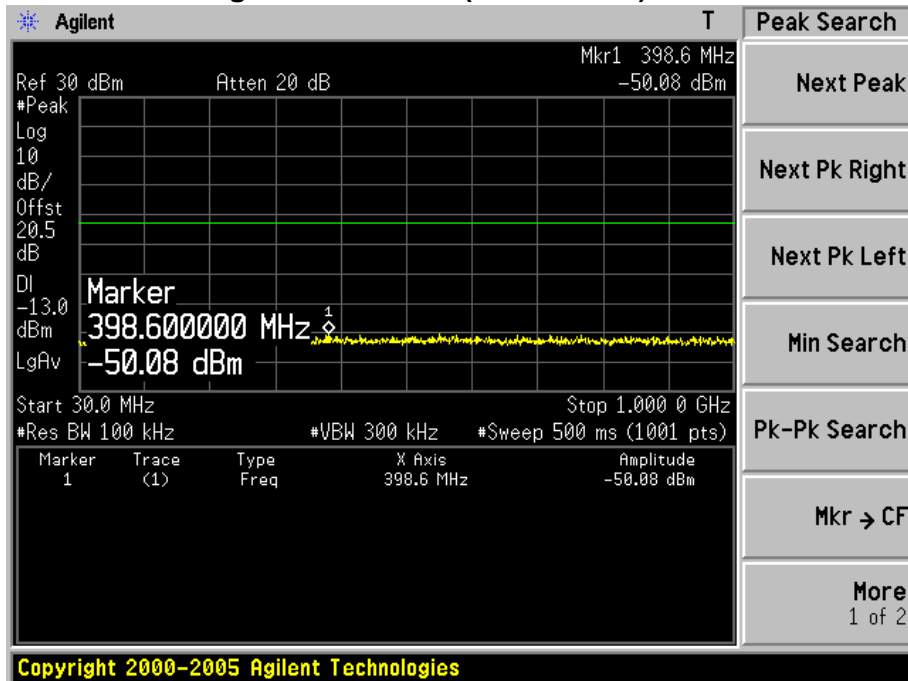
### Low Channel 9262(1852.40MHz)



Mid Channel 9400(1880.00MHz)



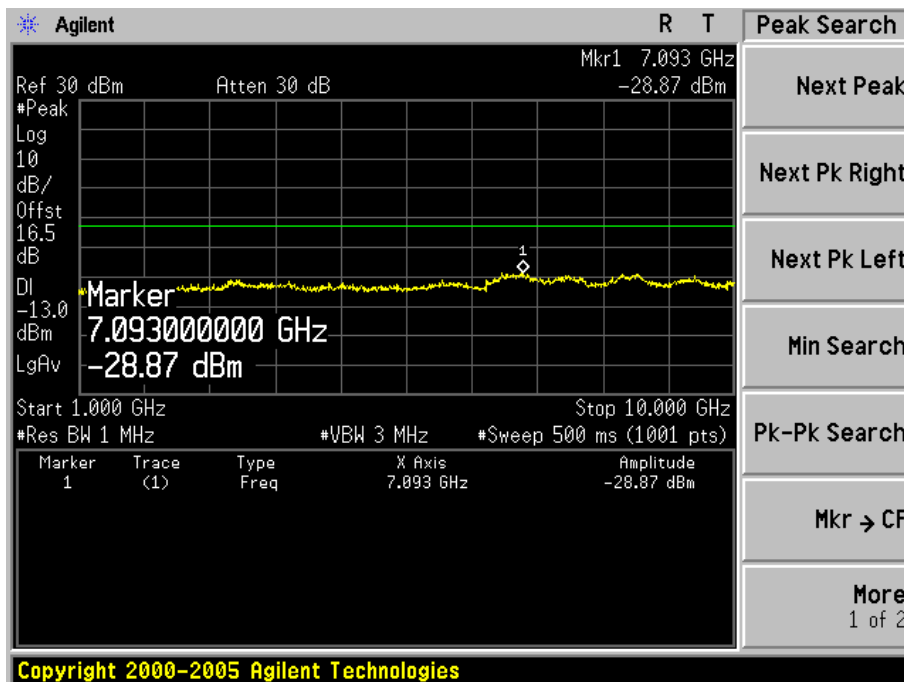
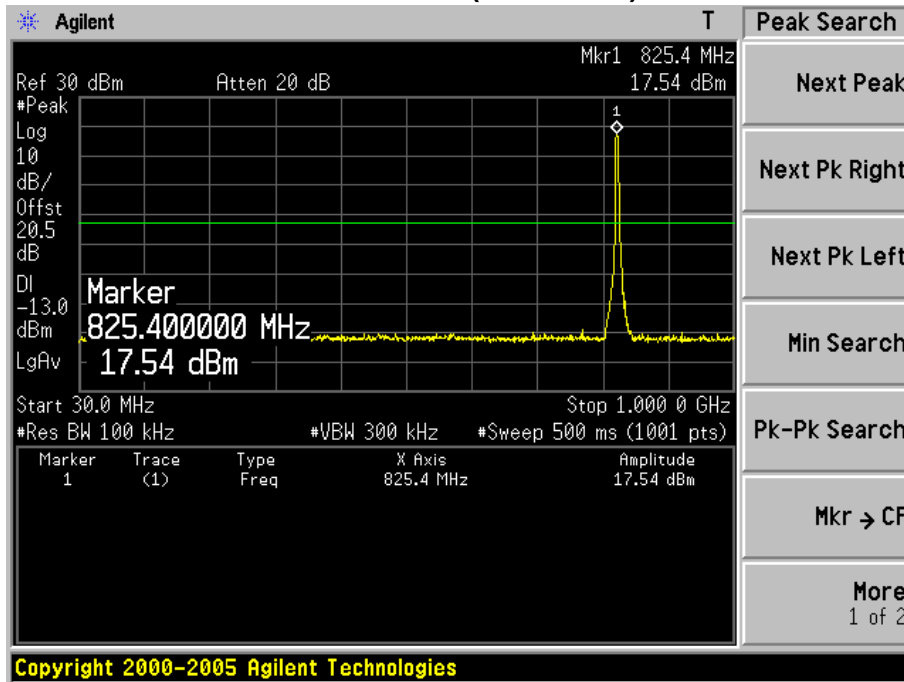
High Channel 9538(1907.60MHz)



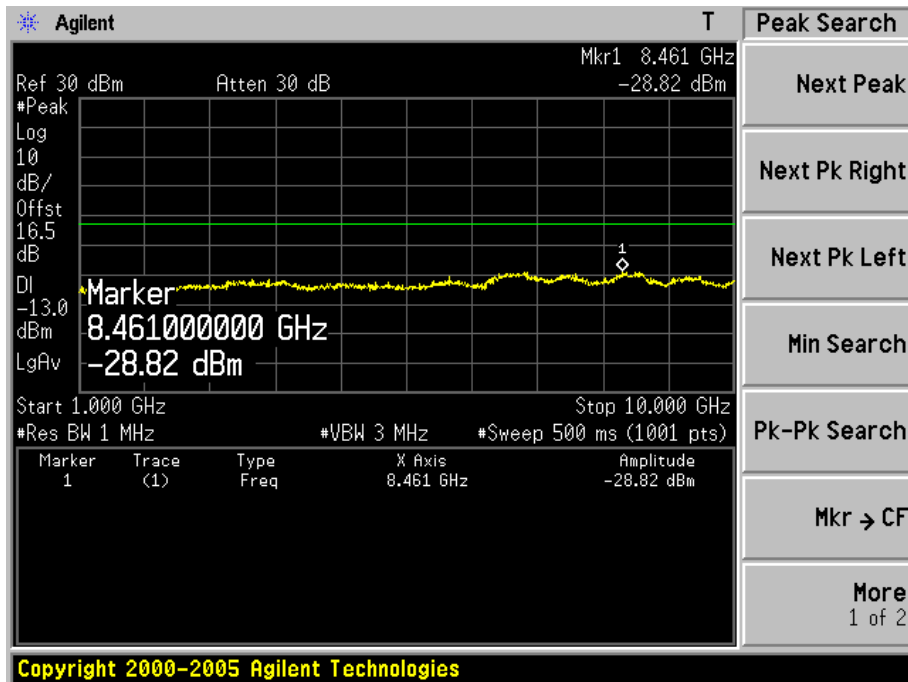
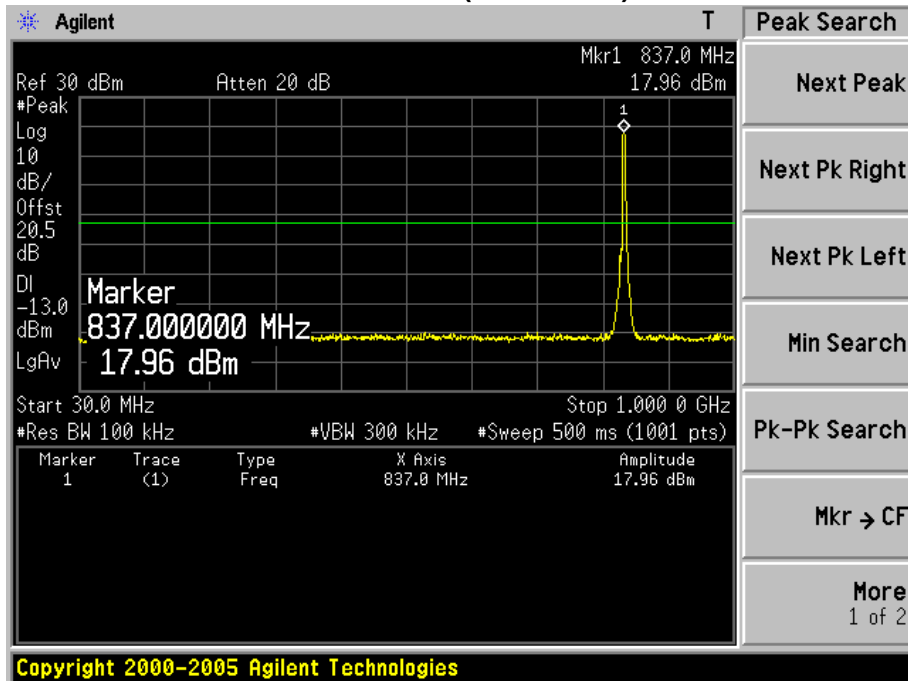


Product	Wireless Module		
Test Item	Conducted Spurious Emission		
Test Mode	Mode 6: WCDMA Band V Link		
Date of Test	2014/12/28	Test Site	TR8

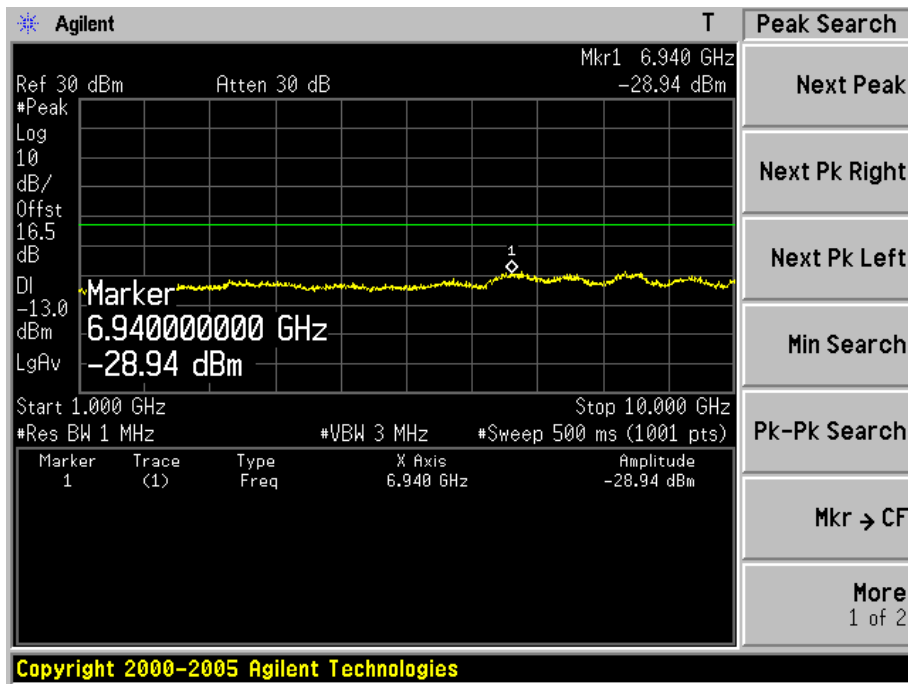
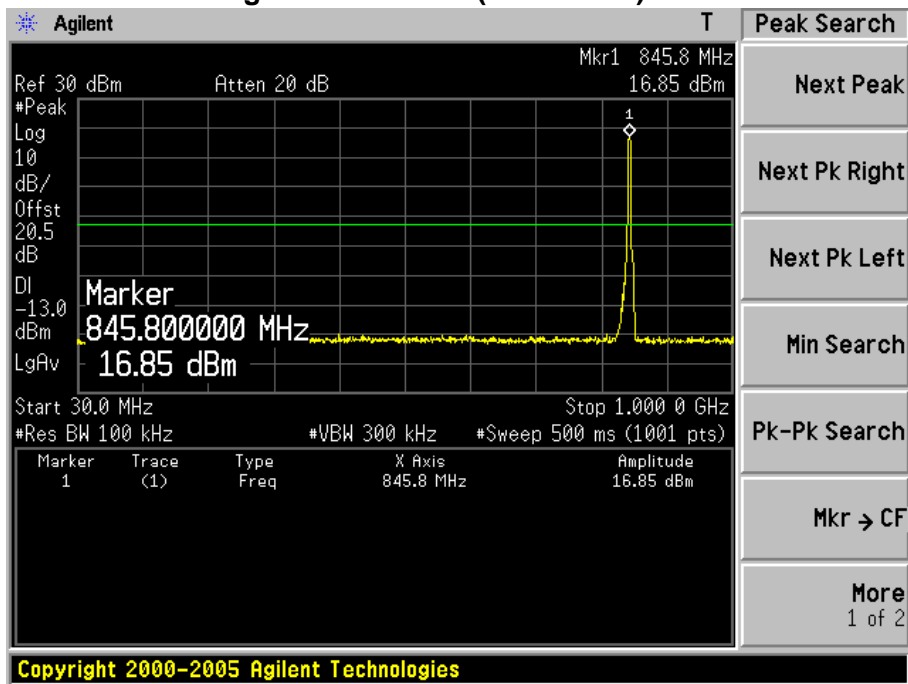
### Low Channel 4132(826.40MHz)



Mid Channel 4182(836.40MHz)



High Channel 4233(846.60MHz)



Product	Wireless Module		
Test Item	Radiated Spurious Emission		
Test Mode	Mode 1: GSM 850 Link		
Date of Test	2014/11/21	Test Site	AC-5

Frequency (MHz)	SA Reading (dBm)	Ant.Pol. (H/V)	SG Reading (dBm)	Cable Loss (dB)	Gain (dBi)	EIRP (dBm)	Limit (dBm)	Margin (dB)
Low Channel 128 (824.20MHz)								
1646.00	-50.43	V	-53.06	2.50	9.75	-45.81	-13.00	-32.81
2470.50	-58.96	V	-57.87	3.12	10.48	-50.51	-13.00	-37.51
1646.00	-52.32	H	-54.87	2.50	9.75	-47.62	-13.00	-34.62
2470.50	-61.46	H	-60.53	3.12	10.48	-53.17	-13.00	-40.17
Middle Channel 189 (836.40MHz)								
1671.50	-52.28	V	-54.67	2.52	9.95	-47.24	-13.00	-34.24
2513.00	-57.07	V	-56.07	3.18	10.62	-48.63	-13.00	-35.63
1671.50	-57.10	H	-59.77	2.52	9.95	-52.34	-13.00	-39.34
2513.00	-59.23	H	-58.61	3.18	10.62	-51.17	-13.00	-38.17
High Channel 251 (848.80MHz)								
1697.00	-56.38	V	-58.38	2.54	10.06	-50.86	-13.00	-37.86
2547.00	-59.14	V	-57.34	3.14	10.68	-49.80	-13.00	-36.80
1697.00	-57.52	H	-60.25	2.54	10.06	-52.73	-13.00	-39.73
2547.00	-59.13	H	-57.58	3.14	10.68	-50.04	-13.00	-37.04

Product	Wireless Module		
Test Item	Radiated Spurious Emission		
Test Mode	Mode 2: PCS 1900 Link		
Date of Test	2014/11/21	Test Site	AC-5

Frequency (MHz)	SA Reading (dBm)	Ant.Pol. (H/V)	SG Reading (dBm)	Cable Loss (dB)	Gain (dBi)	EIRP (dBm)	Limit (dBm)	Margin (dB)
Low Channel 512 (1850.20MHz)								
3700.00	-64.29	V	-60.92	3.84	12.69	-52.07	-13.00	-39.07
5550.00	-66.39	V	-58.51	4.82	13.15	-50.18	-13.00	-37.18
3700.00	-64.31	H	-60.87	3.84	12.69	-52.02	-13.00	-39.02
5550.00	-66.46	H	-57.96	4.82	13.15	-49.63	-13.00	-36.63
Middle Channel 661 (1880.00MHz)								
3760.00	-62.02	V	-58.75	3.73	12.72	-49.76	-13.00	-36.76
5640.00	-55.20	V	-47.58	4.93	13.14	-39.37	-13.00	-26.37
3760.00	-61.94	H	-58.73	3.73	12.72	-49.74	-13.00	-36.74
5640.00	-52.59	H	-44.65	4.93	13.14	-36.44	-13.00	-23.44
High Channel 810 (1909.80MHz)								
3818.00	-57.57	V	-53.69	4.02	12.73	-44.98	-13.00	-31.98
5727.00	-57.21	V	-48.95	4.87	13.11	-40.71	-13.00	-27.71
3818.00	-57.77	H	-54.05	4.02	12.73	-45.34	-13.00	-32.34
5727.00	-50.80	H	-42.13	4.87	13.11	-33.89	-13.00	-20.89

Product	Wireless Module		
Test Item	Radiated Spurious Emission		
Test Mode	Mode 3: EDGE S850 Link		
Date of Test	2014/11/21	Test Site	AC5

Frequency (MHz)	SA Reading (dBm)	Ant.Pol. (H/V)	SG Reading (dBm)	Cable Loss (dB)	Gain (dBi)	EIRP (dBm)	Limit (dBm)	Margin (dB)
Low Channel 128 (824.20MHz)								
1646.00	-58.91	V	-61.54	2.50	9.75	-54.29	-13.00	-41.29
2470.50	-61.59	V	-60.50	3.12	10.48	-53.14	-13.00	-40.14
1646.00	-61.26	H	-63.82	2.50	9.75	-56.57	-13.00	-43.57
2470.50	-64.64	H	-63.72	3.12	10.48	-56.36	-13.00	-43.36
Middle Channel 189 (836.40MHz)								
1671.50	-61.29	V	-63.82	2.52	9.95	-56.39	-13.00	-43.39
2513.00	-52.68	V	-55.08	3.18	10.62	-47.64	-13.00	-34.64
1671.50	-61.19	H	-64.89	2.52	9.95	-57.46	-13.00	-44.46
2513.00	-55.26	H	-57.93	3.18	10.62	-50.49	-13.00	-37.49
High Channel 251 (848.80MHz)								
1697.00	-62.50	V	-64.50	2.54	10.06	-56.98	-13.00	-43.98
2547.00	-63.86	V	-62.05	3.14	10.68	-54.51	-13.00	-41.51
1697.00	-61.42	H	-64.15	2.54	10.06	-56.63	-13.00	-43.63
2547.00	-63.88	H	-62.33	3.14	10.68	-54.79	-13.00	-41.79

Product	Wireless Module		
Test Item	Radiated Spurious Emission		
Test Mode	Mode 4: EDGE 1900 Link		
Date of Test	2014/11/21	Test Site	AC5

Frequency (MHz)	SA Reading (dBm)	Ant.Pol. (H/V)	SG Reading (dBm)	Cable Loss (dB)	Gain (dBi)	EIRP (dBm)	Limit (dBm)	Margin (dB)
Low Channel 512 (1850.20MHz)								
3700.00	-61.54	V	-58.18	3.84	12.69	-49.33	-13.00	-36.33
5550.00	-56.40	V	-48.51	4.82	13.15	-40.18	-13.00	-27.18
3700.00	-61.51	H	-58.08	3.84	12.69	-49.23	-13.00	-36.23
5550.00	-54.95	H	-46.44	4.82	13.15	-38.11	-13.00	-25.11
Middle Channel 661 (1880.00MHz)								
3760.00	-63.15	V	-59.87	3.73	12.72	-50.88	-13.00	-37.88
5640.00	-63.52	V	-55.89	4.93	13.14	-47.68	-13.00	-34.68
3760.00	-62.11	H	-58.91	3.73	12.72	-49.92	-13.00	-36.92
5640.00	-53.82	H	-45.88	4.93	13.14	-37.67	-13.00	-24.67
High Channel 810 (1909.80MHz)								
3818.00	-60.74	V	-56.86	4.02	12.73	-48.15	-13.00	-35.15
5727.00	-59.69	V	-51.43	4.87	13.11	-43.19	-13.00	-30.19
3818.00	-57.17	H	-53.45	4.02	12.73	-44.74	-13.00	-31.74
5727.00	-56.96	H	-48.29	4.87	13.11	-40.05	-13.00	-27.05

Product	Wireless Module		
Test Item	Radiated Spurious Emission		
Test Mode	Mode5: WCDMA Band II Link		
Date of Test	2014/11/21	Test Site	AC5

Frequency (MHz)	SA Reading (dBm)	Ant.Pol. (H/V)	SG Reading (dBm)	Cable Loss (dB)	Gain (dBi)	EIRP (dBm)	Limit (dBm)	Margin (dB)
Low Channel 9262 (1852.40MHz)								
3704.80	-49.72	V	-45.41	4.78	12.69	-37.50	-13.00	-24.50
5557.20	-59.18	V	-50.48	4.82	13.15	-42.15	-13.00	-29.15
3704.80	-45.73	H	-41.34	4.78	12.69	-33.43	-13.00	-20.43
5557.20	-59.64	H	-51.30	4.82	13.15	-42.97	-13.00	-29.97
Middle Channel 9400 (1880.00MHz)								
3760.00	-44.78	V	-40.18	5.03	12.72	-32.49	-13.00	-19.49
5640.00	-59.31	V	-50.78	5.93	13.14	-43.57	-13.00	-30.57
3760.00	-38.95	H	-34.45	5.03	12.72	-26.76	-13.00	-13.76
5640.00	-60.82	H	-50.77	5.93	13.14	-43.56	-13.00	-30.56
High Channel 9538 (1907.60MHz)								
3815.20	-41.91	V	-37.00	5.03	12.73	-29.30	-13.00	-16.30
5722.80	-58.50	V	-50.26	4.87	13.11	-42.02	-13.00	-29.02
3815.20	-40.14	H	-35.40	5.03	12.73	-27.70	-13.00	-14.70
5722.80	-57.50	H	-48.92	4.87	13.11	-40.68	-13.00	-27.68



Product	Wireless Module		
Test Item	Radiated Spurious Emission		
Test Mode	Mode 6: WCDMA Band V Traffic		
Date of Test	2014/11/21	Test Site	AC5

Frequency (MHz)	SA Reading (dBm)	Ant.Pol. (H/V)	SG Reading (dBm)	Cable Loss (dB)	Gain (dBi)	EIRP (dBm)	Limit (dBm)	Margin (dB)
Low Channel 4132 (826.40MHz)								
1654.50	-50.53	V	-52.30	3.28	9.75	-45.83	-13.00	-32.83
2479.20	-57.42	V	-53.07	4.10	10.48	-46.69	-13.00	-33.69
1654.50	-49.80	H	-51.55	3.28	9.75	-45.08	-13.00	-32.08
2479.00	-63.30	H	-57.75	4.10	10.48	-51.37	-13.00	-38.37
Middle Channel 4182 (836.40MHz)								
1671.50	-51.68	V	-53.24	3.32	9.95	-46.61	-13.00	-33.61
2513.00	-62.75	V	-56.86	4.31	10.62	-50.55	-13.00	-37.55
1671.50	-47.45	H	-49.31	3.32	9.95	-42.68	-13.00	-29.68
2513.00	-63.23	H	-57.49	4.31	10.62	-51.18	-13.00	-38.18
High Channel 4233 (846.60MHz)								
1697.00	-47.45	V	-49.39	3.35	10.06	-42.68	-13.00	-29.68
2539.80	-63.23	V	-57.60	3.91	10.33	-51.18	-13.00	-38.18
1697.00	-47.02	H	-48.72	4.19	10.68	-42.23	-13.00	-29.23
2538.50	-64.75	H	-59.31	4.33	10.79	-52.85	-13.00	-39.85

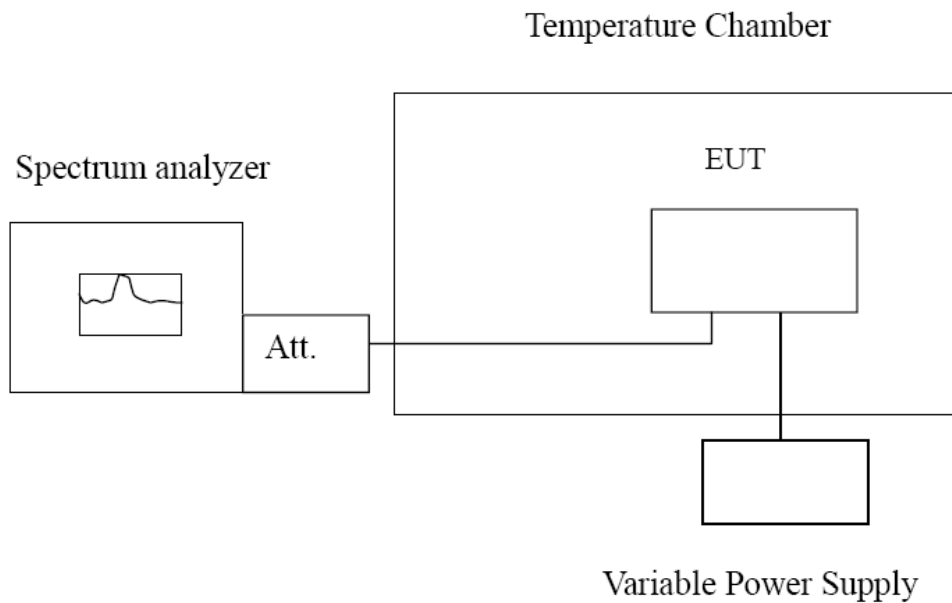
## 8. Frequency Stability Under Temperature & Voltage Variations

### 8.1. Test Equipment

Frequency Stability Under Temperature & Voltage Variations / AC-6

Instrument	Manufacturer	Type No.	Serial No	Cali. Due Date
PSA Series Spectrum Analyzer	Agilent	E4440A	MY49420184	2015.03.28
Radio Communication Tester	R&S	CMU 200	117088	2015.03.28
Dual Directional Coupler	Agilent	778D	20160	2015.03.28
10dB Coaxial Coupler	Agilent	87300C	MY44300299	2015.03.28
DC Power Supply	IDRC	CD-035-020PR	977272	2015.03.28
Temperature & Humidity Chamber	Gaoyu	TH-1P-B	WIT-05121302	2016.01.07
Temperature/Humidity Meter	Zhicheng	ZC1-2	AC6-TH	2016.01.07

### 8.2. Test Setup



### 8.3. Test Procedure

#### **Frequency Stability Under Temperature Variations:**

The equipment under test was connected to an external AC or DC power supply and input rated voltage. RF output was connected to a frequency counter or spectrum analyzer via feed through attenuators. The EUT was placed inside the temperature chamber. Set the spectrum analyzer RBW low enough to obtain the desired frequency resolution and measure EUT 20°C operating frequency as reference frequency. Turn EUT off and set the chamber temperature to -30°C. After the temperature stabilized for approximately 30 minutes recorded the frequency. Repeat step measure with 10°C increased per stage until the highest temperature of +50°C reached.

#### **Frequency Stability Under Voltage Variations:**

Set chamber temperature to 20°C. Use a variable AC power supply / DC power source to power the EUT and set the voltage to rated voltage. Set the spectrum analyzer RBW low enough to obtain the desired frequency resolution and recorded the frequency.

Reduce the input voltage to specify extreme voltage variation ( $\pm 15\%$ ) and endpoint, record the maximum frequency change.

### 8.4. Uncertainty

The measurement uncertainty is defined as  $\pm 10$  Hz.

**8.5. Test Result**

Product	Wireless Module		
Test Item	Frequency Stability Under Temperature & Voltage Variations		
Test Mode	Mode 1: GSM 850 Link		
Date of Test	2014/12/29	Test Site	AC6

Frequency Stability under Temperature

Temperature Interval (°C)	Test Frequency (MHz)	Deviation (Hz)	Limit (Hz)
-30	836.40	61	± 2091
-20	836.40	-14	± 2091
-10	836.40	44	± 2091
0	836.40	33	± 2091
10	836.40	49	± 2091
20	836.40	23	± 2091
30	836.40	63	± 2091
40	836.40	55	± 2091
50	836.40	-58	± 2091

Frequency Stability under Voltage

DC Voltage (V)	Test Frequency (MHz)	Deviation (Hz)	Limit (Hz)
3.4	836.40	33	± 2091
3.7	836.40	52	± 2091
4.2	836.40	-19	± 2091

Product	Wireless Module		
Test Item	Frequency Stability Under Temperature & Voltage Variations		
Test Mode	Mode 2: PCS1900 Link		
Date of Test	2014/12/29	Test Site	AC6

Frequency Stability under Temperature

Temperature Interval (°C)	Test Frequency (MHz)	Deviation (Hz)	Limit (Hz)
-30	1880.00	43	± 4700
-20	1880.00	57	± 4700
-10	1880.00	32	± 4700
0	1880.00	36	± 4700
10	1880.00	44	± 4700
20	1880.00	39	± 4700
30	1880.00	59	± 4700
40	1880.00	-23	± 4700
50	1880.00	50	± 4700

Frequency Stability under Voltage

DC Voltage (V)	Test Frequency (MHz)	Deviation (Hz)	Limit (Hz)
3.4	1880.00	62	± 4700
3.7	1880.00	-32	± 4700
4.2	1880.00	-47	± 4700

Product	Wireless Module		
Test Item	Frequency Stability Under Temperature & Voltage Variations		
Test Mode	Mode 3: EDGE 850 Link		
Date of Test	2014/12/29	Test Site	TR7

Frequency Stability under Temperature

Temperature Interval (°C)	Test Frequency (MHz)	Deviation (Hz)	Limit (Hz)
-30	836.40	40	± 2091
-20	836.40	30	± 2091
-10	836.40	34	± 2091
0	836.40	62	± 2091
10	836.40	-31	± 2091
20	836.40	15	± 2091
30	836.40	33	± 2091
40	836.40	-13	± 2091
50	836.40	34	± 2091

Frequency Stability under Voltage

DC Voltage (V)	Test Frequency (MHz)	Deviation (Hz)	Limit (Hz)
3.4	836.40	29	± 2091
3.7	836.40	-18	± 2091
4.2	836.40	43	± 2091

Product	Wireless Module		
Test Item	Frequency Stability Under Temperature & Voltage Variations		
Test Mode	Mode 4: EDGE1900 Link		
Date of Test	2014/12/29	Test Site	TR7

### Frequency Stability under Temperature

Temperature Interval (°C)	Test Frequency (MHz)	Deviation (Hz)	Limit (Hz)
-30	1880.00	11	± 4700
-20	1880.00	-20	± 4700
-10	1880.00	43	± 4700
0	1880.00	50	± 4700
10	1880.00	-44	± 4700
20	1880.00	-10	± 4700
30	1880.00	74	± 4700
40	1880.00	30	± 4700
50	1880.00	-29	± 4700

### Frequency Stability under Voltage

DC Voltage (V)	Test Frequency (MHz)	Deviation (Hz)	Limit (Hz)
3.4	1880.00	-32	± 4700
3.7	1880.00	43	± 4700
4.2	1880.00	-36	± 4700

Product	Wireless Module		
Test Item	Frequency Stability Under Temperature & Voltage Variations		
Test Mode	Mode 5: WCDMA Band II Link		
Date of Test	2014/12/29	Test Site	TR7

### Frequency Stability under Temperature

Temperature Interval (°C)	Test Frequency (MHz)	Deviation (Hz)	Limit (Hz)
-30	1880.00	26	± 4700
-20	1880.00	30	± 4700
-10	1880.00	25	± 4700
0	1880.00	34	± 4700
10	1880.00	28	± 4700
20	1880.00	35	± 4700
30	1880.00	43	± 4700
40	1880.00	77	± 4700
50	1880.00	-6	± 4700

### Frequency Stability under Voltage

DC Voltage (V)	Test Frequency (MHz)	Deviation (Hz)	Limit (Hz)
3.4	1880.00	20	± 4700
3.7	1880.00	-10	± 4700
4.2	1880.00	29	± 4700



Product	Wireless Module		
Test Item	Frequency Stability Under Temperature & Voltage Variations		
Test Mode	Mode 6: WCDMA Band V Link		
Date of Test	2014/12/29	Test Site	TR7

### Frequency Stability under Temperature

Temperature Interval (°C)	Test Frequency (MHz)	Deviation (Hz)	Limit (Hz)
-30	836.40	19	± 2091
-20	836.40	45	± 2091
-10	836.40	-33	± 2091
0	836.40	41	± 2091
10	836.40	23	± 2091
20	836.40	35	± 2091
30	836.40	47	± 2091
40	836.40	50	± 2091
50	836.40	-47	± 2091

### Frequency Stability under Voltage

DC Voltage (V)	Test Frequency (MHz)	Deviation (Hz)	Limit (Hz)
3.4	836.40	-64	± 2091
3.7	836.40	44	± 2091
4.2	836.40	29	± 2091

————— The End —————

檔名: 1510280R-RF-FCC 22H&24E  
GSM&WCDMA-Wireless Module-AR7558-V1  
目錄: D:\Backup\我的文档  
範本: C:\Documents and Settings\aliceni\Application  
Data\Microsoft\Templates\Normal.dotm  
標題: 1  
主旨:  
作者: JackyLee  
關鍵字:  
註解:  
建立日期: 2007/1/26 2:07:00 PM  
修訂版編號: 104  
前次更新日期: 2015/3/16 2:53:00 PM  
前次存檔人員: aliceni  
編輯總時間: 1,222 分鐘  
最後列印在: 2015/3/16 2:54:00 PM  
最後列印的字數  
頁數: 81  
字數: 6,308 (約)  
字元數: 35,957 (約)