



Intertek Testing Services
ETL SEMKO

FCC Part 15, Class B (DoC) Emissions Test Report
for
Sierra Wireless, Inc.
on the
CDMA Transceiver
Model: Aircard 510

Test Report #: J20007760B
Date of Report: April 3, 2000

Job #: J20007760
Date of Test: March 30-31, 2000

Total No. of Pages Contained in this Report: 17 + data pages



<i>Xi-Ming Yang</i>	Xi-Ming Yang, Test Engineer
<i>David Chernomordik</i>	David Chernomordik, Ph.D., EMC Site Manager

All services undertaken are subject to the following general policy: Reports are submitted for exclusive use of the client to whom they are addressed. Their significance is subject to the adequacy and representative character of the samples and to the comprehensiveness of the tests, examinations or surveys made. This report shall not be reproduced except in full, without written consent of Intertek Testing Services, NA Inc. This report must not be used to claim product endorsement by NVLAP, NIST nor any other agency of the U.S. Government.

Part 15 Class B (DoC) and ANSI C63.4-1992, Rev. 8/99



Intertek Testing Services NA Inc.
1365 Adams Court, Menlo Park, CA 94025
Telephone 650-463-2900 Fax 650-463-2910 Home Page www.etlsemko.com





VERIFICATION OF COMPLIANCE
Report No. J20007760B

Verification is hereby issued to the named APPLICANT and is VALID ONLY for the equipment tested hereon for use under the rules and regulations listed below

Equipment Under Test:	CDMA Transceiver
Trade Name:	Sierra Wireless
Model No.:	Aircard 510
Serial No.:	Not Labeled
Applicant:	Sierra Wireless, Inc.
Contact:	Mr. Dominique Kwong
Address:	#150-13575 Commerce Parkway Richmond, B.C. V6V 2L1 Canada
Tel. number:	(604) 231 1181
Fax number:	(604) 231 1109
Applicable Regulation:	FCC Part 15, Subpart B, and Industry Canada ICES-003 issue 2
Equipment Class:	Class B
Test Site Location:	ITS - Site 3 1365 Adams Drive Menlo Park, CA 94025
Date of Test:	March 30-31, 2000

We attest to the accuracy of this report:

Xi-Ming Yang
Xi-Ming Yang
Test Engineer

David Chernomordik
David Chernomordik, Ph.D.
EMC Site Manager



Table of Contents

1.0	Introduction.....	1
2.0	Description of Equipment.....	1
3.0	Test Summary.....	1
4.0	System Test Configuration.....	2
4.1	Support Equipment	2
4.2	Block Diagram of Test Setup	2
4.3	Justification.....	3
4.4	Software Exercise Program.....	3
4.5	Mode of Operation During Test	3
4.6	Modifications Required for Compliance.....	3
4.7	Additions, deviations and exclusions from standards.....	3
5.0	Radiated Emissions	4
5.1	Radiated Emission Limits	4
5.2	Field Strength Calculation	5
5.3	Configuration Photographs.....	6
5.4	Test Data	7
6.0	AC Mains Line-Conducted Emissions	8
6.1	Line Conducted Emission Limits	8
6.2	Configuration Photographs.....	9
6.3	Test Data	10
7.0	Test Equipment.....	11
7.1	Equipment List.....	11
7.2	Measurement Uncertainty.....	12
7.2.1	Radiated Emission - 3m Open Site Test Distance	12
7.2.2	Conducted Emission - AC Supply.....	12
7.3	Measurement Traceability.....	12
8.0	Miscellaneous Information or Other Comments	13
8.1	Labeling - USA.....	14
8.2	Labeling - Canada	15
8.3	Compliance Information - USA	16
8.4	Manufacturer's Certification	17

1.0 Introduction

This report is designed to show compliance with the FCC Part 15, Subpart B Rules for an unintentional radiator. The test procedures, as described in American National Standards Institute C63.4-1992, were employed. A description of the product and operating configuration, the various provisions of the rules, the methods for determining compliance, and a detailed summary of the results are included within this test report.

2.0 Description of Equipment

The Model Aircard 510 is a PCS CDPD modem.

A production version of the sample was received on February 11, 2000 in good condition.

3.0 Test Summary

Test results are given in full in section 5 and 6.

FCC Part 15 Subpart B Summary of Test Results			
Test Condition	Description	Class	Compliance Status
Conducted Emission (AC main)	0.45 MHz - 30 MHz	B	Pass
Radiated Emission	30 MHz - 1000 MHz	B	Pass

4.0 System Test Configuration

4.1 Support Equipment

Support Equipment					
Equip. #	Equipment	Manufacturer	Model #	S/N #	FCC ID
1	Computer	HP	F1260A	F1200-80055	DOC
2	Monitor	Dell Computer	D1428-HS	02922CV22495	GWGPM04EIX

4.2 Block Diagram of Test Setup

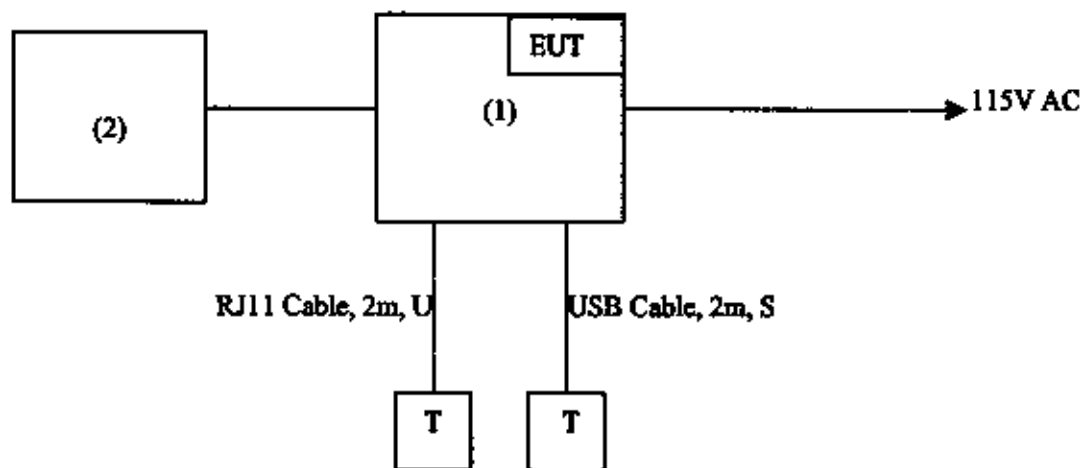

* - EUT
 ** - No ferrites on video cable
 S - Shielded
 U - Unshielded
 F - With Ferrite

4.3 Justification

The system was configured for testing in a typical fashion (as a customer would normally use it).

4.4 Software Exercise Program

There was no special software used during the tests.

4.5 Mode of Operation During Test

The EUT was operating in continuous transmitting mode.

4.6 Modifications Required for Compliance

The following modifications were installed during compliance testing in order to bring the product into compliance (Please note that this list does not include changes made specifically by Sierra Wireless, Inc. prior to compliance testing):

None

4.7 Additions, deviations and exclusions from standards

None

5.0 Radiated Emissions

5.1 Radiated Emission Limits

The following radiated emission limits apply to Class B unintentional radiators:

Radiated Emissions Limits, Section 15.109(a)

Frequency MHz	Class B at 3m $\mu V/m$	Class B at 3m dB($\mu V/m$)
30-88	100	40
88-216	150	43.5
216-960	200	46
Above 960	500	54

Note: Three sets of units are commonly used for EMI measurement, decibels below one milliwatt (-dBm), decibels above a microvolt, dB(μV), and microvolts (μV). To convert between them, use the following formulas: $20 \text{ LOG}_{10}(\mu V) = \text{dB}(\mu V)$, $\text{dB}(m) = \text{dB}(\mu V) - 107$.

5.2 Field Strength Calculation

The field strength is calculated by adding the Antenna Factor and Cable Factor, and subtracting the Amplifier Gain (if any) from the measured reading. The basic equation with a sample calculation is as follows:

$$FS = RA + AF + CF - AG$$

where FS = Field Strength in dB(μ V/m)

RA = Receiver Amplitude (including preamplifier) in dB(μ V)

CF = Cable Attenuation Factor in dB

AF = Antenna Factor in dB/m

AG = Amplifier Gain in dB

In the following table(s), the reading shown on the data table reflects the preamplifier gain. An example for the calculations in the following table is as follows:

$$FS = RR + LF$$

where FS = Field Strength in dB(μ V/m)

RR = RA - AG in dB(μ V)

LF = CF + AF in dB/m

Assume a receiver reading of 52.0 dB(μ V) is obtained. The antenna factor of 7.4 1/m and cable factor of 1.6 dB is added. The amplifier gain of 29 dB is subtracted, giving a field strength of 32 dB(μ V/m). This value in dB μ V/m was converted to its corresponding level in μ V/m.

$$RA = 52.0 \text{ dB}(\mu\text{V})$$

$$AF = 7.4 \text{ dB/m}$$

$$CF = 1.6 \text{ dB}$$

$$AG = 29.0 \text{ dB}$$

$$FS = RR + LF$$

$$FS = 23 + 9 = 32 \text{ dB}(\mu\text{V/m})$$

$$RR = 23.0 \text{ dB}(\mu\text{V})$$

$$LF = 9.0 \text{ dB}$$

$$\text{Level in } \mu\text{V/m} = \text{Common Antilogarithm } \{[32 \text{ dB}(\mu\text{V/m})]/20\} = 39.8 \mu\text{V/m}$$

5.3 Configuration Photographs

**Worst-Case Radiated Emission
at 73.7 MHz**

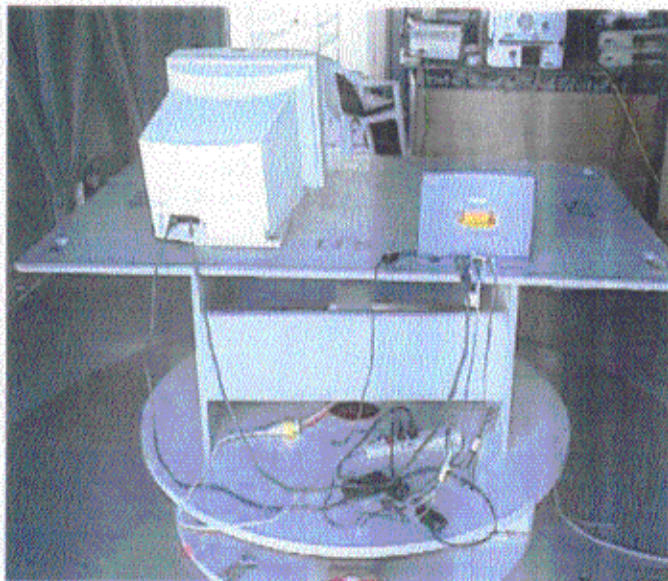
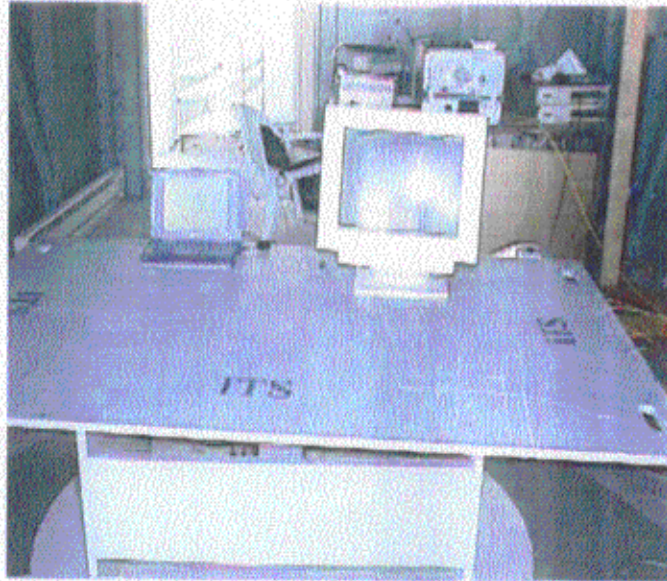

5.4 Test Data

The results on the following page(s) were obtained when the device was tested in the condition described in section 4.

Results: Passed by 4.2 dB at 73.7 MHz
--

- Note:
- a) A complete scan from 30-1000 MHz was made with antenna oriented horizontally and vertically.
 - b) All emissions not reported are at least 20 dB below the limits
 - c) Analyzer setting: RBW \geq 100 kHz, VBW \geq 100 kHz
Detector mode: Peak unless otherwise specified in the data page

**Radiated Emissions
Test Data**

Company: Sierra Wireless Inc.	Model #: Aircard 510	Standard: FCC 3 15B
EUT:	S/N #:	Limits: 2
Project #:	Test Date: March 31, 2000	Test Distance: 3 meters
Test Mode: Rx	Engineer: Xi-Ming Y.	Duty Relaxation: 0 dB

	Antenna Used			Pre-Amp Used			Cable Used			Transducer Used
Number:	2	18	8	8	10	0	0	0	3	0
Model:	EMCO 9143	0	EMCO 3115	EDI P100 6	AT10055	None	None	None	Site 2 10m	None

Frequency	Reading	Detector	Ant. #	Amp. #	Ant. Pol	Ant. Factor	Pre-Amp	Insert. Loss	D. C. F.	Net	Limit @3m	Margin
MHz	dB(uV)	PAV	#	#	RV	dB(uV/m)	dB	dB	dB	dB(uV/m)	dB(uV/m)	dB
68.79	26.3	Peak	2	0	V	5.8	0.0	1.5	0.0	33.6	40.0	-6.4
73.74	28.7	Peak	2	0	V	5.6	0.0	1.5	0.0	35.8	40.0	-4.2
111.14	27.6	Peak	2	0	V	7.0	0.0	1.7	0.0	36.3	43.5	-7.2
116.00	30.0	Peak	2	0	V	7.3	0.0	1.7	0.0	39.0	43.5	-4.5
167.08	24.2	Peak	2	0	V	9.2	0.0	2.1	0.0	35.5	43.5	-8.0
176.97	22.9	Peak	2	0	H	9.1	0.0	2.2	0.0	34.2	43.5	-9.3
275.25	20.6	Peak	2	0	H	12.4	0.0	2.8	0.0	35.8	46.0	-10.2
460.00	12.0	Peak	2	0	H	17.5	0.0	3.6	0.0	33.1	46.0	-12.9

- Notes:**
- a) D.C.F.: Distance Correction Factor
 - b) Insert. Loss (dB) = Cable A + Cable B + Cable C
 - c) Net (dB) = Reading + Antenna Factor - Pre-amp + Insert. Loss. - Transducer Loss - Duty Relaxation (transmitter only).
 - d) Negative signs (-) in Margin column signify levels below the limits.
 - e) All other emissions not reported are below the equipment noise floor which is at least 20 dB below the limits.

Sierra Wireless, Inc., Aircard 510

Date of Test: March 31, 2000

6.0 AC Mains Line-Conducted Emissions

6.1 Line Conducted Emission Limits

The following AC line conducted emission limits apply to Class B unintentional radiators:

Conducted Emissions Limits, Section 15.107(a)

Frequency MHz	Class B μV	Class B dB(μV)
0.45 - 1.705	250	48
1.705 to 30.000	250	48

Note: Three sets of units are commonly used for EMI measurement, decibels below one milliwatt (-dBm), decibels above a microvolt, dB(μV), and microvolts (μV). To convert between them, use the following formulas: $20 \text{ LOG}_{10}(\mu V) = \text{dB}(\mu V)$, $\text{dB}(m) = \text{dB}(\mu V) - 107$.

6.2 Configuration Photographs

**Worst-Case Line-Conducted Emission
at 2.2 MHz**

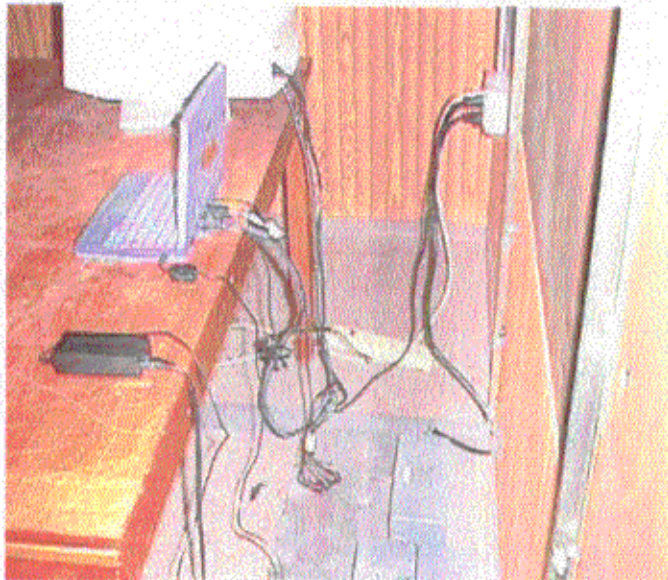

6.3 Test Data

The results on the following page(s) were obtained when the device was tested in the condition described in section 4.

Results: Passed by 13 dB at 2.2 MHz
--

- Note: a) A complete scan from 0.45 - 30 MHz was made.
- b) Analyzer setting: RBW \geq 9 kHz, VBW \geq 9 kHz
Detector mode: Peak unless otherwise specified in the data page

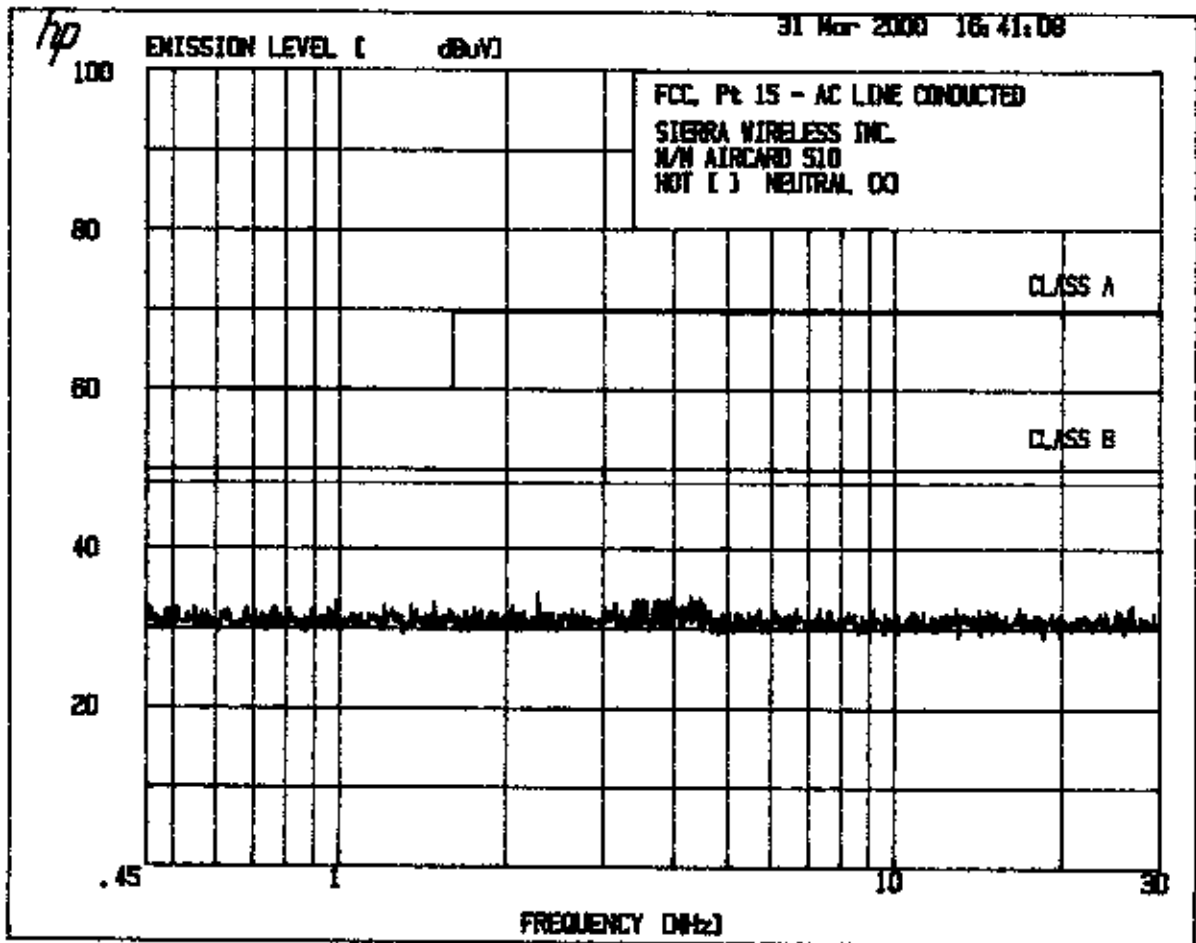
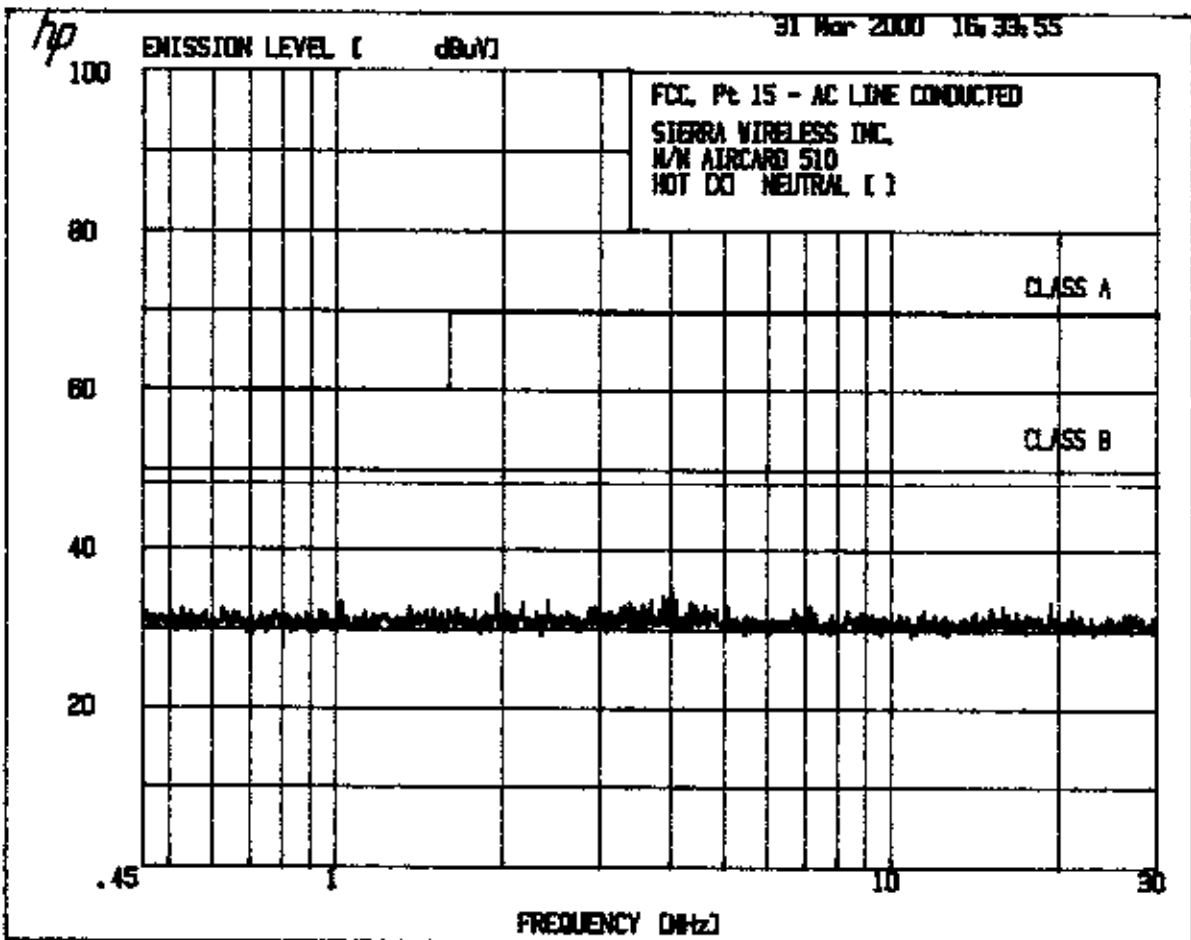

Sierra Wireless, Inc., Aircard 510

Date of Test: March 31, 2000

7.0 Test Equipment

7.1 Equipment List

All test sites are FCC listed, IC accepted, and NVLAP accredited.

Industry Canada identifier number	IC 2059
NVLAP Lab Code	200201-0

Instruments used for emission compliance tests described in this report are listed below:

TEST EQUIPMENT FOR EMISSION TESTING						
EQUIPMENT	MFG.	MODEL	SERIAL NUMBER	CAL. INTERVAL (Months)	CAL. DUE DATE (m/d/y)	USED
LISN	Solar Electronics	8028-50-TS-24-BNC	980235	12	2/9/01	X
LISN	Solar Electronics	8028-50-TS-24-BNC	941501	12	12/10/00	X
LISN	Solar Electronics	8028-50-TS-24-BNC	941502	12	12/10/00	X
Bi-Log Antenna	EMCO	3143	9509-1160	12	4/15/00	X
Spectrum Analyzer	Hewlett Packard	8591EM	3536A00451	12	2/2/01	X

Sierra Wireless, Inc., Aircard 510

Date of Test: March 31, 2000

7.2 Measurement Uncertainty**7.2.1 Radiated Emission - 3m Open Site Test Distance**

The uncertainty in the measured field strength is estimated as follows, for a minimum confidence probability of 95 %

Freq. Range	Detection Mode	Uncertainty
30 MHz to 200 MHz	Quasi-peak	± 4.4 dB
200 MHz to 1000 MHz	Quasi-peak	+ 5.0 / - 3.6 dB

7.2.2 Conducted Emission - AC Supply

The uncertainty in the measured voltage is estimated as follows, for a minimum confidence probability of 95 %

Freq. Range	Detection Mode	Uncertainty
9 kHz to 150 kHz	Average	± 2.1 dB
	Quasi-peak	± 2.5 dB
150 kHz to 30 MHz	Average	± 2.4 dB
	Quasi-peak	± 2.6 dB

7.3 Measurement Traceability

All measurements described in this report are traceable to National Institute of Standards and Technology (NIST) standards.

Sierra Wireless, Inc., Aircard 510

Date of Test: March 31, 2000

8.0 Miscellaneous Information or Other Comments

None.

8.1 Labeling - USA

Products subject to Declaration of Conformity (DoC) shall be labeled as shown below. The label shall be located in a conspicuous location on the device and shall contain the unique identification described in FCC Section 2.1074.

The label shall not be a stick-on, paper label. The label on these products shall be permanently affixed to the product and shall be readily visible to the purchaser at the time of purchase, as described in FCC Section 2.925(d). "Permanently affixed" means that the label is etched, engraved, stamped, silkscreened, indelibly printed, or otherwise permanently marked on a permanently attached part of the equipment or on a nameplate of metal, plastic, or other material fastened to the equipment by welding, riveting, or a permanent adhesive. The label must be designed to last the expected lifetime of the equipment in the environment in which the equipment may be operated and must not be readily detachable.

- (i) If the product is authorized based on testing of the product or system

Trade Name	Model Number
 Tested To Comply With FCC Standards FOR HOME OR OFFICE USE	

- (ii) If the product is authorized based on assembly using separately authorized components and the resulting product is not separately tested:

Trade Name	Model Number
 Assembled From Tested Components (Complete System)	
Tested]	Not
FOR HOME OR OFFICE USE	

8.2 Labeling - Canada

Canadian Emissions and Labeling Requirements

The Canadian Government has announced an amendment of the radio act which will require computing equipment to comply with EMI Specifications in Canada. The effective date for products imported into Canada is January 31, 1989.

The intent of the amendment is to establish Canadian Regulations which are harmonized with the existing FCC Regulations. As such, no retesting is required and devices which have been tested and comply with the FCC Specifications (Class A or B) also comply with the Canadian Specification (Class A or B).

A record of the measurements and results shall be retained by the manufacturer or importer for a period of at least five years and made available for examination on the request of the Canadian Government.

A written notice indicating compliance must accompany each unit of digital apparatus to the end user. The notice shall be in the form of a label that is affixed to the apparatus. Where because of insufficient space or other restrictions it is not feasible to affix a label to the apparatus, the notice may be in form of a statement included in the user's manual.

A suggested text for the notice, in English and French, is as follows:

**This Class [*] digital apparatus meets all requirements of the
Canadian Interference-Causing Equipment Regulations.**

**Cet appareil numérique de la classe [*] respecte toutes les
exigences du Règlement sur le matériel brouilleur du Canada.**

*Insert either "A" or "B" but not both as appropriate for the equipment requirements.

8.3 Compliance Information - USA

If a product must be tested and authorized under a Declaration of Conformity, a compliance information statement shall be supplied with the product at the time of marketing or importation, containing the following information:

- (a) Identification of the product, e.g., name and model number.
- (b) A statement that the product complies with Part 15 of the regulations:

This device complies with Part 15 of the FCC Rules. Operation is subject to the following two conditions: (1) this device may not cause harmful interference, and (2) this device must accept any interference received, including interference that may cause undesired operation.

- (c) The identification, by name, address and telephone number, of the responsible party. The responsible party for a Declaration of Conformity must be located within the United States.

The compliance information statement shall be included in the user's manual or as a separate sheet.

The users manual or instruction manual shall also caution the user that:

Changes or modifications not expressly approved the party responsible for compliance could void the user's authority to operate this equipment.

Sierra Wireless, Inc., Aircard 510

Date of Test: March 31, 2000

8.4 Manufacturer's Certification

Declaration of ConformityStandard to which conformity is declared: FCC PART 15 § 24**Manufacturer/Importer's Information**Name: SIERRA WIRELESS, INC.Address: SUITE 150, 13575 COMMERCE PARKWAY
RICHMOND, BC, CANADA, V6V2L1Telephone Number: 604-231-1100**Equipment Information**Type of Equipment: PCS BAND CDMA WIRELESS MODEMTrade Name: AIRCARDModel Number: 510Test Report Reference: J20007760B (PART 15 - PDF)

I, the undersigned, hereby declare that the equipment specified above conforms to Part 15 of the FCC Rules.

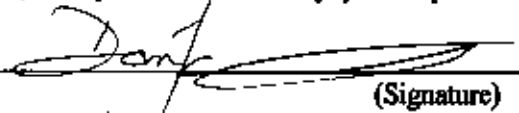

(Signature)

DOMINIQUE KWONG, RF ENGINEERING TECHNOLOGIST

(Name & Title)

APRIL 7, 2000

(Date)