



***FCC Parts 22 and 24 Test Report***

**For**  
**800/1900 MHz CDMA DUAL BAND PC CARD**

**Model: AirCard 575**

**FCC ID: N7NAC575**

**Prepared by**  
**SIERRA WIRELESS INC.**  
**13811 WIRELESS WAY**  
**RICHMOND, BC V6V 3A4**  
**CANADA**

**Test date(s): May / June 2002**

© 2001 Sierra Wireless, Inc.

This document contains information which is proprietary and confidential to Sierra Wireless, Inc. Disclosure to persons other than the officers, employees, agents, or subcontractors of the Company or licensee of this document without the prior written permission of Sierra Wireless, Inc. is strictly prohibited.

**Table of Contents**

1 Introduction ..... 3

    1.1 Test Summary..... 3

    1.2 Product Description..... 4

    1.3 Test Configuration ..... 4

    1.4 Related Submittal(s) Grants..... 4

2 RF Power Output ..... 5

    2.1 Test Procedure..... 5

    2.2 Test Equipment..... 5

    2.3 Test Results ..... 6

3 Radiated Power ..... 13

4 Occupied Bandwidth..... 14

    4.1 Test Procedure..... 14

    4.2 Test Equipment..... 14

    4.3 Test Results ..... 14

5 Out of Band Emissions at Antenna Terminals ..... 17

    5.1 Test Procedure..... 17

    5.2 Test Equipment..... 17

    5.3 Test Results ..... 18

6 Field Strength of Spurious Radiation..... 39

7 Frequency Stability vs Temperature ..... 40

    7.1 Test Procedure..... 40

    7.2 Test Equipment..... 40

    7.3 Test Results ..... 41

8 Frequency Stability vs Voltage..... 42

    8.1 Test Procedure..... 42

    8.2 Test Equipment..... 42

    8.3 Test Results ..... 42

# SIERRA WIRELESS, INC.

FCC Part 22 & 24 Test Report	FCC ID: N7NAC575	June 2002	Page 3 of 42
------------------------------	------------------	-----------	--------------

## 1 Introduction

### 1.1 Test Summary

FCC RULE	DESCRIPTION OF TEST	RESULT	PAGE
2.1046	RF Power Output	Complies	5
22.913, 24.232	ERP, EIRP	Complies	*
2.1049	Occupied Bandwidth Emission Designator	Complies 1M25G7D	14
2.1051, 22.901(d) 22.917, 24.238(a)	Out of Band Emissions at Antenna Terminals Mobile Emissions In Base Frequency Range	Complies	17
2.1053	Field Strength of Spurious Radiation	Complies	*
2.1055	Frequency Stability vs Temperature	Complies	40
2.1055	Frequency Stability vs Voltage	Complies	42

\* Separate Reports are issued.

The following tests:

- 22.913, 24.232          ERP/EIRP Measurement
- 2.1053                  Field Strength of Spurious Radiation

were conducted at

Compliance Certification Services, Inc.  
561F Monterey Road  
Morgan Hill  
CA 95037  
USA

The remaining tests described in this report were performed at

Sierra Wireless, Inc.  
13811 Wireless Way  
Richmond, B.C. V6V 3A4  
Canada

**SIERRA WIRELESS, INC.**

FCC Part 22 & 24 Test Report	FCC ID: N7NAC575	June 2002	Page 4 of 42
------------------------------	------------------	-----------	--------------

**1.2 Product Description**

The Sierra Wireless Inc. Model AC575 (FCC ID: N7NAC575) is a dual band CDMA PCMCIA Radio Card with retractable diversity antennae.

<b>EUT Type</b>	Cellular and PCS PCMCIA Card	
<b>Whether quantity(&gt;1) production is planned</b>	<input checked="" type="checkbox"/> Yes <input type="checkbox"/> No	
<b>Standards</b>	CMDA	
<b>Types of Emission</b>	1M25G7D	
<b>RF Output Power</b>	824.01-848.97 MHz:	23 dBm(Average)
	1850.00-1909.95 MHz:	23 dBm(Average)
<b>Frequency Range</b>	Cell Band TX 824.01 MHz - 848.97 MHz  RX 869.01 MHz - 893.97 MHz	PCS Band TX 1850.00 MHz – 1909.95 MHz  RX 1930.00 MHz – 1989.95 MHz
<b>Antenna &amp; Gain</b>	Cell Band 1/4 wavelength Average Gain: -2.5 dBi	PCS Band 1/2 wavelength Average Gain: -4 dBi
<b>Detachable antenna?</b>	<input checked="" type="checkbox"/> Yes <input type="checkbox"/> No	
<b>Receiver L.O. frequency</b>	1052.61 – 1077.57 MHz (Cellular) 2113.6 – 2173.6 MHz (PCS)	
<b>External input</b>	<input type="checkbox"/> Audio <input type="checkbox"/> Digital Data	

**1.3 Test Configuration**

The radio was tested with radio card installed into laptop.

Item #	Description	Model No.	Serial No.
1	EUT	AirCard 575	I020418000160C7
2	Laptop	IBM ThinkPad iSeries	AA-G2DX7

**1.4 Related Submittal(s) Grants**

© 2002 Sierra Wireless, Inc.

The contents of this page are subject to the confidentiality information on page one.

## 2 RF Power Output

FCC 2.1046

### 2.1 Test Procedure

The transmitter output was connected to the Average Power Meter. The output power was adjusted to 23 dBm. The transmitter output was connected a calibrated coaxial cable other end of which was connected to a spectrum analyzer. The resolution and video bandwidths of the spectrum analyzer were set up to 10 MHz and 10 MHz respectively. The peak power at the transmitter output was determined by adding the value of the cable loss to the spectrum analyzer reading in the reference offset level. Tests were performed at three frequencies (low, middle, and high channels) in Cellular and PCS bands.

### Test Setup

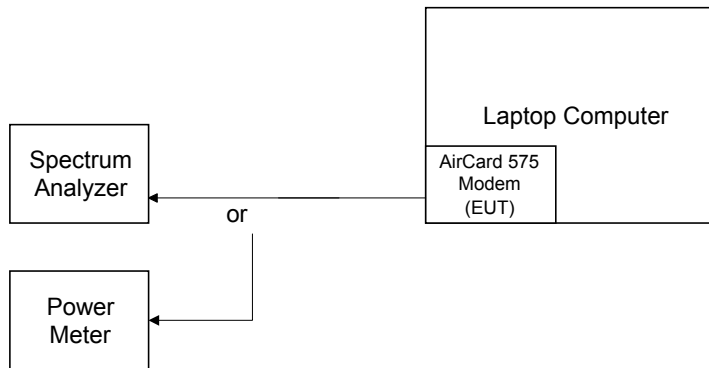

### 2.2 Test Equipment

EQUIPMENT	MANUFACTURER	MODEL NO.	SERIAL NO.	CAL. DUE DATE
Spectrum Analyzer	Rhode & Schwarz	FSP	100060	2003-05-18
Power Meter	Anritsu	ML2408A	00440086	N/A

**SIERRA WIRELESS, INC.**

**2.3 Test Results**

<b>Frequency (MHz)</b>	<b>Average Power (dBm)</b>	<b>Measured Peak Power (dBm)</b>
825.25	23.0	27.04
836.5	23.0	27.40
847.75	23.0	27.22
1851.25	23.0	27.10
1880.0	23.0	27.52
1908.75	23.0	25.97

For more details refer to the attached plots:

• **Cellular Band (CDMA Mode)**

<b>Plot Number</b>	<b>Description</b>
2.1	Low Channel (CH 8)
2.2	Middle Channel (CH 383)
2.3	High Channel (CH 758)

• **PCS Band (CDMA Mode)**

<b>Plot Number</b>	<b>Description</b>
2.4	Low Channel (CH 25)
2.5	Middle Channel (CH 600)
2.6	High Channel (CH 1175)

SIERRA WIRELESS, INC.

Plot 2.1

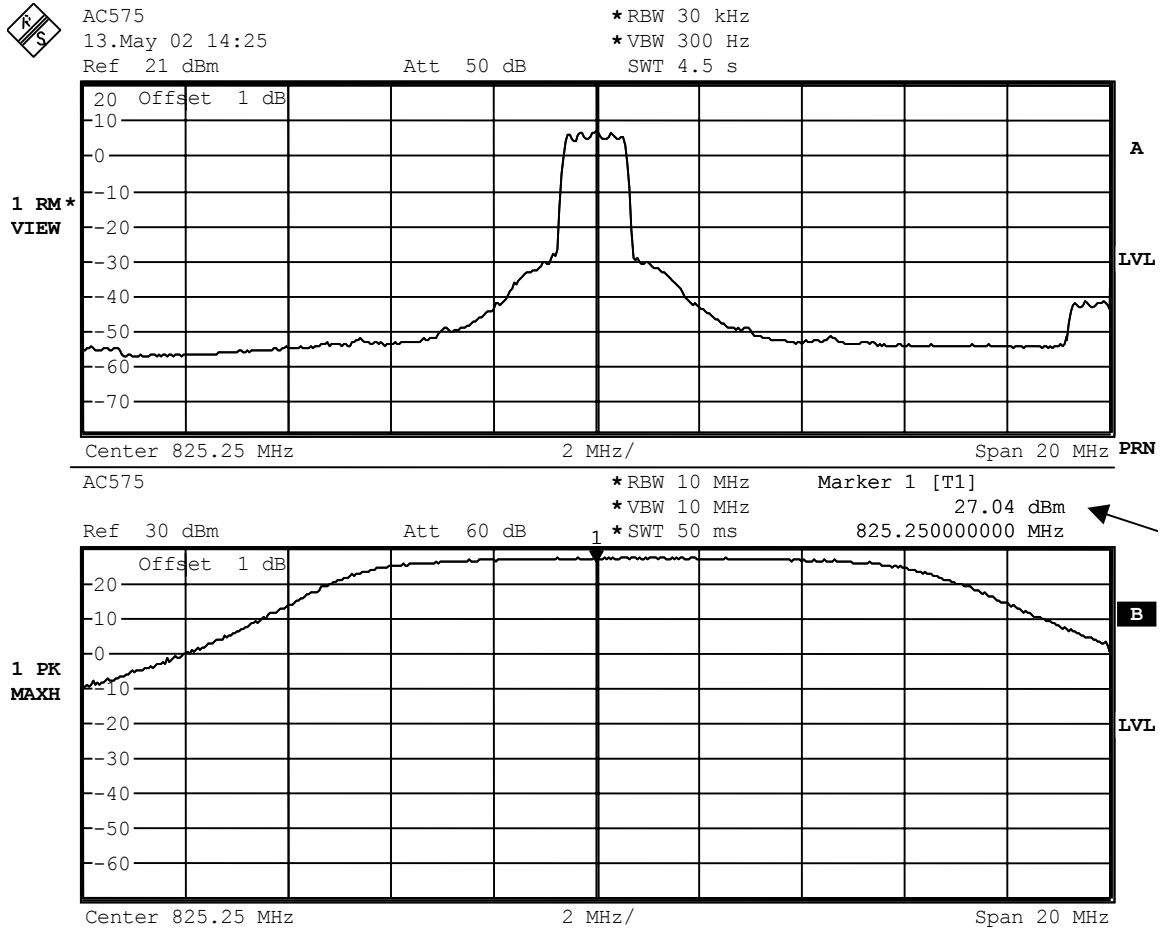

Date: 13.MAY.2002 14:25:46

# SIERRA WIRELESS, INC.

## Plot 2.2

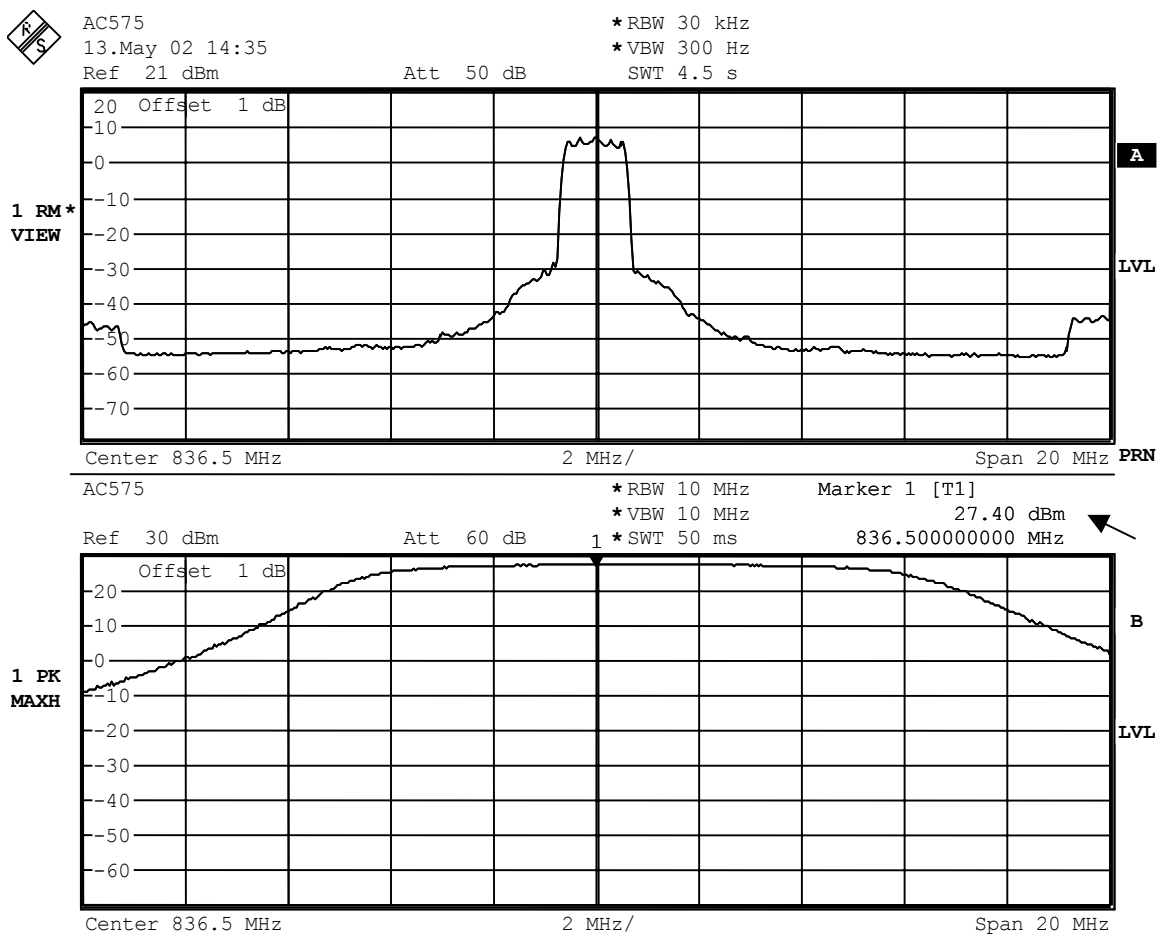

Date: 13.MAY.2002 14:36:03



# SIERRA WIRELESS, INC.

## Plot 2.3

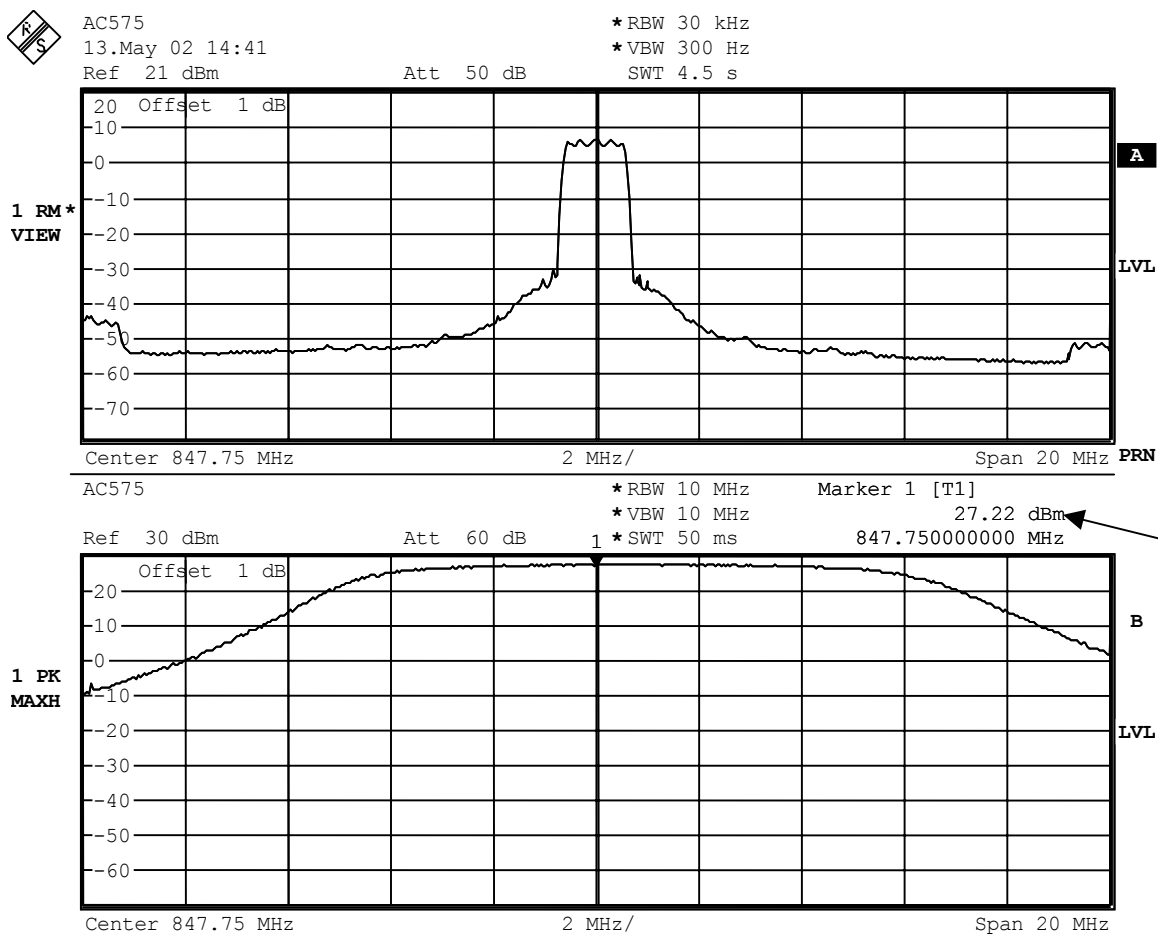

Date: 13.MAY.2002 14:41:38

# SIERRA WIRELESS, INC.

## Plot 2.4

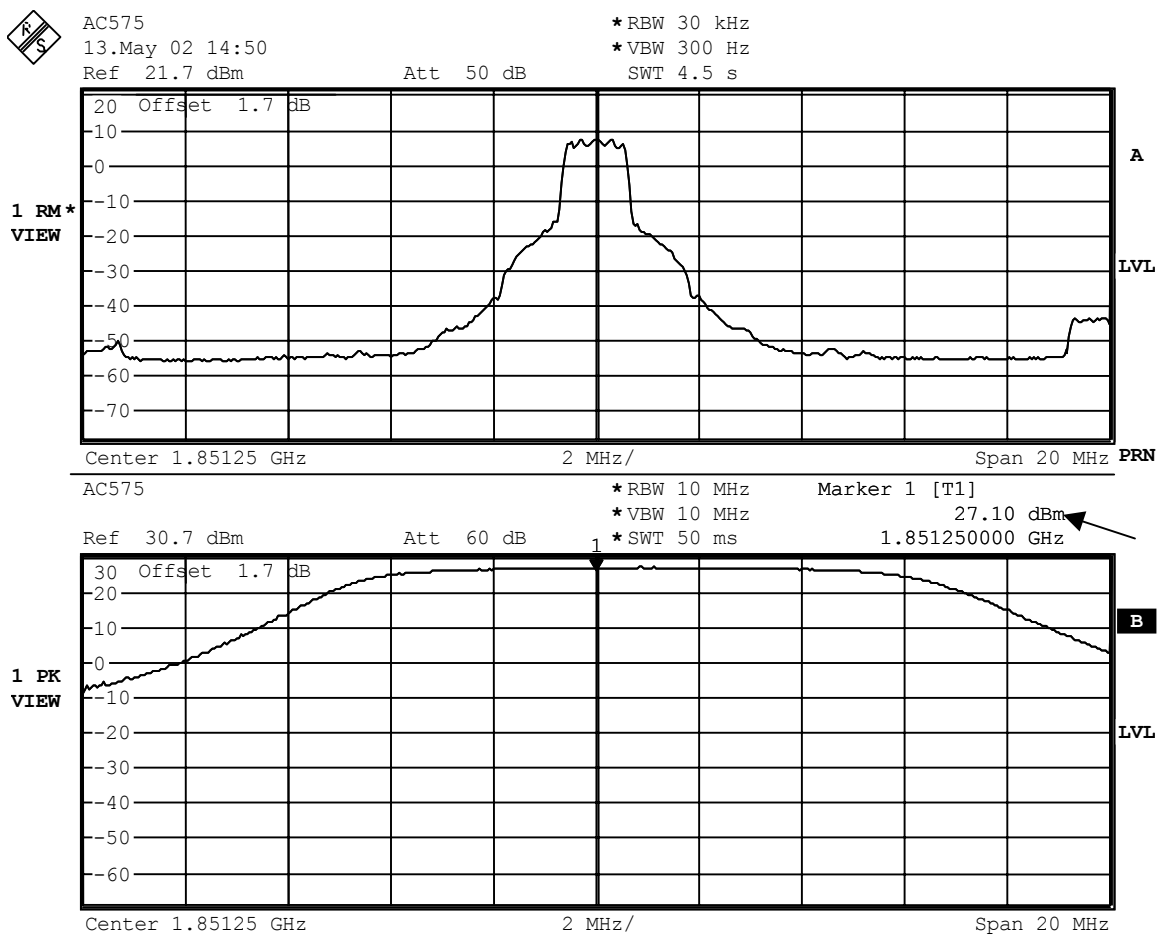

Date: 13.MAY.2002 14:50:56

# SIERRA WIRELESS, INC.

## Plot 2.5

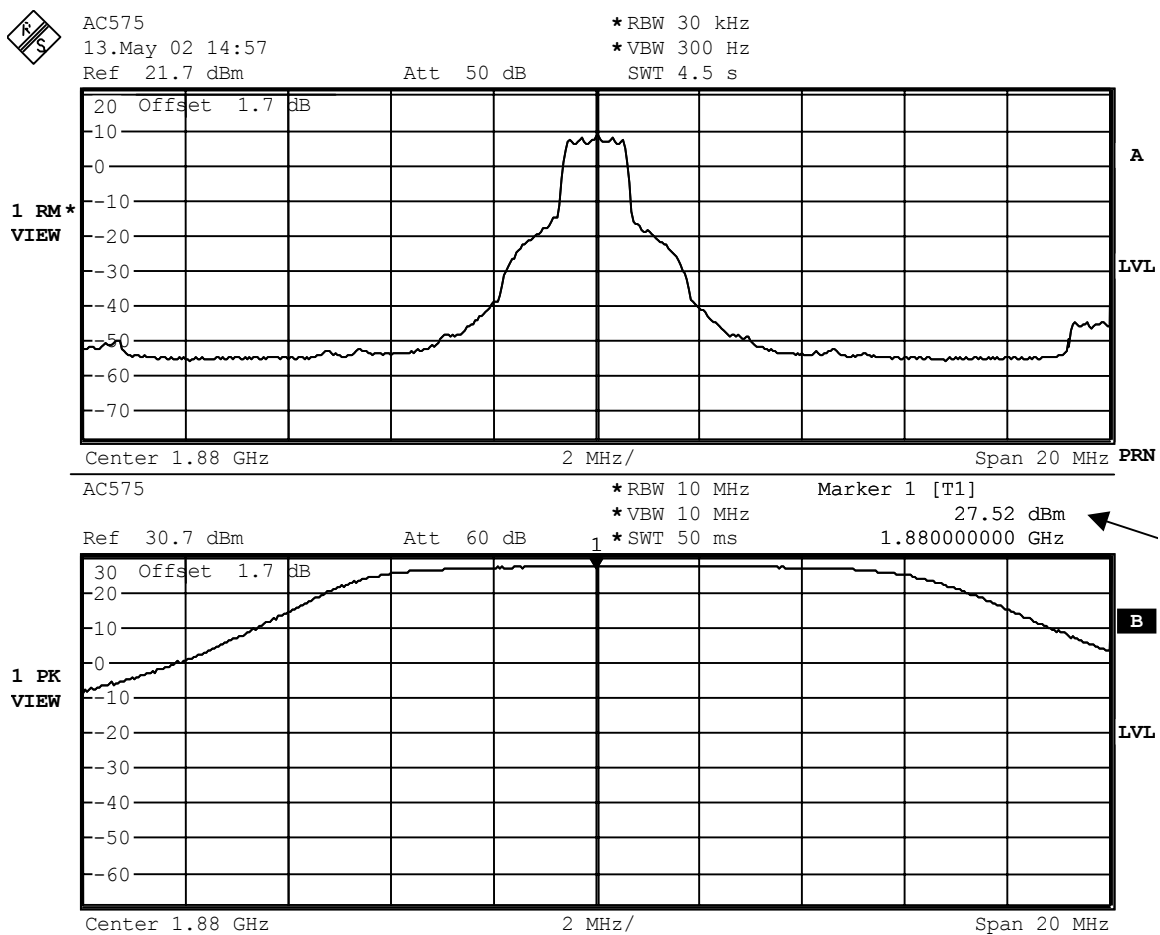

Date: 13.MAY.2002 14:57:31

# SIERRA WIRELESS, INC.

## Plot 2.6

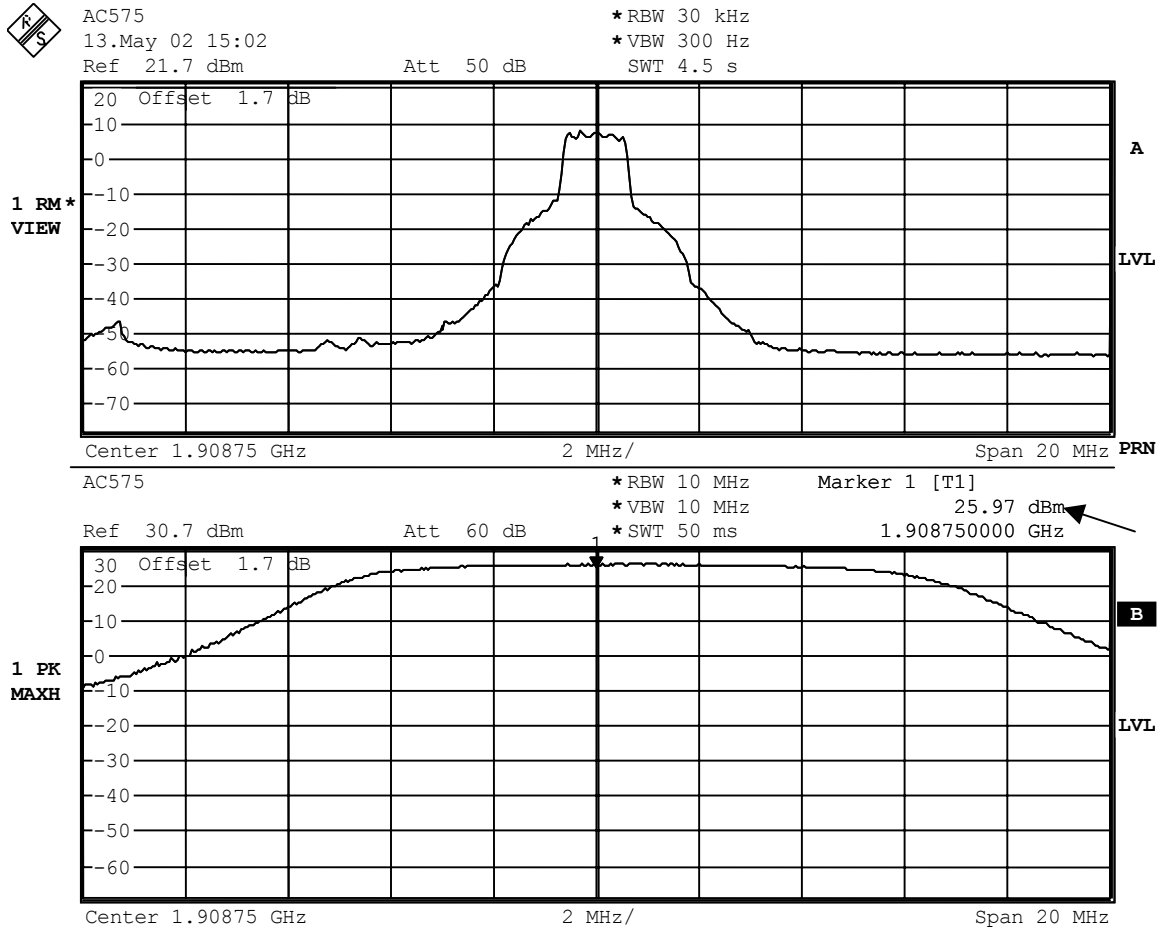

Date: 13.MAY.2002 15:02:42

**SIERRA WIRELESS, INC.**

FCC Part 22 & 24 Test Report	FCC ID: N7NAC575	June 2002	Page 13 of 42
------------------------------	------------------	-----------	---------------

**3 Radiated Power**

FCC 22.913

This test was performed at CCS and please refer to the attached CCS Test Report (AC575CCS\_report.pdf).

## 4 Occupied Bandwidth

FCC 2.1049

### 4.1 Test Procedure

The transmitter output was connected to a calibrated coaxial cable, the other end of which was connected to a spectrum analyzer. The occupied Bandwidth (defined as the 99% Power Bandwidth) was measured with Rohde & Schwarz FSP Spectrum Analyzer.

### Test Setup

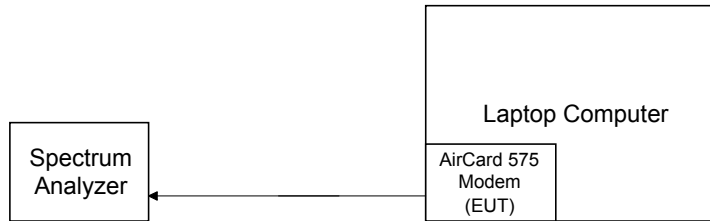

### 4.2 Test Equipment

EQUIPMENT	MANUFACTURER	MODEL NO.	SERIAL NO.	CAL. DUE DATE
Spectrum Analyzer	Rhode & Schwarz	FSP	100060	2003-05-18

### 4.3 Test Results

See attached plots 4.1 and 4.2. The test results shows that the bandwidth is 1.280 MHz, which is 2.5% higher than the theoretical bandwidth for CDMA – 1.25 MHz. The Emission Designator was determined as 1M25G7D.

# SIERRA WIRELESS, INC.

## Plot 4.1 Cellular Band (Middle Channel)

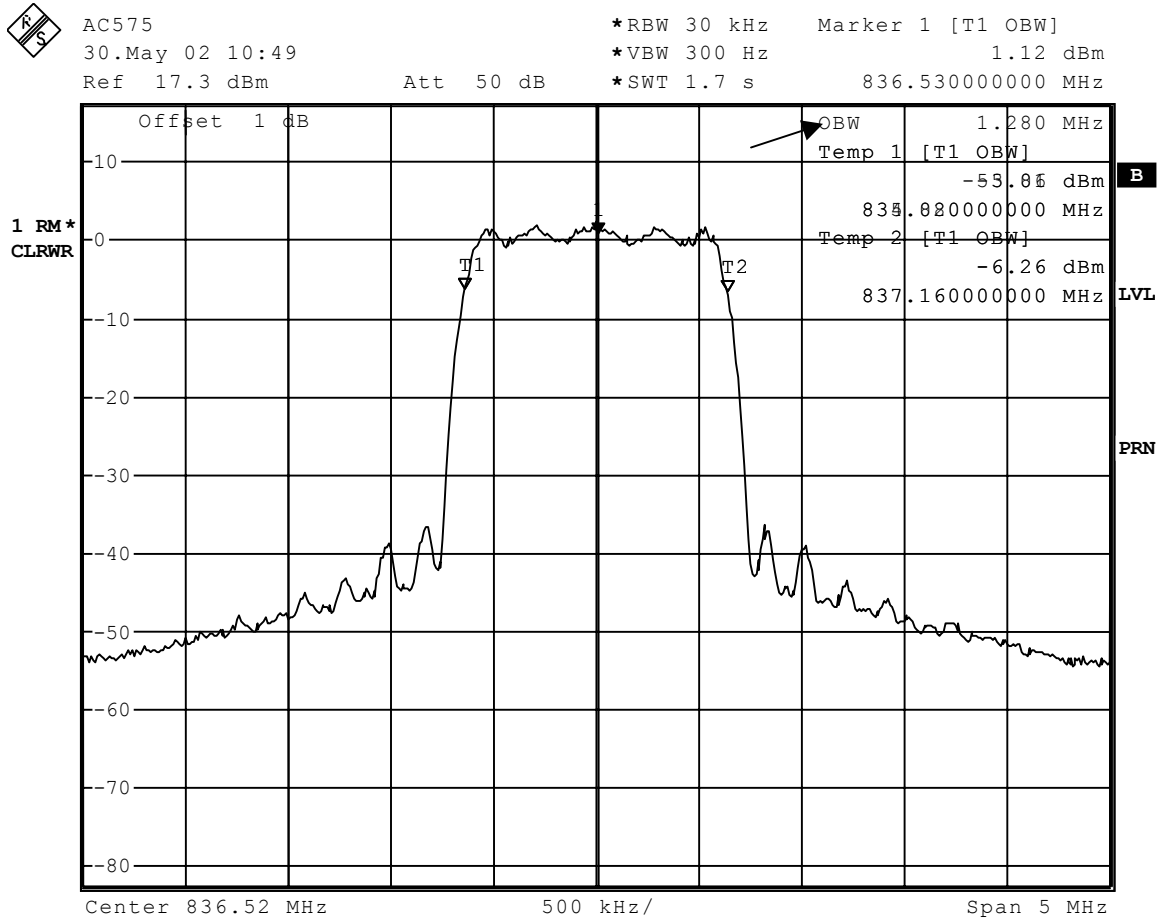

Date: 30.MAY.2002 10:49:51

# SIERRA WIRELESS, INC.

## Plot 4.2 PCS Band (Middle Channel)

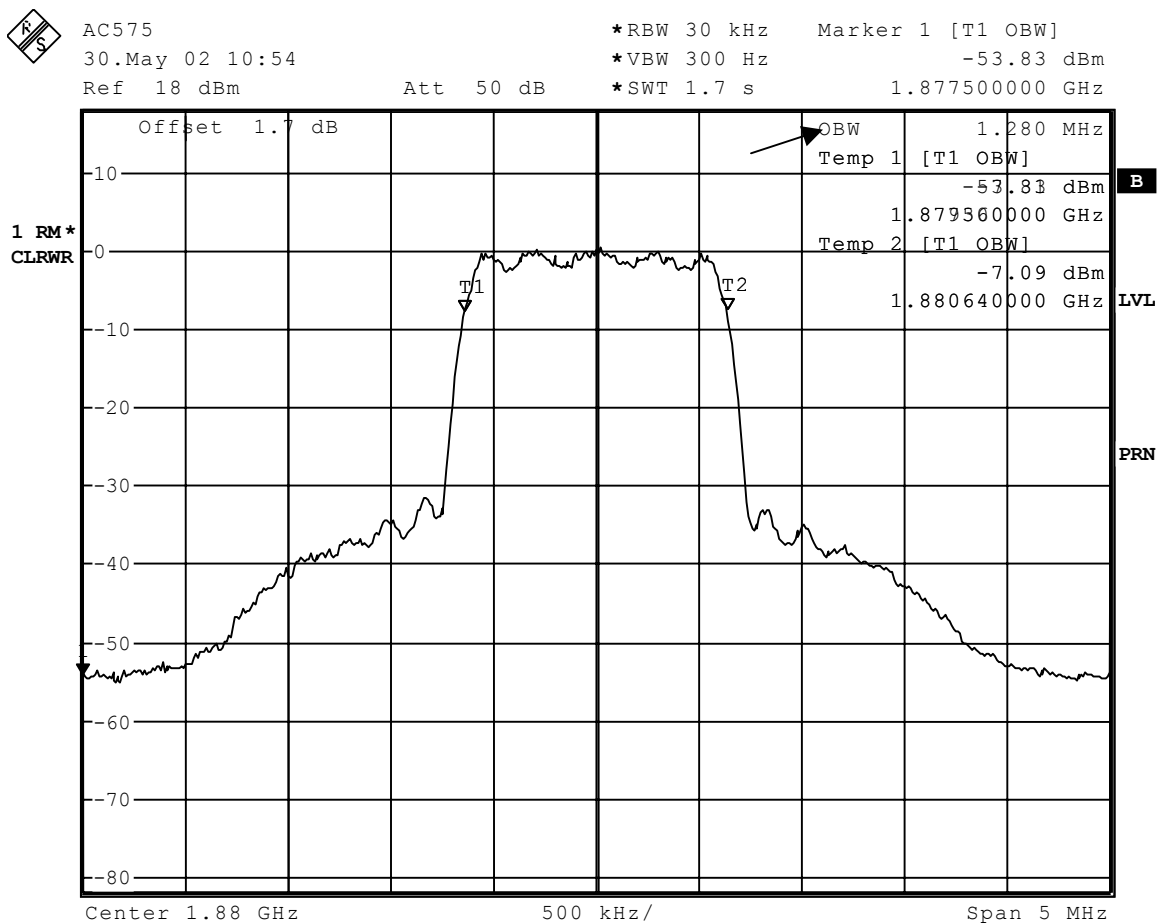

Date: 30.MAY.2002 10:54:43



**5 Out of Band Emissions at Antenna Terminals**

FCC 22.901(d), 22.917, 24.238(a)

Out of Band Emissions:

The mean power of emissions must be attenuated below the mean power of the unmodulated carrier(P) on any frequency outside the frequency band by at least  $(43 + 10 \log P)$  dB, in this case, -13dBm.

Mobile Emissions in Base Frequency Range:

The mean power of any emissions appearing in the base station frequency range from cellular mobile transmitters operated must be attenuated to a level not exceed -80 dBm at the transmit antenna connector.

**5.1 Test Procedure**

The RF output of the transmitter was connected to a spectrum analyzer through a calibrated coaxial cable. Sufficient scans were taken to show the out-of-band Emissions, if any, up to 10<sup>th</sup> harmonic. The EUT was scanned for spurious emissions from 1MHz to 20GHz with sufficient bandwidth and video resolution. Data plots were recorded only for the frequency range where out of band emissions at the antenna terminal were detected.

**Test Setup**

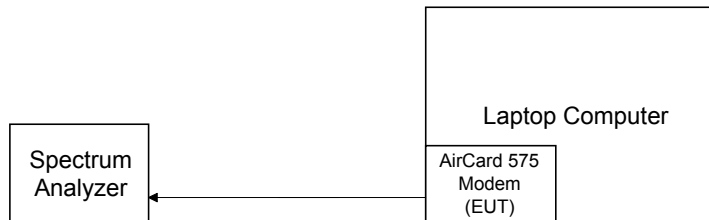

**5.2 Test Equipment**

EQUIPMENT	MANUFACTURER	MODEL NO.	SERIAL NO.	CAL. DUE DATE
Spectrum Analyzer	Rhode & Schwarz	FSP	100060	2003-05-18

**SIERRA WIRELESS, INC.**

**5.3 Test Results**

Refer to the attached plots.

- **Cellular Band**

<b>Plot Number</b>	<b>Description</b>
5.1a – 5.1b	Low Channel, 825.25 MHz
5.2a – 5.2b	Middle Channel, 836.50 MHz
5.3a – 5.3b	High Channel, 847.75 MHz

- **PCS Band**

<b>Plot Number</b>	<b>Description</b>
5.4a – 5.4d	Low Channel, 1851.25 MHz
5.5a – 5.5c	Middle Channel, 1880 MHz
5.6a – 5.6d	High Channel, 1908.75 MHz

- **Emission to Base Frequency Range**

<b>Plot Number</b>	<b>Description</b>
5.7a	Low Channel, 825.25 MHz
5.7b	Middle Channel, 836.50 MHz
5.7c	High Channel, 847.75 MHz

# SIERRA WIRELESS, INC.

## Plot 5.1a

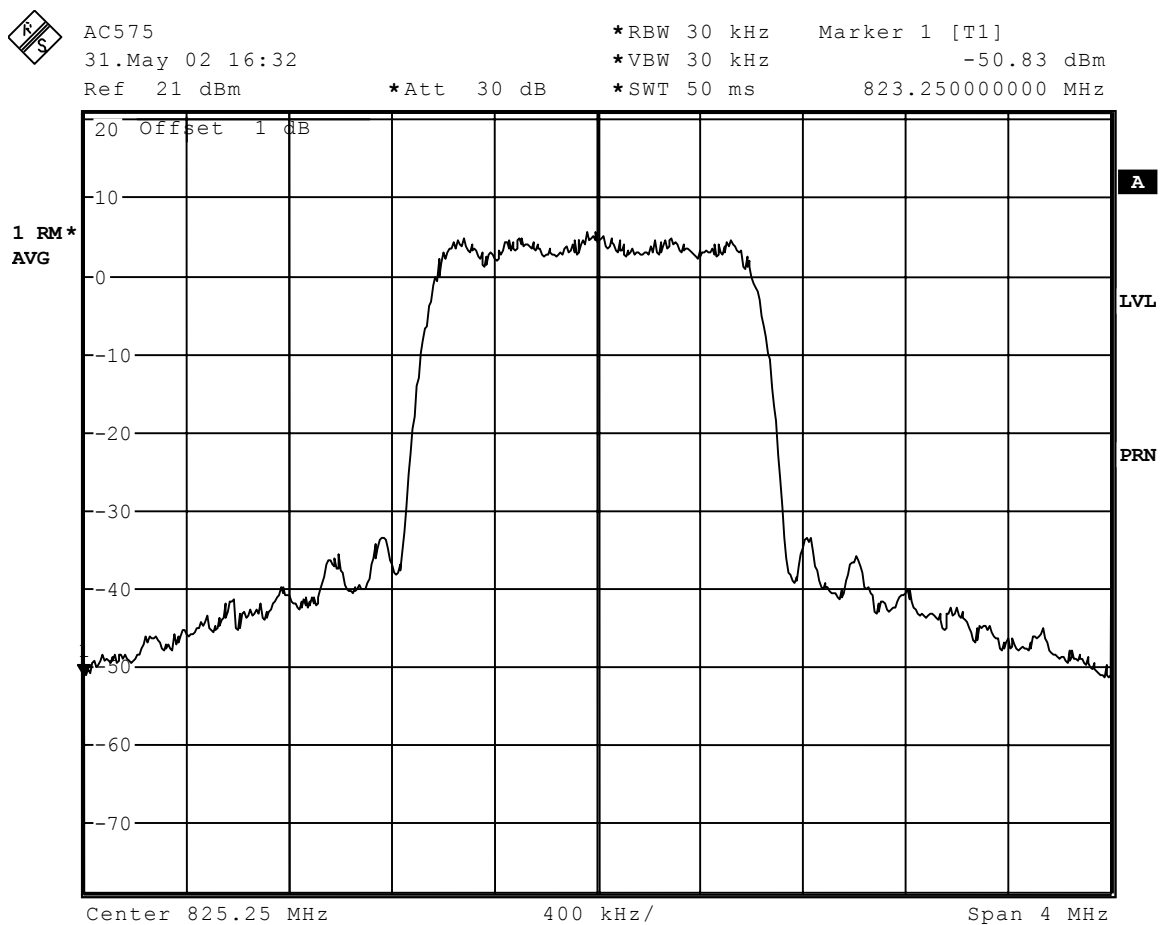

Date: 31.MAY.2002 16:32:17

SIERRA WIRELESS, INC.

Plot 5.1b



AC575 \*RBW 1 MHz Marker 1 [T1]  
31.May 02 16:36 \*VBW 10 MHz -46.38 dBm  
Ref 21 dBm \*Att 30 dB \*SWT 500 ms 1.648000000 GHz

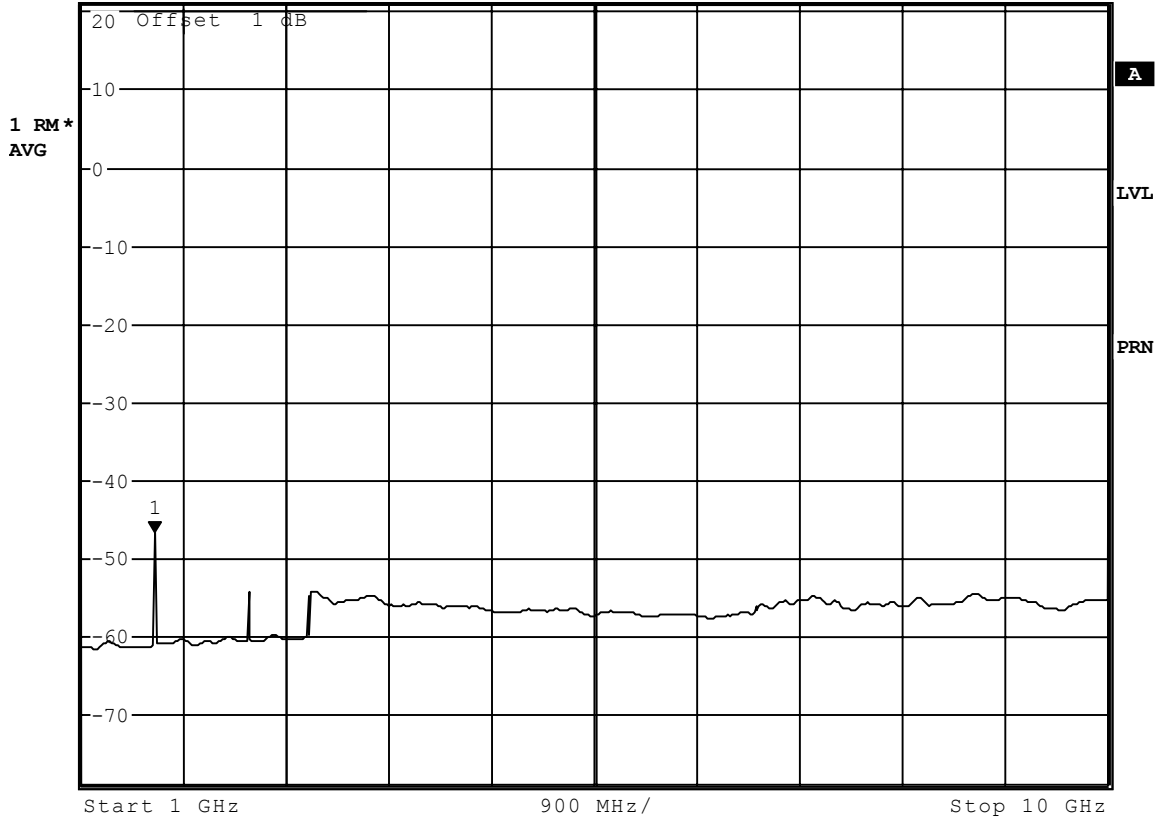

Date: 31.MAY.2002 16:36:33

# SIERRA WIRELESS, INC.

## Plot 5.2a



AC575  
31.May 02 16:40  
Ref 21 dBm  
\*RBW 30 kHz  
\*VBW 10 MHz  
\*Att 30 dB  
\*SWT 500 ms  
Marker 1 [T1]  
-33.00 dBm  
837.31600000 MHz

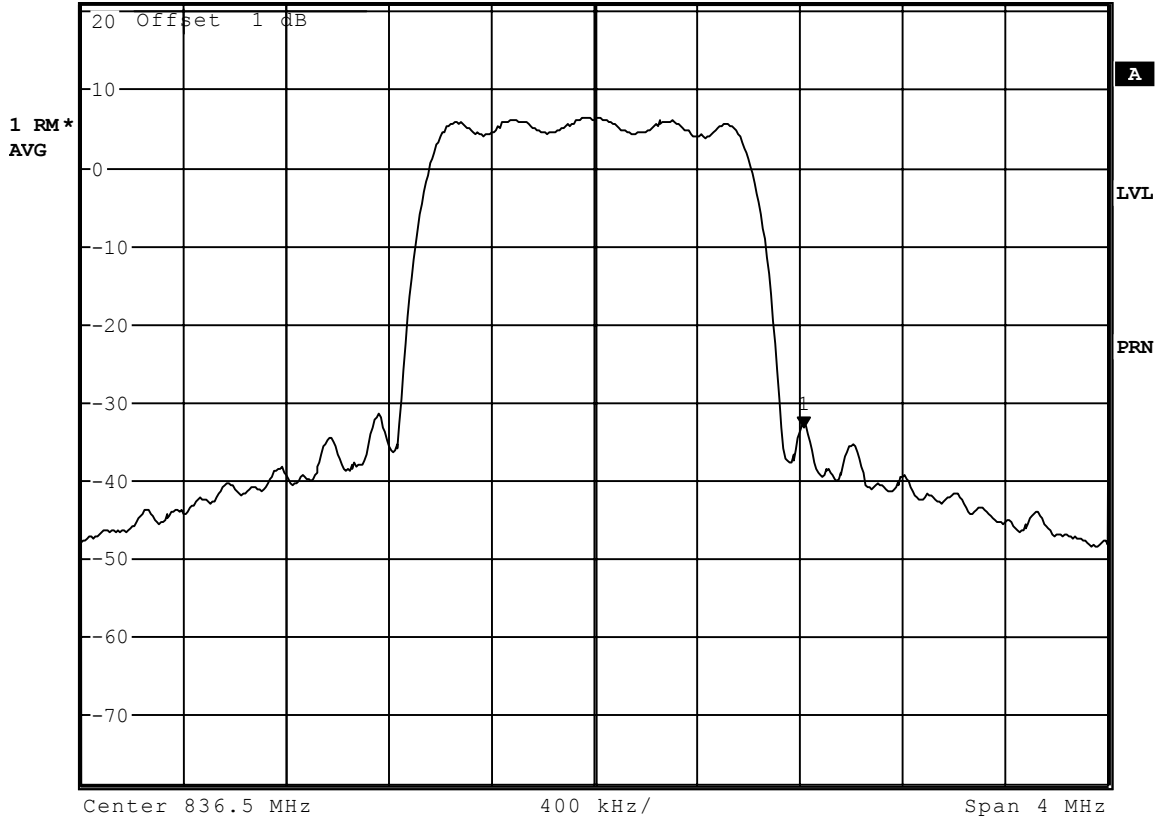

Date: 31.MAY.2002 16:40:23

# SIERRA WIRELESS, INC.

## Plot 5.2b



AC575  
31.May 02 16:38  
Ref 21 dBm  
\*RBW 1 MHz  
\*VBW 10 MHz  
\*SWT 500 ms  
Marker 1 [T1]  
-42.90 dBm  
1.666000000 GHz  
\*Att 30 dB

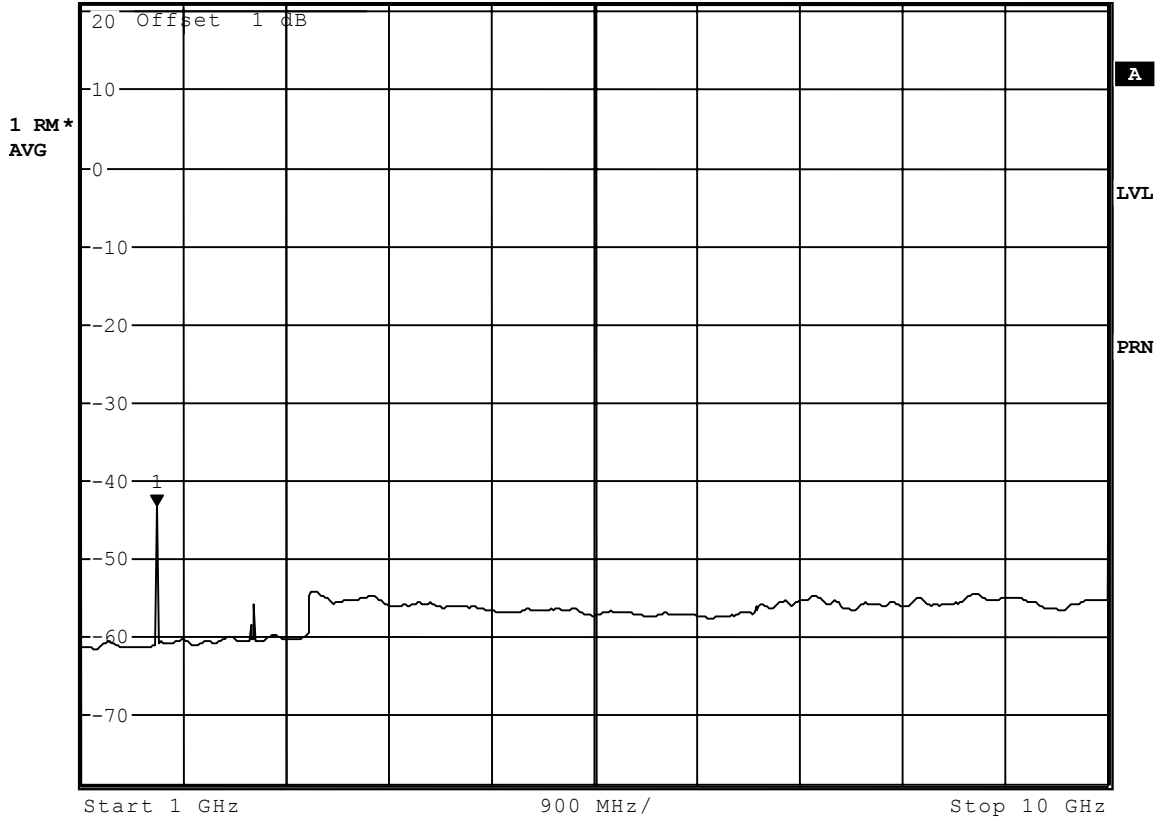

Date: 31.MAY.2002 16:38:55

SIERRA WIRELESS, INC.

Plot 5.3a



AC575 \*RBW 30 kHz Marker 1 [T1]  
31.May 02 16:43 \*VBW 30 kHz -28.37 dBm  
Ref 21 dBm \*Att 30 dB \*SWT 20 ms 848.59000000 MHz

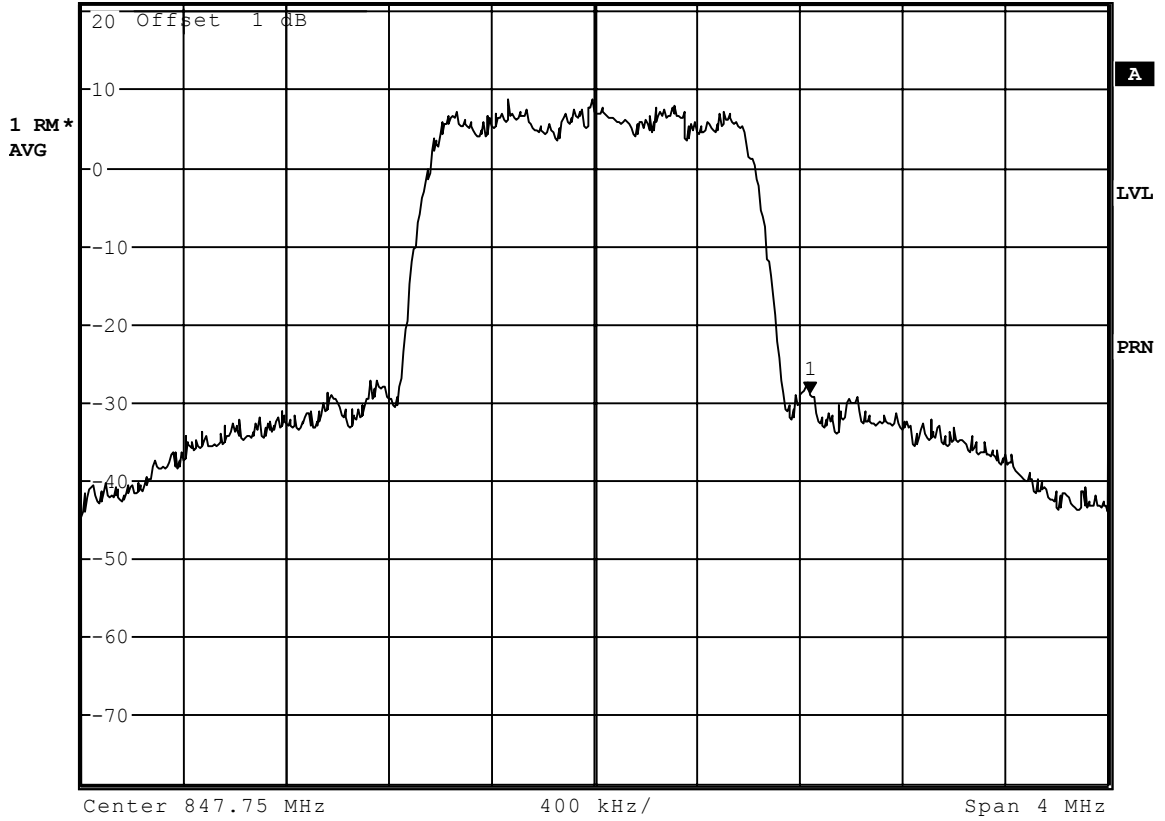

Date: 31.MAY.2002 16:43:14

SIERRA WIRELESS, INC.

Plot 5.3b



AC575  
31.May 02 16:45  
Ref 21 dBm  
\*RBW 1 MHz  
\*VBW 10 MHz  
\*SWT 500 ms  
Marker 1 [T1]  
-40.72 dBm  
1.684000000 GHz  
\*Att 30 dB

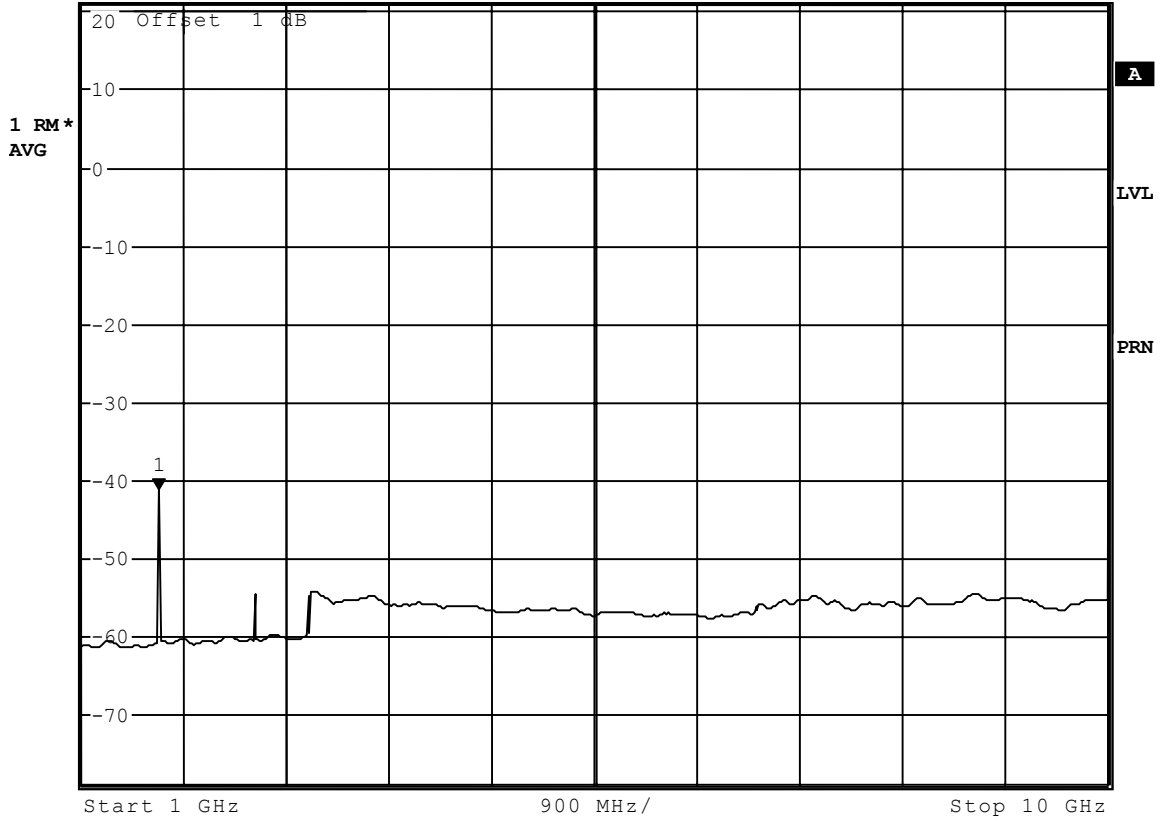

Date: 31.MAY.2002 16:45:08



# SIERRA WIRELESS, INC.

### Plot 5.4a

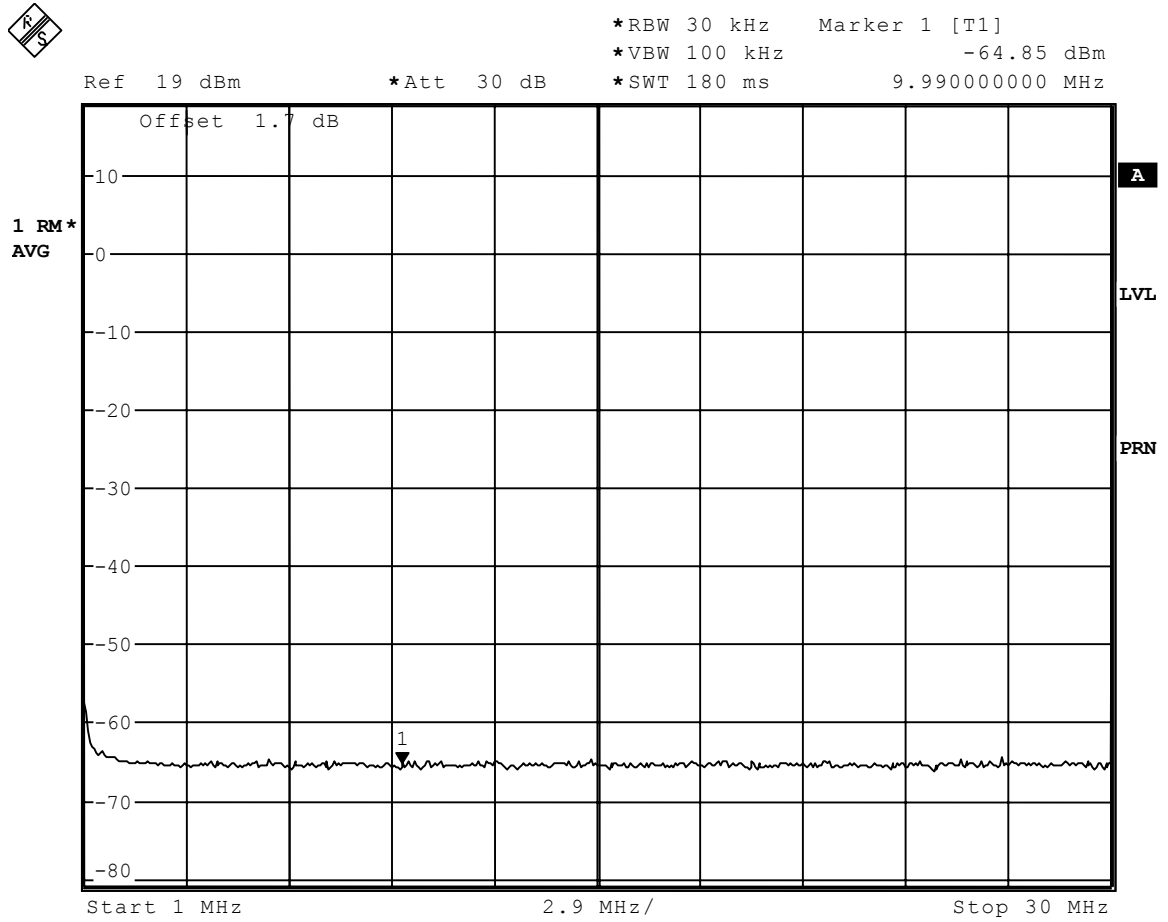

Date: 3.JUL.2002 14:43:52

SIERRA WIRELESS, INC.

Plot 5.4b

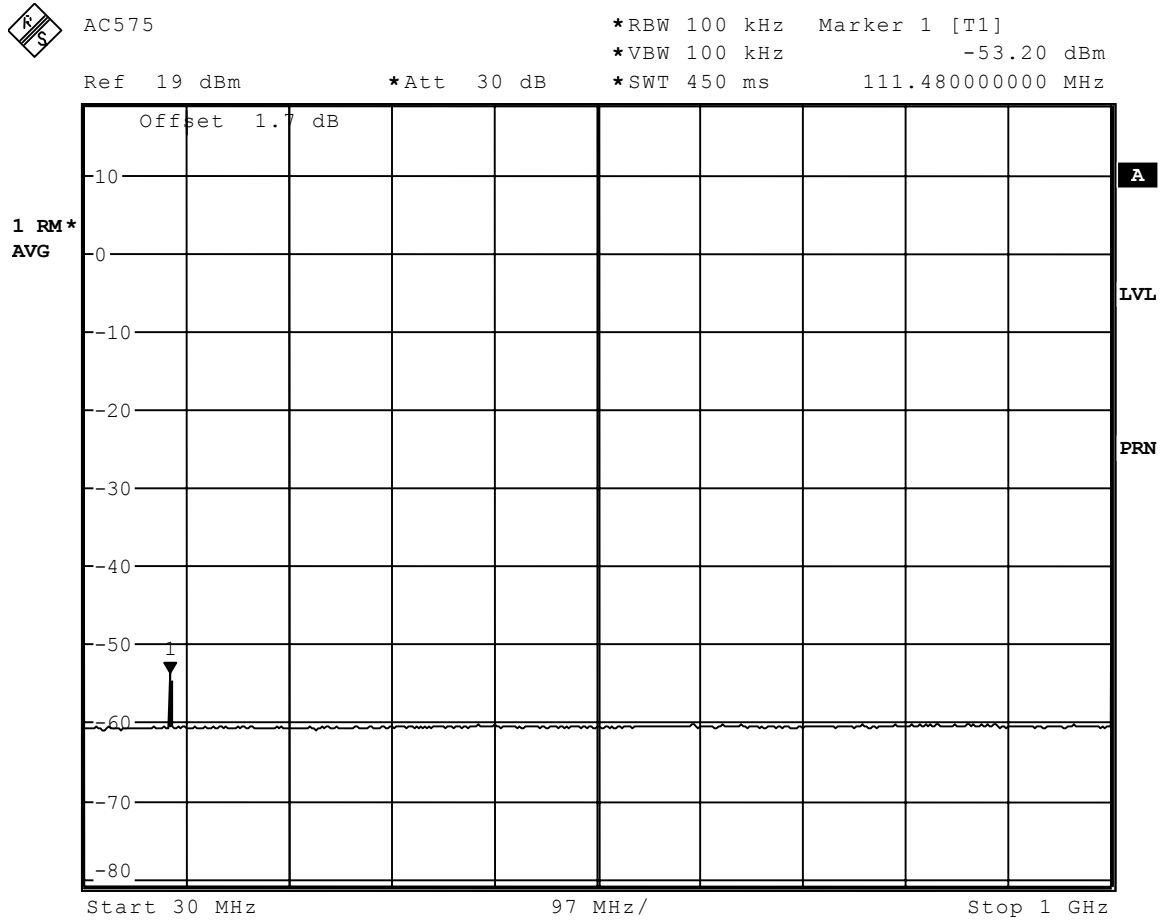

Date: 3.JUL.2002 14:45:43

# SIERRA WIRELESS, INC.

## Plot 5.4c



\*RBW 30 kHz    Marker 1 [T1]  
\*VBW 10 MHz    -23.34 dBm  
\*SWT 50 ms    1.850000000 GHz

Ref 19 dBm

\*Att 30 dB

1.850000000 GHz

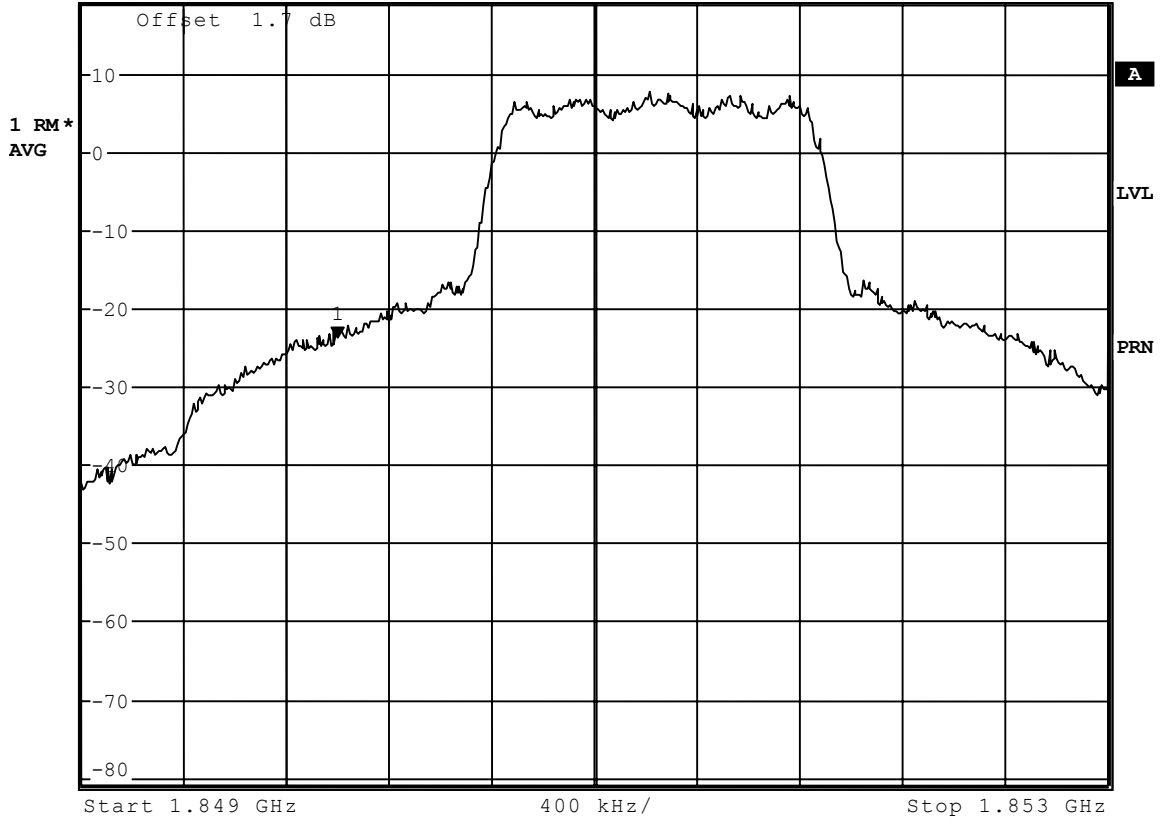

Date: 3.JUL.2002 14:40:07

# SIERRA WIRELESS, INC.

## Plot 5.4d

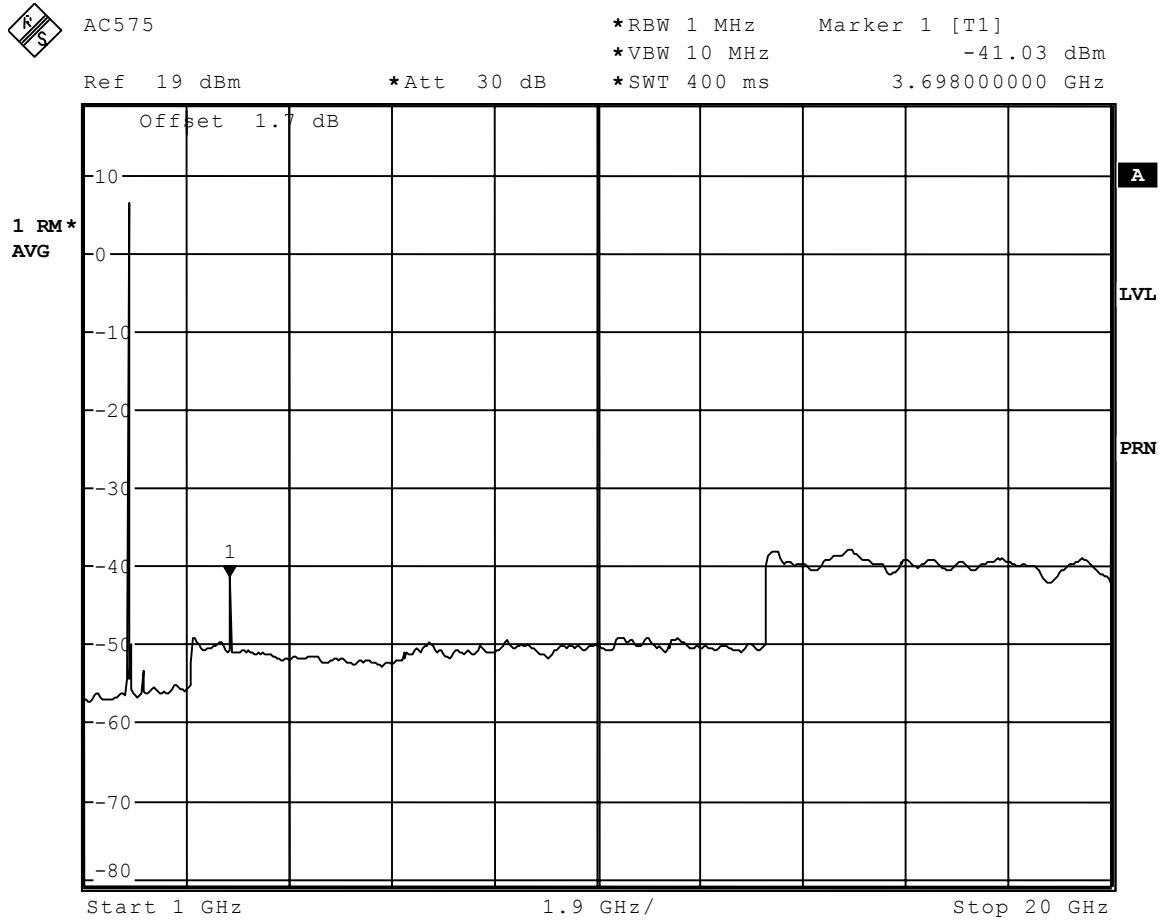

Date: 3.JUL.2002 14:47:19

SIERRA WIRELESS, INC.

Plot 5.5a

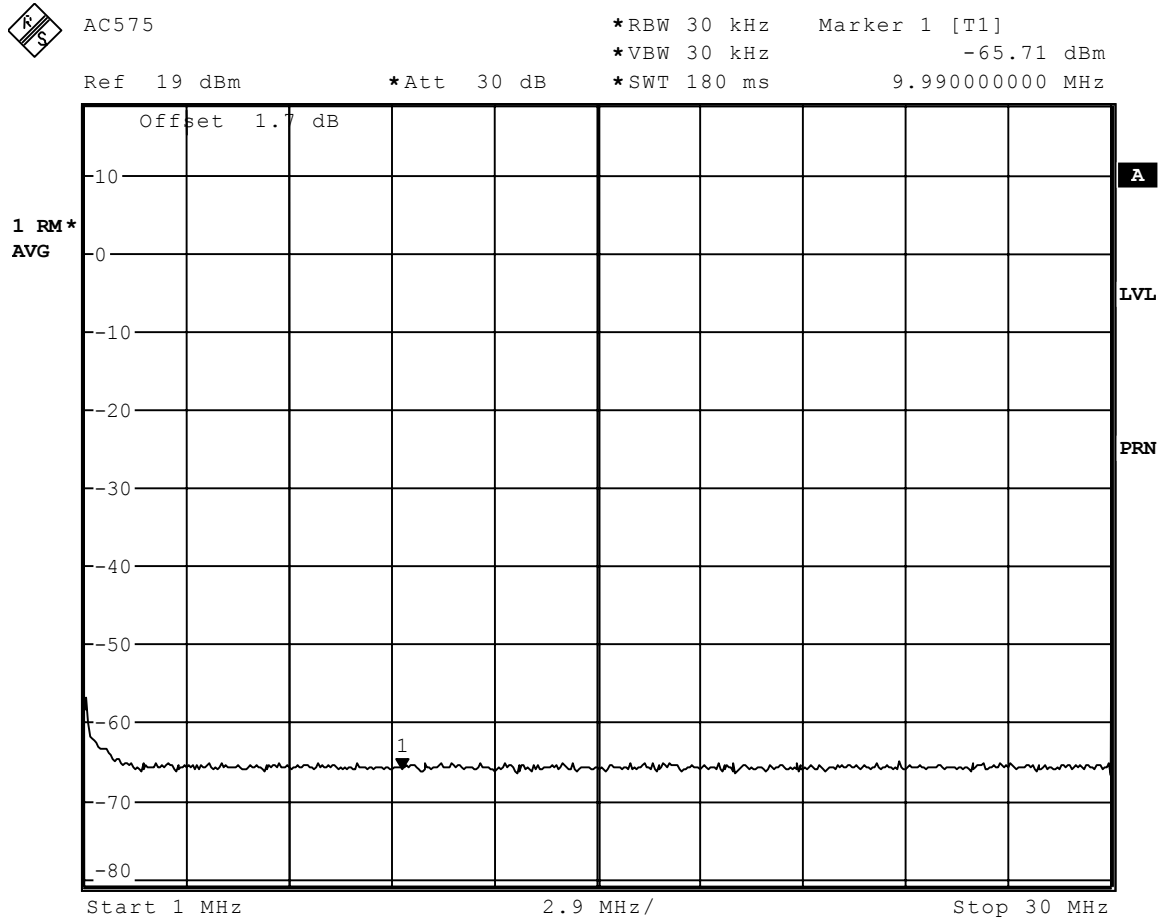

Date: 3.JUL.2002 14:54:46

# SIERRA WIRELESS, INC.

## Plot 5.5b

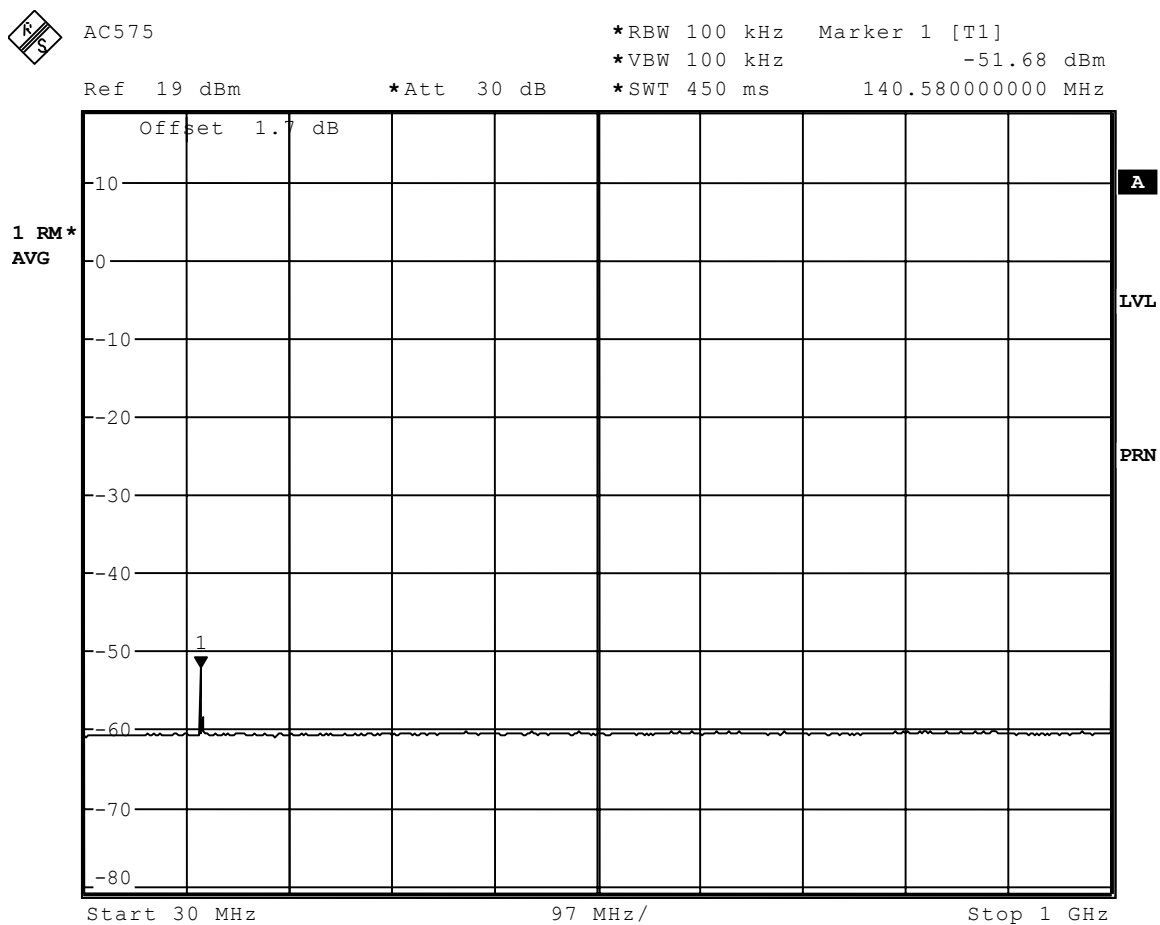

Date: 3.JUL.2002 14:55:47

# SIERRA WIRELESS, INC.

## Plot 5.5c

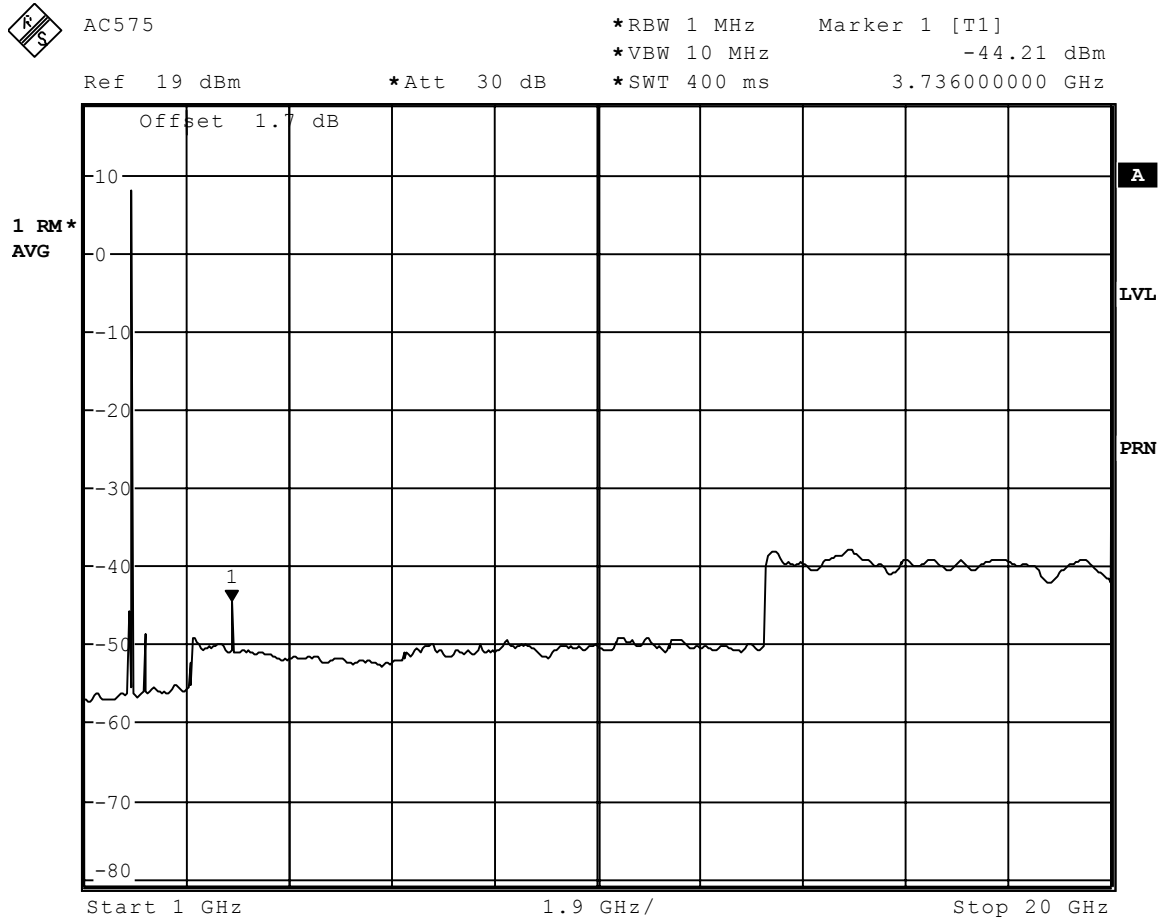

Date: 3.JUL.2002 14:56:42

SIERRA WIRELESS, INC.

Plot 5.6a

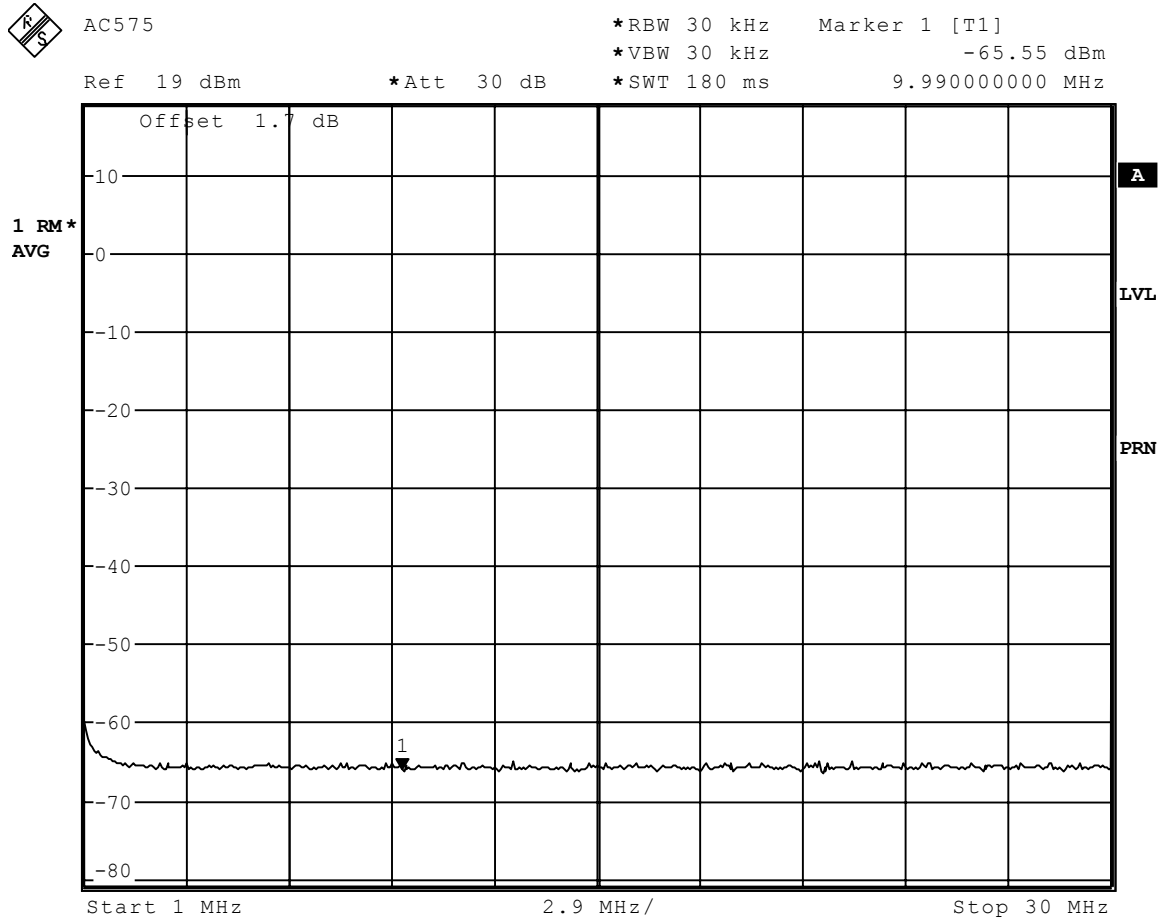

Date: 3.JUL.2002 15:01:27



# SIERRA WIRELESS, INC.

## Plot 5.6b

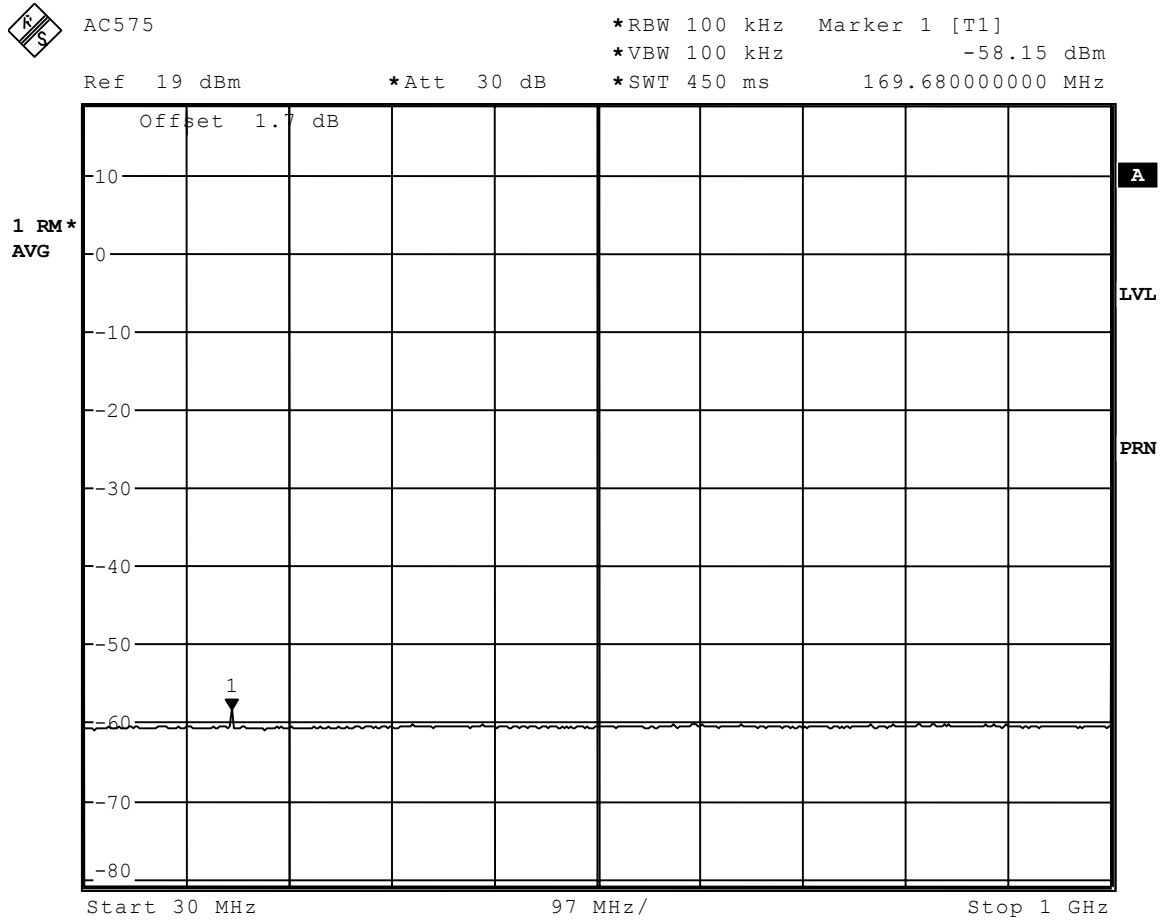

Date: 3.JUL.2002 15:02:20

# SIERRA WIRELESS, INC.

## Plot 5.6c

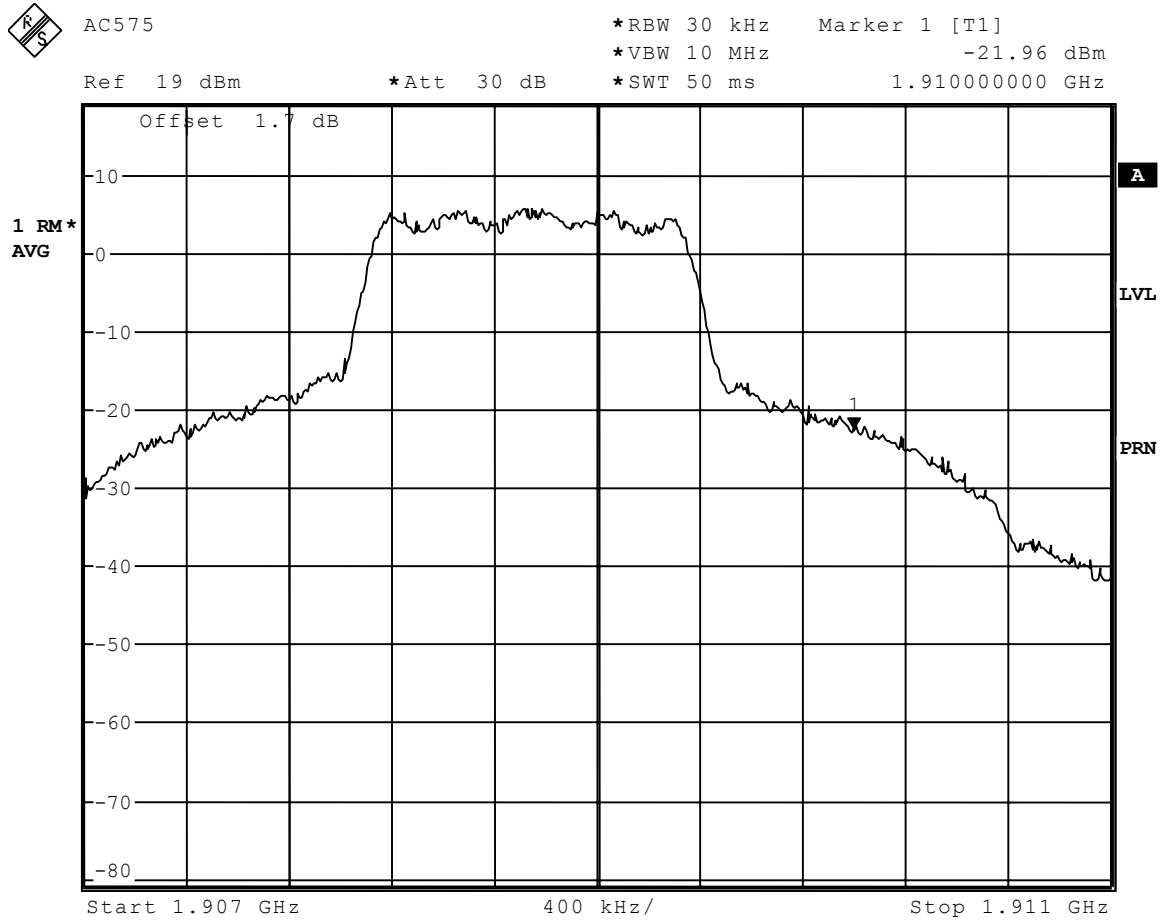

Date: 3.JUL.2002 15:00:15

SIERRA WIRELESS, INC.

Plot 5.6d

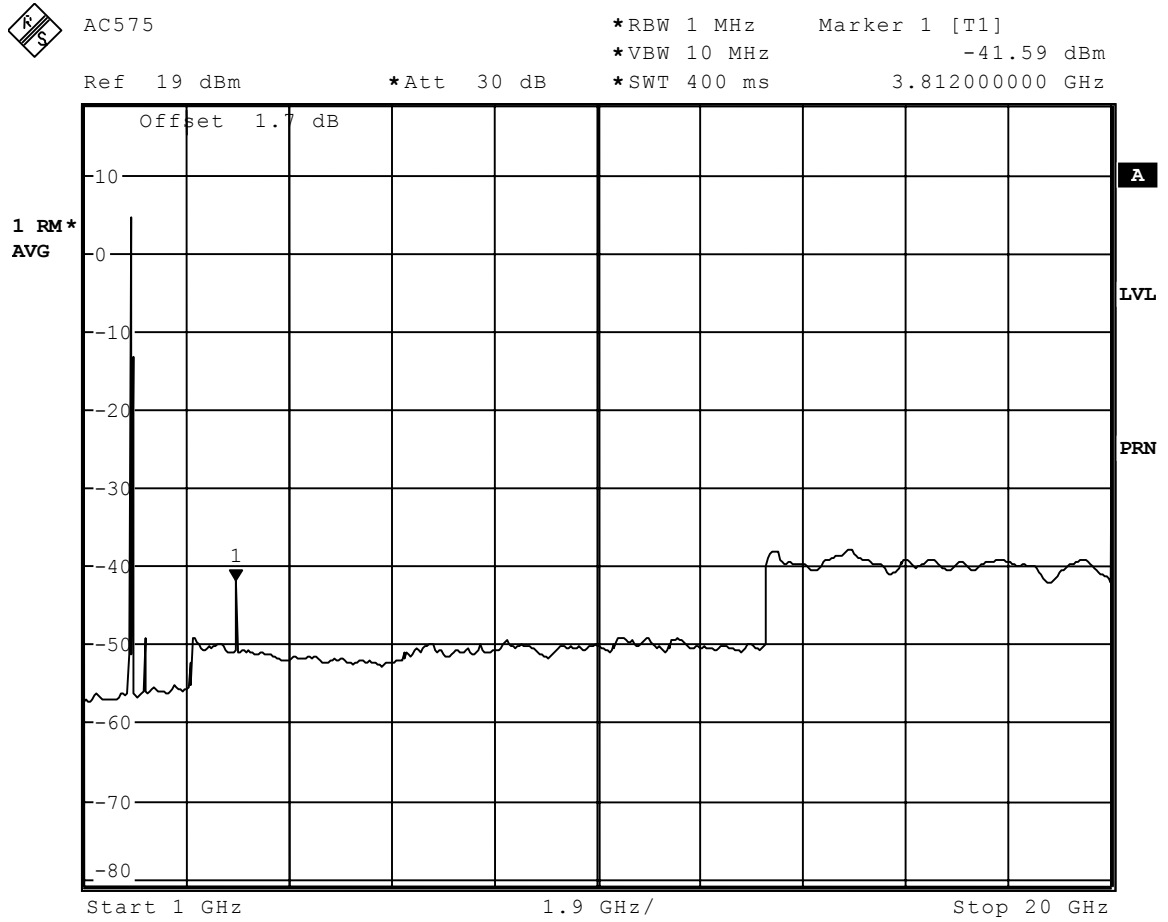

Date: 3.JUL.2002 15:03:13

SIERRA WIRELESS, INC.

Plot 5.7a

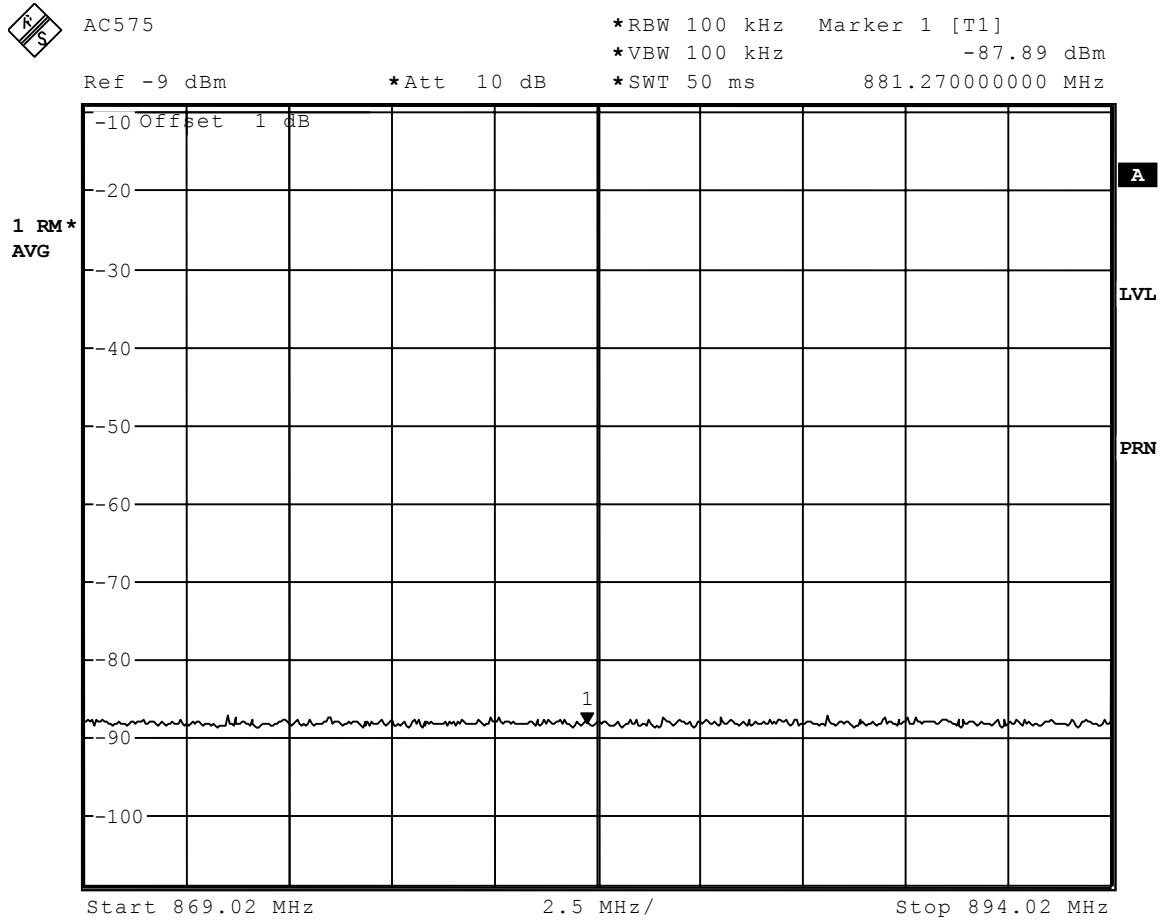

Date: 19.JUN.2002 15:39:18

SIERRA WIRELESS, INC.

Plot 5.7b

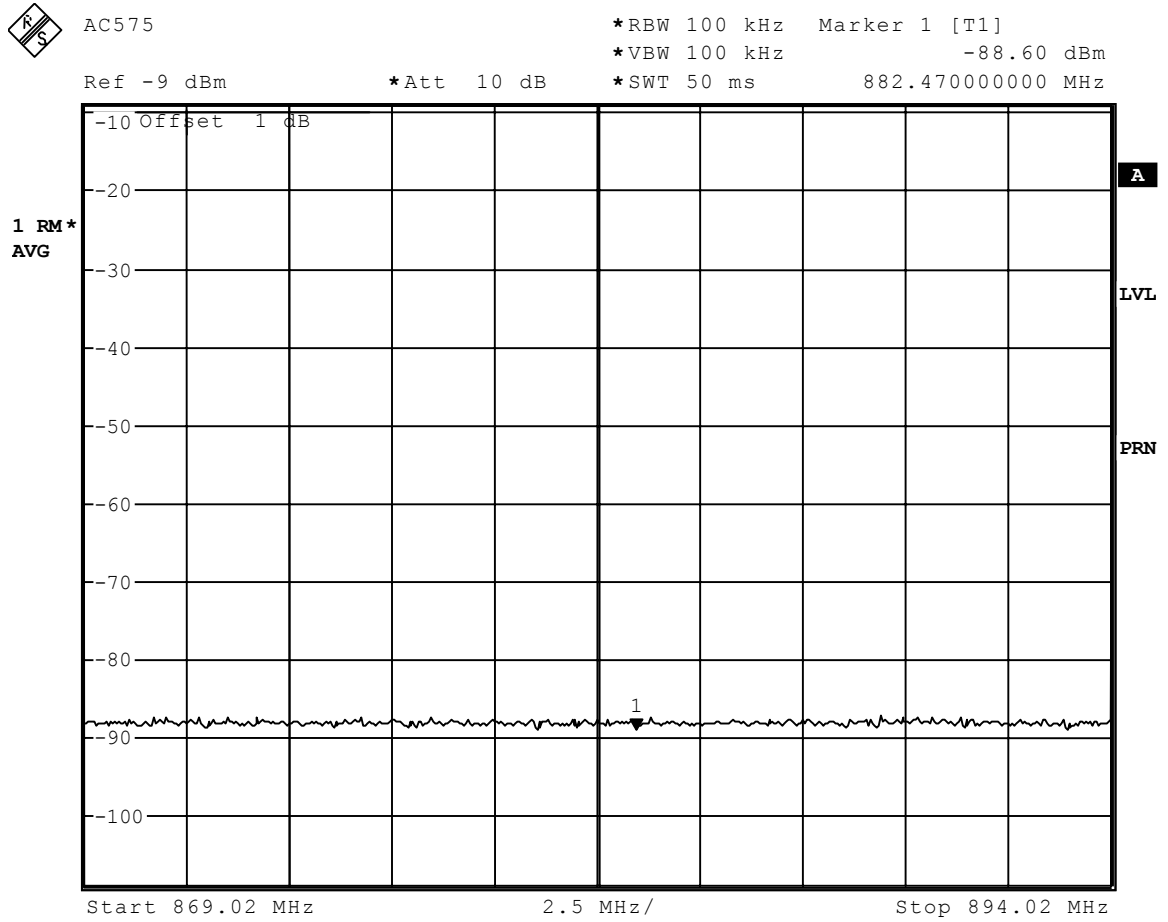

Date: 19.JUN.2002 15:39:45

SIERRA WIRELESS, INC.

Plot 5.7c

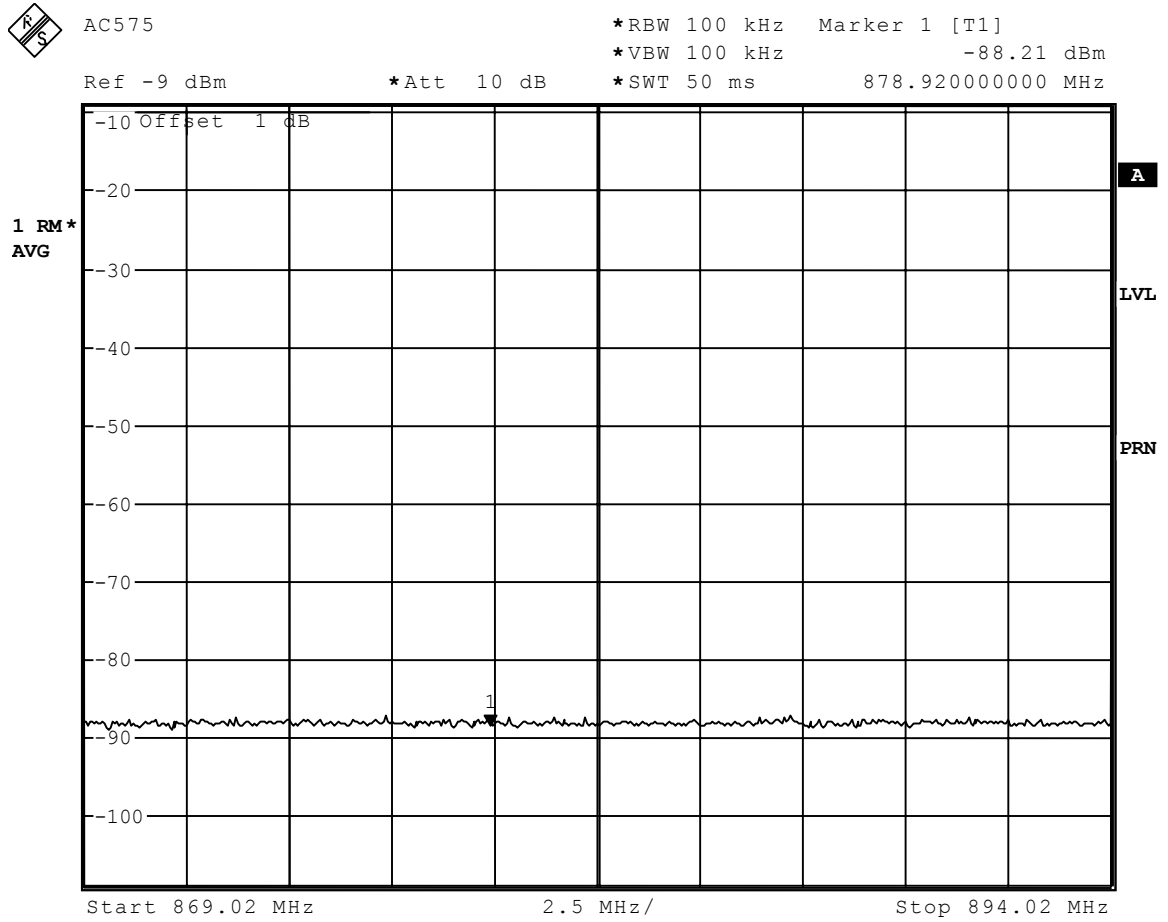

Date: 19.JUN.2002 15:40:17

**SIERRA WIRELESS, INC.**

FCC Part 22 & 24 Test Report	FCC ID: N7NAC575	June 2002	Page 39 of 42
------------------------------	------------------	-----------	---------------

**6 Field Strength of Spurious Radiation**

FCC 2.1053, 22.901(d), 24.238(a)

This test was performed at CCS and please refer to the attached CCS Test Report (AC575CCS\_report.pdf).

## 7 Frequency Stability vs Temperature

FCC 2.1055

### 7.1 Test Procedure

The AC575 was placed inside the temperature chamber. After the temperature stabilized for approximately 20 minutes, the transmitting frequency was recorded.

### Test Setup

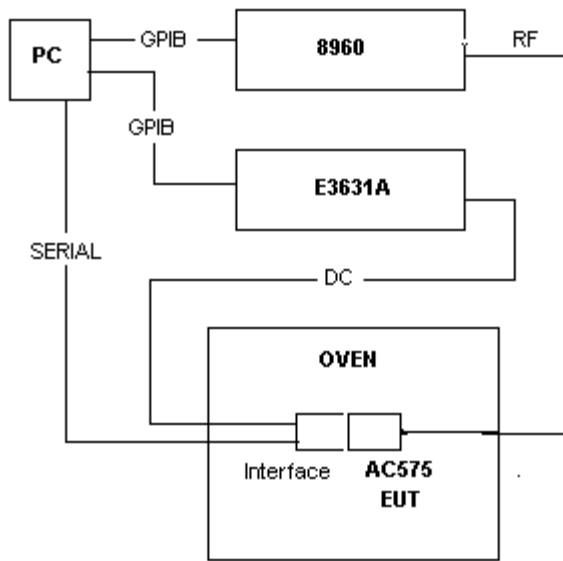

### 7.2 Test Equipment

EQUIPMENT	MANUFACTURER	MODEL	SERIAL NO.	CAL. DUE DATE
Wireless Test Set	Agilent	8960	GB41070182	2003-06-27
DC Power Supply	Hewlett Packard	E3631A	KR94624200	N/A
Temperature Chamber	Sigma Systems	M30M	7454	N/N



## SIERRA WIRELESS, INC.

### 7.3 Test Results

Transmitting Frequency: 1880 MHz

Temperature (°C)	Frequency (MHz)	Difference (Hz)
-30	1879.999997	-2.9
-20	1880.000009	8.5
-10	1880.000003	3.1
0	1879.999996	-3.8
10	1879.999997	-3.3
20	1880.000007	7.4
30	1879.999997	-3.3
40	1879.999994	-6.4
50	1880.000004	3.5

Note: The measured frequency stability vs temperature for the Cellular band is identical (% difference) to the above table since the transmitting frequency is locked to the same oscillator.

# SIERRA WIRELESS, INC.

FCC Part 22 & 24 Test Report	FCC ID: N7NAC575	June 2002	Page 42 of 42
------------------------------	------------------	-----------	---------------

## 8 Frequency Stability vs Voltage

FCC 2.1055

### 8.1 Test Procedure

The AC575 was connected to a DC Power Supply. The voltage was set to 115% of the nominal voltage and was then decreased to 85% of the nominal value. The output frequency was recorded for each voltage setting.

### Test Setup

Refer to Section 7.1

### 8.2 Test Equipment

EQUIPMENT	MANUFACTURER	MODEL	SERIAL NO.	CAL. DUE DATE
Wireless Test Set	Agilent	8960	GB41070182	2003-06-27
DC Power Supply	Hewlett Packard	E3631A	KR94624200	N/A
Temperature Chamber	Sigma Systems	M30M	7454	N/A

### 8.3 Test Results

Transmitting Frequency : 837 MHz

Vcc (Volts)	Frequency (MHz)	Difference (Hz)
4.0	837.000006	5.8
6.0	836.999992	-7.9

Transmitting Frequency: 1880 MHz

Vcc (Volts)	Frequency (MHz)	Difference (Hz)
4.0	1880.000004	3.7
6.0	1879.999994	-5.5