



**FCC CFR47 PART 22H AND 24E
&
INDUSTRY CANADA RSS-132 AND RSS-133
CLASS II PERMISSIVE CHANGE
CERTIFICATION TEST REPORT**

FOR

PCA, EVDO MINI-PCI EXPRESS CARD CDMA MODEM

MODEL NUMBER: MC5727, MC5727V

**FCC ID: N7N-MC5725
IC: 2417C-MC5725**

REPORT NUMBER: 08U11847-1, Revision B

ISSUE DATE: JULY 22, 2008

Prepared for

**SIERRA WIRELESS INC.
2290 COSMOS CT.
CARLSBAD, CA 92010, U.S.A.**

Prepared by

**COMPLIANCE CERTIFICATION SERVICES
47173 BENICIA STREET
FREMONT, CA, 94538 U.S.A.
TEL: (510) 771-1000
FAX: (510) 661-0888**



NVLAP LAB CODE 200065-0

Revision History

<u>Rev.</u>	<u>Issue Date</u>	<u>Revisions</u>	<u>Revised By</u>
---	06/11/08	Initial Issue	T. Chan
A	07/10/08	Added model 5727V to report	A. Zaffar
B	07/22/08	Updated Section 5.3 & Removed MPE Section	T. Chan

TABLE OF CONTENTS

1. TEST RESULT CERTIFICATION	4
2. TEST METHODOLOGY	5
3. FACILITIES AND ACCREDITATION.....	5
4. CALIBRATION AND UNCERTAINTY.....	5
4.1. <i>MEASURING INSTRUMENT CALIBRATION.....</i>	<i>5</i>
4.2. <i>MEASUREMENT UNCERTAINTY.....</i>	<i>5</i>
5. EQUIPMENT UNDER TEST.....	6
5.1. <i>DESCRIPTION OF EUT.....</i>	<i>6</i>
5.2. <i>DESCRIPTION OF CLASS II CHANGE.....</i>	<i>7</i>
5.3. <i>MAXIMUM OUTPUT POWER.....</i>	<i>8</i>
5.4. <i>DESCRIPTION OF AVAILABLE ANTENNAS.....</i>	<i>8</i>
5.5. <i>SOFTWARE AND FIRMWARE.....</i>	<i>8</i>
5.6. <i>WORST-CASE CONFIGURATION AND MODE.....</i>	<i>9</i>
5.7. <i>DESCRIPTION OF TEST SETUP.....</i>	<i>10</i>
6. TEST AND MEASUREMENT EQUIPMENT.....	13
7. LIMITS AND RESULTS.....	14
7.1. <i>OCCUPIED BANDWIDTH.....</i>	<i>14</i>
7.2. <i>RF POWER OUTPUT.....</i>	<i>21</i>
7.3. <i>SPURIOUS EMISSION AT ANTENNA TERMINAL.....</i>	<i>30</i>
7.4. <i>FREQUENCY STABILITIES.....</i>	<i>44</i>
7.5. <i>RECEIVER SPURIOUS EMISSIONS.....</i>	<i>47</i>
7.6. <i>POWER LINE CONDUCTED EMISSION.....</i>	<i>51</i>
8. SETUP PHOTOS.....	54

1. TEST RESULT CERTIFICATION

COMPANY NAME: SIERRA WIRELESS
2290 COSMOS CT.
CARLSBAD, CA, 92010 U.S.A.

EUT DESCRIPTION: PCA, EVDO MINI-PCI EXPRESS CARD CDMA MODEM

SERIAL NUMBER: P721128001710-10

MODEL NAMES: MC5727, MC5727V

DATE TESTED: JUNE 2 – JUNE 9, 2008

APPLICABLE STANDARDS	
STANDARD	TEST RESULTS
FCC PART 22H and 24E	PASS
IC RSS-132 ISSUE 2 and RSS-133 ISSUE 4	PASS

Compliance Certification Services, Inc. (CCS) tested the above equipment in accordance with the requirements set forth in the above standards. All expressions of Pass/Fail in this report are opinions expressed by CCS based on interpretations of the test results. The test results show that the equipment tested is capable of demonstrating compliance with the requirements as documented in this report.

Note: The results documented in this report apply only to the tested sample, under the conditions and modes of operation as described herein. This document may not be altered or revised in any way unless done so by Compliance Certification Services and all revisions are duly noted in the revisions section. Any alteration of this document not carried out by Compliance Certification Services will constitute fraud and shall nullify the document. No part of this report may be used to claim product certification, approval, or endorsement by NVLAP, NIST, or any government agency.

Approved & Released For CCS By:

Tested By:

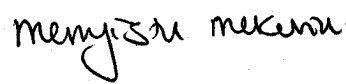

THU CHAN
EMC SUPERVISOR
COMPLIANCE CERTIFICATION SERVICES

MENGISTU MEKURIA
EMC ENGINEER
COMPLIANCE CERTIFICATION SERVICES

2. TEST METHODOLOGY

The tests documented in this report were performed in accordance with RSS-GEN, RSS132, RSS133, ANSI C63.4-2003, and TIA/EIA 603C (2004).

3. FACILITIES AND ACCREDITATION

The test sites and measurement facilities used to collect data are located at 47173 Benicia Street, Fremont, California, USA.

CCS is accredited by NVLAP, Laboratory Code 200065-0. The full scope of accreditation can be viewed at <http://www.ccsemc.com>.

4. CALIBRATION AND UNCERTAINTY

4.1. MEASURING INSTRUMENT CALIBRATION

The measuring equipment utilized to perform the tests documented in this report has been calibrated in accordance with the manufacturer's recommendations, and is traceable to recognized national standards.

4.2. MEASUREMENT UNCERTAINTY

Where relevant, the following measurement uncertainty levels have been estimated for tests performed on the apparatus:

PARAMETER	UNCERTAINTY
Radiated Emission, 30 to 200 MHz	+/- 3.3 dB
Radiated Emission, 200 to 1000 MHz	+4.5 / -2.9 dB
Radiated Emission, 1000 to 2000 MHz	+4.5 / -2.9 dB
Radiated Emission, Above 2000 MHz	+/- 4.3 dB
Power Line Conducted Emission	+/- 2.9 dB

Uncertainty figures are valid to a confidence level of 95%.

5. EQUIPMENT UNDER TEST

5.1. DESCRIPTION OF EUT

The EUT is a dual band, 800/1900MHz, PCA EVDO Mini-PCI Express Card CDMA Modem. The module manufactured by Sierra Wireless, Inc.

5.2. DESCRIPTION OF CLASS II CHANGE



Date: 7/2/08

Federal Communications Commission
Authorization and Evaluation Division
7435 Oakland Mills Road
Columbia, MD 21046

Attn: OET Dept.

Ref: FCC Class II Permissive change for FCC ID: N7N-MC5725
(Original Grant date: 5/15/2006)
Applicant: Sierra Wireless

Dear Examiner,

This is to request a Class II permissive change for FCC ID: N7N-MC5725, originally granted on 5/15/2006. This change also applies to FCC ID: N7N-MC5727 which is electrically identical.

The change filed under this application is:

The hardware changes to support the Qualcomm – Broadcom FTS litigation. The components were highlighted in the submitted schematic diagram and PCB layout documents.

If you have any questions regarding this application, please feel free to contact me.

Sincerely,

Todd Van Cleave
Manager Engineering Services
Carlsbad Research & Development
Sierra Wireless America, Inc.

5.3. MAXIMUM OUTPUT POWER

The transmitter has a maximum radiated emission peak output powers as follows:

824 to 849 MHz Authorized Band

Frequency Range (MHz)	Modulation	Conducted Average (dBm)	Conducted Peak Power (dBm)	Conducted Peak Power (mW)
Low CH - 824.7	1 x EVDO, Rev A	24.80	29.25	841.40
Mid CH - 836.5		24.86	29.23	837.53
High CH - 848.3		24.55	28.64	731.14

1850 to 1910 MHz Authorized Band

Frequency Range (MHz)	Modulation	Conducted Average Power (dBm)	Conducted Peak Power (dBm)	Conducted Peak Power (mW)
Low CH - 1851.25	1 x EVDO, Rev A	24.96	28.70	741.31
Mid CH - 1880		25.26	28.91	778.04
High CH - 1908.75		24.94	28.20	660.69

5.4. DESCRIPTION OF AVAILABLE ANTENNAS

The radio utilizes a dipole antenna with a maximum gain of 0dBi for Cellular band PCS bands.

5.5. SOFTWARE AND FIRMWARE

The EUT is linked with Agilent Communication Test Set.

5.6. WORST-CASE CONFIGURATION AND MODE

PROCEDURE USED TO ESTABLISH TEST SIGNAL

3G-CDMA2000 1xEV-DO Revision A (Rev A)

This procedure assumes the Agilent 8960 Test Set has the following applications installed and with valid license.

<u>Application</u>	<u>Rev. License</u>
1xEV-DO Terminal Test	A.06.06, L

RETAP

- Call Setup > Shift & Preset
- Protocol Rev > A (1xEV-DO-A)
- Application Config > Enhanced Test Application Protocol > RETAP
- F-Traffic Format > 4 (1024, 2,128) Canonical (307.2k, QPSK)
- R-Data Pkt Size > 4096 (for PCS band), 12288 (for Cellular band)
- Protocol Subtype Config > Release A Physical Layer Subtype > Subtype 2
> PL Subtype 2 Access Channel MAC Subtype > Default (Subtype 0)
- Access Network Info > Cell Parameters > Sector ID > 00000000 > Subnet Mask > 0
- Generator Info > Termination Parameters > Max Forward Packet Duration >16 Slots
> ACK R-Data After > Subpacket 0 (All ACK)
- Rvs Power Ctrl > All Up bits (to get the maximum power)

EV-DO REV A Worst Case Data

Based on the previous test results from the different modulations, EV-DO, REV A Protocol RETAP to be the worst-case scenario for Cell and PCS bands.

The worst-case channel is determined as the channel with the highest output power. The highest measured output power was at mid channel for both CELL and PCS bands.

During emission tests two antenna orientations, X and Y, were investigated to determine the worst-case. The outcome showed that X-orientation as the worst-case.

5.7. DESCRIPTION OF TEST SETUP

SUPPORT EQUIPMENT

PERIPHERAL SUPPORT EQUIPMENT LIST				
Description	Manufacturer	Model	Serial Number	FCC ID
AC Adapter	ELPAC	W1505	14416	N/A
Test Fixture	Sierra Wireless	1200981-REV 3.X	MC00395	N/A
Wireless Communications Test Set	Agilent	E5515C	10092	DoC
Directional Coupler	Narda	4242-10	3423	N/A

I/O CABLES

I/O CABLE LIST						
Cable No.	Port	# of Identical Ports	Connector Type	Cable Type	Cable Length	Remarks
1	AC	1	US 115V	Un-shielded	2.0 m	NA
2	DC	1	DC	Un-shielded	2.0 m	Ferrite on DC end
3	RF In/Out	1	SMA	Shielded	1.0 m	NA
4	RF In/Out	1	SMA	Shielded	0.5 m	NA

TEST SETUP

The EUT is installed in a Test Kit during the tests, and the EUT is linked with Agilent Communication Test Set.

SETUP DIAGRAM FOR CONDUCTED TESTS

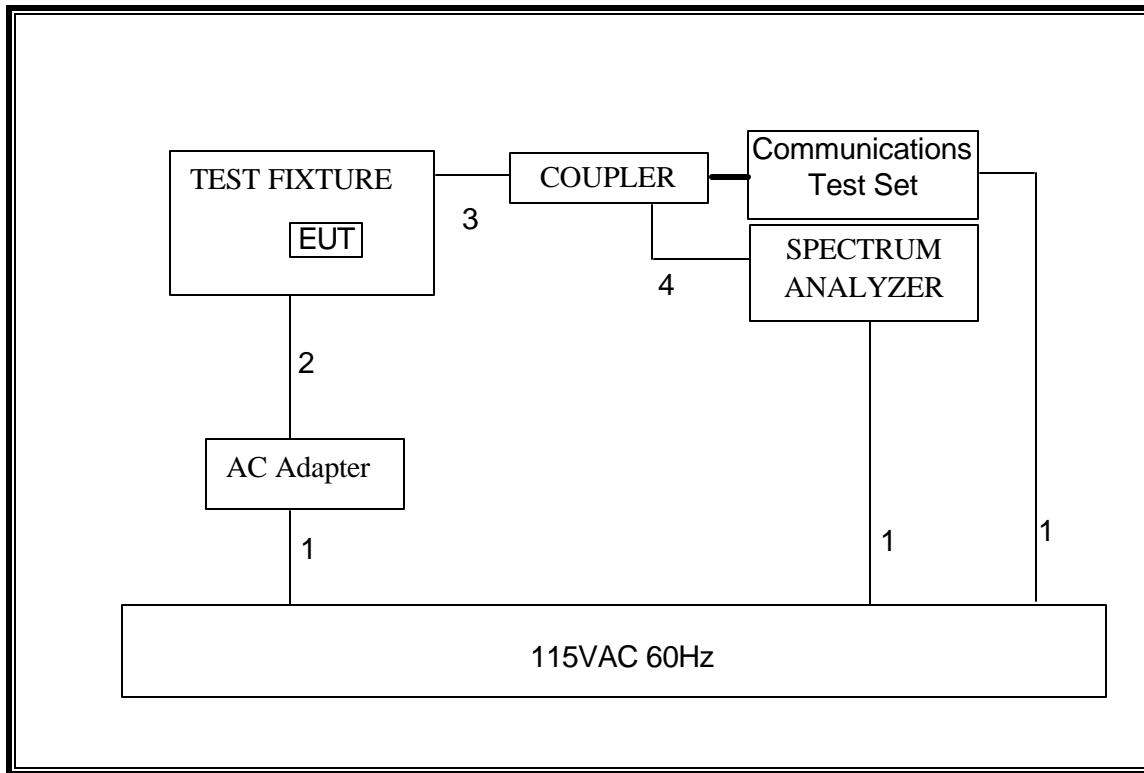

SETUP DIAGRAM FOR RADIATED TESTS

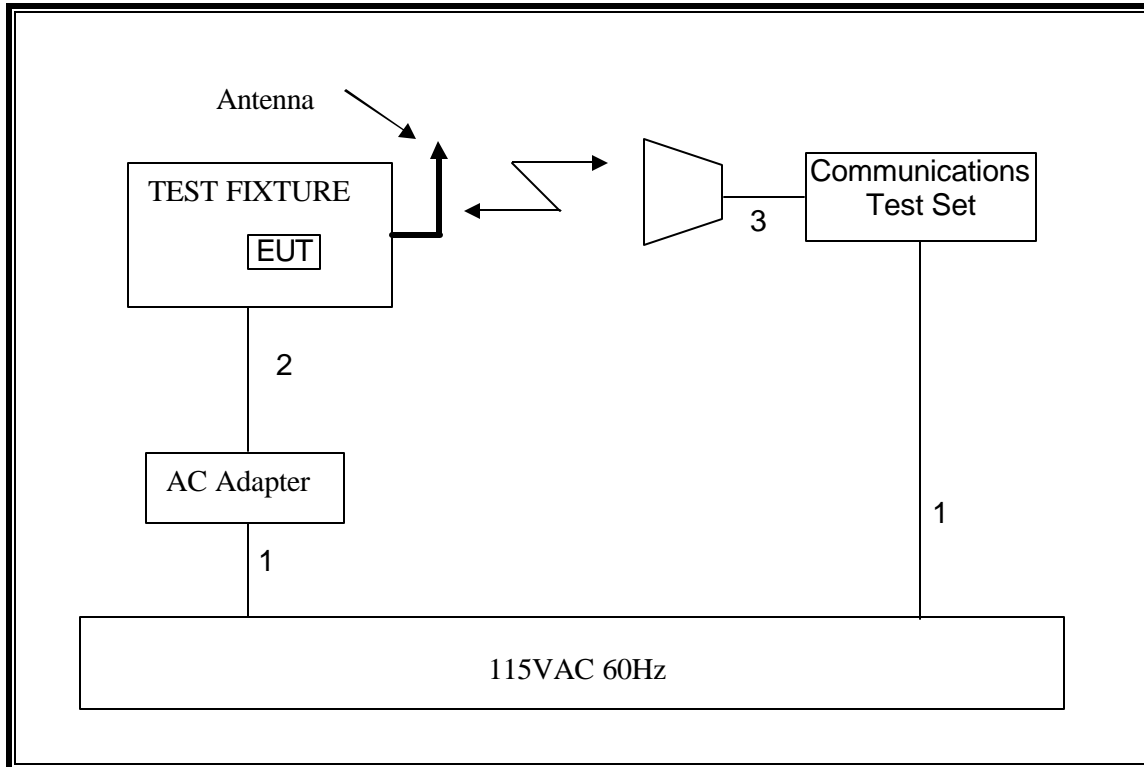

6. TEST AND MEASUREMENT EQUIPMENT

The following test and measurement equipment was utilized for the tests documented in this report:

TEST EQUIPMENT LIST				
Description	Manufacturer	Model	Serial Number	Cal Due
EMI Test Receiver, 30 MHz	R & S	ESHS 20	N02396	08/06/09
LISN, 30 MHz	FCC	LISN-50/250-25-2	N02625	10/25/08
LISN, 10 kHz ~ 30 MHz	Solar	8012-50-R-24-BNC	N02481	10/25/08
Preamp 30-1000MHz	Sonoma Instrument	310N	185623	03/31/09
Antenna, Bilog 30 MHz ~ 2 Ghz	Sunol Sciences	JB1	A121003	10/25/08
Spectrum Analyzer 3 Hz ~ 44 GHz	Agilent / HP	E4446A	MY43360112	03/03/09
Antenna, Horn 1 ~ 18 GHz	EMCO	3115	2238	04/22/09
Antenna, Horn 1 ~ 18 GHz	EMCO	3115	6717	04/22/09
Preamplifier, 1 ~ 26.5 GHz	Agilent / HP	8449B	3008A00369	09/27/08
Temperature / Humidity Chamber	Thermotron	SE 600-10-10	29800	05/13/09
Wireless Communications Test Set	Agilent	E5515C	10092	06/29/08
2.7GHz HPF	MicroTronic	HPM13194	2	CNR
1.5GHz HPF	MicroTronic	HPM13195	1	CNR
Signal Generator 2 -40 GHz	R & S	SMP04	DE 34210	02/16/09
Signal Generator 1024 MHz	R & S	SMY01	DE 12311	05/28/09
Dipole	ETS	3121C-DB2	22435	06/08/09

7. LIMITS AND RESULTS

7.1. OCCUPIED BANDWIDTH

LIMIT

None: for reporting purposes only.

TEST PROCEDURE

The transmitter output is connected to the spectrum analyzer. The RBW is set to 1% to 3% of the 99% bandwidth. The VBW is set to 3 times the RBW. The sweep time is coupled. The spectrum analyzer internal 99% and -26 dB bandwidths function are utilized.

RESULTS

No non-compliance noted.

CELL, CDMA Modulation

Channel	Frequency (MHz)	99% BW (MHz)	-26dB BW (MHz)
Low	824.70	1.265	1.378
Middle	836.52	1.266	1.382
High	848.31	1.269	1.384

PCS, CDMA Modulation

Channel	Frequency (MHz)	99% BW (MHz)	-26dB BW (MHz)
Low	1851.25	1.285	1.456
Middle	1880.00	1.292	1.499
High	1908.75	1.294	1.429

CELL CDMA BANDWIDTH

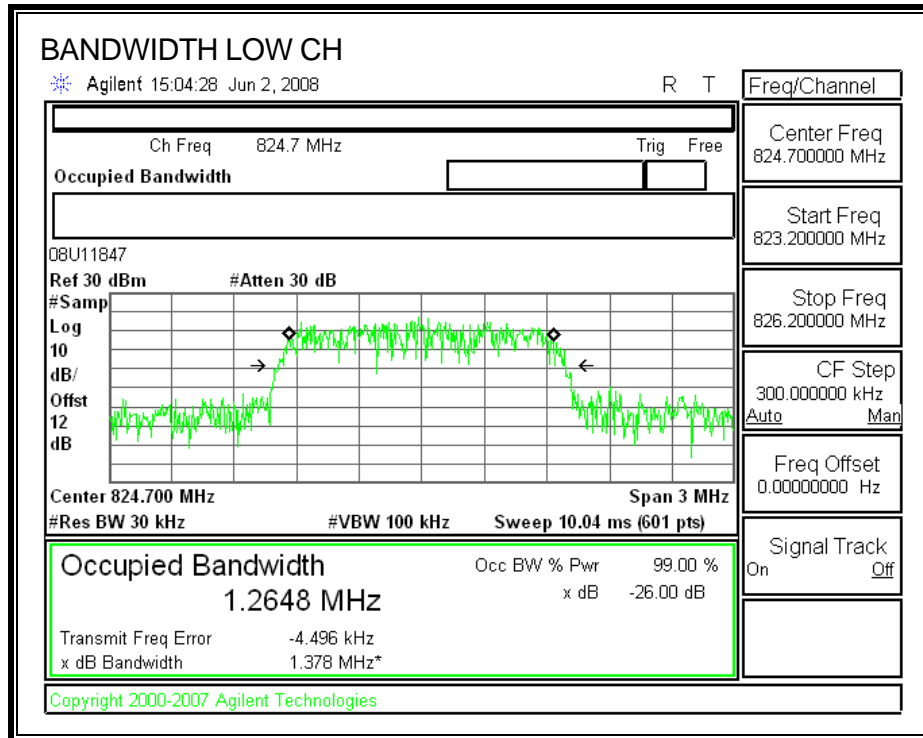

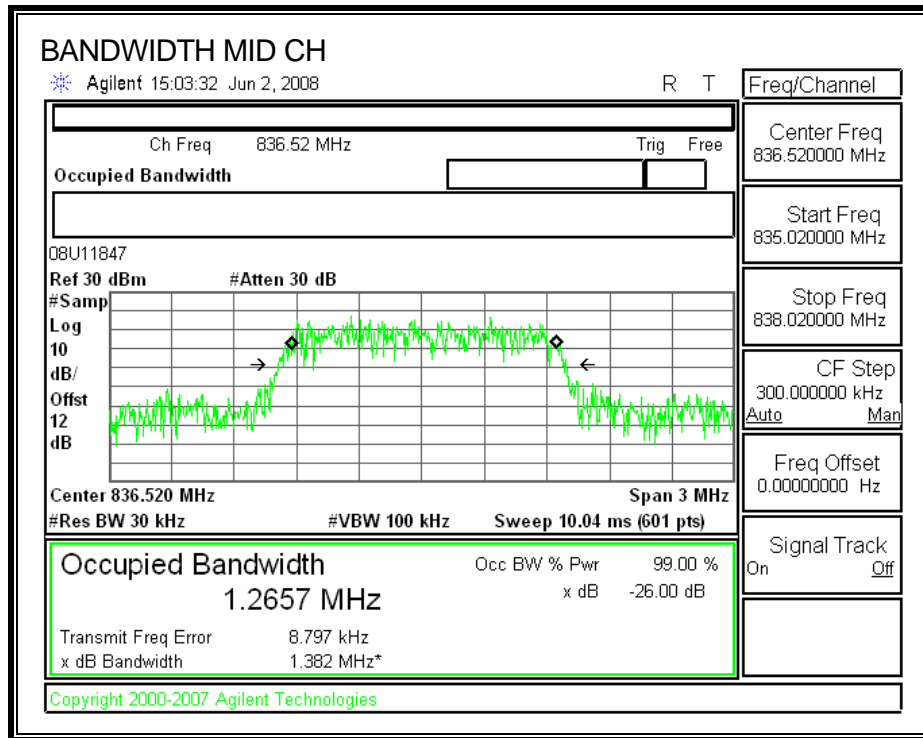

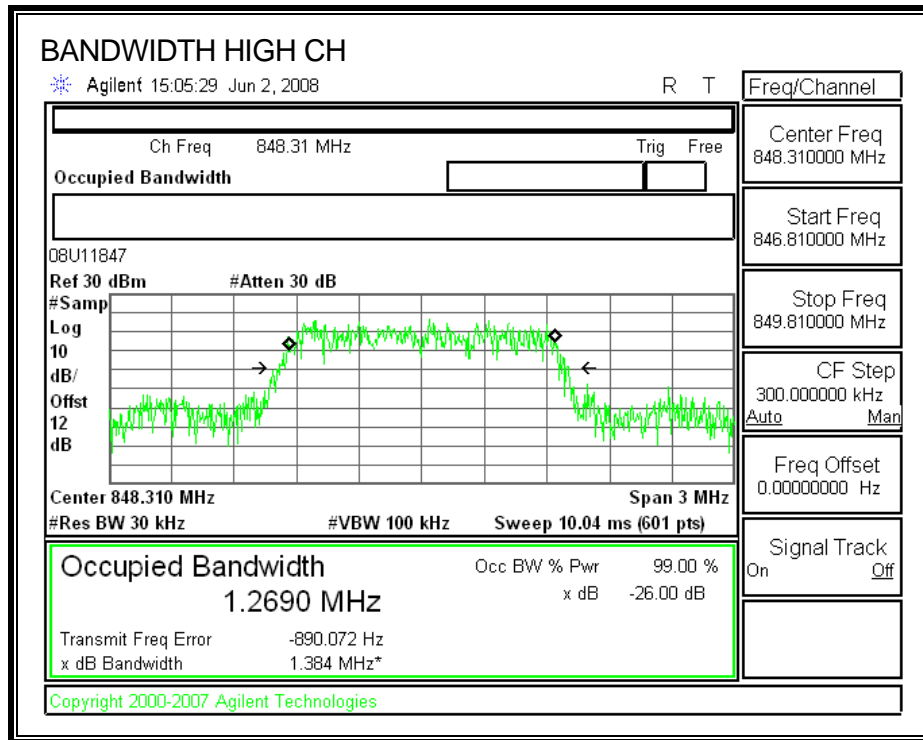

PCS, CDMA BANDWIDTH

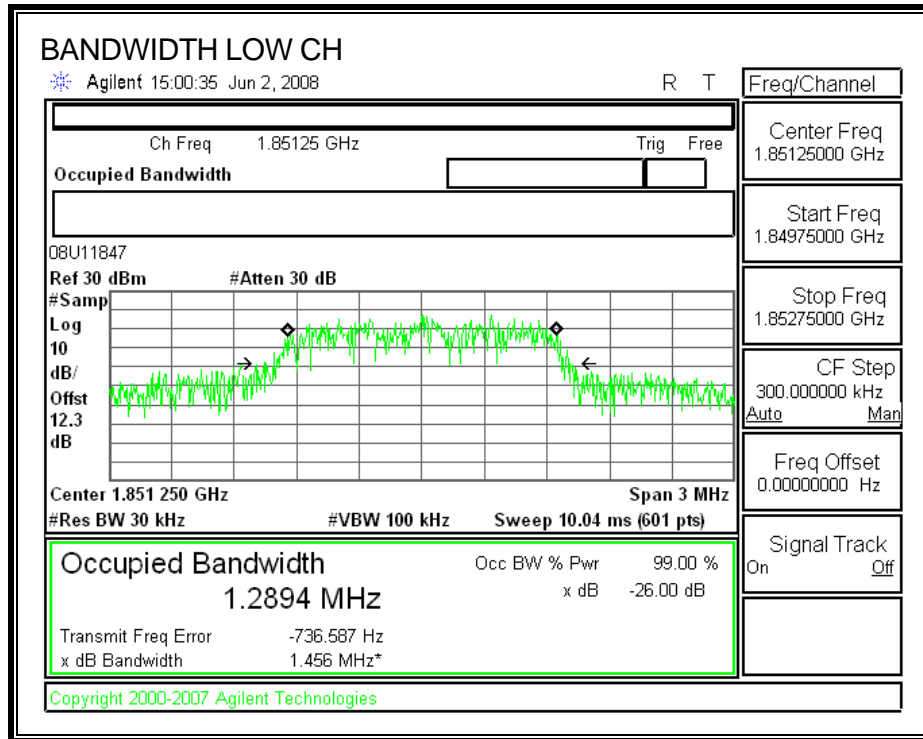

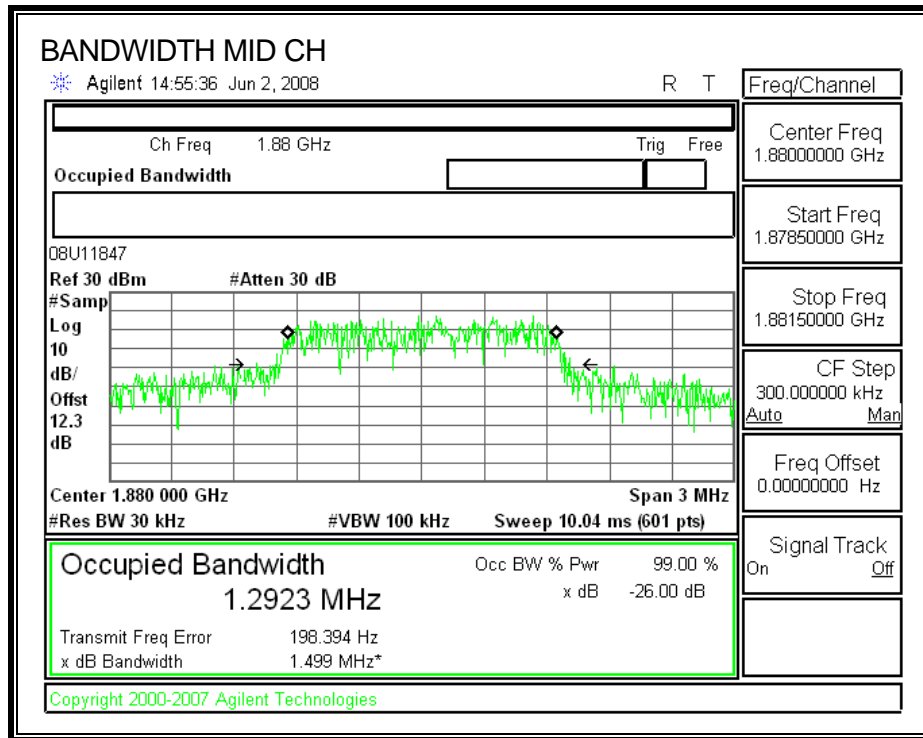

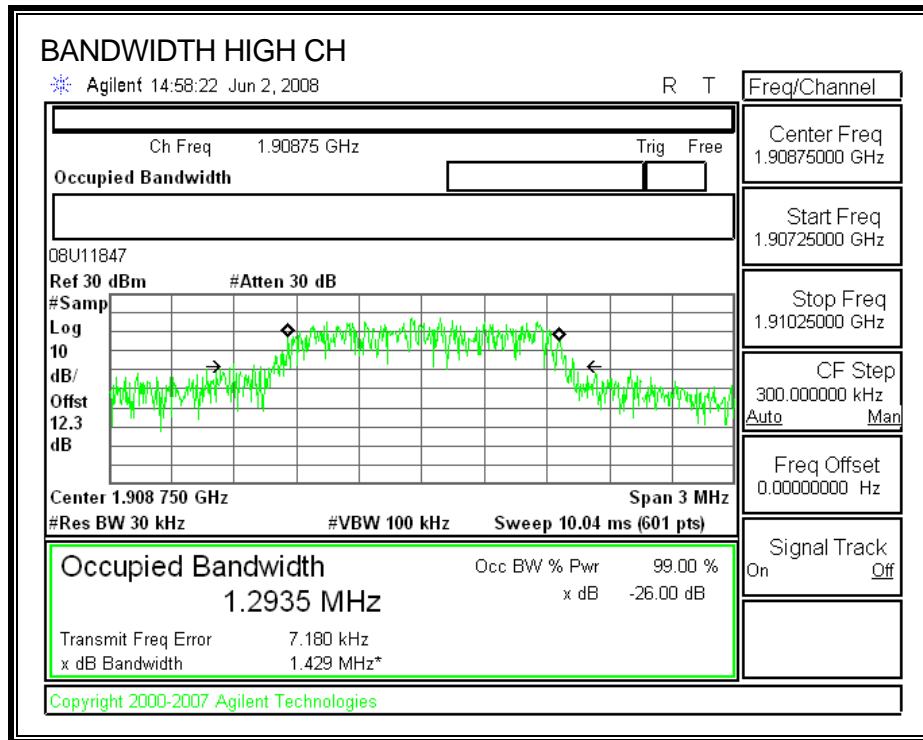

7.2. RF POWER OUTPUT

LIMIT

22.913(a) The ERP of mobile transmitters and auxiliary test transmitters must not exceed 7 Watts.

24.232(b) & RSS133 § 6.4 Mobile/portable stations are limited to 2 watts e.i.r.p. peak power and the equipment must employ means to limit the power to the minimum necessary for successful communications.

RSS-132 § 4.4 The maximum ERP shall be 6.3 Watts for mobile stations.

TEST PROCEDURE

RSS-132, RSS-133, & ANSI / TIA / EIA 603C Clause 2.2.17

RESULTS

No non-compliance noted.

CELL, CDMA Modulation

Channel	Frequency (MHz)	Conducted Peak Power (dBm)	Conducted Peak Power (mW)	ERP Peak Power (dBm)	ERP Peak Power (mW)
Low	824.7	29.25	841.40	29.00	794.33
Middle	836.5	29.23	837.53	29.60	912.01
High	848.3	28.64	731.14	29.70	933.25

PCS, CDMA Modulation

Channel	Frequency (MHz)	Conducted Peak Power (dBm)	Conducted Peak Power (mW)	EIRP Peak Power (dBm)	EIRP Peak Power (mW)
Low	1851.25	28.70	741.31	27.90	616.60
Middle	1880.00	28.91	778.04	28.30	676.08
High	1908.75	28.20	660.69	27.60	575.44

NOTE: RBW=VBW=3MHz

CELL, CDMA RF CONDUCTED OUTPUT POWER

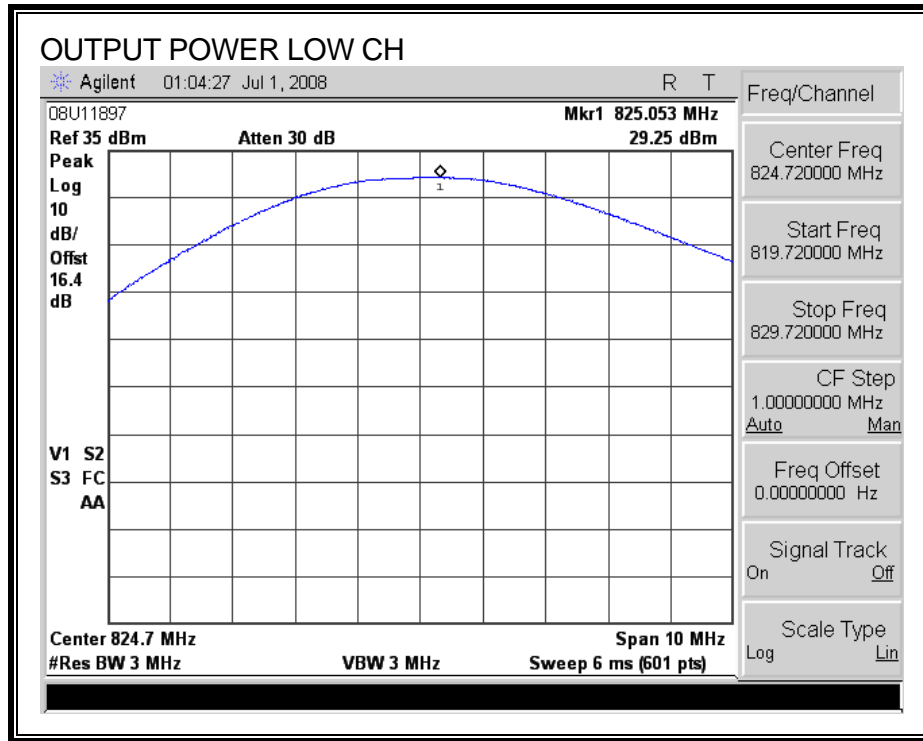

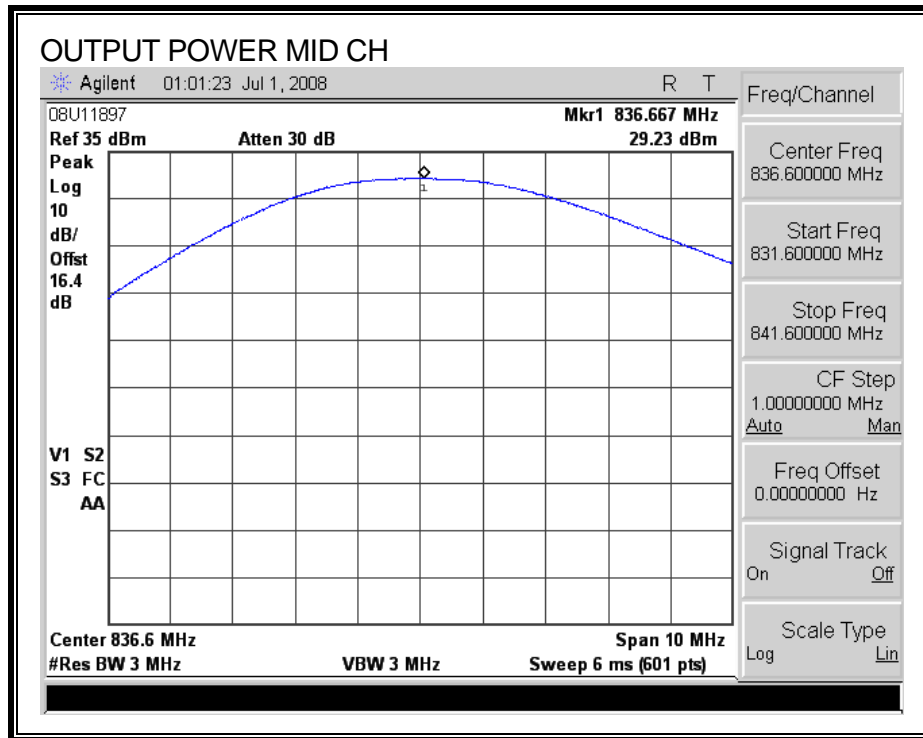

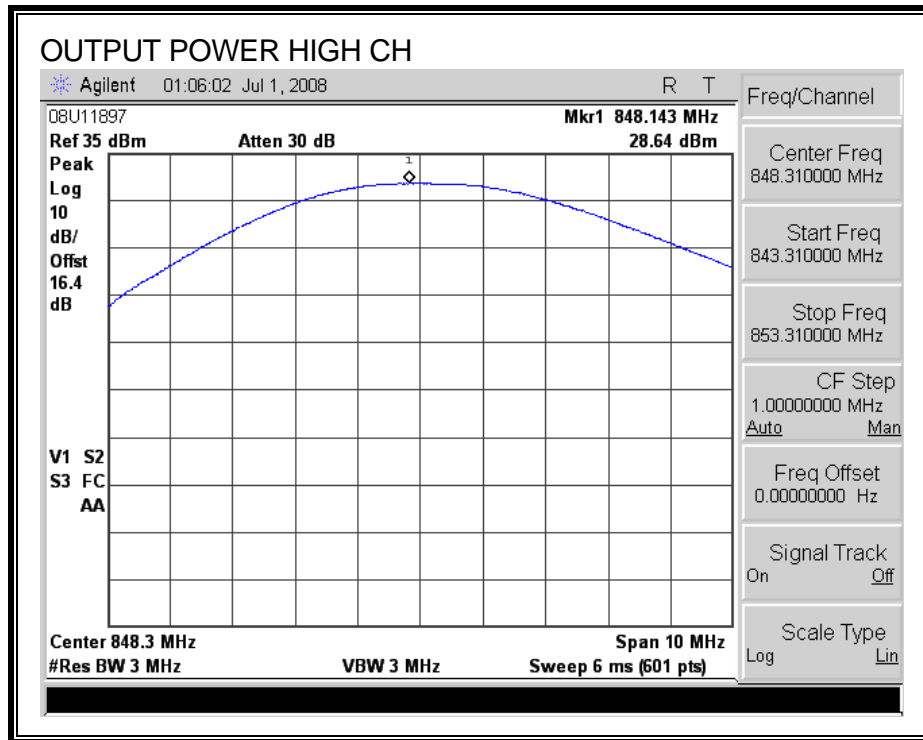

PCS, CDMA RF CONDUCTED OUTPUT POWER

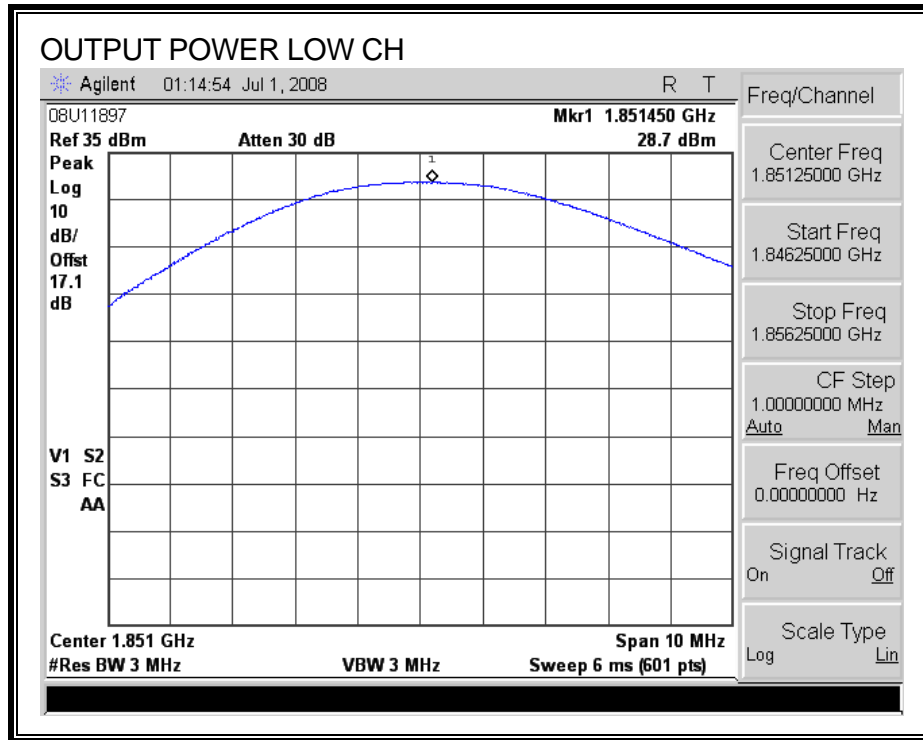

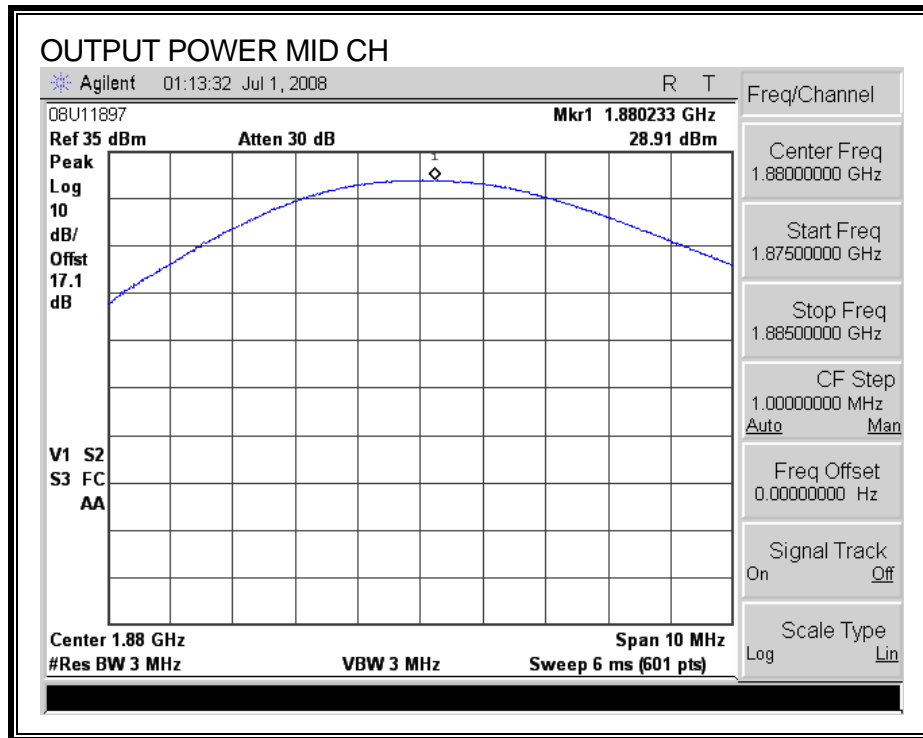

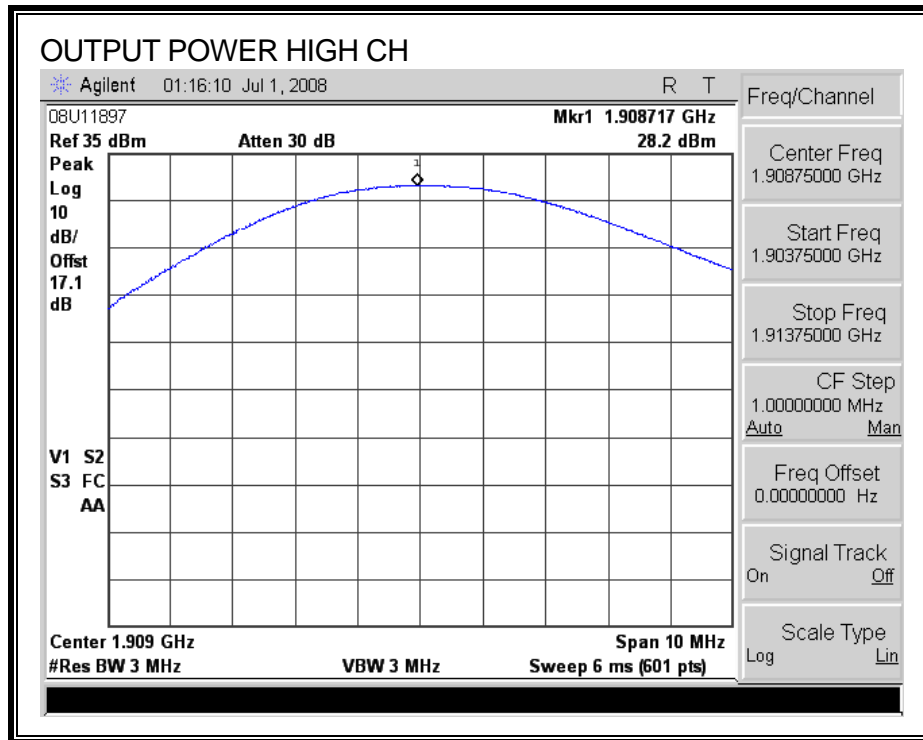

CELL, CDMA OUTPUT POWER (ERP)

High Frequency Substitution Measurement									
Compliance Certification Services, Fremont 5m Chamber A									
Company:		SIERRA WIRELESS INC.							
Project #:		08U11847							
Date:		6/4/2008							
Test Engineer:		MENGISTU MEKURIA							
Configuration:		EUT WITH SUPPORT TEST FIXTURE							
Mode:		CELL, CDMA MODULATION TX MODE							
Test Equipment:									
Receiving: Sunol T130, and 5m Chamber N-type Cable (Setup this one for testing EUT)									
Substitution: Dipole S/N: 00022117, and 4ft SMA Cable Warehouse S/N: 177081003.									
f MHz	SA reading (dBuV/m)	Ant. Pol. (H/V)	SG reading (dBm)	CL (dB)	Gain (dBd)	ERP (dBm)	Limit (dBm)	Margin (dB)	Notes
824.70	96.3	V	22.8	0.5	0.0	22.3	38.5	-16.2	
824.70	105.5	H	29.5	0.5	0.0	29.0	38.5	-9.4	
836.52	96.3	V	23.2	0.6	0.0	22.6	38.5	-15.8	
836.52	105.7	H	30.2	0.6	0.0	29.6	38.5	-8.9	
848.31	96.6	V	23.4	0.7	0.0	22.7	38.5	-15.8	
848.31	106.5	H	30.4	0.7	0.0	29.7	38.5	-8.8	
Rev. 1.247									

PCS, CDMA OUTPUT POWER (EIRP)

High Frequency Fundamental Measurement Compliance Certification Services, Fremont 5m Chamber A									
Company:		SIERRA WIRELESS INC.							
Project #:		08U11847							
Date:		6/4/2008							
Test Engineer:		MENGISTU MEKURIA							
Configuration:		EUT WITH SUPPORT TEST FIXTURE							
Mode:		PCS, CDMA MODULATION TX MODE							
<u>Test Equipment:</u>									
Receiving: Horn T60, and 12ft S/N: 197209005 (Setup this one for testing EUT)									
Substitution: Horn T73 Substitution, 4ft SMA Cable Warehouse S/N: 177081003									
f GHz	SA reading (dBuV/m)	Ant. Pol. (H/V)	SG reading (dBm)	CL (dB)	Gain (dBi)	EIRP (dBm)	Limit (dBm)	Margin (dB)	Notes
1.851	93.0	V	20.4	0.7	8.3	27.9	33.0	-5.1	
1.851	89.4	H	16.2	0.7	8.3	23.7	33.0	-9.3	
1.880	93.1	V	20.7	0.7	8.3	28.3	33.0	-4.7	
1.880	88.6	H	15.6	0.7	8.3	23.2	33.0	-9.8	
1.909	92.3	V	20.0	0.7	8.4	27.6	33.0	-5.4	
1.909	86.6	H	13.7	0.7	8.4	21.3	33.0	-11.7	
Rev. 1.24.7									

7.3. SPURIOUS EMISSION AT ANTENNA TERMINAL

LIMIT

§22.917 (e) and §24.238 (a), RSS-132 § 4.5.1, & RSS-133 § 6.5.1 (a) (i) & (b): The power of any emission outside of the authorized operating frequency ranges must be attenuated below the transmitting power (P) by a factor of at least $43 + 10 \log (P)$ dB.

TEST PROCEDURE

ANSI / TIA / EIA 603C Clause 2.2.12, FCC 22.917 (h), FCC 24.238 (b), RSS-132, & RSS-133

RESULTS

No non-compliance noted.

RF CONDUCTED PORT:

CELL, CDMA MODULATION:

Low Channel, Out-Of-Band Emissions

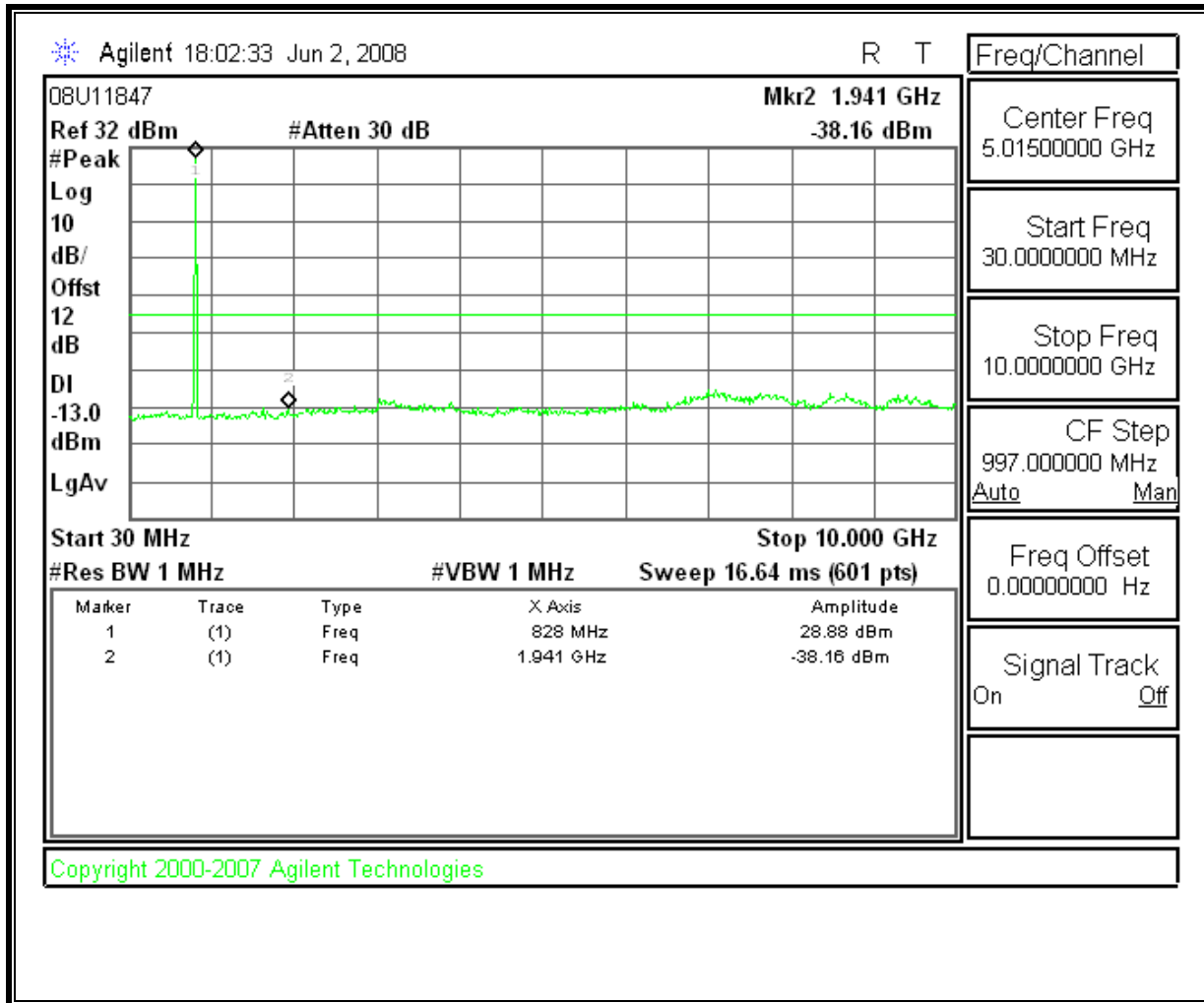

Mid Channel, Out-Of-Band Emissions

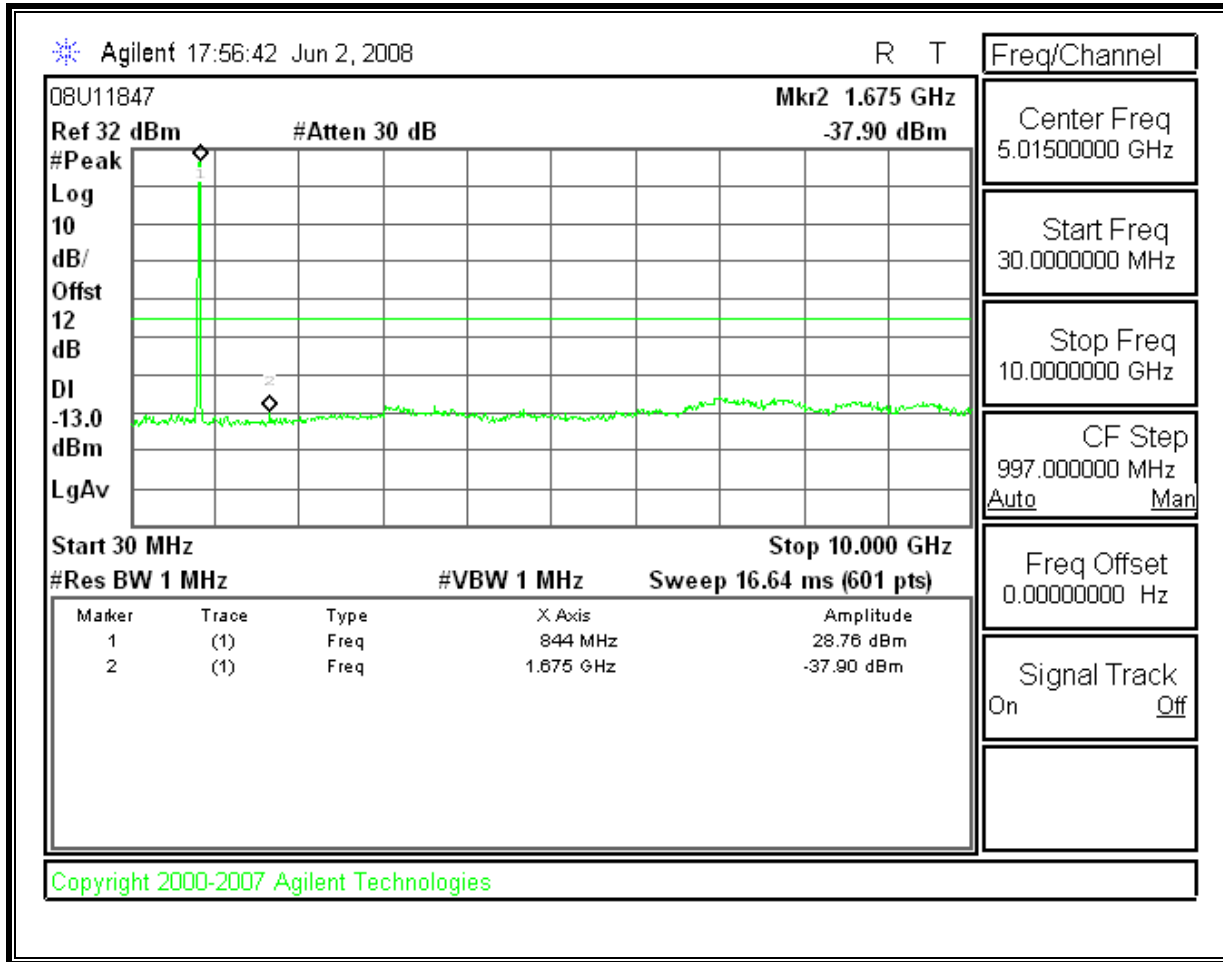

High Channel, Out-Of-Band Emissions

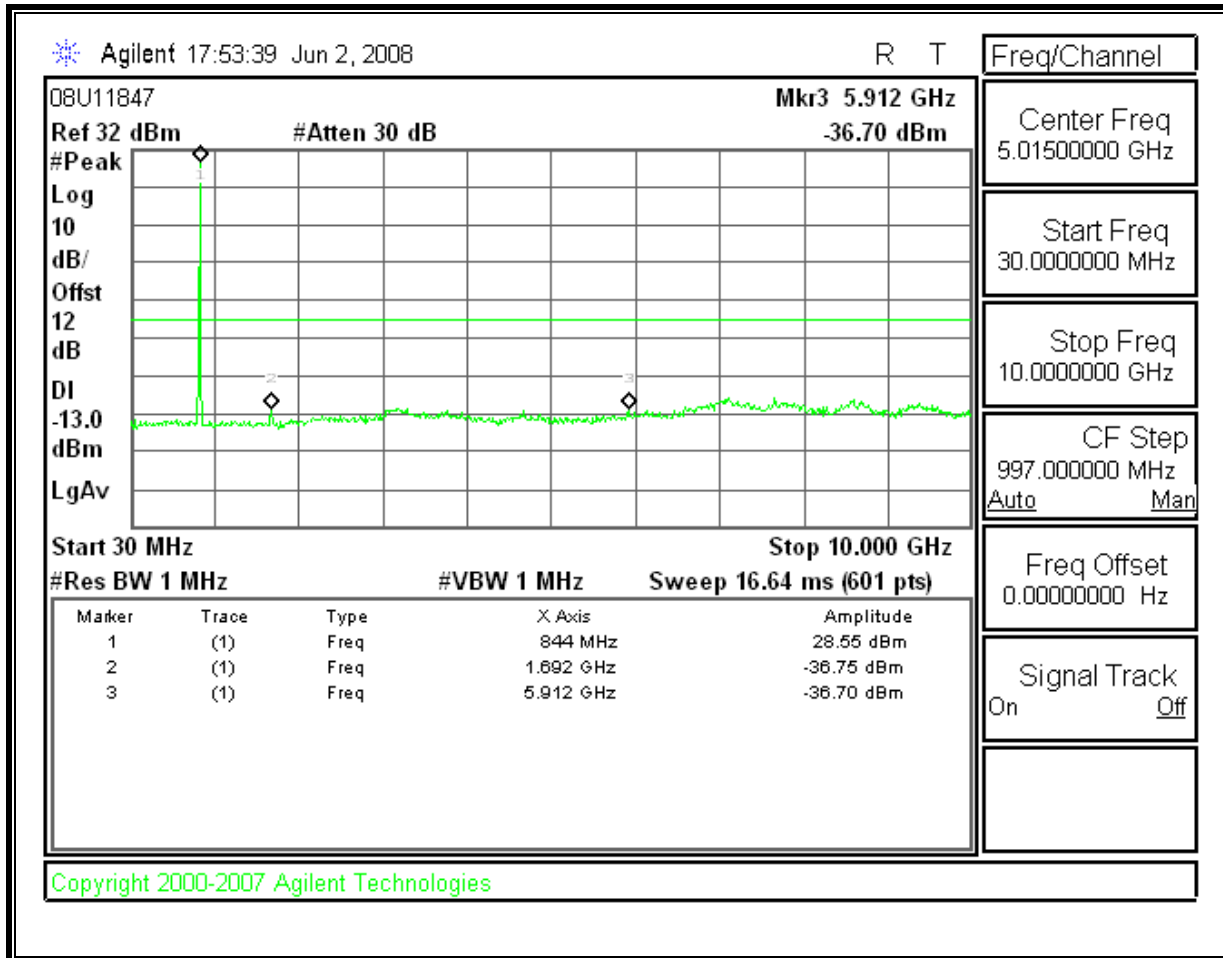

Low Channel Band Edge

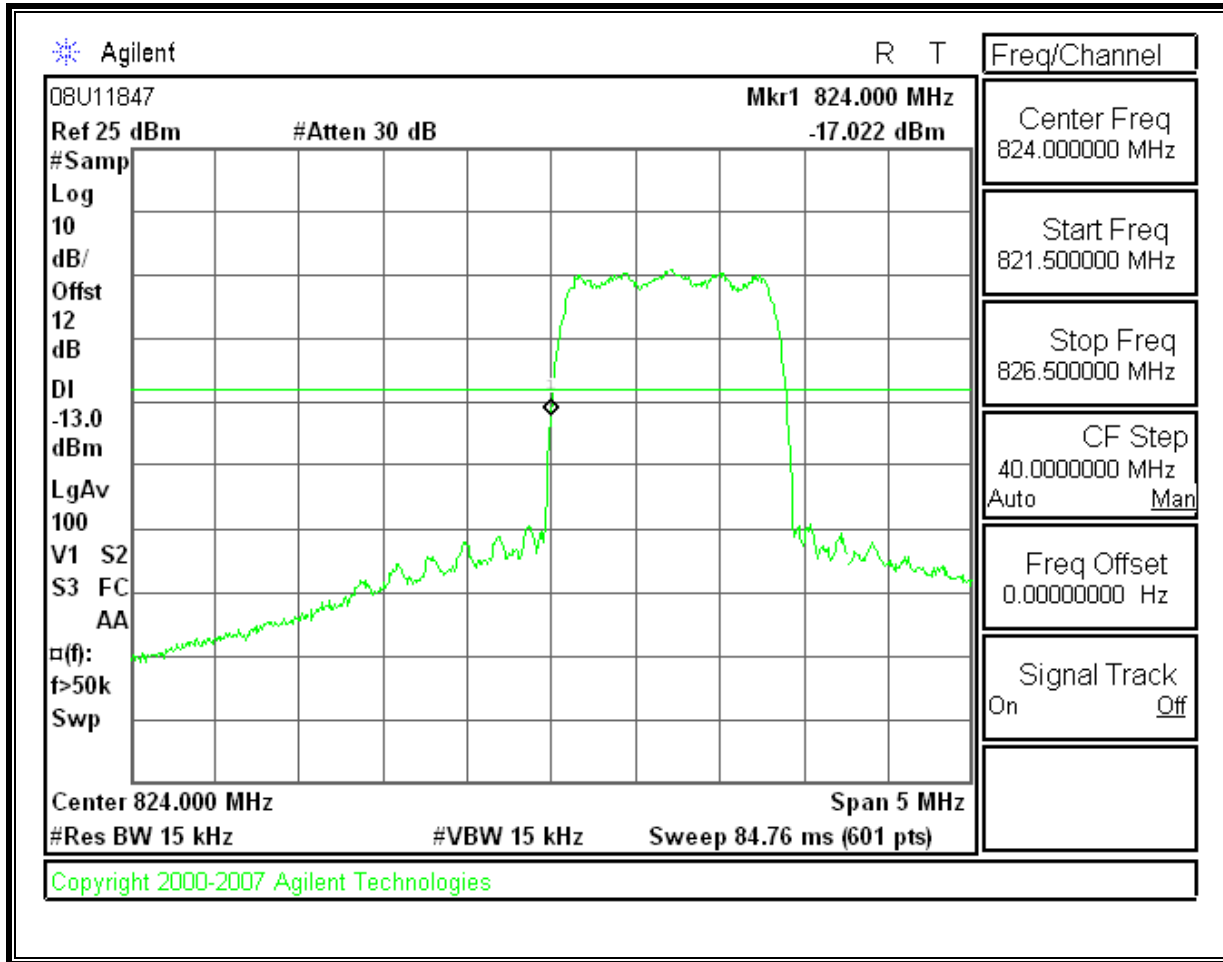

High Channel Band Edge

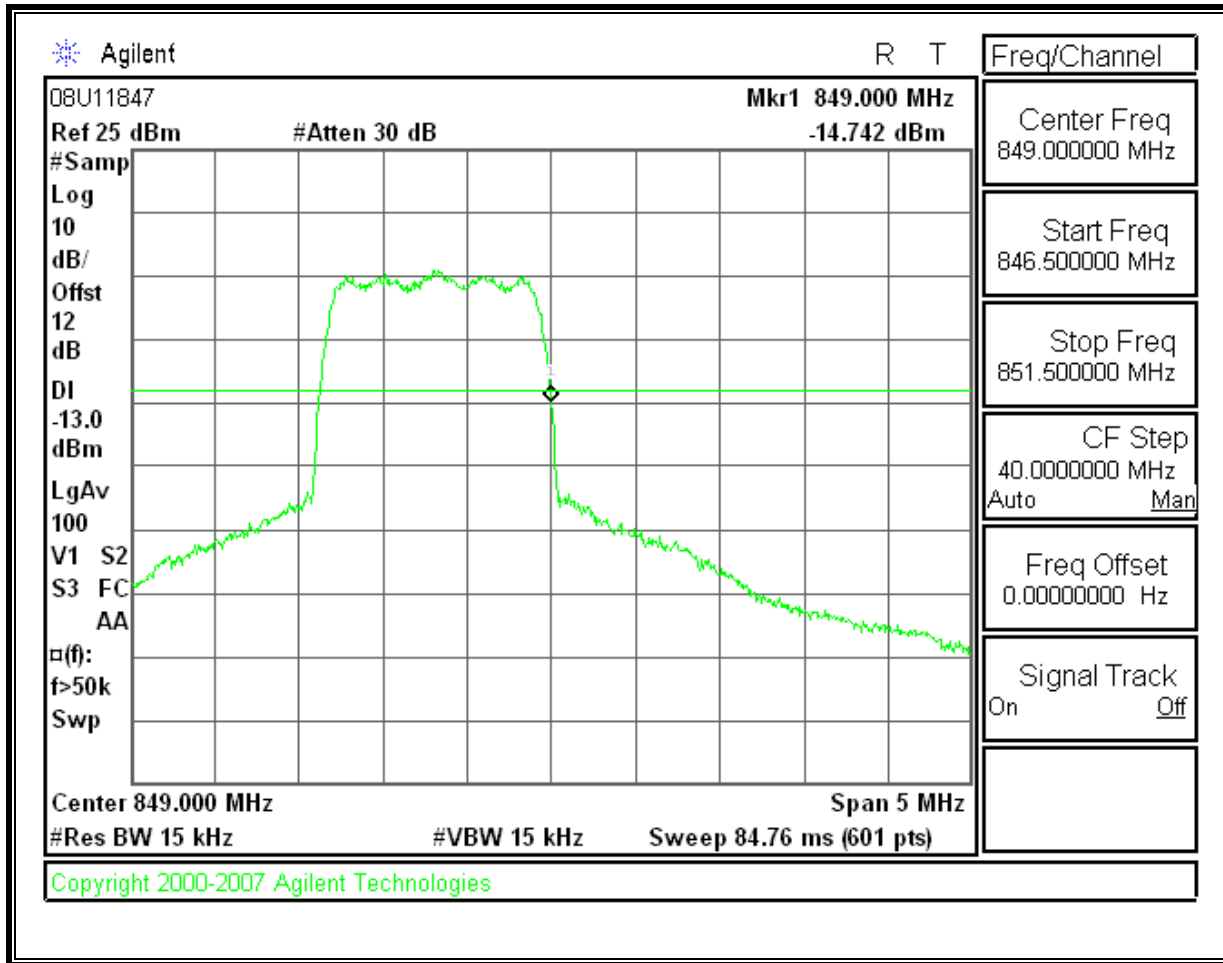

Mobile Emissions in Base Frequency Range

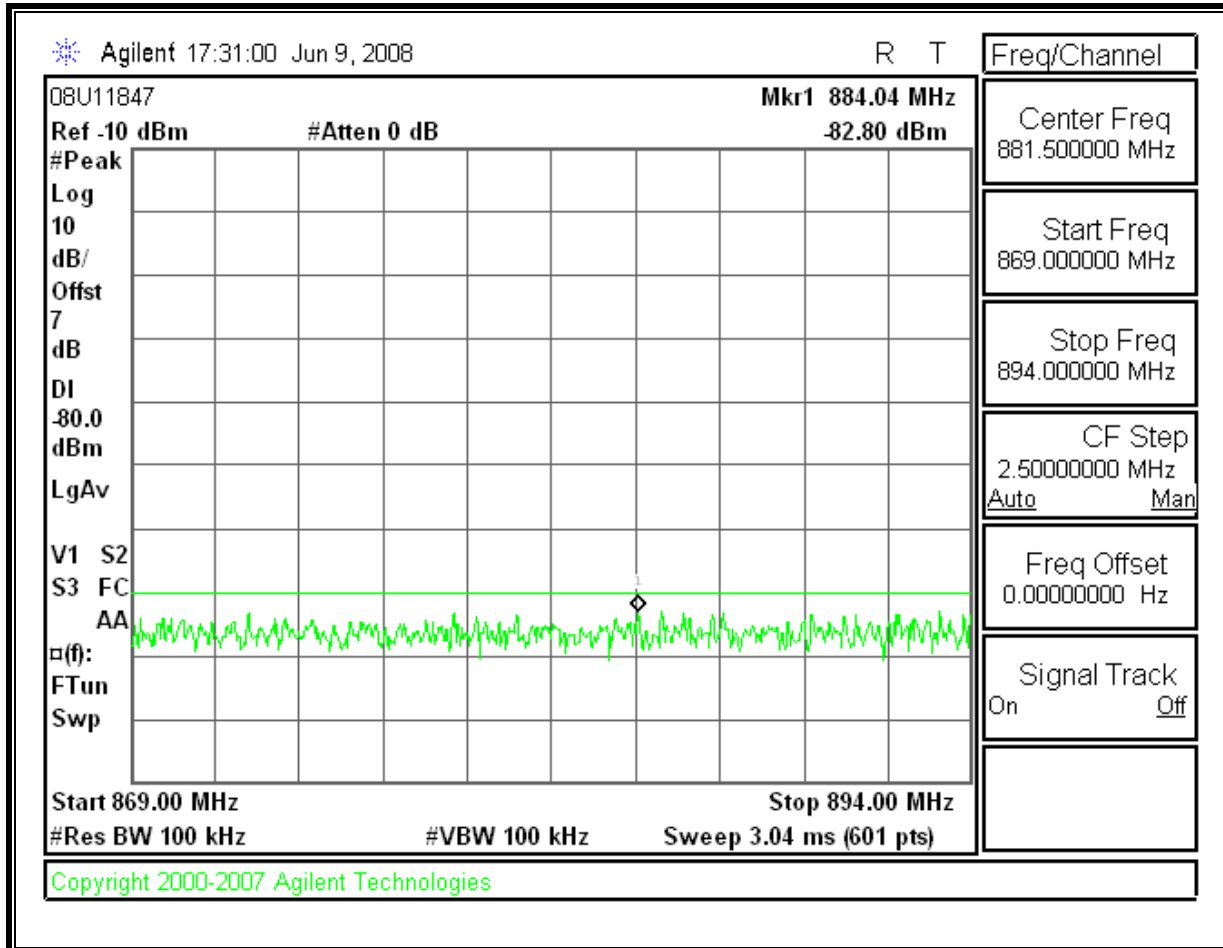

PCS, CDMA MODULATION::

Low Channel, Out-Of-Band Emissions

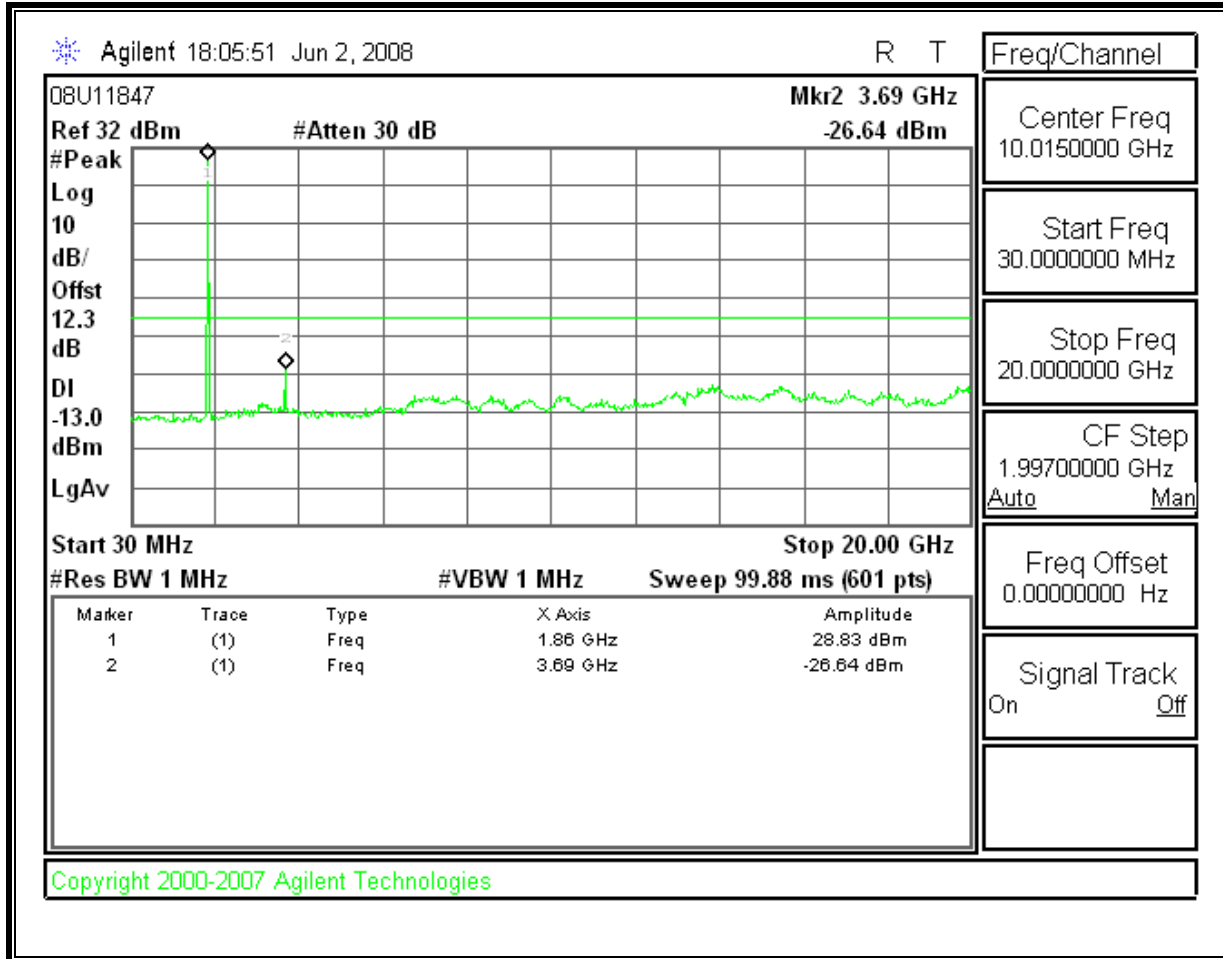

Mid Channel, Out-Of-Band Emissions

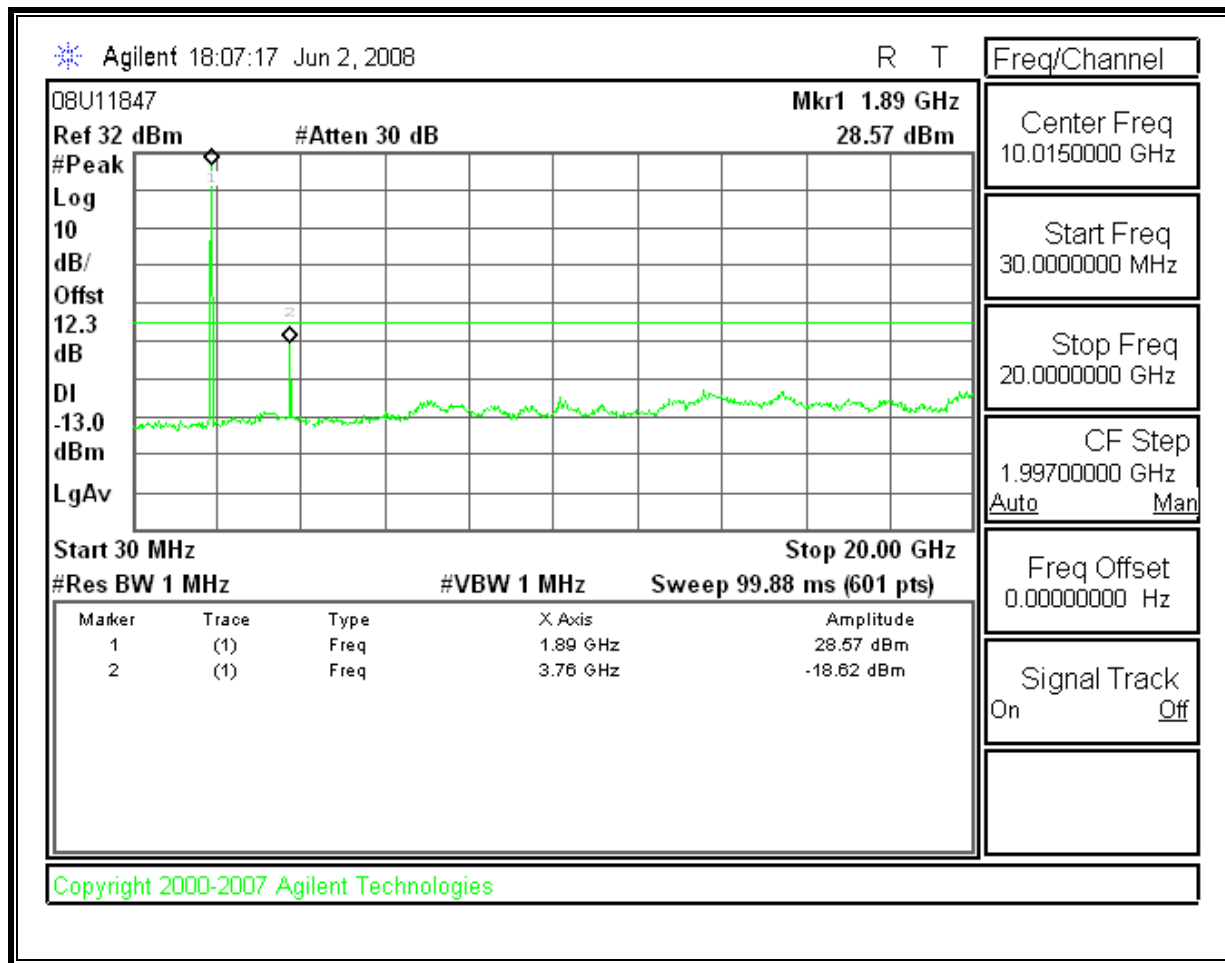

High Channel, Out-Of-Band Emissions

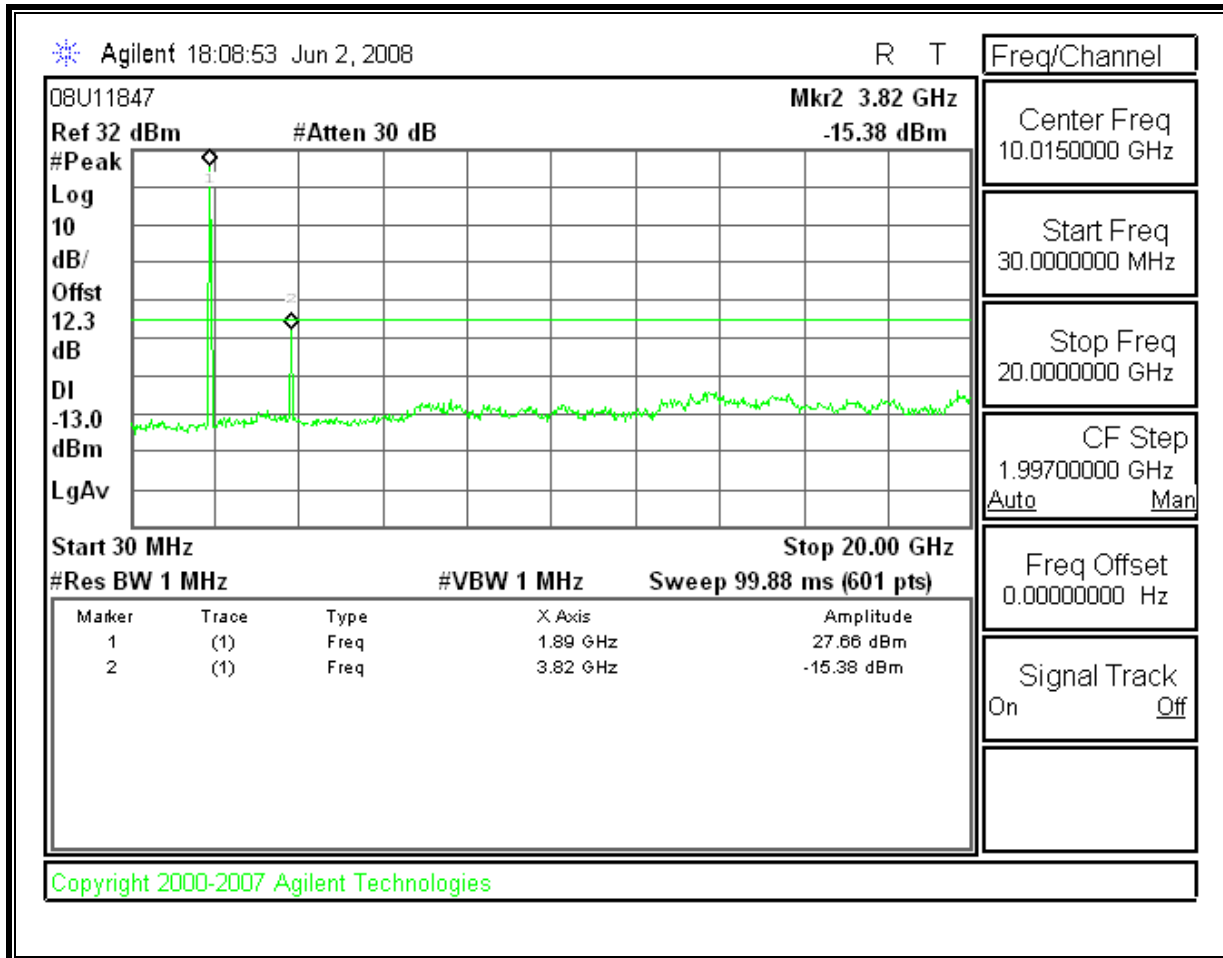

Low Channel Band Edge

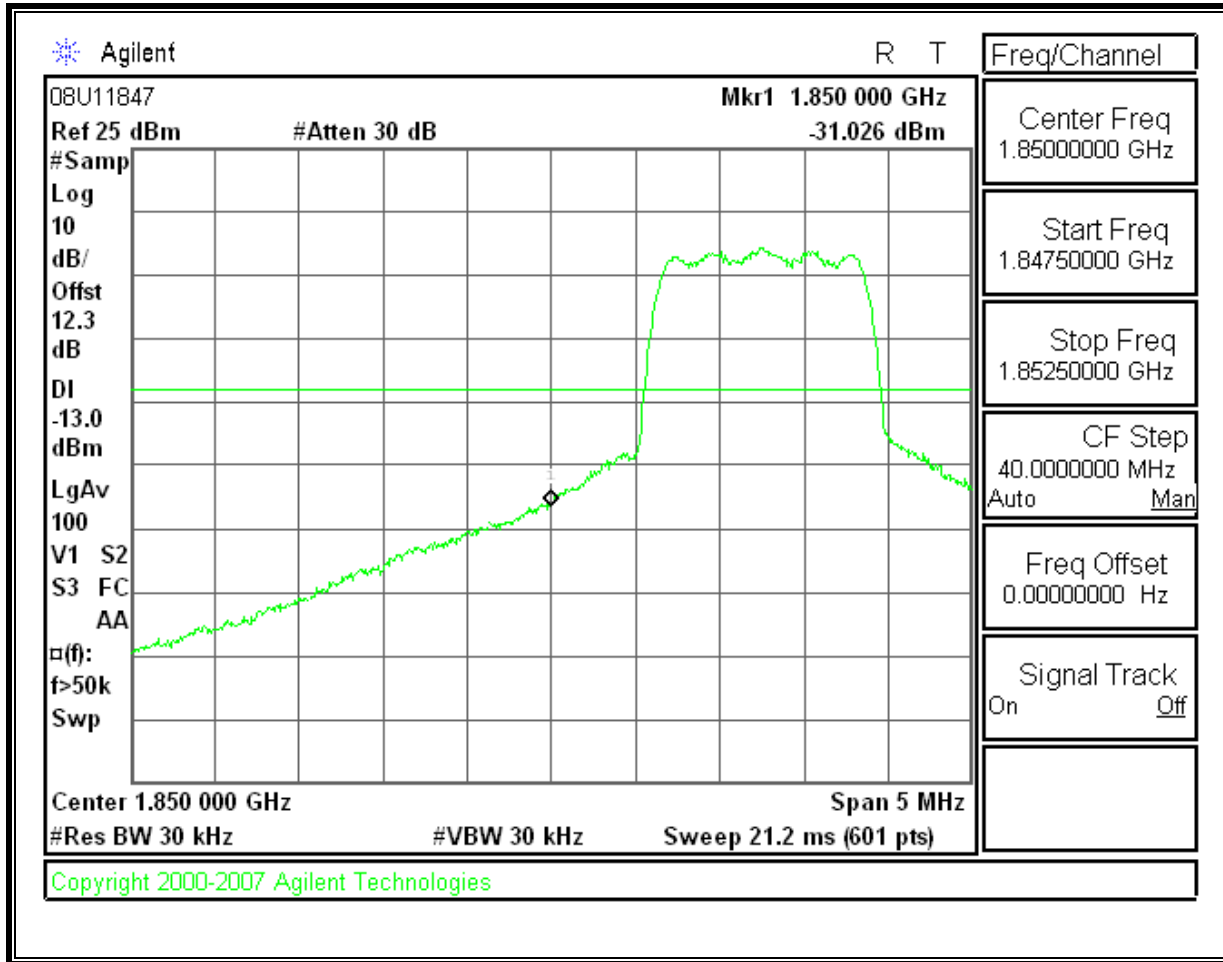

High Channel Band Edge

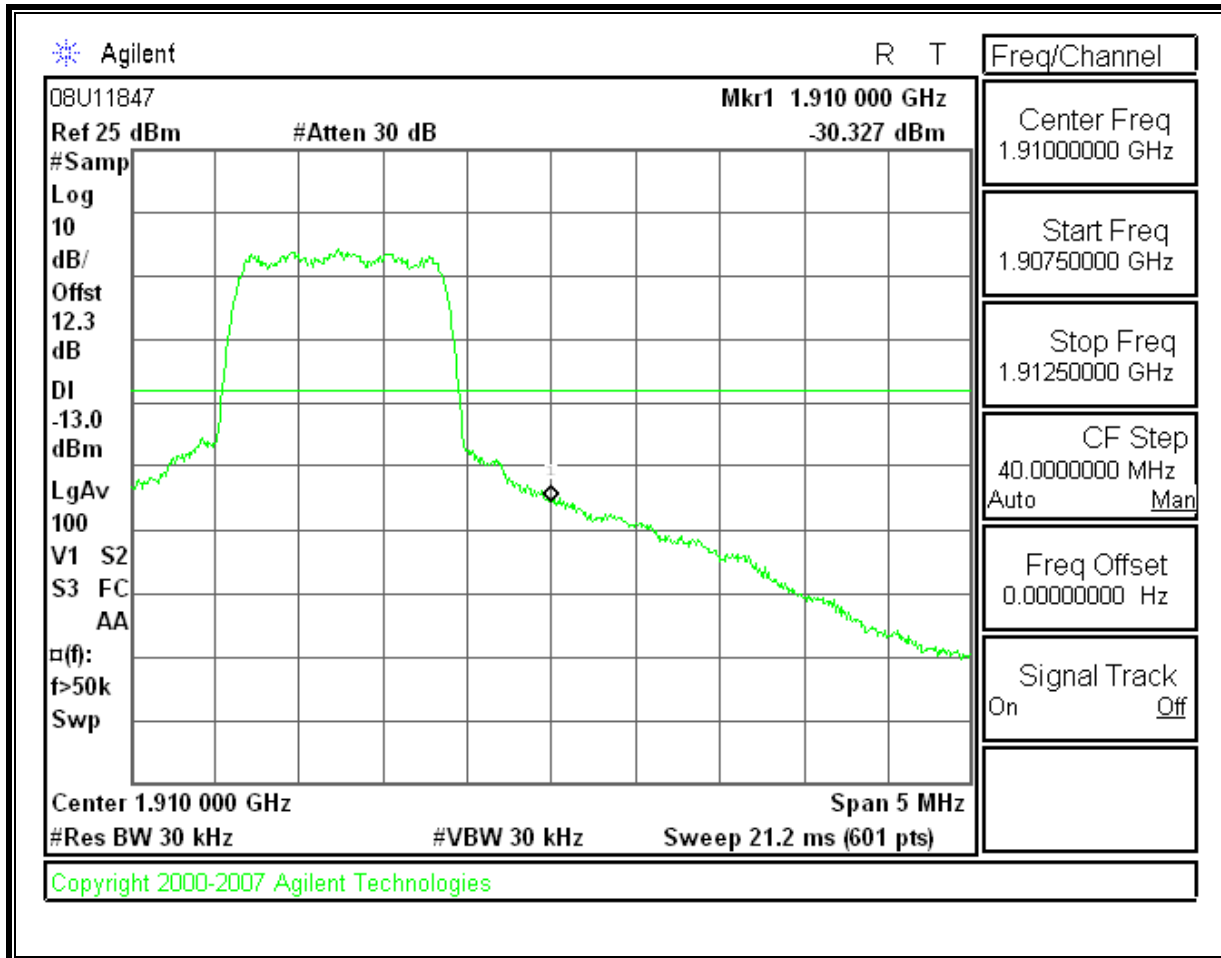

FIELD STRENGTH OF SPURIOUS RADIATION:

CELL, CDMA MODULATION SPURIOUS & HARMONIC (ERP)

High Frequency Substitution Measurement
 Compliance Certification Services, Fremont 5m A-Chamber

Company: SIERRA WIRELESS INC.
Project #: 08U11847
Date: 6/4/2008
Test Engineer: MENGISTU MEKURIA
Configuration: EUT WITH SUPPORT TEST FIXTURE
Mode: CELL, CDMA MODULATION TX MODE

Test Equipment:

EMCO Horn 1-18GHz
T60; S/N: 2238 @3m

Horn > 18GHz

Limit
FCC 22

High Pass Filter

Hi Frequency Cables

(2 ft)
 (2 ~ 3 ft)
 (4 ~ 6 ft)
 (12 ft)

Pre-amplifier 1-26GHz
T144 Miteq 3008A0

Pre-amplifier 26-40GHz

f GHz	SA reading (dBuV/m)	Ant. Pol. (H/V)	SG reading (dBm)	CL (dB)	Gain (dBi)	Gain (dBd)	ERP (dBm)	Limit (dBm)	Margin (dB)	Notes
LOW CH										
1.649	57.4	V	-49.7	3.8	7.1	4.9	-48.6	-13.0	-35.6	
2.474	46.7	V	-57.6	4.9	9.3	7.1	-55.3	-13.0	-42.3	
1.649	57.0	H	-49.4	3.8	7.1	4.9	-48.3	-13.0	-35.3	
2.474	46.3	H	-57.7	4.9	9.3	7.1	-55.5	-13.0	-42.5	
MID										
1.673	58.0	V	-49.0	3.9	7.2	5.0	-47.8	-13.0	-34.8	
2.510	48.8	V	-55.2	4.9	9.3	7.1	-53.0	-13.0	-40.0	
1.673	58.6	H	-47.7	3.9	7.2	5.0	-46.6	-13.0	-33.6	
2.510	47.0	H	-56.9	4.9	9.3	7.1	-54.7	-13.0	-41.7	
HI CH										
1.697	55.2	V	-51.7	3.9	7.2	5.1	-50.5	-13.0	-37.5	
2.545	48.0	V	-55.9	4.9	9.3	7.1	-53.7	-13.0	-40.7	
1.697	56.6	H	-49.7	3.9	7.2	5.1	-48.5	-13.0	-35.5	
2.545	47.0	H	-56.7	4.9	9.3	7.1	-54.6	-13.0	-41.6	

Rev. 4.12.7

PCS CDMA MODULATION SPURIOUS & HARMONIC (EIRP)

High Frequency Substitution Measurement
 Compliance Certification Services, Fremont 5m A-Chamber

Company: SIERRA WIRELESS INC.
 Project #: 08U11847
 Date: 6/4/2008
 Test Engineer: MENGISTU MEKURIA
 Configuration: EUT WITH SUPPORT TEST FIXTURE
 Mode: PCS, CDMA MODULATION TX MODE

Test Equipment:

EMC O Horn 1-18GHz

T60; S/N: 2238 @3m

Horn > 18GHz

Limit

FCC 24

High Pass Filter

Hi Frequency Cables

(2 ft) (2~3 ft) (4~6 ft) (12 ft)

Pre-amplifier 1-26GHz

T144 Miteq 3008A01

Pre-amplifier 26-40GHz

f GHz	SA reading (dBuV/m)	Ant. Pol. (H/V)	SG reading (dBm)	CL (dB)	Gain (dBi)	Gain (dBd)	EIRP (dBm)	Limit (dBm)	Margin (dB)	Notes
LOW CH										
3.703	54.7	V	-44.2	5.9	9.7	7.5	-40.5	-13.0	-27.5	
7.405	52.1	V	-38.6	8.3	12.0	9.8	-34.9	-13.0	-21.9	
9.256	55.0	V	-34.8	9.3	12.7	10.6	-31.3	-13.0	-18.3	
3.703	50.5	H	-48.3	5.9	9.7	7.5	-44.5	-13.0	-31.5	
7.405	44.9	H	-45.1	8.3	12.0	9.8	-41.3	-13.0	-28.3	
9.256	50.2	H	-39.5	9.3	12.7	10.6	-36.1	-13.0	-23.1	
MID										
3.760	60.0	V	-38.7	6.0	9.7	7.5	-35.0	-13.0	-22.0	
7.520	54.6	V	-35.9	8.3	12.0	9.8	-32.2	-13.0	-19.2	
9.400	53.7	V	-35.7	9.4	12.7	10.6	-32.4	-13.0	-19.4	
3.760	55.6	H	-43.0	6.0	9.7	7.5	-39.3	-13.0	-26.3	
7.520	50.1	H	-39.6	8.3	12.0	9.8	-35.9	-13.0	-22.9	
9.400	49.5	H	-39.9	9.4	12.7	10.6	-36.6	-13.0	-23.6	
HI CH										
3.818	62.7	V	-35.8	6.0	9.7	7.6	-32.1	-13.0	-19.1	
7.635	57.4	V	-32.8	8.4	12.0	9.8	-29.2	-13.0	-16.2	
9.544	47.8	V	-41.3	9.6	12.7	10.6	-38.1	-13.0	-25.1	
3.818	57.9	H	-40.4	6.0	9.7	7.6	-36.7	-13.0	-23.7	
7.635	51.9	H	-37.5	8.4	12.0	9.8	-33.9	-13.0	-20.9	
9.544	44.6	H	-44.5	9.6	12.7	10.6	-41.3	-13.0	-28.3	

Rev. 4127

7.4. FREQUENCY STABILITIES

LIMIT

The carrier frequency shall not depart from the reference frequency in excess of ± 2.5 ppm for mobile stations. The frequency stability shall be sufficient to ensure that the fundamental emission stays within the authorized frequency block.

TEST PROCEDURE

RSS-132, RSS-133, & ANSI / TIA / EIA 603C Clause 2.3.1 and 2.3.2

RESULTS

No non-compliance noted.

CELL, CDMA MODULATION – MID CHANNEL

Reference Frequency: Cellular Mid Channel 835.837000MHz @ 20°C				
Limit: to stay +- 2.5 ppm = 2089.593 Hz				
DC Power Supply (Vdc)	Environment Temperature (*C)	Frequency Deviation Measured with Time Elapse		
		(MHz)	Delta (ppm)	Limit (ppm)
3.60	50	835.837015	-0.018	2.5
3.60	40	835.837011	-0.013	2.5
3.60	30	835.837010	-0.012	2.5
3.60	20	835.837000	0	2.5
3.60	10	835.837013	-0.016	2.5
3.60	0	835.837011	-0.013	2.5
3.60	-10	835.837014	-0.017	2.5
3.60	-20	835.837014	-0.017	2.5
3.60	-30	835.837017	-0.020	2.5

Reference Frequency: Cellular Mid Channel 835.837000MHz @ 20°C				
Limit: to stay +- 2.5 ppm = 2089.593 Hz				
DC Power Supply (Vdc)	Environment Temperature (*C)	Frequency Deviation Measured with Time Elapse		
		(MHz)	Delta (ppm)	Limit (ppm)
100%	20	835.837000	0	2.5
85%	20	835.837000	0.000	2.5
115%	20	835.837006	-0.007	2.5

PCS, CDMA MODULATION – MID CHANNEL

Reference Frequency: PCS Mid Channel 1879.314000MHz @ 20°C				
Limit: within the authorized block or +- 2.5 ppm = 4698.285 Hz				
Power Supply (Vdc)	Environment Temperature (*C)	Frequency Deviation Measured with Time Elapse		
		(MHz)	Delta (ppm)	Limit (ppm)
3.60	50	1879.314034	-0.018	2.5
3.60	40	1879.314031	-0.016	2.5
3.60	30	1879.314041	-0.022	2.5
3.60	20	1879.31400	0	2.5
3.60	10	1879.314024	-0.013	2.5
3.60	0	1879.314025	-0.013	2.5
3.60	-10	1879.314037	-0.020	2.5
3.60	-20	1879.314039	-0.021	2.5
3.60	-30	1879.314034	-0.018	2.5

Reference Frequency: PCS Mid Channel 1879.314000MHz @ 20 C				
Limit: within the authorized block or +- 2.5 ppm = 4698.285 Hz				
Power Supply (Vdc)	Environment Temperature (*C)	Frequency Deviation Measured with Time Elapse		
		(MHz)	Delta (ppm)	Limit (ppm)
100%	20	1879.314000	0	2.5
85%	20	1879.313902	0.052	2.5
115%	20	1879.314000	0.000	2.5

7.5. RECEIVER SPURIOUS EMISSIONS

LIMIT

Spurious Emission Limits for Receivers:

Spurious Frequency (MHz)	Field Strength (microvolts/m at 3 metres)
30-88	100
88-216	150
216-960	200
Above 960	500

TEST PROCEDURE

The search for spurious emissions shall be from the lowest frequency internally generated or used in the receiver (local oscillator frequency, intermediate frequency or carrier frequency), or 30 MHz, whichever is the higher, to at least 3 times the highest tunable and local oscillator frequencies.

RESULTS

No non-compliance noted:

RECEIVER SPURIOUS EMISSIONS FOR 30 TO 1000 MHz, HORIZONTAL

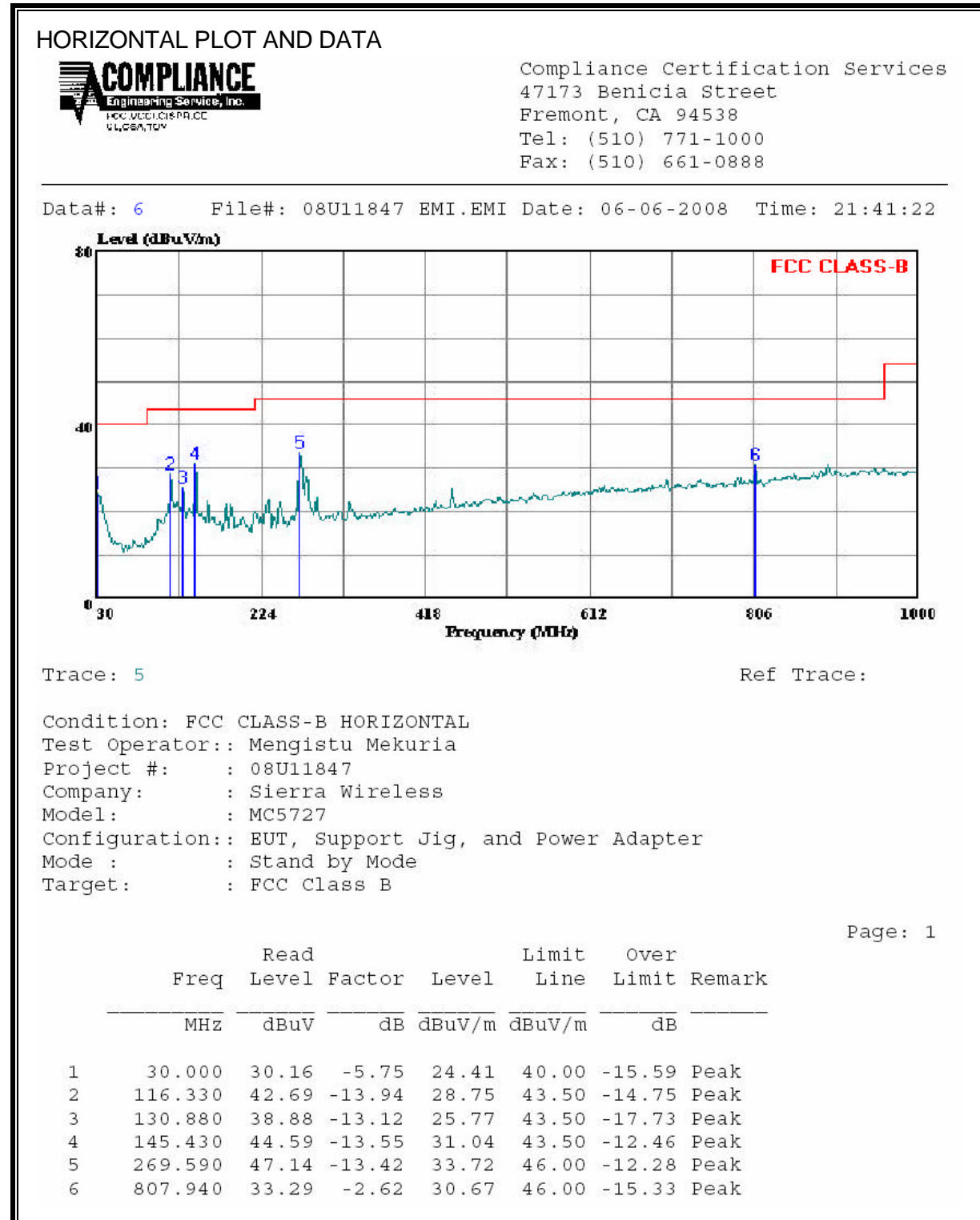

RECEIVER SPURIOUS EMISSIONS FOR 30 TO 1000 MHz, VERTICAL

VERTICAL PLOT AND DATA



Compliance Certification Services
 47173 Benicia Street
 Fremont, CA 94538
 Tel: (510) 771-1000
 Fax: (510) 661-0888

Data#: 4 File#: 08U11847 EMI.EMI Date: 06-06-2008 Time: 21:33:27

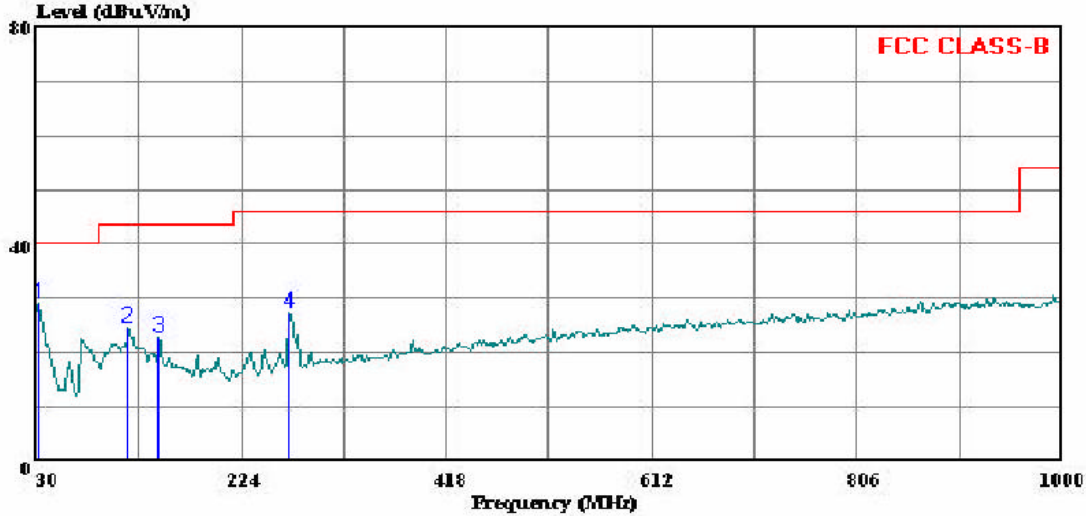

Trace: 3

Ref Trace:

Condition: FCC CLASS-B VERTICAL
 Test Operator:: Mengistu Mekuria
 Project #: : 08U11847
 Company: : Sierra Wireless
 Model: : MC5727
 Configuration: : EUT, Support Jig, and Power Adapter
 Mode : : Stand by Mode
 Target: : FCC Class B

Page: 1

	Read	Limit	Over				
Freq	Level	Factor	Level	Line	Limit	Remark	
MHz	dBuV	dB	dBuV/m	dBuV/m	dB		
1	31.940	35.74	-6.58	29.16	40.00	-10.84	Peak
2	116.330	38.49	-13.94	24.55	43.50	-18.95	Peak
3	145.430	36.47	-13.55	22.92	43.50	-20.58	Peak
4	269.590	40.84	-13.42	27.42	46.00	-18.58	Peak

RECEIVER SPURIOUS EMISSIONS FOR ABOVE 1GHz

Note: No emissions were found within above 1GHz of 20dB below the system noise floor.

7.6. POWER LINE CONDUCTED EMISSION

LIMIT

RSS-Gen 7.2.2

Except when the requirements applicable to a given device state otherwise, for any licence-exempt radio communication device equipped to operate from the public utility AC power supply, either directly or indirectly, the radio frequency voltage that is conducted back onto the AC power lines in the frequency range of 0.15 MHz to 30 MHz shall not exceed the limits shown in Table 2. The tighter limit applies at the frequency range boundaries.

Table 2 – AC Power Lines Conducted Emission Limits

Frequency of Emission (MHz)	Conducted Limit (dBuV)	
	Quasi-peak	Average
0.15-0.5	66 to 56*	56 to 46*
0.5-5	56	46
5-30	60	50

*Decreases with the logarithm of the frequency.

RESULTS

No non-compliance noted:

CONDUCTED EMISSIONS DATA (115VAC 60Hz)									
Freq.	Reading			Closs	Limit	EN B	Margin		Remark
(MHz)	PK (dBuV)	QP (dBuV)	AV (dBuV)	(dB)	QP	AV	QP (dB)	AV (dB)	L1 / L2
0.19	53.02	--	37.72	0.00	64.26	54.26	-11.24	-16.54	L1
0.23	47.84	--	33.49	0.00	62.31	52.31	-14.47	-18.82	L1
0.28	43.02	--	30.10	0.00	60.76	50.76	-17.74	-20.66	L1
0.19	52.50	--	36.35	0.00	64.26	54.26	-11.76	-17.91	L2
0.23	47.38	--	31.07	0.00	62.31	52.31	-14.93	-21.24	L2
0.28	42.35	--	27.60	0.00	60.76	50.76	-18.41	-23.16	L2
6 Worst Data									

LINE 1 RESULTS

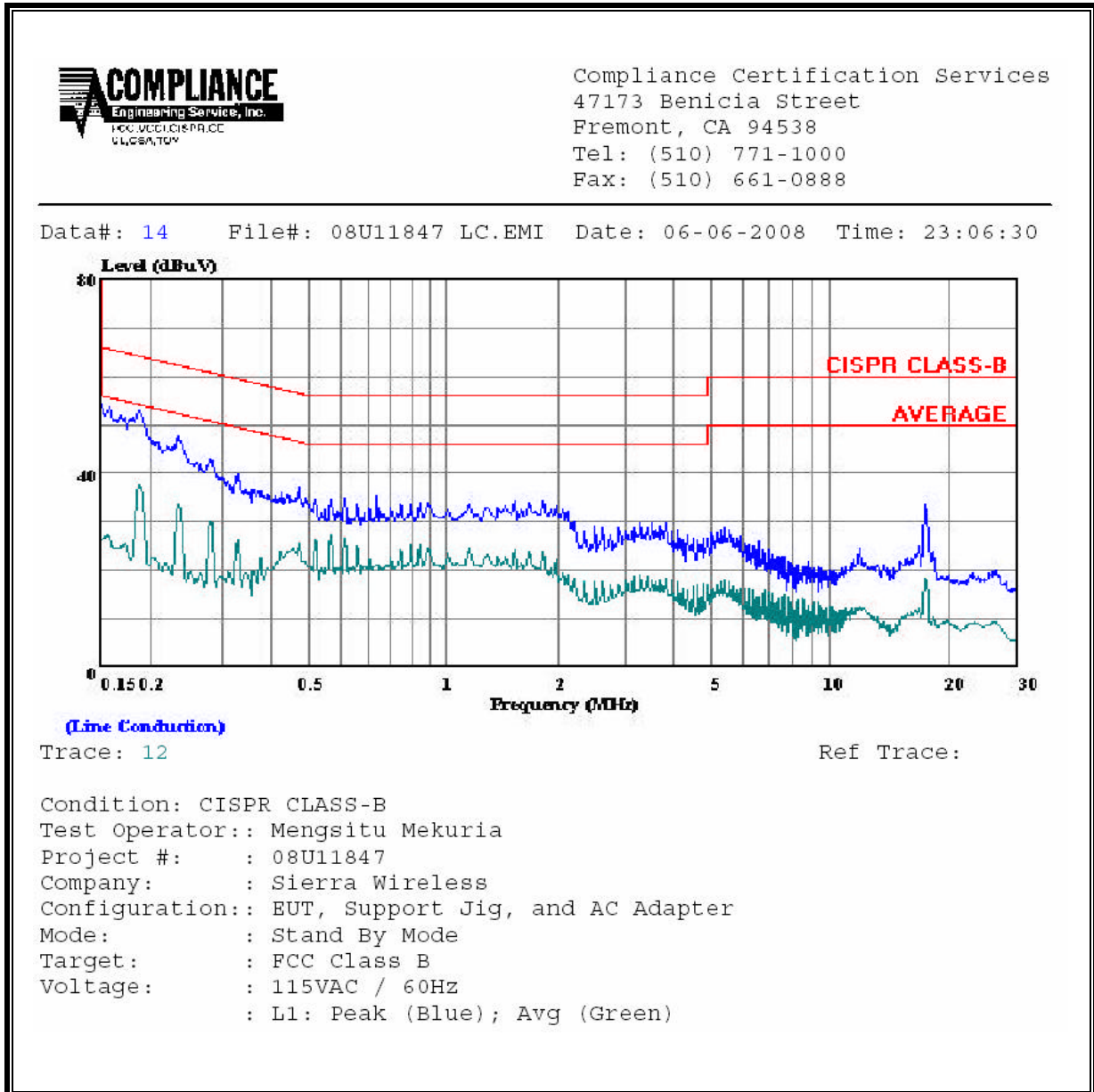

LINE 2 RESULTS

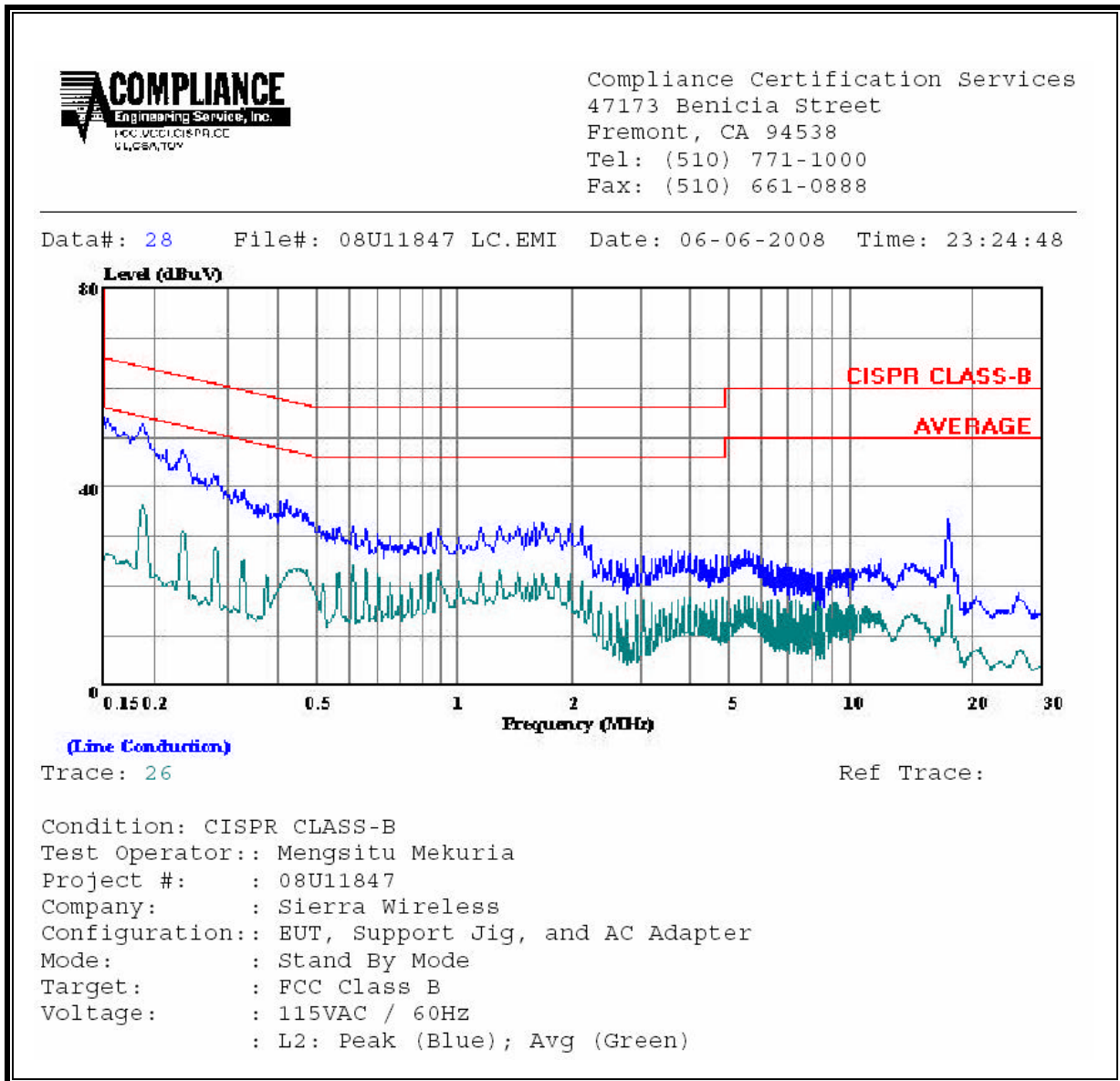

8. SETUP PHOTOS

ANTENNA PORT CONDUCTED RF MEASUREMENT SETUP

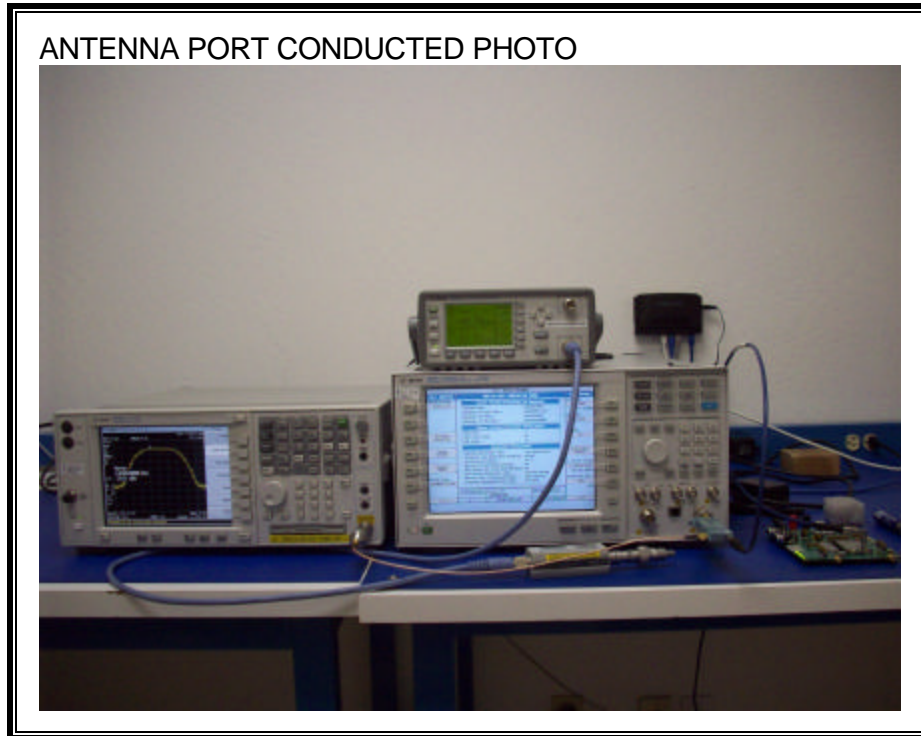

RADIATED RF MEASUREMENT SETUP

X-ANTENNA ORIENTATION

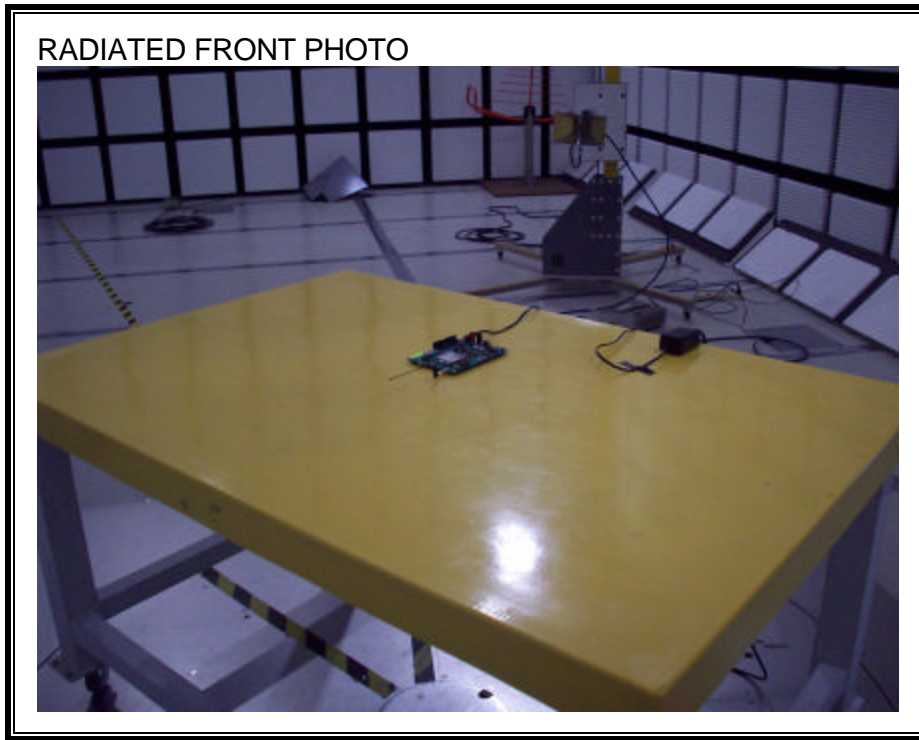

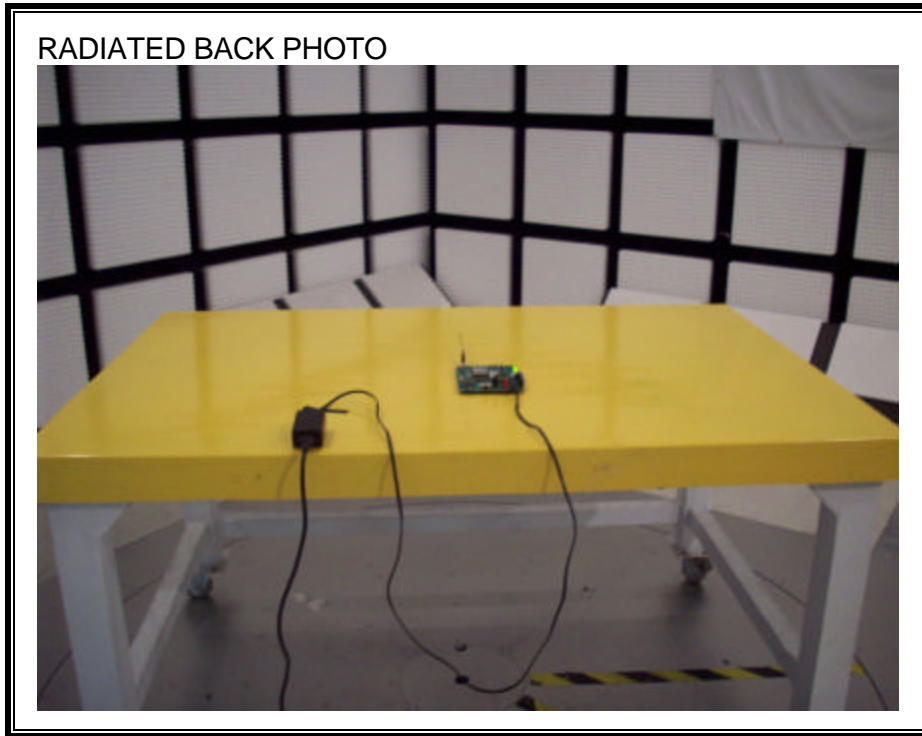

Y-ANTENNA ORIENTATION

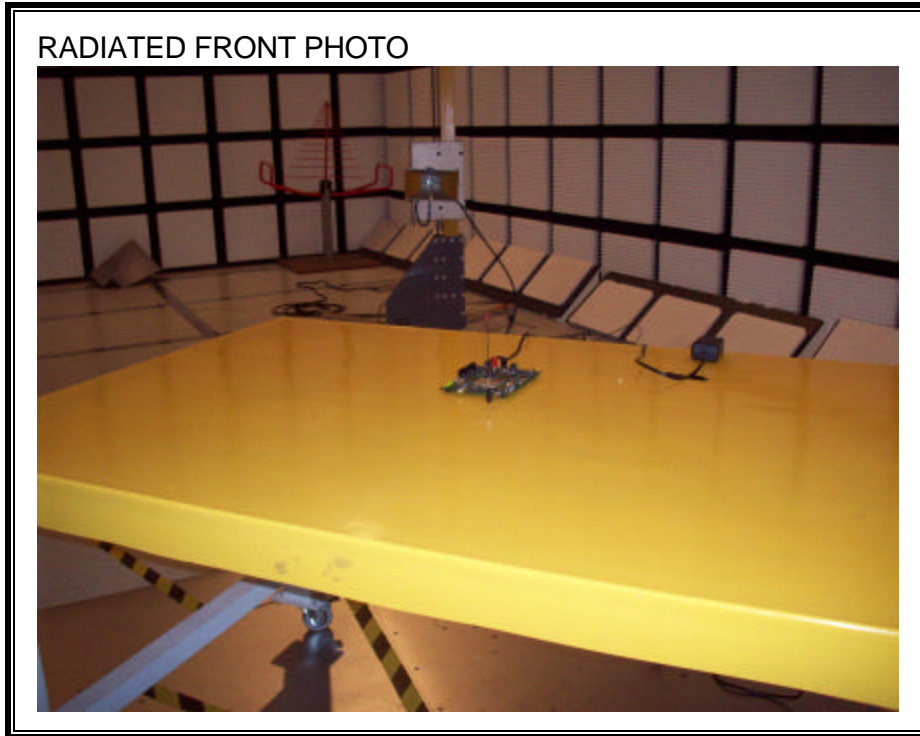

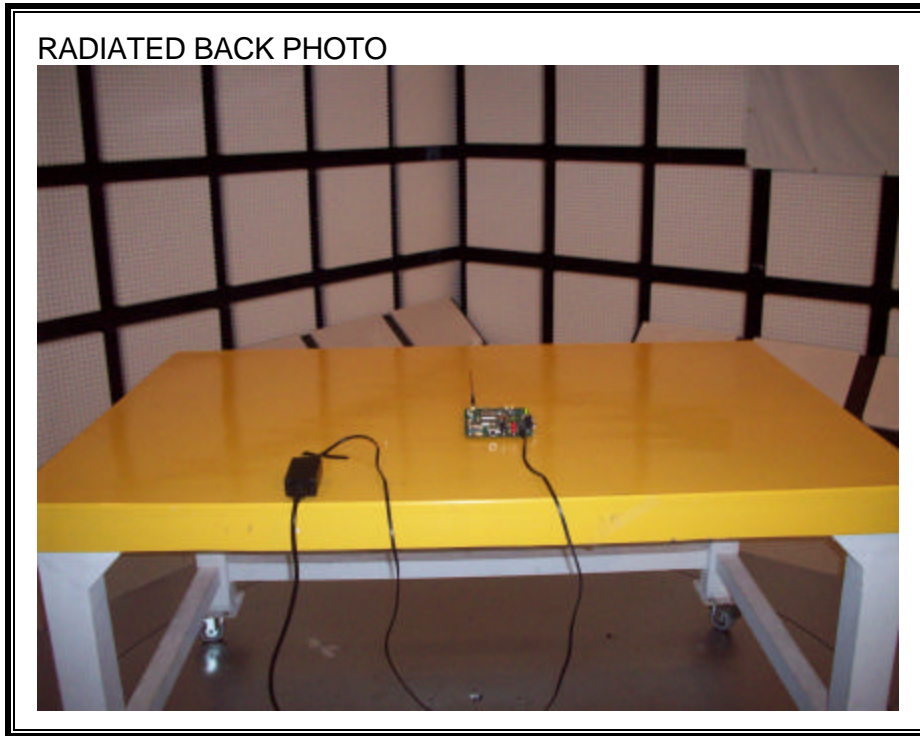



END OF REPORT