



Getting Started

HP Compaq Notebook PC

Document Part Number: [409814-001](#)

March 2006

This guide explains how to set up your hardware and software, and begin using the computer in Microsoft® Windows®.

© Copyright 2005 Hewlett-Packard Development Company, L.P.

Microsoft and Windows are U.S. registered trademarks of Microsoft Corporation. SD Logo is a trademark of its proprietor. Java is a U.S. trademark of Sun Microsystems, Inc. Bluetooth is a trademark owned by its proprietor and used by Hewlett-Packard Company under license.

The information contained herein is subject to change without notice. The only warranties for HP products and services are set forth in the express warranty statements accompanying such products and services. Nothing herein should be construed as constituting an additional warranty. HP shall not be liable for technical or editorial errors or omissions contained herein.

Getting Started
HP Compaq Notebook PC
First Edition March 2006
Document Part Number: 409814-001

Contents

1 First-time setup

Identify hardware	1-1
Computer hardware	1-1
Top components	1-2
Keys	1-4
Pointing devices	1-5
Front components	1-7
Rear components	1-9
Right-side components	1-10
Left-side components	1-11
Bottom components	1-12
Set up the computer	1-14
Step 1: Insert the battery pack	1-15
Step 2: Connect the computer to external power	1-16
Step 3: Turn on the computer	1-18
Step 4: Set up the software	1-20
Step 5: Create recovery discs	1-21

2 Next steps

Install additional hardware and software	2-1
Protect the computer	2-1
Protect the computer from viruses	2-1
Protect your system files	2-2
Protect your privacy	2-2
Protect the computer from power surges	2-3
Use the computer safely	2-3

Connect to a computer network	2-5
Update your software	2-6
Locate the user guides	2-6
Turn off the computer correctly	2-7

3 Troubleshooting

Troubleshooting resources	3-1
Quick troubleshooting	3-2
Is the computer unable to start up?	3-2
Is the computer screen blank?	3-3
Is software functioning abnormally?	3-4
Is the computer turned on, but is not responding?	3-5
Is the computer unusually warm?	3-6
Is an external device not working?	3-7
Is the home wireless network connection not working?	3-8
Help and Support Center	3-9
Customer Care	3-10
Preparing to contact Customer Care	3-10
Contacting Customer Care by e-mail or telephone	3-11

A Specifications

Operating Environment	A-1
Rated Input Power	A-2

B Backup and Recovery

Safeguarding your data	B-1
Backing up your system	B-2
Backing up specific files or folders	B-2
Backing up your entire system	B-3
Backing up modifications made to your system	B-4
Recovering your system	B-6
Creating recovery discs	B-7
Performing a recovery	B-8

C Connect to the Internet from your home

Choose an ISP	C-1
Using the New Connection Wizard.....	C-2
Choose the type of Internet access.....	C-3

Index

Contents

1

First-time setup

Identify hardware



Components included with the computer may vary by region and by model. The illustrations in this chapter identify the standard external features included in most computer models.

Computer hardware



Component	
❶	HP Smart AC Adapter
❷	Power cord
❸	Primary battery pack
❹	Modem cable

Top components



Refer to the illustration that most closely matches your computer.

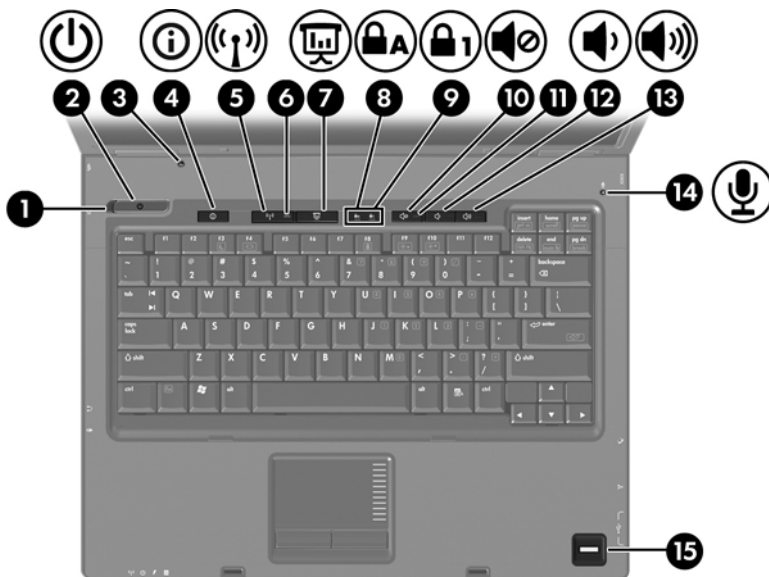

Component

❶	Power light	❹	Num lock light
❷	Power button	❺	Volume mute button
❸	Display switch	❻	Volume mute light
❹	Info Center button	❼	Volume down button
❺	Wireless button	❽	Volume up button
❻	Wireless light	❾	Internal microphone
❼	Presentation button	❿	Fingerprint reader
❽	Caps lock light		

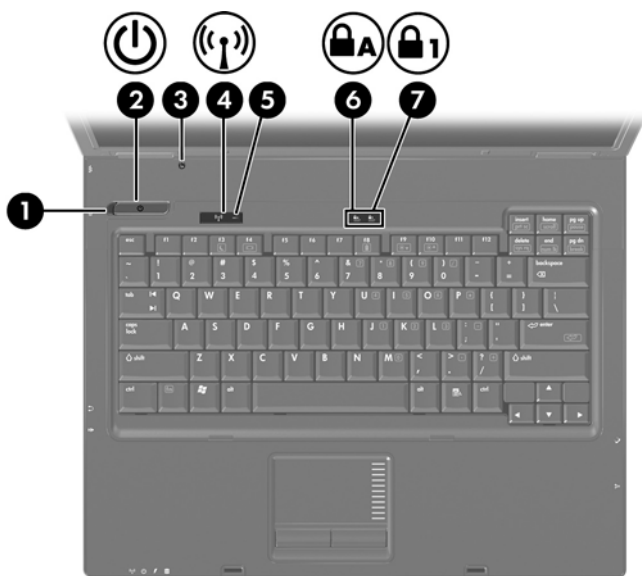

Component

❶	Power light	❺	Wireless light
❷	Power button	❻	Caps lock light
❸	Display switch	❼	Num lock light
❹	Wireless button		

Keys



Your computer may look slightly different from the illustration in this section.



Component

❶	esc key	❷	Windows applications key
❸	fn key	❸	Embedded numeric keypad keys
❹	Windows logo key	❹	Function keys

Pointing devices

TouchPad (select models only)

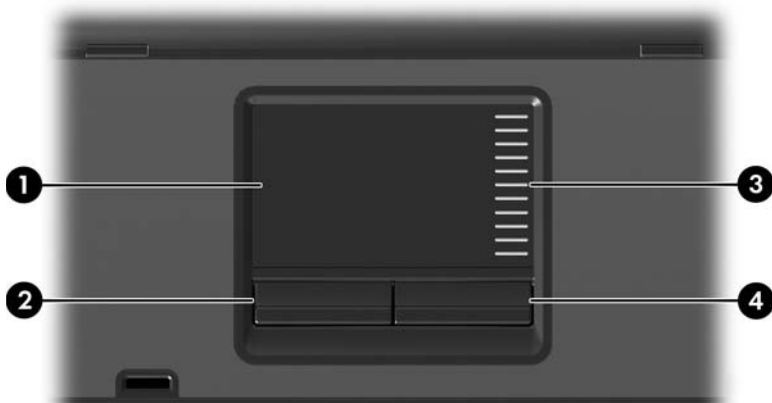

Component

❶	TouchPad	❸	TouchPad scroll zone
❷	Left TouchPad button	❹	Right TouchPad button

Pointing stick (select models only)

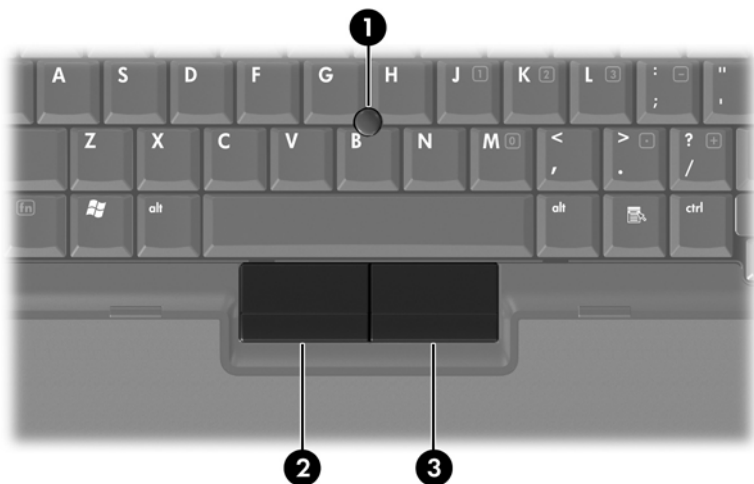

Component

- ① Pointing stick
 - ② Left pointing stick button
 - ③ Right pointing stick button
-

Front components



Refer to the illustration that most closely matches your computer.

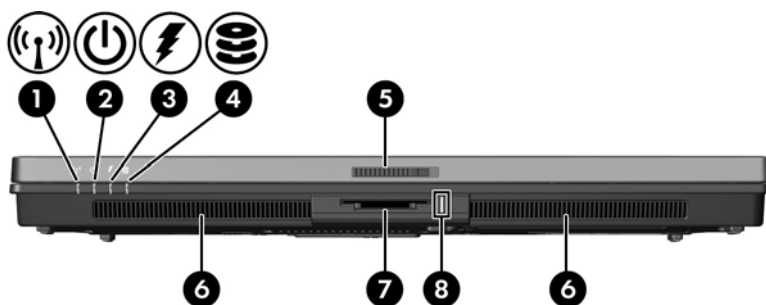

Component	
❶	Wireless light
❷	Power light
❸	Battery light
❹	IDE (Integrated Drive Electronics) drive light
❺	Display release latch
❻	Speakers (2)
❼	Digital Media Slot
❽	Digital Media Slot light

First-time setup

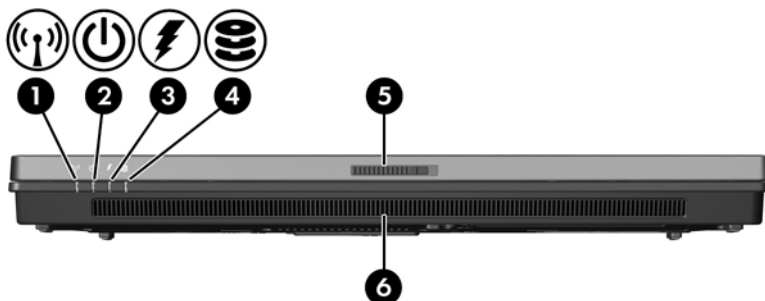

Component

❶ Wireless light	❷ IDE (Integrated Drive Electronics) drive light
❸ Power light	❹ Display release latch
❺ Battery light	❻ Speakers (2)

Rear components



Refer to the illustration that most closely matches your computer.



Component

- | | |
|-----------------------|--------------------|
| ❶ Security cable slot | ❸ Parallel port |
| ❷ Power connector | ❹ S-Video-out jack |



Component

- | |
|-----------------------|
| ❶ Security cable slot |
| ❷ Power connector |

Right-side components



Refer to the illustration that most closely matches your computer.

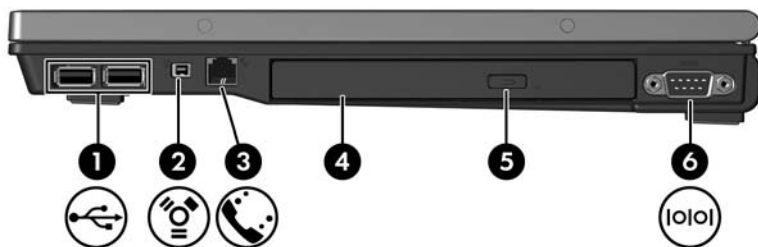

Component

❶ USB ports (2)	❷ Optical drive
❸ 1394 port	❹ Optical drive button
❺ RJ-11 (modem) jack	❻ Serial port

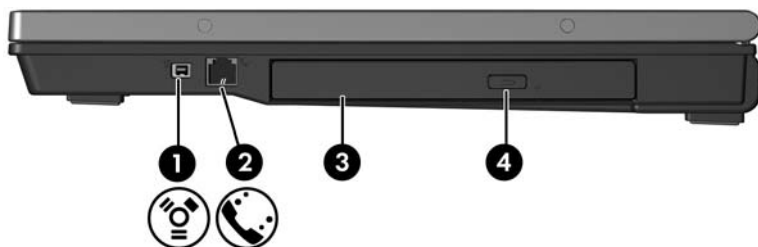

Component

❶ 1394 port	❷ Optical drive
❸ RJ-11 (modem) jack	❹ Optical drive button

Left-side components



Your computer may look slightly different from the illustration in this section.

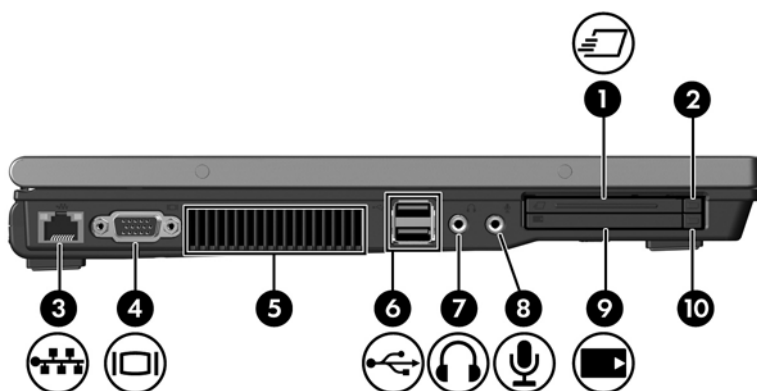

Component

❶ ExpressCard slot (select models only)	❷ USB ports (2)
❸ ExpressCard slot eject button	❹ Audio-out (headphone) jack
❹ RJ-45 (network) jack	❺ Audio-in (microphone) jack
❺ External monitor port	❻ PC Card slot
❻ Vent	❼ PC Card slot eject button

Bottom components



Refer to the illustration that most closely matches your computer.

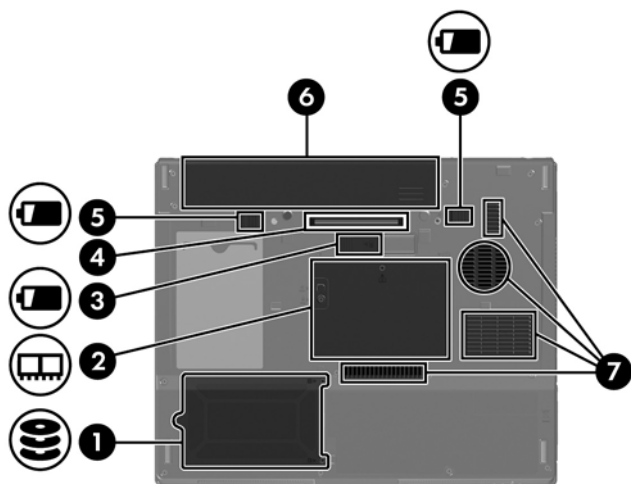

Component

①	Hard drive bay	⑤	Primary battery pack release latches (2)
②	Expansion memory module and Mini Card compartment	⑥	Battery bay
③	Accessory battery connector	⑦	Exhaust vents (4)
④	Docking connector		

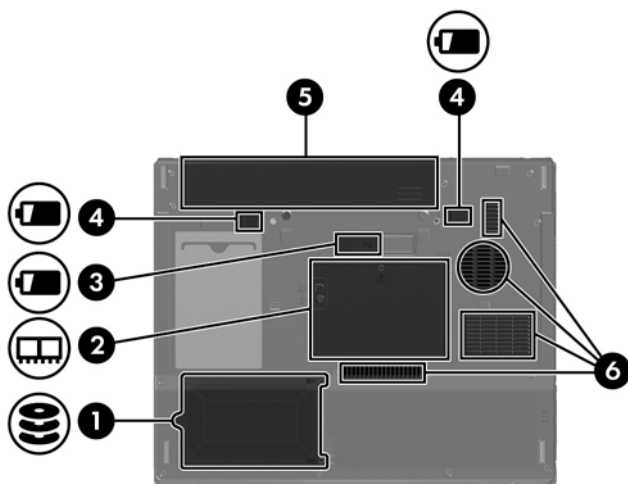

Component

- | | |
|---|--|
| ❶ Hard drive bay | ❷ Primary battery pack release latches (2) |
| ❸ Expansion memory module and Mini Card compartment | ❹ Battery bay |
| ❺ Accessory battery connector | ❻ Exhaust vents (4) |
-

Set up the computer



CAUTION: To prevent file corruption and to ensure that the correct drivers are installed:

- Do not set up the computer for the first time while the computer is docked in an optional docking device.
 - During the hardware and software setup procedures:
 - Do not unplug the computer from external power.
 - Do not shut down the computer or initiate standby or hibernation.
-



Your computer may look slightly different from the illustrations in this section.

When setting up the computer, you will

1. Insert the battery pack into the computer so that it can begin to charge as soon as the computer is connected to external power.
2. Connect the computer to external power.
3. Turn on the computer.
4. Set up the software.
5. Create recovery discs

Step 1: Insert the battery pack

To insert a primary battery pack:

1. Turn the computer upside down on a flat surface, with the battery bay toward you.
2. Slide the battery pack ❶ into the battery bay until it is seated.

The battery pack release latches ❷ automatically lock the battery into place.

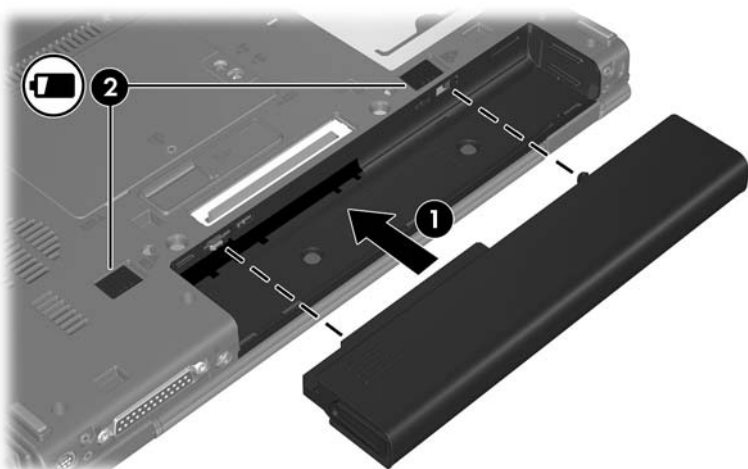

Step 2: Connect the computer to external power

To connect the computer to external AC power:

1. Plug the AC adapter into the power connector ❶ on the computer.
2. Plug the power cord into the AC adapter ❷.
3. Plug the other end of the power cord into an AC outlet ❸.

When the computer receives AC power, the battery pack begins to charge and the battery light (on the front of the computer) ❹ is turned on. When the battery pack is fully charged, the battery light is turned off.

It is recommended that you leave the computer connected to external power until the battery pack is fully charged and the battery light is turned off. (A partially charged new battery pack can run the computer after software setup is complete, but battery charge displays will not be accurate until the new battery pack has been fully charged.)



Power cords and AC outlets vary in appearance by region and country.



Step 3: Turn on the computer

To open the computer:

1. Slide the display release latch **1** to the right to release the display.
2. Raise the display **2**.



3. Press the power button **1**.

The power light next to the power button **2** and the power light on the front of the computer **3** are turned on, and you are prompted to begin software setup.

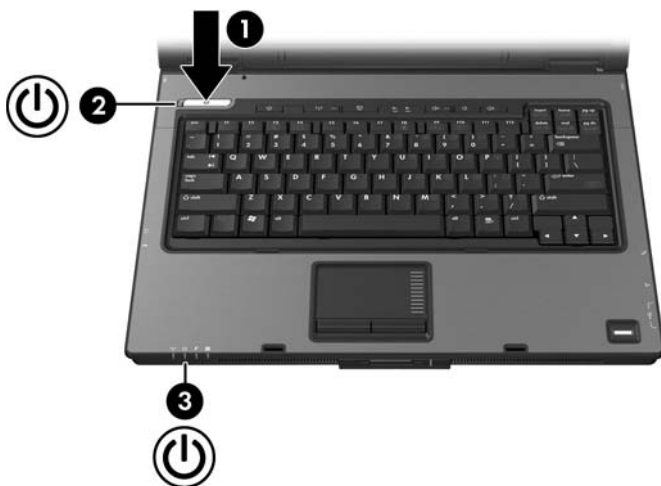

Step 4: Set up the software

After the computer is turned on, it will go through a brief software setup. Follow the on-screen instructions to set up the software. Note the following:

- After you respond to the setup prompt, you must complete the entire setup process without interruption. Setup time varies.
- During software setup, it is normal for some computer models to pause occasionally for several minutes. These normal pauses are indicated by an hourglass icon.



CAUTION: If you are prompted to select an operating system language before the “Welcome to Windows” page is displayed, choose carefully. On some models, the languages that you do not choose are deleted from the system and cannot be restored during software setup.



To register your operating system and your computer, you must be connected to the Internet. For more information about connecting to the Internet, refer to [Appendix C, “Connect to the Internet from your home,”](#) in this guide. If you do not send your registration during software setup, you can do so at any time after software setup is complete.

Step 5: Create recovery discs

HP highly recommends that you create recovery discs of your full factory image after you set up the computer for the first time.



After you create the recovery discs, you can increase the amount of space on the hard drive by deleting the recovery partition. However, doing this is **not** recommended.

HP Recovery CD/DVD Creator allows you to create a set of recovery discs for the computer. The recovery discs are used to boot up your computer and recover the operating system and software applications to factory settings in case of system failure or instability.

Note the following considerations before creating recovery discs:

- You will need high quality CD-R, DVD-R, or DVD+R media, purchased separately.
- Only one set of recovery discs can be created per computer.
- Number each disc before inserting it into the optical drive of the computer.
- If necessary, you can exit the program before you have finished creating the recovery discs. The next time you open HP Recovery CD/DVD Creator, you will be prompted to continue the disc creation process where you left off.

To create a set of recovery discs:

1. Select **Start > All Programs > HP Backup & Recovery Manager > HP Backup and Recovery Manager**.
2. Click **Next**.
3. Click **Create factory software recovery CDs or DVDs to recover the system (highly recommended)**.
4. Click **Next**.
The Recovery CD/DVD Creator Wizard opens.
5. Click **Next**.
6. Follow the on-screen instructions to create the recovery discs.



The wizard will specify the number of discs needed before disc creation begins.



For information about backup and recovery, refer to [Appendix B, “Backup and Recovery.”](#)

2

Next steps

Install additional hardware and software

To install additional hardware, such as an optional printer, follow the instructions provided by the hardware manufacturer to install any drivers required by the device.

Install new software by inserting the software disc into the optical drive, and then follow the on-screen instructions.

Protect the computer

The information in this section is designed to protect the computer from damage caused by a virus, a security breach, a power surge, or unsafe operation.

Protect the computer from viruses

When you use the computer for e-mail, network, or Internet access, you expose it to computer viruses. Computer viruses can disable the operating system, applications, or utilities, or cause them to function abnormally.

Antivirus software can detect most viruses, destroy them, and in most cases, repair any damage they have caused. To provide ongoing protection against newly discovered viruses, antivirus software must be updated.

Norton Internet Security is preinstalled on the computer (select models only). For information about using the Norton Internet Security software, select **Start > All Programs > Norton Internet Security > Help and Support**.

For more information about computer viruses, type viruses in the Search field in the Help and Support Center.

Protect your system files

The HP Backup and Recovery Manager provides several ways to back up the system and to recover optimal system functionality. Refer to [Appendix B, “Backup and Recovery”](#) for additional information.

Protect your privacy

When you use the computer for e-mail, network, or Internet access, unauthorized persons may be able to gain access to information about you, the computer, and your information.

To optimize the privacy protection features included with the computer, it is recommended that you

- Keep your operating system and software updated. Many software applications contain security enhancements. For information about updating your operating system and software, refer to [“Update your software,”](#) later in this chapter.
- Use a firewall. A firewall is software that monitors incoming traffic on the computer. Some firewalls also monitor outgoing traffic.

Protect the computer from power surges

To protect the computer from the power surges that may be caused by an uncertain power supply or an electrical storm:

- Plug the computer power cord into an optional, high-quality surge protector. Surge protectors are available from most computer or electronics retailers.
- During an electrical storm, either run the computer on battery power or shut down the computer and unplug the power cord.
- If applicable to your location, provide surge protection on the modem cable that connects the modem to a telephone line. Telephone line surge protectors are available from computer or electronic retailers in some regions.

Use the computer safely



WARNING: To reduce the risk of electric shock or damage to your equipment:

- Plug the power cord into an AC outlet that is easily accessible at all times.
 - Disconnect power from the computer by unplugging the power cord from the AC outlet (not by unplugging the power cord from the computer).
 - If provided with a 3-pin attachment plug on your power cord, plug the cord into a grounded (earthed) 3-pin outlet. Do not disable the power cord grounding pin; for example, by attaching a 2-pin adapter. The grounding pin is an important safety feature.
-



WARNING: To reduce the risk of serious injury, read the *Safety and Comfort Guide* (not available in all languages). It describes proper workstation setup; and proper posture, health, and work habits for computer users. The *Safety and Comfort Guide* also provides important electrical and mechanical safety information. This guide is available on the Web at <http://www.hp.com/ergo> and in the Help and Support Center. To access the Help and Support Center, select **Start > Help and Support > User Guides**.



WARNING: To avoid potential discomfort or burns, do not block the air vents or use the computer on your lap for extended periods. The computer is designed to run demanding applications at full power. As a result of increased power consumption, it is normal for the computer to feel warm or hot when used continuously. The computer complies with the user-accessible surface temperature limits defined by the International Standard for Safety of Information Technology Equipment (IEC 60950).



WARNING: To reduce potential safety issues, only the AC adapter or battery pack provided with the computer, a replacement AC adapter or battery pack provided by HP, or a compatible AC adapter or battery pack purchased as an accessory from HP should be used with the computer.

For more safety and regulatory information, and for battery disposal information, refer to *Regulatory, Safety, and Environmental Notices* located in the Help and Support Center. To access the Help and Support Center, select **Start > Help and Support > User Guides**.

Connect to a computer network

The computer may have one or more of the following networking devices:

- Local area network (LAN) device
- Wireless local area network (WLAN) device
- Wireless wide-area network (WWAN) device
- Bluetooth® device
- Internal modem

If you plan to connect the computer to a home office LAN or WLAN, you must have a router or a wireless router. Refer to the documentation that came with the router for additional information, or refer to the Help and Support Center for information on networking.

For information on connecting to a WWAN, refer to the *HP Broadband Wireless Getting Started* guide that came with the computer.

If you need assistance to connect to a company LAN or WLAN, contact your network administrator.

If the computer has a Bluetooth device, you can create a personal area network (PAN) to connect to other Bluetooth-enabled devices, such as computers, telephones, printers, headsets, speakers, and cameras. For information on using a Bluetooth device, refer to the *Bluetooth Getting Started* guide in the Help and Support Center.



For information on connecting the computer to the Internet when you are not connected to a network, refer to [Appendix C, “Connect to the Internet from your home.”](#)

Update your software

Most software, including the operating system, is updated frequently by the manufacturer or provider. Important updates to the software included with the computer may have been released since the computer left the factory.

Some updates may affect the way the computer responds to optional software or external devices. Many updates provide security enhancements.

It is strongly recommended that you update the operating system and other software provided on the computer as soon as the computer is connected to the Internet.

To access update links for the operating system and other software provided on the computer:

- » Select **Start > Help and Support**.

Locate the user guides

User guides, regulatory and safety notices, and other resources that provide information about using the computer are available through the Help and Support Center (select **Start > Help and Support > User Guides**), or on a *User Guides* disc included with some models.

For more information about the resources available through the Help and Support Center, refer to “[Help and Support Center](#)” in [Chapter 3, “Troubleshooting.”](#)”

Turn off the computer correctly

Whenever possible, turn off the computer by using the standard Windows shutdown procedure:

1. Save your work and close all open applications.
2. Shut down the computer through the operating system by selecting **Start > Turn Off Computer > Turn Off**.

 In Windows XP Professional, select **Start > Turn Off Computer > Shut down > OK**. (If you have been registered to a domain, the button you click will be called Shut Down instead of Turn Off Computer.)

If the system is unresponsive and you are unable to shut down the computer with these procedures, use the following emergency procedures in the sequence provided:



CAUTION: Emergency shutdown procedures result in the loss of unsaved information.

- Press **ctrl+alt+delete**. Then, select **Shut Down > Turn Off**.
- Press and hold the power button for at least 5 seconds.
- Disconnect the computer from external power and remove the battery pack.

Next steps

3

Troubleshooting

Troubleshooting resources

If you experience computer problems, follow the troubleshooting steps below:

1. Refer to “[Quick troubleshooting](#),” next in this chapter.
2. Access additional information about the computer and Web site links through the Help and Support Center. Select **Start > Help and Support**.



Although many checkup and repair tools require an Internet connection, other tools can help you fix a problem when the computer is offline.

3. Contact Customer Care for any further assistance.

Quick troubleshooting

Is the computer unable to start up?

To turn on the computer, press the power button. When the computer is turned on, the power light is turned on.

If the computer and the power light are not turned on when you press the power button, adequate power may not be available to the computer.

The suggestions below may help you determine why the computer will not start up:

- If the computer is plugged into an AC outlet, verify that the AC outlet is providing adequate power by plugging another electrical device into the outlet.
- If the computer is running on battery power or is plugged into an external power source other than an AC outlet, plug the computer into an AC outlet using the AC adapter. Be sure the power cord and AC adapter connections are secure.
- If the computer is running on battery power:
 - ❑ Remove the primary battery pack and travel battery pack (if applicable) and plug the computer into an AC outlet using the AC adapter. If the computer starts up, one of the battery packs may need to be replaced.
 - ❑ If the battery light on the front of the computer is blinking, the battery pack has reached a low-battery condition, which may prevent the computer from starting up. To start the computer and allow the battery to charge, plug the computer into an AC outlet using the AC adapter.

Is the computer screen blank?

If you have not turned off the computer but the screen is blank, the computer may be in standby or hibernation, may not be set to display the image on the computer screen, or the display switch may not be functioning properly.

The suggestions below may help you determine why the computer screen is blank:

- To resume from standby or restore from hibernation, briefly press the power button.

Standby and hibernation are energy-saving features that can turn off the display. Standby and hibernation can be initiated by the system while the computer is in Microsoft® Windows® but is not in use, or when the computer has reached a low-battery condition. To change these and other power settings, select **Start > Control Panel > Performance and Maintenance > Power Options**.

- To transfer the image to the computer screen, press **fn+f4**.

On most models, when an optional external display device, such as a monitor, is connected to the computer, the image can be displayed on the computer screen or the external display, or on both devices simultaneously. When you press **fn+f4** repeatedly, the image alternates among the computer display, one or more external display devices, and simultaneously displays on all devices.

- Press the display switch on the computer to confirm that it moves freely.

The display switch is normally located on the upper-left corner of the keyboard.

Is software functioning abnormally?

If the software becomes unresponsive or responds abnormally:

- Restart the computer:
 - In Windows XP Home, select **Start > Turn Off Computer > Restart**.
 - In Windows XP Professional, select **Start > Turn Off Computer > Restart > OK**. (If you have been registered to a domain, the button you click will be called Shut Down instead of Turn Off Computer.)

If you cannot restart the computer using these procedures, refer to the next section, “[Is the computer turned on, but is not responding?](#)”

- Run a virus scan. For information about using the antivirus resources on your computer, refer to “[Protect the computer from viruses](#)” in the [Chapter 2](#), “Next steps.”

Is the computer turned on, but is not responding?

If the computer is turned on, but is not responding to software applications or keyboard commands, try first to shut down the computer through the operating system by selecting **Start > Turn Off Computer > Turn Off**. (If you have been registered to a domain, the button you click will be called Shut Down instead of Turn Off Computer.)

If the computer remains unresponsive, try the emergency shutdown procedures in the following sequence:

1. If the computer is in Windows, press **ctrl+alt+delete**. Then, select **Shut Down > Turn Off**.
2. If you cannot shut down the computer by using **ctrl+alt+delete**, press and hold the power button for at least 5 seconds.
3. If you cannot shut down the computer by using the power button, unplug the computer from external power and remove the battery pack.



If you cannot turn the computer back on after shutting it down, refer to “[Is the computer unable to start up?](#)”

Is the computer unusually warm?

It is normal for the computer to feel warm to the touch while it is in use. But if the computer feels *unusually* warm, it may be overheating because a vent is blocked.

If you suspect that the computer is overheating, allow the computer to cool to room temperature. Then be sure to keep all vents free from obstructions while you are using the computer.



CAUTION: To prevent overheating, do not obstruct vents. Use the computer only on a hard, flat surface. Do not allow another hard surface, such as a printer, or a soft surface, such as a pillow or a thick rug or clothing, to block airflow.



The fan in the computer starts up automatically to cool internal components and prevent overheating. It is normal for the internal fan to cycle on and off during routine operation.

Is an external device not working?

If an external device does not function as expected:

- Turn on the device as instructed in the device user guide. Some devices, such as monitors and printers, may not be powered by the computer, and must be turned on before the computer is turned on.
- Be sure that
 - All device connections are secure.
 - The device is receiving electrical power.
 - The device, especially if it is an older one, is compatible with your operating system. For compatibility information, refer to the Web site of the device manufacturer.
 - The correct drivers are installed and updated. Drivers may be available on a CD included with the device or on the Web site of the device manufacturer. For more information about updating drivers, select **Start > Help and Support**.

Is the home wireless network connection not working?

If a home wireless network connection is not working as expected:

- Be sure that the wireless light on the computer is on. If the light is off, press the wireless button to turn it on.
- Be sure that the computer wireless antennae are free from obstructions.
- Be sure that the cable or DSL modem and its power cord are properly connected, and the lights are on.
- Be sure that the wireless router (access point) is properly connected to its power adapter and the cable modem, and the lights are on.
- Disconnect and then reconnect all cables, and turn the power off and then back on.



For information on setting up a home wireless network connection, refer to <http://www.hp.com/go/techcenter/wireless>.

Help and Support Center

If the preceding questions and solutions did not address your problem, access the Help and Support Center by selecting **Start > Help and Support**. In addition to providing information about your operating system, the Help and Support Center provides

- Information about your computer, such as model and serial number, installed software, hardware components, and specifications.
- Answers to question about using your computer.
- Product information to help you learn to use computer and operating system features.
- Updates for your operating system, device drivers, and the software provided on your computer.
- Checkups for computer functionality.
- Automated and interactive troubleshooting, repair solutions, and system recovery procedures.
- Links to community forums of IT experts.

Customer Care

If you are unable to find the help you need by using the Help and Support Center at **Start > Help and Support**, you may need to contact Customer Care.

Preparing to contact Customer Care

For the fastest possible resolution of your problem, have the computer and the following information available when you call or e-mail:

- Product name located on the display or keyboard.
- Serial number (s/n) listed on the service tag.
 - The service tag label is on the bottom of the computer.
 - To display the service tag information on the computer screen, select **Start > Help and Support > My Computer**.
- Date the computer was purchased.
- Conditions under which the problem occurred.
- Error messages that have been displayed.

- The manufacturer and model of the printer or other accessories connected to the computer.
- Operating system version number and registration number.

To display the operating system version number and registration number, select **Start > Help and Support > My Computer**. (On some models, the registration number may be identified in the Operating System table as the *Product Id*).

Contacting Customer Care by e-mail or telephone

If the computer is connected to the Internet, select **Start > Help and Support** to get help by e-mail or you can access Customer Care telephone numbers.

A

Specifications

The following sections provide information on the operating environment specifications and power specifications of the computer.

Operating Environment

The operating environment information in the following table may be helpful if you plan to use or transport the computer in extreme environments.

Factor	Metric	U.S.
Temperature		
Operating (not writing to optical disc)	0°C to 35°C	32°F to 95°F
Operating (writing to optical disc)	5°C to 35°C	41°F to 95°F
Nonoperating	-20°C to 60°C	-4°F to 140°F
Relative humidity (noncondensing)		
Operating	10% to 90%	10% to 90%
Nonoperating	5% to 95%	5% to 95%
Maximum altitude (unpressurized)		
Operating (14.7 to 10.1 psia*)	-15 m to 3,048 m	-50 ft to 10,000 ft
Nonoperating (14.7 to 4.4 psia*)	-15 m to 12,192 m	-50 ft to 40,000 ft
*Pounds per square inch absolute (psia) is another unit of measurement for altitude.		

Rated Input Power

The power information in this section may be helpful if you plan to travel internationally with your computer.

The computer operates on DC power, which can be supplied by an AC or a DC power source. Although the computer can be powered from a stand-alone DC power source, it is strongly recommended that the computer be powered only with an AC adapter or a DC power cord supplied by or approved for an HP computer.

The computer is capable of accepting DC power within the following specifications.

Input Power	Rating
Operating voltage	18.5 V dc @ 3.5 A - 65 W
Operating current	3.5 A

This product is designed for IT power systems in Norway with phase-to-phase voltage not exceeding 240 V rms.

B

Backup and Recovery

The HP Backup and Recovery Manager provides several ways to back up the system and to recover optimal system functionality. This chapter explains the available backup options. For information about recovering system functionality, refer to [“Recovering your system.”](#)



HP installed drivers, utilities, and applications can be copied to a CD or to a DVD using the HP Backup and Recovery Manager.

Safeguarding your data

Software or devices added to the computer can cause your system to become unstable. To safeguard your documents, store personal files in the My Documents folder and periodically create a backup copy of the folder.

Backing up your system

Using HP Backup and Recovery Manager, you can back up

- Specific files and folders.
- The entire system.
- Modifications since your last backup, using HP system recovery points.

Backing up specific files or folders

You can back up specific files or folders to the hard drive, to an optional external hard drive, or to discs.

To back up specific files or folders:

1. Select **Start > All Programs > HP Backup and Recovery Manager > HP Backup and Recovery Manager**.
2. Click **Next**.
3. Click **Back up to protect user system settings and important data files**, and then click **Next**.
4. Click **Back up specific files and folders** and then click **Next**.
The Backup Wizard opens.
5. Click **Back up selected files from most common locations (Recommended)**.
– or –
Click **Advanced Backup (Experienced users)** to access advanced filtering techniques.
6. Click **Next**.
7. Follow the on-screen instructions to back up specific files or folders.

Backing up your entire system

When you perform a complete system backup, you are saving the full factory image, including the Windows operating system, software applications, and all personal files and folders.



The entire image can be stored on another hard drive, on a network drive, or on recovery discs that you create. For information on creating recovery discs, refer to “Creating recovery discs.”

To back up your entire system:

1. Select **Start > All Programs > HP Backup & Recovery Manager > HP Backup and Recovery Manager**.
2. Click **Next**.
3. Click **Back up to protect user system settings and important data files**, and then click **Next**.
4. Click **Make a complete backup of my system**, and then click **Next**.

The “Welcome to Full Image Manager” page opens.

5. Follow the on-screen instructions to back up your entire system.
-



This process may take several minutes, depending on your computer speed and the amount of data being stored.

Backing up modifications made to your system

When you back up modifications made to your system, you are creating system recovery points. This allows you to save a snapshot of your hard drive at a specific point in time. You can then restore back to that point if you want to reverse subsequent changes made to your system.



By default, the first system recovery point, a snapshot of the entire image, is automatically created the first time you perform a backup. Subsequent recovery points make a copy of changes made after that time.

HP recommends that you create recovery points

- Before you add or extensively modify software or hardware.
 - Periodically, whenever the system is performing optimally.
-



Recovering to an earlier recovery point does not affect data files or e-mails created since that last recovery point.

After you create a recovery point, you are prompted to schedule subsequent recovery points. You can schedule recovery points for a specific time or event in your system.

To create and schedule a system recovery point:

1. Select **Start > All Programs > HP Backup & Recovery Manager > HP Backup and Recovery Manager**.
2. Click **Next**.
3. Click **Back up to protect user system settings and important data files**, and then click **Next**.
4. Click **Back up the modifications made on your system since your last recovery point or your first complete backup**, and then click **Next**.

The Recovery Point Manager opens.

5. Follow the on-screen instructions to create or manage recovery points.

Recovering your system

HP Backup and Recovery Manager analyzes your hard drive, creates a dedicated hard drive recovery partition on the hard drive, and stores a copy of the full factory image on that partition. You can choose to keep the copy on the recovery partition, or you can choose to store it on external recovery discs or on another drive.



Before using HP Backup and Recovery Manager, try repairing the system by running Microsoft Windows System Restore. For more information, select **Start > Help and Support**, and then search for “System Restore.”

The HP Backup and Recovery Manager allows you to

- **Create recovery discs (highly recommended).** The recovery discs are used to start your computer and to recover the full factory image (operating system and software) in case of system failure or instability. For more information, refer to [“Creating recovery discs.”](#)
- **Perform a recovery.** HP Backup and Recovery Manager allows you to perform a full system recovery or to recover important files. This software works from a recovery partition on the hard drive or from recovery discs that you create. For more information, refer to [“Performing a recovery.”](#)

Creating recovery discs

HP recommends that you create recovery discs of your full factory image after you set up the computer for the first time.



After you create the recovery discs, you can increase the amount of space on the hard drive by deleting the recovery partition. However, doing this is **not** recommended.

HP Recovery CD/DVD Creator allows you to create a set of recovery discs for the computer. The recovery discs are used to boot up your computer and recover the operating system and software applications to factory settings in case of system failure or instability.

Note the following considerations before creating recovery discs:

- You will need high quality CD-R, DVD-R, or DVD+R media, purchased separately.
- Only one set of recovery discs can be created per computer.
- Number each disc before inserting it into the optical drive of the computer.
- If necessary, you can exit the program before you have finished creating the recovery discs. The next time you open HP Recovery CD/DVD Creator, you will be prompted to continue the disc creation process where you left off.

To create a set of recovery discs:

1. Select **Start > All Programs > HP Backup & Recovery Manager > HP Backup and Recovery Manager**.
2. Click **Next**.
3. Click **Create factory software recovery CDs or DVDs to recover the system (highly recommended)**.

4. Click **Next**.

The Recovery CD/DVD Creator Wizard opens.

5. Click **Next**.

6. Follow the on-screen instructions to create the recovery discs.



The wizard will specify the number of discs needed before disc creation begins.

Performing a recovery

Performing a recovery from the recovery discs

To perform a recovery from the recovery discs:

1. Back up all personal files. For more information, refer to [“Backing up specific files or folders.”](#)
2. Insert the first recovery disc into the optical drive and restart the computer.
3. Follow the on-screen instructions to perform a recovery from the recovery discs.

Performing a recovery from the hard drive

There are two ways to perform a recovery from the hard drive:

- From within Microsoft Windows.
- From the recovery partition.

Performing a recovery in Windows

To perform a recovery in Windows:

1. Back up all personal files before performing a recovery. For more information, refer to “[Backing up specific files or folders](#).”
2. If the computer is on, select **Start > All Programs > HP Backup & Recovery Manager > HP Backup and Recovery Manager**.
3. Click **Next**.
4. Click **Recover important files or the entire system**, and then click **Next**.
5. Select a recovery option, and then click **Next**.



If you select to recover the system, the computer restarts and recovery will begin.

6. Follow the on-screen instructions to perform a recovery in Windows.

Performing a recovery from the recovery partition

To perform a recovery from the recovery partition:

1. Back up all personal files before performing a recovery. For more information, refer to “[Backing up specific files or folders](#).”
2. Turn on or restart the computer, and then press **f11** before the Windows operating system loads.
3. Select a recovery option, and then click **Next**.
4. Follow the on-screen instructions to perform a recovery from the recovery partition.

Backup and Recovery

C

Connect to the Internet from your home

Your computer includes hardware and software that allows you to connect to the Internet. Before you can access the Internet, you must

- Choose an Internet service provider (ISP).
- Choose the type of Internet access you want, and connect the hardware.



Internet hardware and software features vary depending on your computer model and your location.

Choose an ISP

You must set up Internet service before you can connect to the Internet. The New Connection Wizard helps you set up a new Internet account or configure the computer to use an existing account.

Using the New Connection Wizard

You can use the New Connection Wizard to connect to the Internet

- If you already have an account with an ISP.
- If you have a disc from an ISP.
- If you do not have an Internet account and would like to select an ISP from the list provided within the wizard.
- If you have selected an unlisted ISP and the ISP has provided you with such information as a specific IP address, and POP3 and SMTP settings.

To access the New Connection Wizard and instructions for using the wizard:

- » Select **Start > Help and Support**.



If you are prompted within the wizard to choose between enabling or disabling Windows Firewall, choose to enable the firewall. For more information about firewalls, refer to “[Protect your privacy](#)” in [Chapter 2](#), “Next steps.”

Choose the type of Internet access

There are 3 basic types of Internet access:

- **Broadband:** High-speed Internet access is available through
 - ❑ Cable modem
 - ❑ Digital Subscriber Line (DSL)
 - ❑ Satellite
 - ❑ Other services

For broadband access, additional hardware and/or software must be provided by your ISP. Refer to “[Choose an ISP](#),” or contact your ISP for details.

- **Wireless:** For high-speed mobile Internet access, you can use a wireless connection. A wireless network set up at home requires a wireless router, purchased separately. To learn about setting up wireless access, select <http://www.hp.com/go/techcenter/wireless> (English only).
- **Dial-up:** You can access the Internet by dialing into a service provider using a modem cable connected to an RJ-11 (modem) jack.

Connect to the Internet from your home

Index

1394 port 1–10

A

accessory battery connector,
 identifying 1–12, 1–13
altitude specifications A–1
antivirus software 3–4
audio-in (microphone) jack
 1–11
audio-out (headphone) jack
 1–11

B

battery bay 1–12, 1–13
battery light
 identifying 1–7, 1–8
 on, off 1–16
battery pack
 charging 1–16
 identifying 1–1
 inserting 1–15
battery pack release latch
 1–12, 1–13
bays
 battery 1–12, 1–13
 hard drive 1–12, 1–13
buttons
 ExpressCard slot eject
 1–11

Info Center 1–2
optical drive 1–10
PC Card slot eject 1–11
power 1–2, 1–3
Presentation mode 1–2
TouchPad 1–5
 volume down 1–2
 volume mute 1–2
 volume up 1–2
 wireless 1–2, 1–3

C

cables
 modem 1–11
 network 1–11
cables and cords, power 3–2
caps lock light, identifying
 1–2, 1–3
compartments
 expansion memory module
 1–12
 expansion memory module
 and Mini Card 1–13
 Mini Card 1–12
computer
 turn off 2–7
 turn on 1–18
computer viruses 3–4

- connect the computer to external power 1–16
- connecting to a computer network 2–5
- connectors
 - accessory battery 1–12, 1–13
 - docking 1–12
 - power 1–9
- Customer Care 3–10
- D**
- D 1–7
- data, safeguarding B–1
- devices, external,
 - troubleshooting 3–7
- Digital Media Slot light, identifying 1–7
- Digital Media Slot, identifying 1–7
- display release latch, identifying 1–7, 1–8
- display switch, identifying 1–2, 1–3
- display, switching image 3–3
- docking connector 1–12
- drive, optical 1–10
- E**
- eject button, PC Card slot 1–11
- embedded numeric keypad
 - keys, identifying 1–4
- environmental specifications A–1
- esc** key, identifying 1–4
- exhaust vents 1–11
- exhaust vents, identifying 1–12, 1–13
- expansion memory module compartment, identifying 1–12
- ExpressCard slot 1–11
- ExpressCard slot eject button 1–11
- external devices,
 - troubleshooting 3–7
- external monitor port 1–11
- F**
- fingerprint reader 1–2
- firewalls 2–2
- fn** key, identifying 1–4
- function keys, identifying 1–4
- H**
- hard drive bay, identifying 1–12, 1–13
- headphone (audio-out) jack 1–11
- Help and Support Center 3–9
- hibernation 3–3
- HP Smart AC Adapter
 - identifying 1–1
- humidity specifications A–1
- I**
- IDE drive light, identifying 1–7, 1–8
- IEC 60950 compliance 2–4
- IEEE 1394 port 1–10
- If 3–2
- image, switching among display devices 3–3

Info Center button, identifying
1-2
insert the battery pack 1-15
internal microphone 1-2
Internet access C-3
It 3-6

J

jacks
 audio-in (microphone)
 1-11
 audio-out (headphone)
 1-11
 RJ-11 (modem) 1-10
 RJ-45 (network) 1-11
 S-Video-out 1-9

K

keys
 embedded numeric keypad
 1-4
 esc 1-4
 fn 1-4
 function 1-4
 Windows applications 1-4
 Windows logo 1-4

L

labels, service tag 3-10
LAN (local area network) 2-5
latches
 battery pack release 1-12,
 1-13
 display release 1-7, 1-8
lights
 battery 1-16
 caps lock 1-2, 1-3

Digital Media Slot 1-7
IDE drive 1-7, 1-8
num lock 1-2, 1-3
power 1-2, 1-3, 1-7, 1-8,
 1-19
 wireless 1-2, 1-3, 1-7, 1-8
locate user guides 2-6

M

memory module compartment,
 expansion 1-13
microphone (audio-in) jack
 1-11
Mini Card compartment 1-13
Mini Card compartment,
 identifying 1-12
modem
 setting up Internet service
 C-3
 surge protection 2-3
modem cable 1-1, 1-11
monitor port, external 1-11
monitor, external 3-3, 3-7

N

network (RJ-45) jack 1-11
network cable 1-11
network, connecting computer
 to 2-5
New Connection Wizard C-2
num lock light, identifying
 1-2, 1-3

O

operating environment
 specifications A-1
operating system

- displaying version number
3–11
- optical drive button,
identifying 1–10
- optical drive, identifying 1–10
- overheating, computer 3–6
- overheating, safety
considerations 2–4
- P**
- parallel port, identifying 1–9
- PC Card slot 1–11
- PC Card slot eject button 1–11
- pointing stick
 - buttons 1–6
 - location 1–6
- ports
 - 1394 1–10
 - external monitor 1–11
 - parallel 1–9
 - serial 1–10
 - USB 1–10, 1–11
- power
 - running the computer on
battery 1–17
 - turning on computer 1–19,
3–2
- power button, identifying 1–2,
1–3
- power connector, identifying
1–9
- power cord
 - identifying 1–1
- power lights
 - identifying 1–2, 1–3, 1–7,
1–8
 - on, off 1–19, 3–2
- power surge 2–3
- Presentation mode button,
identifying 1–2
- printer 3–7
- Product Id 3–11
- R**
- rated input power,
specifications A–2
- reader, fingerprint 1–2
- recovery point B–2
- registration number, operating
system 3–11
- regulatory information notices
2–4
- Regulatory, Safety, and Envi-
ronmental Notices* 2–4
- release latch
 - battery pack 1–12, 1–13
- reset (emergency shutdown)
3–5
- RJ-11 (modem) jack 1–10
- RJ-45 (network) jack 1–11
- Run 3–4
- S**
- Safety and Comfort Guide* 2–4
- security cable slot, identifying
1–9
- serial number, computer 3–10
- serial port, identifying 1–10
- Service Tag 3–10
- service tag 3–10
- set up the software 1–20
- slots
 - Digital Media 1–7

- ExpressCard 1–11
- PC Card 1–11
- security cable 1–9
- software
 - antivirus 2–1
- software updates 2–6
- speakers, identifying 1–7, 1–8
- specifications
 - operating environment A–1
 - rated input power A–2
- standby 3–3
- S-Video-out jack, identifying 1–9
- switch, display 1–2, 1–3
- system lock-up 3–5
- T**
- temperature
 - safety considerations 2–4
 - specifications A–1
 - troubleshooting 3–6
- TouchPad buttons, identifying 1–5
- TouchPad, identifying 1–5
- traveling with computer,
 - environmental specifications A–2
- troubleshooting
 - display problems 3–3
 - external device problems 3–7
 - hibernation or standby problems 3–3
 - overheating problems 3–6
 - resources for 3–1
 - software problems 3–4
 - virus problems 3–4
 - wireless network problems 3–8
- turn off the computer 2–7
- turn on the computer 1–18
- U**
- update, software 2–6
- USB ports, identifying 1–10, 1–11
- user guides 2–6
- V**
- vents, exhaust 1–11, 1–12, 1–13
- viruses, antivirus software 2–1
- volume down button, identifying 1–2
- volume mute button, identifying 1–2
- volume up button, identifying 1–2
- W**
- Windows applications key, identifying 1–4
- Windows logo key, identifying 1–4
- wireless button, identifying 1–2, 1–3
- wireless light, identifying 1–2, 1–3, 1–7, 1–8
- WLAN (wireless local area network) 2–5
- WWAN (wireless wide-area network) 2–5

