

Wireless Speaker Instruction Manual

FCC ID: N7KF2S
Model Name: F2S



F2S

Introduction

Thank you for choosing the F2S as your source for entertainment! you can use this item with iPads,iPhones, iPods and many types of smartphone to stream music , and enjoy handsfree calling.In order to get the best results when using the device,please read this manual first before using.

Important Safety Information

- 1.Keep this product and its charging cable away from excessive heat;
- 2.Do not operate this device with a damaged cable or after it has malfunctioned or has been damaged in any manner;
- 3.Do not disassemble your device;

Description:

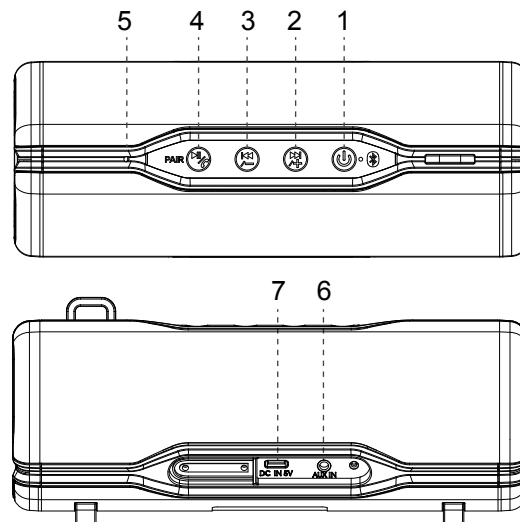

- 1.ON/OFF button
- 2.Next/Volume +
- 3.Previous/Volume -
- 4.Play/Pause/Phone
- 5.MIC
- 6.AUX in Port
- 7.Charging Port

Included:

- 1.Speaker
- 2.USB Micro Tape C Charging Cable
- 3.3.5 mm Audio Cable
- 4.User Manual

Specifications

Supported Profiles: A2DP, HFP, AVRCP
Bluetooth Range:33ft (10m)
Dimensions: L:202 mm * W 76.6 mm* D 88.6 mm
Battery: Li-Ion 7.2V, 2000 mAh
Charging: 5V @ 1A

Operation

Powering On

Press and Hold "  " button 2 seconds to power ON, the Blue LED will start to flash.

If an Aux (3.5 mm) cable is connected to the unit, the Blue LED will turn off, and the Green LED will stay illuminated, notifying you, the unit is in Aux-In mode.

Powering Off

Press and Hold "  " button 2 seconds to power OFF

Bluetooth Mode

Pairing

The unit will automatically go into "Pairing Mode" when it is powered ON.

Go into your Bluetooth device settings menu and look for "F2S"

After the unit has paired and connected, it will re-connect automatically when the unit is powered on and the device is in range.



Note: Bluetooth Timeout :10 minutes

Begin Streaming Music

Press "  " to start playing music

Press and Hold "  " 2 seconds to play the next track

Press and Hold "  " 2 seconds to play previous track

Press either "  " or "  " for volume control

Making and Receiving Phone Calls

When the unit is connected and paired to your device, the unit allows you to make or receive phone calls with its built-in microphone.

Press "  " to accept a call

To end a call press "  "

To place a call, simply dial the number or select a contact from your Bluetooth device and call

To reject a call, press and hold "  " for 2 seconds

Aux-In Mode

Plug in the supplied 3.5 mm cable into the unit. The other end is connected to your device. The Green LED will only illuminate when in "Aux" mode.

Please note music and volume can be controlled by your device.

Charging

Attach the USB cable to the unit, and plug into any USB charger.

If the unit is completely discharged, it will take approximately 4 hours to fully charge.

The Red LED will illuminate during charging, when it has completed, the Red LED will turn off.

Note: There will be a beep when the battery is low and needs to be recharged.

Troubleshooting

Unit doesn't connect to device	Speaker needs to be connected/re-paired to device
A tone is heard every few seconds	Speaker needs to be charged
Unit will not power on	Speaker needs to be charged
Unit doesn't control track(s)/volume	Speaker needs to be in Bluetooth mode for full control
Unit distorts at high volume	The devices' volume needs to be lowered

FCC Caution.

This device complies with part 15 of the FCC Rules. Operation is subject to the following two conditions:

- (1) This device may not cause harmful interference, and
- (2) this device must accept any interference received, including interference that may cause undesired operation.

Any Changes or modifications not expressly approved by the party responsible for compliance could void the user's authority to operate the equipment.

Note: This equipment has been tested and found to comply with the limits for a Class B digital device, pursuant to part 15 of the FCC Rules. These limits are designed to provide reasonable protection against harmful interference in a residential installation. This equipment generates uses and can radiate radio frequency energy and, if not installed and used in accordance with the instructions, may cause harmful interference to radio communications. However, there is no guarantee that interference will not occur in a particular installation. If this equipment does cause harmful interference to radio or television reception, which can be determined by turning the equipment off and on, the user is encouraged to try to correct the interference by one or more of the following measures:

- Reorient or relocate the receiving antenna.
- Increase the separation between the equipment and receiver.
- Connect the equipment into an outlet on a circuit different from that to which the receiver is connected.
- Consult the dealer or an experienced radio/TV technician for help.

The device has been evaluated to meet general RF exposure requirement. The device can be used in portable exposure condition without restriction.