



FCC CERTIFICATION TEST REPORT

FOR

Applicant : KINGTA TECHNOLOGY CO.,LTD
4F, Building 2, HaoJingDa Science Park, Shangmugu,
Address : Pinghu Town, Longgang District, Shenzhen, Guangdong
Province, China

Equipment under Test : BLUETOOTH SPEAKER

Model No : B3D

FCC ID : N7KB3D

Manufacturer : KINGTA TECHNOLOGY CO.,LTD
4F, Building 2, HaoJingDa Science Park, Shangmugu,
Address : Pinghu Town, Longgang District, Shenzhen, Guangdong
Province, China

Issued By: Dongguan Dongdian Testing Service Co., Ltd.

Add: No. 17, Zongbu Road 2, Songshan Lake Sci&Tech, Industry Park, Dongguan City,
Guangdong Province, China, 523808

Tel: +86-0769-22891499

Report No: DDT-F12018

Issued Date: 2012/05/03

TABLE OF CONTENTS

	Test report declares.....	3
1.	Summary of test results	5
2.	General test information	6
2.1.	Description of EUT.....	6
2.2.	Accessories of EUT	6
2.3.	Assistant equipment used for test.....	6
2.4.	Block diagram of EUT configuration for test	6
2.5.	Test environment conditions	7
2.6.	Test laboratory.....	7
2.7.	Measurement uncertainty	7
3.	Maximum Peak Output Power	8
3.1.	Test equipment.....	8
3.2.	Block diagram of test setup	8
3.3.	Limits	8
3.4.	Test Procedure	8
3.5.	Test Result	8
4.	20dB Bandwidth.....	10
4.1.	Test equipment.....	10
4.2.	Block diagram of test setup	10
4.3.	Limits	10
4.4.	Test Procedure	10
4.5.	Test Result	11
4.6.	Original test data.....	11
5.	Carrier Frequency Separation.....	15
5.1.	Test equipment.....	15
5.2.	Block diagram of test setup	15
5.3.	Limits	15
5.4.	Test Procedure	15
5.5.	Test Result	15
5.6.	Original test data.....	16
6.	Number Of Hopping Channel.....	17
6.1.	Test equipment.....	17
6.2.	Block diagram of test setup	17
6.3.	Limits	17
6.4.	Test Procedure	17
6.5.	Test Result	17

- 6.6. Original test data..... 18
- 7. Dwell Time20
 - 7.1. Test equipment20
 - 7.2. Block diagram of test setup20
 - 7.3. Limits20
 - 7.4. Test Procedure20
 - 7.5. Test Result20
 - 7.6. Original test data.....21
- 8. Radiated emission27
 - 8.1. Test equipment.....27
 - 8.2. Block diagram of test setup27
 - 8.3. Limit28
 - 8.4. Test Procedure29
 - 8.5. Test result.....29
- 9. Band Edge Compliance56
 - 9.1. Test equipment.....56
 - 9.2. Block diagram of test setup56
 - 9.3. Limit56
 - 9.4. Test Procedure57
 - 9.5. Test result.....57
- 10. Power Line Conducted Emission74
 - 10.1. Test equipment.....74
 - 10.2. Block diagram of test setup74
 - 10.3. Power Line Conducted Emission Limits(Class B).....74
 - 10.4. Test Procedure74
 - 10.5. Test Result75
- 11. Antenna Requirements78
 - 11.1. Limit78
 - 11.2. Result78
- 12. Test setup photograph.....79
- 13. Photos of the EUT81

TEST REPORT DECLARE

Applicant : KINGTA TECHNOLOGY CO.,LTD

Address : 4F, Building 2, HaoJingDa Science Park, Shangmugu, Pinghu Town, Longgang District, Shenzhen, Guangdong Province, China

Equipment under Test : BLUETOOTH SPEAKER

Model No : B3D

FCC ID : N7KB3D

Manufacturer : KINGTA TECHNOLOGY CO.,LTD

Address : 4F, Building 2, HaoJingDa Science Park, Shangmugu, Pinghu Town, Longgang District, Shenzhen, Guangdong Province, China

Test Standard Used: FCC Rules and Regulations Part 15 Subpart C:2012

Test procedure used: ANSI C63.10:2009

We Declare:

The equipment described above is tested by Dongguan Dongdian Testing Service Co., Ltd and in the configuration tested the equipment complied with the standards specified above. The test results are contained in this test report and Dongguan Dongdian Testing Service Co., Ltd is assumed of full responsibility for the accuracy and completeness of these tests.

After test and evaluation, our opinion is that the equipment provided for test compliance with the requirement of the above FCC standards.

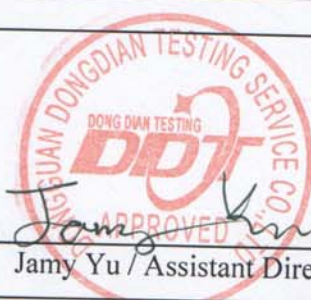
Report No:	DDT-F12018		
Date of Test:	2012/05/02—2012/05/03	Date of Report:	2012/05/03
Approved & Authorized Signer :	 Jamy Yu / Assistant Director		

Note: This report applies to above tested sample only. This report shall not be reproduced in parts without written approval of Dongguan Dongdian Testing Service Co., Ltd.

1. Summary of test results

Description of Test Item	Standard	Results
Maximum Peak Output Power	FCC Part 15: 15.247(b)(1) ANSI C63.10 :2009	PASS
20dB Bandwidth	FCC Part 15: 15.215 ANSI C63.10 :2009	PASS
Carrier Frequency Separation	FCC Part 15: 15.247(a)(1) ANSI C63.10 :2009	PASS
Number Of Hopping Channel	FCC Part 15: 15.247(a)(1)(iii) ANSI C63.10 :2009	PASS
Dwell Time	FCC Part 15: 15.247(a)(1)(iii) ANSI C63.10 :2009	PASS
Radiated Emission	FCC Part 15: 15.209 FCC Part 15: 15.247(d) ANSI C63.10 :2009	PASS
Band Edge Compliance	FCC Part 15: 15.247(d) ANSI C63.10 :2009	PASS
Power Line Conducted Emissions	FCC Part 15: 15.207 ANSI C63.10 :2009	PASS
Antenna requirement	FCC Part 15: 15.203	PASS

2. General test information

2.1. Description of EUT

EUT* Name	:	BLUETOOTH SPEAKER
Model Number	:	B3D
EUT function description	:	Please reference user manual of this device
Power supply	:	DC 3.7V from built-in battery and DC 5V from external power supply
FCC ID	:	N7KB3D
Radio Technology	:	Bluetooth 2.0+ EDR
FCC Operation frequency	:	2402MHz -2480MHz
Modulation	:	GFSK, $\pi/4$ QPSK, 8-DPSK
Antenna Type	:	“F” Shape PCB antenna, Gain: 0dBi
Date of Receipt	:	2012/04/20
Sample Type	:	Series production

Note: EUT is the ab. of equipment under test.

2.2. Accessories of EUT

Description of Accessories	Manufacturer	Model number or Type	Other
Line in cable	/	/	/
USB cable			/

2.3. Assistant equipment used for test

Description of Assistant equipment	Manufacturer	Model number or Type	Other
Notebook	LENOVO	X61S	/

2.4. Block diagram of EUT configuration for test



The test software “Bluesuite.exe” was used to control EUT work in Continuous TX mode, and select test channel, wireless mode

Tested mode, channel, and data rate information		
Mode	Channel	Frequency (MHz)
BDR:GFSK	Low :CH1	2402
	Middle: CH40	2441
	High: CH79	2480
$\pi/4$ QPSK	Low :CH1	2402
	Middle: CH40	2441
	High: CH79	2480
EDR:8-DPSK	Low :CH1	2402
	Middle: CH40	2441
	High: CH79	2480

Note: For $\pi/4$ QPSK its same modulation type with 8-DPSK, and based exploratory test, there is no significant difference of that two types test result, so except output power, all other items final test were only performed with 8-DPSK and GFSK.

2.5. Test environment conditions

During the measurement the environmental conditions were within the listed ranges:

Temperature range:	21-25°C
Humidity range:	40-75%
Pressure range:	86-106kPa

2.6. Test laboratory

Dongguan Dongdian Testing Service Co., Ltd

Add: No. 17, Zongbu Road 2, Songshan Lake Sci&Tech, Industry Park, Dongguan City, Guangdong Province, China, 523808 Tel: +86-0769-22891499

FCC Registration Number: 270092

2.7. Measurement uncertainty

Test Item	Uncertainty
Uncertainty for Conduction emission test	2.40dB
Uncertainty for Radiation Emission test (150KHz-30MHz)	3.21dB
Uncertainty for Radiation Emission test (30MHz-1GHz)	2.78 dB (Polarize: V)
	3.20 dB (Polarize: H)
Uncertainty for Radiation Emission test (1GHz to 25GHz)	2.08dB(Polarize: V)
	2.56dB (Polarize: H)
Uncertainty for radio frequency	1×10^{-9}
Uncertainty for conducted RF Power	0.65dB

Note: This uncertainty represents an expanded uncertainty expressed at approximately the 95% confidence level using a coverage factor of k=2.

3. Maximum Peak Output Power

3.1. Test equipment

Item	Equipment	Manufacturer	Model No.	Serial No.	Last Cal.	Cal. Interval
1	Spectrum analyzer	R&S	FSU	1166.1660.26	2011/11/23	1Y
2	Attenuator	Mini-Circuits	BW-S10W2	101109	2011/11/23	1 Y
3	RF Cable	Micable	C10-01-01-1	100309	2011/11/23	1 Y

3.2. Block diagram of test setup

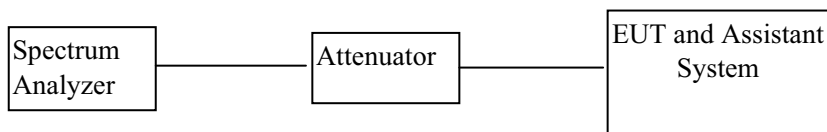

3.3. Limits

For frequency hopping systems operating in the 2400-2483.5 MHz band employing at least 75 non-overlapping hopping channels, and all frequency hopping systems in the 5725-5850 MHz band: 1 watt. For all other frequency hopping systems in the 2400-2483.5 MHz band: 0.125 watts, the e.i.r.p shall not exceed 4W

3.4. Test Procedure

- (1) Configure EUT and assistant system according clause 2.4 and 3.2
- (2) Connect EUT's antenna output to spectrum analyzer by RF cable and through a 10dB attenuator.
- (3) Configure EUT work in test mode as stated in clause 2.4.
- (4) Measure the maximum output power of EUT by spectrum analyzer with PK detector and RBW=3MHz(above 6dB bandwidth of measured signal), VBW=4MHz

Note: The attenuator loss was inputted into spectrum analyzer as amplitude offset.

3.5. Test Result

EUT: BLUETOOTH SPEAKER M/N: B3D					
Mode	Freq (MHz)	Result (dBm)	Limit (dBm)	Margin (dB)	Conclusion
GFSK	2402	2.56	30	27.44	PASS
	2441	2.43	30	27.57	PASS
	2480	2.30	30	27.70	PASS
$\pi/4$ QPSK	2402	2.20	30	27.80	PASS
	2441	2.24	30	27.76	PASS
	2480	2.10	30	27.9	PASS
8-DPSK	2402	2.45	30	27.55	PASS
	2441	2.43	30	27.57	PASS

	2480	2.32	30	27.68	PASS
Test Date : 2012/05/02			Test Engineer :Damon_Hu		

4. 20dB Bandwidth

4.1. Test equipment

Item	Equipment	Manufacturer	Model No.	Serial No.	Last Cal.	Cal. Interval
1	Spectrum analyzer	R&S	FSU	1166.1660.26	2011/11/23	1Y
2	Attenuator	Mini-Circuits	BW-S10W2	101109	2011/11/23	1 Y
3	RF Cable	Micable	C10-01-01-1	100309	2011/11/23	1 Y

4.2. Block diagram of test setup

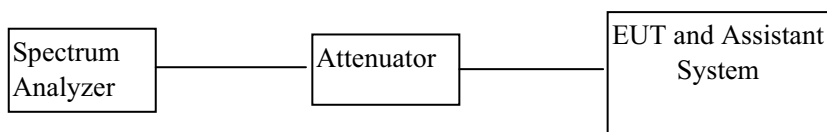

4.3. Limits

Intentional radiators operating under the alternative provisions to the general emission limits, as contained in § 15.217 through 15.257 and in Subpart E of this part, must be designed to ensure that the 20 dB bandwidth of the emission, or whatever bandwidth may otherwise be specified in the specific rule section under which the equipment operates, is contained within the frequency band designated in the rule section under which the equipment is operated.

4.4. Test Procedure

- (1) Configure EUT and assistant system according clause 2.4 and 4.2
- (2) Connect EUT's antenna output to spectrum analyzer by RF cable and though a 10dB attenuator.
- (3) Configure EUT work in test mode as stated in clause 2.4.
- (4) The bandwidth of the fundamental frequency was measured by spectrum analyzer with 30kHz RBW and 100kHz VBW. The 20dB bandwidth is defined as the total spectrum the power of which is higher than peak power minus 20dB.

4.5. Test Result

EUT: BLUETOOTH SPEAKER		M/N: B3D			
Mode	Freq (MHz)	Result (MHz)	Limit (MHz)	Margin (MHz)	Conclusion
GFSK	2402	0.846	/	/	PASS
	2441	0.849	/	/	PASS
	2480	0.856	/	/	PASS
8-DPSK	2402	1.202	/	/	PASS
	2441	1.209	/	/	PASS
	2480	1.207	/	/	PASS

Test Date : 2012/05/02 Test Engineer : Damon_Hu

4.6. Original test data

GFSK Mode

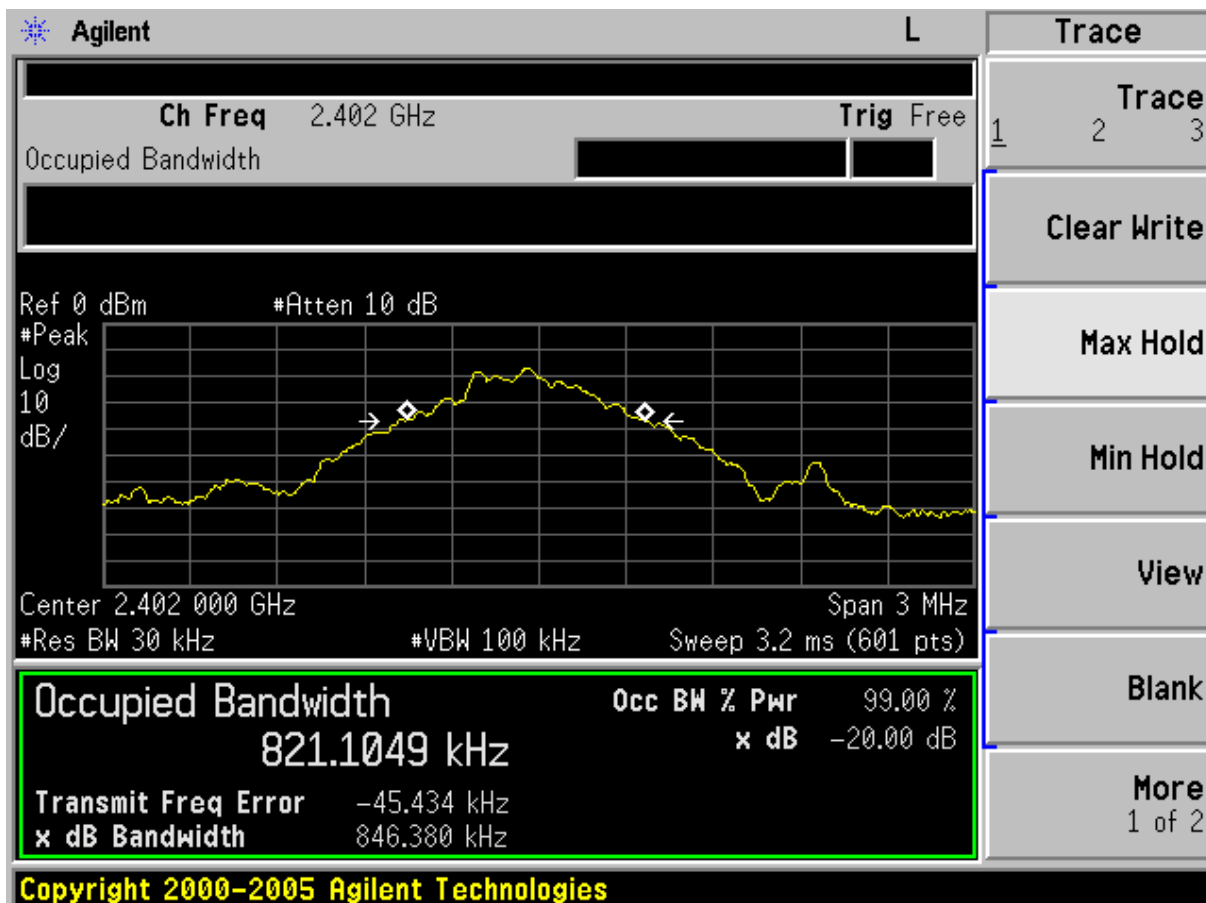

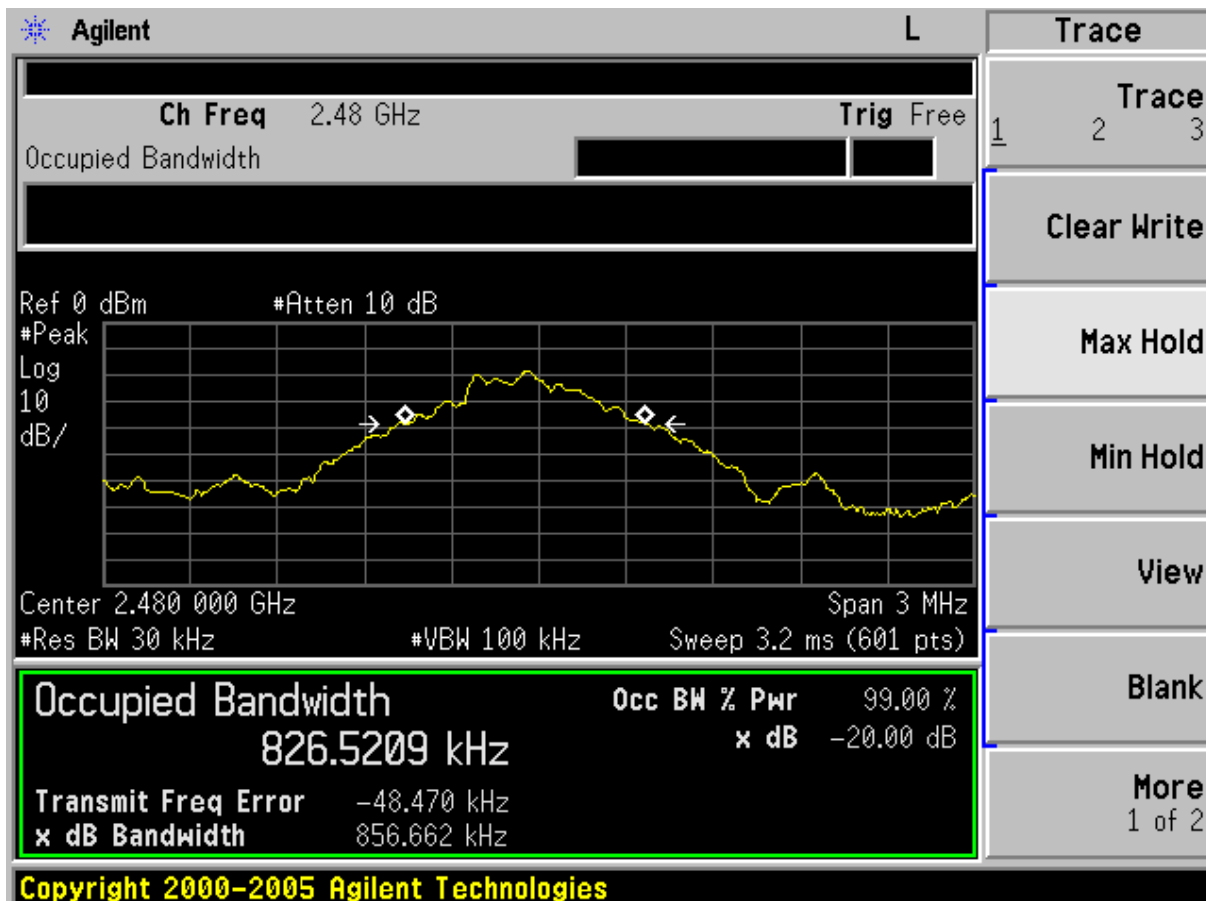

8-DPSK Mode

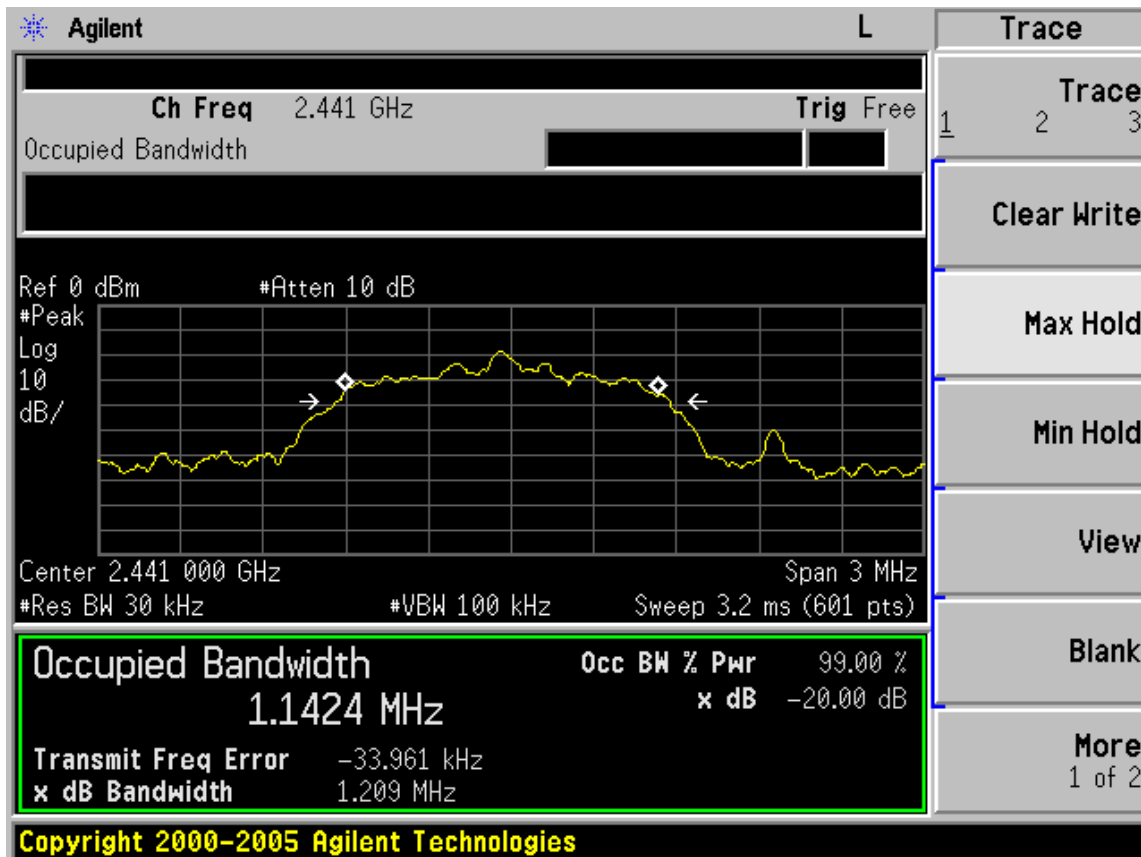
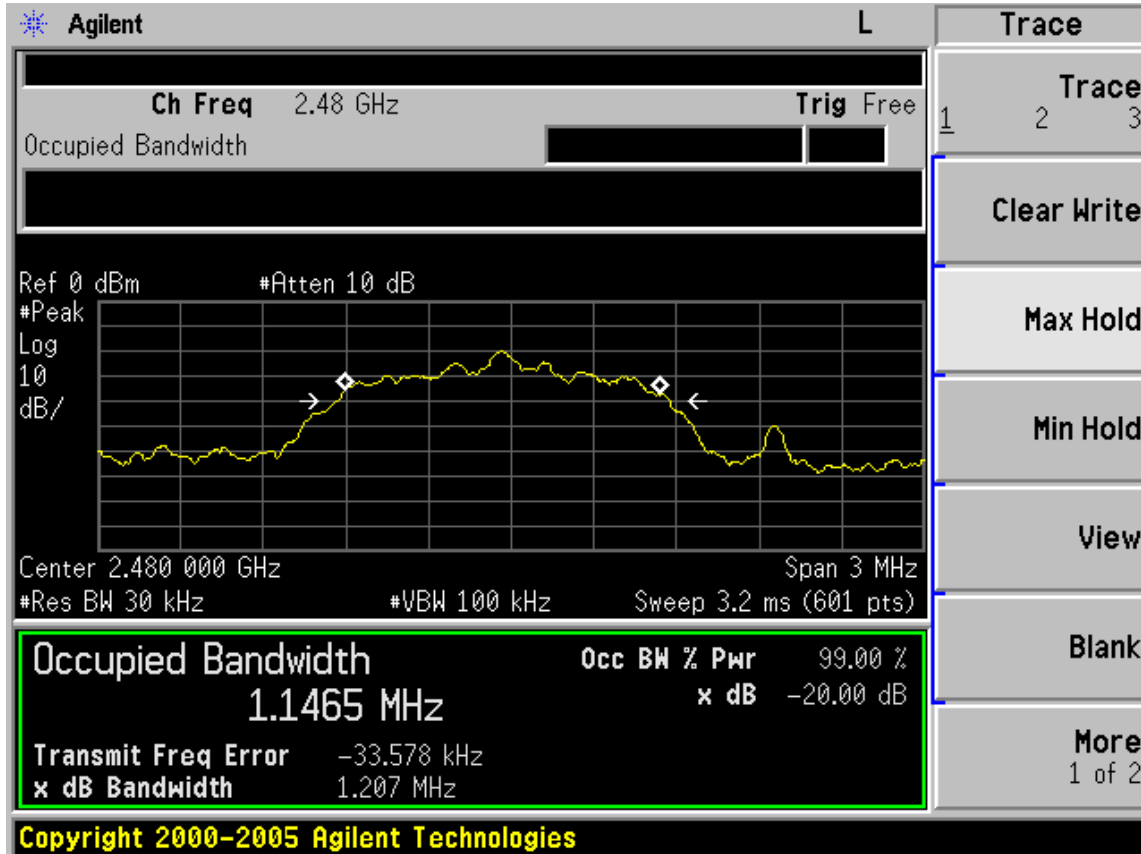

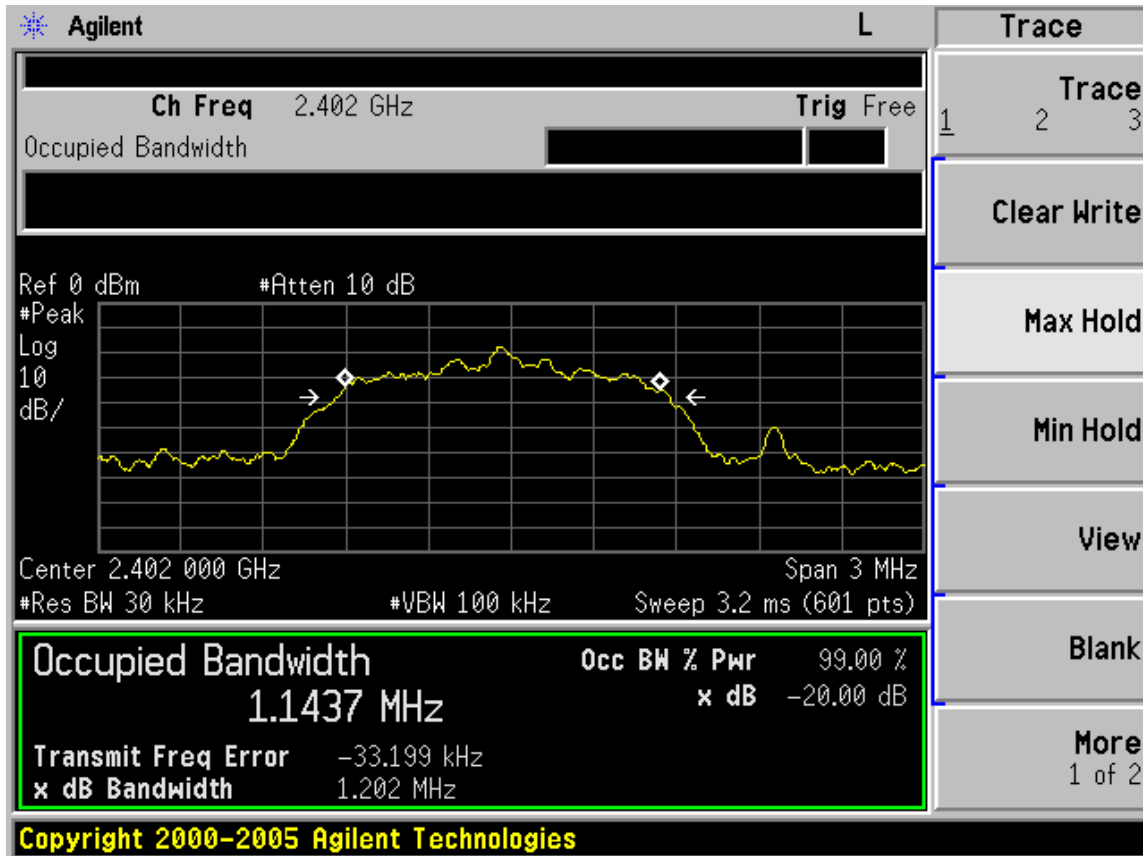

5. Carrier Frequency Separation

5.1. Test equipment

Item	Equipment	Manufacturer	Model No.	Serial No.	Last Cal.	Cal. Interval
1	Spectrum analyzer	R&S	FSU	1166.1660.26	2011/11/23	1Y
2	Attenuator	Mini-Circuits	BW-S10W2	101109	2011/11/23	1 Y
3	RF Cable	Micable	C10-01-01-1	100309	2011/11/23	1 Y

5.2. Block diagram of test setup

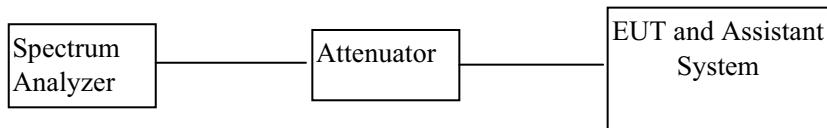

5.3. Limits

Frequency hopping systems shall have hopping channel carrier frequencies separated by a minimum of 25 kHz or the 20 dB bandwidth of the hopping channel, whichever is greater. Alternatively, frequency hopping systems operating in the 2400-2483.5 MHz band may have hopping channel carrier frequencies that are separated by 25 kHz or two-thirds of the 20 dB bandwidth of the hopping channel, whichever is greater, provided the systems operate with an output power no greater than 125 mW.

5.4. Test Procedure

- (1) Configure EUT and assistant system according clause 2.4 and 5.2
- (2) Connect EUT's antenna output to spectrum analyzer by RF cable and though a 10dB attenuator.
- (3) Configure EUT work in test mode as stated in clause 2.4.
- (4) The carrier frequency was measured by spectrum analyzer with 30kHz RBW and 100kHz VBW.

5.5. Test Result

EUT: BLUETOOTH SPEAKER		M/N: B3D			
Mode	Channel separation (MHz)	20dB Bandwidth (MHz)	Limit (MHz) 2/3 of 20dB bandwidth	Conclusion	
GFSK	1.0	0.856	0.570	PASS	
8-DPSK	1.0	1.209	0.80	PASS	
Test Date : 2012/05/02			Test Engineer : Damon_Hu		

5.6. Original test data

GFSK

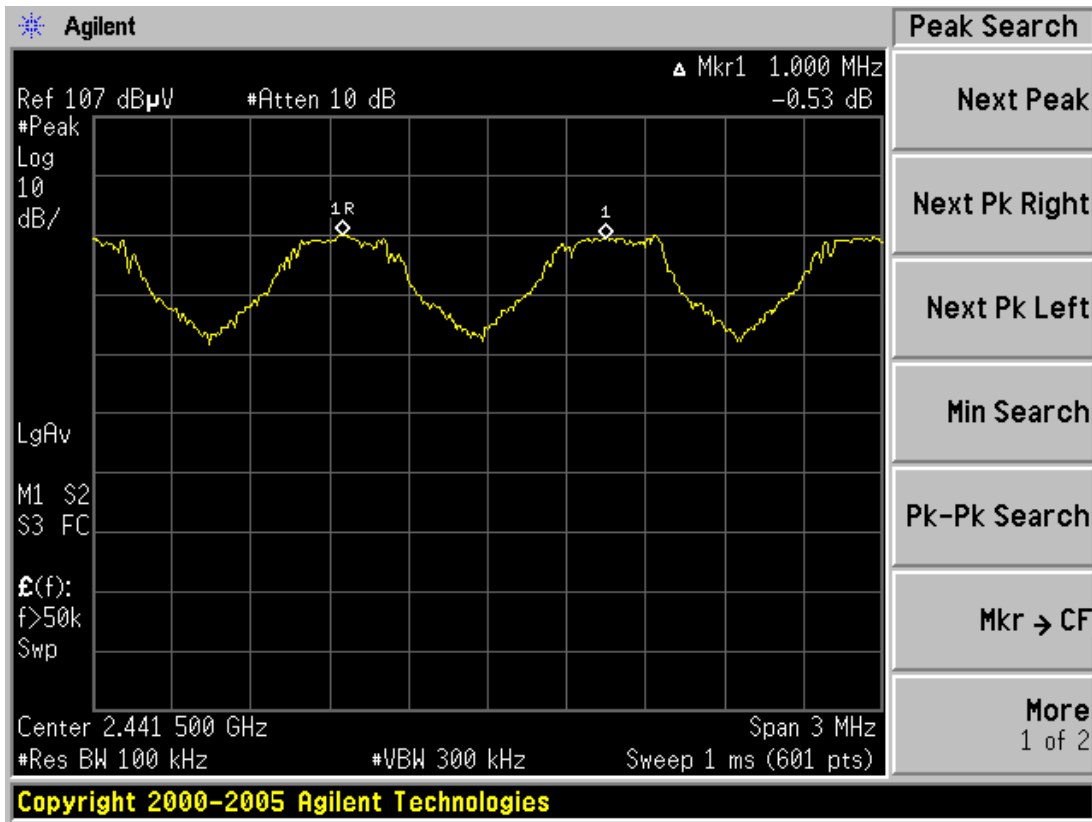

8-DPSK

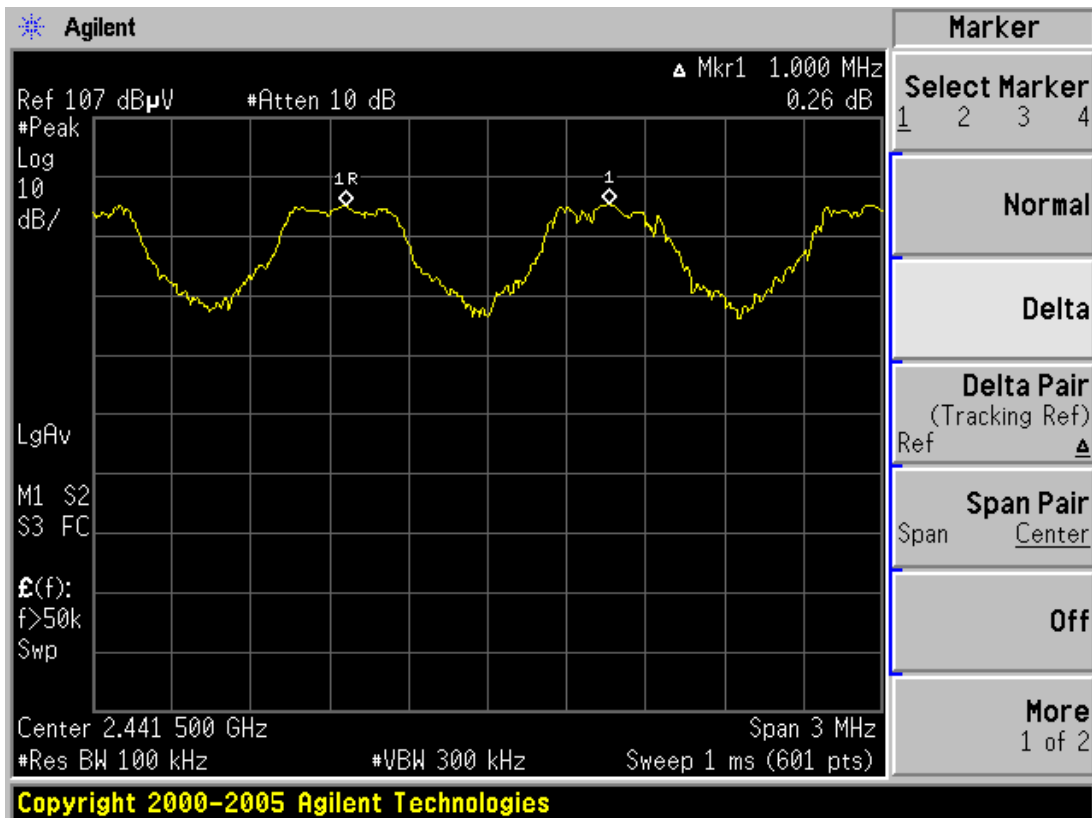

6. Number Of Hopping Channel

6.1. Test equipment

Item	Equipment	Manufacturer	Model No.	Serial No.	Last Cal.	Cal. Interval
1	Spectrum analyzer	R&S	FSU	1166.1660.26	2011/11/23	1Y
2	Attenuator	Mini-Circuits	BW-S10W2	101109	2011/11/23	1 Y
3	RF Cable	Micable	C10-01-01-1	100309	2011/11/23	1 Y

6.2. Block diagram of test setup

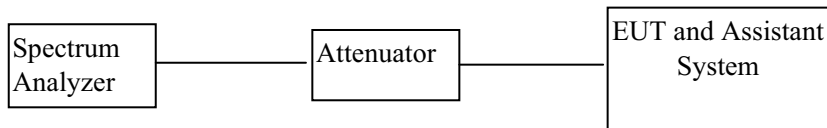

6.3. Limits

Frequency hopping systems in the 2400-2483.5 MHz band shall use at least 15 channels.

6.4. Test Procedure

- (1) Configure EUT and assistant system according clause 2.4 and 6.2
- (2) Connect EUT's antenna output to spectrum analyzer by RF cable and though a 10dB attenuator.
- (3) Configure EUT work in test mode as stated in clause 2.4.
- (4) The number of hopping channel was measured by spectrum analyzer with 300kHz RBW and 1MHz VBW.

6.5. Test Result

EUT: BLUETOOTH SPEAKER M/N: B3D			
Mode	Number of hopping channel	Limit	Conclusion
GFSK	79	>15	PASS
8-DPSK	79	>15	PASS
Test Date : 2012/05/02		Test Engineer : Damon_Hu	

6.6. Original test data

GFSK:

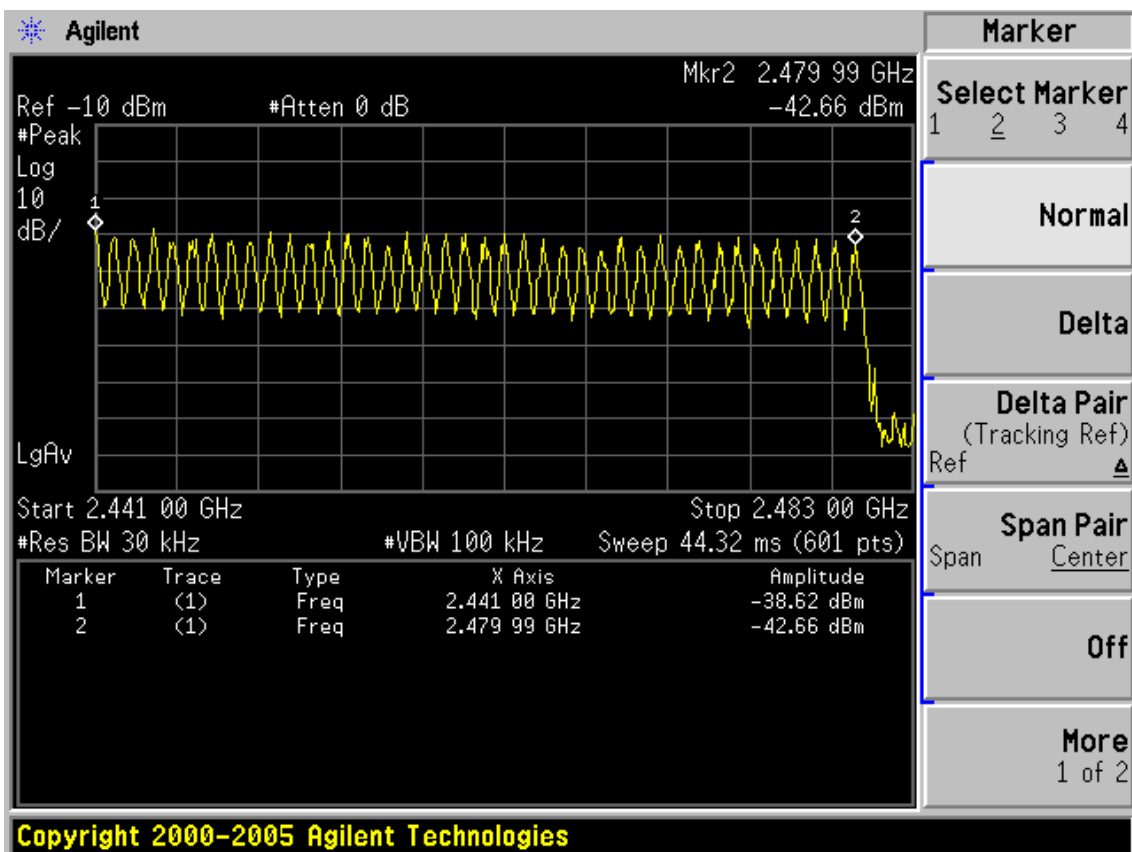
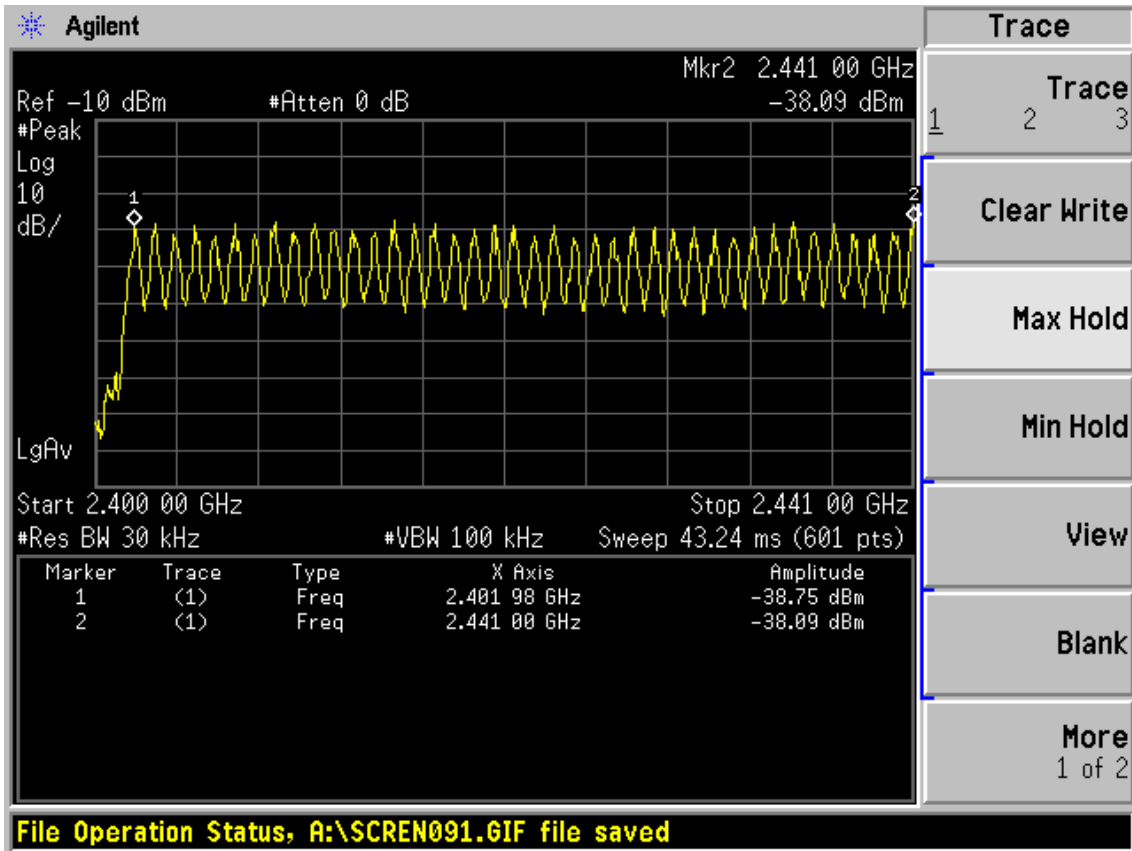

8-DPSK:

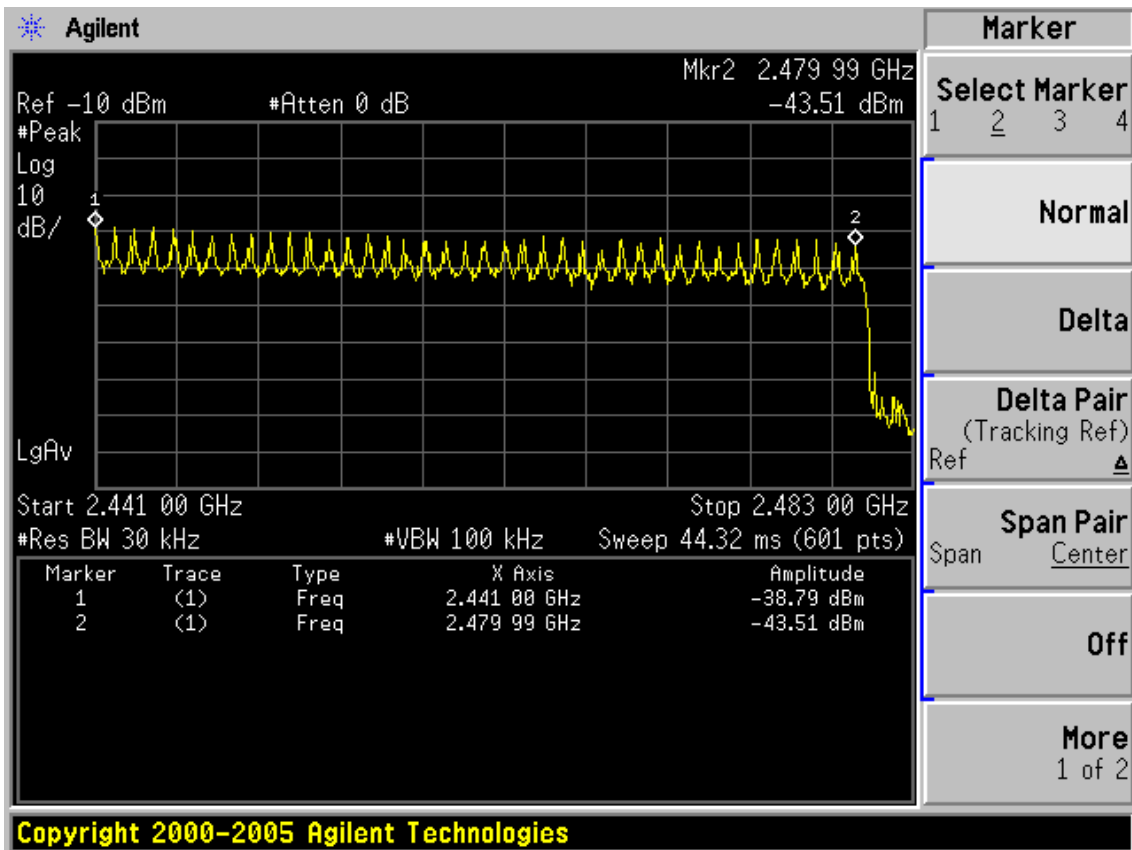
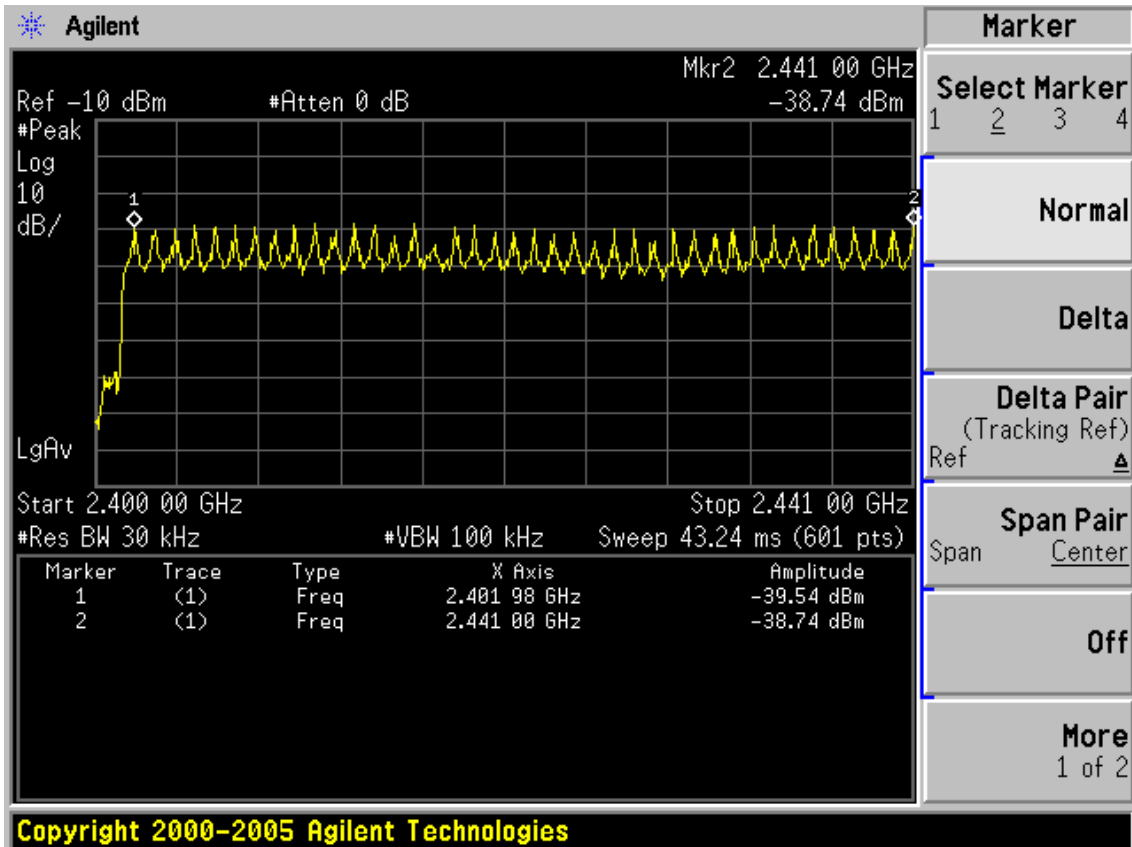

7. Dwell Time

7.1. Test equipment

Item	Equipment	Manufacturer	Model No.	Serial No.	Last Cal.	Cal. Interval
1	Spectrum analyzer	R&S	FSU	1166.1660.26	2011/11/23	1Y
2	Attenuator	Mini-Circuits	BW-S10W2	101109	2011/11/23	1 Y
3	RF Cable	Micable	C10-01-01-1	100309	2011/11/23	1 Y

7.2. Block diagram of test setup

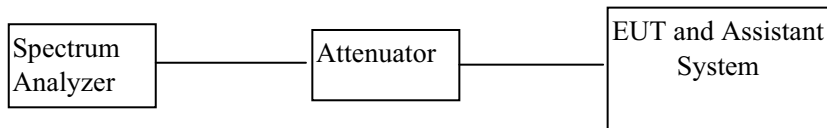

7.3. Limits

The average time of occupancy on any channel shall not be greater than 0.4 seconds within a period of 0.4 seconds multiplied by the number of hopping channels employed.

7.4. Test Procedure

- (1) Configure EUT and assistant system according clause 2.4 and 7.2
- (2) Connect EUT's antenna output to spectrum analyzer by RF cable and through a 10dB attenuator.
- (3) Configure EUT work in test mode as stated in clause 2.4.
- (4) Measure the hopping number and on time of each pulse with spectrum analyzer in zero span set, and calculate dwell time with formula $Dwell\ time = \frac{Hopping\ number}{measure\ time} * 0.4 * 79 * pulse's\ on\ time$

7.5. Test Result

EUT: BLUETOOTH SPEAKER M/N: B3D			
Mode	Number of hopping channel	Limit	Conclusion
DH1	167.48ms	<400ms	PASS
DH3	283.13ms	<400ms	PASS
DH5	298.30ms	<400ms	PASS
3-DH1	139.04ms	<400ms	PASS
3-DH3	268.60ms	<400ms	PASS
3-DH5	308.41ms	<400ms	PASS
Test Date : 2012/05/02		Test Engineer : Damon_Hu	

7.6. Original test data

DH1: $50\text{hop}/5\text{s} * 0.4 * 79 * 0.53\text{ms} = 167.48\text{ms}$

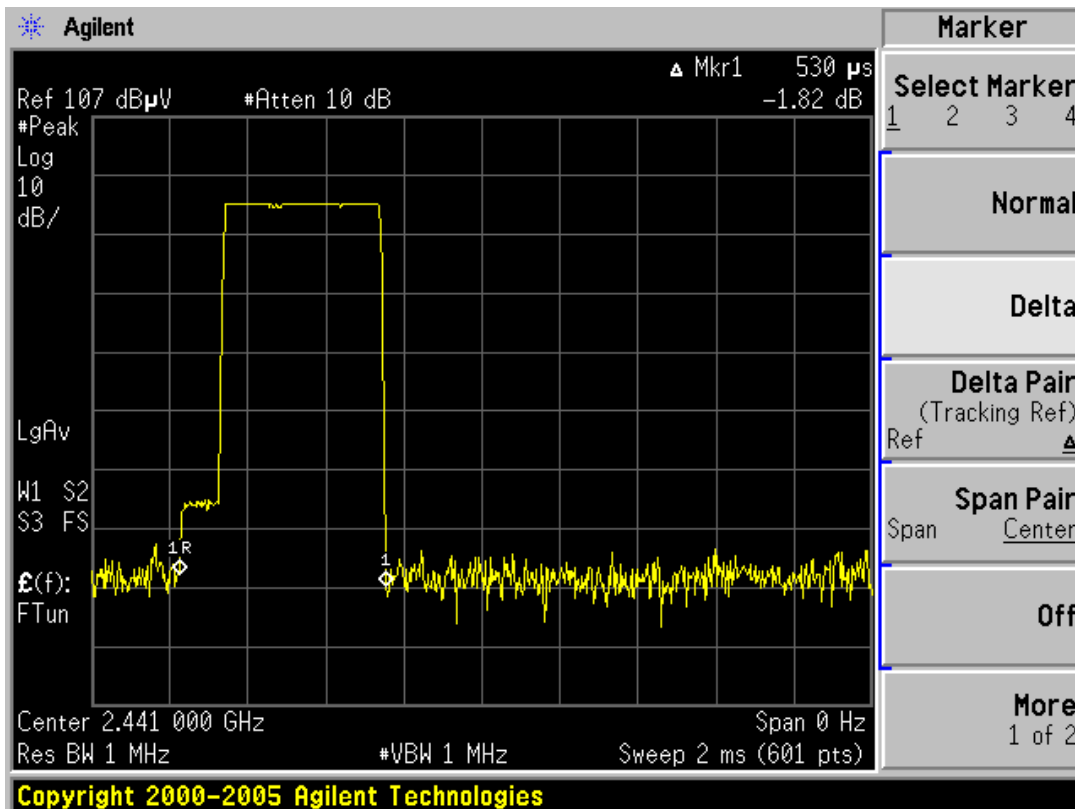
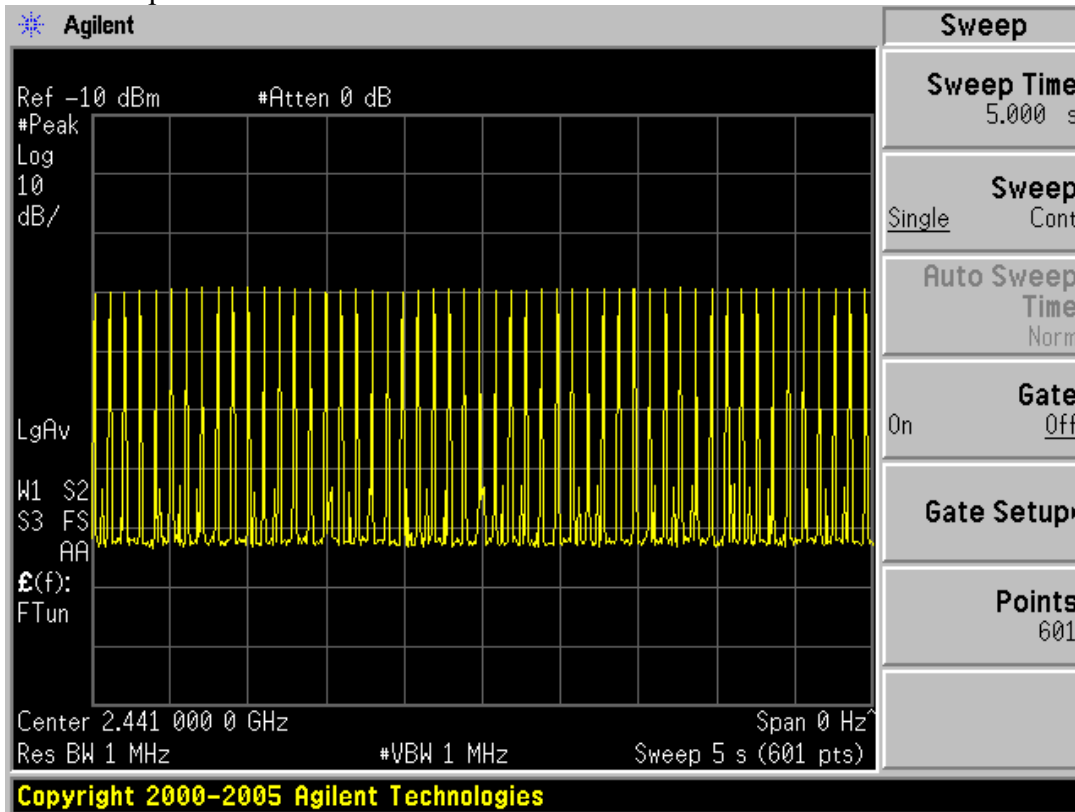

DH3: 25hop/5s*0.4*79*1.792ms=283.13ms

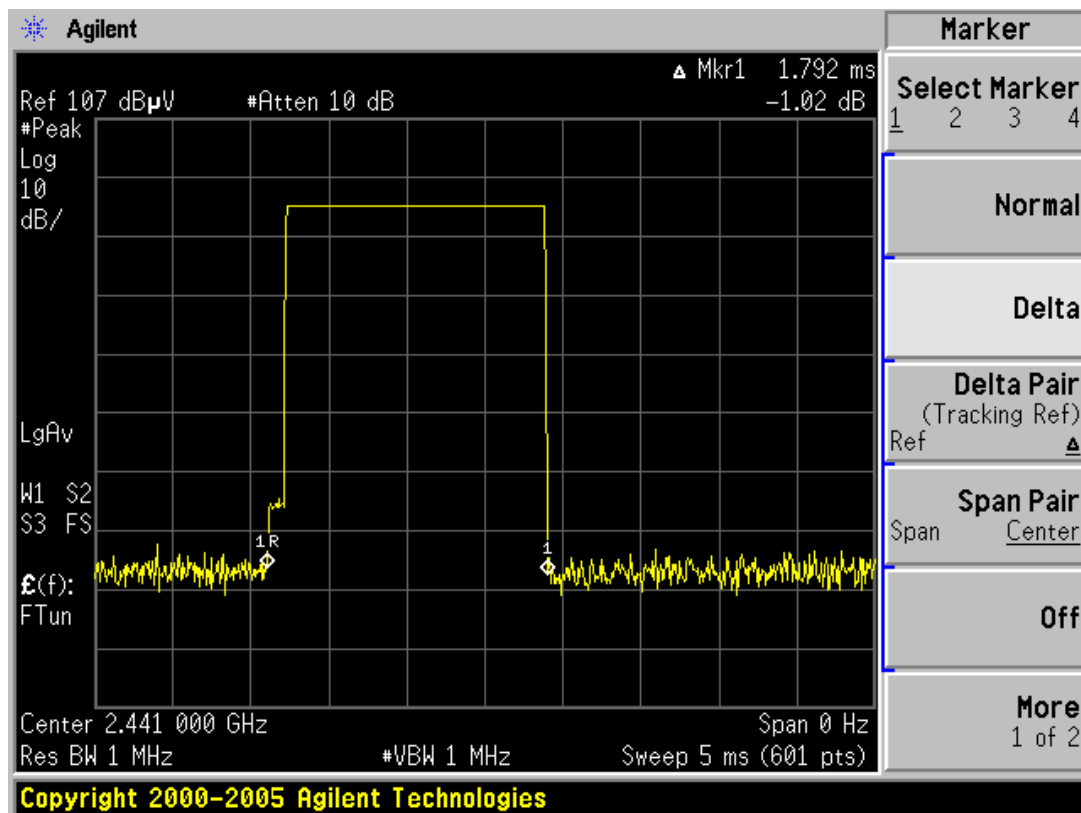
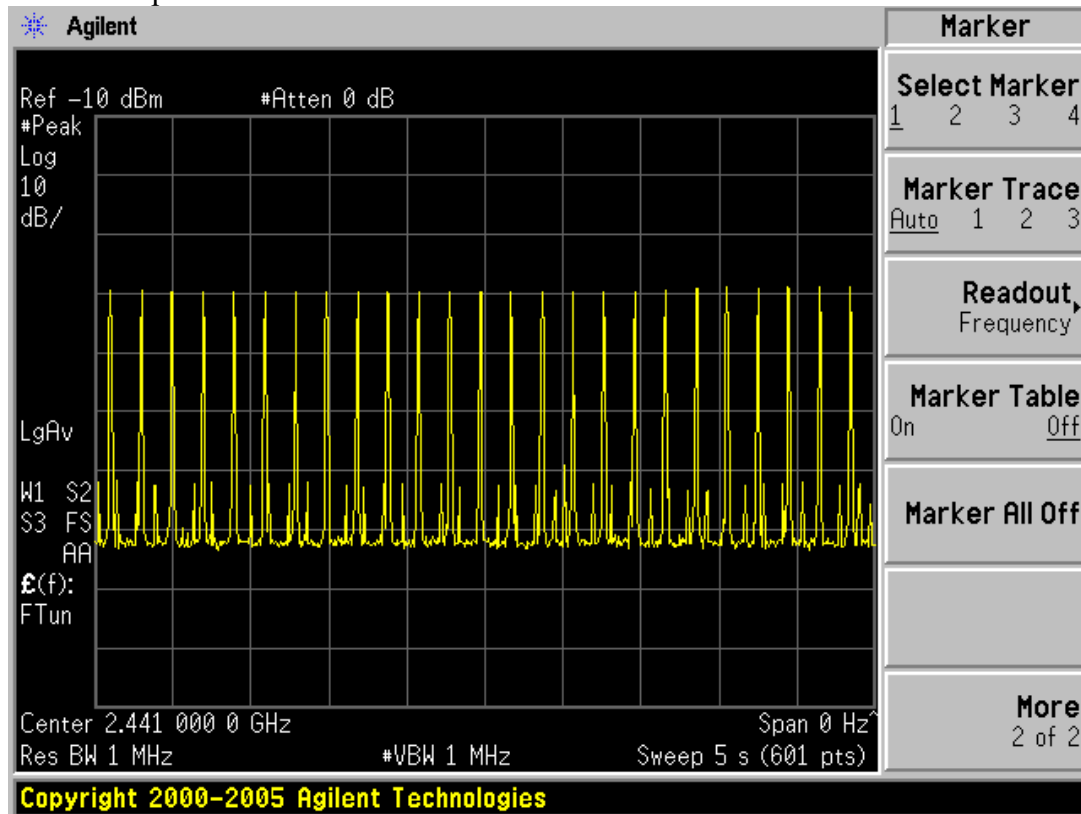

DH5: 16hop/5s*0.4*79*2.95ms=298.30ms

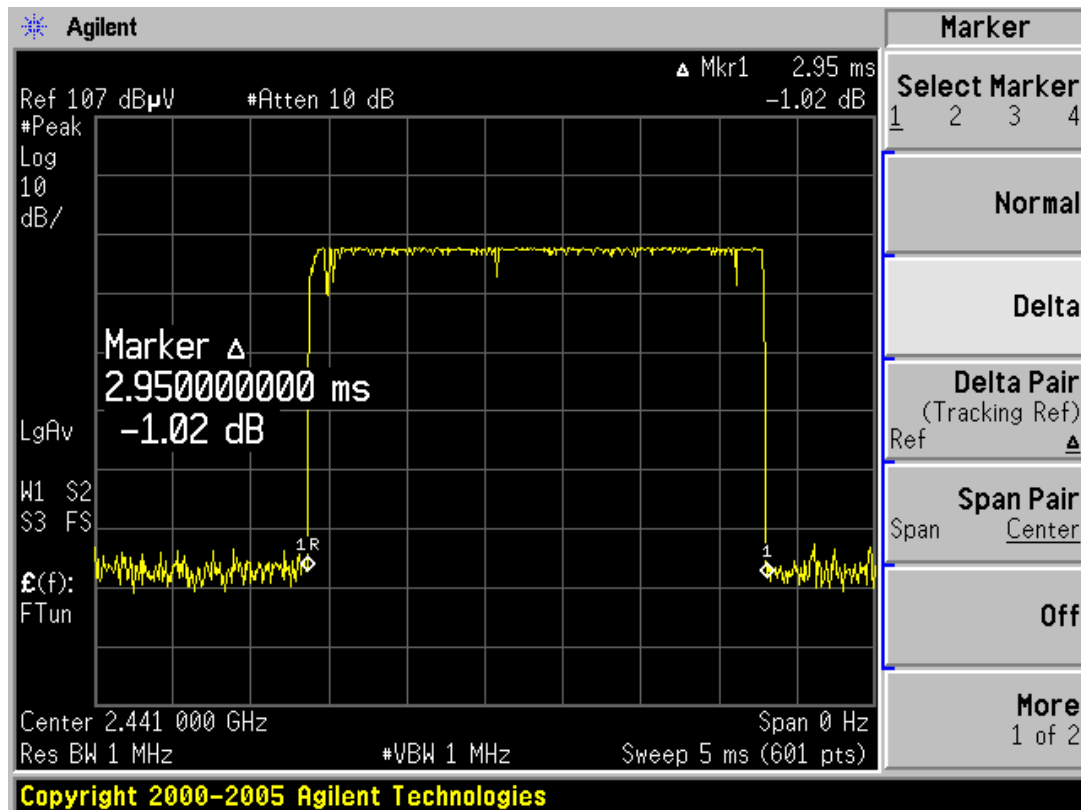
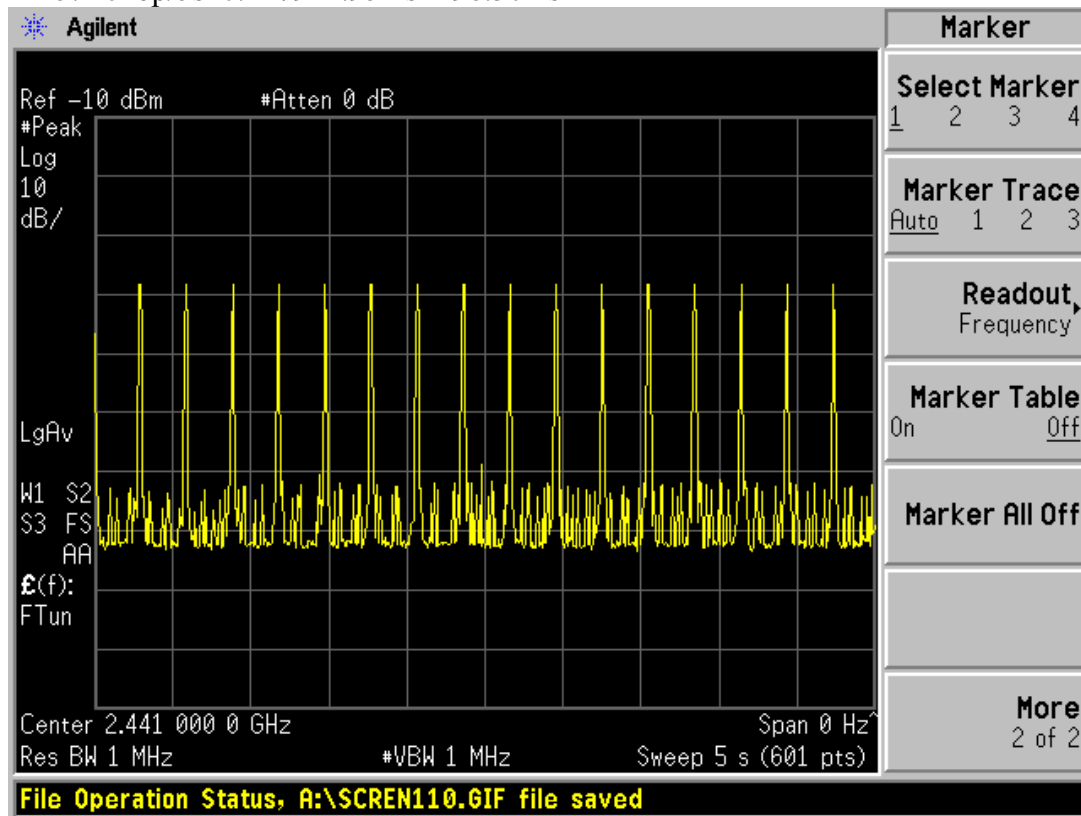

3-DH1: $50\text{hop}/5*0.4*79*0.44\text{ms}=139.04\text{ms}$

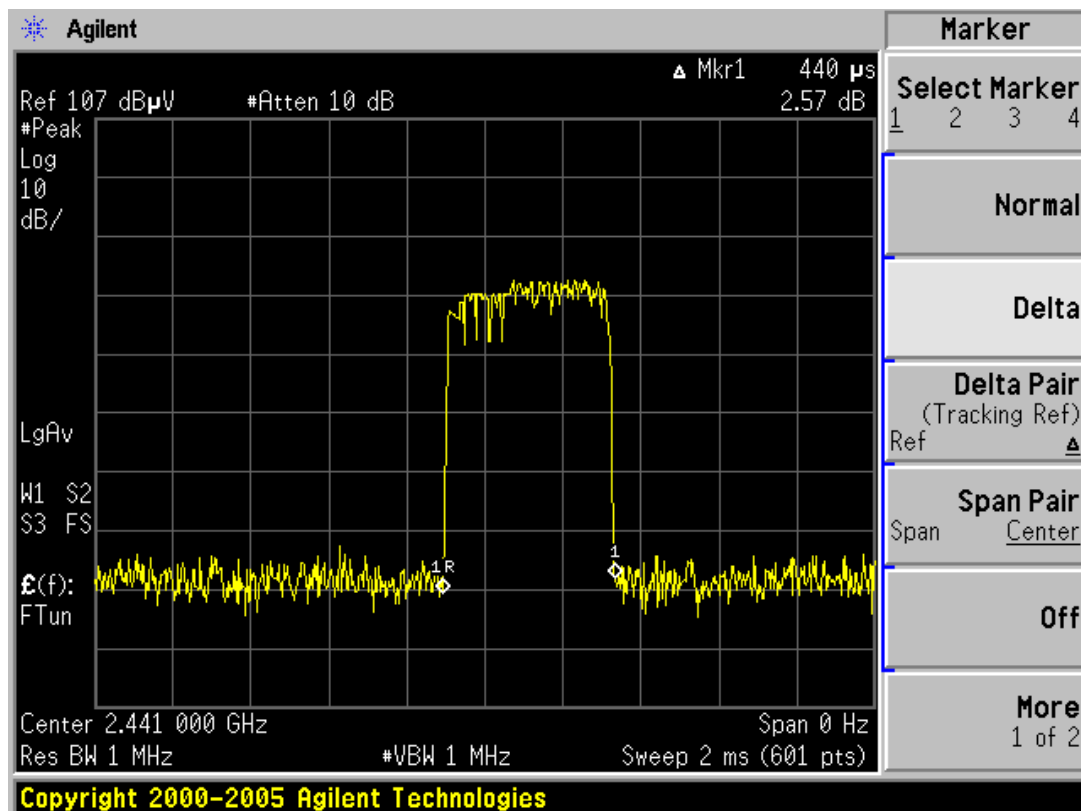
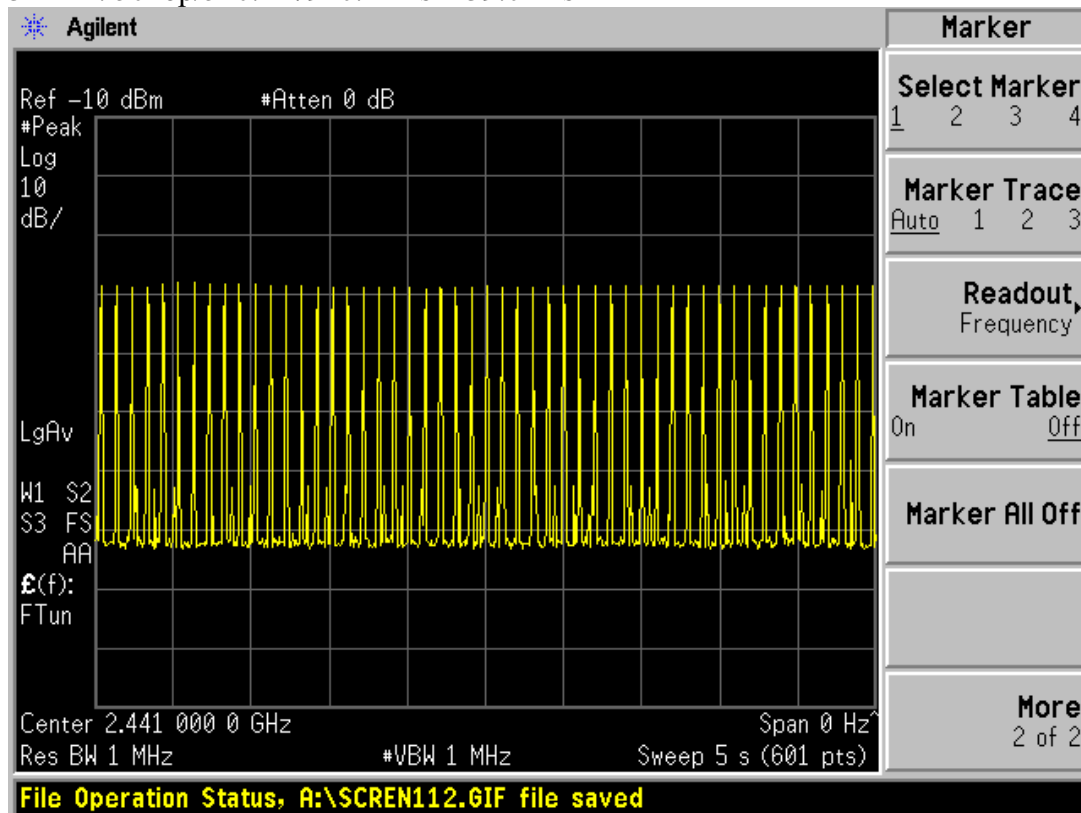

3-DH3: 25hop/5*0.4*79*1.70ms=268.60ms

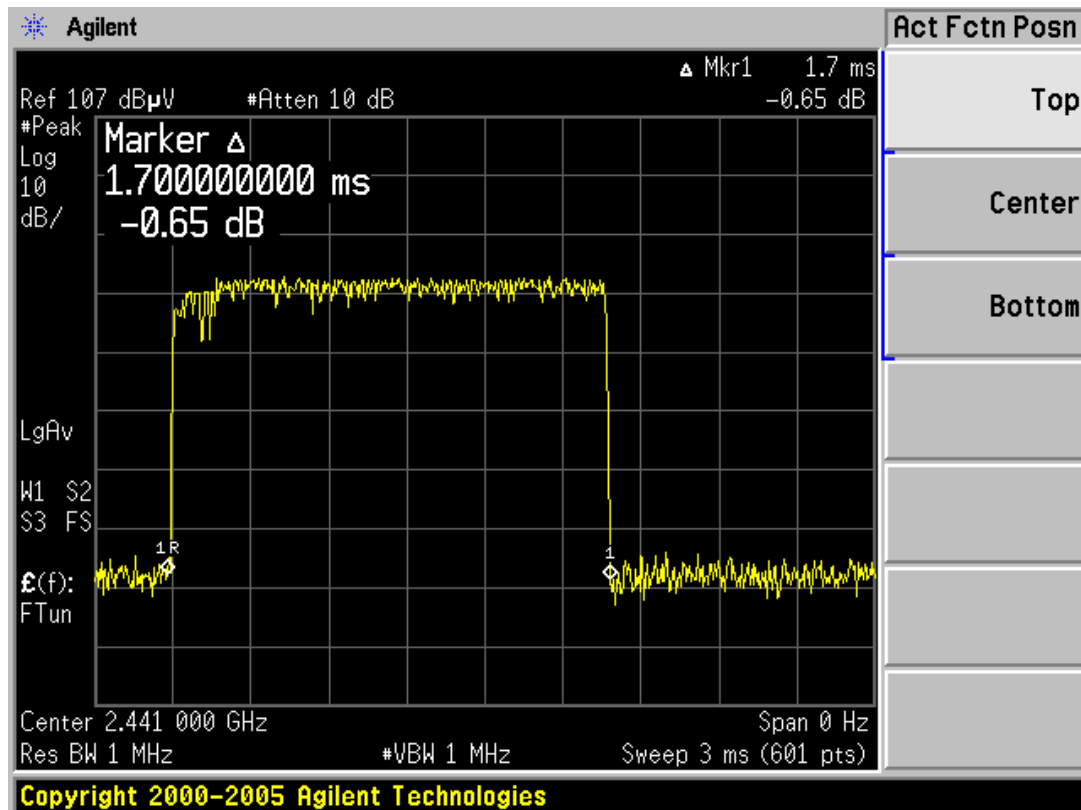
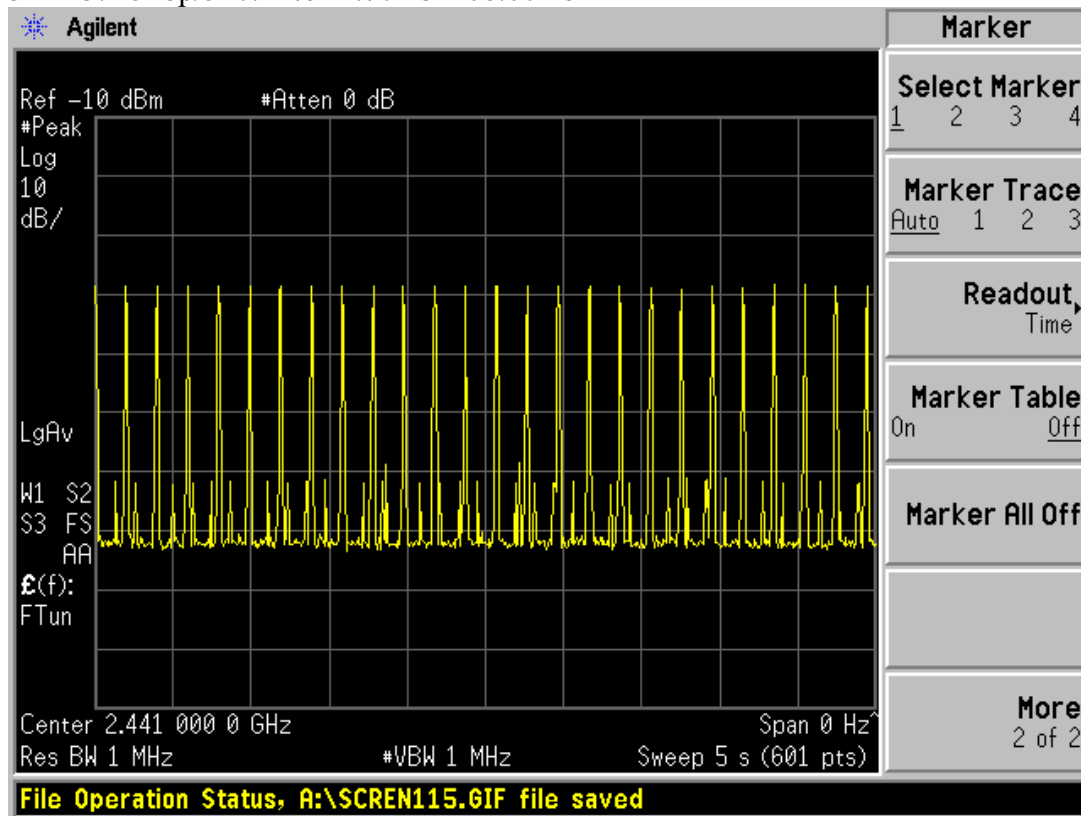

3-DH5: $16\text{hop}/5 * 0.4 * 79 * 3.05 = 308.41\text{ms}$

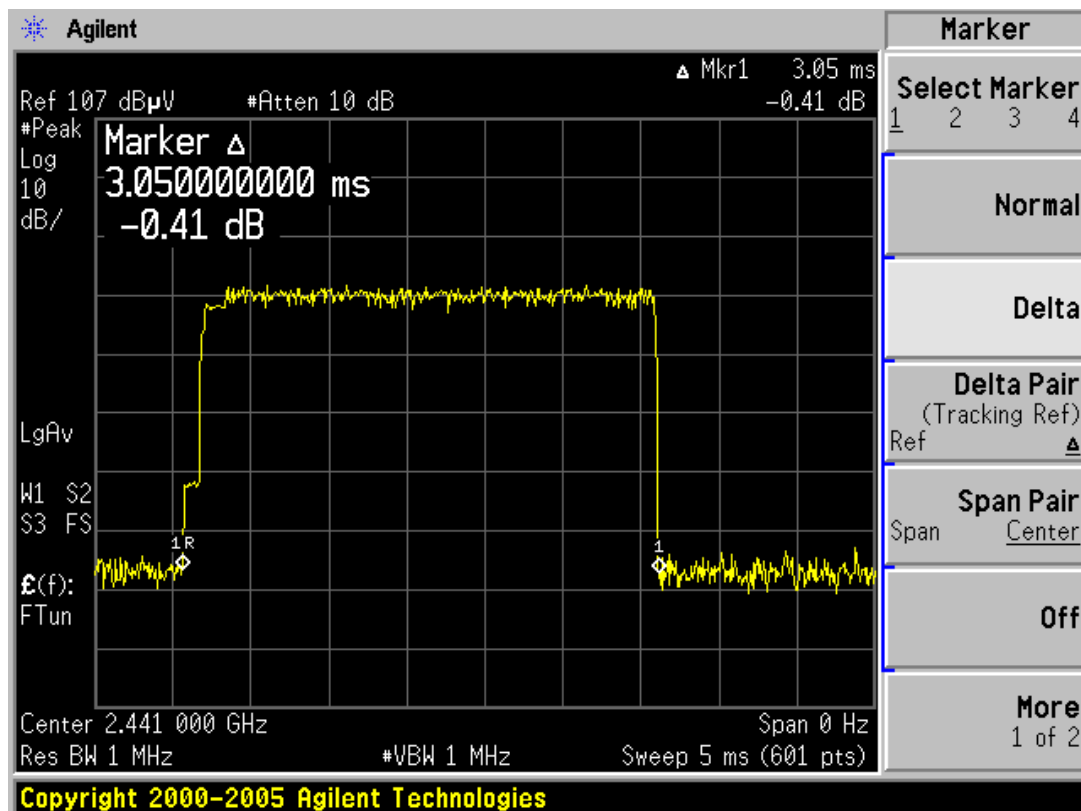
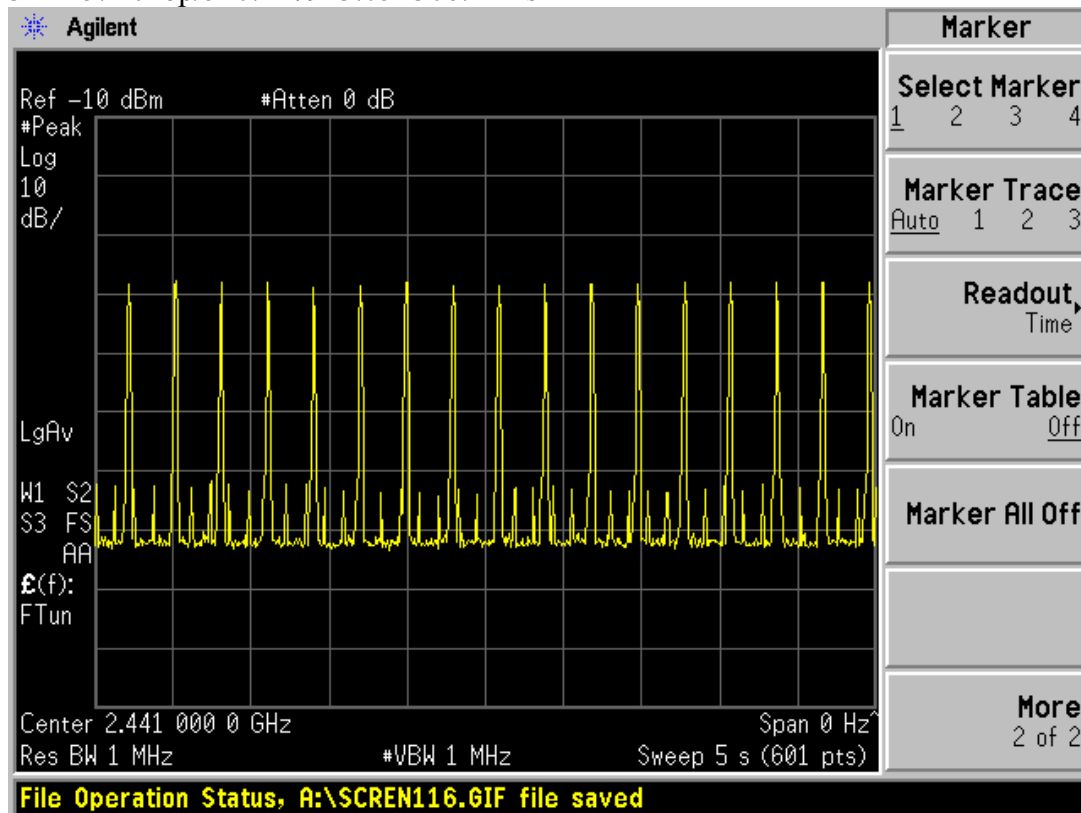

8. Radiated emission

8.1. Test equipment

Item	Equipment	Manufacturer	Model No.	Serial No.	Last Cal.	Cal. Interval
1	EMI Test Receiver	R&S	ESU8	100316	2011/11/23	1Y
2	Spectrum analyzer	R&S	FSU	1166.1660.26	2011/11/23	1Y
3	Trilog Broadband Antenna	Schwarzbeck	VULB9163	9163-462	2010/11/09	2 Y
4	Double Ridged Horn Antenna	R&S	HF907	100276	2011/01/16	2 Y
5	Pre-Amplifier	R&S	SCU-01	10049	2011/11/23	1Y
6	Pre-amplifier	A.H.	PAM0-0118	360	2011-12-20	1Y
7	RF Cable	R&S	R01	10403	2011/11/23	1Y
8	RF Cable	R&S	R02	10512	2011/11/23	1Y
9	Test software	R&S	EMC32	/	/	/

8.2. Block diagram of test setup

In 3m Anechoic Chamber Test Setup Diagram for below 1GHz

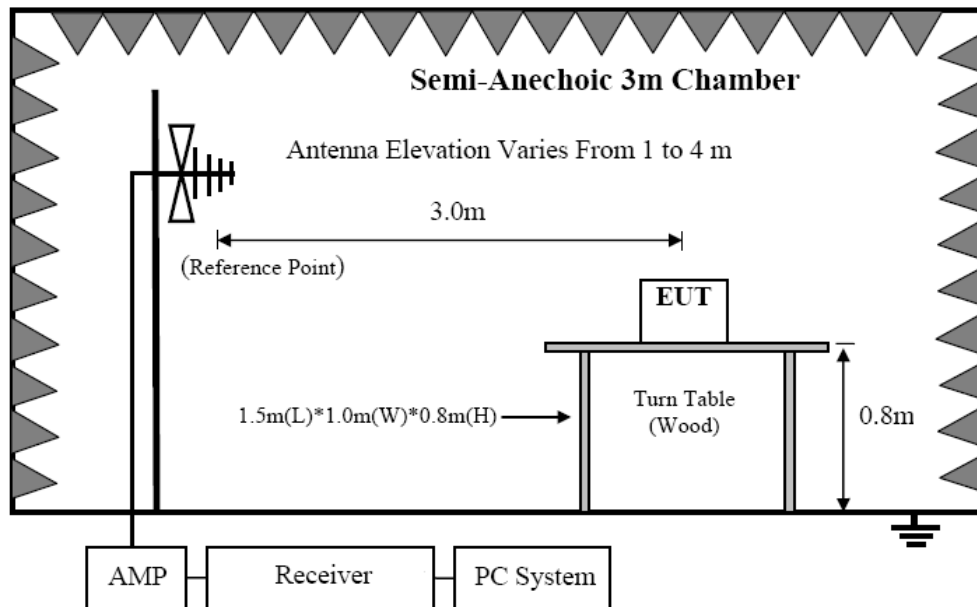

In 3m Anechoic Chamber Test Setup Diagram for frequency above 1GHz

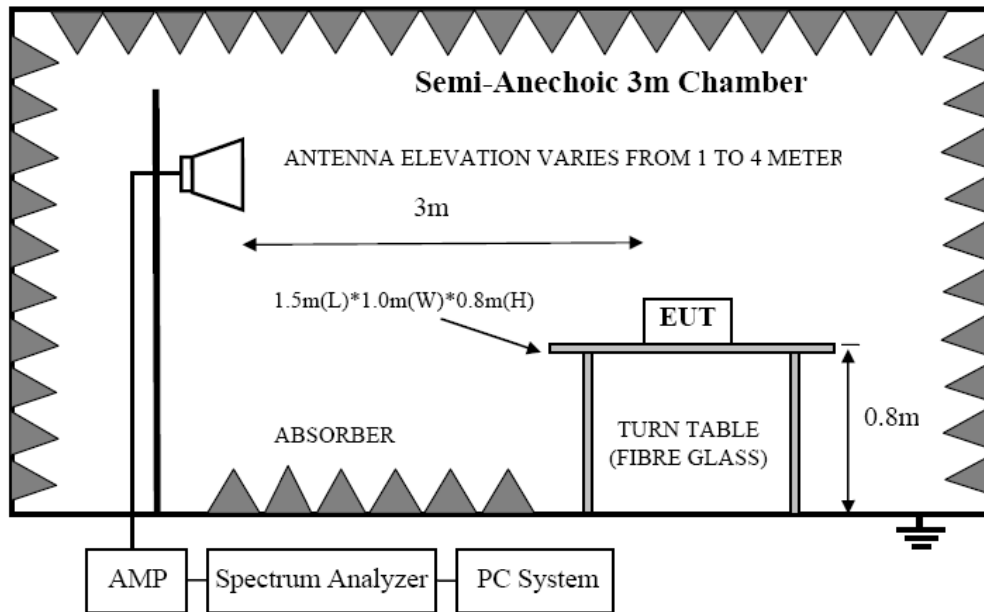

Note: For harmonic emissions test a appropriate high pass filter was inserted in the input port of AMP.

8.3. Limit

8.3.1 FCC 15.205 Restricted frequency band

MHz	MHz	MHz	GHz
0.090 - 0.110	16.42 - 16.423	399.9 - 410	4.5 - 5.15
¹ 0.495 - 0.505	16.69475 - 16.69525	608 - 614	5.35 - 5.46
2.1735 - 2.1905	16.80425 - 16.80475	960 - 1240	7.25 - 7.75
4.125 - 4.128	25.5 - 25.67	1300 - 1427	8.025 - 8.5
4.17725 - 4.17775	37.5 - 38.25	1435 - 1626.5	9.0 - 9.2
4.20725 - 4.20775	73 - 74.6	1645.5 - 1646.5	9.3 - 9.5
6.215 - 6.218	74.8 - 75.2	1660 - 1710	10.6 - 12.7
6.26775 - 6.26825	108 - 121.94	1718.8 - 1722.2	13.25 - 13.4
6.31175 - 6.31225	123 - 138	2200 - 2300	14.47 - 14.5
8.291 - 8.294	149.9 - 150.05	2310 - 2390	15.35 - 16.2
8.362 - 8.366	156.52475 - 156.52525	2483.5 - 2500	17.7 - 21.4
8.37625 - 8.38675	156.7 - 156.9	2690 - 2900	22.01 - 23.12
8.41425 - 8.41475	162.0125 - 167.17	3260 - 3267	23.6 - 24.0
12.29 - 12.293	167.72 - 173.2	3332 - 3339	31.2 - 31.8
12.51975 - 12.52025	240 - 285	3345.8 - 3358	36.43 - 36.5
12.57675 - 12.57725	322 - 335.4	3600 - 4400	(²)

8.3.2 FCC 15.209 Limit

FREQUENCY MHz	DISTANCE Meters	FIELD STRENGTHS LIMIT	
		μV/m	dB(μV)/m
30 ~ 88	3	100	40.0
88 ~ 216	3	150	43.5
216 ~ 960	3	200	46.0
960 ~ 1000	3	500	54.0

Above 1000	3	74.0 dB(μ V)/m (Peak) 54.0 dB(μ V)/m (Average)
------------	---	---

8.3.3 Limit for this EUT

All the emissions appearing within 15.205 restricted frequency bands shall not exceed the limits shown in 15.209, all the other emissions shall be at least 20dB below the fundamental emissions, or comply with 15.209 limits.

8.4. Test Procedure

- (1) EUT was placed on a non-metallic table, 80 cm above the ground plane inside a semi-anechoic chamber.
- (2) Setup EUT and assistant system according clause 2.4 and 8.2
- (3) Test antenna was located 3m from the EUT on an adjustable mast. Below pre-scan procedure was first performed in order to find prominent radiated emissions.
 - (a) Change work frequency or channel of device if practicable.
 - (b) Change modulation type of device if practicable.
 - (c) Change power supply range from 85% to 115% of the rated supply voltage
 - (d) Rotated EUT though three orthogonal axes to determine the attitude of EUT arrangement produces highest emissions
- (4) Spectrum frequency from 9MHz to 25GHz (tenth harmonic of fundamental frequency) was investigated, and no any obvious emission were detected from 9KHz to 30MHz and 18GHz to 25GHz, so below final test was performed with frequency range from 30MHz to 18GHz.
- (5) For final emissions measurements at each frequency of interest, the EUT were rotated and the antenna height was varied between 1m and 4m in order to maximize the emission. Measurements in both horizontal and vertical polarities were made and the data was recorded. In order to find the maximum emission, the relative positions of equipments and all of the interface cables were changed according to ANSI C63.10 2009 on Radiated Emission test.
- (6) For emissions from 30MHz to 1GHz, Quasi-Peak values were measured with EMI Receiver and the bandwidth of Receiver is 120 KHz.
- (7) For emissions above 1GHz, both Peak and Average level were measured with Spectrum Analyzer, and the RBW is set at 1MHz, VBW is set at 3MHz for Peak measure; RBW is set at 1MHz, VBW is set at 10Hz for Average measure.
- (8) For emissions below 1GHz, according explorer test, when change Tx mode and channel, have no distinct influence on emissions level, so for emissions below 1GHz, the final test was only performed with EUT working in GFSK, Tx 2440MHz mode.

8.5. Test result

PASS. (See below detailed test result)

All the emissions except fundamental emission from 9KHz to 25GHz were comply with 15.209 limit.

Radiated Emission Test Result

Test Site	: 3m Chamber	E:\D\12Q0017\ACSH216.EM6
Test Date	: 2012/05/02	Tested By : TaTa Chen
EUT	: BLUETOOTH SPEAKER	Model Number : B3D
Power Supply	: DC 5V from PC	Test Mode : Tx Mode
Condition	: Temp:24.5°C,Humi:55%	Antenna/Distance : VULB 9163/3m/VERTICAL

Data: 5

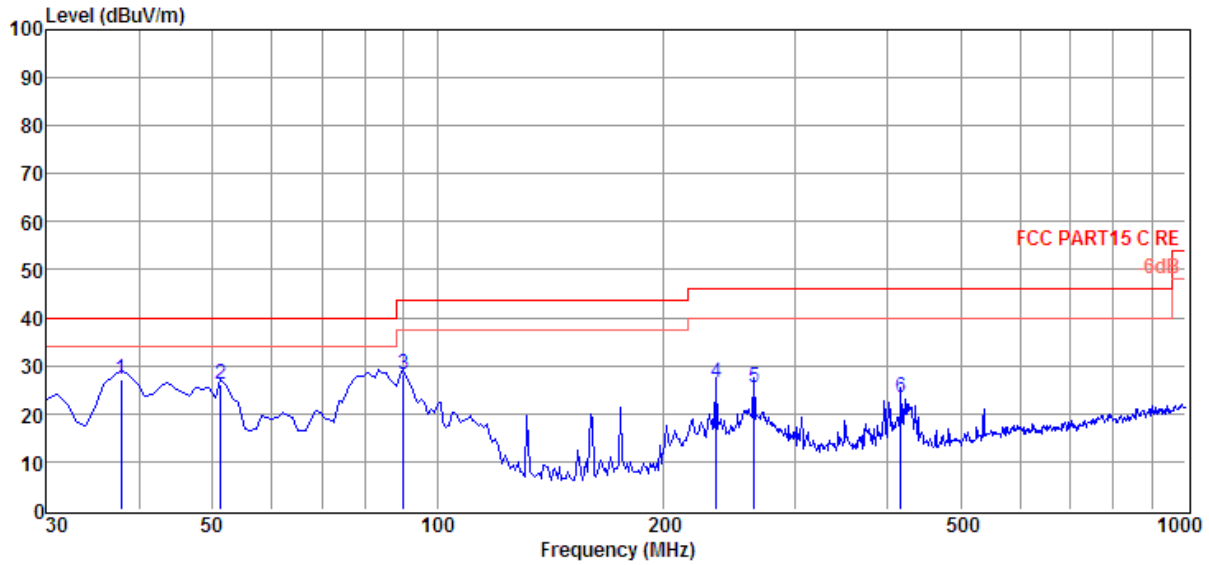

Item (Mark)	Freq (MHz)	Read Level (dBμV)	Antenna Factor (dB/m)	PRM Factor dB	Cable Loss dB	Result Level (dBμV/m)	Limit Line (dBμV/m)	Over Limit (dB)	Detector	Polarization
1	37.76	58.20	12.30	43.95	0.71	27.26	40.00	-12.74	QP	VERTICAL
2	51.34	56.21	13.14	43.90	0.83	26.28	40.00	-13.72	QP	VERTICAL
3	90.14	58.79	11.90	43.76	1.13	28.06	43.50	-15.44	QP	VERTICAL
4	235.64	56.33	11.91	43.69	1.87	26.42	46.00	-19.58	QP	VERTICAL
5	264.74	54.78	12.17	43.69	2.09	25.35	46.00	-20.65	QP	VERTICAL
6	416.06	48.83	15.39	43.53	2.62	23.31	46.00	-22.69	QP	VERTICAL

Note1: Result Level = Read Level + Antenna Factor + Cable loss - PRM Factor

Radiated Emission Test Result

Test Site	: 3m Chamber	E:\D\12Q0017\ACSH216.EM6
Test Date	: 2012/05/02	Tested By : TaTa Chen
EUT	: BLUETOOTH SPEAKER	Model Number : B3D
Power Supply	: DC 5V from PC	Test Mode : Tx Mode
Condition	: Temp:24.5°C,Humi:55%	Antenna/Distance : VULB 9163/3m/HORIZONTAL

Data: 6

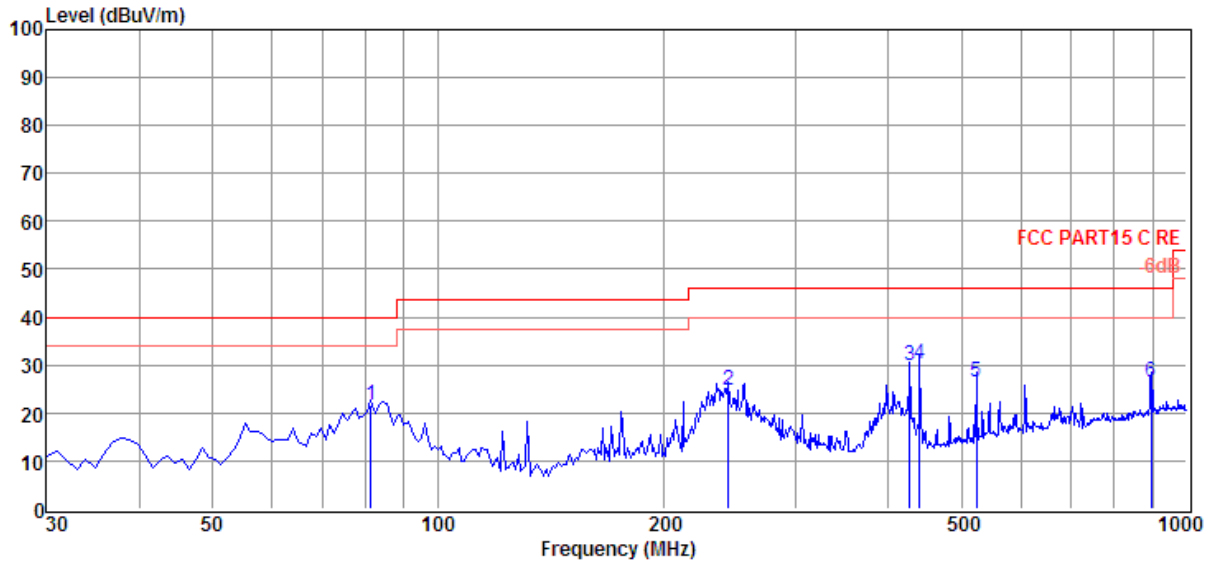

Item (Mark)	Freq (MHz)	Read Level (dBμV)	Antenna Factor (dB/m)	PRM Factor dB	Cable Loss dB	Result Level (dBμV/m)	Limit Line (dBμV/m)	Over Limit (dB)	Detector	Polarization
1	81.41	55.95	8.54	43.78	1.07	21.78	40.00	-18.22	QP	HORIZONTAL
2	244.37	54.31	12.08	43.69	1.92	24.62	46.00	-21.38	QP	HORIZONTAL
3	426.73	55.07	15.51	43.50	2.65	29.73	46.00	-16.27	QP	HORIZONTAL
4	440.31	55.56	15.56	43.44	2.70	30.38	46.00	-15.62	QP	HORIZONTAL
5	523.73	49.45	17.01	43.11	3.01	26.36	46.00	-19.64	QP	HORIZONTAL
6	896.21	45.15	21.05	43.89	4.16	26.47	46.00	-19.53	QP	HORIZONTAL

Note1: Result Level = Read Level + Antenna Factor + Cable loss - PRM Factor

Radiated Emission Test Result

Test Site	: 3m Chamber	E:\D\12Q0017\ACSH216.EM6
Test Date	: 2012/05/02	Tested By : TaTa Chen
EUT	: BLUETOOTH SPEAKER	Model Number : B3D
Power Supply	: DC 5V from PC	Test Mode : GFSK Tx 2402MHz
Condition	: 23°C/54%	Antenna/Distance : 3115(0911)/3m/VERTICAL

Data: 1

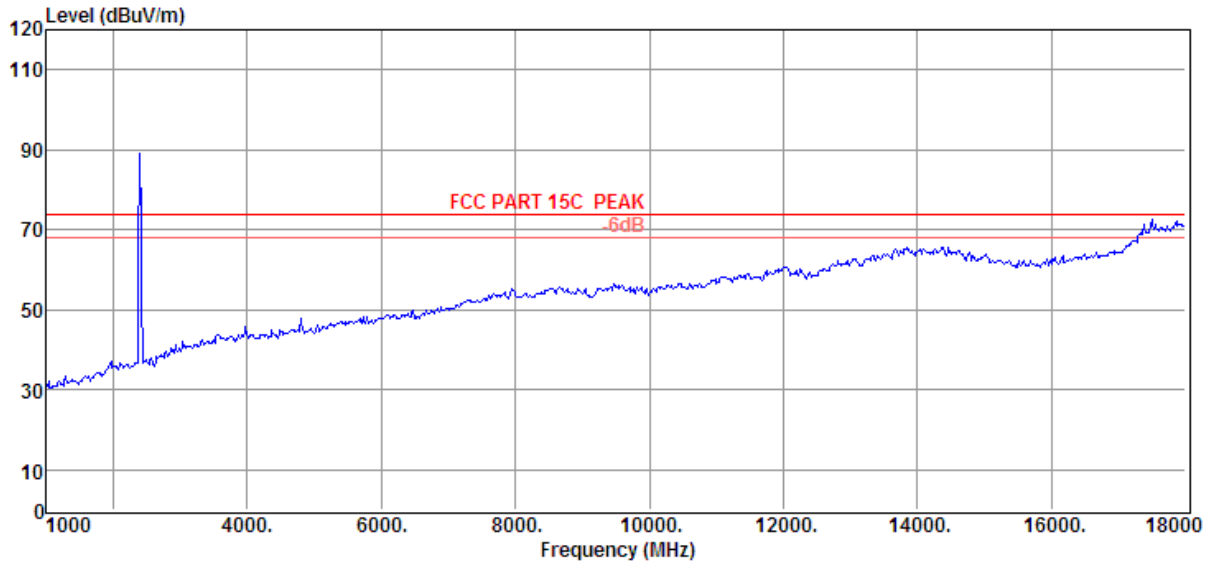

Item	Freq	Read Level	Antenna Factor	PRM Factor	Cable Loss	Result Level	Limit Line	Over Limit	Detector	Polarization
(Mark)	(MHz)	(dBμV)	(dB/m)	dB	dB	(dBμV/m)	(dBμV/m)	(dB)		

Note1: Result Level = Read Level + Antenna Factor + Cable loss - PRM Factor

Note2: If Peak Result complies with AV limit, AV Result is deemed to comply with AV limit

Radiated Emission Test Result

Test Site	: 3m Chamber	E:\D\12Q0017\ACSH216.EM6
Test Date	: 2012/05/02	Tested By : TaTa Chen
EUT	: BLUETOOTH SPEAKER	Model Number : B3D
Power Supply	: DC 5V from PC	Test Mode : GFSK Tx 2402MHz
Condition	: 23°C/54%	Antenna/Distance : 3115(0911)/3m/VERTICAL

Data: 2

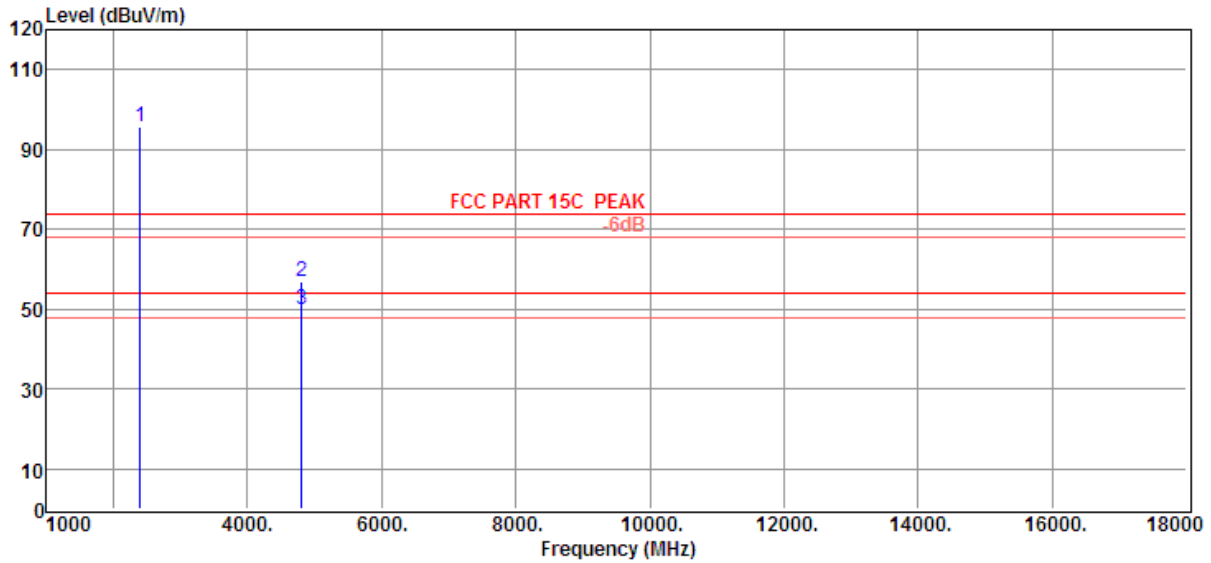

Item (Mark)	Freq (MHz)	Read Level (dBμV)	Antenna Factor (dB/m)	PRM Factor dB	Cable Loss dB	Result Level (dBμV/m)	Limit Line (dBμV/m)	Over Limit (dB)	Detector	Polarization
1	2402.00	95.58	29.44	36.62	7.43	95.83	74.00	21.83	Peak	VERTICAL
2	4804.00	47.27	34.30	35.10	10.62	57.09	74.00	-16.91	Peak	VERTICAL
3	4804.00	40.07	34.30	35.10	10.62	49.89	54.00	-4.11	Average	VERTICAL

Note1: Result Level = Read Level + Antenna Factor + Cable loss - PRM Factor

Note2: If Peak Result complies with AV limit, AV Result is deemed to comply with AV limit

Radiated Emission Test Result

Test Site	: 3m Chamber	E:\D\12Q0017\ACSH216.EM6
Test Date	: 2012/05/02	Tested By : TaTa Chen
EUT	: BLUETOOTH SPEAKER	Model Number : B3D
Power Supply	: DC 5V from PC	Test Mode : GFSK Tx 2402MHz
Condition	: 23°C/54%	Antenna/Distance : 3115(0911)/3m/HORIZONTAL

Data: 3

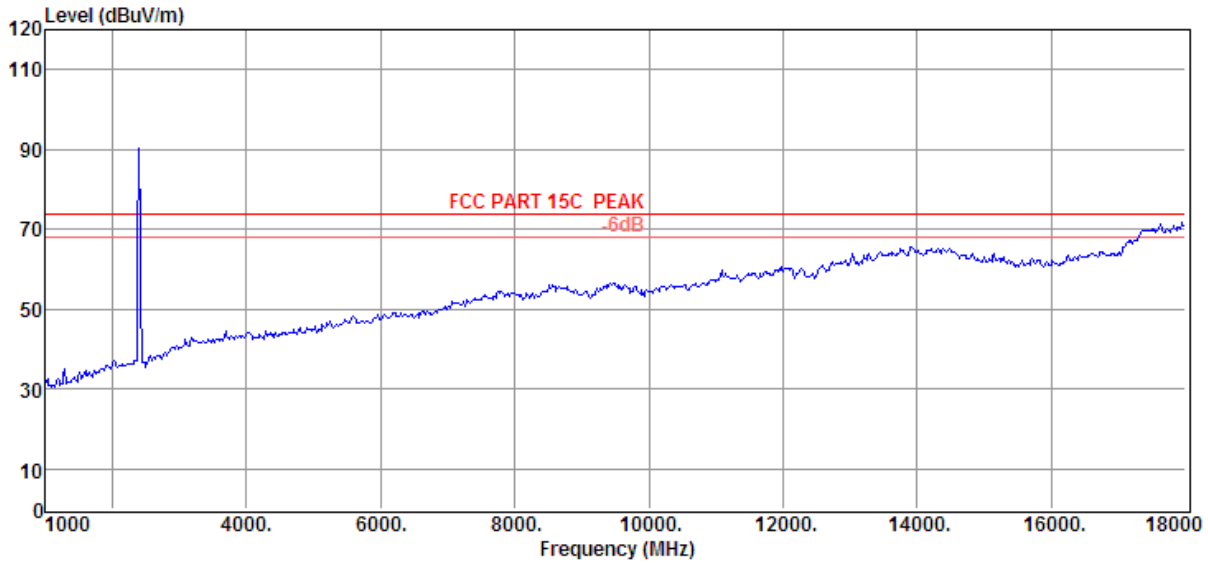

Item	Freq	Read Level	Antenna Factor	PRM Factor	Cable Loss	Result Level	Limit Line	Over Limit	Detector	Polarization
(Mark)	(MHz)	(dBμV)	(dB/m)	dB	dB	(dBμV/m)	(dBμV/m)	(dB)		

Note1: Result Level = Read Level + Antenna Factor + Cable loss - PRM Factor

Note2: If Peak Result complies with AV limit, AV Result is deemed to comply with AV limit

Radiated Emission Test Result

Test Site	: 3m Chamber	E:\D\12Q0017\ACSH216.EM6
Test Date	: 2012/05/02	Tested By : TaTa Chen
EUT	: BLUETOOTH SPEAKER	Model Number : B3D
Power Supply	: DC 5V from PC	Test Mode : GFSK Tx 2402MHz
Condition	: 23*C/54%	Antenna/Distance : 3115(0911)/3m/HORIZONTAL

Data: 4

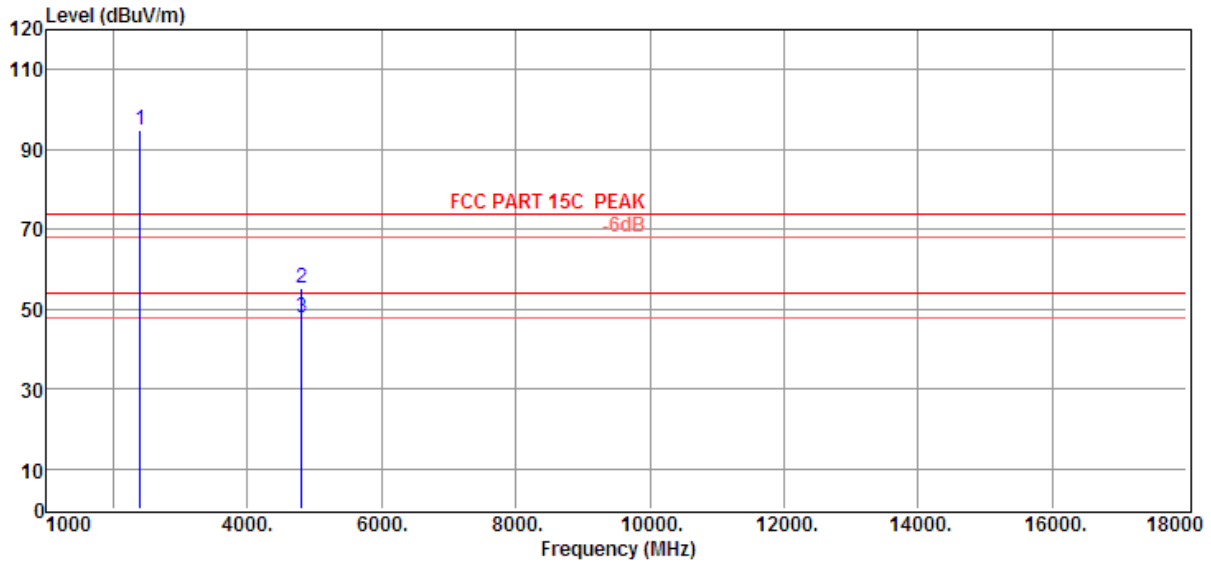

Item (Mark)	Freq (MHz)	Read Level (dBμV)	Antenna Factor (dB/m)	PRM Factor dB	Cable Loss dB	Result Level (dBμV/m)	Limit Line (dBμV/m)	Over Limit (dB)	Detector	Polarization
1	2402.00	94.50	29.44	36.62	7.43	94.75	74.00	20.75	Peak	HORIZONTAL
2	4804.00	45.25	34.30	35.10	10.62	55.07	74.00	-18.93	Peak	HORIZONTAL
3	4804.00	38.05	34.30	35.10	10.62	47.87	54.00	-6.13	Average	HORIZONTAL

Note1: Result Level = Read Level + Antenna Factor + Cable loss - PRM Factor

Note2: If Peak Result complies with AV limit, AV Result is deemed to comply with AV limit

Radiated Emission Test Result

Test Site	: 3m Chamber	E:\D\12Q0017\ACSH216.EM6
Test Date	: 2012/05/02	Tested By : TaTa Chen
EUT	: BLUETOOTH SPEAKER	Model Number : B3D
Power Supply	: DC 5V from PC	Test Mode : GFSK Tx 2441MHz
Condition	: 23*C/54%	Antenna/Distance : 3115(0911)/3m/HORIZONTAL

Data: 5

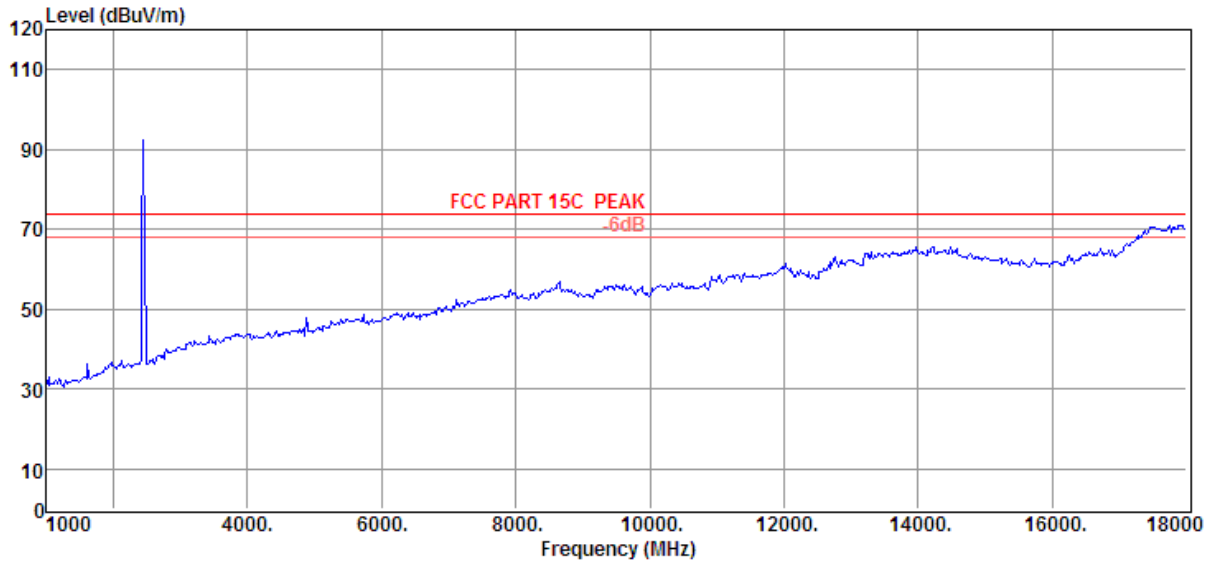

Item	Freq	Read Level	Antenna Factor	PRM Factor	Cable Loss	Result Level	Limit Line	Over Limit	Detector	Polarization
(Mark)	(MHz)	(dBμV)	(dB/m)	dB	dB	(dBμV/m)	(dBμV/m)	(dB)		

Note1: Result Level = Read Level + Antenna Factor + Cable loss - PRM Factor

Note2: If Peak Result complies with AV limit, AV Result is deemed to comply with AV limit

Radiated Emission Test Result

Test Site	: 3m Chamber	E:\D\12Q0017\ACSH216.EM6
Test Date	: 2012/05/02	Tested By : TaTa Chen
EUT	: BLUETOOTH SPEAKER	Model Number : B3D
Power Supply	: DC 5V from PC	Test Mode : GFSK Tx 2441MHz
Condition	: 23*C/54%	Antenna/Distance : 3115(0911)/3m/HORIZONTAL

Data: 6

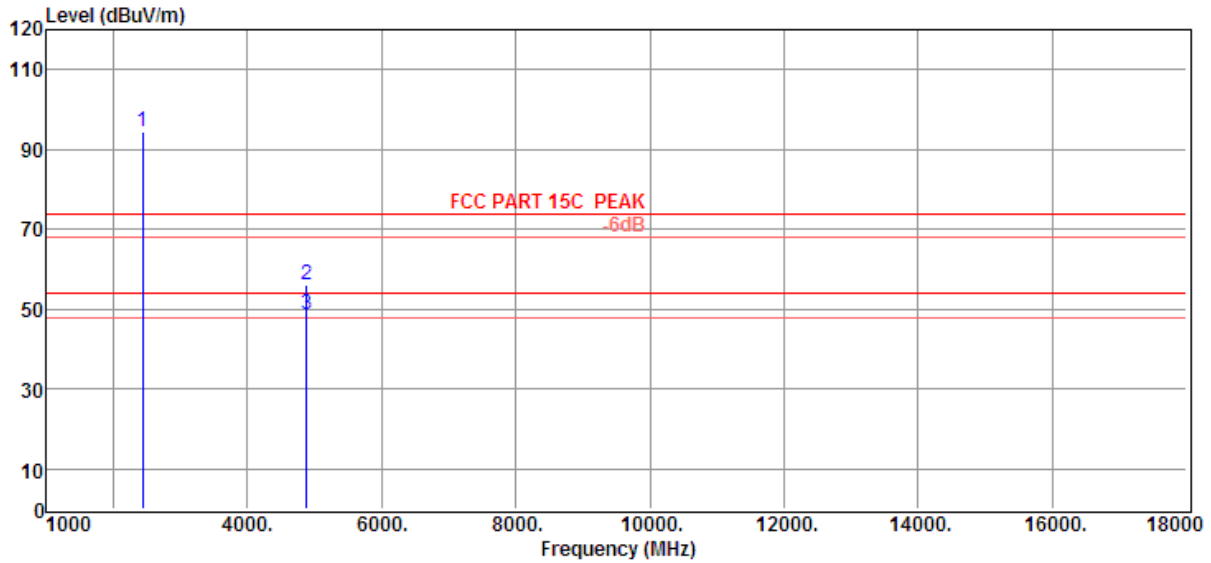

Item (Mark)	Freq (MHz)	Read Level (dBμV)	Antenna Factor (dB/m)	PRM Factor dB	Cable Loss dB	Result Level (dBμV/m)	Limit Line (dBμV/m)	Over Limit (dB)	Detector	Polarization
1	2441.00	94.05	29.47	36.61	7.50	94.41	74.00	20.41	Peak	HORIZONTAL
2	4882.00	45.85	34.41	35.03	10.71	55.94	74.00	-18.06	Peak	HORIZONTAL
3	4882.00	38.65	34.41	35.03	10.71	48.74	54.00	-5.26	Average	HORIZONTAL

Note1: Result Level = Read Level + Antenna Factor + Cable loss - PRM Factor

Note2: If Peak Result complies with AV limit, AV Result is deemed to comply with AV limit

Radiated Emission Test Result

Test Site	: 3m Chamber	E:\D\12Q0017\ACSH216.EM6
Test Date	: 2012/05/02	Tested By : TaTa Chen
EUT	: BLUETOOTH SPEAKER	Model Number : B3D
Power Supply	: DC 5V from PC	Test Mode : GFSK Tx 2441MHz
Condition	: 23*C/54%	Antenna/Distance : 3115(0911)/3m/VERTICAL

Data: 7

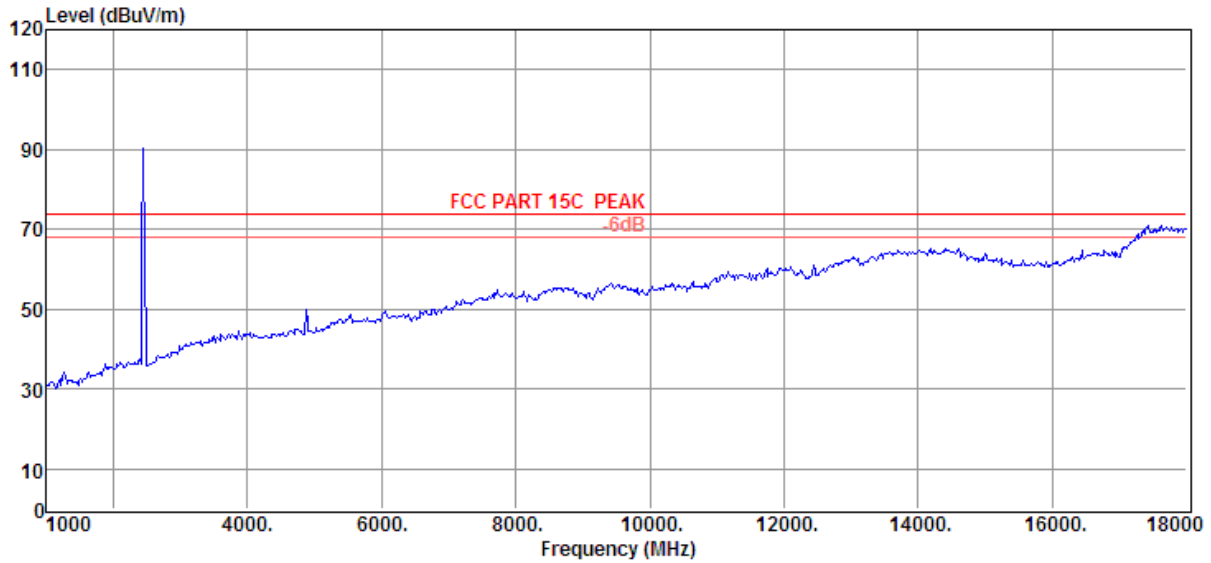

Item	Freq	Read Level	Antenna Factor	PRM Factor	Cable Loss	Result Level	Limit Line	Over Limit	Detector	Polarization
(Mark)	(MHz)	(dBμV)	(dB/m)	dB	dB	(dBμV/m)	(dBμV/m)	(dB)		

Note1: Result Level = Read Level + Antenna Factor + Cable loss - PRM Factor

Note2: If Peak Result complies with AV limit, AV Result is deemed to comply with AV limit

Radiated Emission Test Result

Test Site	: 3m Chamber	E:\D\12Q0017\ACSH216.EM6
Test Date	: 2012/05/02	Tested By : TaTa Chen
EUT	: BLUETOOTH SPEAKER	Model Number : B3D
Power Supply	: DC 5V from PC	Test Mode : GFSK Tx 2441MHz
Condition	: 23*C/54%	Antenna/Distance : 3115(0911)/3m/VERTICAL

Data: 8

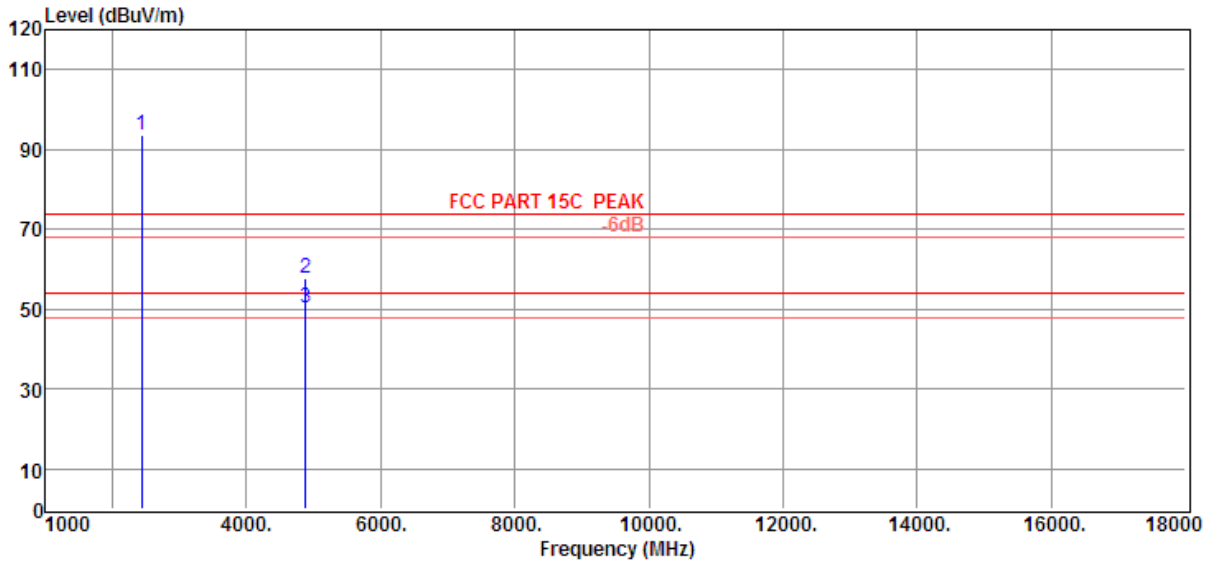

Item (Mark)	Freq (MHz)	Read Level (dBμV)	Antenna Factor (dB/m)	PRM Factor dB	Cable Loss dB	Result Level (dBμV/m)	Limit Line (dBμV/m)	Over Limit (dB)	Detector	Polarization
1	2441.00	93.40	29.47	36.61	7.50	93.76	74.00	19.76	Peak	VERTICAL
2	4882.00	47.63	34.41	35.03	10.71	57.72	74.00	-16.28	Peak	VERTICAL
3	4882.00	40.40	34.41	35.03	10.71	50.49	54.00	-3.51	Average	VERTICAL

Note1: Result Level = Read Level + Antenna Factor + Cable loss - PRM Factor

Note2: If Peak Result complies with AV limit, AV Result is deemed to comply with AV limit

Radiated Emission Test Result

Test Site	: 3m Chamber	E:\D\12Q0017\ACSH216.EM6
Test Date	: 2012/05/02	Tested By : TaTa Chen
EUT	: BLUETOOTH SPEAKER	Model Number : B3D
Power Supply	: DC 5V from PC	Test Mode : GFSK Tx 2480MHz
Condition	: 23°C/54%	Antenna/Distance : 3115(0911)/3m/VERTICAL

Data: 9

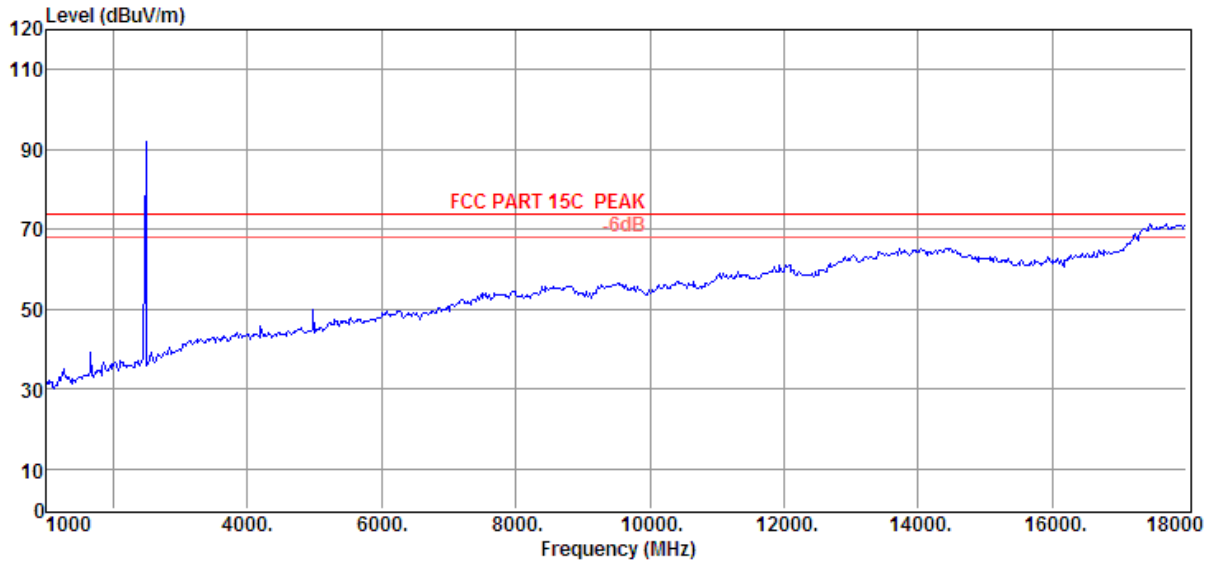

Item	Freq	Read Level	Antenna Factor	PRM Factor	Cable Loss	Result Level	Limit Line	Over Limit	Detector	Polarization
(Mark)	(MHz)	(dBμV)	(dB/m)	dB	dB	(dBμV/m)	(dBμV/m)	(dB)		

Note1: Result Level = Read Level + Antenna Factor + Cable loss - PRM Factor

Note2: If Peak Result complies with AV limit, AV Result is deemed to comply with AV limit

Radiated Emission Test Result

Test Site : 3m Chamber	E:\D\12Q0017\ACSH216.EM6
Test Date : 2012/05/02	Tested By : TaTa Chen
EUT : BLUETOOTH SPEAKER	Model Number : B3D
Power Supply : DC 5V from PC	Test Mode : GFSK Tx 2480MHz
Condition : 23°C/54%	Antenna/Distance : 3115(0911)/3m/VERTICAL

Data: 10

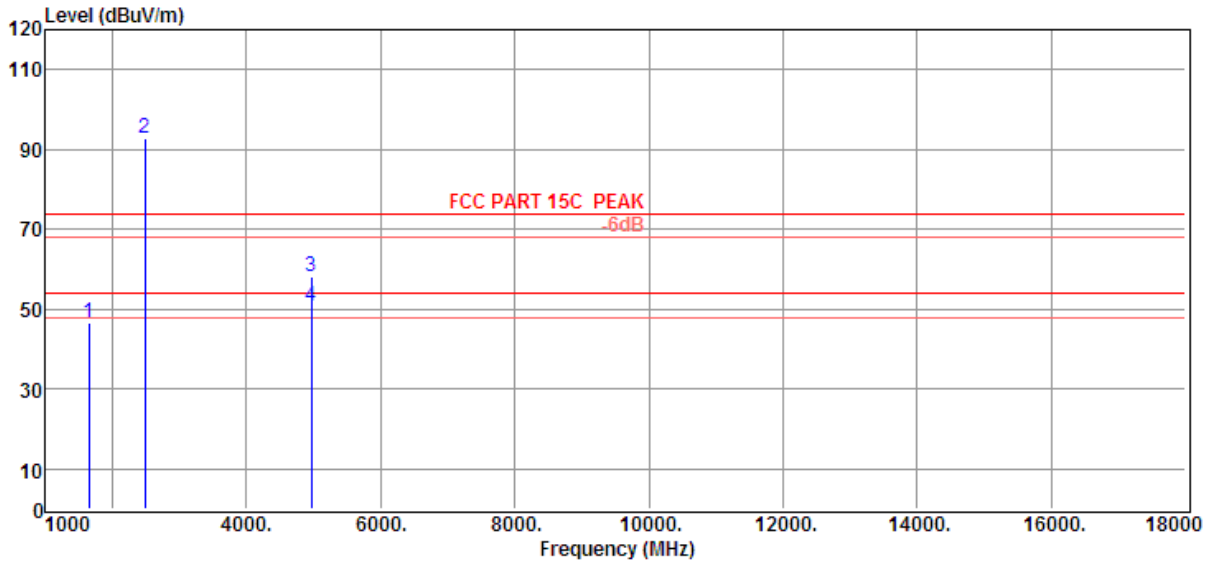

Item (Mark)	Freq (MHz)	Read Level (dBμV)	Antenna Factor (dB/m)	PRM Factor dB	Cable Loss dB	Result Level (dBμV/m)	Limit Line (dBμV/m)	Over Limit (dB)	Detector	Polarization
1	1646.00	57.97	26.61	43.35	5.24	46.47	74.00	-27.53	Peak	VERTICAL
2	2480.00	92.17	29.49	36.60	7.58	92.64	74.00	18.64	Peak	VERTICAL
3	4960.00	47.70	34.54	34.95	10.80	58.09	74.00	-15.91	Peak	VERTICAL
4	4960.00	40.48	34.54	34.95	10.80	50.87	54.00	-3.13	Average	VERTICAL

Note1: Result Level = Read Level + Antenna Factor + Cable loss - PRM Factor

Note2: If Peak Result complies with AV limit, AV Result is deemed to comply with AV limit

Radiated Emission Test Result

Test Site	: 3m Chamber	E:\D\12Q0017\ACSH216.EM6
Test Date	: 2012/05/02	Tested By : TaTa Chen
EUT	: BLUETOOTH SPEAKER	Model Number : B3D
Power Supply	: DC 5V from PC	Test Mode : GFSK Tx 2480MHz
Condition	: 23°C/54%	Antenna/Distance : 3115(0911)/3m/HORIZONTAL

Data: 11

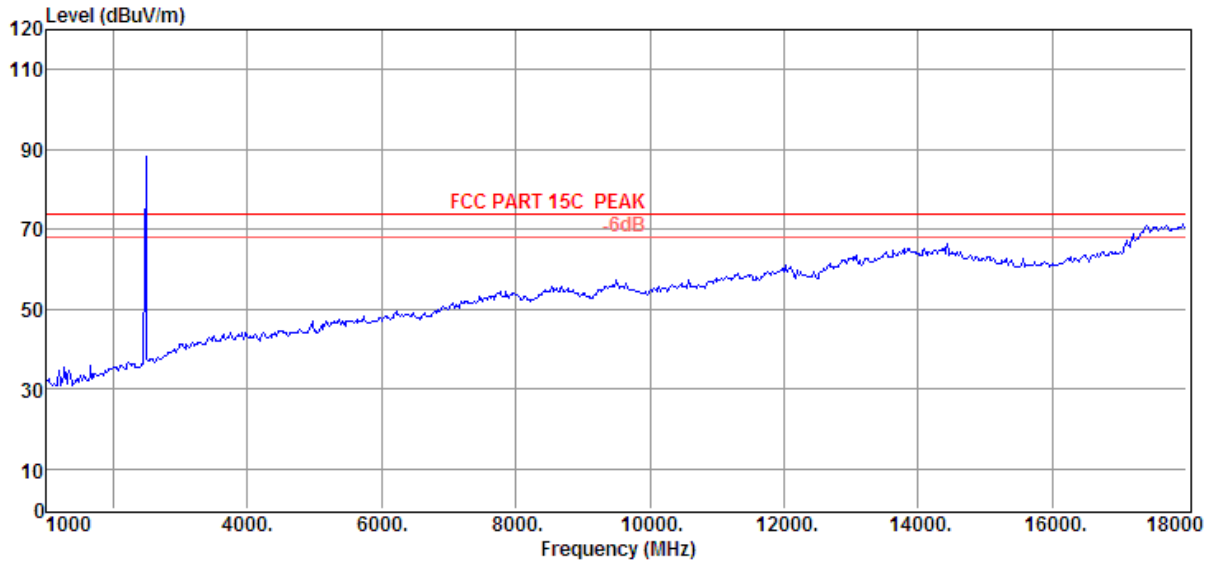

Item	Freq	Read Level	Antenna Factor	PRM Factor	Cable Loss	Result Level	Limit Line	Over Limit	Detector	Polarization
(Mark)	(MHz)	(dBμV)	(dB/m)	dB	dB	(dBμV/m)	(dBμV/m)	(dB)		

Note1: Result Level = Read Level + Antenna Factor + Cable loss - PRM Factor

Note2: If Peak Result complies with AV limit, AV Result is deemed to comply with AV limit

Radiated Emission Test Result

Test Site	: 3m Chamber	E:\D\12Q0017\ACSH216.EM6
Test Date	: 2012/05/02	Tested By : TaTa Chen
EUT	: BLUETOOTH SPEAKER	Model Number : B3D
Power Supply	: DC 5V from PC	Test Mode : GFSK Tx 2480MHz
Condition	: 23°C/54%	Antenna/Distance : 3115(0911)/3m/HORIZONTAL

Data: 12

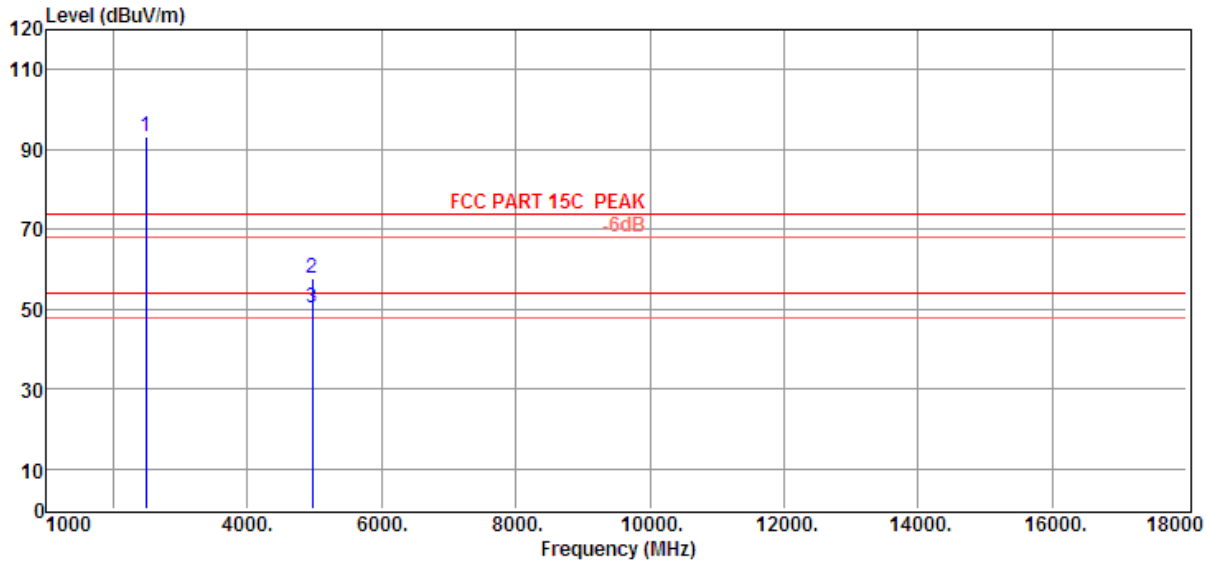

Item (Mark)	Freq (MHz)	Read Level (dBμV)	Antenna Factor (dB/m)	PRM Factor dB	Cable Loss dB	Result Level (dBμV/m)	Limit Line (dBμV/m)	Over Limit (dB)	Detector	Polarization
1	2480.00	92.56	29.49	36.60	7.58	93.03	74.00	19.03	Peak	HORIZONTAL
2	4960.00	47.31	34.54	34.95	10.80	57.70	74.00	-16.30	Peak	HORIZONTAL
3	4960.00	40.02	34.54	34.95	10.80	50.41	54.00	-3.59	Average	HORIZONTAL

Note1: Result Level = Read Level + Antenna Factor + Cable loss - PRM Factor

Note2: If Peak Result complies with AV limit, AV Result is deemed to comply with AV limit

Radiated Emission Test Result

Test Site	: 3m Chamber	E:\D\12Q0017\ACSH216.EM6
Test Date	: 2012/05/02	Tested By : TaTa Chen
EUT	: BLUETOOTH SPEAKER	Model Number : B3D
Power Supply	: DC 5V from PC	Test Mode : 8-DPSK Tx 2480MHz
Condition	: 23*C/54%	Antenna/Distance : 3115(0911)/3m/VERTICAL

Data: 13

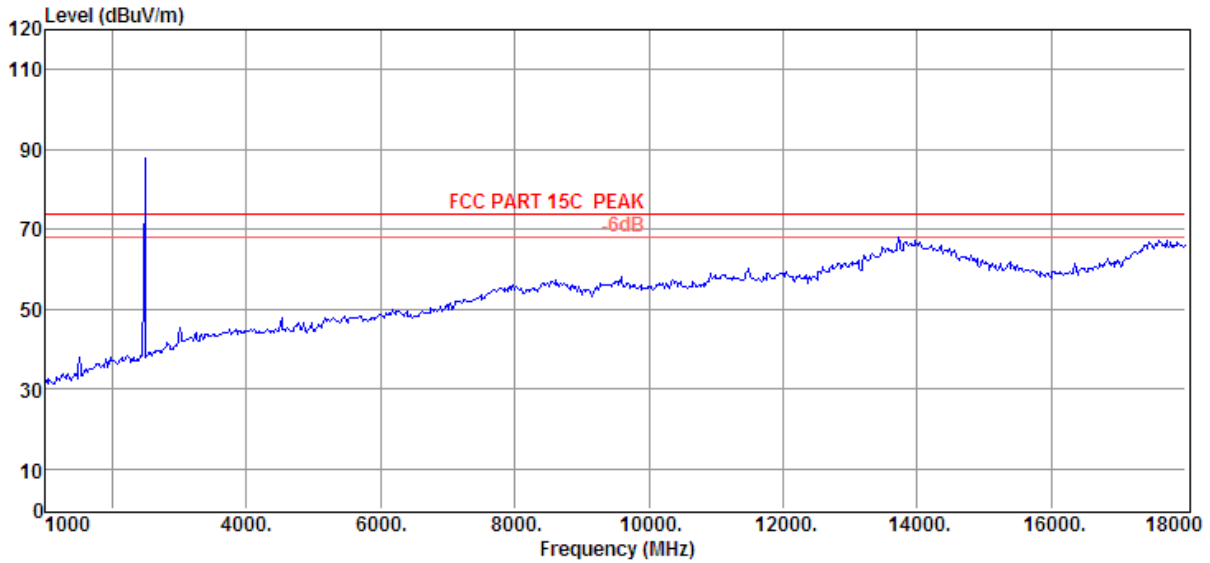

Item	Freq	Read Level	Antenna Factor	PRM Factor	Cable Loss	Result Level	Limit Line	Over Limit	Detector	Polarization
(Mark)	(MHz)	(dBμV)	(dB/m)	dB	dB	(dBμV/m)	(dBμV/m)	(dB)		

Note1: Result Level = Read Level + Antenna Factor + Cable loss - PRM Factor

Note2: If Peak Result complies with AV limit, AV Result is deemed to comply with AV limit

Radiated Emission Test Result

Test Site : 3m Chamber	E:\D\12Q0017\ACSH216.EM6
Test Date : 2012/05/02	Tested By : TaTa Chen
EUT : BLUETOOTH SPEAKER	Model Number : B3D
Power Supply : DC 5V from PC	Test Mode : 8-DPSK Tx 2480MHz
Condition : 23*C/54%	Antenna/Distance : 3115(0911)/3m/VERTICAL

Data: 14

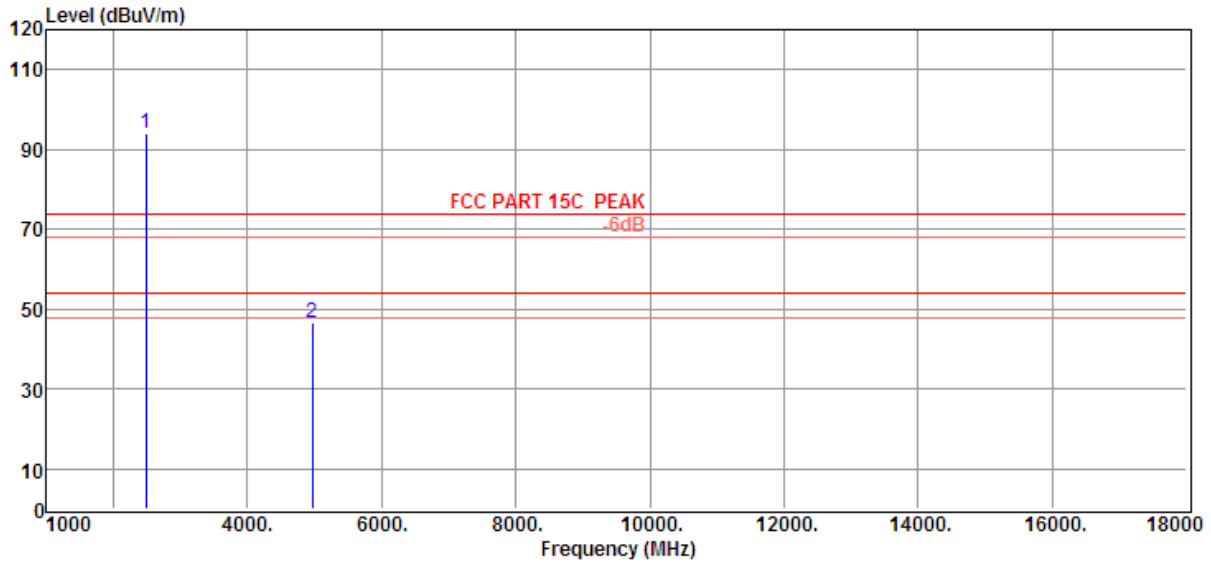

Item (Mark)	Freq (MHz)	Read Level (dBμV)	Antenna Factor (dB/m)	PRM Factor dB	Cable Loss dB	Result Level (dBμV/m)	Limit Line (dBμV/m)	Over Limit (dB)	Detector	Polarization
1	2480.00	91.58	29.49	35.97	8.87	93.97	74.00	19.97	Peak	VERTICAL
2	4960.00	12.21	34.34	0.00	0.00	46.55	74.00	-27.45	Peak	VERTICAL

Note1: Result Level = Read Level + Antenna Factor + Cable loss - PRM Factor

Note2: If Peak Result complies with AV limit, AV Result is deemed to comply with AV limit

Radiated Emission Test Result

Test Site	: 3m Chamber	E:\D\12Q0017\ACSH216.EM6
Test Date	: 2012/05/02	Tested By : TaTa Chen
EUT	: BLUETOOTH SPEAKER	Model Number : B3D
Power Supply	: DC 5V from PC	Test Mode : 8-DPSK Tx 2480MHz
Condition	: 23*C/54%	Antenna/Distance : 3115(0911)/3m/HORIZONTAL

Data: 15

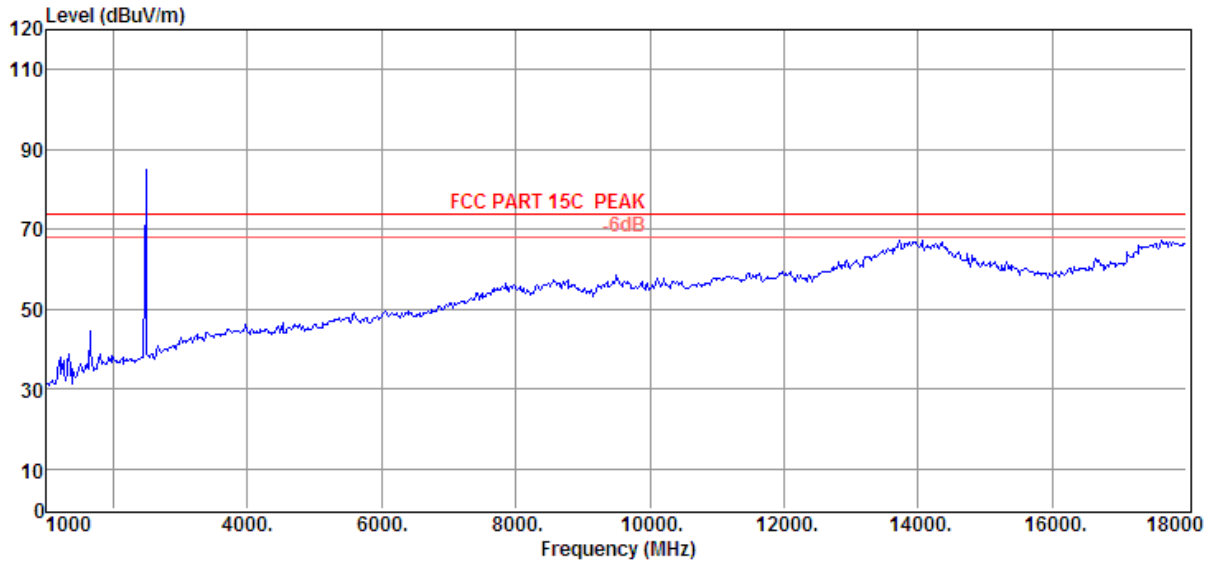

Item	Freq	Read Level	Antenna Factor	PRM Factor	Cable Loss	Result Level	Limit Line	Over Limit	Detector	Polarization
(Mark)	(MHz)	(dBμV)	(dB/m)	dB	dB	(dBμV/m)	(dBμV/m)	(dB)		

Note1: Result Level = Read Level + Antenna Factor + Cable loss - PRM Factor

Note2: If Peak Result complies with AV limit, AV Result is deemed to comply with AV limit

Radiated Emission Test Result

Test Site	: 3m Chamber	E:\D\12Q0017\ACSH216.EM6
Test Date	: 2012/05/02	Tested By : TaTa Chen
EUT	: BLUETOOTH SPEAKER	Model Number : B3D
Power Supply	: DC 5V from PC	Test Mode : 8-DPSK Tx 2480MHz
Condition	: 23*C/54%	Antenna/Distance : 3115(0911)/3m/HORIZONTAL

Data: 16

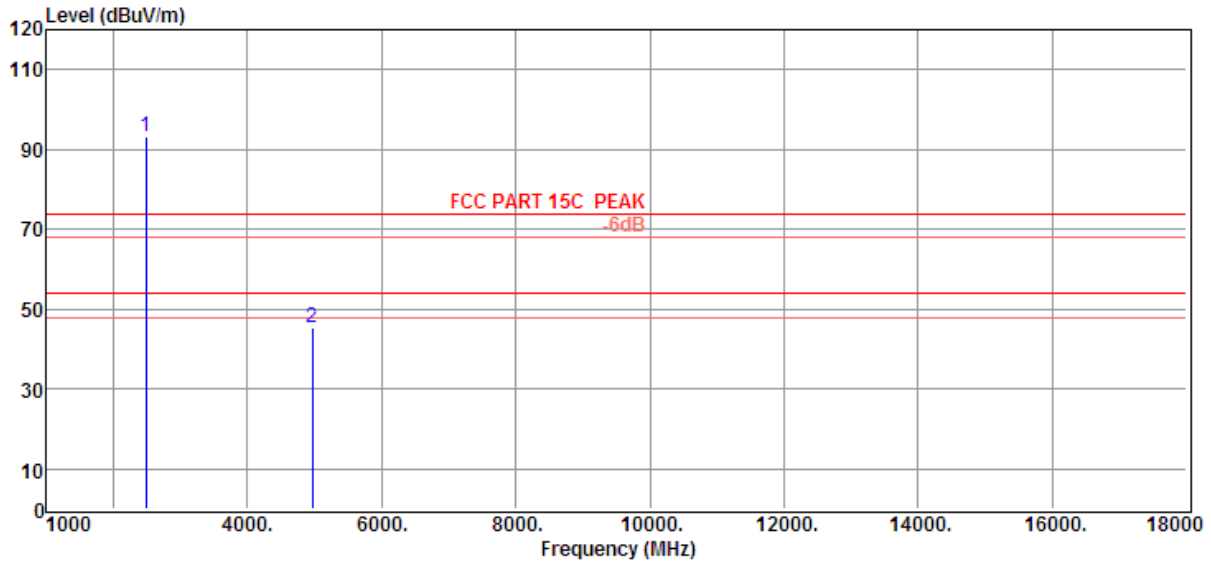

Item (Mark)	Freq (MHz)	Read Level (dBμV)	Antenna Factor (dB/m)	PRM Factor dB	Cable Loss dB	Result Level (dBμV/m)	Limit Line (dBμV/m)	Over Limit (dB)	Detector	Polarization
1	2480.00	90.92	29.49	35.97	8.87	93.31	74.00	19.31	Peak	HORIZONTAL
2	4960.00	11.15	34.34	0.00	0.00	45.49	74.00	-28.51	Peak	HORIZONTAL

Note1: Result Level = Read Level + Antenna Factor + Cable loss - PRM Factor

Note2: If Peak Result complies with AV limit, AV Result is deemed to comply with AV limit

Radiated Emission Test Result

Test Site	: 3m Chamber	E:\D\12Q0017\ACSH216.EM6
Test Date	: 2012/05/02	Tested By : TaTa Chen
EUT	: BLUETOOTH SPEAKER	Model Number : B3D
Power Supply	: DC 5V from PC	Test Mode : 8-DPSK Tx 2441MHz
Condition	: 23*C/54%	Antenna/Distance : 3115(0911)/3m/HORIZONTAL

Data: 17

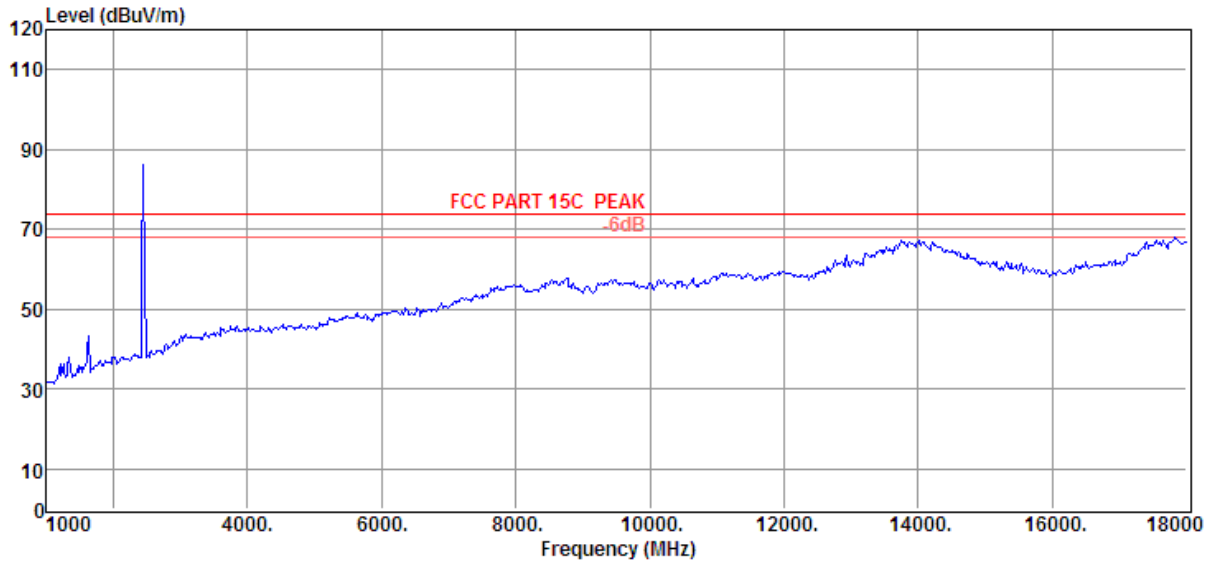

Item	Freq	Read Level	Antenna Factor	PRM Factor	Cable Loss	Result Level	Limit Line	Over Limit	Detector	Polarization
(Mark)	(MHz)	(dBμV)	(dB/m)	dB	dB	(dBμV/m)	(dBμV/m)	(dB)		

Note1: Result Level = Read Level + Antenna Factor + Cable loss - PRM Factor

Note2: If Peak Result complies with AV limit, AV Result is deemed to comply with AV limit

Radiated Emission Test Result

Test Site	: 3m Chamber	E:\D\12Q0017\ACSH216.EM6
Test Date	: 2012/05/02	Tested By : TaTa Chen
EUT	: BLUETOOTH SPEAKER	Model Number : B3D
Power Supply	: DC 5V from PC	Test Mode : 8-DPSK Tx 2441MHz
Condition	: 23*C/54%	Antenna/Distance : 3115(0911)/3m/HORIZONTAL

Data: 18

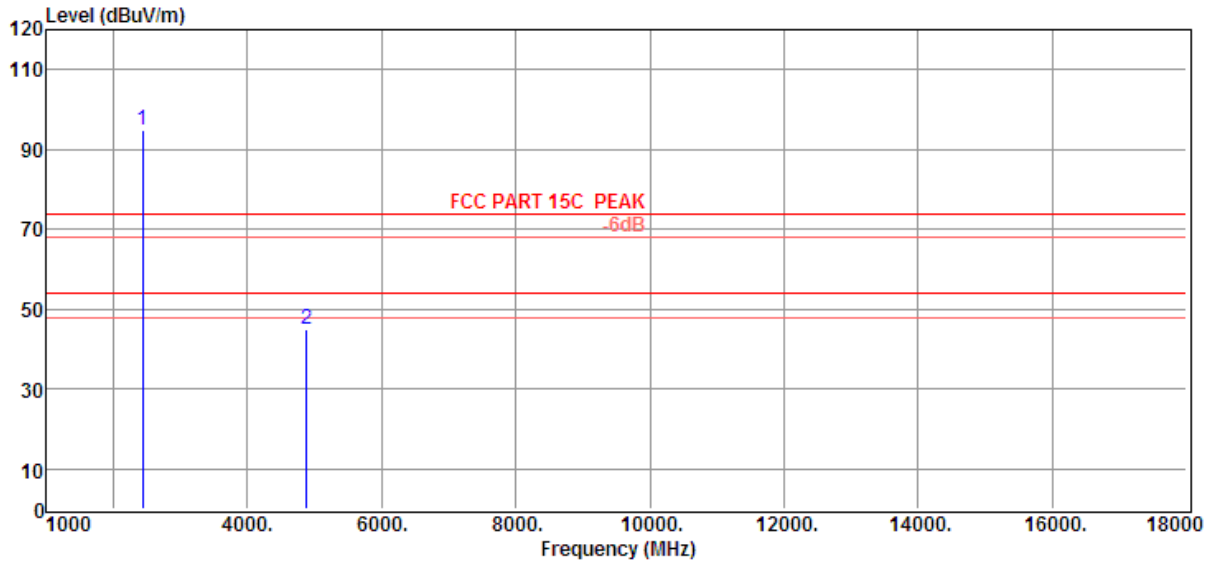

Item (Mark)	Freq (MHz)	Read Level (dBμV)	Antenna Factor (dB/m)	PRM Factor dB	Cable Loss dB	Result Level (dBμV/m)	Limit Line (dBμV/m)	Over Limit (dB)	Detector	Polarization
1	2441.00	92.81	29.47	36.06	8.77	94.99	74.00	20.99	Peak	HORIZONTAL
2	4882.00	10.79	34.29	0.00	0.00	45.08	74.00	-28.92	Peak	HORIZONTAL

Note1: Result Level = Read Level + Antenna Factor + Cable loss - PRM Factor

Note2: If Peak Result complies with AV limit, AV Result is deemed to comply with AV limit

Radiated Emission Test Result

Test Site	: 3m Chamber	E:\D\12Q0017\ACSH216.EM6
Test Date	: 2012/05/02	Tested By : TaTa Chen
EUT	: BLUETOOTH SPEAKER	Model Number : B3D
Power Supply	: DC 5V from PC	Test Mode : 8-DPSK Tx 2441MHz
Condition	: 23*C/54%	Antenna/Distance : 3115(0911)/3m/VERTICAL

Data: 19

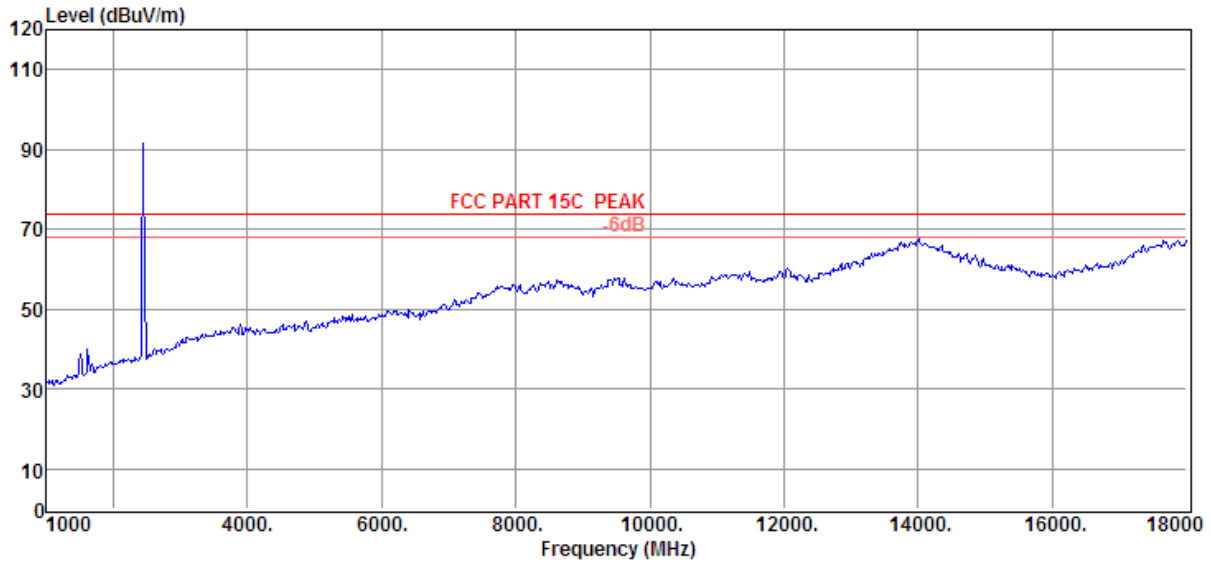

Item	Freq	Read Level	Antenna Factor	PRM Factor	Cable Loss	Result Level	Limit Line	Over Limit	Detector	Polarization
(Mark)	(MHz)	(dBμV)	(dB/m)	dB	dB	(dBμV/m)	(dBμV/m)	(dB)		

Note1: Result Level = Read Level + Antenna Factor + Cable loss - PRM Factor

Note2: If Peak Result complies with AV limit, AV Result is deemed to comply with AV limit

Radiated Emission Test Result

Test Site	: 3m Chamber	E:\D\12Q0017\ACSH216.EM6
Test Date	: 2012/05/02	Tested By : TaTa Chen
EUT	: BLUETOOTH SPEAKER	Model Number : B3D
Power Supply	: DC 5V from PC	Test Mode : 8-DPSK Tx 2441MHz
Condition	: 23*C/54%	Antenna/Distance : 3115(0911)/3m/VERTICAL

Data: 20

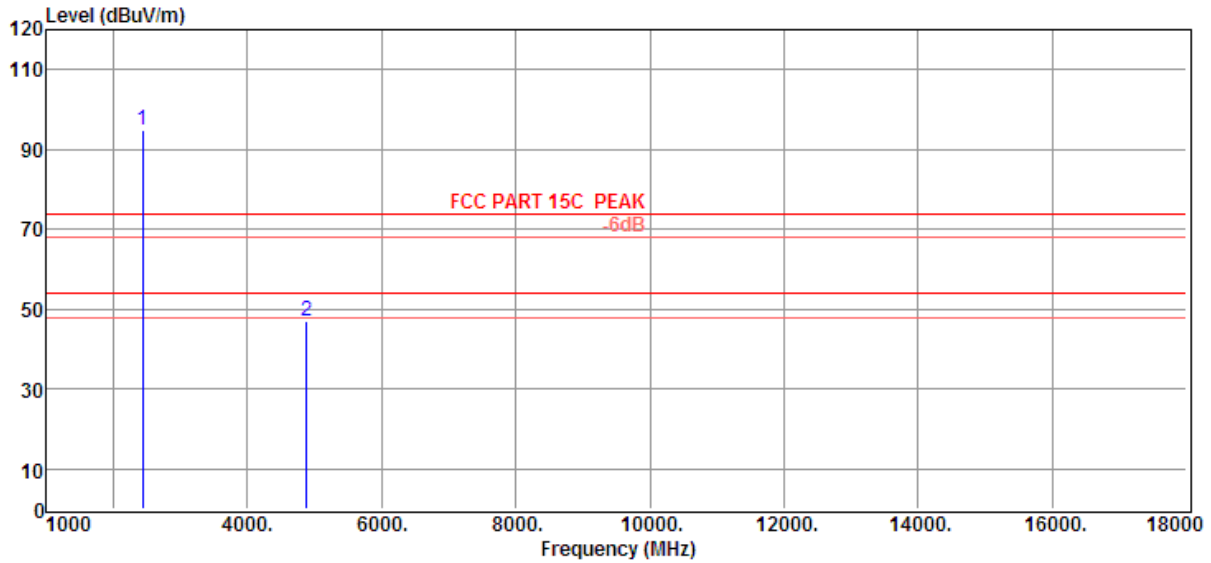

Item (Mark)	Freq (MHz)	Read Level (dBμV)	Antenna Factor (dB/m)	PRM Factor dB	Cable Loss dB	Result Level (dBμV/m)	Limit Line (dBμV/m)	Over Limit (dB)	Detector	Polarization
1	2441.00	92.56	29.47	36.06	8.77	94.74	74.00	20.74	Peak	VERTICAL
2	4882.00	12.79	34.29	0.00	0.00	47.08	74.00	-26.92	Peak	VERTICAL

Note1: Result Level = Read Level + Antenna Factor + Cable loss - PRM Factor

Note2: If Peak Result complies with AV limit, AV Result is deemed to comply with AV limit

Radiated Emission Test Result

Test Site	: 3m Chamber	E:\D\12Q0017\ACSH216.EM6
Test Date	: 2012/05/02	Tested By : TaTa Chen
EUT	: BLUETOOTH SPEAKER	Model Number : B3D
Power Supply	: DC 5V from PC	Test Mode : 8-DPSK Tx 2402MHz
Condition	: 23*C/54%	Antenna/Distance : 3115(0911)/3m/VERTICAL

Data: 21

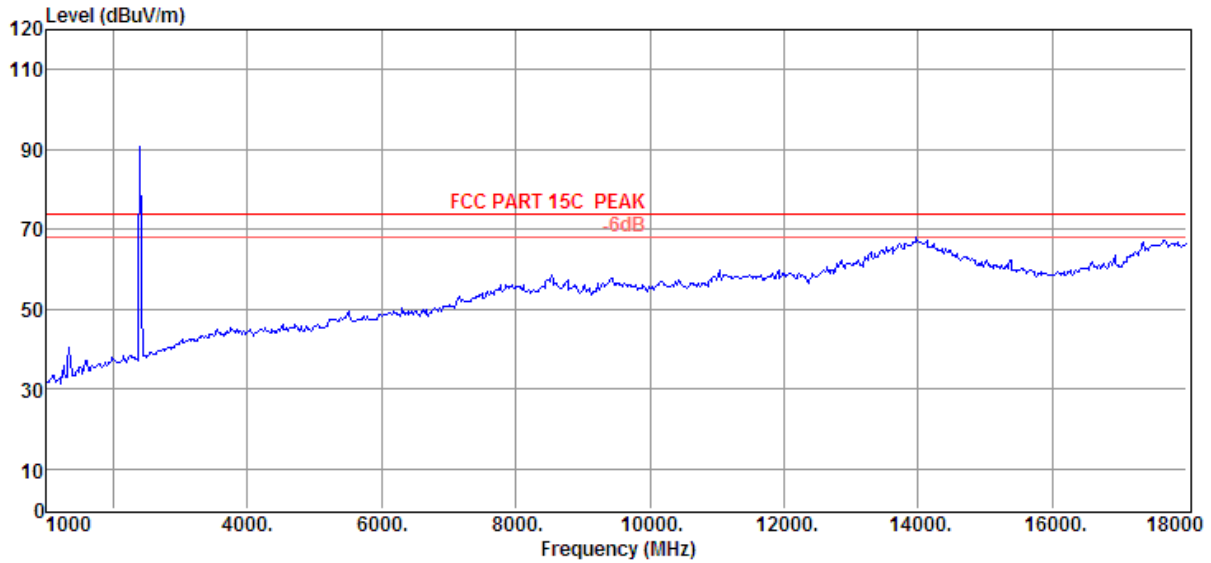

Item	Freq	Read Level	Antenna Factor	PRM Factor	Cable Loss	Result Level	Limit Line	Over Limit	Detector	Polarization
(Mark)	(MHz)	(dBμV)	(dB/m)	dB	dB	(dBμV/m)	(dBμV/m)	(dB)		

Note1: Result Level = Read Level + Antenna Factor + Cable loss - PRM Factor

Note2: If Peak Result complies with AV limit, AV Result is deemed to comply with AV limit

Radiated Emission Test Result

Test Site	: 3m Chamber	E:\D\12Q0017\ACSH216.EM6
Test Date	: 2012/05/02	Tested By : TaTa Chen
EUT	: BLUETOOTH SPEAKER	Model Number : B3D
Power Supply	: DC 5V from PC	Test Mode : 8-DPSK Tx 2402MHz
Condition	: 23*C/54%	Antenna/Distance : 3115(0911)/3m/VERTICAL

Data: 22

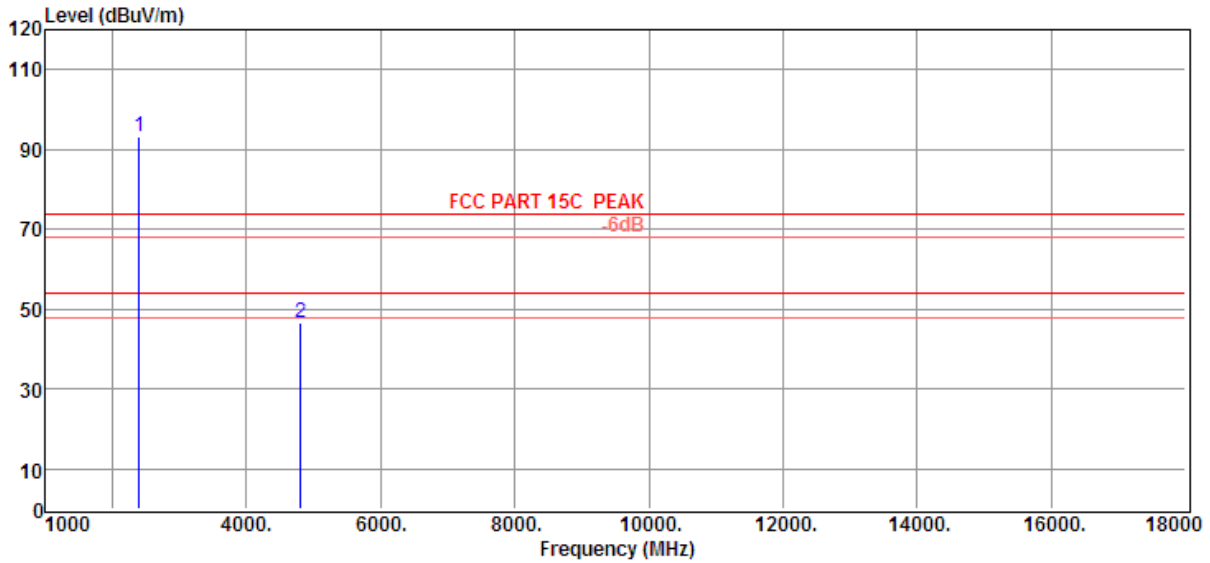

Item (Mark)	Freq (MHz)	Read Level (dBμV)	Antenna Factor (dB/m)	PRM Factor dB	Cable Loss dB	Result Level (dBμV/m)	Limit Line (dBμV/m)	Over Limit (dB)	Detector	Polarization
1	2402.00	91.07	29.44	36.09	8.72	93.14	74.00	19.14	Peak	VERTICAL
2	4804.00	12.47	34.01	0.00	0.00	46.48	74.00	-27.52	Peak	VERTICAL

Note1: Result Level = Read Level + Antenna Factor + Cable loss - PRM Factor

Note2: If Peak Result complies with AV limit, AV Result is deemed to comply with AV limit

Radiated Emission Test Result

Test Site	: 3m Chamber	E:\D\12Q0017\ACSH216.EM6
Test Date	: 2012/05/02	Tested By : TaTa Chen
EUT	: BLUETOOTH SPEAKER	Model Number : B3D
Power Supply	: DC 5V from PC	Test Mode : 8-DPSK Tx 2402MHz
Condition	: 23*C/54%	Antenna/Distance : 3115(0911)/3m/HORIZONTAL

Data: 23

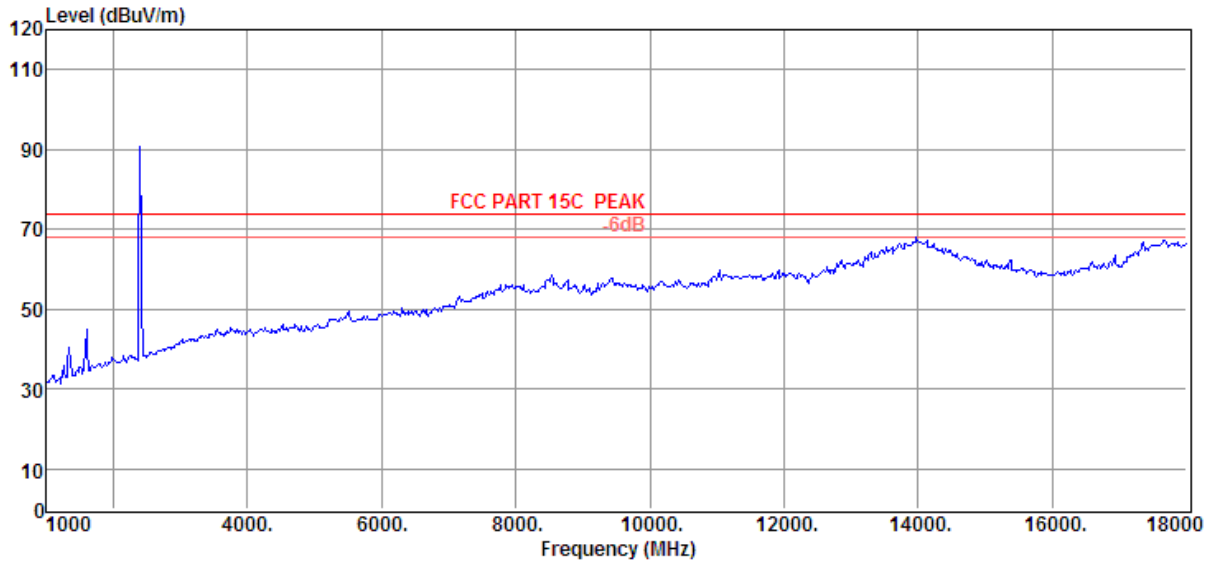

Item	Freq	Read Level	Antenna Factor	PRM Factor	Cable Loss	Result Level	Limit Line	Over Limit	Detector	Polarization
(Mark)	(MHz)	(dBμV)	(dB/m)	dB	dB	(dBμV/m)	(dBμV/m)	(dB)		

Note1: Result Level = Read Level + Antenna Factor + Cable loss - PRM Factor

Note2: If Peak Result complies with AV limit, AV Result is deemed to comply with AV limit

Radiated Emission Test Result

Test Site	: 3m Chamber	E:\D\12Q0017\ACSH216.EM6
Test Date	: 2012/05/02	Tested By : TaTa Chen
EUT	: BLUETOOTH SPEAKER	Model Number : B3D
Power Supply	: DC 5V from PC	Test Mode : 8-DPSK Tx 2402MHz
Condition	: 23*C/54%	Antenna/Distance : 3115(0911)/3m/HORIZONTAL

Data: 24

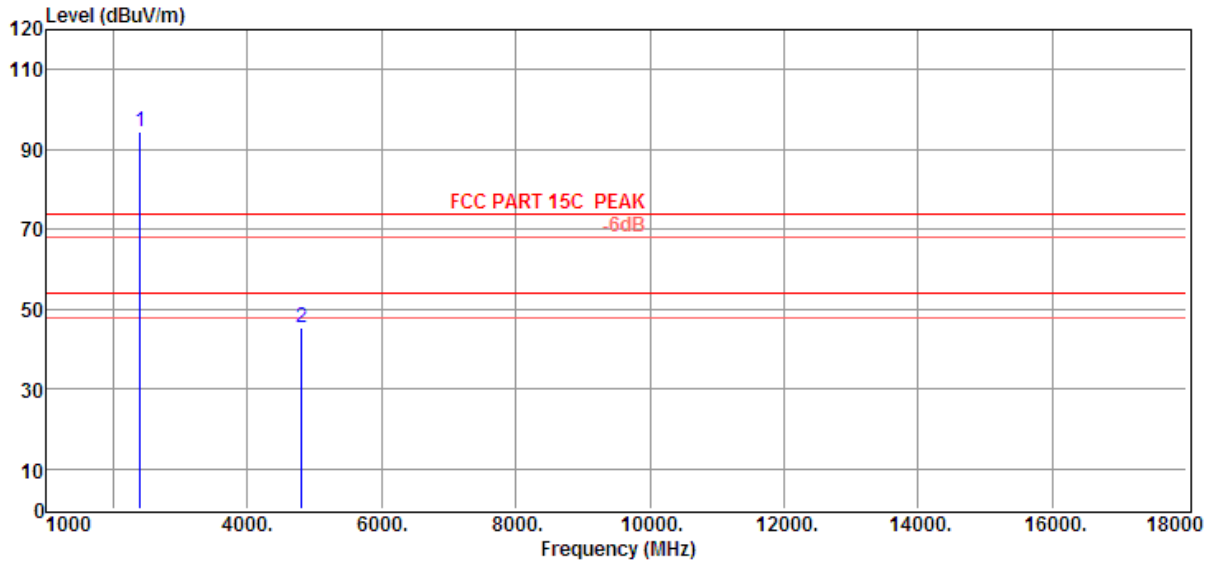

Item (Mark)	Freq (MHz)	Read Level (dBμV)	Antenna Factor (dB/m)	PRM Factor dB	Cable Loss dB	Result Level (dBμV/m)	Limit Line (dBμV/m)	Over Limit (dB)	Detector	Polarization
1	2402.00	92.56	29.44	36.09	8.72	94.63	74.00	20.63	Peak	HORIZONTAL
2	4804.00	11.18	34.01	0.00	0.00	45.19	74.00	-28.81	Peak	HORIZONTAL

Note1: Result Level = Read Level + Antenna Factor + Cable loss - PRM Factor

Note2: If Peak Result complies with AV limit, AV Result is deemed to comply with AV limit

9. Band Edge Compliance

9.1. Test equipment

Item	Equipment	Manufacturer	Model No.	Serial No.	Last Cal.	Cal. Interval
1	EMI Test Receiver	R&S	ESU8	100316	2011/11/23	1Y
2	Spectrum analyzer	R&S	FSU	1166.1660.26	2011/11/23	1Y
3	Trilog Broadband Antenna	Schwarzbeck	VULB9163	9163-462	2010/11/09	2 Y
4	Double Ridged Horn Antenna	R&S	HF907	100276	2011/01/16	2 Y
5	Pre-Amplifier	R&S	SCU-01	10049	2011/11/23	1Y
6	Pre-amplifier	A.H.	PAM0-0118	360	2011-12-20	1Y
7	RF Cable	R&S	R01	10403	2011/11/23	1Y
8	RF Cable	R&S	R02	10512	2011/11/23	1Y
9	Test software	R&S	EMC32	/	/	/

9.2. Block diagram of test setup

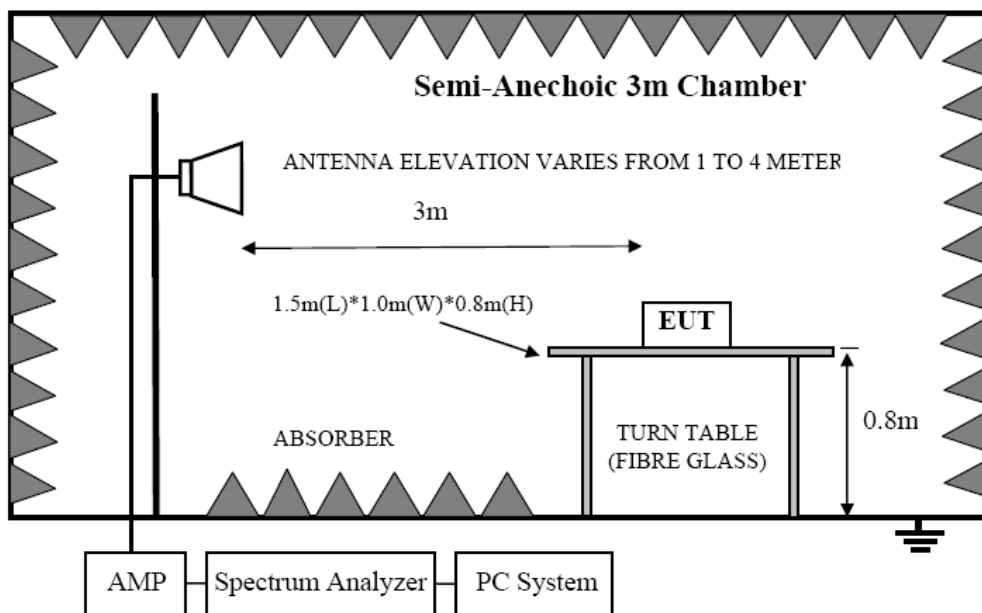

9.3. Limit

All the lower and upper band-edges emissions appearing within 2310MHz to 2390MHz and 2483.5MHz to 2500MHz restricted frequency bands shall not exceed the limits shown in 15.209, all the other emissions outside operation frequency band 2400MHz to 2483.5MHz and 5725MHz to 5850MHz shall be at least 20dB below the fundamental emissions, or comply with 15.209 limits.

9.4. Test Procedure

Same with clause 8.4 except change investigated frequency range from 2310MHz to 2415MHz and 2475MHz to 2500MHz.

9.5. Test result

PASS. (See below detailed test result)

Radiated Emission Test Result

Test Site	: 3m Chamber	E:\D\12Q0017\ACSH216.EM6
Test Date	: 2012/05/02	Tested By : TaTa Chen
EUT	: BLUETOOTH SPEAKER	Model Number : B3D
Power Supply	: DC 5V from PC	Test Mode : 8-DPSK Tx 2402MHz
Condition	: 23*C/54%	Antenna/Distance : 3115(0911)/3m/HORIZONTAL

Data: 25

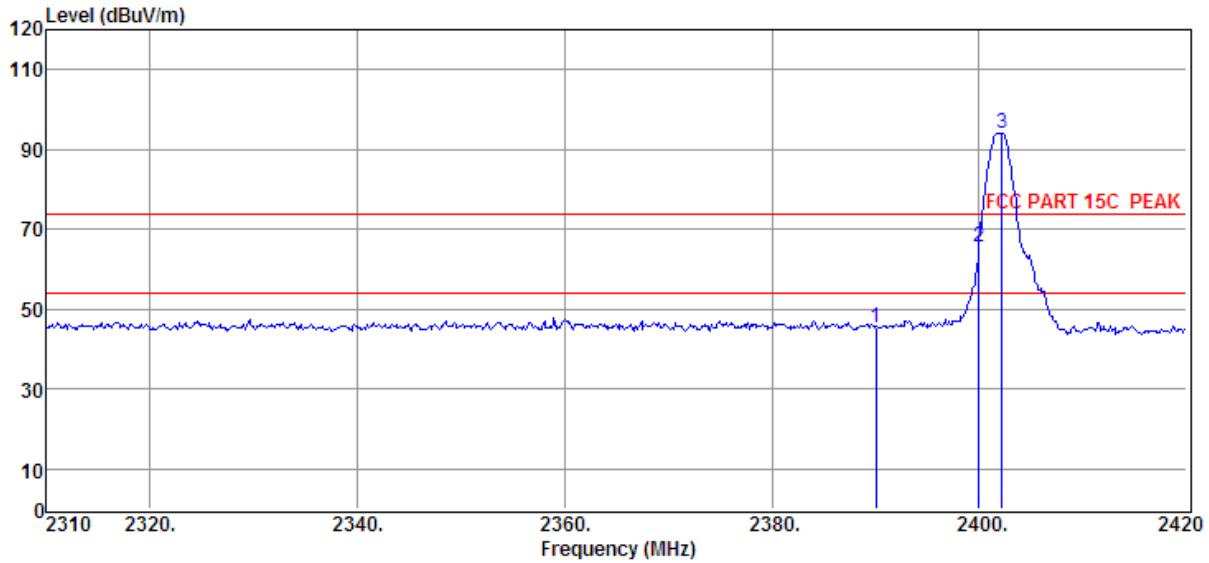

Item (Mark)	Freq (MHz)	Read Level (dBμV)	Antenna Factor (dB/m)	PRM Factor dB	Cable Loss dB	Result Level (dBμV/m)	Limit Line (dBμV/m)	Over Limit (dB)	Detector	Polarization
1	2390.00	16.75	28.70	0.00	0.00	45.45	74.00	-28.55	Peak	HORIZONTAL
2	2400.00	36.70	28.93	0.00	0.00	65.63	74.00	-8.37	Peak	HORIZONTAL
3	2402.18	65.13	28.93	0.00	0.00	94.06	74.00	20.06	Peak	HORIZONTAL

Note1: Result Level = Read Level + Antenna Factor + Cable loss - PRM Factor

Note2: If Peak Result complies with AV limit, AV Result is deemed to comply with AV limit

Radiated Emission Test Result

Test Site	: 3m Chamber	E:\D\12Q0017\ACSH216.EM6
Test Date	: 2012/05/02	Tested By : TaTa Chen
EUT	: BLUETOOTH SPEAKER	Model Number : B3D
Power Supply	: DC 5V from PC	Test Mode : 8-DPSK Tx 2402MHz
Condition	: 23*C/54%	Antenna/Distance : 3115(0911)/3m/VERTICAL

Data: 26

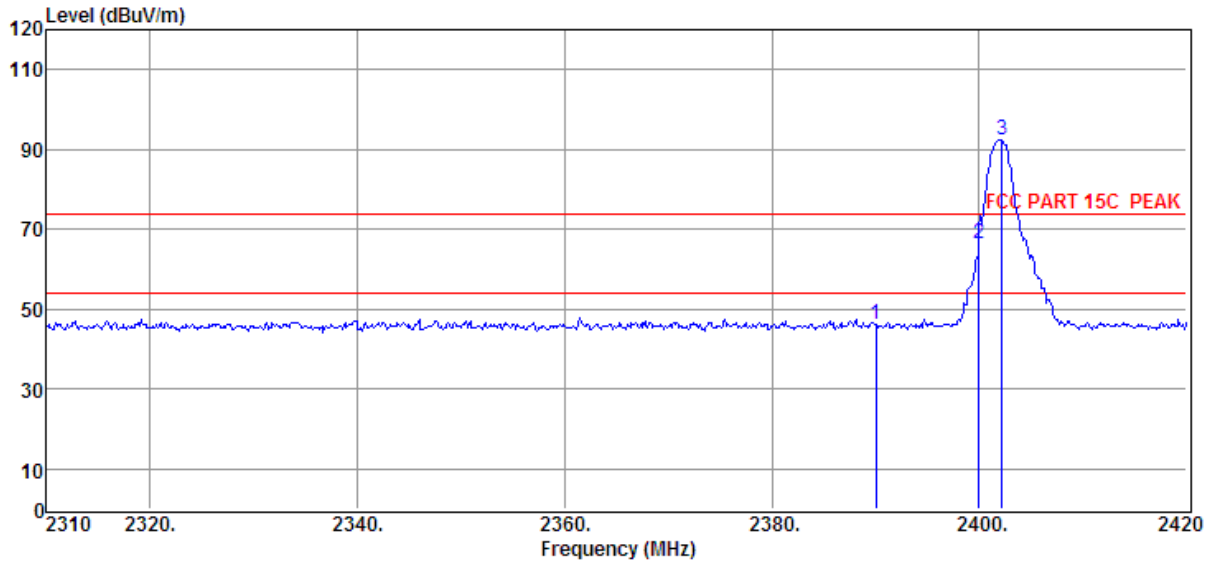

Item (Mark)	Freq (MHz)	Read Level (dBμV)	Antenna Factor (dB/m)	PRM Factor dB	Cable Loss dB	Result Level (dBμV/m)	Limit Line (dBμV/m)	Over Limit (dB)	Detector	Polarization
1	2390.00	17.57	28.70	0.00	0.00	46.27	74.00	-27.73	Peak	VERTICAL
2	2400.00	37.33	28.93	0.00	0.00	66.26	74.00	-7.74	Peak	VERTICAL
3	2402.18	63.37	28.93	0.00	0.00	92.30	74.00	18.30	Peak	VERTICAL

Note1: Result Level = Read Level + Antenna Factor + Cable loss - PRM Factor

Note2: If Peak Result complies with AV limit, AV Result is deemed to comply with AV limit

Radiated Emission Test Result

Test Site	: 3m Chamber	E:\D\12Q0017\ACSH216.EM6
Test Date	: 2012/05/02	Tested By : TaTa Chen
EUT	: BLUETOOTH SPEAKER	Model Number : B3D
Power Supply	: DC 5V from PC	Test Mode : 8-DPSK Tx 2480MHz
Condition	: 23*C/54%	Antenna/Distance : 3115(0911)/3m/VERTICAL

Data: 27

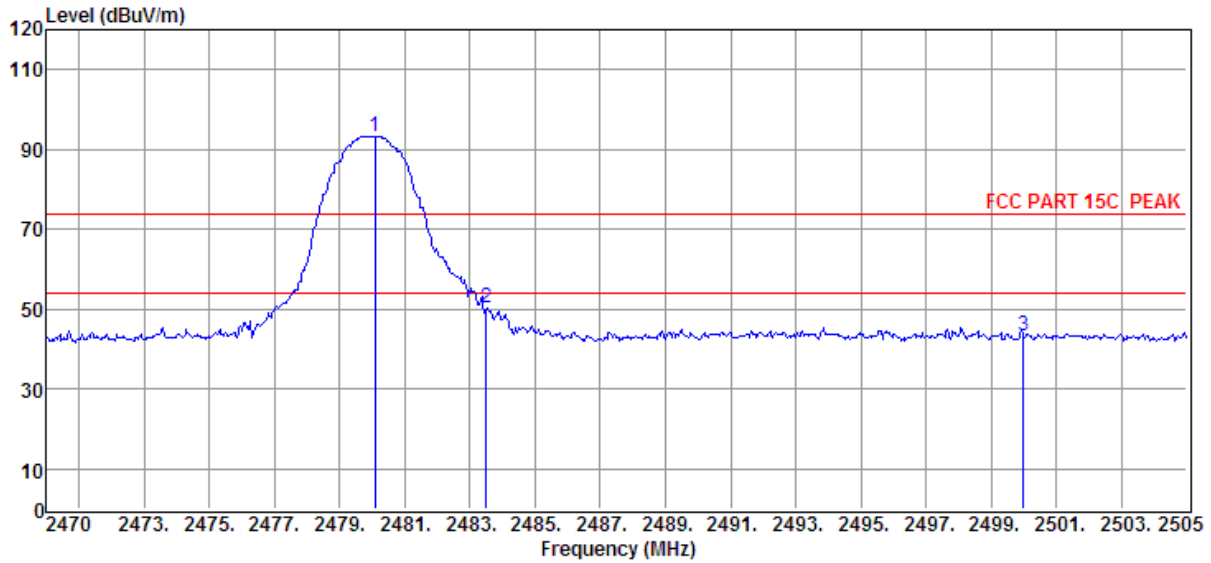

Item (Mark)	Freq (MHz)	Read Level (dBμV)	Antenna Factor (dB/m)	PRM Factor dB	Cable Loss dB	Result Level (dBμV/m)	Limit Line (dBμV/m)	Over Limit (dB)	Detector	Polarization
1	2480.08	64.21	29.18	0.00	0.00	93.39	74.00	19.39	Peak	VERTICAL
2	2483.50	21.21	29.18	0.00	0.00	50.39	74.00	-23.61	Peak	VERTICAL
3	2500.00	13.95	29.25	0.00	0.00	43.20	74.00	-30.80	Peak	VERTICAL

Note1: Result Level = Read Level + Antenna Factor + Cable loss - PRM Factor

Note2: If Peak Result complies with AV limit, AV Result is deemed to comply with AV limit

Radiated Emission Test Result

Test Site	: 3m Chamber	E:\D\12Q0017\ACSH216.EM6
Test Date	: 2012/05/02	Tested By : TaTa Chen
EUT	: BLUETOOTH SPEAKER	Model Number : B3D
Power Supply	: DC 5V from PC	Test Mode : 8-DPSK Tx 2480MHz
Condition	: 23*C/54%	Antenna/Distance : 3115(0911)/3m/HORIZONTAL

Data: 28

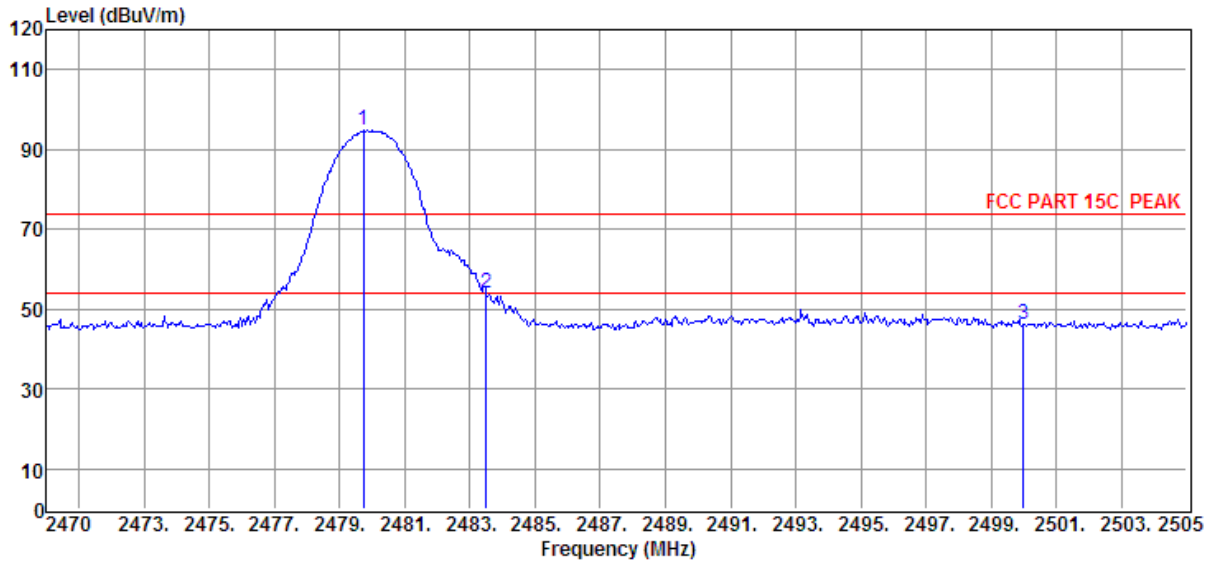

Item (Mark)	Freq (MHz)	Read Level (dBμV)	Antenna Factor (dB/m)	PRM Factor dB	Cable Loss dB	Result Level (dBμV/m)	Limit Line (dBμV/m)	Over Limit (dB)	Detector	Polarization
1	2479.73	65.63	29.18	0.00	0.00	94.81	74.00	20.81	Peak	HORIZONTAL
2	2483.50	24.88	29.18	0.00	0.00	54.06	74.00	-19.94	Peak	HORIZONTAL
3	2500.00	17.03	29.25	0.00	0.00	46.28	74.00	-27.72	Peak	HORIZONTAL

Note1: Result Level = Read Level + Antenna Factor + Cable loss - PRM Factor

Note2: If Peak Result complies with AV limit, AV Result is deemed to comply with AV limit

Radiated Emission Test Result

Test Site	: 3m Chamber	E:\D\12Q0017\ACSH216.EM6
Test Date	: 2012/05/02	Tested By : TaTa Chen
EUT	: BLUETOOTH SPEAKER	Model Number : B3D
Power Supply	: DC 5V from PC	Test Mode : 8-DPSK Hopping on
Condition	: 23*C/54%	Antenna/Distance : 3115(0911)/3m/HORIZONTAL

Data: 29

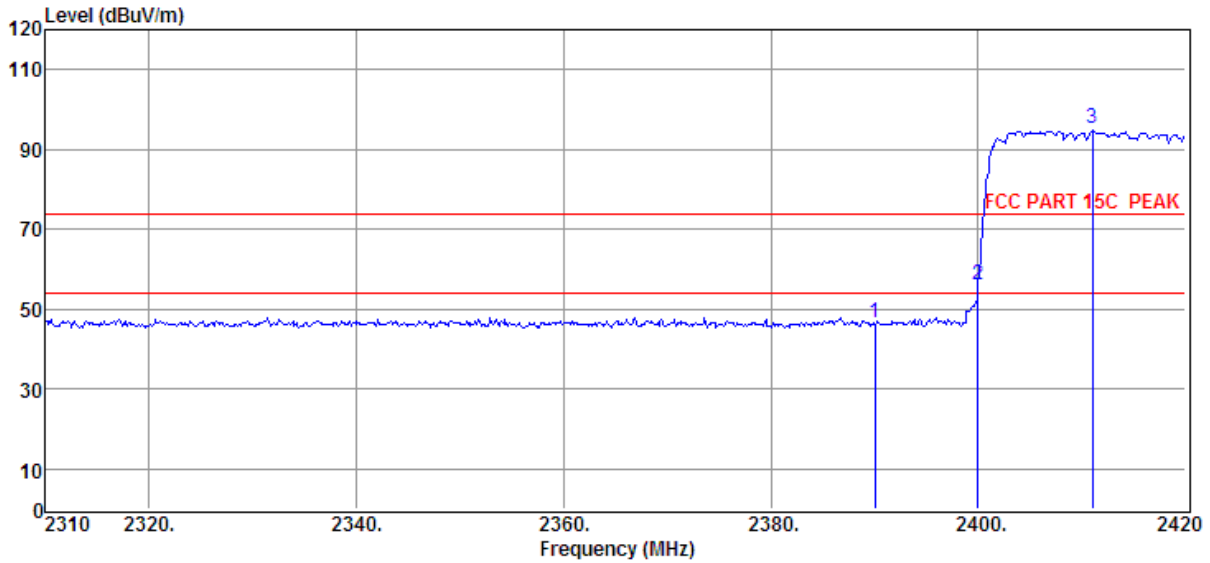

Item (Mark)	Freq (MHz)	Read Level (dBμV)	Antenna Factor (dB/m)	PRM Factor dB	Cable Loss dB	Result Level (dBμV/m)	Limit Line (dBμV/m)	Over Limit (dB)	Detector	Polarization
1	2390.00	17.71	28.70	0.00	0.00	46.41	74.00	-27.59	Peak	HORIZONTAL
2	2400.00	27.23	28.93	0.00	0.00	56.16	74.00	-17.84	Peak	HORIZONTAL
3	2410.98	66.38	28.98	0.00	0.00	95.36	74.00	21.36	Peak	HORIZONTAL

Note1: Result Level = Read Level + Antenna Factor + Cable loss - PRM Factor

Note2: If Peak Result complies with AV limit, AV Result is deemed to comply with AV limit

Radiated Emission Test Result

Test Site	: 3m Chamber	E:\D\12Q0017\ACSH216.EM6
Test Date	: 2012/05/02	Tested By : TaTa Chen
EUT	: BLUETOOTH SPEAKER	Model Number : B3D
Power Supply	: DC 5V from PC	Test Mode : 8-DPSK Hopping on
Condition	: 23*C/54%	Antenna/Distance : 3115(0911)/3m/VERTICAL

Data: 30

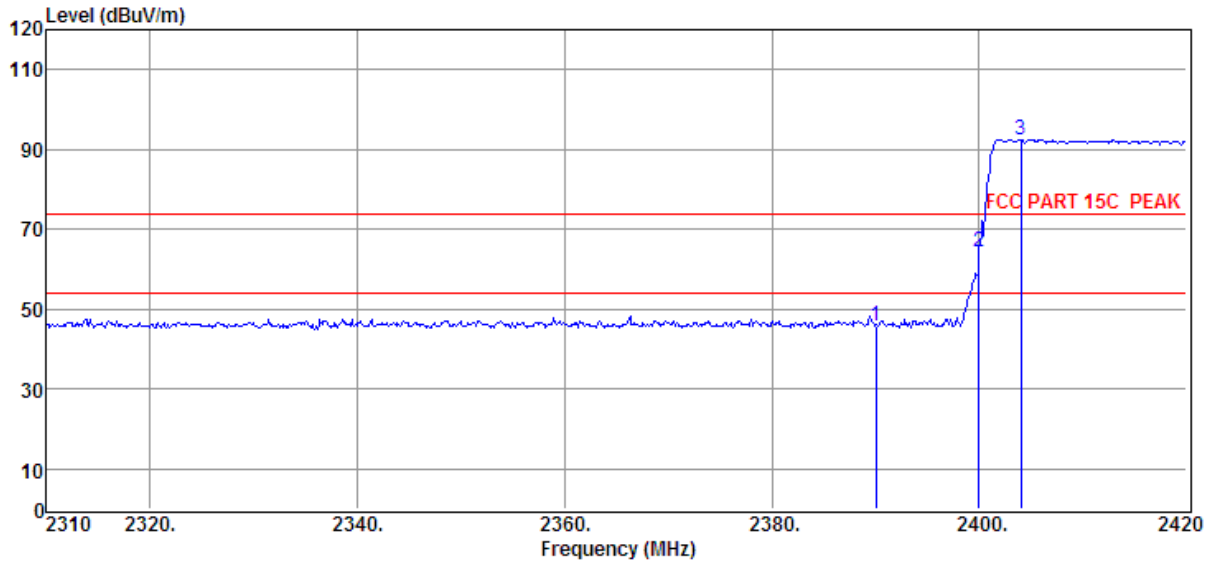

Item (Mark)	Freq (MHz)	Read Level (dBμV)	Antenna Factor (dB/m)	PRM Factor dB	Cable Loss dB	Result Level (dBμV/m)	Limit Line (dBμV/m)	Over Limit (dB)	Detector	Polarization
1	2390.00	17.11	28.70	0.00	0.00	45.81	74.00	-28.19	Peak	VERTICAL
2	2400.00	35.59	28.93	0.00	0.00	64.52	74.00	-9.48	Peak	VERTICAL
3	2404.05	63.37	28.93	0.00	0.00	92.30	74.00	18.30	Peak	VERTICAL

Note1: Result Level = Read Level + Antenna Factor + Cable loss - PRM Factor

Note2: If Peak Result complies with AV limit, AV Result is deemed to comply with AV limit

Radiated Emission Test Result

Test Site	: 3m Chamber	E:\D\12Q0017\ACSH216.EM6
Test Date	: 2012/05/02	Tested By : TaTa Chen
EUT	: BLUETOOTH SPEAKER	Model Number : B3D
Power Supply	: DC 5V from PC	Test Mode : 8-DPSK Hopping on
Condition	: 23*C/54%	Antenna/Distance : 3115(0911)/3m/VERTICAL

Data: 31

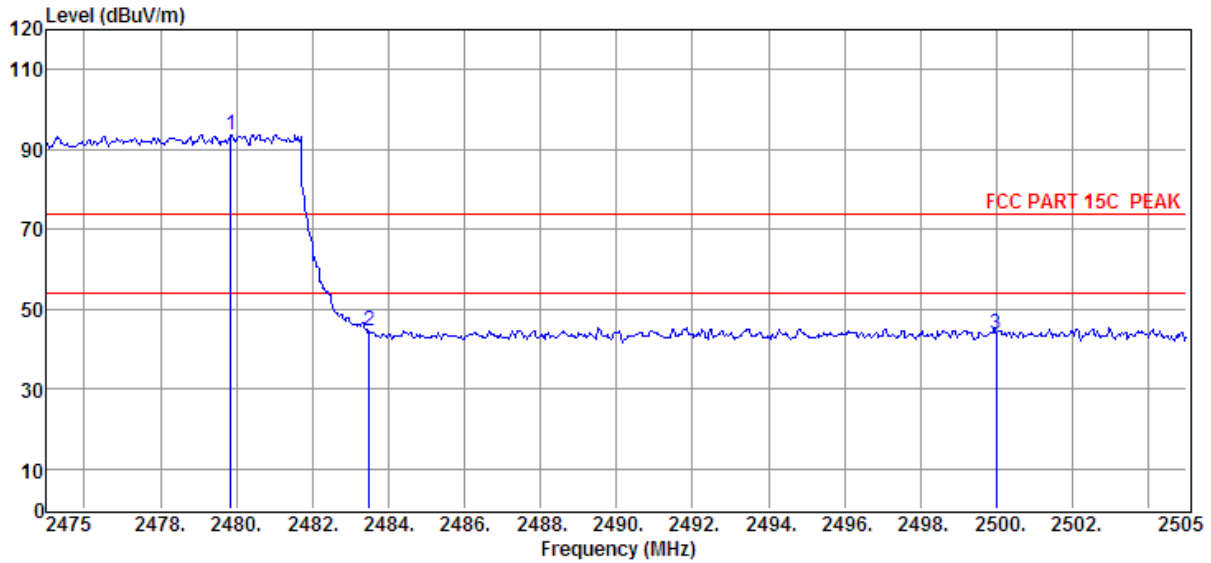

Item (Mark)	Freq (MHz)	Read Level (dBμV)	Antenna Factor (dB/m)	PRM Factor dB	Cable Loss dB	Result Level (dBμV/m)	Limit Line (dBμV/m)	Over Limit (dB)	Detector	Polarization
1	2479.86	64.53	29.18	0.00	0.00	93.71	74.00	19.71	Peak	VERTICAL
2	2483.50	15.23	29.18	0.00	0.00	44.41	74.00	-29.59	Peak	VERTICAL
3	2500.00	14.59	29.25	0.00	0.00	43.84	74.00	-30.16	Peak	VERTICAL

Note1: Result Level = Read Level + Antenna Factor + Cable loss - PRM Factor

Note2: If Peak Result complies with AV limit, AV Result is deemed to comply with AV limit

Radiated Emission Test Result

Test Site	: 3m Chamber	E:\D\12Q0017\ACSH216.EM6
Test Date	: 2012/05/02	Tested By : TaTa Chen
EUT	: BLUETOOTH SPEAKER	Model Number : B3D
Power Supply	: DC 5V from PC	Test Mode : 8-DPSK Hopping on
Condition	: 23*C/54%	Antenna/Distance : 3115(0911)/3m/HORIZONTAL

Data: 32

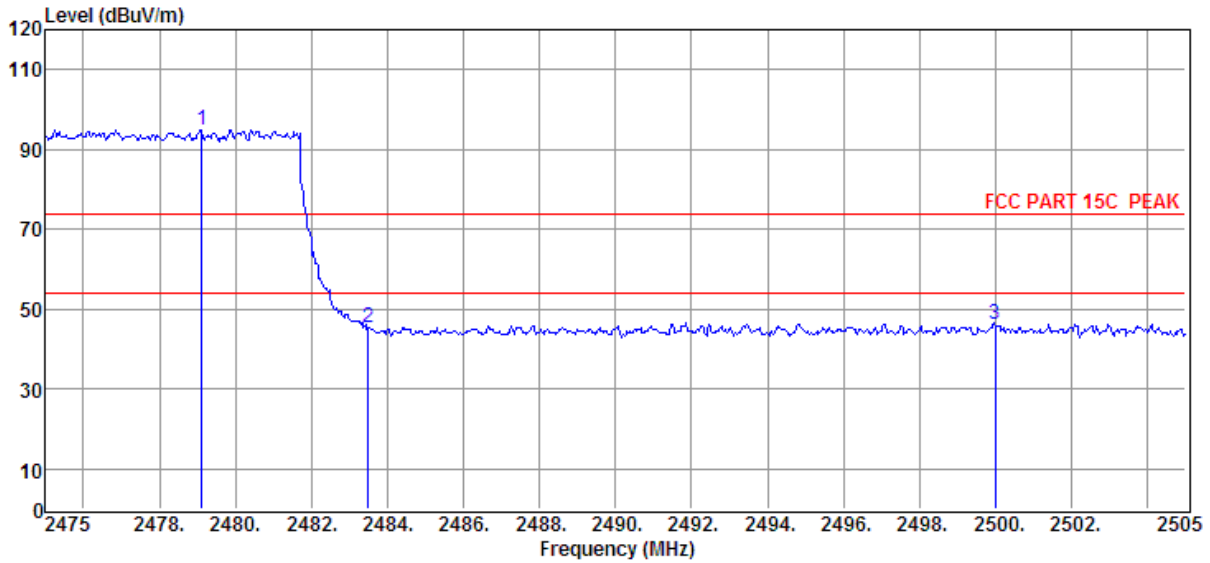

Item (Mark)	Freq (MHz)	Read Level (dBμV)	Antenna Factor (dB/m)	PRM Factor dB	Cable Loss dB	Result Level (dBμV/m)	Limit Line (dBμV/m)	Over Limit (dB)	Detector	Polarization
1	2479.11	65.46	29.18	0.00	0.00	94.64	74.00	20.64	Peak	HORIZONTAL
2	2483.50	16.23	29.18	0.00	0.00	45.41	74.00	-28.59	Peak	HORIZONTAL
3	2500.00	17.12	29.25	0.00	0.00	46.37	74.00	-27.63	Peak	HORIZONTAL

Note1: Result Level = Read Level + Antenna Factor + Cable loss - PRM Factor

Note2: If Peak Result complies with AV limit, AV Result is deemed to comply with AV limit

Radiated Emission Test Result

Test Site	: 3m Chamber	E:\D\12Q0017\ACSH216.EM6
Test Date	: 2012/05/02	Tested By : TaTa Chen
EUT	: BLUETOOTH SPEAKER	Model Number : B3D
Power Supply	: DC 5V from PC	Test Mode : GFSK Tx 2480MHz
Condition	: 23*C/54%	Antenna/Distance : 3115(0911)/3m/HORIZONTAL

Data: 33

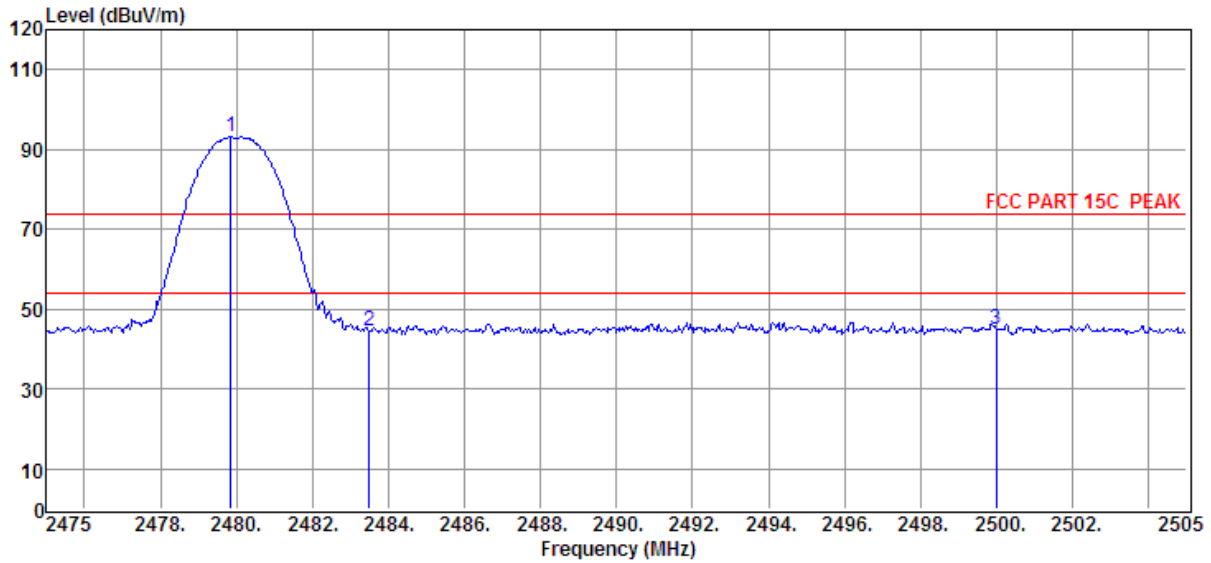

Item (Mark)	Freq (MHz)	Read Level (dBμV)	Antenna Factor (dB/m)	PRM Factor dB	Cable Loss dB	Result Level (dBμV/m)	Limit Line (dBμV/m)	Over Limit (dB)	Detector	Polarization
1	2479.86	100.76	29.18	43.50	6.57	93.01	74.00	19.01	Peak	HORIZONTAL
2	2483.50	52.43	29.18	43.50	6.57	44.68	74.00	-29.32	Peak	HORIZONTAL
3	2500.00	52.65	29.25	43.50	6.59	44.99	74.00	-29.01	Peak	HORIZONTAL

Note1: Result Level = Read Level + Antenna Factor + Cable loss - PRM Factor

Note2: If Peak Result complies with AV limit, AV Result is deemed to comply with AV limit

Radiated Emission Test Result

Test Site	: 3m Chamber	E:\D\12Q0017\ACSH216.EM6
Test Date	: 2012/05/02	Tested By : TaTa Chen
EUT	: BLUETOOTH SPEAKER	Model Number : B3D
Power Supply	: DC 5V from PC	Test Mode : GFSK Tx 2480MHz
Condition	: 23°C/54%	Antenna/Distance : 3115(0911)/3m/VERTICAL

Data: 34

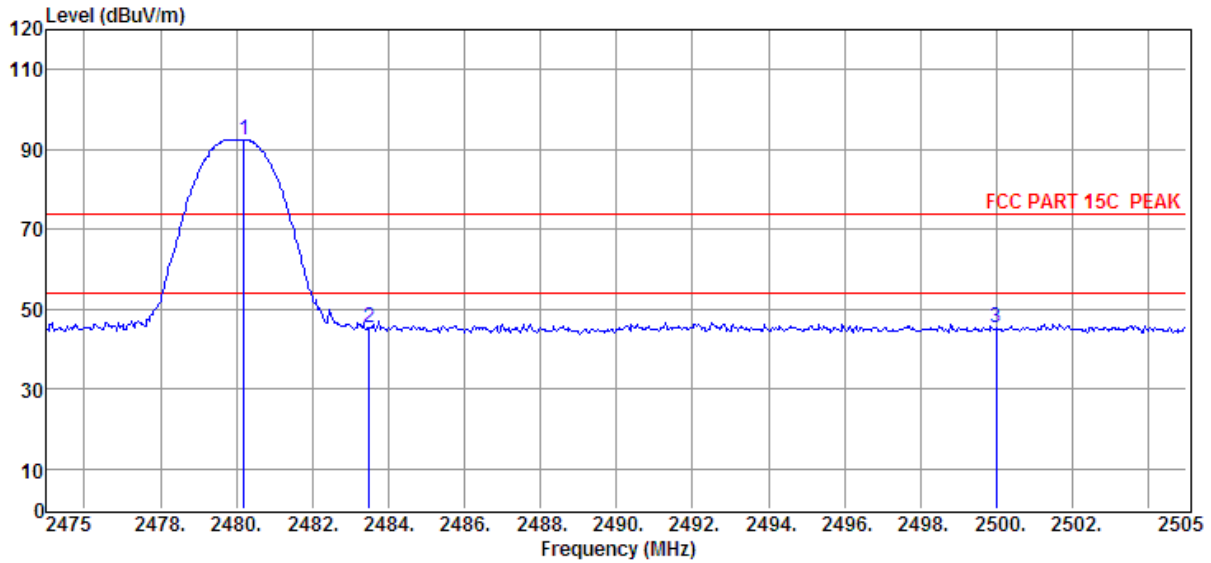

Item (Mark)	Freq (MHz)	Read Level (dBμV)	Antenna Factor (dB/m)	PRM Factor dB	Cable Loss dB	Result Level (dBμV/m)	Limit Line (dBμV/m)	Over Limit (dB)	Detector	Polarization
1	2480.19	100.31	29.18	43.50	6.57	92.56	74.00	18.56	Peak	VERTICAL
2	2483.50	53.08	29.18	43.50	6.57	45.33	74.00	-28.67	Peak	VERTICAL
3	2500.00	53.03	29.25	43.50	6.59	45.37	74.00	-28.63	Peak	VERTICAL

Note1: Result Level = Read Level + Antenna Factor + Cable loss - PRM Factor

Note2: If Peak Result complies with AV limit, AV Result is deemed to comply with AV limit

Radiated Emission Test Result

Test Site	: 3m Chamber	E:\D\12Q0017\ACSH216.EM6
Test Date	: 2012/05/02	Tested By : TaTa Chen
EUT	: BLUETOOTH SPEAKER	Model Number : B3D
Power Supply	: DC 5V from PC	Test Mode : GFSK Tx 2402MHz
Condition	: 23*C/54%	Antenna/Distance : 3115(0911)/3m/VERTICAL

Data: 35

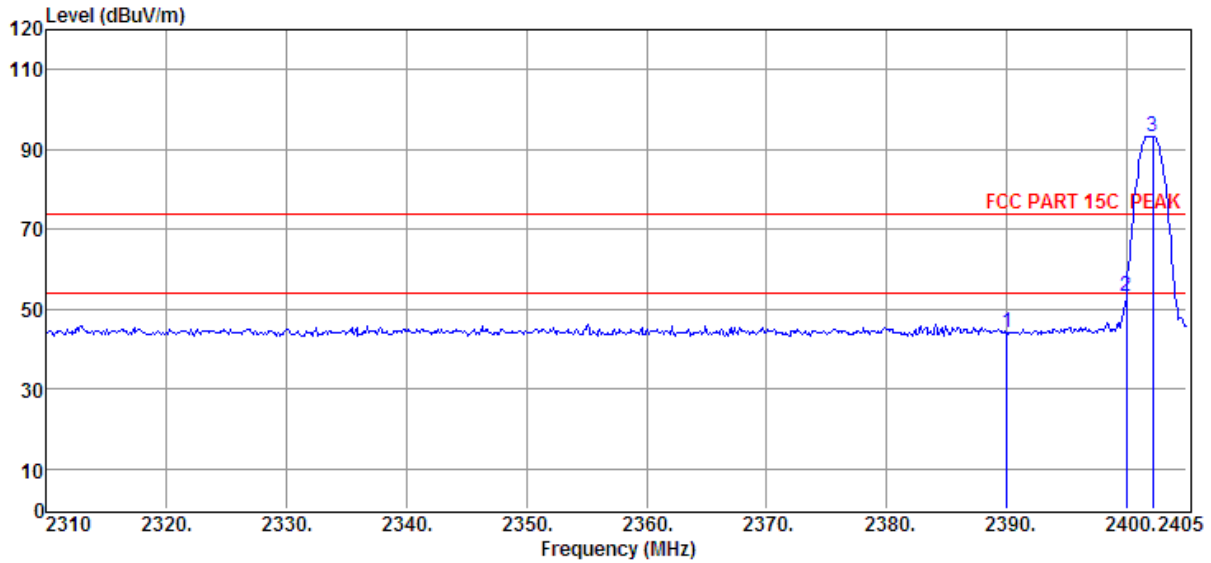

Item (Mark)	Freq (MHz)	Read Level (dBμV)	Antenna Factor (dB/m)	PRM Factor dB	Cable Loss dB	Result Level (dBμV/m)	Limit Line (dBμV/m)	Over Limit (dB)	Detector	Polarization
1	2390.00	52.50	28.70	43.48	6.47	44.19	74.00	-29.81	Peak	VERTICAL
2	2400.00	61.18	28.93	43.49	6.47	53.09	74.00	-20.91	Peak	VERTICAL
3	2402.15	101.48	28.93	43.49	6.47	93.39	74.00	19.39	Peak	VERTICAL

Note1: Result Level = Read Level + Antenna Factor + Cable loss - PRM Factor

Note2: If Peak Result complies with AV limit, AV Result is deemed to comply with AV limit

Radiated Emission Test Result

Test Site	: 3m Chamber	E:\D\12Q0017\ACSH216.EM6
Test Date	: 2012/05/02	Tested By : TaTa Chen
EUT	: BLUETOOTH SPEAKER	Model Number : B3D
Power Supply	: DC 5V from PC	Test Mode : GFSK Tx 2402MHz
Condition	: 23*C/54%	Antenna/Distance : 3115(0911)/3m/HORIZONTAL

Data: 36

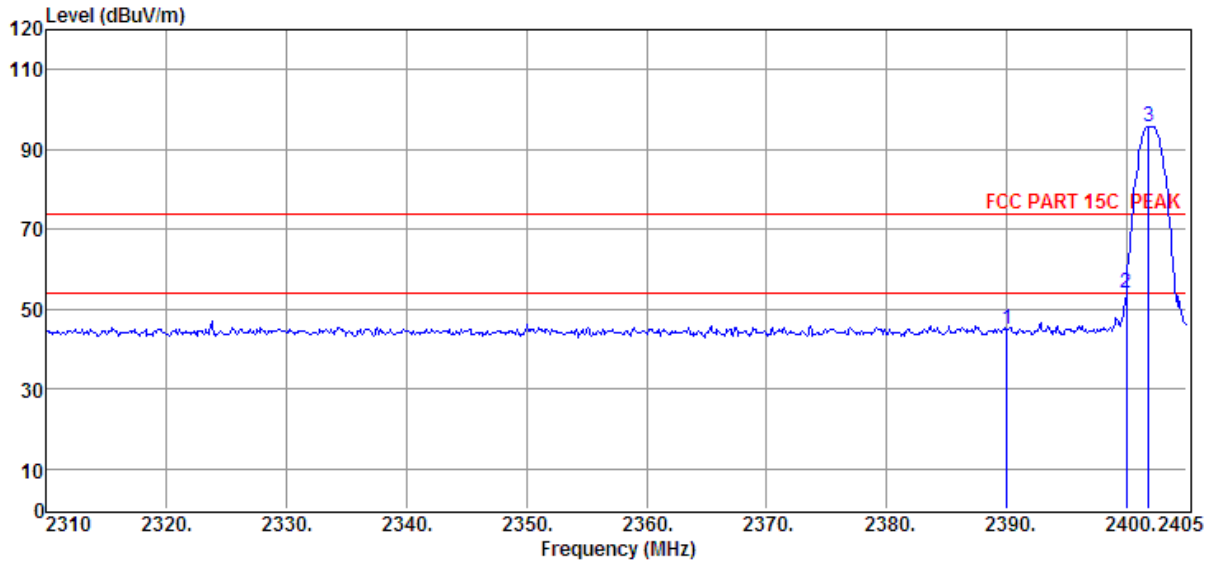

Item (Mark)	Freq (MHz)	Read Level (dBμV)	Antenna Factor (dB/m)	PRM Factor dB	Cable Loss dB	Result Level (dBμV/m)	Limit Line (dBμV/m)	Over Limit (dB)	Detector	Polarization
1	2390.00	53.33	28.70	43.48	6.47	45.02	74.00	-28.98	Peak	HORIZONTAL
2	2400.00	62.25	28.93	43.49	6.47	54.16	74.00	-19.84	Peak	HORIZONTAL
3	2401.87	103.95	28.93	43.49	6.47	95.86	74.00	21.86	Peak	HORIZONTAL

Note1: Result Level = Read Level + Antenna Factor + Cable loss - PRM Factor

Note2: If Peak Result complies with AV limit, AV Result is deemed to comply with AV limit

Radiated Emission Test Result

Test Site	: 3m Chamber	E:\D\12Q0017\ACSH216.EM6
Test Date	: 2012/05/02	Tested By : TaTa Chen
EUT	: BLUETOOTH SPEAKER	Model Number : B3D
Power Supply	: DC 5V from PC	Test Mode : GFSK Hopping ON
Condition	: 23*C/54%	Antenna/Distance : 3115(0911)/3m/HORIZONTAL

Data: 37

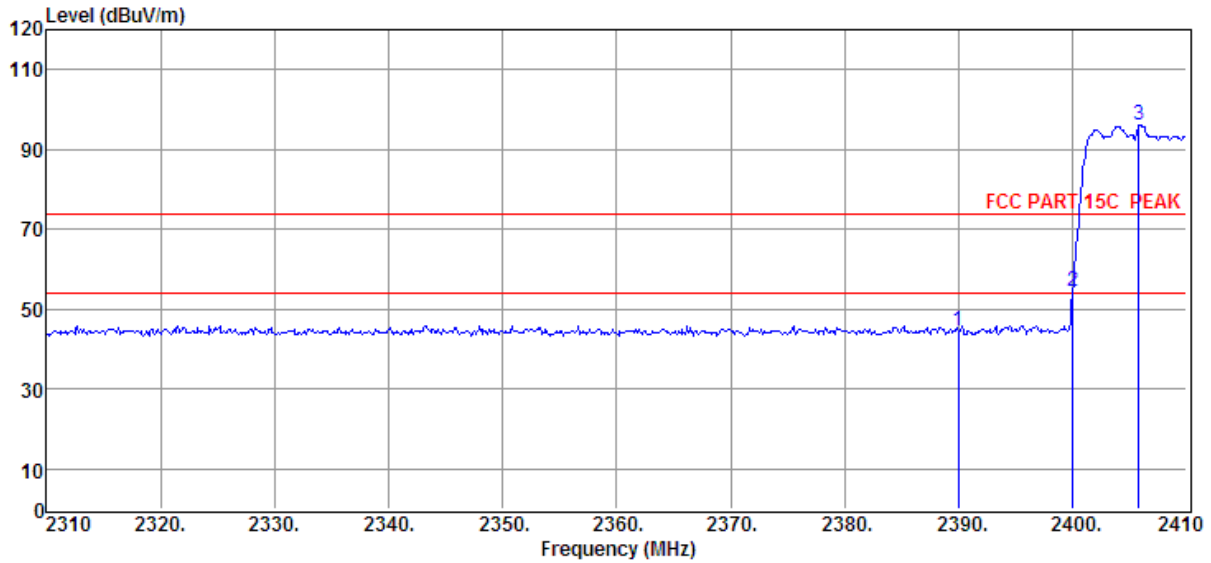

Item (Mark)	Freq (MHz)	Read Level (dBμV)	Antenna Factor (dB/m)	PRM Factor dB	Cable Loss dB	Result Level (dBμV/m)	Limit Line (dBμV/m)	Over Limit (dB)	Detector	Polarization
1	2390.00	52.86	28.70	43.48	6.47	44.55	74.00	-29.45	Peak	HORIZONTAL
2	2400.00	62.43	28.93	43.49	6.47	54.34	74.00	-19.66	Peak	HORIZONTAL
3	2405.80	104.12	28.93	43.49	6.49	96.05	74.00	22.05	Peak	HORIZONTAL

Note1: Result Level = Read Level + Antenna Factor + Cable loss - PRM Factor

Note2: If Peak Result complies with AV limit, AV Result is deemed to comply with AV limit

Radiated Emission Test Result

Test Site	: 3m Chamber	E:\D\12Q0017\ACSH216.EM6
Test Date	: 2012/05/02	Tested By : TaTa Chen
EUT	: BLUETOOTH SPEAKER	Model Number : B3D
Power Supply	: DC 5V from PC	Test Mode : GFSK Hopping ON
Condition	: 23*C/54%	Antenna/Distance : 3115(0911)/3m/VERTICAL

Data: 38

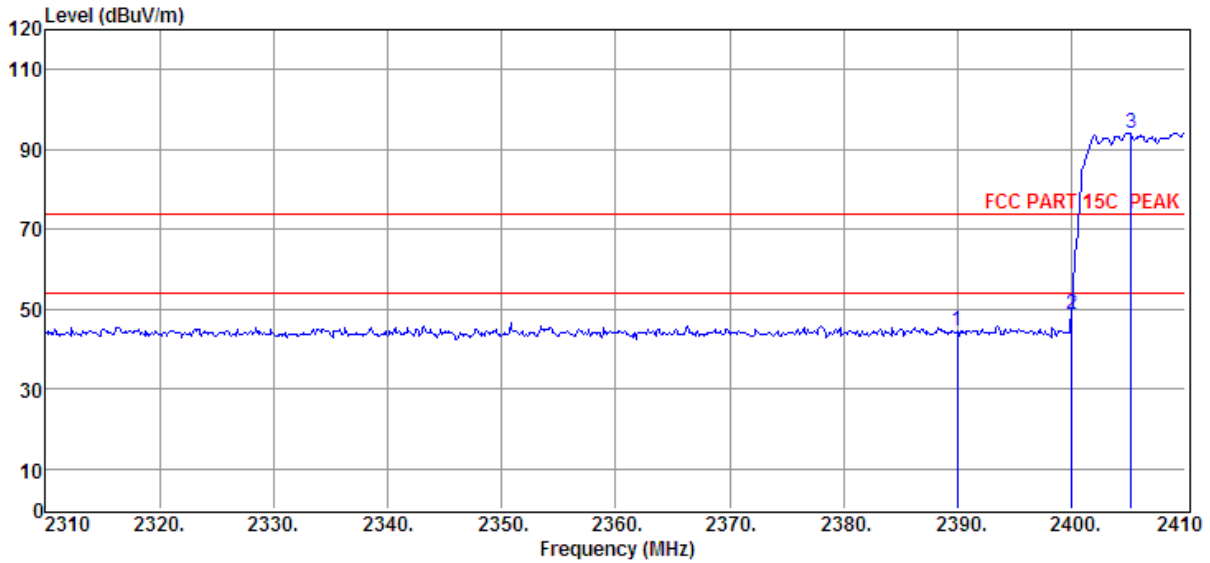

Item (Mark)	Freq (MHz)	Read Level (dBμV)	Antenna Factor (dB/m)	PRM Factor dB	Cable Loss dB	Result Level (dBμV/m)	Limit Line (dBμV/m)	Over Limit (dB)	Detector	Polarization
1	2390.00	52.77	28.70	43.48	6.47	44.46	74.00	-29.54	Peak	VERTICAL
2	2400.00	56.60	28.93	43.49	6.47	48.51	74.00	-25.49	Peak	VERTICAL
3	2405.20	102.01	28.93	43.49	6.49	93.94	74.00	19.94	Peak	VERTICAL

Note1: Result Level = Read Level + Antenna Factor + Cable loss - PRM Factor

Note2: If Peak Result complies with AV limit, AV Result is deemed to comply with AV limit

Radiated Emission Test Result

Test Site	: 3m Chamber	E:\D\12Q0017\ACSH216.EM6
Test Date	: 2012/05/02	Tested By : TaTa Chen
EUT	: BLUETOOTH SPEAKER	Model Number : B3D
Power Supply	: DC 5V from PC	Test Mode : GFSK Hopping ON
Condition	: 23*C/54%	Antenna/Distance : 3115(0911)/3m/VERTICAL

Data: 39

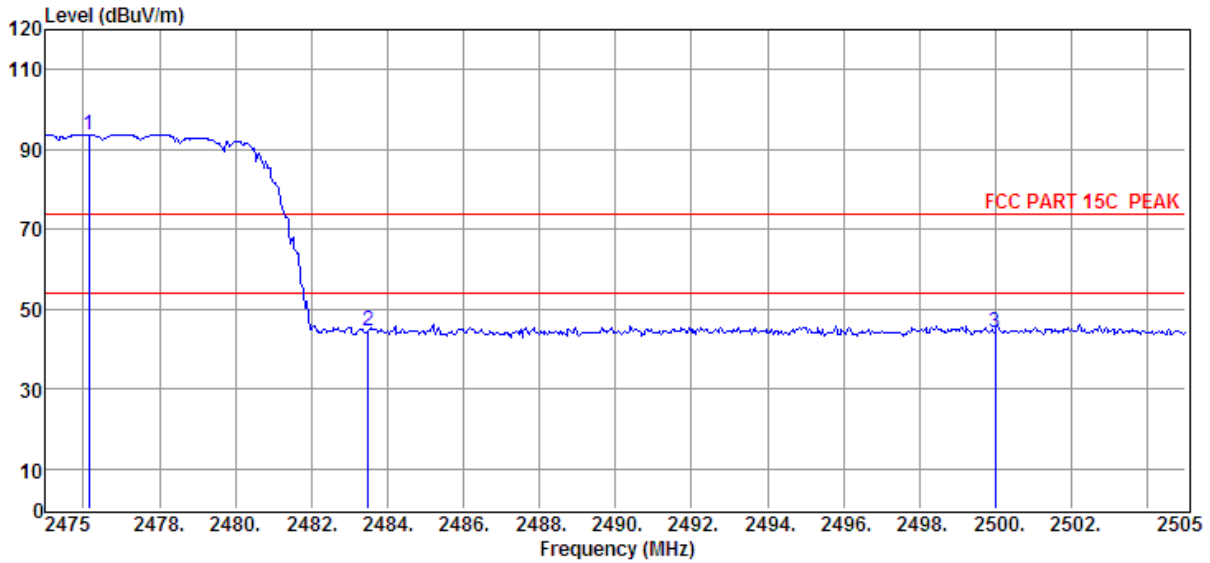

Item (Mark)	Freq (MHz)	Read Level (dBμV)	Antenna Factor (dB/m)	PRM Factor dB	Cable Loss dB	Result Level (dBμV/m)	Limit Line (dBμV/m)	Over Limit (dB)	Detector	Polarization
1	2476.14	101.59	29.13	43.49	6.57	93.80	74.00	19.80	Peak	VERTICAL
2	2483.50	52.22	29.18	43.50	6.57	44.47	74.00	-29.53	Peak	VERTICAL
3	2500.00	51.94	29.25	43.50	6.59	44.28	74.00	-29.72	Peak	VERTICAL

Note1: Result Level = Read Level + Antenna Factor + Cable loss - PRM Factor

Note2: If Peak Result complies with AV limit, AV Result is deemed to comply with AV limit

Radiated Emission Test Result

Test Site	: 3m Chamber	E:\D\12Q0017\ACSH216.EM6
Test Date	: 2012/05/02	Tested By : TaTa Chen
EUT	: BLUETOOTH SPEAKER	Model Number : B3D
Power Supply	: DC 5V from PC	Test Mode : GFSK Hopping ON
Condition	: 23*C/54%	Antenna/Distance : 3115(0911)/3m/HORIZONTAL

Data: 40

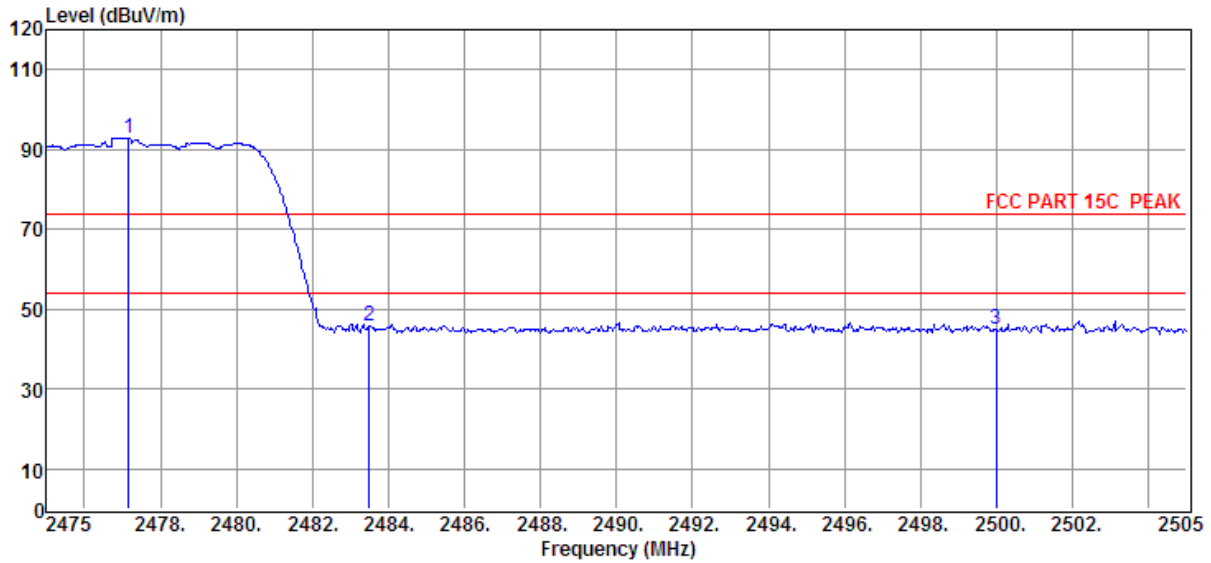

Item (Mark)	Freq (MHz)	Read Level (dBμV)	Antenna Factor (dB/m)	PRM Factor dB	Cable Loss dB	Result Level (dBμV/m)	Limit Line (dBμV/m)	Over Limit (dB)	Detector	Polarization
1	2477.16	100.70	29.18	43.49	6.57	92.96	74.00	18.96	Peak	HORIZONTAL
2	2483.50	53.36	29.18	43.50	6.57	45.61	74.00	-28.39	Peak	HORIZONTAL
3	2500.00	52.47	29.25	43.50	6.59	44.81	74.00	-29.19	Peak	HORIZONTAL

Note1: Result Level = Read Level + Antenna Factor + Cable loss - PRM Factor

Note2: If Peak Result complies with AV limit, AV Result is deemed to comply with AV limit

10. Power Line Conducted Emission

10.1. Test equipment

Item	Equipment	Manufacturer	Model No.	Serial No.	Last Cal.	Cal. Interval
1	Test Receiver	R&S	ESU8	100316	2011/11/23	1 Year
2	LISN 1	R&S	ENV216	101109	2011/11/23	1 Year
3	LISN 2	R&S	ESH2-Z5	100309	2011/11/23	1 Year
4	Pulse Limiter	R&S	ESH3-Z2	101242	2011/11/23	1 Year
5	Test software	Audix	E3	/	/	/

10.2. Block diagram of test setup

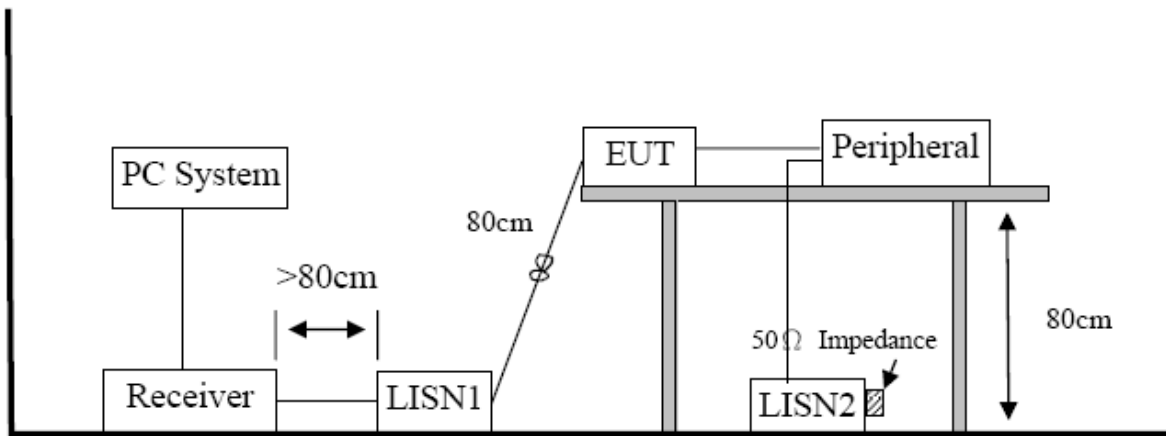

10.3. Power Line Conducted Emission Limits(Class B)

Frequency	Quasi-Peak Level dB(μV)	Average Level dB(μV)
150kHz ~ 500kHz	66 ~ 56*	56 ~ 46*
500kHz ~ 5MHz	56	46
5MHz ~ 30MHz	60	50

Note 1: * Decreasing linearly with logarithm of frequency.

Note 2: The lower limit shall apply at the transition frequencies.

10.4. Test Procedure

The EUT and Support equipment, if needed, were put placed on a non-metallic table, 80cm above the ground plane.

Configuration EUT to simulate typical usage as described in clause 2.4 and test equipment as described in clause 10.2 of this report.

All I/O cables were positioned to simulate typical actual usage as per ANSI C63.4.

All support equipment power received from a second LISN.

Emissions were measured on each current carrying line of the EUT using an EMI Test Receiver connected to the LISN powering the EUT.

The Receiver scanned from 150 kHz to 30MHz for emissions in each of the test modes.

During the above scans, the emissions were maximized by cable manipulation.

The test mode(s) described in clause 2.4 were scanned during the preliminary test.

After the preliminary scan, we found the test mode producing the highest emission level.

The EUT configuration and worse cable configuration of the above highest emission levels were recorded for reference of the final test.

EUT and support equipment were set up on the test bench as per the configuration with highest emission level in the preliminary test.

A scan was taken on both power lines, Neutral and Line, recording at least the six highest emissions.

Emission frequency and amplitude were recorded into a computer in which correction factors were used to calculate the emission level and compare reading to the applicable limit.

The test data of the worst-case condition(s) was recorded.

The bandwidth of test receiver is set at 9 KHz.

10.5. Test Result

PASS. (See below detailed test result)

Note1: All emissions not reported below are too low against the prescribed limits.

Note2: "----" means average detection; "----" mans peak detection

Conducted Emission Test Result

Test Site	: 1# Shield room	E:\2012 Test Data\D\12Q0056	
Test Date	: 2012/05/02	Tested By	: Damon_Hu
EUT	: BLUETOOTH SPEAKER	Model Number	: B3D
Power Supply	: DC 5V from PC	Test Mode	: TX Mode
Condition	: Temp:24.5°C,Humi:55%	LISN	: 2012 ENV216/LINE

Data : 1

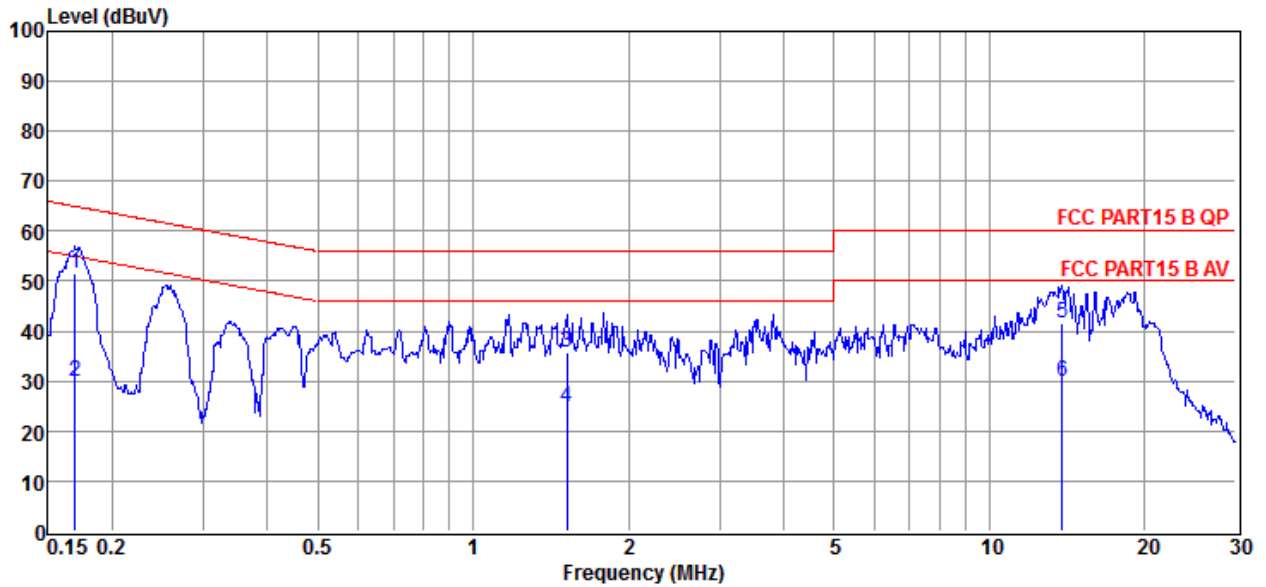

Item (Mark)	Freq (MHz)	Read Level (dBμV)	LISN Factor (dB)	Cable Loss dB	Result Level (dBμV)	Limit Line (dBμV)	Over Limit (dB)	Detector	Phase
1	0.17	41.88	9.63	0.04	51.55	64.99	-13.44	QP	LINE
2	0.17	20.20	9.63	0.04	29.87	54.99	-25.12	Average	LINE
3	1.52	26.00	9.71	0.06	35.77	56.00	-20.23	QP	LINE
4	1.52	15.00	9.71	0.06	24.77	46.00	-21.23	Average	LINE
5	13.84	31.49	9.86	0.19	41.54	60.00	-18.46	QP	LINE
6	13.84	19.99	9.86	0.19	30.04	50.00	-19.96	Average	LINE

Note: 1. Result Level = Read Level + LISN Factor + Cable loss

2. If QP Result comply with AV limit, AV Result is deemed to comply with AV limit

Conducted Emission Test Result

Test Site	: 1# Shield room	E:\2012 Test Data\D\12Q0056
Test Date	: 2012/05/02	Tested By : Damon_Hu
EUT	: BLUETOOTH SPEAKER	Model Number : B3D
Power Supply	: DC 5V from PC	Test Mode : TX Mode
Condition	: Temp:24.5°C,Humi:55%	LISN : 2012 ENV216/NEUTRAL

Data : 2

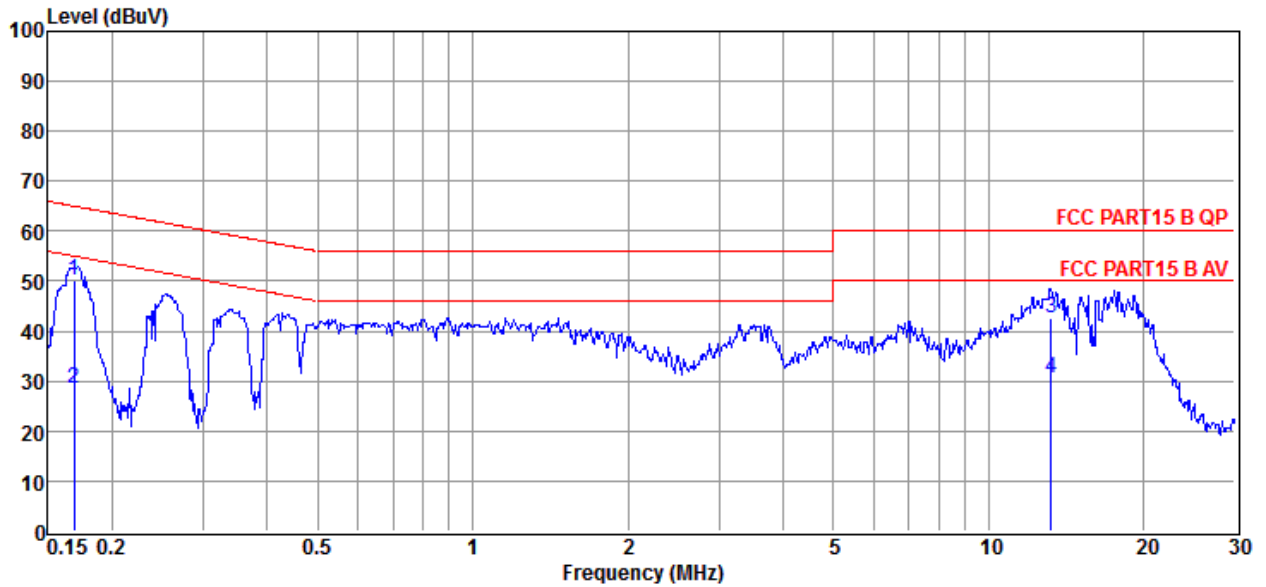

Item (Mark)	Freq (MHz)	Read Level (dBμV)	LISN Factor (dB)	Cable Loss dB	Result Level (dBμV)	Limit Line (dBμV)	Over Limit (dB)	Detector	Phase
1	0.17	40.20	9.97	0.04	50.21	65.03	-14.82	QP	NEUTRAL
2	0.17	18.50	9.97	0.04	28.51	55.03	-26.52	Average	NEUTRAL
3	13.20	32.50	9.79	0.18	42.47	60.00	-17.53	QP	NEUTRAL
4	13.20	20.68	9.79	0.18	30.65	50.00	-19.35	Average	NEUTRAL

Note: 1. Result Level = Read Level + LISN Factor + Cable loss

2. If QP Result comply with AV limit, AV Result is deemed to comply with AV limit

11. Antenna Requirements

11.1. Limit

For intentional device, according to FCC 47 CFR Section 15.203, an intentional radiator shall be designed to ensure that no antenna other than that furnished by the responsible party shall be used with the device. And according to FCC 47 CFR Section 15.247 (b), if transmitting antennas of directional gain greater than 6dBi are used, the power shall be reduced by the amount in dB that the directional gain of the antenna exceeds 6dBi.

11.2. Result

The antennas used for this product are integral Patch Antenna and that no antenna other than that furnished by the responsible party shall be used with the device, the maximum peak gain of the transmit antenna is only 0dBi.