





RADIO TEST REPORT

Test Report No.: 14800200H-A-R1

Customer	silex technology, Inc.
Description of EUT	Wireless E84 Digital Communication Unit
Model Number of EUT	WDCU-3310
FCC ID	N6C-WDCU3310H
Test Regulation	FCC Part 15 Subpart C
Test Result	Complied (Refer to SECTION 3)
Issue Date	September 28, 2023
Remarks	-

<p>Representative Test Engineer</p> <div style="text-align: center; margin: 10px 0;">  </div> <p style="text-align: center;">Takumi Nishida Engineer</p>	<p>Approved By</p> <div style="text-align: center; margin: 10px 0;">  </div> <p style="text-align: center;">Satofumi Matsuyama Engineer</p>
<div style="display: flex; justify-content: space-around; align-items: center;">   </div> <p style="text-align: right; margin-top: 5px;">CERTIFICATE 5107.02</p>	
<p><input type="checkbox"/> The testing in which "Non-accreditation" is displayed is outside the accreditation scopes in UL Japan, Inc.</p> <p><input checked="" type="checkbox"/> There is no testing item of "Non-accreditation".</p>	

Report Cover Page - Form-ULID-003532 (DCS:13-EM-F0429) Issue# 22.0

ANNOUNCEMENT

- This test report shall not be reproduced in full or partial, without the written approval of UL Japan, Inc.
- The results in this report apply only to the sample tested. (Laboratory was not involved in sampling.)
- This sample tested is in compliance with the limits of the above regulation.
- The test results in this test report are traceable to the national or international standards.
- This test report must not be used by the customer to claim product certification, approval, or endorsement by the A2LA accreditation body.
- This test report covers Radio technical requirements.
It does not cover administrative issues such as Manual or non-Radio test related Requirements. (if applicable)
- The all test items in this test report are conducted by UL Japan, Inc. Ise EMC Lab.
- The opinions and the interpretations to the result of the description in this report are outside scopes where UL Japan, Inc. has been accredited.
- The information provided from the customer for this report is identified in Section 1.
- For test report(s) referred in this report, the latest version (including any revisions) is always referred.

REVISION HISTORY

Original Test Report No.: 14800200H-A-R1

This report is a revised version of 14800200H-A. 14800200H-A is replaced with this report.

Revision	Test Report No.	Date	Page Revised Contents
- (Original)	14800200H-A	June 27, 2023	-
1	14800200H-A-R1	September 28, 2023	Section 4.1: Operating Mode(s) -Addition of explanatory note *1) for power settings
1	14800200H-A-R1	September 28, 2023	APPENDIX 1: Test Data Radiated Spurious Emission (Reference Plot for bandedge) for 2462 MHz -Correction of mode name Tx 11b 2462 MHz → Tx 2480 MHz

Reference: Abbreviations (Including words undescribed in this report)

A2LA	The American Association for Laboratory Accreditation	ICES	Interference-Causing Equipment Standard
AC	Alternating Current	IEC	International Electrotechnical Commission
AFH	Adaptive Frequency Hopping	IEEE	Institute of Electrical and Electronics Engineers
AM	Amplitude Modulation	IF	Intermediate Frequency
Amp, AMP	Amplifier	ILAC	International Laboratory Accreditation Conference
ANSI	American National Standards Institute	ISED	Innovation, Science and Economic Development Canada
Ant, ANT	Antenna	ISO	International Organization for Standardization
AP	Access Point	JAB	Japan Accreditation Board
ASK	Amplitude Shift Keying	LAN	Local Area Network
Atten., ATT	Attenuator	LIMS	Laboratory Information Management System
AV	Average	MCS	Modulation and Coding Scheme
BPSK	Binary Phase-Shift Keying	MRA	Mutual Recognition Arrangement
BR	Bluetooth Basic Rate	N/A	Not Applicable
BT	Bluetooth	NIST	National Institute of Standards and Technology
BT LE	Bluetooth Low Energy	NS	No signal detect.
BW	BandWidth	NSA	Normalized Site Attenuation
Cal Int	Calibration Interval	NVLAP	National Voluntary Laboratory Accreditation Program
CCK	Complementary Code Keying	OBW	Occupied Band Width
Ch., CH	Channel	OFDM	Orthogonal Frequency Division Multiplexing
CISPR	Comite International Special des Perturbations Radioelectriques	P/M	Power meter
CW	Continuous Wave	PCB	Printed Circuit Board
DBPSK	Differential BPSK	PER	Packet Error Rate
DC	Direct Current	PHY	Physical Layer
D-factor	Distance factor	PK	Peak
DFS	Dynamic Frequency Selection	PN	Pseudo random Noise
DQPSK	Differential QPSK	PRBS	Pseudo-Random Bit Sequence
DSSS	Direct Sequence Spread Spectrum	PSD	Power Spectral Density
EDR	Enhanced Data Rate	QAM	Quadrature Amplitude Modulation
EIRP, e.i.r.p.	Equivalent Isotropically Radiated Power	QP	Quasi-Peak
EMC	ElectroMagnetic Compatibility	QPSK	Quadri-Phase Shift Keying
EMI	ElectroMagnetic Interference	RBW	Resolution Band Width
EN	European Norm	RDS	Radio Data System
ERP, e.r.p.	Effective Radiated Power	RE	Radio Equipment
EU	European Union	RF	Radio Frequency
EUT	Equipment Under Test	RMS	Root Mean Square
Fac.	Factor	RSS	Radio Standards Specifications
FCC	Federal Communications Commission	Rx	Receiving
FHSS	Frequency Hopping Spread Spectrum	SA, S/A	Spectrum Analyzer
FM	Frequency Modulation	SG	Signal Generator
Freq.	Frequency	SVSWR	Site-Voltage Standing Wave Ratio
FSK	Frequency Shift Keying	TR	Test Receiver
GFSK	Gaussian Frequency-Shift Keying	Tx	Transmitting
GNSS	Global Navigation Satellite System	VBW	Video BandWidth
GPS	Global Positioning System	Vert.	Vertical
Hori.	Horizontal	WLAN	Wireless LAN

CONTENTS	PAGE
SECTION 1: Customer Information	5
SECTION 2: Equipment Under Test (EUT)	5
SECTION 3: Test Specification, Procedures & Results	6
SECTION 4: Operation of EUT during testing	9
SECTION 5: Conducted Emission	13
SECTION 6: Radiated Spurious Emission	14
SECTION 7: Antenna Terminal Conducted Tests	16
APPENDIX 1: Test Data	17
Conducted Emission.....	17
99 % Occupied Bandwidth and 6 dB Bandwidth.....	18
Maximum Peak Output Power	20
Average Output Power.....	21
Radiated Spurious Emission	23
Conducted Spurious Emission.....	29
Power Density.....	30
APPENDIX 2: Test Instruments	32
APPENDIX 3: Photographs of Test Setup	34
Conducted Emission.....	34
Radiated Spurious Emission	35
Worst Case Position	36
Antenna Terminal Conducted Tests.....	37

SECTION 1: Customer Information

Company Name	silex technology, Inc.
Address	2-3-1 Hikaridai, Seika-cho, Soraku-gun, Kyoto 619-0237, Japan
Telephone Number	+81-774-98-3878
Contact Person	Yoshinori Nakai

The information provided from the customer is as follows;

- Customer, Description of EUT, Model Number of EUT, FCC ID on the cover and other relevant pages
- Operating/Test Mode(s) (Mode(s)) on all the relevant pages
- SECTION 1: Customer Information
- SECTION 2: Equipment Under Test (EUT) other than the Receipt Date and Test Date
- SECTION 4: Operation of EUT during testing

* The laboratory is exempted from liability of any test results affected from the above information in SECTION 2 and 4.

SECTION 2: Equipment Under Test (EUT)

2.1 Identification of EUT

Description	Wireless E84 Digital Communication Unit
Model Number	WDCU-3310
Serial Number	Refer to SECTION 4.2
Condition	Production prototype (Not for Sale: This sample is equivalent to mass-produced items.)
Modification	No Modification by the test lab
Receipt Date	May 14, 2023
Test Date	May 17 to 28, 2023

2.2 Product Description

General Specification

Rating	DC 24 V
--------	---------

Radio Specification

Short-Range Wireless 2.4 GHz *

Equipment Type	Transceiver
Frequency of Operation	2403 MHz to 2480 MHz
Type of Modulation	FSK
Antenna Gain	6.4 dBi

Short-Range Wireless 5.8 GHz

Equipment Type	Transceiver
Frequency of Operation	5731 MHz to 5872 MHz
Type of Modulation	FSK
Antenna Gain	1.9 dBi

* This test report applies to 2.4 GHz Band.

SECTION 3: Test Specification, Procedures & Results

3.1 Test Specification

Test Specification	FCC Part 15 Subpart C The latest version on the first day of the testing period
Title	FCC 47 CFR Part 15 Radio Frequency Device Subpart C Intentional Radiators Section 15.207 Conducted limits Section 15.247 Operation within the bands 902-928 MHz, 2400-2483.5 MHz, and 5725-5850 MHz

*The customer has declared that the EUT has complies with FCC Part 15 Subpart B as SDoC.

3.2 Procedures and Results

Item	Test Procedure	Specification	Worst Margin	Results	Remarks
Conducted Emission	FCC: ANSI C63.10-2013 6. Standard test methods ISED: RSS-Gen 8.8	FCC: Section 15.207 ----- ISED: RSS-Gen 8.8	8.52 dB, 24.00012 MHz, N, AV	Complied	-
6dB Bandwidth	FCC: KDB 558074 D01 15.247 Meas Guidance v05r02 ISED: -	FCC: Section 15.247(a)(2) ----- ISED: RSS-247 5.2(a)	See data.	Complied	Conducted
Maximum Peak Output Power	FCC: KDB 558074 D01 15.247 Meas Guidance v05r02 ISED: RSS-Gen 6.12	FCC: Section 15.247(b)(3) ----- ISED: RSS-247 5.4(d)		Complied	Conducted
Power Density	FCC: KDB 558074 D01 15.247 Meas Guidance v05r02 ISED: -	FCC: Section 15.247(e) ----- ISED: RSS-247 5.2(b)		Complied	Conducted
Spurious Emission Restricted Band Edges	FCC: KDB 558074 D01 15.247 Meas Guidance v05r02 ISED: RSS-Gen 6.13	FCC: Section 15.247(d) ----- ISED: RSS-247 5.5 RSS-Gen 8.9 RSS-Gen 8.10	5.4 dB 55.8 MHz, QP, Vertical	Complied	Conducted (below 30 MHz)/ Radiated (above 30 MHz) *1)
<p>Note: UL Japan, Inc.'s EMI Work Procedures: Work Instructions-ULID-003591 and Work Instructions-ULID-003593. * In case any questions arise about test procedure, ANSI C63.10: 2013 is also referred. *1) Radiated test was selected over 30 MHz based on section 15.247(d) and KDB 558074 D01 15.247 Meas Guidance v05r02 8.5 and 8.6.</p>					

FCC Part 15.31 (e)

This EUT provides stable voltage constantly to RF Module regardless of input voltage. Therefore, this EUT complies with the requirement.

FCC Part 15.203 Antenna requirement

The EUT has an external antenna connector, but it is installed by the professionals. Therefore, the equipment complies with the antenna requirement of Section 15.203.

3.3 Addition to Standard

Item	Test Procedure	Specification	Worst Margin	Results	Remarks
99% Occupied Bandwidth	ISED: RSS-Gen 6.7	ISED: -	N/A	-	Conducted

Other than above, no addition, exclusion nor deviation has been made from the standard.

3.4 Uncertainty

Measurement uncertainty is not taken into account when stating conformity with a specified requirement. Note: When margins obtained from test results are less than the measurement uncertainty, the test results may exceed the limit.

The following uncertainties have been calculated to provide a confidence level of 95 % using a coverage factor $k = 2$.

Conducted emission

Item	Frequency Range	Unit	Calculated Uncertainty (+/-)
AMN (LISN)	0.009 MHz to 0.15 MHz	dB	3.7
	0.15 MHz to 30 MHz	dB	3.3

Radiated emission

Measurement distance	Frequency Range	Unit	Calculated Uncertainty (+/-)
3 m	9 kHz to 30 MHz	dB	3.3
10 m		dB	3.1
3 m	30 MHz to 200 MHz	Horizontal	4.8
		Vertical	5.0
	200 MHz to 1000 MHz	Horizontal	5.1
		Vertical	6.2
10 m	30 MHz to 200 MHz	Horizontal	4.8
		Vertical	4.8
	200 MHz to 1000 MHz	Horizontal	4.9
		Vertical	5.0
3 m	1 GHz to 6 GHz	dB	4.9
	6 GHz to 18 GHz	dB	5.2
1 m	10 GHz to 26.5 GHz	dB	5.5
	26.5 GHz to 40 GHz	dB	5.4
10 m	1 GHz to 18 GHz	dB	5.3

Antenna Terminal Conducted Tests

Item	Unit	Calculated Uncertainty (+/-)
Antenna Terminated Conducted Emission / Power Density / Burst Power	dB	3.28
Adjacent Channel Power (ACP)	dB	2.27
Bandwidth (OBW)	%	0.96
Time Readout (Time span upto 100 msec)	%	0.11
Time Readout (Time span upto 1000 msec)	%	0.11
Time Readout (Time span upto 60 sec)	%	0.02
Power Measurement (Power meter)	dB	1.50
Frequency Readout (Frequency counter)	ppm	0.67
Frequency Readout (Spectrum analyzer frequency readout function)	ppm	1.61
Temperature (Constant temperature bath)	deg. C	0.78
Humidity (Constant temperature bath)	%HR	2.80
Modulation Characteristics	%	6.93
Frequency for Mobile	ppm	0.08

3.5 Test Location

UL Japan, Inc. Ise EMC Lab.

*A2LA Certificate Number: 5107.02 / FCC Test Firm Registration Number: 884919

ISED Lab Company Number: 2973C / CAB identifier: JP0002

4383-326 Asama-cho, Ise-shi, Mie-ken 516-0021 Japan

Telephone: +81-596-24-8999

Test site	Width x Depth x Height (m)	Size of reference ground plane (m) / horizontal conducting plane	Other rooms	Maximum measurement distance
No.1 semi-anechoic chamber	19.2 x 11.2 x 7.7	7.0 x 6.0	No.1 Power source room	10 m
No.2 semi-anechoic chamber	7.5 x 5.8 x 5.2	4.0 x 4.0	-	3 m
No.3 semi-anechoic chamber	12.0 x 8.5 x 5.9	6.8 x 5.75	No.3 Preparation room	3 m
No.3 shielded room	4.0 x 6.0 x 2.7	N/A	-	-
No.4 semi-anechoic chamber	12.0 x 8.5 x 5.9	6.8 x 5.75	No.4 Preparation room	3 m
No.4 shielded room	4.0 x 6.0 x 2.7	N/A	-	-
No.5 semi-anechoic chamber	6.0 x 6.0 x 3.9	6.0 x 6.0	-	-
No.5 measurement room	6.4 x 6.4 x 3.0	6.4 x 6.4	-	-
No.6 shielded room	4.0 x 4.5 x 2.7	4.0 x 4.5	-	-
No.6 measurement room	4.75 x 5.4 x 3.0	4.75 x 4.15	-	-
No.7 shielded room	4.7 x 7.5 x 2.7	4.7 x 7.5	-	-
No.8 measurement room	3.1 x 5.0 x 2.7	3.1 x 5.0	-	-
No.9 measurement room	8.8 x 4.6 x 2.8	2.4 x 2.4	-	-
No.10 shielded room	3.8 x 2.8 x 2.8	3.8 x 2.8	-	-
No.11 measurement room	4.0 x 3.4 x 2.5	N/A	-	-
No.12 measurement room	2.6 x 3.4 x 2.5	N/A	-	-
Large Chamber	16.9 x 22.1 x 10.17	16.9 x 22.1	-	10 m
Small Chamber	5.3 x 6.69 x 3.59	5.3 x 6.69	-	-

* Size of vertical conducting plane (for Conducted Emission test) : 2.0 x 2.0 m for No.1, No.2, No.3, and No.4 semi-anechoic chambers and No.3 and No.4 shielded rooms.

3.6 Test Data, Test Instruments, and Test Set Up

Refer to APPENDIX.

SECTION 4: Operation of EUT during testing

4.1 Operating Mode(s)

Mode	Remarks*
Transmitting (2.4 GHz)	Tx
*Transmitting duty was 100 % on all tests.	
*Power of the EUT was set by the software as follows;	
Power settings: 0 dBm (All Tests) , -20dBm (Maximum Peak Output Power only *1))	
*1) In the radiated spurious emission test when the power setting value was -20 dBm, the test was not conducted because the level of any unwanted emissions was confirmed not to exceed the level of the fundamental frequency by pre-test.	
Software: TeraTerm Ver 4.99.0.0 (Date: 2016.2.16, Storage location: Driven by connected PC)	
*This setting of software is the worst case. Any conditions under the normal use do not exceed the condition of setting. In addition, end users cannot change the settings of the output power of the product.	

*The details of Operating mode(s)

Test Item	Operating Mode	Tested Frequency
Conducted emission, Radiated Spurious Emission (Below 1 GHz),	Tx	2403 MHz *1)
Radiated Spurious Emission (Above 1 GHz), Conducted Spurious Emission, 6dB Bandwidth, Maximum Peak Output Power, Power Density, 99% Occupied Bandwidth, Conducted Spurious Emission	Tx	2403 MHz 2440 MHz 2480 MHz
*1) The mode was tested as a representative, because it had the highest power at antenna terminal test.		

4.2 Configuration and Peripherals

Conducted Emission Test and Radiated Emission Test

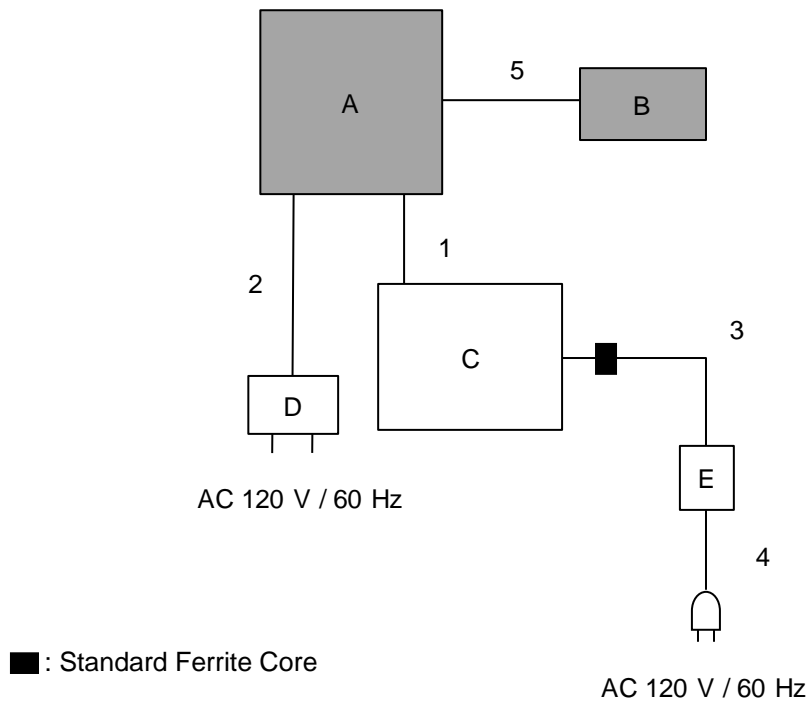

* Cabling and setup(s) were taken into consideration and test data was taken under worse case conditions.

*As a result of comparing AC 120 V and AC 240 V at pre-check, conducted emission test was performed with AC 120 V of the worst voltage as representative.

Description of EUT and Support Equipment

No.	Item	Model number	Serial Number	Manufacturer	Remarks
A	Wireless E84 Digital Communication Unit	WDCU-3310	CS6_No.05	silex technology, Inc.	EUT
B	Antenna	JUM2458PO_W1	001	Sakuma Antenna	EUT
C	Laptop PC	CF-N8HWCDPS	9LKSA04645	Panasonic	*1)
		X1 Carbon	R9-OH8OTU 15/9	Lenovo Corporation	*2)
D	AC Adapter	WB-18D12R	Y19490019654	Asian Power Devices Inc.	-
E	AC Adapter	CF-AA6372B	6372BM610214975E	Panasonic	*1)
		ADXL45NCC2A	11S45N0299 Z1ZS944B6KBR	Lenovo Corporation	*2)

*1) Used for Conducted Emission test

*2) Used for Radiated Emission test

List of Cables Used

No.	Name	Length (m)	Shield		Remarks
			Cable	Connector	
1	RS-232C Cable	1.1	Shielded	Shielded	-
2	DC Cable	1.8	Unshielded	Unshielded	-
3	DC Cable	1.1	Unshielded	Unshielded	*1)
		1.7			*2)
4	AC Cable	0.9	Unshielded	Unshielded	*1)
		1.0			*2)
5	Antenna Cable	0.4	Shielded	Shielded	-

*1) Used for Conducted Emission test

*2) Used for Radiated Emission test

Antenna Terminal Conducted Test

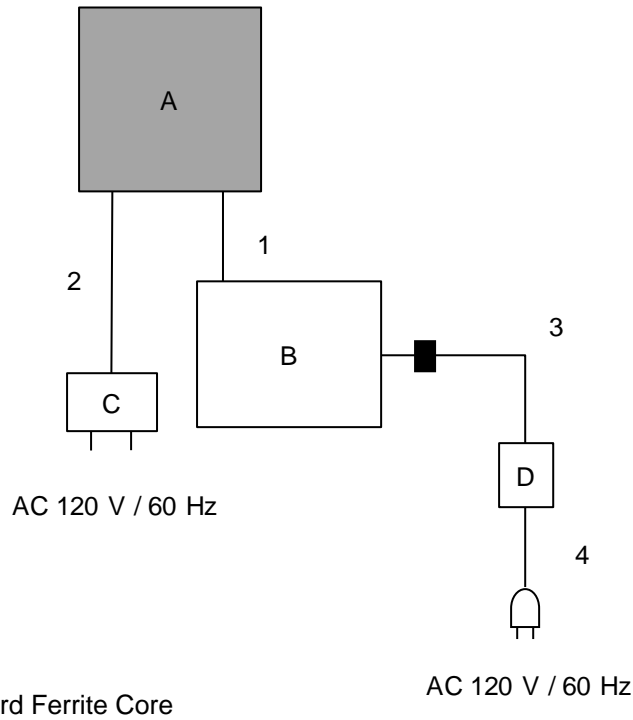

* Cabling and setup(s) were taken into consideration and test data was taken under worse case conditions.

Description of EUT and Support Equipment

No.	Item	Model Number	Serial Number	Manufacturer	Remarks
A	Wireless E84 Digital Communication Unit	WDCU-3310	CS6_No.05	silex technology, Inc.	EUT
B	Laptop PC	X1 Carbon	R9-OH8OTU 15/9	Lenovo Corporation	-
C	AC Adapter	WB-18D12R	Y19490019654	Asian Power Devices Inc.	-
D	AC Adapter	ADXL45NCC2A	11S45N0299Z1ZS 944B6KBR	Lenovo Corporation	-

List of Cables Used

No.	Name	Length (m)	Shield		Remarks
			Cable	Connector	
1	RS-232C Cable	1.1	Shielded	Shielded	-
2	DC Cable	1.8	Unshielded	Unshielded	-
3	DC Cable	1.7	Unshielded	Unshielded	-
4	AC Cable	1.0	Unshielded	Unshielded	-

SECTION 5: Conducted Emission

Test Procedure and Conditions

EUT was placed on a urethane platform of nominal size, 1.0 m by 1.5 m, raised 0.8 m above the conducting ground plane.

The rear of tabletop was located 40 cm to the vertical conducting plane. The rear of EUT, including peripherals aligned and flushed with rear of tabletop. All other surfaces of tabletop were at least 80cm from any other grounded conducting surface. EUT was located 80 cm from a Line Impedance Stabilization Network (LISN) / Artificial mains Network (AMN) and excess AC cable was bundled in center.

For the tests on EUT with other peripherals (as a whole system)

I/O cables that were connected to the peripherals were bundled in center. They were folded back and forth forming a bundle 30 cm to 40 cm long and were hanged at a 40 cm height to the ground plane. All unused 50ohm connectors of the LISN (AMN) were resistivity terminated in 50 ohm when not connected to the measuring equipment.

The AC Mains Terminal Continuous disturbance Voltage has been measured with the EUT in a Semi Anechoic Chamber.

The EUT was connected to a LISN (AMN).

An overview sweep with peak detection has been performed.

The test results and limit are rounded off to one decimal place, so some differences might be observed.

Detector	: QP and CISPR AV
Measurement Range	: 0.15 MHz to 30 MHz
Test Data	: APPENDIX
Test Result	: Pass

Figure 1: Test Setup

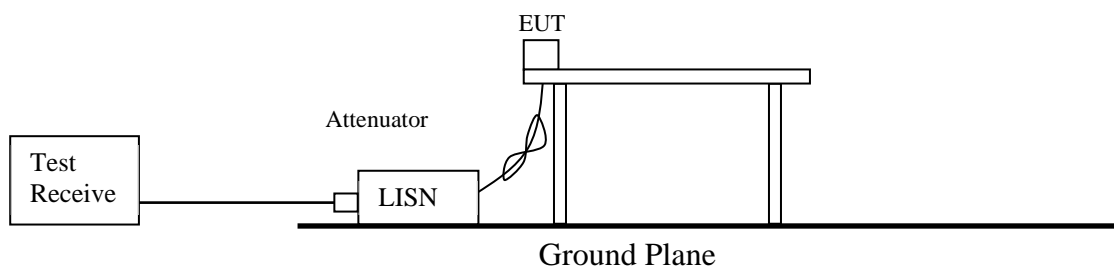

SECTION 6: Radiated Spurious Emission

Test Procedure

It was measured based on "8.5 and 8.6 of KDB 558074 D01 15.247 Meas Guidance v05r02".

[For below 1 GHz]

EUT was placed on a urethane platform of nominal size, 1.0 m by 1.5 m, raised 0.8 m above the conducting ground plane. The Radiated Electric Field Strength has been measured in a Semi Anechoic Chamber with a ground plane.

[For above 1 GHz]

EUT was placed on a urethane platform of nominal size, 0.5 m by 0.5 m, raised 1.5 m above the conducting ground plane. The Radiated Electric Field Strength has been measured in a Semi Anechoic Chamber with absorbent materials lined on a ground plane. Test antenna was aimed at the EUT for receiving the maximum signal and always kept within the illumination area of the 3 dB beamwidth of the antenna.

The height of the measuring antenna varied between 1 m and 4 m and EUT was rotated a full revolution in order to obtain the maximum value of the electric field strength.

The measurements were performed for both vertical and horizontal antenna polarization with the Test Receiver, or the Spectrum Analyzer.

The measurements were made with the following detector function of the test receiver and the Spectrum analyzer (in linear mode).

The test was made with the detector (RBW/VBW) in the following table.

When using Spectrum analyzer, the test was made with adjusting span to zero by using peak hold.

Test Antennas are used as below;

Frequency	30 MHz to 200 MHz	200 MHz to 1 GHz	Above 1 GHz
Antenna Type	Biconical	Logperiodic	Horn

In any 100 kHz bandwidth outside the restricted band in which the spread spectrum intentional radiator is operating, the radio frequency power that is produced by the intentional radiator confirmed 20 dB below that in the 100 kHz bandwidth within the band that contains the highest level of the desired power, based on a radiated measurement.

20 dBc was applied to the frequency over the limit of FCC 15.209 / Table 4 of RSS-Gen 8.9(ISED) and outside the restricted band of FCC15.205 / Table 6 of RSS-Gen 8.10 (ISED).

Frequency	Below 1 GHz	Above 1 GHz		20 dBc
Instrument Used	Test Receiver	Spectrum Analyzer		Spectrum Analyzer
Detector	QP	PK	AV	PK
IF Bandwidth	BW 120 kHz	RBW: 1 MHz VBW: 3 MHz	11.12.2.5.1 RBW: 1 MHz VBW: 3 MHz Detector: Power Averaging (RMS) Trace: 100 traces 11.12.2.5.2 The duty cycle was less than 98% for detected noise, a duty factor was added to the 11.12.2.5.1 results.	RBW: 100 kHz VBW: 300 kHz

Figure 2: Test Setup

Below 1 GHz

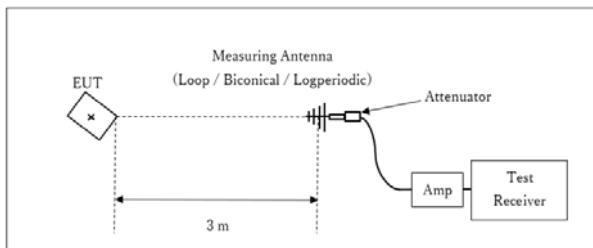

× : Center of turn table

Test Distance: 3 m

1 GHz to 10 GHz

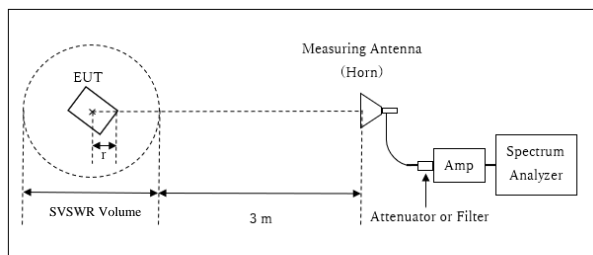

r : Radius of an outer periphery of EUT
× : Center of turn table

Distance Factor: $20 \times \log (3.65 \text{ m} / 3.0 \text{ m}) = 1.71 \text{ dB}$
* Test Distance: $(3 + \text{SVSWR Volume} / 2) - r = 3.65 \text{ m}$

SVSWR Volume : 1.5 m
(SVSWR Volume has been calibrated based on CISPR 16-1-4.)
 $r = 0.1 \text{ m}$

10 GHz to 26.5 GHz

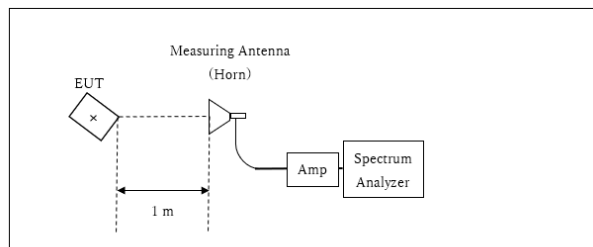

× : Center of turn table

Distance Factor: $20 \times \log (1.0 \text{ m} / 3.0 \text{ m}) = -9.5 \text{ dB}$
*Test Distance: 1 m

The carrier level and noise levels were confirmed at each position of X, Y and Z axes of EUT to see the position of maximum noise, and the test was made at the position that has the maximum noise.

The test results and limit are rounded off to one decimal place, so some differences might be observed.

Measurement Range : 30 MHz to 26.5 GHz
Test Data : APPENDIX
Test Result : Pass

SECTION 7: Antenna Terminal Conducted Tests

Test Procedure

The tests were made with below setting connected to the antenna port.

Test	Span	RBW	VBW	Sweep time	Detector	Trace	Instrument Used
6dB Bandwidth	3 MHz	100 kHz	300 kHz	Auto	Peak	Max Hold	Spectrum Analyzer
99% Occupied Bandwidth *1)	Enough width to display emission skirts	1 to 5 % of OBW	Three times of RBW	Auto	Peak	Max Hold	Spectrum Analyzer
Maximum Peak Output Power	-	-	-	Auto	Peak/Average *2)	-	Power Meter (Sensor: 50 MHz BW)
	Three times of RBW	1 MHz	Three times of RBW	Auto	Peak	Max Hold	Spectrum Analyzer
Peak Power Density	1.5 times the 6dB Bandwidth	3 kHz	10 kHz	Auto	Peak	Max Hold	Spectrum Analyzer *3)
Conducted Spurious Emission *4) *5)	9 kHz to 150 kHz	200 Hz	620 Hz	Auto	Peak	Max Hold	Spectrum Analyzer
	150 kHz to 30 MHz	9.1 kHz	27 kHz				

*1) Peak hold was applied as Worst-case measurement.

*2) Reference data

*3) Section 11.10.2 Method PKPSD (peak PSD) of "ANSI C63.10-2013".

*4) In the frequency range below 30MHz, RBW was narrowed to separate the noise contents.

Then, wide-band noise near the limit was checked separately, however the noise was not detected as shown in the chart.

(9 kHz - 150 kHz: RBW = 200 Hz, 150 kHz - 30 MHz: RBW = 9.1 kHz)

*5) The limits in CFR 47, Part 15, Subpart C, paragraph 15.209(a), are identical to those in RSS-Gen section 8.9, Table 6, since the measurements are performed in terms of magnetic field strength and converted to electric field strength levels (as reported in the table) using the free space impedance of 377 Ohms. For example, the measurement at frequency 9 kHz resulted in a level of 45.5 dBuV/m, which is equivalent to $45.5 - 51.5 = -6.0$ dBuA/m, which has the same margin, 3 dB, to the corresponding RSS-Gen Table 6 limit as it has to 15.209(a) limit.

The test results and limit are rounded off to two decimals place, so some differences might be observed. The equipment and cables were not used for factor 0 dB of the data sheets.

Test Data : **APPENDIX**

Test Result : **Pass**

APPENDIX 1: Test Data

Conducted Emission

Test place Ise EMC Lab. No.5 Semi Anechoic Chamber
Date May 26, 2023
Temperature / Humidity 22 deg. C / 57 % RH
Engineer Tetsuro Yoshida
Mode Tx 2403 MHz

Limit : FCC_Part 15 Subpart C(15.207)

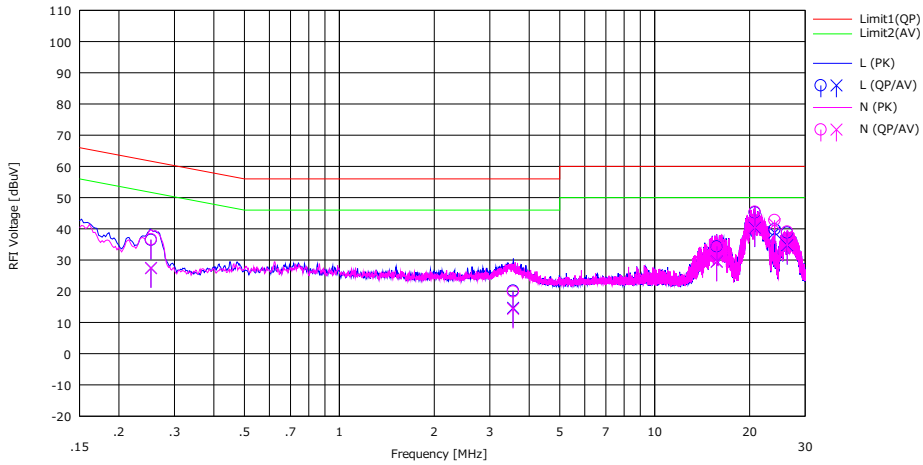

No.	Freq. [MHz]	Reading		LISN [dB]	LOSS [dB]	Results		Limit		Margin		Phase	Comment
		(QP) [dBuV]	(AV) [dBuV]			(QP) [dBuV]	(AV) [dBuV]	(QP) [dB]	(AV) [dB]	(QP) [dB]	(AV) [dB]		
1	0.25267	23.30	14.30	0.13	13.02	36.45	27.45	61.67	51.67	25.22	24.22	L	
2	3.55600	6.80	1.30	0.28	13.12	20.20	14.70	56.00	46.00	35.80	31.30	L	
3	15.73361	19.60	14.70	1.53	13.29	34.42	29.52	60.00	50.00	25.58	20.48	L	
4	20.77166	29.60	24.80	2.30	13.35	45.25	40.45	60.00	50.00	14.75	9.55	L	
5	24.00012	26.00	25.00	0.43	13.38	39.81	38.81	60.00	50.00	20.19	11.19	L	
6	26.32174	22.30	18.30	3.10	13.40	38.80	34.80	60.00	50.00	21.20	15.20	L	
7	0.25267	23.50	14.30	0.12	13.02	36.64	27.44	61.67	51.67	25.03	24.23	N	
8	3.55600	6.50	1.00	0.27	13.12	19.89	14.39	56.00	46.00	36.11	31.61	N	
9	15.73361	19.80	14.70	1.52	13.29	34.61	29.51	60.00	50.00	25.39	20.49	N	
10	20.77166	29.70	24.90	2.39	13.35	45.44	40.64	60.00	50.00	14.56	9.36	N	
11	24.00012	26.50	25.20	2.90	13.38	42.78	41.48	60.00	50.00	17.22	8.52	N	
12	26.32174	22.50	18.50	3.19	13.40	39.09	35.09	60.00	50.00	20.91	14.91	N	

CHART: WITH FACTOR Peak hold data. CALCULATION : RESULT = READING + LISN + LOSS (CABLE + ATT)
Except for the above table: adequate margin data below the limits.

99 % Occupied Bandwidth and 6 dB Bandwidth

Test place Ise EMC Lab. No.6 Measurement Room
Date May 17, 2023
Temperature / Humidity 22 deg. C / 42 % RH
Engineer Nachi Konegawa
Mode Tx

Frequency [MHz]	99 % Occupied Bandwidth [kHz]	6 dB Bandwidth [MHz]	Limit for 6 dB Bandwidth [MHz]
2403	919.7	0.502	> 0.5000
2440	917.8	0.501	> 0.5000
2480	917.7	0.501	> 0.5000

99 % Occupied Bandwidth and 6 dB Bandwidth

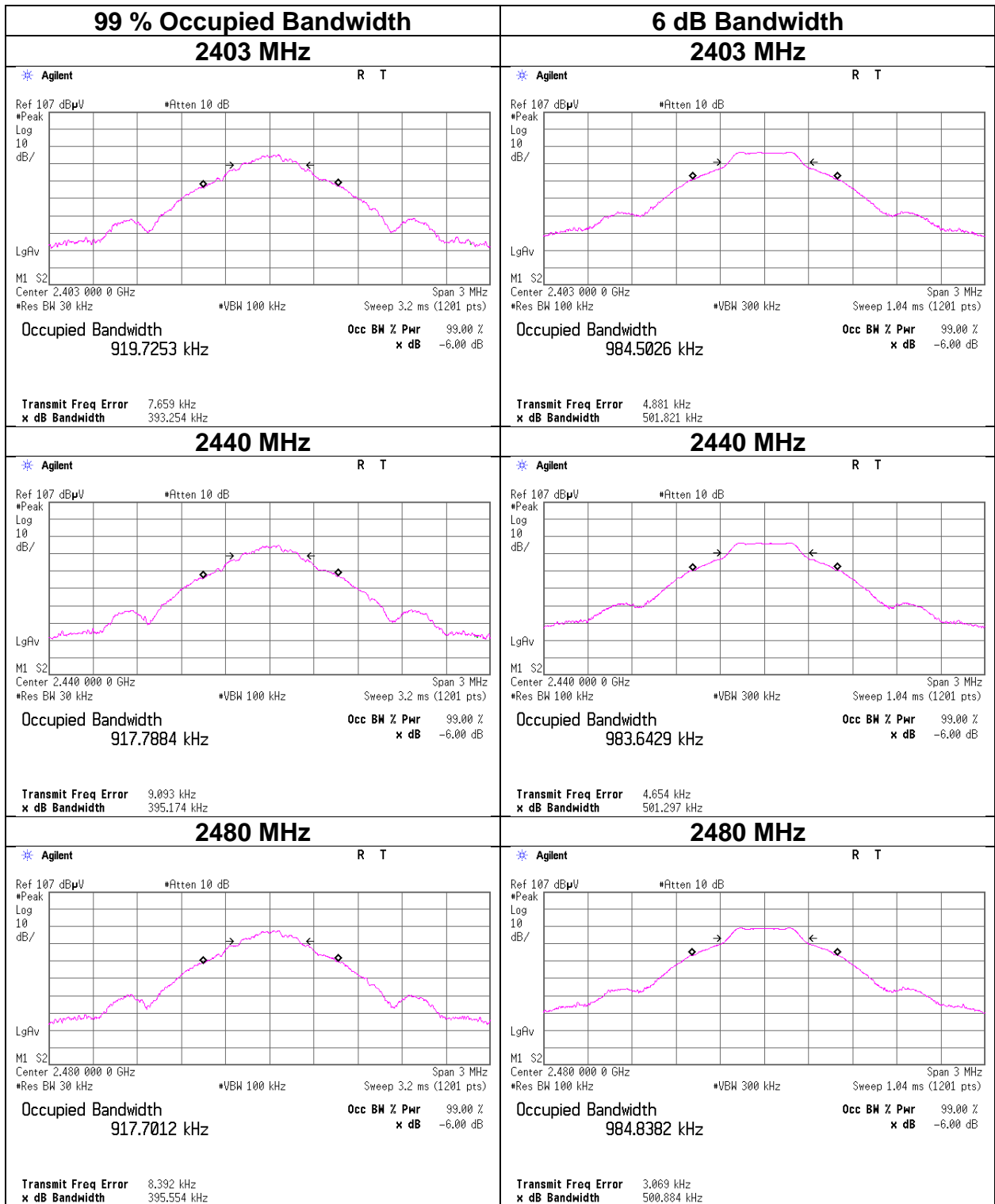

Maximum Peak Output Power

Test place	Ise EMC Lab. No.6 Measurement Room	
Date	May 17, 2023	May 18, 2023
Temperature / Humidity	22 deg. C / 42 % RH	23 deg. C / 43 % RH
Engineer	Nachi Konegawa	Nachi Konegawa
Mode	Tx	

Power setting (0 dBm)				Conducted Power					e.i.r.p. for RSS-247					
Freq. [MHz]	Reading [dBm]	Cable Loss [dB]	Atten. Loss [dB]	Result		Limit		Margin [dB]	Antenna Gain [dBi]	Result		Limit		Margin [dB]
				[dBm]	[mW]	[dBm]	[mW]			[dBm]	[mW]	[dBm]	[mW]	
2403	-12.61	1.28	0.00	-11.33	0.07	29.60	912	40.93	6.40	-4.93	0.32	36.02	4000	40.95
2440	-12.92	1.28	0.00	-11.64	0.07	29.60	912	41.24	6.40	-5.24	0.30	36.02	4000	41.26
2480	-13.33	1.29	0.00	-12.04	0.06	29.60	912	41.64	6.40	-5.64	0.27	36.02	4000	41.66

Power setting (-20 dBm)				Conducted Power					e.i.r.p. for RSS-247					
Freq. [MHz]	Reading [dBm]	Cable Loss [dB]	Atten. Loss [dB]	Result		Limit		Margin [dB]	Antenna Gain [dBi]	Result		Limit		Margin [dB]
				[dBm]	[mW]	[dBm]	[mW]			[dBm]	[mW]	[dBm]	[mW]	
2403	-32.25	1.28	0.00	-30.97	0.001	29.60	912	60.57	6.40	-24.57	0.003	36.02	4000	60.59
2440	-32.79	1.28	0.00	-31.51	0.001	29.60	912	61.11	6.40	-25.11	0.003	36.02	4000	61.13
2480	-33.53	1.29	0.00	-32.24	0.001	29.60	912	61.84	6.40	-25.84	0.003	36.02	4000	61.86

Sample Calculation:

Result = Reading + Cable Loss + Attenuator Loss

e.i.r.p. Result = Conducted Power Result + Antenna Gain

*The equipment and cables were not used for factor 0 dB of the data sheets.

Average Output Power
(Reference data for RF Exposure)

Test place	Ise EMC Lab. No.6 Measurement Room
Date	May 17, 2023
Temperature / Humidity	22 deg. C / 42 % RH
Engineer	Nachi Konegawa
Mode	Tx

Power setting (0 dBm)

Freq. [MHz]	Reading [dBm]	Cable Loss [dB]	Atten. Loss [dB]	Result (Time average)		Duty factor [dB]	Result (Burst power average)	
				[dBm]	[mW]		[dBm]	[mW]
2403	-12.98	1.28	0.00	-11.70	0.07	0.00	-11.70	0.07
2440	-13.34	1.28	0.00	-12.06	0.06	0.00	-12.06	0.06
2480	-13.80	1.29	0.00	-12.51	0.06	0.00	-12.51	0.06

Power setting (-20 dBm)

Freq. [MHz]	Reading [dBm]	Cable Loss [dB]	Atten. Loss [dB]	Result (Time average)		Duty factor [dB]	Result (Burst power average)	
				[dBm]	[mW]		[dBm]	[mW]
2403	-31.05	0.00	0.00	-31.05	0.001	0.00	-31.05	0.00
2440	-31.60	0.00	0.00	-31.60	0.001	0.00	-31.60	0.00
2480	-32.34	0.00	0.00	-32.34	0.001	0.00	-32.34	0.00

Sample Calculation:

Result (Time average) = Reading + Cable Loss + Attenuator Loss

Result (Burst power average) = Time average + Duty factor

*The equipment and cables were not used for factor 0 dB of the data sheets.

Burst rate confirmation

Test place Ise EMC Lab. No.6 Measurement Room
Date May 17, 2023
Temperature / Humidity 24 deg. C / 46 % RH
Engineer Nachi Konegawa
Mode Tx

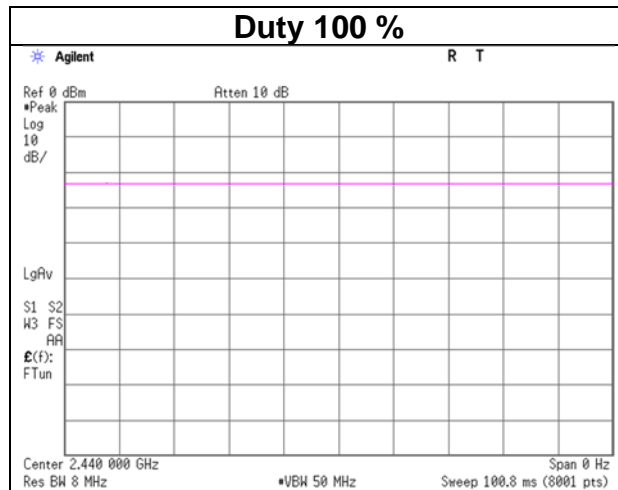

* Since the burst rate is not different between the channels, the data has been obtained on the representative channel.

Radiated Spurious Emission

Test place	Ise EMC Lab.			
Semi Anechoic Chamber	No.2	No.2	No.2	Large chamber
Date	May 23, 2023	May 25, 2023	May 28, 2023	May 28, 2023
Temperature / Humidity	24 deg. C / 34 % RH	23 deg. C / 46 % RH	25 deg. C / 42 % RH	25 deg. C / 42 % RH
Engineer	Daiki Matsui	Daiki Matsui	Takumi Nishida	Daiki Matsui
Mode	(1 GHz to 10 GHz)	(10 GHz to 18 GHz)	(18 GHz to 26.5 GHz)	Below 1 GHz
	Tx 2403 MHz			

Polarity [Hori/Vert]	Frequency [MHz]	Reading (QP / PK) [dBuV]	Reading (AV) [dBuV]	Ant. Factor [dB/m]	Loss [dB]	Gain [dB]	Duty Factor [dB]	Result (QP / PK) [dBuV/m]	Result (AV) [dBuV/m]	Limit (QP / PK) [dBuV/m]	Limit (AV) [dBuV/m]	Margin (QP / PK) [dB]	Margin (AV) [dB]	Remark
Hori.	34.1	35.0	-	12.7	7.2	33.0	-	21.8	-	40.0	-	18.2	-	
Hori.	39.3	35.1	-	11.6	7.3	33.0	-	21.0	-	40.0	-	19.1	-	
Hori.	55.8	39.5	-	9.7	7.5	33.0	-	23.7	-	40.0	-	16.3	-	
Hori.	62.5	33.4	-	9.4	7.6	33.0	-	17.4	-	40.0	-	22.6	-	
Hori.	134.7	31.9	-	11.4	8.4	33.0	-	18.8	-	43.5	-	24.7	-	
Hori.	303.4	43.4	-	12.9	9.8	32.9	-	33.1	-	46.0	-	12.9	-	
Hori.	2390.0	35.4	-	27.6	4.9	34.9	-	32.9	-	73.9	-	41.0	-	
Hori.	4806.0	42.7	33.3	31.6	7.1	34.1	-	47.3	37.9	73.9	53.9	26.6	16.0	Floor noise
Hori.	7209.0	43.5	34.4	35.9	8.4	34.0	-	53.8	44.7	73.9	53.9	20.1	9.2	Floor noise
Hori.	9612.0	42.9	33.9	38.8	9.0	34.7	-	56.0	47.1	73.9	53.9	17.9	6.8	Floor noise
Vert.	33.8	47.2	-	12.7	7.2	33.0	-	34.1	-	40.0	-	5.9	-	
Vert.	39.2	47.2	-	11.6	7.3	33.0	-	33.1	-	40.0	-	6.9	-	
Vert.	53.2	49.8	-	9.9	7.5	33.0	-	34.1	-	40.0	-	5.9	-	
Vert.	55.8	50.4	-	9.7	7.5	33.0	-	34.6	-	40.0	-	5.4	-	
Vert.	135.7	39.5	-	11.5	8.4	33.0	-	26.5	-	43.5	-	17.0	-	
Vert.	280.2	39.6	-	12.4	9.6	32.9	-	28.7	-	46.0	-	17.3	-	
Vert.	2390.0	35.6	-	27.6	4.9	34.9	-	33.1	-	73.9	-	40.8	-	
Vert.	4806.0	42.3	33.3	31.6	7.1	34.1	-	46.9	37.9	73.9	53.9	27.0	16.0	Floor noise
Vert.	7209.0	44.0	34.9	35.9	8.4	34.0	-	54.3	45.1	73.9	53.9	19.6	8.8	Floor noise
Vert.	9612.0	42.8	34.1	38.8	9.0	34.7	-	55.9	47.2	73.9	53.9	18.0	6.7	Floor noise

Result (QP / PK) = Reading + Ant Factor + Loss (Cable+Attenuator+Filter+Distance factor(above 1 GHz)) - Gain(Amplifier)

Result (AV)= Reading + Ant Factor + Loss (Cable+Attenuator+Filter+Distance factor(above 1 GHz)) - Gain(Amplifier) + Duty factor

*Other frequency noises omitted in this report were not seen or had enough margin (more than 20 dB).

*QP detector was used up to 1GHz.

20dBc Data Sheet

Polarity [Hori/Vert]	Frequency [MHz]	Reading (PK) [dBuV]	Ant Factor [dB/m]	Loss [dB]	Gain [dB]	Result [dBuV/m]	Limit [dBuV/m]	Margin [dB]	Remark
Hori.	2403.0	85.9	27.6	4.9	34.9	83.4	-	-	Carrier
Hori.	2400.0	36.2	27.6	4.9	34.9	33.7	63.4	29.6	
Vert.	2403.0	91.3	27.6	4.9	34.9	88.8	-	-	Carrier
Vert.	2400.0	38.4	27.6	4.9	34.9	35.9	68.8	32.9	

Result = Reading + Ant Factor + Loss (Cable+Attenuator+Filter+Distance factor(above 1 GHz)) - Gain(Amplifier)

Distance factor: 1 GHz - 10 GHz 20log (3.65 m / 3.0 m) = 1.71 dB

10 GHz - 26.5 GHz 20log (1.0 m / 3.0 m) = -9.5 dB

Radiated Spurious Emission (Reference Plot for band-edge)

Test place	Ise EMC Lab.
Semi Anechoic Chamber	No.2
Date	May 23, 2023
Temperature / Humidity	24 deg. C / 34 % RH
Engineer	Daiki Matsui
	(1 GHz to 10 GHz)
Mode	Tx 2403 MHz

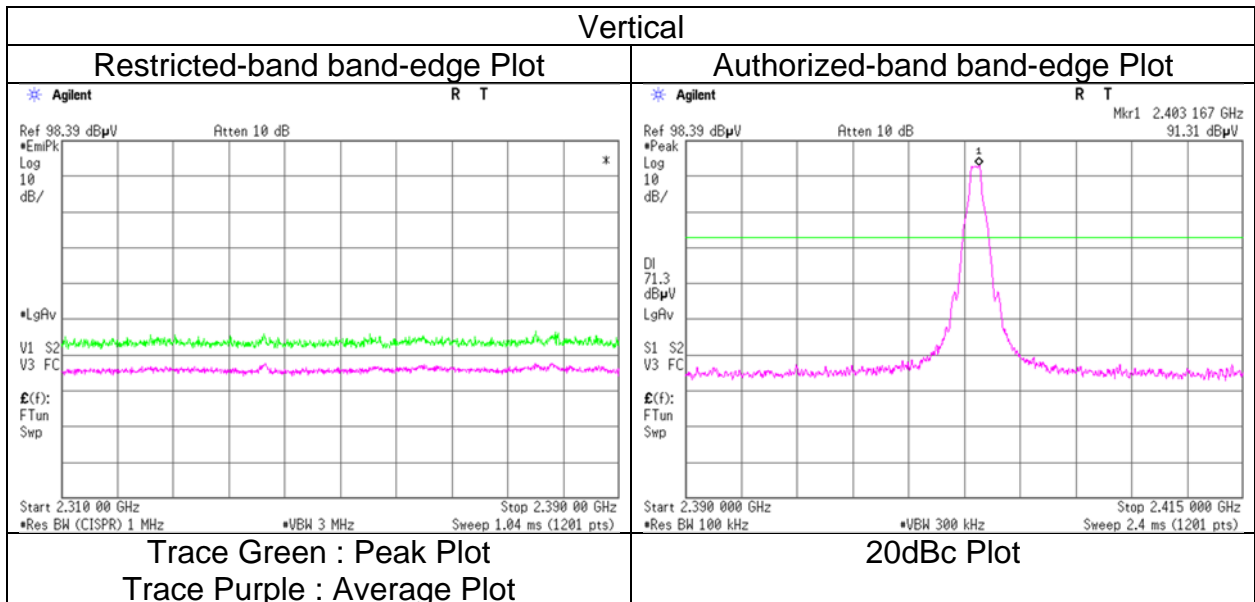
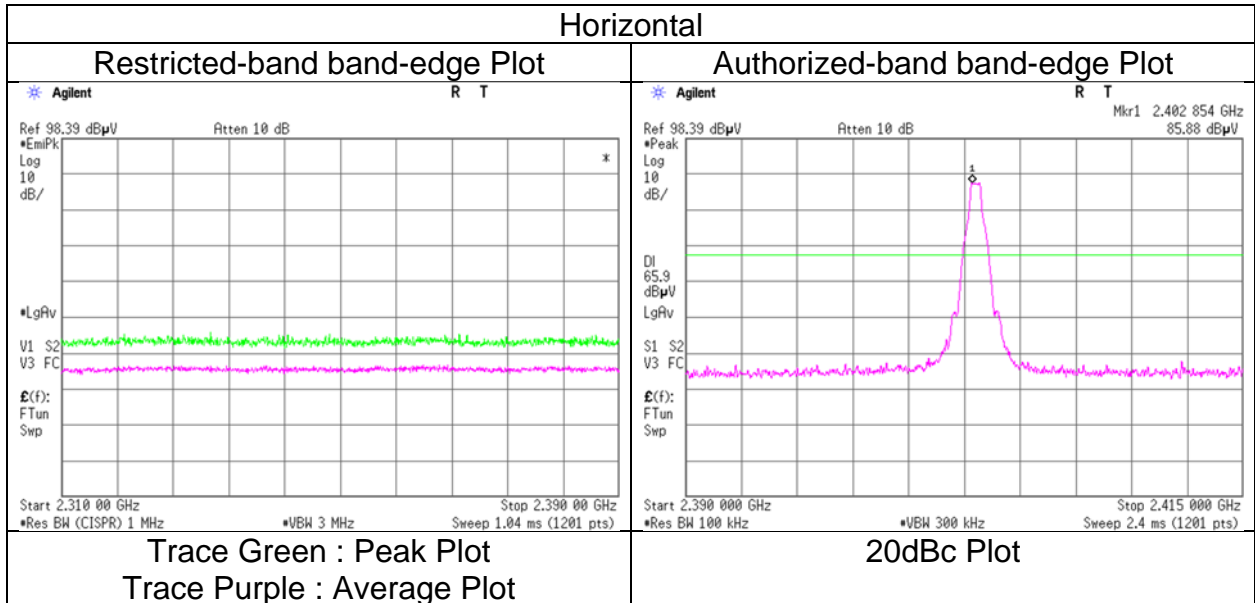

* The measurement was conducted for a sufficiently long enough time to detect any possible spurious emissions.
Final result of restricted band edge was shown in tabular data.

Radiated Spurious Emission

Test place	Ise EMC Lab.		
Semi Anechoic Chamber	No.2	No.2	No.2
Date	May 23, 2023	May 25, 2023	May 28, 2023
Temperature / Humidity	24 deg. C / 34 % RH	23 deg. C / 46 % RH	25 deg. C / 42 % RH
Engineer	Daiki Matsui	Daiki Matsui	Takumi Nishida
Mode	(1 GHz to 10 GHz) Tx 2440 MHz	(10 GHz to 18 GHz)	(18 GHz to 26.5 GHz)

Polarity [Hori/Vert]	Frequency [MHz]	Reading (QP / PK) [dBuV]	Reading (AV) [dBuV]	Ant. Factor [dB/m]	Loss [dB]	Gain [dB]	Duty Factor [dB]	Result (QP / PK) [dBuV/m]	Result (AV) [dBuV/m]	Limit (QP / PK) [dBuV/m]	Limit (AV) [dBuV/m]	Margin (QP / PK) [dB]	Margin (AV) [dB]	Remark
Hori.	4880.0	42.5	33.6	31.7	7.1	34.2	-	47.2	38.3	73.9	53.9	26.7	15.6	Floor noise
Hori.	7320.0	42.7	34.0	36.1	8.4	34.1	-	53.1	44.4	73.9	53.9	20.8	9.5	Floor noise
Hori.	9760.0	42.3	33.6	39.2	9.0	34.7	-	55.8	47.1	73.9	53.9	18.1	6.8	Floor noise
Vert.	4880.0	42.0	33.6	31.7	7.1	34.2	-	46.7	38.3	73.9	53.9	27.2	15.6	Floor noise
Vert.	7320.0	43.0	34.9	36.1	8.4	34.1	-	53.3	45.2	73.9	53.9	20.6	8.7	Floor noise
Vert.	9760.0	42.3	33.5	39.2	9.0	34.7	-	55.8	47.0	73.9	53.9	18.1	6.9	Floor noise

Result (QP / PK) = Reading + Ant Factor + Loss (Cable+Attenuator+Filter+Distance factor(above 1 GHz)) - Gain(Amplifier)

Result (AV)= Reading + Ant Factor + Loss (Cable+Attenuator+Filter+Distance factor(above 1 GHz)) - Gain(Amplifier) + Duty factor

*Other frequency noises omitted in this report were not seen or had enough margin (more than 20 dB).

*QP detector was used up to 1GHz.

Distance factor: 1 GHz - 10 GHz $20\log(3.65\text{ m} / 3.0\text{ m}) = 1.71\text{ dB}$
 10 GHz - 26.5 GHz $20\log(1.0\text{ m} / 3.0\text{ m}) = -9.5\text{ dB}$

Radiated Spurious Emission

Test place	Ise EMC Lab.		
Semi Anechoic Chamber	No.2	No.2	No.2
Date	May 23, 2023	May 25, 2023	May 28, 2023
Temperature / Humidity	24 deg. C / 34 % RH	23 deg. C / 46 % RH	25 deg. C / 42 % RH
Engineer	Daiki Matsui	Daiki Matsui	Takumi Nishida
Mode	(1 GHz to 10 GHz)	(10 GHz to 18 GHz)	(18 GHz to 26.5 GHz)
	Tx 2480 MHz		

Polarity [Hori/Vert]	Frequency [MHz]	Reading (QP / PK) [dBuV]	Reading (AV) [dBuV]	Ant. Factor [dB/m]	Loss [dB]	Gain [dB]	Duty Factor [dB]	Result (QP / PK) [dBuV/m]	Result (AV) [dBuV/m]	Limit (QP / PK) [dBuV/m]	Limit (AV) [dBuV/m]	Margin (QP / PK) [dB]	Margin (AV) [dB]	Remark
Hori.	2483.5	44.1	35.0	27.5	4.9	34.9	-	41.6	32.5	73.9	53.9	32.3	21.4	
Hori.	4960.0	42.1	33.4	31.8	7.2	34.2	-	47.0	38.2	73.9	53.9	27.0	15.7	Floor noise
Hori.	7440.0	42.6	34.2	36.2	8.4	34.1	-	53.0	44.6	73.9	53.9	20.9	9.3	Floor noise
Hori.	9920.0	42.9	33.9	39.2	9.0	34.7	-	56.4	47.3	73.9	53.9	17.6	6.6	Floor noise
Vert.	2483.5	45.2	35.8	27.5	4.9	34.9	-	42.7	33.3	73.9	53.9	31.2	20.6	
Vert.	4960.0	42.6	33.4	31.8	7.2	34.2	-	47.4	38.2	73.9	53.9	26.5	15.7	Floor noise
Vert.	7440.0	43.8	33.9	36.2	8.4	34.1	-	54.2	44.4	73.9	53.9	19.7	9.5	Floor noise
Vert.	9920.0	42.9	33.8	39.2	9.0	34.7	-	56.3	47.2	73.9	53.9	17.6	6.7	Floor noise

Result (QP / PK) = Reading + Ant Factor + Loss (Cable+Attenuator+Filter+Distance factor(above 1 GHz)) - Gain(Amplifier)

Result (AV)= Reading + Ant Factor + Loss (Cable+Attenuator+Filter+Distance factor(above 1 GHz)) - Gain(Amplifier) + Duty factor

*Other frequency noises omitted in this report were not seen or had enough margin (more than 20 dB).

*QP detector was used up to 1GHz.

Distance factor: 1 GHz - 10 GHz $20\log(3.65\text{ m} / 3.0\text{ m}) = 1.71\text{ dB}$
 10 GHz - 26.5 GHz $20\log(1.0\text{ m} / 3.0\text{ m}) = -9.5\text{ dB}$

Radiated Spurious Emission (Reference Plot for bandedge)

Test place
Semi Anechoic Chamber
Date
Temperature / Humidity
Engineer

Mode

Ise EMC Lab.
No.2
May 23, 2023
24 deg. C / 34 % RH
Daiki Matsui
(1 GHz to 10 GHz)
Tx 2480 MHz

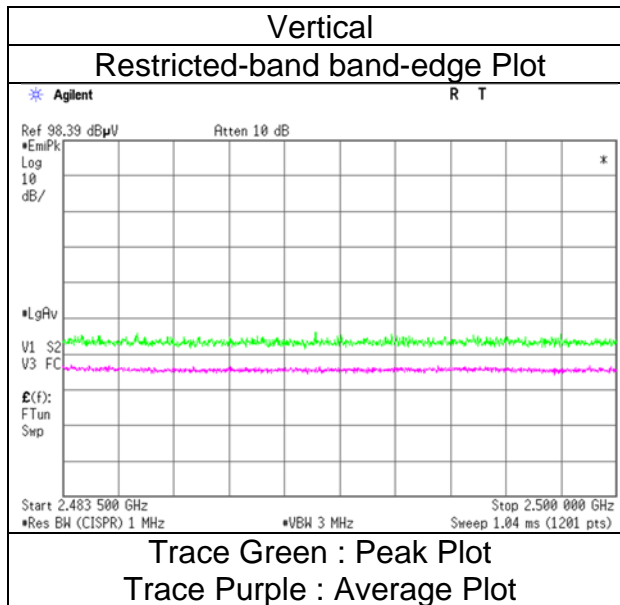
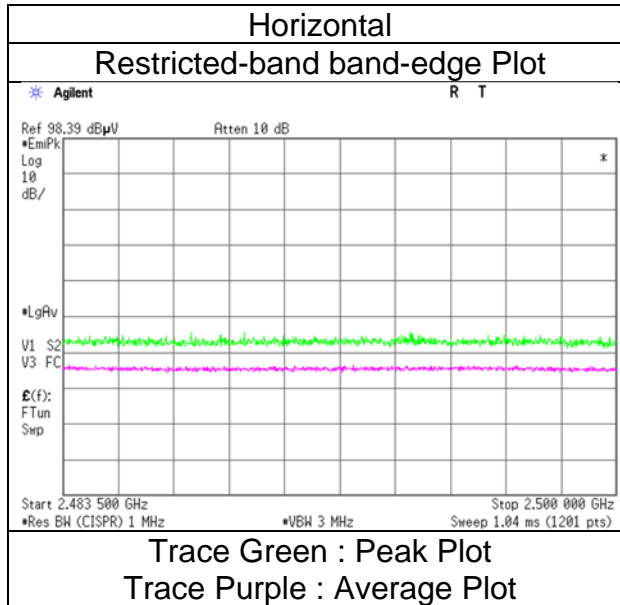

* The measurement was conducted for a sufficiently long enough time to detect any possible spurious emissions.
Final result of restricted band edge was shown in tabular data.

Radiated Spurious Emission (Plot data, Worst case mode for Maximum Peak Output Power)

Test place	Ise EMC Lab.			
Semi Anechoic Chamber	No.2	No.2	No.2	Large chamber
Date	May 23, 2023	May 25, 2023	May 28, 2023	May 28, 2023
Temperature / Humidity	24 deg. C / 34 % RH	23 deg. C / 46 % RH	25 deg. C / 42 % RH	25 deg. C / 42 % RH
Engineer	Daiki Matsui	Daiki Matsui	Takumi Nishida	Daiki Matsui
Mode	(1 GHz to 10 GHz) Tx 2403 MHz	(10 GHz to 18 GHz)	(18 GHz to 26.5 GHz)	Below 1 GHz

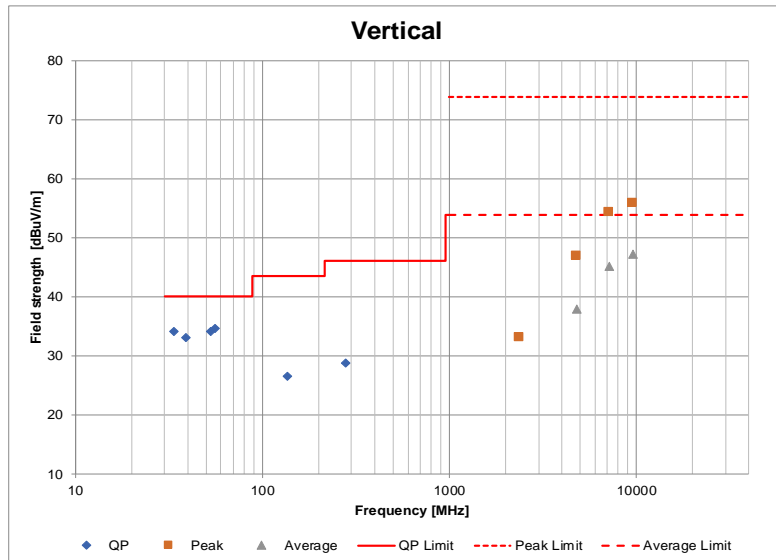
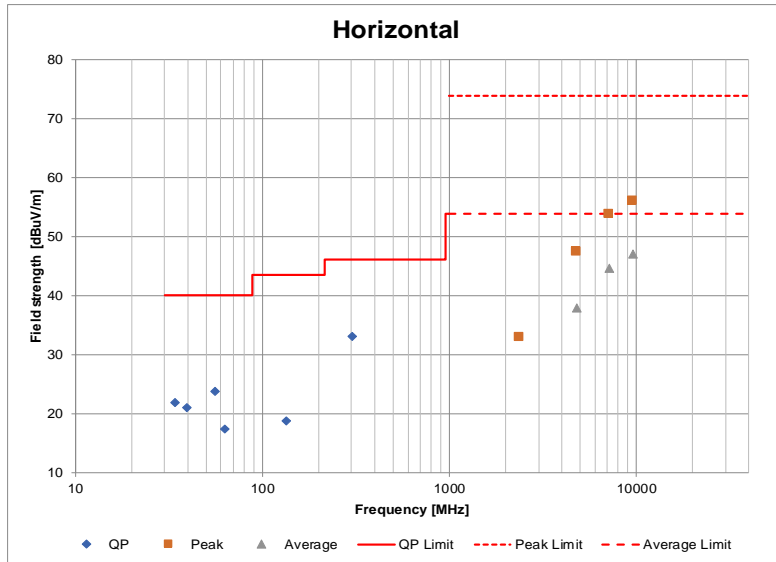

*These plots data contains sufficient number to show the trend of characteristic features for EUT.

Conducted Spurious Emission

Test place	Ise EMC Lab. No.6 Measurement Room
Date	May 18, 2023
Temperature / Humidity	23 deg. C / 43 % RH
Engineer	Nachi Konegawa
Mode	Tx 2403 MHz

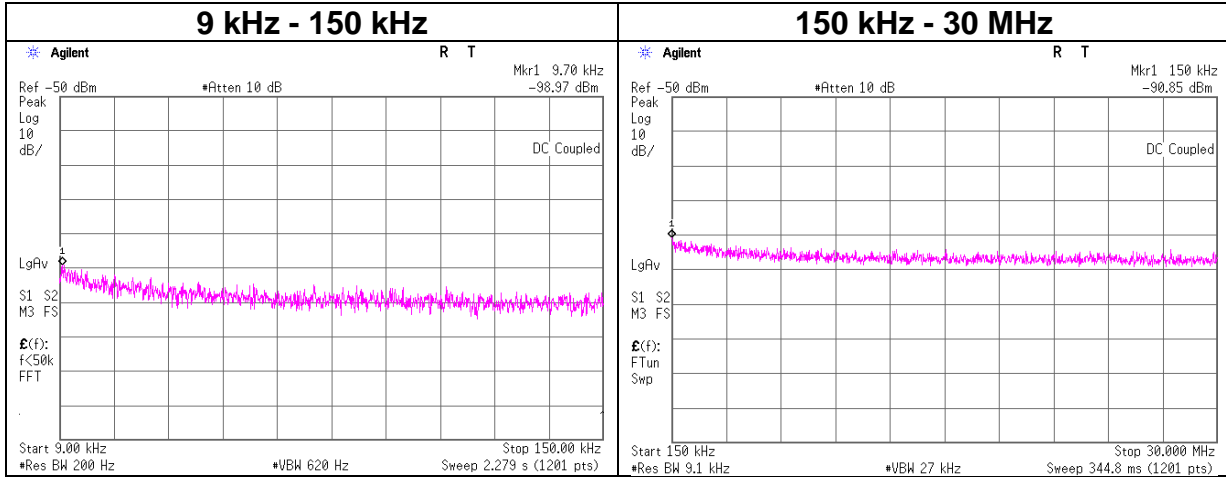

Frequency [kHz]	Reading [dBm]	Cable Loss [dB]	Attenuator Loss [dB]	Antenna Gain [dBi]	N (Number of Output)	EIRP [dBm]	Distance [m]	Ground bounce [dB]	E (field strength) [dBuV/m]	Limit [dBuV/m]	Margin [dB]	Remark
9.70	-99.0	0.00	9.8	6.4	1	-82.7	300	6.0	-21.5	47.8	69.3	
150.00	-90.9	0.01	9.8	6.4	1	-74.6	300	6.0	-13.3	24.0	37.3	

$E \text{ [dBuV/m]} = \text{EIRP [dBm]} - 20 \log(\text{Distance [m]}) + \text{Ground bounce [dB]} + 104.8 \text{ [dBuV/m]}$

$\text{EIRP [dBm]} = \text{Reading [dBm]} + \text{Cable loss [dB]} + \text{Attenuator Loss [dB]} + \text{Antenna gain [dBi]} + 10 * \log(N)$

N: Number of output

Power Density

Test place	Ise EMC Lab. No.6 Measurement Room
Date	May 17, 2023
Temperature / Humidity	22 deg. C / 42 % RH
Engineer	Nachi Konegawa
Mode	Tx

Freq. [MHz]	Reading dBm / 3 kHz	Cable Loss [dB]	Atten. Loss [dB]	Result dBm / 3 kHz	Limit dBm / 3 kHz	Margin [dB]
2403	-30.66	1.28	10.00	-19.38	8.00	27.38
2440	-30.83	1.28	10.00	-19.55	8.00	27.55
2480	-31.26	1.29	10.01	-19.96	8.00	27.96

Sample Calculation:

Result = Reading + Cable Loss + Attenuator Loss

Power Density

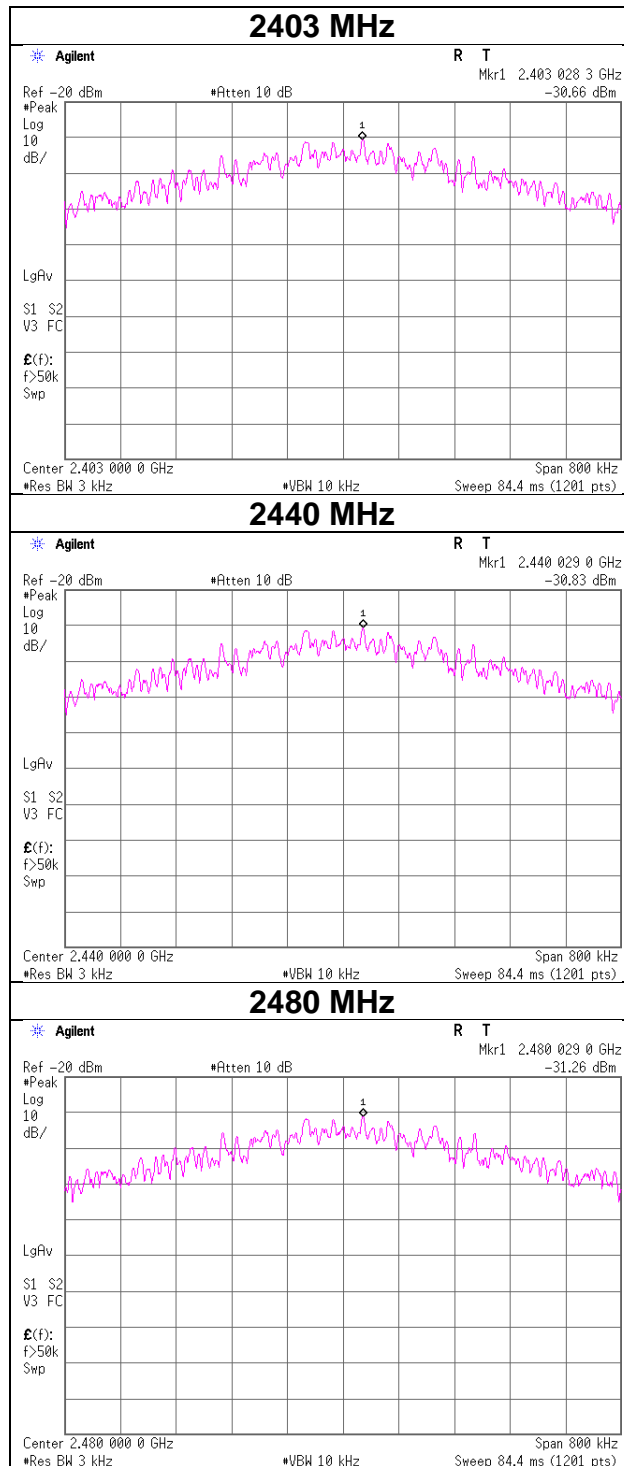

APPENDIX 2: Test Instruments**Test Equipment (1/2)**

Test Item	Local ID	LIMS ID	Description	Manufacturer	Model	Serial	Last Calibration Date	Cal Int
AT	MAT-10	141156	Attenuator (10dB)	Weinschel Corp	2	BL1173	11/10/2022	12
AT	MAT-91	141420	Attenuator	Weinschel Associates	WA56-10	56100307	05/18/2023	12
AT	MCC-138	141410	Microwave cable	Huber+Suhner	SUCOFLEX 102	37953/2	09/11/2022	12
AT	MCC-243	196430	Microwave Cable	Huber+Suhner	SF102D/11PC24/11PC24/1000mm	537059/126EA	02/02/2023	12
AT	MMM-18	141558	Digital Tester (TRUE RMS MULTIMETER)	Fluke Corporation	115	17930030	05/29/2023	12
AT	MOS-14	141561	Thermo-Hygrometer	CUSTOM. Inc	CTH-201	1401	01/13/2023	12
AT	MPM-01	141801	Power Meter	Keysight Technologies Inc	E4417A	GB41290639	04/11/2023	12
AT	MPM-08	141805	Power Meter	Anritsu Corporation	ML2495A	6K00003338	07/04/2022	12
AT	MPSE-03	141837	Power sensor	Keysight Technologies Inc	E9327A	US40440576	04/11/2023	12
AT	MPSE-11	141840	Power sensor	Anritsu Corporation	MA2411B	11737	07/04/2022	12
AT	MSA-16	141903	Spectrum Analyzer	Keysight Technologies Inc	E4440A	MY46186390	01/16/2023	12
CE	MAT-67	141248	Attenuator	JFW Industries, Inc.	50FP-013H2 N	-	12/22/2022	12
CE	MCC-225	166638	Coaxial cable	UL Japan	MP4/6-5D-2W	MP4/6	12/17/2022	12
CE	MJM-28	142229	Measure, Tape, Steel	KOMELON	KMC-36	-	-	-
CE	MLS-23	141357	LISN(AMN)	Schwarzbeck Mess-Elektronik OHG	NSLK8127	8127-729	07/28/2022	12
CE	MLS-24	141358	LISN(AMN)	Schwarzbeck Mess-Elektronik OHG	NSLK8127	8127-730	07/28/2022	12
CE	MMM-11	141546	Digital HiTESTER	HIOKI E.E. CORPORATION	3805	060100600	05/29/2023	12
CE	MOS-17	141563	Thermo-Hygrometer	CUSTOM. Inc	CTH-180	1005	01/13/2023	12
CE	MTA-55	141937	Terminator	TME	CT-01BP	-	12/14/2022	12
CE	MTR-10	141951	EMI Test Receiver	Rohde & Schwarz	ESR26	101408	07/25/2022	12
RE	COTS-MEMI-02	178648	EMI measurement program	TSJ (Techno Science Japan)	TEPTO-DV	-	-	-
RE	JAEC-01(NSA)	199242	Semi-Anechoic Chamber	Riken Environmental System	Large Chamber	1	02/09/2023	24
RE	JAT-02	199050	Attenuator (6dB)	Anritsu Corporation	BW-N6W5+	1926	11/17/2022	12
RE	JBA-01-EMC	199476	Biconical antenna	Schwarzbeck Mess-Elektronik OHG	VHBB9124+BBA9106	01410	05/16/2023	12
RE	JCC-15	199212	Microwave Cable	Huber+Suhner	S04272B/RFM-E721/Sucofeed/SF106	-	11/28/2022	12
RE	JDM-01	199067	Digital Multimeter	SANWA	PC7000	19105100121	06/01/2022	12
RE	JJM-01	199065	Measure	SHINWA	80814	001	-	-
RE	JLA-01-EMC	199477	Logperiodic antenna	Schwarzbeck Mess-Elektronik OHG	VULP9118A	00831	05/16/2023	12
RE	JOS-07	221241	Thermo-Hygrometer	Mother tool	MHB-382SD	55534	07/03/2022	12
RE	JPA-02	198470	Broadband Amplifier	SONOMA	310N	400557	01/12/2023	12
RE	JTR-03	213780	EMI Test Receiver	Rohde & Schwarz	ESW8	103079	12/07/2022	12
RE	MAEC-02	142004	AC2_Semi Anechoic Chamber (NSA)	TDK	Semi Anechoic Chamber 3m	DA-06902	05/30/2022	24
RE	MAEC-02-SVSWR	142006	AC2_Semi Anechoic Chamber (SVSWR)	TDK	Semi Anechoic Chamber 3m	DA-06902	04/17/2023	24

Test Equipment (2/2)

Test Item	Local ID	LIMS ID	Description	Manufacturer	Model	Serial	Last Calibration Date	Cal Int
RE	MCC-176	141279	Microwave Cable	Junkosha	MMX221-00500DMSDMS	1502S303	03/08/2023	12
RE	MCC-218	141394	Microwave Cable	Junkosha	MWX221	1607S141(1 m) / 1608S264(5 m)	09/12/2022	12
RE	MHA-06	141512	Horn Antenna 1-18GHz	Schwarzbeck Mess-Elektronik OHG	BBHA9120D	254	10/20/2022	12
RE	MHA-16	141513	Horn Antenna 15-40GHz	Schwarzbeck Mess-Elektronik OHG	BBHA9170	BBHA9170306	07/05/2022	12
RE	MHF-16	141406	High Pass Filter 7-20GHz	TOKIMEC	TF37NCCA	7001	09/07/2022	12
RE	MHF-25	141232	High Pass Filter 3.5-18.0GHz	UL Japan	HPF SELECTOR	001	09/07/2022	12
RE	MJM-27	142228	Measure, Tape, Steel	KOMELON	KMC-36	-	-	-
RE	MMM-01	141542	Digital Tester	Fluke Corporation	FLUKE 26-3	78030611	08/12/2022	12
RE	MOS-41	192300	Thermo-Hygrometer	CUSTOM. Inc	CTH-201	0013	12/17/2022	12
RE	MPA-10	141579	Pre Amplifier	Keysight Technologies Inc	8449B	3008A02142	02/14/2023	12
RE	MSA-22	141978	Spectrum Analyzer	Keysight Technologies Inc	E4448A	MY46180899	03/06/2023	12

*Hyphens for Last Calibration Date and Cal Int (month) are instruments that Calibration is not required (e.g. software), or instruments checked in advance before use.

The expiration date of the calibration is the end of the expired month.
As for some calibrations performed after the tested dates, those test equipment have been controlled by means of an unbroken chains of calibrations.

All equipment is calibrated with valid calibrations. Each measurement data is traceable to the national or international standards.

Test item: AT: Antenna Terminal Conducted
 CE: Conducted Emission
 RE: Radiated Emission