



# RADIO TEST REPORT

**Test Report No. : 13226743H-A-R3**

**Applicant** : silex technology, Inc.  
**Type of EUT** : Wireless E84 Digital Communication Unit  
**Model Number of EUT** : WDCU-3310  
**FCC ID** : N6C-WDCU3310  
**Test regulation** : FCC Part 15 Subpart C: 2020  
**Test Result** : Complied (Refer to SECTION 3.2)

1. This test report shall not be reproduced in full or partial, without the written approval of UL Japan, Inc.
2. The results in this report apply only to the sample tested.
3. This sample tested is in compliance with the limits of the above regulation.
4. The test results in this test report are traceable to the national or international standards.
5. This test report covers Radio technical requirements.  
It does not cover administrative issues such as Manual or non-Radio test related Requirements. (if applicable)
6. The all test items in this test report are conducted by UL Japan, Inc. Ise EMC Lab.
7. This test report must not be used by the customer to claim product certification, approval, or endorsement by NVLAP, NIST, or any agency of the U.S. Government.
8. The information provided from the customer for this report is identified in Section 1.
9. This report is a revised version of 13226743H-A-R2. 13226743H-A-R2 is replaced with this report.

**Date of test:** March 19 to August 26, 2020

**Representative test engineer:**   
Yuta Moriya  
Engineer  
Consumer Technology Division

**Approved by:**   
Satofumi Matsuyama  
Engineer  
Consumer Technology Division



This laboratory is accredited by the NVLAP LAB CODE 200572-0, U.S.A. The tests reported herein have been performed in accordance with its terms of accreditation.  
\*As for the range of Accreditation in NVLAP, you may refer to the WEB address,  
[http://japan.ul.com/resources/emc\\_accredited/](http://japan.ul.com/resources/emc_accredited/)

- This report contains data that are not covered by the NVLAP accreditation.  
 There is no testing item of "Non-accreditation".

**UL Japan, Inc.**  
**Ise EMC Lab.**

4383-326 Asama-cho, Ise-shi, Mie-ken 516-0021 JAPAN  
Telephone : +81 596 24 8999  
Facsimile : +81 596 24 8124

## REVISION HISTORY

### Original Test Report No.: 13226743H-A

Revision	Test report No.	Date	Page revised	Contents
- (Original)	13226743H-A	July 29, 2020	-	-
1	13226743H-A-R1	August 20, 2020	P 22	Correction of Attenuator Loss of Power Setting -20 dBm in APPENDIX 1: Test data (Maximum Peak Output Power) 9.77 dB → 0 dB
1	13226743H-A-R1	August 20, 2020	P 36	Deletion of Local ID MPM-12, MPSE-17 in APPENDIX 2: Test instruments
2	13226743H-A-R2	August 26, 2020	P 1	Correction of Date of test March 19 to June 30, 2020→March 19 to August 26, 2020
2	13226743H-A-R2	August 26, 2020	P 5	Correction of Receipt Date of Sample in Section2.1 March 11, 2020→ March 11, 2020 (The test data before March 24, 2020 used this samples.) *1) June 9, 2020 (The test data after June 24, 2020 used this samples.) *1) The samples received on March 11, 2020 did not differ from the samples received on June 9, 2020. Therefore, the data for the tests performed with samples received on March 11, 2020 was used.
2	13226743H-A-R2	August 26, 2020	P 7	Correction of Test Specification in Section 3.1. FCC Part 15 final revised on May 26, 2020 and effective July 27, 2020 except 15.258→ FCC Part 15 final revised on June 26, 2020 and effective July 27, 2020  Addition of below explanatory note. * The revision does not affect the test result conducted before its effective date.
2	13226743H-A-R2	August 26, 2020	P 22, 23	Replacement to new test data of Power Setting 0 dBm in APPENDIX 1: Test data (Maximum Peak Output Power / Average Output Power)
2	13226743H-A-R2	August 26, 2020	P 22, 23	Correction of Result [mW] of Power Setting -20 dBm in APPENDIX 1: Test data (Maximum Peak Output Power / Average Output Power) P22: Conducted: 0.00 → 0.001 e.i.r.p: 0.00 → 0.003 P23: 0.00 → 0.001
3	13226743H-A-R3	August 31, 2020	P 5	Correction of explanatory note for Receipt Date of Sample *1) in Section2.1  *1) The samples received on March 11, 2020 did not differ from the samples received on June 9, 2020. Therefore, the data for the tests performed with samples received on March 11, 2020 was used. → *1) The samples received on June 9, 2020 have improved spurious emission characteristics over the samples received on March 11, 2020, due to improvements in the electromagnetic wave absorption sheet. There was no difference in the maximum peak output power test (for power setting: 0 dBm) results between the samples received on March 11, 2020 and the samples received on June 9, 2020, therefore the test data performed with samples received on March 11, 2020 was used for the following test items:  6 dB Bandwidth and 99 % Occupied Bandwidth Maximum Peak Output Power and Average Output Power (for power setting -20dBm) Conducted Spurious Emission

**UL Japan, Inc.**

**Ise EMC Lab.**

4383-326 Asama-cho, Ise-shi, Mie-ken 516-0021 JAPAN

Telephone : +81 596 24 8999

Facsimile : +81 596 24 8124

## Reference: Abbreviations (Including words undescribed in this report)

A2LA	The American Association for Laboratory Accreditation	MCS	Modulation and Coding Scheme
AC	Alternating Current	MRA	Mutual Recognition Arrangement
AFH	Adaptive Frequency Hopping	N/A	Not Applicable
AM	Amplitude Modulation	NIST	National Institute of Standards and Technology
Amp, AMP	Amplifier	NS	No signal detect.
ANSI	American National Standards Institute	NSA	Normalized Site Attenuation
Ant, ANT	Antenna	NVLAP	National Voluntary Laboratory Accreditation Program
AP	Access Point	OBW	Occupied Band Width
ASK	Amplitude Shift Keying	OFDM	Orthogonal Frequency Division Multiplexing
Atten., ATT	Attenuator	P/M	Power meter
AV	Average	PCB	Printed Circuit Board
BPSK	Binary Phase-Shift Keying	PER	Packet Error Rate
BR	Bluetooth Basic Rate	PHY	Physical Layer
BT	Bluetooth	PK	Peak
BT LE	Bluetooth Low Energy	PN	Pseudo random Noise
BW	BandWidth	PRBS	Pseudo-Random Bit Sequence
Cal Int	Calibration Interval	PSD	Power Spectral Density
CCK	Complementary Code Keying	QAM	Quadrature Amplitude Modulation
Ch., CH	Channel	QP	Quasi-Peak
CISPR	Comite International Special des Perturbations Radioelectriques	QPSK	Quadri-Phase Shift Keying
CW	Continuous Wave	RBW	Resolution Band Width
DBPSK	Differential BPSK	RDS	Radio Data System
DC	Direct Current	RE	Radio Equipment
D-factor	Distance factor	RF	Radio Frequency
DFS	Dynamic Frequency Selection	RMS	Root Mean Square
DQPSK	Differential QPSK	RSS	Radio Standards Specifications
DSSS	Direct Sequence Spread Spectrum	Rx	Receiving
EDR	Enhanced Data Rate	SA, S/A	Spectrum Analyzer
EIRP, e.i.r.p.	Equivalent Isotropically Radiated Power	SG	Signal Generator
EMC	ElectroMagnetic Compatibility	SVSWR	Site-Voltage Standing Wave Ratio
EMI	ElectroMagnetic Interference	TR	Test Receiver
EN	European Norm	Tx	Transmitting
ERP, e.r.p.	Effective Radiated Power	VBW	Video BandWidth
EU	European Union	Vert.	Vertical
EUT	Equipment Under Test	WLAN	Wireless LAN
Fac.	Factor		
FCC	Federal Communications Commission		
FHSS	Frequency Hopping Spread Spectrum		
FM	Frequency Modulation		
Freq.	Frequency		
FSK	Frequency Shift Keying		
GFSK	Gaussian Frequency-Shift Keying		
GNSS	Global Navigation Satellite System		
GPS	Global Positioning System		
Hori.	Horizontal		
ICES	Interference-Causing Equipment Standard		
IEC	International Electrotechnical Commission		
IEEE	Institute of Electrical and Electronics Engineers		
IF	Intermediate Frequency		
ILAC	International Laboratory Accreditation Conference		
ISED	Innovation, Science and Economic Development Canada		
ISO	International Organization for Standardization		
JAB	Japan Accreditation Board		
LAN	Local Area Network		
LIMS	Laboratory Information Management System		

**UL Japan, Inc.**

**Ise EMC Lab.**

4383-326 Asama-cho, Ise-shi, Mie-ken 516-0021 JAPAN

Telephone : +81 596 24 8999

Facsimile : +81 596 24 8124

<b>CONTENTS</b>	<b>PAGE</b>
<b>SECTION 1: Customer information.....</b>	<b>5</b>
<b>SECTION 2: Equipment under test (EUT).....</b>	<b>5</b>
<b>SECTION 3: Test specification, procedures &amp; results.....</b>	<b>7</b>
<b>SECTION 4: Operation of EUT during testing.....</b>	<b>10</b>
<b>SECTION 5: Conducted Emission.....</b>	<b>12</b>
<b>SECTION 6: Radiated Spurious Emission.....</b>	<b>13</b>
<b>SECTION 7: Antenna Terminal Conducted Tests.....</b>	<b>15</b>
<b>APPENDIX 1: Test data .....</b>	<b>16</b>
Conducted Emission .....	16
6 dB Bandwidth and 99 % Occupied Bandwidth .....	19
Maximum Peak Output Power.....	22
Average Output Power.....	23
Radiated Spurious Emission .....	25
Conducted Spurious Emission .....	31
Power Density.....	34
<b>APPENDIX 2: Test instruments.....</b>	<b>36</b>
<b>APPENDIX 3: Photographs of test setup .....</b>	<b>38</b>
Conducted Emission .....	38
Radiated Spurious Emission .....	39
Worst Case Position.....	40

## **SECTION 1: Customer information**

Company Name : silex technology, Inc.  
Address : 2-3-1 Hikaridai, Seika-cho, Soraku-gun, Kyoto 619-0237, Japan  
Telephone Number : +81-774-98-3878  
Facsimile Number : +81-774-98-3758  
Contact Person : Keisuke Ishiro

The information provided from the customer is as follows;

- Applicant, Type of EUT, Model Number of EUT, FCC ID on the cover and other relevant pages
- Operating/Test Mode(s) (Mode(s)) on all the relevant pages
- SECTION 1: Customer information
- SECTION 2: Equipment under test (EUT)
- SECTION 4: Operation of EUT during testing

\* The laboratory is exempted from liability of any test results affected from the above information in SECTION 2 and 4.

## **SECTION 2: Equipment under test (EUT)**

### **2.1 Identification of EUT**

Type of Equipment : Wireless E84 Digital Communication Unit  
Model No. : WDCU-3310  
Serial No. : Refer to SECTION 4.2  
Rating : DC 24 V  
Receipt Date of Sample : March 11, 2020 (The test data before March 24, 2020 used this samples.) \*1)  
(Information from test lab.) : June 9, 2020 (The test data after June 24, 2020 used this samples.)  
\*1) The samples received on June 9, 2020 have improved spurious emission characteristics over the samples received on March 11, 2020, due to improvements in the electromagnetic wave absorption sheet.  
There was no difference in the maximum peak output power test (for power setting: 0 dBm) results between the samples received on March 11, 2020 and the samples received on June 9, 2020, therefore the test data performed with samples received on March 11, 2020 was used for the following test items:  
6 dB Bandwidth and 99 % Occupied Bandwidth  
Maximum Peak Output Power and Average Output Power (for power setting -20dBm)  
Conducted Spurious Emission  
Country of Mass-production : Japan  
Condition of EUT : Production prototype  
(Not for Sale: This sample is equivalent to mass-produced items.)  
Modification of EUT : No Modification by the test lab.

## 2.2 Product Description

Model: WDCU-3310 (referred to as the EUT in this report) is a Wireless E84 Digital Communication Unit.

### Radio Specification

Radio Type : Transceiver  
Method of Frequency Generation : Synthesizer

#### [short-range wireless 2.4 GHz] \*

Radio Type : Transceiver  
Frequency of Operation : 2403 MHz to 2480 MHz  
Modulation : FSK  
Antenna type : PCB Antenna  
Antenna Gain : 6 dBi  
Clock frequency (Maximum) : 32 MHz

#### [short-range wireless 5.8 GHz]

Radio Type : Transceiver  
Frequency of Operation : 5726 MHz to 5825 MHz  
Modulation : FSK  
Antenna type : PCB Antenna  
Antenna Gain : 1 dBi  
Clock frequency (Maximum) : 32 MHz

\* This test report applies to 2.4 GHz Band.

## **SECTION 3: Test specification, procedures & results**

### **3.1 Test Specification**

Test Specification : FCC Part 15 Subpart C  
FCC Part 15 final revised on June 26, 2020 and effective July 27, 2020

Title : FCC 47 CFR Part 15 Radio Frequency Device Subpart C Intentional Radiators  
Section 15.207 Conducted limits  
Section 15.247 Operation within the bands 902-928 MHz, 2400-2483.5 MHz,  
and 5725-5850 MHz

\* The revision does not affect the test result conducted before its effective date.

### **3.2 Procedures and results**

Item	Test Procedure	Specification	Worst margin	Results	Remarks
Conducted Emission	FCC: ANSI C63.10-2013 6. Standard test methods ----- ISED: RSS-Gen 8.8	FCC: Section 15.207 ----- ISED: RSS-Gen 8.8	10.63 dB, 20.77440 MHz, L, AV	Complied a)	-
6dB Bandwidth	FCC: KDB 558074 D01 15.247 Meas Guidance v05r02 ----- ISED: -	FCC: Section 15.247(a)(2) ----- ISED: RSS-247 5.2(a)	See data.	Complied b)	Conducted
Maximum Peak Output Power	FCC: KDB 558074 D01 15.247 Meas Guidance v05r02 ----- ISED: RSS-Gen 6.12	FCC: Section 15.247(b)(3) ----- ISED: RSS-247 5.4(d)		Complied c)	Conducted
Power Density	FCC: KDB 558074 D01 15.247 Meas Guidance v05r02 ----- ISED: -	FCC: Section 15.247(e) ----- ISED: RSS-247 5.2(b)		Complied d)	Conducted
Spurious Emission Restricted Band Edges	FCC: KDB 558074 D01 15.247 Meas Guidance v05r02 ----- ISED: RSS-Gen 6.13	FCC: Section 15.247(d) ----- ISED: RSS-247 5.5 RSS-Gen 8.9 RSS-Gen 8.10		3.6 dB 120.000 MHz, QP, Horizontal/Vertical	Complied# e), f)

Note: UL Japan, Inc.'s EMI Work Procedures No. 13-EM-W0420 and 13-EM-W0422.

\*1) Radiated test was selected over 30 MHz based on section 15.247(d) and KDB 558074 D01 15.247 Meas Guidance v05r02 8.5 and 8.6.

- a) Refer to APPENDIX 1 (data of Conducted Emission)  
b) Refer to APPENDIX 1 (data of 6 dB Bandwidth and 99 % Occupied Bandwidth)  
c) Refer to APPENDIX 1 (data of Maximum Peak Output Power)  
d) Refer to APPENDIX 1 (data of Power Density)  
e) Refer to APPENDIX 1 (data of Conducted Spurious Emission)  
f) Refer to APPENDIX 1 (data of Radiated Spurious Emission)

Symbols:

Complied The data of this test item has enough margin, more than the measurement uncertainty.

Complied# The data of this test item meets the limits unless the measurement uncertainty is taken into consideration.

\* In case any questions arise about test procedure, ANSI C63.10: 2013 is also referred.

### **FCC Part 15.31 (e)**

This EUT provides stable voltage constantly to RF Module regardless of input voltage.  
Therefore, this EUT complies with the requirement.

### **FCC Part 15.203 Antenna requirement**

The EUT has an external antenna connector, but it is installed by the professionals.  
Therefore, the equipment complies with the antenna requirement of Section 15.203.

**UL Japan, Inc.**

**Ise EMC Lab.**

4383-326 Asama-cho, Ise-shi, Mie-ken 516-0021 JAPAN

Telephone : +81 596 24 8999

Facsimile : +81 596 24 8124

### 3.3 Addition to standard

Item	Test Procedure	Specification	Worst margin	Results	Remarks
99% Occupied Bandwidth	ISED: RSS-Gen 6.7	ISED: -	N/A	- a)	Conducted
a) Refer to APPENDIX 1 (data of 6 dB Bandwidth and 99 % Occupied Bandwidth)					

Other than above, no addition, exclusion nor deviation has been made from the standard.

### 3.4 Uncertainty

There is no applicable rule of uncertainty in this applied standard. Therefore, the results are derived depending on whether or not laboratory uncertainty is applied.

The following uncertainties have been calculated to provide a confidence level of 95 % using a coverage factor  $k=2$ .

Ise EMC Lab.

#### Antenna Terminal test

Test Item	Uncertainty (+/-)
20 dB Bandwidth / 99 % Occupied Bandwidth	0.96 %
Maximum Peak Output Power / Average Output Power	1.4 dB
Carrier Frequency Separation	0.42 %
Dwell time / Burst rate	0.10 %
Conducted Spurious Emission	2.6 dB

#### Conducted emission

using Item	Frequency range	Uncertainty (+/-)
AMN (LISN)	0.009 MHz to 0.15 MHz	3.4 dB
	0.15 MHz to 30 MHz	2.9 dB

#### Radiated emission

Measurement distance	Frequency range	Uncertainty (+/-)
3 m	9 kHz to 30 MHz	3.3 dB
10 m		3.2 dB
3 m	30 MHz to 200 MHz (Horizontal) (Vertical)	4.8 dB
		5.0 dB
	200 MHz to 1000 MHz (Horizontal) (Vertical)	5.2 dB
		6.3 dB
10 m	30 MHz to 200 MHz (Horizontal) (Vertical)	4.8 dB
		4.8 dB
	200 MHz to 1000 MHz (Horizontal) (Vertical)	5.0 dB
		5.0 dB
3 m	1 GHz to 6 GHz	4.9 dB
	6 GHz to 18 GHz	5.2 dB
1 m	10 GHz to 26.5 GHz	5.5 dB
	26.5 GHz to 40 GHz	5.5 dB
10 m	1 GHz to 18 GHz	5.2 dB

**UL Japan, Inc.**

**Ise EMC Lab.**

4383-326 Asama-cho, Ise-shi, Mie-ken 516-0021 JAPAN

Telephone : +81 596 24 8999

Facsimile : +81 596 24 8124



### 3.5 Test Location

UL Japan, Inc. Ise EMC Lab.

\*NVLAP Lab. code: 200572-0 / FCC Test Firm Registration Number: 199967 / ISED Lab Company Number: 2973C

4383-326 Asama-cho, Ise-shi, Mie-ken 516-0021 JAPAN

Telephone: +81 596 24 8999, Facsimile: +81 596 24 8124

Test site	Width x Depth x Height (m)	Size of reference ground plane (m) / horizontal conducting plane	Other rooms	Maximum measurement distance
No.1 semi-anechoic chamber	19.2 x 11.2 x 7.7	7.0 x 6.0	No.1 Power source room	10 m
No.2 semi-anechoic chamber	7.5 x 5.8 x 5.2	4.0 x 4.0	-	3 m
No.3 semi-anechoic chamber	12.0 x 8.5 x 5.9	6.8 x 5.75	No.3 Preparation room	3 m
No.3 shielded room	4.0 x 6.0 x 2.7	N/A	-	-
No.4 semi-anechoic chamber	12.0 x 8.5 x 5.9	6.8 x 5.75	No.4 Preparation room	3 m
No.4 shielded room	4.0 x 6.0 x 2.7	N/A	-	-
No.5 semi-anechoic chamber	6.0 x 6.0 x 3.9	6.0 x 6.0	-	-
No.5 measurement room	6.4 x 6.4 x 3.0	6.4 x 6.4	-	-
No.6 shielded room	4.0 x 4.5 x 2.7	4.0 x 4.5	-	-
No.6 measurement room	4.75 x 5.4 x 3.0	4.75 x 4.15	-	-
No.7 shielded room	4.7 x 7.5 x 2.7	4.7 x 7.5	-	-
No.8 measurement room	3.1 x 5.0 x 2.7	3.1 x 5.0	-	-
No.9 measurement room	8.8 x 4.6 x 2.8	2.4 x 2.4	-	-
No.11 measurement room	6.2 x 4.7 x 3.0	4.8 x 4.6	-	-

\* Size of vertical conducting plane (for Conducted Emission test) : 2.0 x 2.0 m for No.1, No.2, No.3, and No.4 semi-anechoic chambers and No.3 and No.4 shielded rooms.

### 3.6 Test data, Test instruments, and Test set up

Refer to APPENDIX.

**UL Japan, Inc.**

**Ise EMC Lab.**

4383-326 Asama-cho, Ise-shi, Mie-ken 516-0021 JAPAN

Telephone : +81 596 24 8999

Facsimile : +81 596 24 8124

## **SECTION 4: Operation of EUT during testing**

### **4.1 Operating Mode(s)**

<b>Mode</b>	<b>Remarks*</b>
Transmitting (2.4 GHz)	Tx
*Transmitting duty was 100 % on all tests.	
*Power of the EUT was set by the software as follows; Power settings: 0 dBm (All Tests) , -20dBm (Maximum Peak Output Power only) Software: TeraTerm Ver 4.102 (Date: 2020.3.19, Storage location: Driven by connected PC) *This setting of software is the worst case. Any conditions under the normal use do not exceed the condition of setting. In addition, end users cannot change the settings of the output power of the product.	

\*The details of Operating mode(s)

<b>Test Item</b>	<b>Operating Mode</b>	<b>Tested frequency</b>
Radiated Spurious Emission (Above 1 GHz), Radiated Spurious Emission (Below 1 GHz) Conducted Emission Conducted Spurious Emission, 6dB Bandwidth, Maximum Peak Output Power, Power Density, 99% Occupied Bandwidth, Conducted Spurious Emission	Tx	2403 MHz 2440 MHz 2480 MHz

**UL Japan, Inc.**

**Ise EMC Lab.**

4383-326 Asama-cho, Ise-shi, Mie-ken 516-0021 JAPAN

Telephone : +81 596 24 8999

Facsimile : +81 596 24 8124

## 4.2 Configuration and peripherals

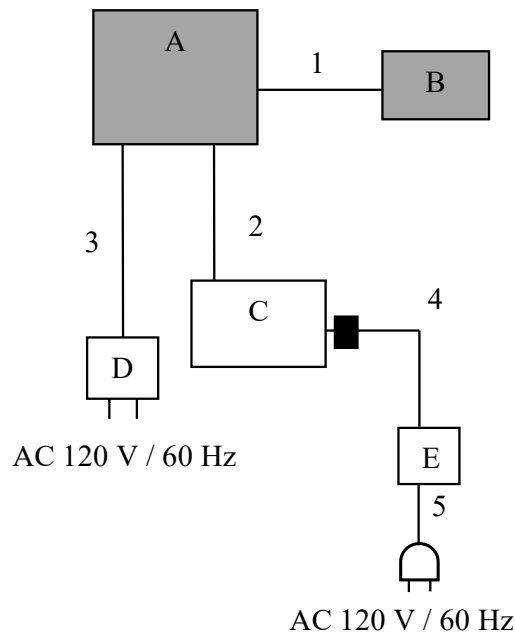

■ : Standard Ferrite Core

\* Cabling and setup(s) were taken into consideration and test data was taken under worse case conditions.

\*As a result of comparing AC 120 V and AC 240 V at pre-check, conducted emission test was performed with AC 240 V of the worst voltage as representative.

### Description of EUT and Support equipment

No.	Item	Model number	Serial number	Manufacturer	Remarks
A	Wireless E84 Digital Communication Unit	WDCU-3310	001	silex technology, Inc.	EUT
B	Antenna	JUM2458PO_W1	001	silex technology, Inc.	EUT
C	Laptop PC	CF-LX4EDHCS	5GKSA17377	Panasonic	-
D	AC Adapter	WB-18D12R	Y19490019464	Asian Power Device. Inc	-
E	AC Adapter	CF-AA62J2C	64B2CM1147037 55B	Panasonic	-

### List of cables used

No.	Name	Length (m)	Shield		Remarks
			Cable	Connector	
1	Antenna Cable	0.4	Shielded	Shielded	-
2	RS-232C Cable	1.1	Shielded	Shielded	-
3	DC Cable	1.9	Unshielded	Unshielded	-
4	DC Cable	0.8	Unshielded	Unshielded	-
5	AC Cable	0.9	Unshielded	Unshielded	-

**UL Japan, Inc.**

**Ise EMC Lab.**

4383-326 Asama-cho, Ise-shi, Mie-ken 516-0021 JAPAN

Telephone : +81 596 24 8999

Facsimile : +81 596 24 8124

## **SECTION 5: Conducted Emission**

### **Test Procedure and conditions**

EUT was placed on a urethane platform of nominal size, 1.0 m by 1.5 m, raised 0.8 m above the conducting ground plane. The rear of tabletop was located 40 cm to the vertical conducting plane. The rear of EUT, including peripherals aligned and flushed with rear of tabletop. All other surfaces of tabletop were at least 80cm from any other grounded conducting surface. EUT was located 80 cm from a Line Impedance Stabilization Network (LISN) / Artificial mains Network (AMN) and excess AC cable was bundled in center.

#### For the tests on EUT with other peripherals (as a whole system)

I/O cables that were connected to the peripherals were bundled in center. They were folded back and forth forming a bundle 30 cm to 40 cm long and were hanged at a 40 cm height to the ground plane. All unused 50ohm connectors of the LISN (AMN) were resistivity terminated in 50 ohm when not connected to the measuring equipment.

The AC Mains Terminal Continuous disturbance Voltage has been measured with the EUT in a Semi Anechoic Chamber. The EUT was connected to a LISN (AMN).

An overview sweep with peak detection has been performed.

The test results and limit are rounded off to one decimal place, so some differences might be observed.

**Detector** : QP and CISPR AV  
**Measurement range** : 0.15 MHz - 30 MHz  
**Test data** : APPENDIX  
**Test result** : Pass

**Figure 1: Test Setup**

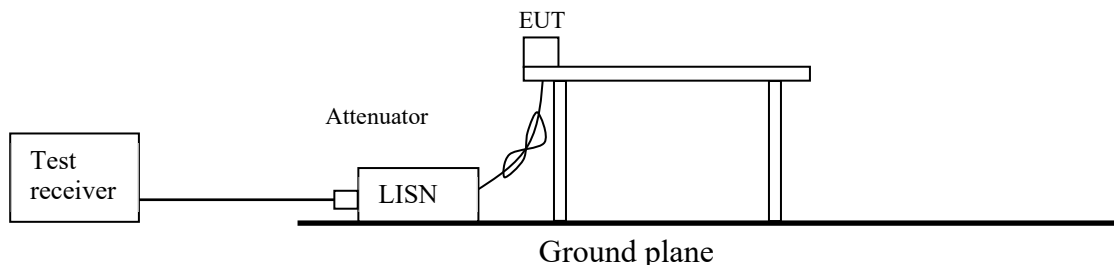

## **SECTION 6: Radiated Spurious Emission**

### **Test Procedure**

It was measured based on "8.5 and 8.6 of KDB 558074 D01 15.247 Meas Guidance v05r02".

[For below 1 GHz]

EUT was placed on a urethane platform of nominal size, 0.5 m by 1.0 m, raised 0.8 m above the conducting ground plane. The Radiated Electric Field Strength has been measured in a Semi Anechoic Chamber with a ground plane.

[For above 1 GHz]

EUT was placed on a urethane platform of nominal size, 0.5 m by 0.5 m, raised 1.5 m above the conducting ground plane. The Radiated Electric Field Strength has been measured in a Semi Anechoic Chamber with absorbent materials lined on a ground plane.

The height of the measuring antenna varied between 1 m and 4 m and EUT was rotated a full revolution in order to obtain the maximum value of the electric field strength.

Test antenna was aimed at the EUT for receiving the maximum signal and always kept within the illumination area of the 3 dB beamwidth of the antenna.

The measurements were performed for both vertical and horizontal antenna polarization with the Test Receiver, or the Spectrum Analyzer.

The measurements were made with the following detector function of the test receiver and the Spectrum analyzer (in linear mode).

The test was made with the detector (RBW/VBW) in the following table.

When using Spectrum analyzer, the test was made with adjusting span to zero by using peak hold.

### **Test Antennas are used as below;**

Frequency	30 MHz to 200 MHz	200 MHz to 1 GHz	Above 1 GHz
Antenna Type	Biconical	Logperiodic	Horn

In any 100 kHz bandwidth outside the restricted band in which the spread spectrum intentional radiator is operating, the radio frequency power that is produced by the intentional radiator confirmed 20 dB below that in the 100 kHz bandwidth within the band that contains the highest level of the desired power, based on a radiated measurement.

### **20 dBc was applied to the frequency over the limit of FCC 15.209 / Table 4 of RSS-Gen 8.9(ISED) and outside the restricted band of FCC15.205 / Table 6 of RSS-Gen 8.10 (ISED).**

Frequency	Below 1 GHz	Above 1 GHz		20 dBc
Instrument used	Test Receiver	Spectrum Analyzer		Spectrum Analyzer
Detector	QP	PK	AV *1)	PK
IF Bandwidth	BW 120 kHz	RBW: 1 MHz VBW: 3 MHz	11.12.2.5.1 RBW: 1 MHz VBW: 3 MHz Detector: Power Averaging (RMS) Trace: 100 traces 11.12.2.5.2 The duty cycle was less than 98% for detected noise, a duty factor was added to the 11.12.2.5.1 results.	RBW: 100 kHz VBW: 300 kHz

\*1) Average Power Measurement was performed based on ANSI C63.10-2013.

## **UL Japan, Inc.**

### **Ise EMC Lab.**

4383-326 Asama-cho, Ise-shi, Mie-ken 516-0021 JAPAN  
Telephone : +81 596 24 8999  
Facsimile : +81 596 24 8124

**Figure 2: Test Setup**

Below 1 GHz

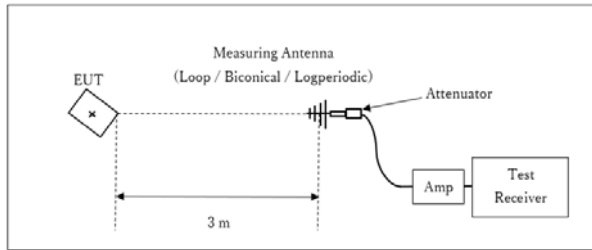

× : Center of turn table

Test Distance: 3 m

1 GHz - 10 GHz

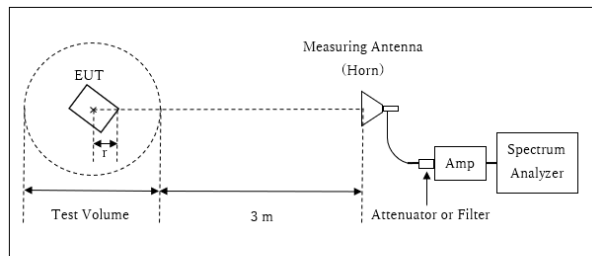

r : Radius of an outer periphery of EUT

× : Center of turn table

Distance Factor:  $20 \times \log(3.9 \text{ m} / 3.0 \text{ m}) = 2.28 \text{ dB}$

\* Test Distance:  $(3 + \text{Test Volume} / 2) - r = 3.9 \text{ m}$

Test Volume : 2.0 m

(Test Volume has been calibrated based on CISPR 16-1-4.)

r = 0.1 m

10 GHz – 26.5 GHz

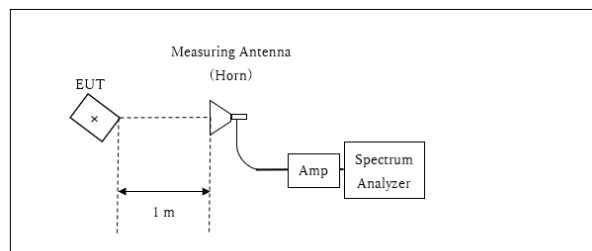

× : Center of turn table

Distance Factor:  $20 \times \log(1.0 \text{ m} / 3.0 \text{ m}) = -9.5 \text{ dB}$

\*Test Distance: 1 m

- The carrier level and noise levels were confirmed at each position of X, Y and Z axes of EUT to see the position of maximum noise, and the test was made at the position that has the maximum noise.

The test results and limit are rounded off to one decimal place, so some differences might be observed.

**Measurement range** : 30 MHz - 26.5 GHz  
**Test data** : APPENDIX  
**Test result** : Pass

## **SECTION 7: Antenna Terminal Conducted Tests**

### **Test Procedure**

The tests were made with below setting connected to the antenna port.

Test	Span	RBW	VBW	Sweep time	Detector	Trace	Instrument used
6dB Bandwidth	3 MHz	100 kHz	300 kHz	Auto	Peak	Max Hold	Spectrum Analyzer
99% Occupied Bandwidth *1)	Enough width to display emission skirts	1 to 5 % of OBW	Three times of RBW	Auto	Peak	Max Hold	Spectrum Analyzer
Maximum Peak Output Power	-	-	-	Auto	Peak/Average *2)	-	Power Meter (Sensor: 50 MHz BW)
Peak Power Density	1.5 times the 6dB Bandwidth	3 kHz	10 kHz	Auto	Peak	Max Hold	Spectrum Analyzer *3)
Conducted Spurious Emission *4), *5)	9kHz to 150kHz	200 Hz	620 Hz	Auto	Peak	Max Hold	Spectrum Analyzer
	150kHz to 30MHz	9.1 kHz	27 kHz				

\*1) Peak hold was applied as Worst-case measurement.  
\*2) Reference data  
\*3) Section 11.10.2 Method PKPSD (peak PSD) of "ANSI C63.10-2013".  
\*4) In the frequency range below 30MHz, RBW was narrowed to separate the noise contents.  
Then, wide-band noise near the limit was checked separately, however the noise was not detected as shown in the chart.  
\*5) The limits in CFR 47, Part 15, Subpart C, paragraph 15.209(a), are identical to those in RSS-Gen section 8.9, Table 6, since the measurements are performed in terms of magnetic field strength and converted to electric field strength levels (as reported in the table) using the free space impedance of 377 Ohms. For example, the measurement at frequency 9 kHz resulted in a level of 45.5 dBuV/m, which is equivalent to  $45.5 - 51.5 = -6.0$  dBuA/m, which has the same margin, 3 dB, to the corresponding RSS-Gen Table 6 limit as it has to 15.209(a) limit.

The test results and limit are rounded off to two decimals place, so some differences might be observed.  
The equipment and cables were not used for factor 0 dB of the data sheets.

**Test data : APPENDIX**  
**Test result : Pass**

**APPENDIX 1: Test data**

**Conducted Emission**

Report No. 13226743H  
Test place Ise EMC Lab. No.3 Semi Anechoic Chamber  
Date June 28, 2020  
Temperature / Humidity 22 deg. C / 60 % RH  
Engineer Takeshi Hiyaji  
Mode Tx 2403 MHz

Limit : FCC\_Part 15 Subpart C(15.207)

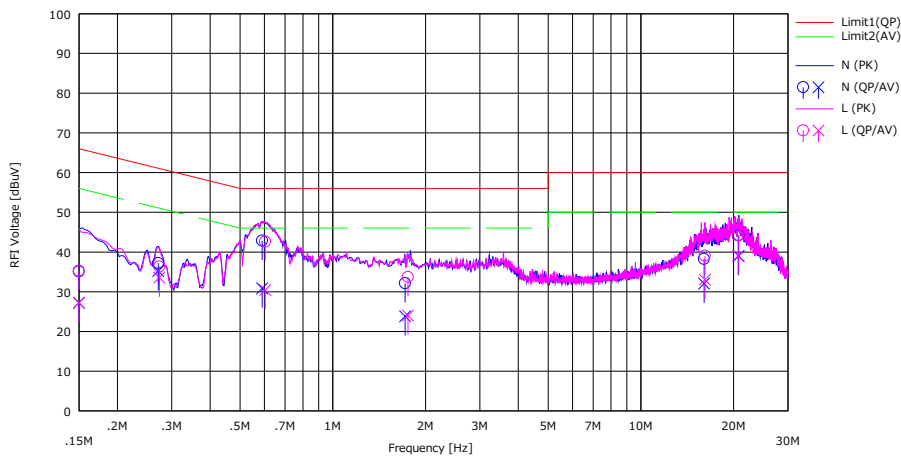

No.	Freq. [MHz]	Reading		LISN [dB]	LOSS [dB]	Results		Limit		Margin		Phase	Comment
		(QP) [dBuV]	(AV) [dBuV]			(QP) [dBuV]	(AV) [dBuV]	(QP) [dB]	(AV) [dB]				
1	0.15000	21.80	13.90	0.15	13.14	35.09	27.19	66.00	56.00	30.91	28.81	N	
2	0.27146	23.90	21.90	0.15	13.16	37.21	35.21	61.10	51.10	23.89	15.89	N	
3	0.59020	29.50	17.50	0.16	13.19	42.85	30.85	56.00	46.00	13.15	15.15	N	
4	1.71732	18.60	10.30	0.26	13.27	32.13	23.83	56.00	46.00	23.87	22.17	N	
5	16.03160	22.20	16.00	2.31	13.74	38.25	32.05	60.00	50.00	21.75	17.95	N	
6	20.77605	27.10	21.90	3.26	13.84	44.20	39.00	60.00	50.00	15.80	11.00	N	
7	0.15000	21.90	13.90	0.20	13.14	35.24	27.24	66.00	56.00	30.76	28.76	L	
8	0.27359	22.90	20.20	0.22	13.16	36.28	33.58	61.00	51.00	24.72	17.42	L	
9	0.60346	29.20	17.00	0.22	13.19	42.61	30.41	56.00	46.00	13.39	15.59	L	
10	1.75479	20.10	10.40	0.33	13.27	33.70	24.00	56.00	46.00	22.30	22.00	L	
11	16.13410	22.90	16.90	2.41	13.74	39.05	33.05	60.00	50.00	20.95	16.95	L	
12	20.67150	27.00	21.90	3.31	13.84	44.15	39.05	60.00	50.00	15.85	10.95	L	

CHART: WITH FACTOR Peak hold data. CALCULATION : RESULT = READING + LISN + LOSS (CABLE + ATT)  
Except for the above table: adequate margin data below the limits.



## Conducted Emission

Report No. 13226743H  
Test place Ise EMC Lab. No.3 Semi Anechoic Chamber  
Date June 28, 2020  
Temperature / Humidity 22 deg. C / 60 % RH  
Engineer Takeshi Hiyaji  
Mode Tx 2440 MHz

Limit : FCC\_Part 15 Subpart C(15.207)

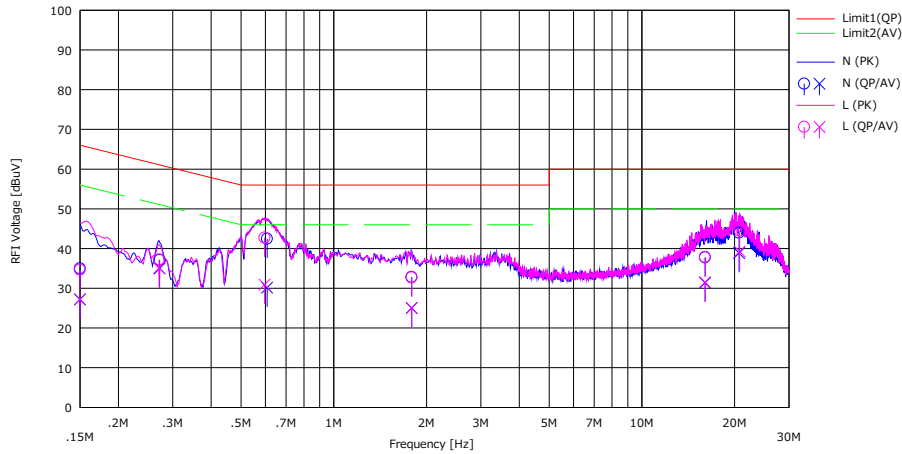

No.	Freq. [MHz]	Reading		LISN [dB]	LOSS [dB]	Results		Limit		Margin		Phase	Comment
		<QP> [dBuV]	<AV> [dBuV]			<QP> [dBuV]	<AV> [dBuV]	<QP> [dBuV]	<AV> [dBuV]	<QP> [dB]	<AV> [dB]		
		1	0.15000			21.70	13.90	0.15	13.14	34.99	27.19		
2	0.27225	23.80	21.70	0.15	13.16	37.11	35.01	61.00	51.00	23.89	15.99	N	
3	0.60762	29.10	16.80	0.16	13.19	42.45	30.15	56.00	46.00	13.55	15.85	N	
4	1.78893	19.30	11.50	0.26	13.28	32.84	25.04	56.00	46.00	23.16	20.96	N	
5	16.03830	21.70	15.30	2.31	13.74	37.75	31.35	60.00	50.00	22.25	18.65	N	
6	20.67190	26.90	21.80	3.24	13.84	43.98	38.88	60.00	50.00	16.02	11.12	N	
7	0.15000	21.30	13.90	0.20	13.14	34.64	27.24	66.00	56.00	31.36	28.76	L	
8	0.27109	23.82	21.70	0.22	13.16	37.20	35.08	61.10	51.10	23.90	16.02	L	
9	0.59638	29.30	17.50	0.22	13.19	42.71	30.91	56.00	46.00	13.29	15.09	L	
10	1.78976	19.10	11.40	0.33	13.28	32.71	25.01	56.00	46.00	23.29	20.99	L	
11	16.03830	21.70	15.40	2.40	13.74	37.84	31.54	60.00	50.00	22.16	18.46	L	
12	20.77440	27.30	22.10	3.33	13.84	44.47	39.27	60.00	50.00	15.53	10.73	L	

CHART: WITH FACTOR Peak hold data. CALCULATION : RESULT = READING + LISN + LOSS (CABLE + ATT)  
Except for the above table: adequate margin data below the limits.

## Conducted Emission

**Report No.** 13226743H  
**Test place** Ise EMC Lab. No.3 Semi Anechoic Chamber  
**Date** June 28, 2020  
**Temperature / Humidity** 22 deg. C / 60 % RH  
**Engineer** Takeshi Hiyaji  
**Mode** Tx 2480 MHz

Limit : FCC\_Part 15 Subpart C(15.207)

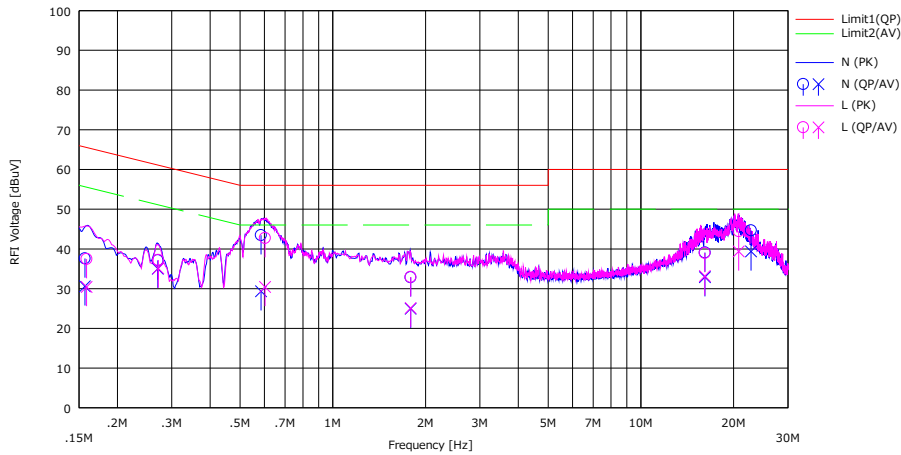

No.	Freq. [MHz]	Reading		LISN [dB]	LOSS [dB]	Results		Limit		Margin		Phase	Comment
		<QP> [dBuV]	<AV> [dBuV]			<QP> [dBuV]	<AV> [dBuV]	<QP> [dBuV]	<AV> [dBuV]	<QP> [dB]	<AV> [dB]		
1	0.15685	24.30	17.30	0.15	13.14	37.59	30.59	65.60	55.60	28.01	25.01	N	
2	0.27040	23.80	21.70	0.15	13.16	37.11	35.01	61.10	51.10	23.99	16.09	N	
3	0.58514	30.10	16.00	0.16	13.19	43.45	29.35	56.00	46.00	12.55	16.65	N	
4	1.78893	19.30	11.40	0.26	13.28	32.84	24.94	56.00	46.00	23.16	21.06	N	
5	16.13410	23.00	16.80	2.33	13.74	39.07	32.87	60.00	50.00	20.93	17.13	N	
6	22.77140	27.10	21.80	3.67	13.88	44.65	39.35	60.00	50.00	15.35	10.65	N	
7	0.15889	24.10	17.10	0.20	13.14	37.44	30.44	65.50	55.50	28.06	25.06	L	
8	0.27138	23.80	21.70	0.22	13.16	37.18	35.08	61.10	51.10	23.92	16.02	L	
9	0.60262	29.30	17.00	0.22	13.19	42.71	30.41	56.00	46.00	13.29	15.59	L	
10	1.78893	19.30	11.50	0.33	13.28	32.91	25.11	56.00	46.00	23.09	20.89	L	
11	16.13160	22.80	17.00	2.41	13.74	38.95	33.15	60.00	50.00	21.05	16.85	L	
12	20.77440	27.30	22.20	3.33	13.84	44.47	39.37	60.00	50.00	15.53	10.63	L	

CHART: WITH FACTOR Peak hold data. CALCULATION : RESULT = READING + LISN + LOSS (CABLE + ATT)  
 Except for the above table: adequate margin data below the limits.

### **6 dB Bandwidth and 99 % Occupied Bandwidth**

Report No. 13226743H  
Test place Ise EMC Lab. No.6 Measurement Room  
Date March 19, 2020  
Temperature / Humidity 23 deg. C / 32 % RH  
Engineer Yuta Moriya  
Mode Tx

Frequency [MHz]	99% Occupied Bandwidth [kHz]	6dB Bandwidth [MHz]	Limit for 6dB Bandwidth [MHz]
2403	917.4	0.501	> 0.5000
2440	920.5	0.502	> 0.5000
2480	922.6	0.501	> 0.5000

## 99 % Occupied Bandwidth

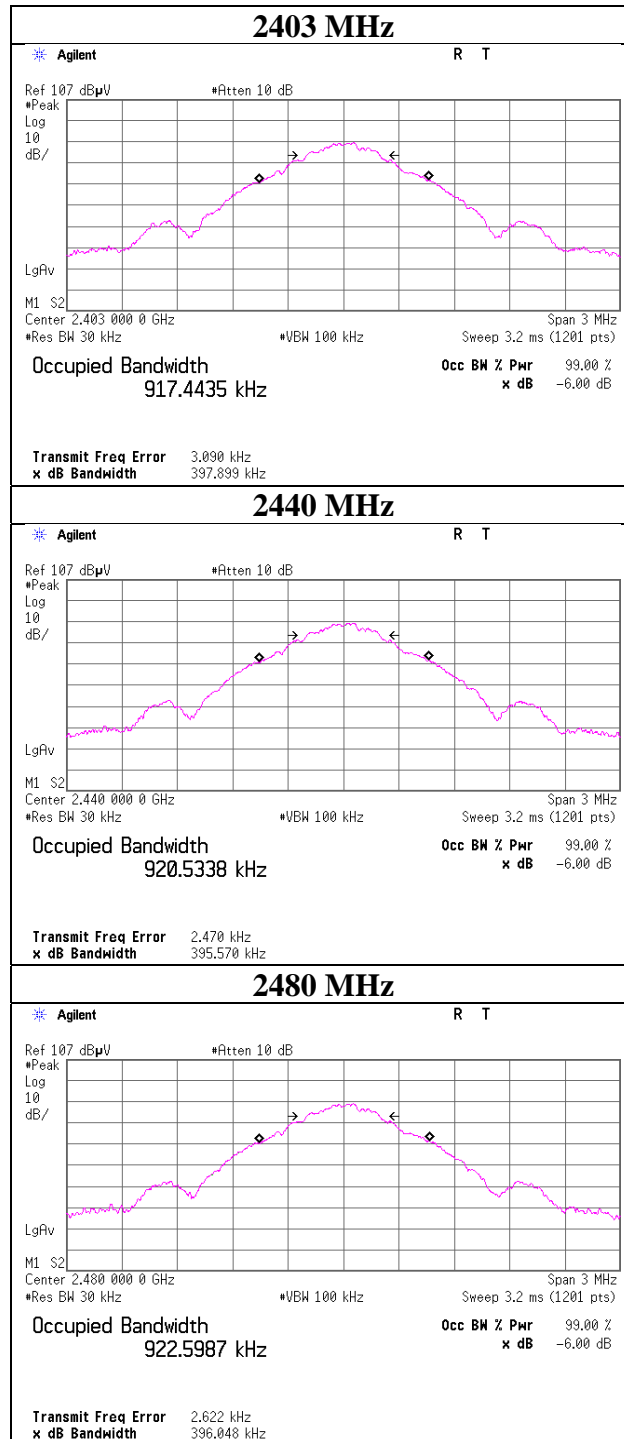

**UL Japan, Inc.**

**Ise EMC Lab.**

4383-326 Asama-cho, Ise-shi, Mie-ken 516-0021 JAPAN

Telephone : +81 596 24 8999

Facsimile : +81 596 24 8124

## 6 dB Bandwidth

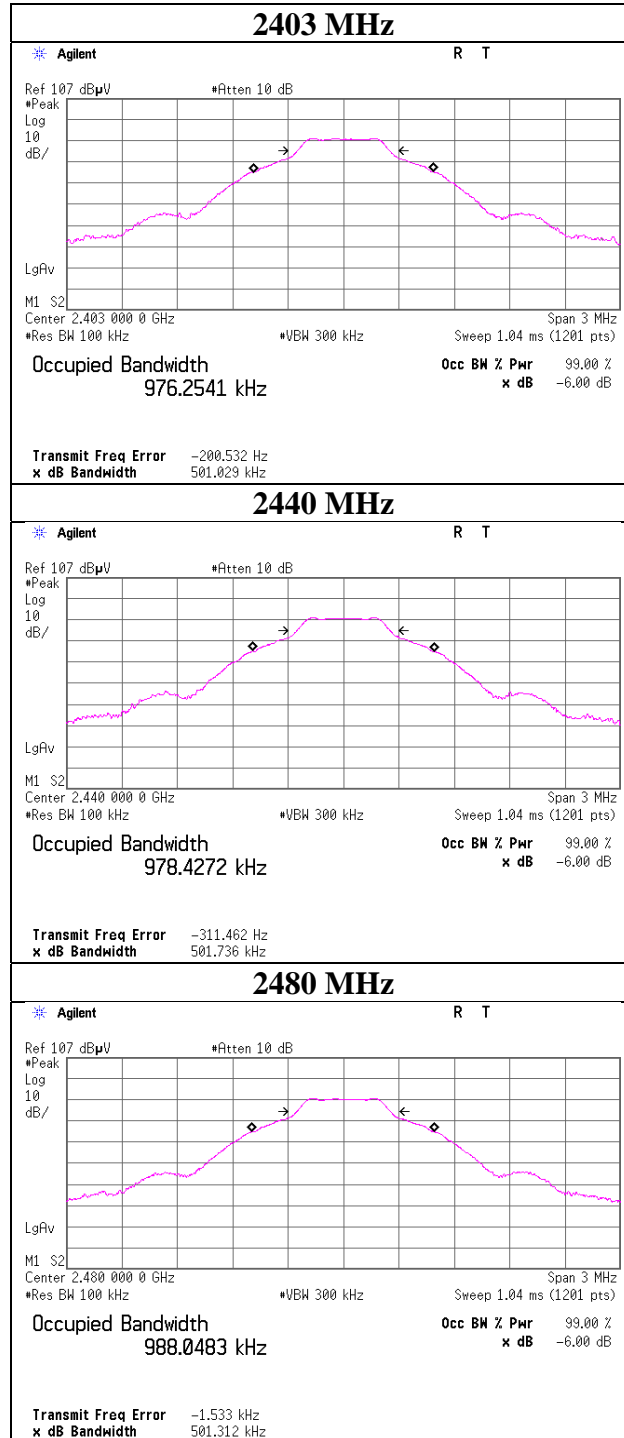

## Maximum Peak Output Power

Report No. 13226743H  
Test place Ise EMC Lab. No.6 Measurement Room  
Date March 19, 2020 August 26, 2020  
Temperature / Humidity 23 deg. C / 32 % RH 22 deg. C / 48 % RH  
Engineer Yuta Moriya Junki Nagatomi  
Mode Tx

Power setting (0dBm)				Conducted Power					e.i.r.p. for RSS-247					
Freq. [MHz]	Reading [dBm]	Cable Loss [dB]	Atten. Loss [dB]	Result		Limit		Margin [dB]	Antenna Gain [dBi]	Result		Limit		Margin [dB]
				[dBm]	[mW]	[dBm]	[mW]			[dBm]	[mW]	[dBm]	[mW]	
2403	-11.89	0.00	0.00	-11.89	0.06	30.00	1000	41.89	6.00	-5.89	0.26	36.02	4000	41.91
2440	-12.19	0.00	0.00	-12.19	0.06	30.00	1000	42.19	6.00	-6.19	0.24	36.02	4000	42.21
2480	-12.59	0.00	0.00	-12.59	0.06	30.00	1000	42.59	6.00	-6.59	0.22	36.02	4000	42.61

Power setting (-20dBm)				Conducted Power					e.i.r.p. for RSS-247					
Freq. [MHz]	Reading [dBm]	Cable Loss [dB]	Atten. Loss [dB]	Result		Limit		Margin [dB]	Antenna Gain [dBi]	Result		Limit		Margin [dB]
				[dBm]	[mW]	[dBm]	[mW]			[dBm]	[mW]	[dBm]	[mW]	
2403	-31.20	0.28	0.00	-30.92	0.001	30.00	1000	60.92	6.00	-24.92	0.003	36.02	4000	60.94
2440	-31.22	0.29	0.00	-30.93	0.001	30.00	1000	60.93	6.00	-24.93	0.003	36.02	4000	60.95
2480	-31.98	0.29	0.00	-31.69	0.001	30.00	1000	61.69	6.00	-25.69	0.003	36.02	4000	61.71

Sample Calculation:

Result = Reading + Cable Loss + Attenuator Loss

e.i.r.p. Result = Conducted Power Result + Antenna Gain

\*The equipment and cables were not used for factor 0 dB of the data sheets.

**Average Output Power**  
**(Reference data for RF Exposure)**

Report No. 13226743H  
Test place Ise EMC Lab. No.6 Measurement Room  
Date March 19, 2020 August 26, 2020  
Temperature / Humidity 23 deg. C / 32 % RH 22 deg. C / 48 % RH  
Engineer Yuta Moriya Junki Nagatomi  
Mode Tx

Power setting (0dBm)

Freq. [MHz]	Reading [dBm]	Cable Loss [dB]	Atten. Loss [dB]	Result (Time average)		Duty factor [dB]	Result (Burst power average)	
				[dBm]	[mW]		[dBm]	[mW]
2403	-12.16	0.00	0.00	-12.16	0.06	0.00	-12.16	0.06
2440	-12.49	0.00	0.00	-12.49	0.06	0.00	-12.49	0.06
2480	-12.92	0.00	0.00	-12.92	0.05	0.00	-12.92	0.05

Power setting (-20dBm)

Freq. [MHz]	Reading [dBm]	Cable Loss [dB]	Atten. Loss [dB]	Result (Time average)		Duty factor [dB]	Result (Burst power average)	
				[dBm]	[mW]		[dBm]	[mW]
2403	-41.52	0.28	9.77	-31.47	0.001	0.00	-31.47	0.001
2440	-41.89	0.29	9.77	-31.83	0.001	0.00	-31.83	0.001
2480	-42.40	0.29	9.77	-32.34	0.001	0.00	-32.34	0.001

Sample Calculation:

Result (Time average) = Reading + Cable Loss + Attenuator Loss

Result (Burst power average) = Time average + Duty factor

\*The equipment and cables were not used for factor 0 dB of the data sheets.

### Burst rate confirmation

Report No. 13226743H  
Test place Ise EMC Lab. No.6 Measurement Room  
Date March 24, 2020  
Temperature / Humidity 24 deg. C / 34 % RH  
Engineer Junki Nagatomi  
Mode Tx

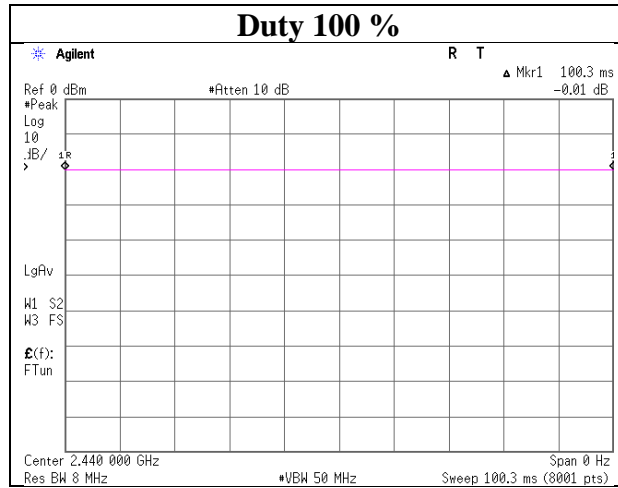

\* Since the burst rate is not different between the channels, the data has been obtained on the representative channel.



## Radiated Spurious Emission

Report No.	13226743H		
Test place	Ise EMC Lab.		
Semi Anechoic Chamber	No.3	No.3	No.3
Date	June 24, 2020	June 26, 2020	June 27, 2020
Temperature / Humidity	20 deg. C / 62 % RH	22 deg. C / 67 % RH	22 deg. C / 67 % RH
Engineer	Junki Nagatomi (1 GHz - 10 GHz)	Junki Nagatomi (10 GHz - 26.5 GHz)	Takeshi Hiyaji Below 1GHz
Mode	Tx 2403 MHz		

Polarity	Frequency [MHz]	Detector	Reading [dBuV]	Ant.Fac. [dBm]	Loss [dB]	Gain [dB]	Duty Factor [dB]	Result [dBuV/m]	Limit [dBuV/m]	Margin [dB]	Remark
Hori.	48.000	QP	33.6	11.9	7.4	32.2	-	20.7	40.0	19.3	
Hori.	96.000	QP	44.7	9.6	8.0	32.1	-	30.2	43.5	13.4	
Hori.	120.000	QP	50.0	12.9	8.3	32.1	-	39.1	43.5	4.4	
Hori.	216.000	QP	42.7	11.1	9.3	32.0	-	31.0	43.5	12.5	
Hori.	264.000	QP	49.1	12.5	9.7	32.0	-	39.3	46.0	6.7	
Hori.	336.000	QP	42.1	14.7	10.2	32.0	-	35.1	46.0	10.9	
Hori.	480.000	QP	36.5	17.2	11.2	32.0	-	32.9	46.0	13.1	
Hori.	2390.000	PK	41.3	27.7	5.4	32.7	-	41.6	73.9	32.3	
Hori.	4806.000	PK	41.0	31.6	7.5	31.7	-	48.4	73.9	25.5	Floor noise
Hori.	7209.000	PK	42.3	36.0	8.9	32.6	-	54.6	73.9	19.3	Floor noise
Hori.	9612.000	PK	42.1	38.5	7.4	33.3	-	54.8	73.9	19.1	Floor noise
Hori.	2390.000	AV	33.5	27.7	5.4	32.7	-	33.8	53.9	20.1	
Hori.	4806.000	AV	32.6	31.6	7.5	31.7	-	40.0	53.9	13.9	Floor noise
Hori.	7209.000	AV	34.6	36.0	8.9	32.6	-	46.9	53.9	7.0	Floor noise
Hori.	9612.000	AV	34.0	38.5	7.4	33.3	-	46.6	53.9	7.3	Floor noise
Vert.	48.000	QP	45.2	11.9	7.4	32.2	-	32.3	40.0	7.7	
Vert.	96.000	QP	46.5	9.6	8.0	32.1	-	32.0	43.5	11.6	
Vert.	120.000	QP	49.2	12.9	8.3	32.1	-	38.3	43.5	5.2	
Vert.	216.000	QP	42.7	11.1	9.3	32.0	-	31.0	43.5	12.5	
Vert.	264.000	QP	50.6	12.5	9.7	32.0	-	40.8	46.0	5.2	
Vert.	336.000	QP	46.1	14.7	10.2	32.0	-	39.1	46.0	6.9	
Vert.	480.000	QP	39.0	17.2	11.2	32.0	-	35.4	46.0	10.6	
Vert.	2390.000	PK	42.4	27.7	5.4	32.7	-	42.7	73.9	31.2	
Vert.	4806.000	PK	40.7	31.6	7.5	31.7	-	48.1	73.9	25.8	Floor noise
Vert.	7209.000	PK	42.9	36.0	8.9	32.6	-	55.2	73.9	18.7	Floor noise
Vert.	9612.000	PK	42.0	38.5	7.4	33.3	-	54.7	73.9	19.2	Floor noise
Vert.	2390.000	AV	33.4	27.7	5.4	32.7	-	33.8	53.9	20.2	
Vert.	4806.000	AV	32.6	31.6	7.5	31.7	-	40.0	53.9	13.9	Floor noise
Vert.	7209.000	AV	34.6	36.0	8.9	32.6	-	46.9	53.9	7.0	Floor noise
Vert.	9612.000	AV	34.0	38.5	7.4	33.3	-	46.6	53.9	7.3	Floor noise

Result = Reading + Ant Factor + Loss (Cable+Attenuator+Filter+Distance factor(above 1 GHz)) - Gain(Amplifier)

\*Other frequency noises omitted in this report were not seen or had enough margin (more than 20 dB).

Distance factor: 1 GHz - 10 GHz 20log(3.9 m / 3.0 m) = 2.28 dB  
10 GHz - 26.5 GHz 20log(1.0 m / 3.0 m) = -9.5 dB

### 20dBc Data Sheet

Polarity	Frequency [MHz]	Detector	Reading [dBuV]	Ant Factor [dBm]	Loss [dB]	Gain [dB]	Result [dBuV/m]	Limit [dBuV/m]	Margin [dB]	Remark
Hori.	2403.000	PK	86.8	27.7	5.4	32.7	87.1	-	-	Carrier
Hori.	2400.000	PK	35.3	27.7	5.4	32.7	35.7	67.1	31.4	
Vert.	2403.000	PK	88.0	27.7	5.4	32.7	88.3	-	-	Carrier
Vert.	2400.000	PK	35.5	27.7	5.4	32.7	35.9	68.3	32.5	

Result = Reading + Ant Factor + Loss (Cable+Attenuator+Filter+Distance factor(above 1 GHz)) - Gain(Amplifier)

**UL Japan, Inc.**

**Ise EMC Lab.**

4383-326 Asama-cho, Ise-shi, Mie-ken 516-0021 JAPAN

Telephone : +81 596 24 8999

Facsimile : +81 596 24 8124

**Radiated Spurious Emission**  
**(Reference Plot for band-edge)**

Report No. 13226743H  
Test place Ise EMC Lab.  
Semi Anechoic Chamber No.3  
Date June 24, 2020  
Temperature / Humidity 20 deg. C / 62 % RH  
Engineer Junki Nagatomi  
(1 GHz - 10 GHz)  
Mode Tx 2403 MHz

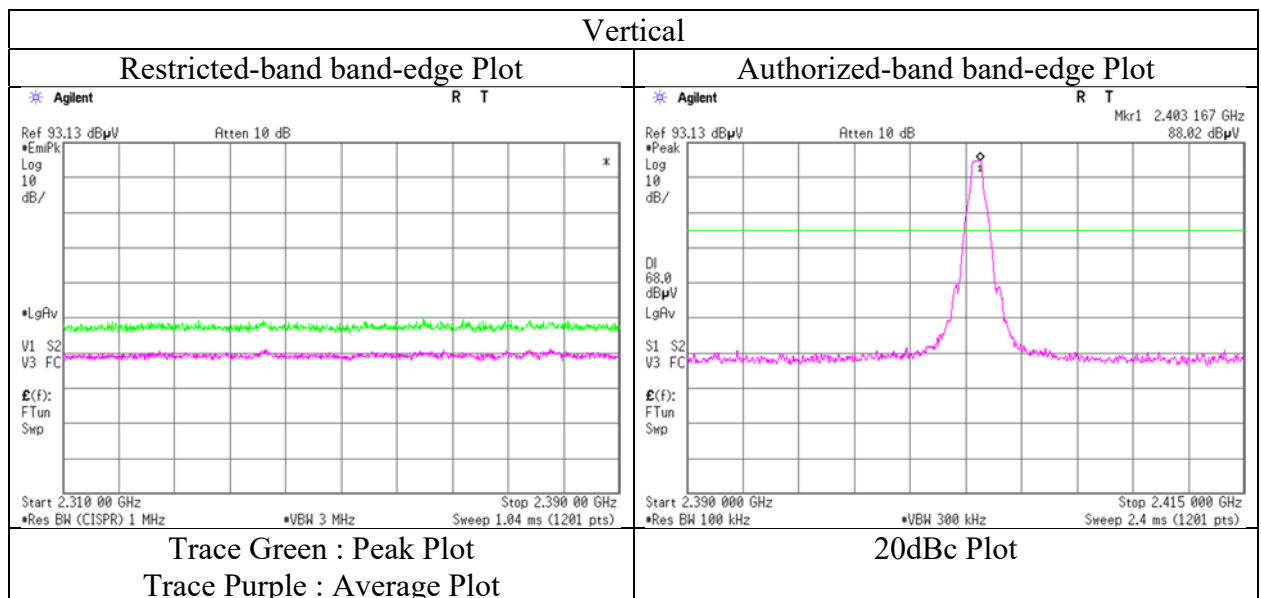
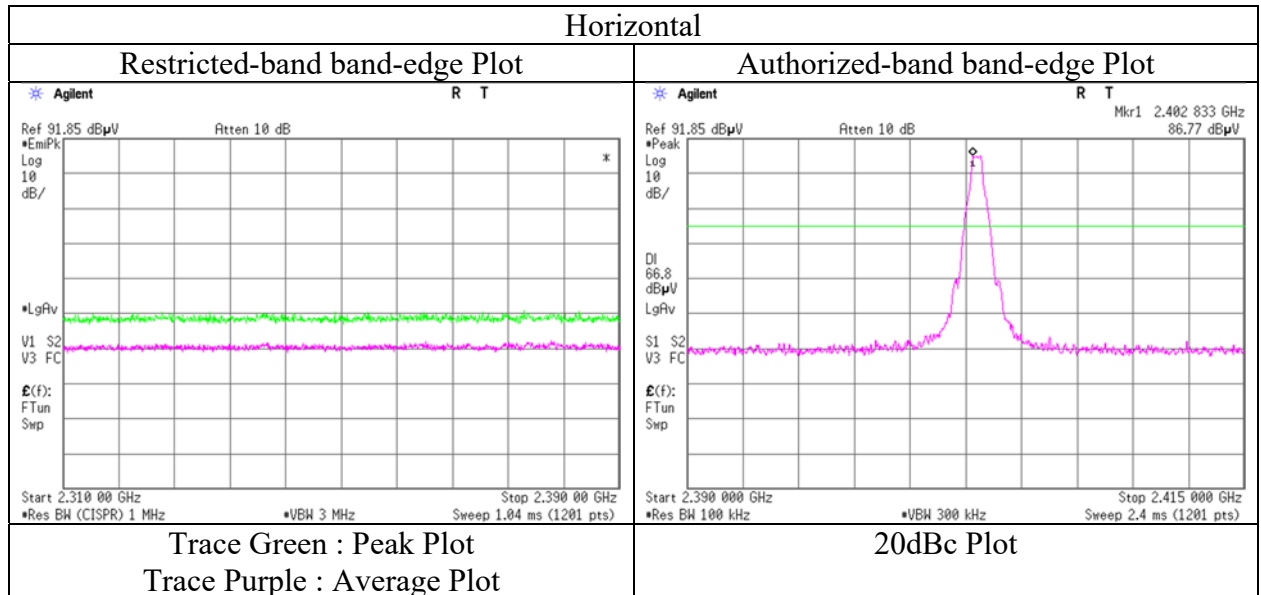

\* The measurement was conducted for a sufficiently long enough time to detect any possible spurious emissions.  
Final result of restricted band edge was shown in tabular data.

## Radiated Spurious Emission

Report No.	13226743H		
Test place	Ise EMC Lab.		
Semi Anechoic Chamber	No.3	No.3	No.3
Date	June 24, 2020	June 26, 2020	June 27, 2020
Temperature / Humidity	20 deg. C / 62 % RH	22 deg. C / 67 % RH	22 deg. C / 67 % RH
Engineer	Junki Nagatomi	Junki Nagatomi	Takeshi Hiyaji
	(1 GHz - 10 GHz)	(10 GHz - 26.5 GHz)	Below 1GHz
Mode	Tx 2440 MHz		

Polarity	Frequency [MHz]	Detector	Reading [dBuV]	Ant.Fac. [dB/m]	Loss [dB]	Gain [dB]	Duty Factor [dB]	Result [dBuV/m]	Limit [dBuV/m]	Margin [dB]	Remark
Hori.	48.000	QP	34.2	11.9	7.4	32.2	-	21.3	40.0	18.7	
Hori.	96.000	QP	44.4	9.6	8.0	32.1	-	29.9	43.5	13.7	
Hori.	120.000	QP	50.8	12.9	8.3	32.1	-	39.9	43.5	3.6	
Hori.	264.000	QP	50.6	12.5	9.7	32.0	-	40.8	46.0	5.2	
Hori.	336.000	QP	46.0	14.7	10.2	32.0	-	39.0	46.0	7.0	
Hori.	480.000	QP	38.0	17.2	11.2	32.0	-	34.4	46.0	11.6	
Hori.	4880.000	PK	41.2	31.5	7.5	31.6	-	48.6	73.9	25.3	Floor noise
Hori.	7320.000	PK	42.4	36.2	8.9	32.6	-	54.9	73.9	19.0	Floor noise
Hori.	9760.000	PK	42.4	38.8	7.5	33.4	-	55.3	73.9	18.6	Floor noise
Hori.	4880.000	AV	32.8	31.5	7.5	31.6	-	40.2	53.9	13.7	Floor noise
Hori.	7320.000	AV	33.9	36.2	8.9	32.6	-	46.4	53.9	7.6	Floor noise
Hori.	9760.000	AV	33.7	38.8	7.5	33.4	-	46.6	53.9	7.3	Floor noise
Vert.	48.000	QP	51.8	11.9	7.4	32.2	-	38.9	40.0	1.1	
Vert.	96.000	QP	48.4	9.6	8.0	32.1	-	33.9	43.5	9.6	
Vert.	120.000	QP	50.8	12.9	8.3	32.1	-	39.9	43.5	3.6	
Vert.	264.000	QP	49.2	12.5	9.7	32.0	-	39.4	46.0	6.6	
Vert.	336.000	QP	41.1	14.7	10.2	32.0	-	34.1	46.0	11.9	
Vert.	480.000	QP	35.2	17.2	11.2	32.0	-	31.6	46.0	14.4	
Vert.	4880.000	PK	41.0	31.5	7.5	31.6	-	48.4	73.9	25.5	Floor noise
Vert.	7320.000	PK	43.1	36.2	8.9	32.6	-	55.5	73.9	18.4	Floor noise
Vert.	9760.000	PK	42.9	38.8	7.5	33.4	-	55.7	73.9	18.2	Floor noise
Vert.	4880.000	AV	32.8	31.5	7.5	31.6	-	40.2	53.9	13.7	Floor noise
Vert.	7320.000	AV	33.9	36.2	8.9	32.6	-	46.4	53.9	7.6	Floor noise
Vert.	9760.000	AV	33.7	38.8	7.5	33.4	-	46.6	53.9	7.3	Floor noise

Result = Reading + Ant Factor + Loss (Cable+Attenuator+Filter+Distance factor(above 1 GHz)) - Gain(Amplifier)

\*Other frequency noises omitted in this report were not seen or had enough margin (more than 20 dB).

## Radiated Spurious Emission

Report No.	13226743H		
Test place	Ise EMC Lab.		
Semi Anechoic Chamber	No.3	No.3	No.3
Date	June 24, 2020	June 26, 2020	June 27, 2020
Temperature / Humidity	20 deg. C / 62 % RH	22 deg. C / 67 % RH	22 deg. C / 67 % RH
Engineer	Junki Nagatomi (1 GHz - 10 GHz)	Junki Nagatomi (10 GHz - 26.5 GHz)	Takeshi Hiyaji Below 1GHz
Mode	Tx 2480 MHz		

Polarity	Frequency [MHz]	Detector	Reading [dBuV]	Ant.Fac. [dB/m]	Loss [dB]	Gain [dB]	Duty Factor [dB]	Result [dBuV/m]	Limit [dBuV/m]	Margin [dB]	Remark
Hori.	48.000	QP	33.8	11.9	7.4	32.2	-	20.9	40.0	19.1	
Hori.	96.000	QP	44.2	9.6	8.0	32.1	-	29.7	43.5	13.9	
Hori.	120.000	QP	50.4	12.9	8.3	32.1	-	39.5	43.5	4.0	
Hori.	264.000	QP	50.8	12.5	9.7	32.0	-	41.0	46.0	5.0	
Hori.	336.000	QP	46.2	14.7	10.2	32.0	-	39.2	46.0	6.8	
Hori.	480.000	QP	38.0	17.2	11.2	32.0	-	34.4	46.0	11.6	
Hori.	2483.500	PK	42.6	27.5	5.4	32.7	-	42.8	73.9	31.1	
Hori.	4960.000	PK	40.9	31.6	6.8	31.6	-	47.6	73.9	26.3	Floor noise
Hori.	7440.000	PK	43.1	36.3	8.9	32.7	-	55.6	73.9	18.3	Floor noise
Hori.	9920.000	PK	42.0	38.9	9.4	33.5	-	56.9	73.9	17.0	Floor noise
Hori.	2483.500	AV	33.9	27.5	5.4	32.7	-	34.1	53.9	19.8	
Hori.	4960.000	AV	32.4	31.6	6.8	31.6	-	39.1	53.9	14.8	Floor noise
Hori.	7440.000	AV	34.7	36.3	8.9	32.7	-	47.3	53.9	6.6	Floor noise
Hori.	9920.000	AV	34.0	38.9	9.4	33.5	-	48.9	53.9	5.0	Floor noise
Vert.	48.000	QP	48.4	11.9	7.4	32.2	-	35.5	40.0	4.5	
Vert.	96.000	QP	45.9	9.6	8.0	32.1	-	31.4	43.5	12.2	
Vert.	120.000	QP	49.5	12.9	8.3	32.1	-	38.6	43.5	4.9	
Vert.	264.000	QP	49.3	12.5	9.7	32.0	-	39.5	46.0	6.5	
Vert.	336.000	QP	41.5	14.7	10.2	32.0	-	34.5	46.0	11.5	
Vert.	480.000	QP	35.2	17.2	11.2	32.0	-	31.6	46.0	14.4	
Vert.	2483.500	PK	42.7	27.5	5.4	32.7	-	42.9	73.9	31.0	
Vert.	4960.000	PK	41.2	31.6	7.5	31.6	-	48.6	73.9	25.3	Floor noise
Vert.	7440.000	PK	44.7	36.3	8.9	32.7	-	57.2	73.9	16.7	Floor noise
Vert.	9920.000	PK	42.6	38.9	7.5	33.5	-	55.6	73.9	18.4	Floor noise
Vert.	2483.500	AV	34.4	27.5	5.4	32.7	-	34.6	53.9	19.3	
Vert.	4960.000	AV	32.4	31.6	7.5	31.6	-	39.8	53.9	14.1	Floor noise
Vert.	7440.000	AV	34.7	36.3	8.9	32.7	-	47.3	53.9	6.6	Floor noise
Vert.	9920.000	AV	34.0	38.9	7.5	33.5	-	47.0	53.9	7.0	Floor noise

Result = Reading + Ant Factor + Loss (Cable+Attenuator+Filter+Distance factor(above 1 GHz)) - Gain(Amplifier)

\*Other frequency noises omitted in this report were not seen or had enough margin (more than 20 dB).

Distance factor: 1 GHz - 10 GHz  $20\log(3.9\text{ m} / 3.0\text{ m}) = 2.28\text{ dB}$   
10 GHz - 26.5 GHz  $20\log(1.0\text{ m} / 3.0\text{ m}) = -9.5\text{ dB}$

**Radiated Spurious Emission**  
**(Reference Plot for band-edge)**

Report No. 13226743H  
Test place Ise EMC Lab.  
Semi Anechoic Chamber No.3  
Date June 24, 2020  
Temperature / Humidity 20 deg. C / 62 % RH  
Engineer Junki Nagatomi  
(1 GHz - 10 GHz)  
Mode Tx 2480 MHz

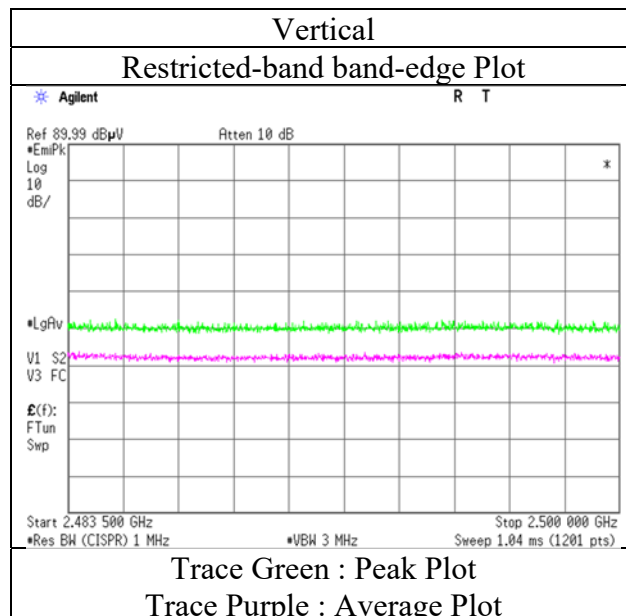
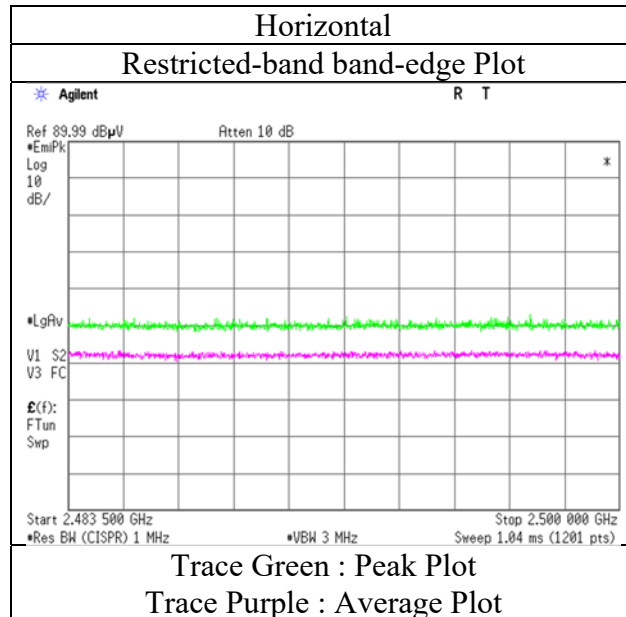

\* The measurement was conducted for a sufficiently long enough time to detect any possible spurious emissions.

Final result of restricted band edge was shown in tabular data.

**Radiated Spurious Emission**  
**(Plot data, Worst case)**

Report No.	13226743H		
Test place	Ise EMC Lab.		
Semi Anechoic Chamber	No.3	No.3	No.3
Date	June 24, 2020	June 26, 2020	June 27, 2020
Temperature / Humidity	20 deg. C / 62 % RH	22 deg. C / 67 % RH	22 deg. C / 67 % RH
Engineer	Junki Nagatomi	Junki Nagatomi	Takeshi Hiyaji
Mode	(1 GHz - 10 GHz) Tx 2403 MHz	(10 GHz - 26.5 GHz)	Below 1GHz

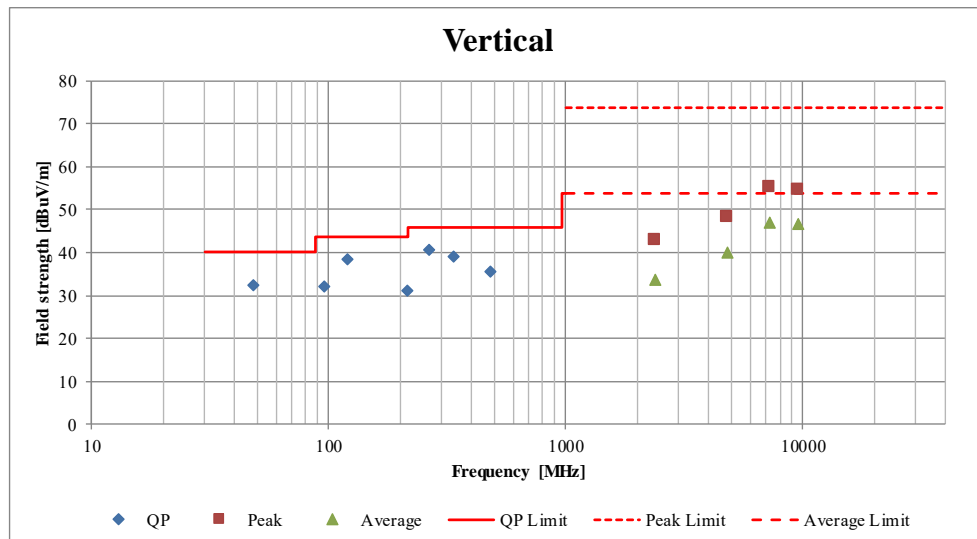
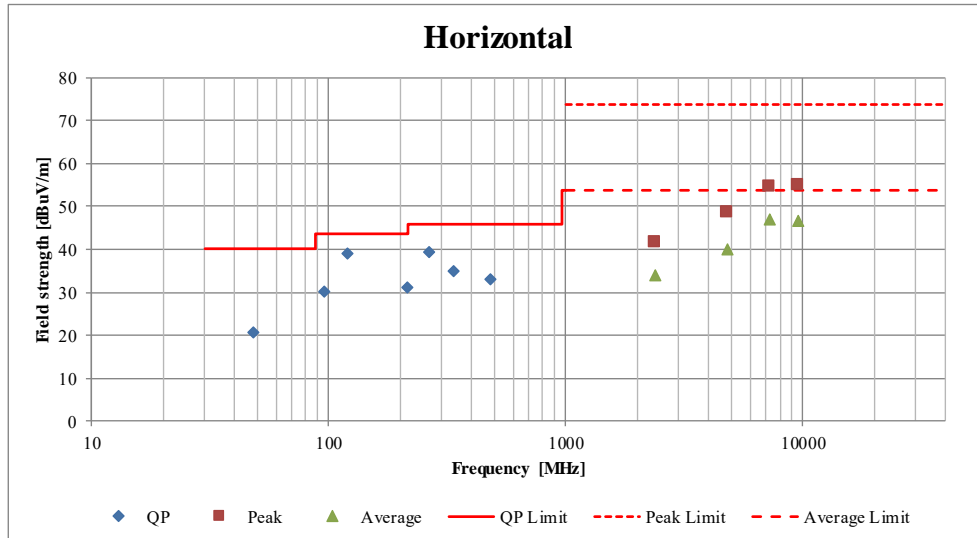

\*These plots data contains sufficient number to show the trend of characteristic features for EUT.

## Conducted Spurious Emission

Report No. 13226743H  
 Test place Ise EMC Lab. No.6 Measurement Room  
 Date March 19, 2020  
 Temperature / Humidity 23 deg. C / 32 % RH  
 Engineer Yuta Moriya  
 Mode Tx 2403 MHz

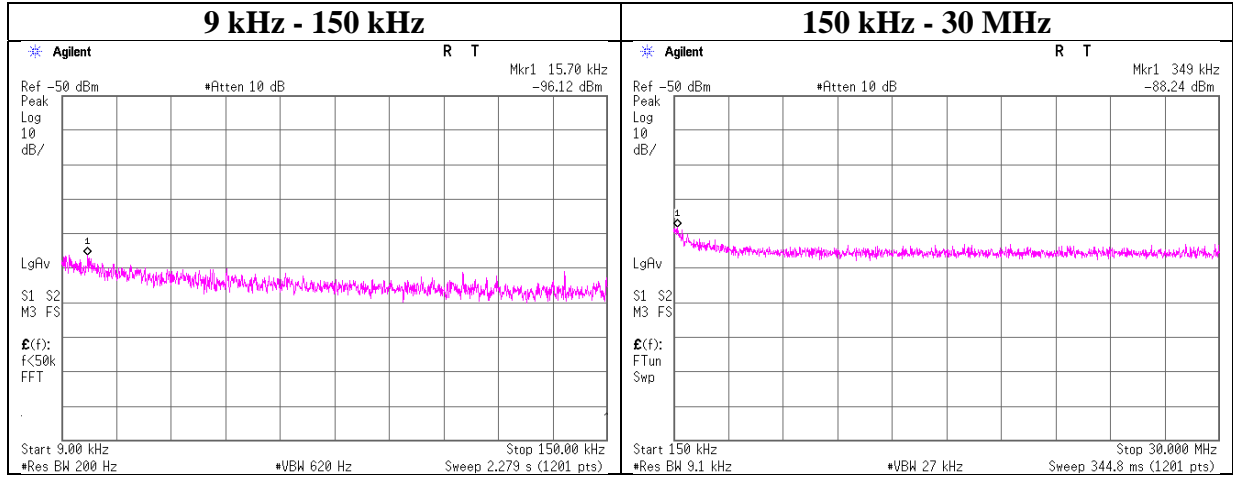

Frequency [kHz]	Reading [dBm]	Cable Loss [dB]	Attenuator Loss [dB]	Antenna Gain* [dBi]	N (Number of Output)	EIRP [dBm]	Distance [m]	Ground bounce [dB]	E (field strength) [dBuV/m]	Limit [dBuV/m]	Margin [dB]	Remark
15.70	-96.1	0.00	9.9	6.0	1	-80.3	300	6.0	-19.0	43.6	62.6	
349.00	-88.2	0.01	9.9	6.0	1	-72.4	300	6.0	-11.1	16.7	27.8	

$$E \text{ [dBuV/m]} = \text{EIRP [dBm]} - 20 \log (\text{Distance [m]}) + \text{Ground bounce [dB]} + 104.8 \text{ [dBuV/m]}$$

$$\text{EIRP [dBm]} = \text{Reading [dBm]} + \text{Cable loss [dB]} + \text{Attenuator Loss [dB]} + \text{Antenna gain [dBi]} + 10 * \log (N)$$

N: Number of output

## Conducted Spurious Emission

Report No. 13226743H  
 Test place Ise EMC Lab. No.6 Measurement Room  
 Date March 19, 2020  
 Temperature / Humidity 23 deg. C / 32 % RH  
 Engineer Yuta Moriya  
 Mode Tx 2440 MHz

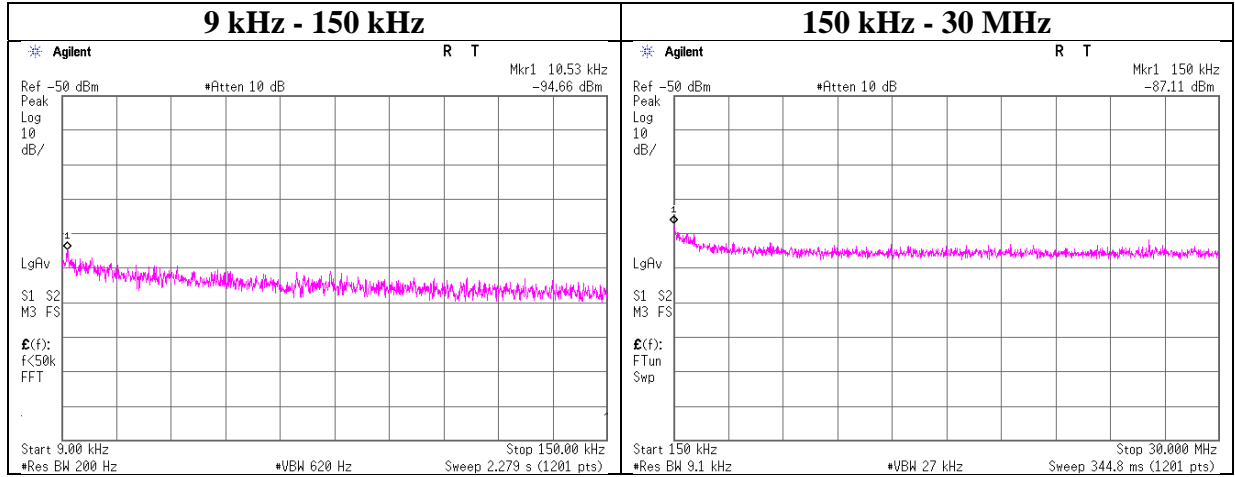

Frequency [kHz]	Reading [dBm]	Cable Loss [dB]	Attenuator Loss [dB]	Antenna Gain* [dBi]	N (Number of Output)	EIRP [dBm]	Distance [m]	Ground bounce [dB]	E (field strength) [dBuV/m]	Limit [dBuV/m]	Margin [dB]	Remark
10.53	-95.6	0.00	9.9	6.0	1	-79.7	300	6.0	-18.4	47.1	65.5	
150.00	-87.8	0.01	9.9	6.0	1	-71.9	300	6.0	-10.7	24.0	34.7	

$$E \text{ [dBuV/m]} = \text{EIRP [dBm]} - 20 \log(\text{Distance [m]}) + \text{Ground bounce [dB]} + 104.8 \text{ [dBuV/m]}$$

$$\text{EIRP [dBm]} = \text{Reading [dBm]} + \text{Cable loss [dB]} + \text{Attenuator Loss [dB]} + \text{Antenna gain [dBi]} + 10 * \log(N)$$

N: Number of output



## Conducted Spurious Emission

Report No. 13226743H  
 Test place Ise EMC Lab. No.6 Measurement Room  
 Date March 19, 2020  
 Temperature / Humidity 23 deg. C / 32 % RH  
 Engineer Yuta Moriya  
 Mode Tx 2480 MHz

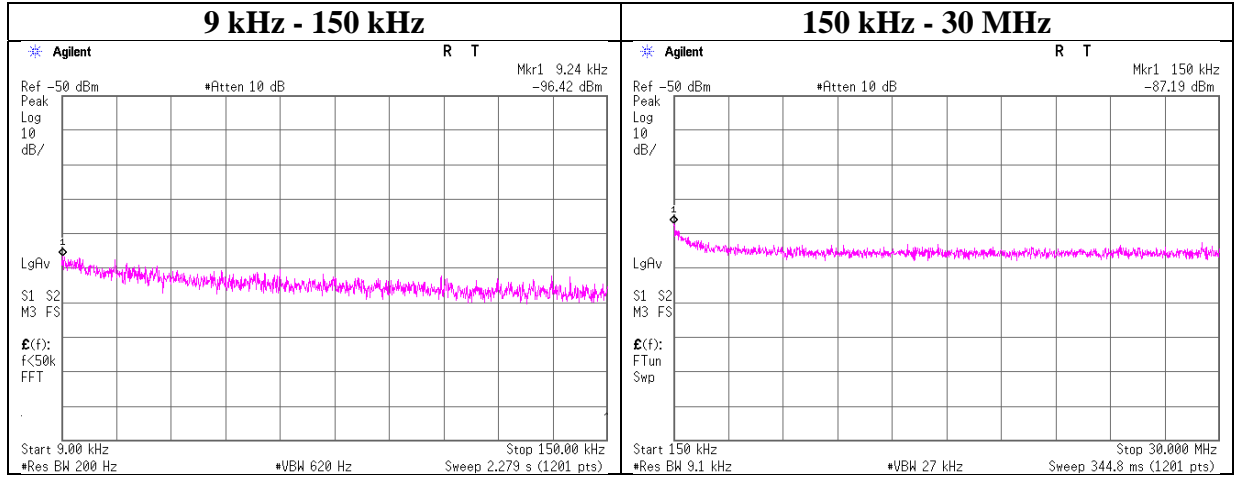

Frequency [kHz]	Reading [dBm]	Cable Loss [dB]	Attenuator Loss [dB]	Antenna Gain* [dBi]	N (Number of Output)	EIRP [dBm]	Distance [m]	Ground bounce [dB]	E (field strength) [dBuV/m]	Limit [dBuV/m]	Margin [dB]	Remark
9.24	-96.4	0.00	9.9	6.0	1	-80.6	300	6.0	-19.3	48.2	67.5	
150.00	-87.2	0.01	9.9	6.0	1	-71.3	300	6.0	-10.1	24.0	34.1	

$$E \text{ [dBuV/m]} = \text{EIRP [dBm]} - 20 \log (\text{Distance [m]}) + \text{Ground bounce [dB]} + 104.8 \text{ [dBuV/m]}$$

$$\text{EIRP [dBm]} = \text{Reading [dBm]} + \text{Cable loss [dB]} + \text{Attenuator Loss [dB]} + \text{Antenna gain [dBi]} + 10 * \log (N)$$

N: Number of output

**UL Japan, Inc.**

**Ise EMC Lab.**

4383-326 Asama-cho, Ise-shi, Mie-ken 516-0021 JAPAN

Telephone : +81 596 24 8999

Facsimile : +81 596 24 8124

## Power Density

Report No. 13226743H  
Test place Ise EMC Lab. No.6 Measurement Room  
Date June 30, 2020  
Temperature / Humidity 23 deg. C / 55 % RH  
Engineer Yuta Moriya  
Mode Tx

Freq.	Reading	Cable Loss	Atten. Loss	Result	Limit	Margin
[MHz]	[dBm]	[dB]	[dB]	[dBm]	[dBm]	[dB]
2403	-33.63	1.29	9.73	-22.61	8.00	30.61
2440	-34.08	1.30	9.73	-23.05	8.00	31.05
2480	-34.48	1.31	9.73	-23.44	8.00	31.44

Sample Calculation:

Result = Reading + Cable Loss + Attenuator Loss

\*The equipment and cables were not used for factor 0 dB of the data sheets.

## Power Density

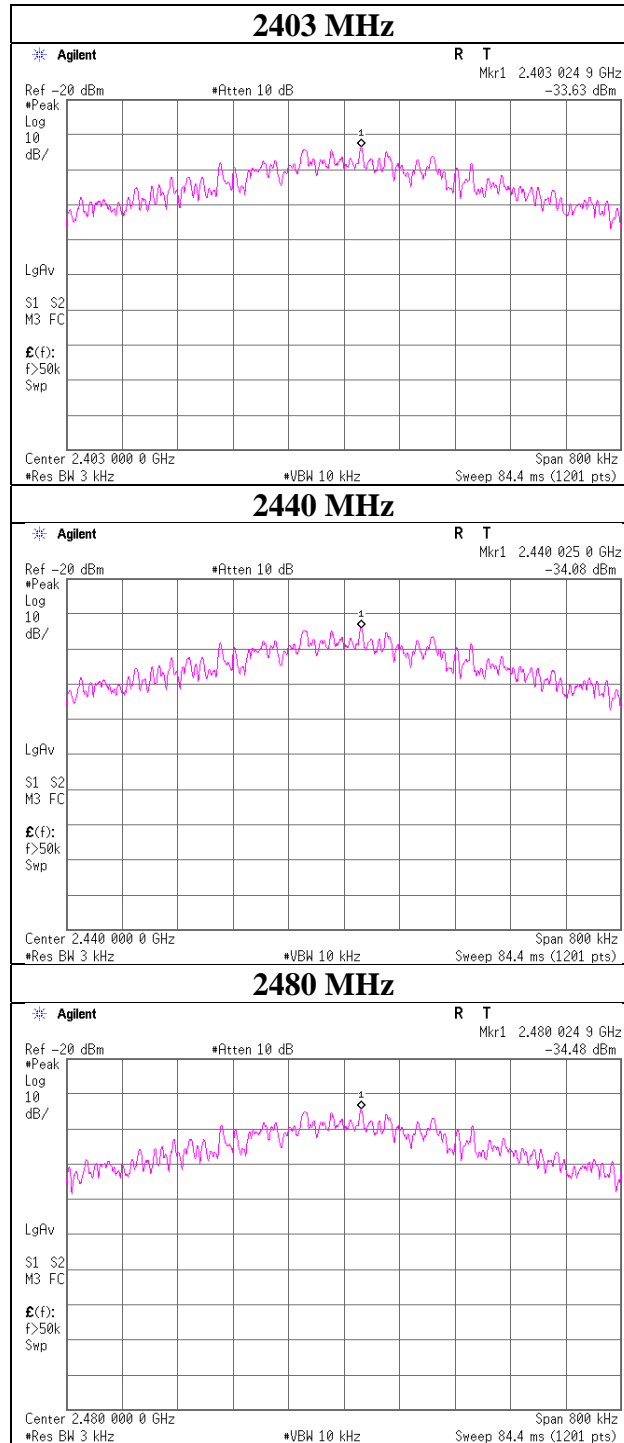

**UL Japan, Inc.**

**Ise EMC Lab.**

4383-326 Asama-cho, Ise-shi, Mie-ken 516-0021 JAPAN

Telephone : +81 596 24 8999

Facsimile : +81 596 24 8124

## APPENDIX 2: Test instruments

### Test equipment

Test Item	Local ID	LIMS ID	Description	Manufacturer	Model	Serial	Last Calibration Date	Cal Int
AT	MSA-04	141885	Spectrum Analyzer	Keysight Technologies Inc	E4448A	US44300523	2019/11/21	12
AT	MPM-01	141801	Power Meter	Keysight Technologies Inc	E4417A	GB41290639	2020/04/07	12
AT	MPSE-03	141837	Power sensor	Keysight Technologies Inc	E9327A	US40440576	2020/04/07	12
AT	MCC-177	141226	Microwave Cable	Junkosha	MMX221-00500DMSDMS	1502S304	2020/03/18	12
AT	MAT-92	141421	Attenuator	Weinschel Associates	WA56-10	56100308	2020/05/25	12
AT	MOS-14	141561	Thermo-Hygrometer	CUSTOM	CTH-201	1401	2020/01/07	12
AT	MAT-10	141156	Attenuator(10dB)	Weinschel Corp	2	BL1173	2019/11/07	12
RE	MSA-10	141899	Spectrum Analyzer	Keysight Technologies Inc	E4448A	MY46180655	2019/08/07	12
RE	MOS-13	141554	Thermo-Hygrometer	CUSTOM	CTH-201	1301	2020/01/07	12
RE	MMM-08	141532	DIGITAL HiTESTER	Hioki	3805	51201197	2020/01/06	12
RE	MJM-16	142183	Measure	KOMELON	KMC-36	-	-	-
RE	MAEC-03-SVSWR	142013	AC3_Semi Anechoic Chamber(SVSWR)	TDK	Semi Anechoic Chamber 3m	DA-10005	2019/04/08	24
RE	MHA-20	141507	Horn Antenna 1-18GHz	Schwarzbeck Mess - Elektronik	BBHA9120D	258	2019/09/26	12
RE	MPA-11	141580	MicroWave System Amplifier	Keysight Technologies Inc	83017A	MY39500779	2020/03/24	12
RE	MCC-231	177964	Microwave Cable	Junkosha INC.	MMX221	1901S329(1m)/1902S579(5m)	2020/03/02	12
RE	MHF-25	141232	High Pass Filter 3.5-18.0GHz	UL Japan	HPF SELECTOR	001	2019/09/11	12
RE	MHA-02	141503	Horn Antenna 18-26.5GHz	EMCO	3160-09	1265	2020/06/15	12
RE	MAT-95	142314	Attenuator	Pasternack	PE7390-6	D/C 1504	2020/06/17	12
RE	MBA-03	141424	Biconical Antenna	Schwarzbeck Mess - Elektronik	VHA9103+BBA9106	1915	2019/08/24	12
RE	MCC-51	141323	Coaxial cable	UL Japan	-	-	2020/07/06	12
RE	MLA-22	141266	Logperiodic Antenna(200-1000MHz)	Schwarzbeck Mess - Elektronik	VUSLP9111B	9111B-191	2019/08/24	12
RE	MPA-13	141582	Pre Amplifier	SONOMA INSTRUMENT	310	260834	2020/02/10	12
RE/CE	MTR-10	141951	EMI Test Receiver	Rohde & Schwarz	ESR26	101408	2020/03/10	12
RE/CE	MAEC-04	142011	AC4_Semi Anechoic Chamber(NSA)	TDK	Semi Anechoic Chamber 3m	DA-10005	2020/05/25	24
RE/CE	MOS-15	141562	Thermo-Hygrometer	CUSTOM	CTH-201	0010	2020/01/07	12
RE/CE	MMM-10	141545	DIGITAL HiTESTER	Hioki	3805	51201148	2020/01/06	12
RE/CE	MJM-26	142227	Measure	KOMELON	KMC-36	-	-	-
RE/CE	COTS-MEMI-02	178648	EMI measurement program	TSJ (Techno Science Japan)	TEPTO-DV	-	-	-
CE	MLS-23	141357	LISN(AMN)	Schwarzbeck Mess - Elektronik	NSLK8127	8127-729	2019/07/05	12
CE	MLS-24	141358	LISN(AMN)	Schwarzbeck Mess - Elektronik	NSLK8127	8127-730	2019/07/05	12
CE	MTA-52	141934	Terminator	TME	CT-01BP	-	2019/12/02	12
CE	MAT-67	141248	Attenuator	JFW Industries, Inc.	50FP-013H2 N	-	2019/12/02	12
CE	MCC-112	141216	Coaxial cable	Fujikura/Suhner/TSJ	5D-2W/SFM14/sucoform141-PE/421-010/RFM-E321(SW)	-/00640	2020/07/06	12
AT	MSA-14	141901	Spectrum Analyzer	Keysight Technologies Inc	E4440A	MY48250080	2019/10/06	12
AT	MAT-88	141312	Attenuator	Weinschel Associates	WA56-10	56100304	2020/05/27	12
AT	MCC-138	141410	Microwave cable	Huber+Suhner	SUCOFLEX 102	37953/2	2019/09/18	12

**UL Japan, Inc.**

**Ise EMC Lab.**

4383-326 Asama-cho, Ise-shi, Mie-ken 516-0021 JAPAN

Telephone : +81 596 24 8999

Facsimile : +81 596 24 8124

\*Hyphens for Last Calibration Date and Cal Int (month) are instruments that Calibration is not required (e.g. software), or instruments checked in advance before use.

The expiration date of the calibration is the end of the expired month.

As for some calibrations performed after the tested dates, those test equipment have been controlled by means of an unbroken chains of calibrations.

All equipment is calibrated with valid calibrations. Each measurement data is traceable to the national or international standards.

Test item:           CE: Conducted Emission test  
                      RE: Radiated Emission test  
                      AT: Antenna Terminal Conducted test