



RADIO TEST REPORT

Test Report No. 14178415H-A-R1

Customer	silex technology, Inc.
Description of EUT	Embedded Wireless Module
Model Number of EUT	SX-USBAC
FCC ID	N6C-USBAC
Test Regulation	FCC Part 15 Subpart C
Test Result	Complied (Refer to SECTION 3)
Issue Date	June 14, 2022
Remarks	* Wireless LAN (2.4 GHz band) and Bluetooth Low Energy part(s) * Maximum Peak Output Power and Radiated Spurious Emission tests only * For Permissive Change

Representative Test Engineer

Junki Nagatomi
Engineer

Approved By

Satofumi Matsuyama
Engineer



CERTIFICATE 5107.02

- The testing in which "Non-accreditation" is displayed is outside the accreditation scopes in UL Japan, Inc.
 There is no testing item of "Non-accreditation".

Report Cover Page - Form-ULID-003532 (DCS:13-EM-F0429) Issue# 20.0

ANNOUNCEMENT

- This test report shall not be reproduced in full or partial, without the written approval of UL Japan, Inc.
- The results in this report apply only to the sample tested.
- This sample tested is in compliance with the limits of the above regulation.
- The test results in this test report are traceable to the national or international standards.
- This test report must not be used by the customer to claim product certification, approval, or endorsement by the A2LA accreditation body.
- This test report covers Radio technical requirements.
It does not cover administrative issues such as Manual or non-Radio test related Requirements. (if applicable)
- The all test items in this test report are conducted by UL Japan, Inc Ise EMC Lab.
- The opinions and the interpretations to the result of the description in this report are outside scopes where UL Japan, Inc. has been accredited.
- The information provided from the applicant for this report is identified in Section 1.
- For test report(s) referred in this report, the latest version (including any revisions) is always referred.

REVISION HISTORY

Original Test Report No.: 14178415H-A

This report is a revised version of 14178415H-A. 14178415H-A is replaced with this report.

Revision	Test Report No.	Date	Page Revised Contents
- (Original)	14178415H-A	May 30, 2022	-
1	14178415H-A-R1	June 14, 2022	-Section2.2: Radio Specification Correction of Type of Modulation for WLAN 5 GHz band. DSSS, OFDM → OFDM
1	14178415H-A-R1	June 14, 2022	-Section 3.2: Procedures and Results Correction of FCC Part 15.203/212 Antenna requirement. The EUT has an external antenna connector, but it is installed by the professionals. → The EUT has a unique coupling/antenna connector (MHF).
1	14178415H-A-R1	June 14, 2022	-P21 Correction of 20dBc Date sheet. Result (Vert) of 2412 MHz: 108.3 → 106.7
1	14178415H-A-R1	June 14, 2022	-P22 Replacement of 20dBc Plot chart (Horizontal/Vertical).

Reference: Abbreviations (Including words undescribed in this report)

A2LA	The American Association for Laboratory Accreditation	ICES	Interference-Causing Equipment Standard
AC	Alternating Current	IEC	International Electrotechnical Commission
AFH	Adaptive Frequency Hopping	IEEE	Institute of Electrical and Electronics Engineers
AM	Amplitude Modulation	IF	Intermediate Frequency
Amp, AMP	Amplifier	ILAC	International Laboratory Accreditation Conference
ANSI	American National Standards Institute	ISED	Innovation, Science and Economic Development Canada
Ant, ANT	Antenna	ISO	International Organization for Standardization
AP	Access Point	JAB	Japan Accreditation Board
ASK	Amplitude Shift Keying	LAN	Local Area Network
Atten., ATT	Attenuator	LIMS	Laboratory Information Management System
AV	Average	MCS	Modulation and Coding Scheme
BPSK	Binary Phase-Shift Keying	MRA	Mutual Recognition Arrangement
BR	Bluetooth Basic Rate	N/A	Not Applicable
BT	Bluetooth	NIST	National Institute of Standards and Technology
BT LE	Bluetooth Low Energy	NS	No signal detect.
BW	BandWidth	NSA	Normalized Site Attenuation
Cal Int	Calibration Interval	NVLAP	National Voluntary Laboratory Accreditation Program
CCK	Complementary Code Keying	OBW	Occupied Band Width
Ch., CH	Channel	OFDM	Orthogonal Frequency Division Multiplexing
CISPR	Comite International Special des Perturbations Radioelectriques	P/M	Power meter
CW	Continuous Wave	PCB	Printed Circuit Board
DBPSK	Differential BPSK	PER	Packet Error Rate
DC	Direct Current	PHY	Physical Layer
D-factor	Distance factor	PK	Peak
DFS	Dynamic Frequency Selection	PN	Pseudo random Noise
DQPSK	Differential QPSK	PRBS	Pseudo-Random Bit Sequence
DSSS	Direct Sequence Spread Spectrum	PSD	Power Spectral Density
EDR	Enhanced Data Rate	QAM	Quadrature Amplitude Modulation
EIRP, e.i.r.p.	Equivalent Isotropically Radiated Power	QP	Quasi-Peak
EMC	ElectroMagnetic Compatibility	QPSK	Quadri-Phase Shift Keying
EMI	ElectroMagnetic Interference	RBW	Resolution Band Width
EN	European Norm	RDS	Radio Data System
ERP, e.r.p.	Effective Radiated Power	RE	Radio Equipment
EU	European Union	RF	Radio Frequency
EUT	Equipment Under Test	RMS	Root Mean Square
Fac.	Factor	RSS	Radio Standards Specifications
FCC	Federal Communications Commission	Rx	Receiving
FHSS	Frequency Hopping Spread Spectrum	SA, S/A	Spectrum Analyzer
FM	Frequency Modulation	SG	Signal Generator
Freq.	Frequency	SVSWR	Site-Voltage Standing Wave Ratio
FSK	Frequency Shift Keying	TR	Test Receiver
GFSK	Gaussian Frequency-Shift Keying	Tx	Transmitting
GNSS	Global Navigation Satellite System	VBW	Video BandWidth
GPS	Global Positioning System	Vert.	Vertical
Hori.	Horizontal	WLAN	Wireless LAN

CONTENTS	PAGE
SECTION 1: Customer Information	5
SECTION 2: Equipment Under Test (EUT).....	5
SECTION 3: Test Specification, Procedures & Results.....	7
SECTION 4: Operation of EUT during testing	10
SECTION 6: Radiated Spurious Emission	13
SECTION 7: Antenna Terminal Conducted Tests.....	15
APPENDIX 1: Test Data.....	16
Maximum Peak Output Power	16
Average Output Power	17
Radiated Spurious Emission	21
APPENDIX 2: Test Instruments.....	64
APPENDIX 3: Photographs of Test Setup	66
Radiated Spurious Emission	66
Worst Case Position (Horizontal: X-axis/ Vertical:Y-axis).....	67

SECTION 1: Customer Information

Company Name	silex technology, Inc.
Address	2-3-1 Hikaridai, Seika-cho, Soraku-gun, Kyoto 619-0237, Japan
Telephone Number	+81-774-98-3878
Contact Person	Yoshinori Nakai

The information provided from the customer is as follows;

- Customer, Description of EUT, Model Number of EUT, FCC ID on the cover and other relevant pages
 - Operating/Test Mode(s) (Mode(s)) on all the relevant pages
 - SECTION 1: Customer Information
 - SECTION 2: Equipment Under Test (EUT) other than the Receipt Date and Test Date
 - SECTION 4: Operation of EUT during testing
- * The laboratory is exempted from liability of any test results affected from the above information in SECTION 2 and 4.

SECTION 2: Equipment Under Test (EUT)

2.1 Identification of EUT

Description	Embedded Wireless Module
Model Number	SX-USBAC
Serial Number	Refer to SECTION 4.2
Condition	Production model
Modification	No Modification by the test lab
Receipt Date	January 25, 2022
Test Date	January 25 to April 19, 2022

2.2 Product Description

General Specification

Rating	Typ: DC 3.3 V (Min: DC 3.14 V to Max: DC 3.46 V)
--------	--

Radio Specification

WLAN (IEEE802.11b/11g/11n-20/11n-40) *1)

Equipment Type	Transceiver	
Frequency of Operation	20 MHz Band:	2412 MHz to 2462 MHz
	40 MHz Band:	2422 MHz to 2452 MHz
Type of Modulation	DSSS, OFDM	
Antenna Type	PCB antenna	
Antenna Gain:	3.25 dBi	

Bluetooth (BR / EDR / Low Energy) *1)

Equipment Type	Transceiver	
Frequency of Operation	2402 MHz to 2480 MHz	
Type of Modulation	BT: FHSS (GFSK, $\pi/4$ DQPSK, 8 DPSK) BT LE: GFSK	
Antenna Type	PCB antenna	
Antenna Gain	3.25 dBi	

WLAN (IEEE802.11a/11n-20/11ac-20/11n-40/11ac-40/11ac-80)

Equipment Type	Transceiver	
Frequency of Operation	20 MHz Band:	5180 MHz to 5240 MHz 5260 MHz to 5320 MHz 5500 MHz to 5720 MHz 5745 MHz to 5825 MHz
	40 MHz Band:	5190 MHz to 5230 MHz 5270 MHz to 5310 MHz 5510 MHz to 5710 MHz 5755 MHz to 5795 MHz
	80 MHz Band:	5210 MHz 5290 MHz 5530 MHz to 5690 MHz 5775 MHz
Type of Modulation	OFDM	
Antenna Type	PCB antenna	
Antenna Gain:	5.0 dBi	

*1) This test report applies to WLAN and Bluetooth (Low Energy) parts.

SECTION 3: Test Specification, Procedures & Results

3.1 Test Specification

Test Specification	FCC Part 15 Subpart C FCC Part 15 final revised on April 1, 2022 and effective May 2, 2022
Title	FCC 47 CFR Part 15 Radio Frequency Device Subpart C Intentional Radiators Section 15.207 Conducted limits Section 15.247 Operation within the bands 902-928 MHz, 2400-2483.5 MHz, and 5725-5850 MHz

* The revision does not affect the test result conducted before its effective date.

3.2 Procedures and Results

Item	Test Procedure	Specification	Worst Margin	Results	Remarks
Maximum Peak Output Power	FCC: KDB 558074 D01 15.247 Meas Guidance v05r02 ISED: RSS-Gen 6.12	FCC: Section 15.247(b)(3) ----- ISED: RSS-247 5.4(d)	See data	Complied a)	Conducted
Spurious Emission Restricted Band Edges	FCC: KDB 558074 D01 15.247 Meas Guidance v05r02 ISED: RSS-Gen 6.13	FCC: Section 15.247(d) ----- ISED: RSS-247 5.5 RSS-Gen 8.9 RSS-Gen 8.10	0.2 dB 2390.0 MHz, AV, Vert./ 2483.5 MHz, AV, Vert.	Complied# b)	Radiated (above 30 MHz) *1)

Note: UL Japan, Inc.'s EMI Work Procedures: Work Instructions-ULID-003591 and Work Instructions-ULID-003593.

* In case any questions arise about test procedure, ANSI C63.10: 2013 is also referred.

*1) Radiated test was selected over 30 MHz based on section 15.247(d) and KDB 558074 D01 15.247 Meas Guidance v05r02 8.5 and 8.6.

a) Refer to APPENDIX 1 (data of Maximum Peak Output Power)

b) Refer to APPENDIX 1 (data of Radiated Spurious Emission)

Symbols:

Complied The data of this test item has enough margin, more than the measurement uncertainty.

Complied# The data of this test item meets the limits unless the measurement uncertainty is taken into consideration

FCC Part 15.31 (e)

This EUT provides stable voltage constantly to RF Module regardless of input voltage.

Therefore, this EUT complies with the requirement.

FCC Part 15.203/212 Antenna requirement

The EUT has a unique coupling/antenna connector (MHF).

Therefore, the equipment complies with the antenna requirement of Section 15.203.

3.3 Addition to Standard

No addition, exclusion nor deviation has been made from the standard.

3.4 Uncertainty

There is no applicable rule of uncertainty in this applied standard. Therefore, the results are derived depending on whether or not laboratory uncertainty is applied.

The following uncertainties have been calculated to provide a confidence level of 95 % using a coverage factor $k=2$.

Radiated emission

Measurement distance	Frequency range		Uncertainty (+/-)
3 m	9 kHz to 30 MHz		3.2 dB
10 m			3.0 dB
3 m	30 MHz to 200 MHz	Horizontal	4.8 dB
		Vertical	5.0 dB
	200 MHz to 1000 MHz	Horizontal	5.1 dB
		Vertical	6.2 dB
10 m	30 MHz to 200 MHz	Horizontal	4.8 dB
		Vertical	4.8 dB
	200 MHz to 1000 MHz	Horizontal	5.0 dB
		Vertical	5.0 dB
3 m	1 GHz to 6 GHz		4.9 dB
	6 GHz to 18 GHz		5.2 dB
1 m	10 GHz to 26.5 GHz		5.4 dB
	26.5 GHz to 40 GHz		5.4 dB
10 m	1 GHz to 18 GHz		5.4 dB

Antenna Terminal test

Test Item	Uncertainty (+/-)
20 dB Bandwidth / 99 % Occupied Bandwidth	0.96 %
Maximum Peak Output Power / Average Output Power	1.5 dB
Carrier Frequency Separation	0.42 %
Dwell time / Burst rate	0.10 %
Conducted Spurious Emission	2.7 dB

3.5 Test Location

UL Japan, Inc. Ise EMC Lab.

*A2LA Certificate Number: 5107.02 / FCC Test Firm Registration Number: 884919

ISED Lab Company Number: 2973C / CAB identifier: JP0002

4383-326 Asama-cho, Ise-shi, Mie-ken 516-0021 Japan

Telephone: +81-596-24-8999

Test site	Width x Depth x Height (m)	Size of reference ground plane (m) / horizontal conducting plane	Other rooms	Maximum measurement distance
No.1 semi-anechoic chamber	19.2 x 11.2 x 7.7	7.0 x 6.0	No.1 Power source room	10 m
No.2 semi-anechoic chamber	7.5 x 5.8 x 5.2	4.0 x 4.0	-	3 m
No.3 semi-anechoic chamber	12.0 x 8.5 x 5.9	6.8 x 5.75	No.3 Preparation room	3 m
No.3 shielded room	4.0 x 6.0 x 2.7	N/A	-	-
No.4 semi-anechoic chamber	12.0 x 8.5 x 5.9	6.8 x 5.75	No.4 Preparation room	3 m
No.4 shielded room	4.0 x 6.0 x 2.7	N/A	-	-
No.5 semi-anechoic chamber	6.0 x 6.0 x 3.9	6.0 x 6.0	-	-
No.5 measurement room	6.4 x 6.4 x 3.0	6.4 x 6.4	-	-
No.6 shielded room	4.0 x 4.5 x 2.7	4.0 x 4.5	-	-
No.6 measurement room	4.75 x 5.4 x 3.0	4.75 x 4.15	-	-
No.7 shielded room	4.7 x 7.5 x 2.7	4.7 x 7.5	-	-
No.8 measurement room	3.1 x 5.0 x 2.7	3.1 x 5.0	-	-
No.9 measurement room	8.8 x 4.6 x 2.8	2.4 x 2.4	-	-
No.10 shielded room	3.8 x 2.8 x 2.8	3.8 x 2.8	-	-
No.11 measurement room	4.0 x 3.4 x 2.5	N/A	-	-
No.12 measurement room	2.6 x 3.4 x 2.5	N/A	-	-
Large Chamber	16.9 x 22.1 x 10.17	16.9 x 22.1	-	10 m
Small Chamber	5.3 x 6.69 x 3.59	5.3 x 6.69	-	-

3.6 Test Data, Test Instruments, and Test Set Up

Refer to APPENDIX.

SECTION 4: Operation of EUT during testing

4.1 Operating Mode(s)

[WLAN]

Test operating mode was determined as follows according to “Section 1 of 6 802.11 a/b/g/n testing - Managing Complex Regulatory Approvals - ” of TCB Council Workshop October 2009.

Mode	Remarks*
IEEE 802.11b (11b)	1 Mbps, PN9
IEEE 802.11g (11g)	48 Mbps, PN9
IEEE 802.11n 20MHz BW (11n-20)	MCS 4, PN9
IEEE 802.11n 40MHz BW (11n-40)	MCS 3, PN9
*The worst condition was determined based on the test result of Maximum Peak Output Power (Mid Channel)	
*Power of the EUT was set by the software as follows; Power settings: Refer to the following table Software: QRCT Ver 4.0.00132.0 (Date: May 21, 2019, Storage location: Driven by connected PC)	
*This setting of software is the worst case. Any conditions under the normal use do not exceed the condition of setting. In addition, end users cannot change the settings of the output power of the product.	

[Power setting: WLAN]

	Rate	Ch	Frequency	Power Setting [dBm]
11b	1 Mbps	1	2412 MHz	16.0
		2	2417 MHz	16.5
		6	2437 MHz	16.5
		10	2457 MHz	16.5
		11	2462 MHz	16.5
11g	48 Mbps	1	2412 MHz	14.5
		2	2417 MHz	15.5
		6	2437 MHz	15.5
		10	2457 MHz	15.5
		11	2462 MHz	13.5
11n20	MCS 4	1	2412 MHz	14.0
		2	2417 MHz	16.0
		6	2437 MHz	16.0
		10	2457 MHz	16.0
		11	2462 MHz	13.5
11n40	MCS 3	3	2422 MHz	11.0
		4	2432 MHz	11.5
		5	2447 MHz	12.5
		8	2437 MHz	12.5
		9	2452 MHz	11.5

*Details of Operating mode for WLAN

Test Item	Operating Mode	Tested frequency
Radiated Spurious Emission (Below 1 GHz)	11n-20 Tx *1)	2437 MHz
Radiated Spurious Emission (Above 1 GHz)	11b Tx 11n-20 Tx	2412 MHz 2417 MHz 2437 MHz 2457 MHz 2462 MHz
	11g Tx	2412 MHz 2417 MHz 2457 MHz 2462 MHz
	11n-40 Tx	2422 MHz 2427 MHz 2432 MHz 2437 MHz 2447 MHz 2452 MHz
Maximum Peak Output Power	11b Tx *2)	2462 MHz
<p>*1) The mode was tested as a representative, because it had the highest power at antenna terminal test. *2) Since only this mode has a change in the power setting value from the original report, the test was performed again.</p>		

[BLE]

Mode	Remarks*
Bluetooth Low Energy (BLE) 1M-PHY Uncoded PHY (1M-PHY)	Maximum Packet Size, PRBS9
<p>*Power of the EUT was set by the software as follows; Power settings: power level 8 Software: QRCT Ver 4.0.00132.0 (Date: May 21, 2019, Storage location: Driven by connected PC)</p> <p>*This setting of software is the worst case. Any conditions under the normal use do not exceed the condition of setting. In addition, end users cannot change the settings of the output power of the product.</p>	

*The Details of Operating Mode(s)

Test Item	Operating Mode	Tested frequency
Radiated Spurious Emission (Below 1 GHz)	Tx BLE, 1M-PHY	2480 MHz
Radiated Spurious Emission	Tx BLE, 1M-PHY	2402 MHz
		2440 MHz
		2480 MHz

4.2 Configuration and Peripherals

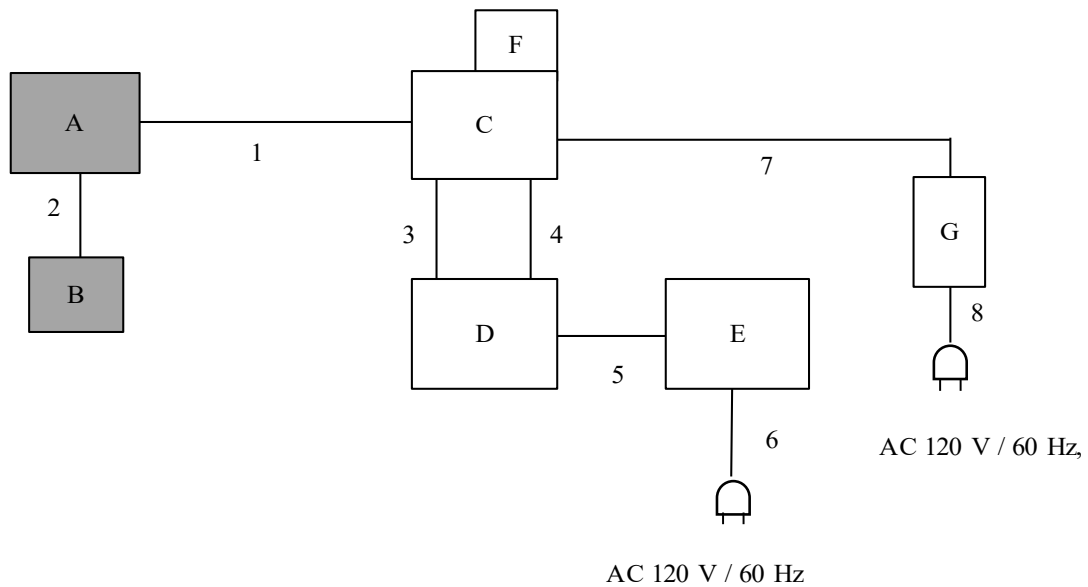

* Cabling and setup(s) were taken into consideration and test data was taken under worse case conditions.

Description of EUT and Support Equipment

No.	Item	Model number	Serial Number	Manufacturer	Remarks
A	Module	SX-USBAC	BB4BC2	silex technology, Inc.	EUT
B	PCB Antenna	146153	-	Molex	EUT
C	Jig board	MCIMX6SX-SDB	SX07042	NXP	-
D	Laptop PC	Latitude 5590	HSLHST2	DELL	-
E	AC adaptor	LA90PM130	CN-50GT3K-LOC00-8AF-4EB6-A02	DELL	-
F	SD card	SDSDUN-008G-J01	SX05150	SanDisk	-
G	AC Adaptor	ATS036T-A050	SX04648	Sceptre	-

List of Cables Used

No.	Name	Length (m)	Shield		Remarks
			Cable	Connector	
1	USB Cable	1.8	Shielded	Shielded	-
2	Antenna Cable	0.1	Shielded	Shielded	-
3	LAN Cable	3.0	Unshielded	Unshielded	-
4	USB Cable	0.9	Shielded	Shielded	-
5	DC Cable	1.8	Unshielded	Unshielded	-
6	AC Cable	0.9	Unshielded	Unshielded	-
7	DC Cable	1.0	Unshielded	Unshielded	-
8	AC Cable	1.8	Unshielded	Unshielded	-

SECTION 5: Radiated Spurious Emission

Test Procedure

It was measured based on "8.5 and 8.6 of KDB 558074 D01 15.247 Meas Guidance v05r02".

[For below 1 GHz]

EUT was placed on a urethane platform of nominal size, 0.5 m by 1.0 m, raised 0.8 m above the conducting ground plane. The Radiated Electric Field Strength has been measured in a Semi Anechoic Chamber with a ground plane.

[For above 1 GHz]

EUT was placed on a urethane platform of nominal size, 0.5 m by 0.5 m, raised 1.5 m above the conducting ground plane. The Radiated Electric Field Strength has been measured in a Semi Anechoic Chamber with absorbent materials lined on a ground plane.

The height of the measuring antenna varied between 1 m and 4 m and EUT was rotated a full revolution in order to obtain the maximum value of the electric field strength.

Test antenna was aimed at the EUT for receiving the maximum signal and always kept within the illumination area of the 3 dB beamwidth of the antenna.

The measurements were performed for both vertical and horizontal antenna polarization with the Test Receiver, or the Spectrum Analyzer.

The measurements were made with the following detector function of the test receiver and the Spectrum analyzer (in linear mode).

The test was made with the detector (RBW/VBW) in the following table.

When using Spectrum analyzer, the test was made with adjusting span to zero by using peak hold.

Test Antennas are used as below;

Frequency	30 MHz to 200 MHz	200 MHz to 1 GHz	Above 1 GHz
Antenna Type	Biconical	Logperiodic	Horn

In any 100 kHz bandwidth outside the restricted band in which the spread spectrum intentional radiator is operating, the radio frequency power that is produced by the intentional radiator confirmed 20 dB below that in the 100 kHz bandwidth within the band that contains the highest level of the desired power, based on a radiated measurement.

20 dBc was applied to the frequency over the limit of FCC 15.209 / Table 4 of RSS-Gen 8.9(ISED) and outside the restricted band of FCC15.205 / Table 6 of RSS-Gen 8.10 (ISED).

Frequency	Below 1 GHz	Above 1 GHz		20 dBc
Instrument Used	Test Receiver	Spectrum Analyzer		Spectrum Analyzer
Detector	QP	PK	AV	PK
IF Bandwidth	BW 120 kHz	RBW: 1 MHz VBW: 3 MHz	<u>11.12.2.5.1(BT LE)</u> RBW: 1 MHz VBW: 3 MHz Detector: Power Averaging (RMS) Trace: 100 traces <u>11.12.2.5.2 (BT LE)</u> The duty cycle was less than 98% for detected noise, a duty factor was added to the 11.12.2.5.1 results. <u>11.12.2.5.3(WLAN 2.4GHz)</u> RBW: 1 MHz VBW: 1/T Detector: Power Averaging (RMS)	RBW: 100 kHz VBW: 300 kHz

Figure 2: Test Setup

Below 1 GHz

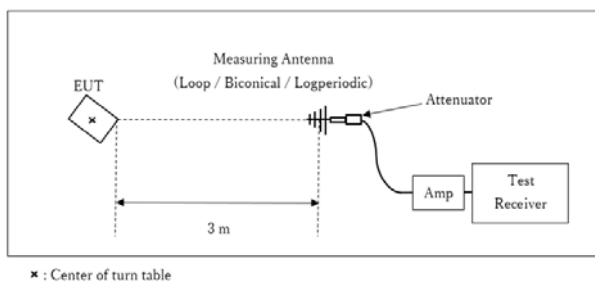

Test Distance: 3 m

1 GHz to 10 GHz

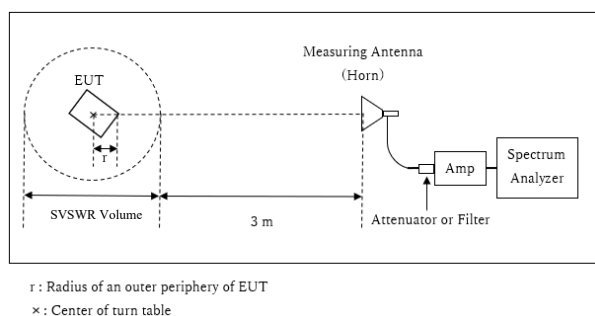

Distance Factor: $20 \times \log (3.95 \text{ m} / 3.0 \text{ m}) = 2.39 \text{ dB}$
* Test Distance: $(3 + \text{SVSWR Volume} / 2) - r = 3.95 \text{ m}$

SVSWR Volume : 2.0 m
(SVSWR Volume has been calibrated based on CISPR 16-1-4.)
 $r = 0.05 \text{ m}$

10 GHz to 26.5 GHz

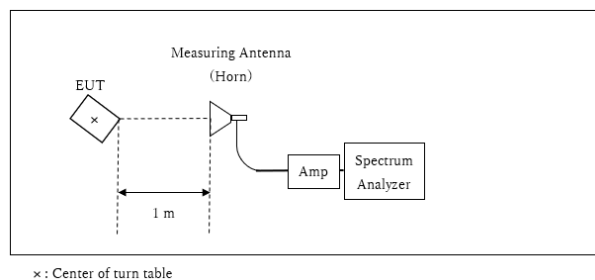

Distance Factor: $20 \times \log (1.0 \text{ m} / 3.0 \text{ m}) = -9.5 \text{ dB}$
*Test Distance: 1 m

- The carrier level and noise levels were confirmed at each position of X, Y and Z axes of EUT to see the position of maximum noise, and the test was made at the position that has the maximum noise.

The test results and limit are rounded off to one decimal place, so some differences might be observed.

Measurement Range : 30 MHz to 26.5 GHz
Test Data : APPENDIX
Test Result : Pass

SECTION 6: Antenna Terminal Conducted Tests

Test Procedure

The tests were made with below setting connected to the antenna port.

Test	Span	RBW	VBW	Sweep time	Detector	Trace	Instrument Used
Maximum Peak Output Power	-	-	-	Auto	Peak/ Average *1)	-	Power Meter (Sensor: 50 MHz BW)
*1) Reference data							

The test results and limit are rounded off to two decimals place, so some differences might be observed.
The equipment and cables were not used for factor 0 dB of the data sheets.

Test Data : **APPENDIX**
Test Result : **Pass**

APPENDIX 1: Test Data

Maximum Peak Output Power

Test place Ise EMC Lab. No.6 Measurement Room
 Date April 6, 2022
 Temperature / Humidity 23 deg. C / 39 % RH
 Engineer Hiroki Numata
 Mode Tx 11b

Freq.	Reading	Cable Loss	Atten. Loss	Conducted Power					e.i.r.p. for RSS-247					
				Result		Limit		Margin	Antenna Gain	Result		Limit		Margin
				[dBm]	[mW]	[dBm]	[mW]	[dB]		[dBi]	[dBm]	[mW]	[dBm]	[mW]
2462	0.48	0.64	19.89	21.01	126.18	30.00	1000	8.99	3.25	24.26	266.69	36.02	4000	11.76

Sample Calculation:

Result = Reading + Cable Loss (including the cable(s) customer supplied) + Attenuator Loss

e.i.r.p. Result = Conducted Power Result + Antenna Gain

*The equipment and cables were not used for factor 0 dB of the data sheets.

Average Output Power
(Reference data for RF Exposure / SAR testing)

Test place Ise EMC Lab. No.6 Measurement Room
Date April 6, 2022
Temperature / Humidity 23 deg. C / 39 % RH
Engineer Hiroki Numata
Mode Tx

11b **1 Mbps**

Freq. [MHz]	Reading [dBm]	Cable Loss [dB]	Atten. Loss [dB]	Result (Time average)		Duty factor [dB]	Result (Burst power average)	
				[dBm]	[mW]		[dBm]	[mW]
2462	-2.18	0.64	19.89	18.35	68.39	0.04	18.39	69.02

Sample Calculation:

Result (Time average) = Reading + Cable Loss (including the cable(s) customer supplied) + Attenuator Loss

Result (Burst power average) = Time average + Duty factor

The average output power was measured with the lowest order modulation and lowest data rate configuration in each IEEE 802.11 mode based on KDB 248227 D01.

Burst rate confirmation

Test place	Ise EMC Lab. No.3 Semi Anechoic Chamber
Date	March 25, 2022
Temperature / Humidity	21 deg. C / 37 % RH
Engineer	Takafumi Noguchi
Mode	Tx

11b 1 Mbps

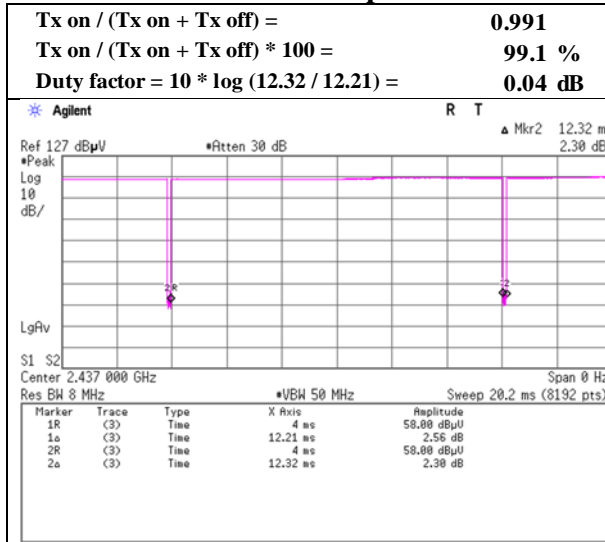

11g 48 Mbps

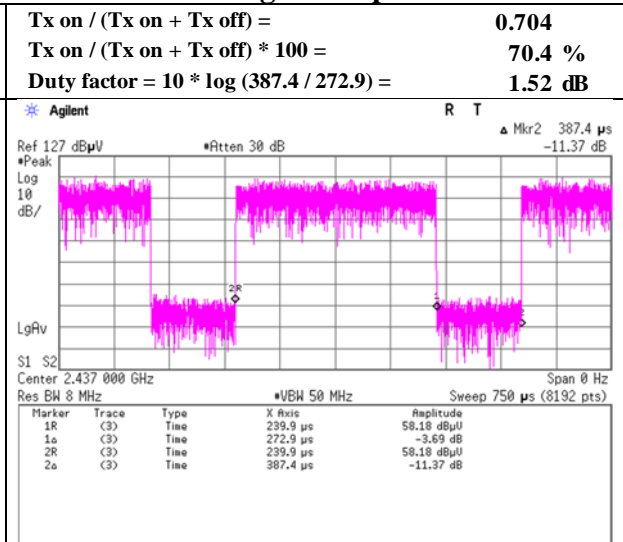

11n-20 MCS 4

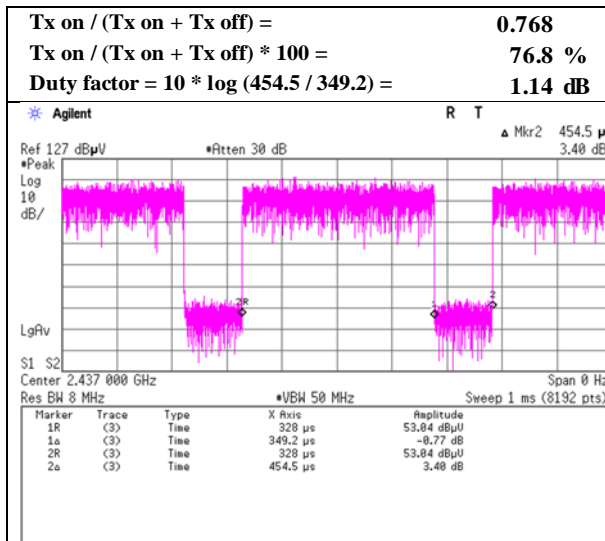

11n-40 MCS 3

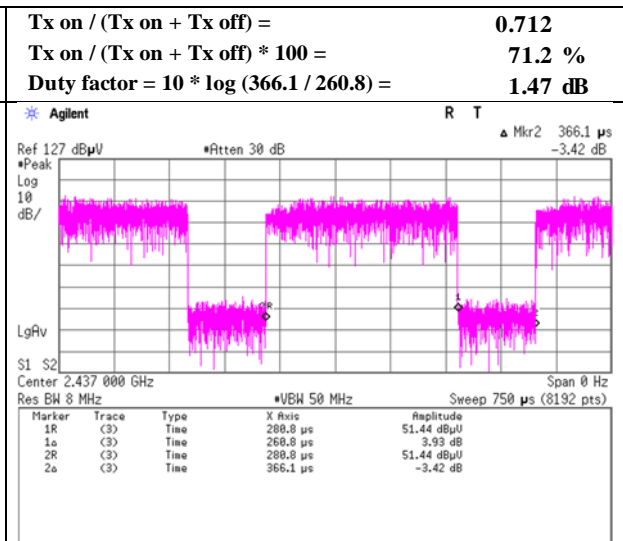

* Since the burst rate is not different between the channels, the data has been obtained on the representative channel.

Burst rate confirmation

Test place Ise EMC Lab. No.3 Semi Anechoic Chamber
 Date March 25, 2022
 Temperature / Humidity 21 deg. C / 37 % RH
 Engineer Takafumi Noguchi
 Mode Tx

11g 6 Mbps

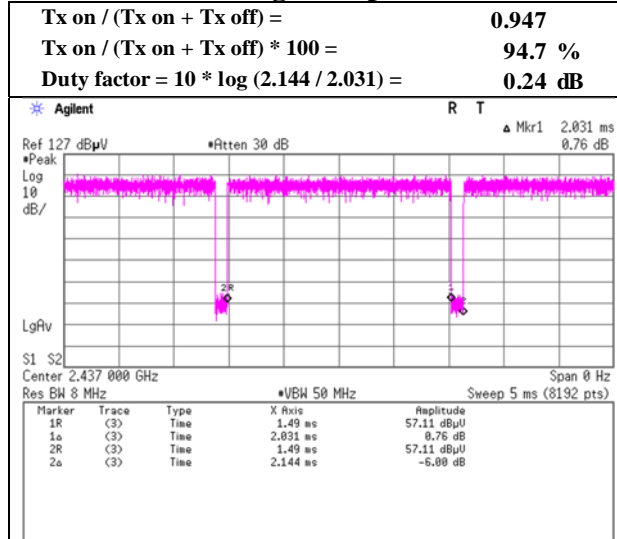

11n-20 MCS 0

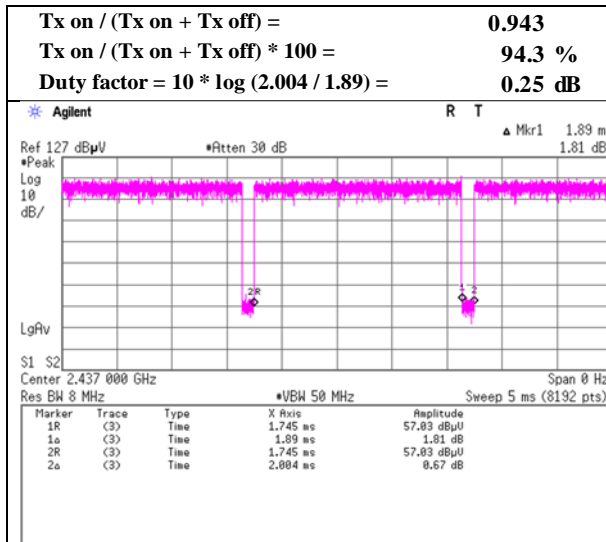

11n-40 MCS 0

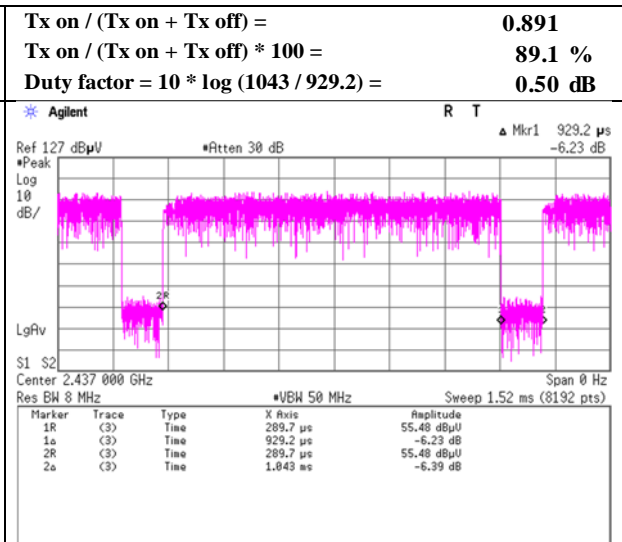

* Since the burst rate is not different between the channels, the data has been obtained on the representative channel.

Burst rate confirmation

Test place	Ise EMC Lab. No.4 Semi Anechoic Chamber
Date	January 25, 2022
Temperature / Humidity	19 deg. C / 30 % RH
Engineer	Junki Nagatomi
Mode	Tx

BT LE

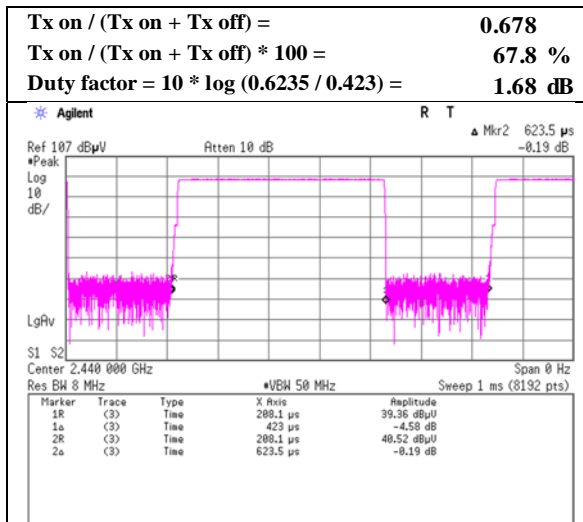

* Since the burst rate is not different between the channels, the data has been obtained on the representative channel.

Radiated Spurious Emission

Test place	Ise EMC Lab.	
Semi Anechoic Chamber	No.3	No.4
Date	March 24, 2022	April 14, 2022
Temperature / Humidity	21 deg. C / 37 % RH	21 deg. C / 59 % RH
Engineer	Takafumi Noguchi	Nachi Konegawa
	(1 GHz - 10 GHz)	(Above 10 GHz)
Mode	Tx 11b 2412 MHz	

Polarity	Frequency	Reading (QP / PK)	Reading (AV)	Ant. Factor	Loss	Gain	Duty Factor	Result (QP / PK)	Result (AV)	Limit (QP / PK)	Limit (AV)	Margin (QP / PK)	Margin (AV)	Remark
[Hori/Vert]	[MHz]	[dBuV]	[dBuV]	[dB/m]	[dB]	[dB]	[dB]	[dBuV/m]	[dBuV/m]	[dBuV/m]	[dBuV/m]	[dB]	[dB]	
Hori.	2390.0	58.7	46.5	27.6	5.7	32.9	-	59.0	46.8	73.9	53.9	14.9	7.1	
Hori.	4824.0	47.3	43.7	31.5	8.0	32.0	-	54.9	51.3	73.9	53.9	19.0	2.6	
Hori.	7236.0	41.5	29.4	35.8	9.6	32.8	-	54.0	42.0	73.9	53.9	19.9	11.9	Floor noise
Hori.	9648.0	41.2	29.7	38.8	10.2	33.5	-	56.7	45.2	73.9	53.9	17.2	8.7	Floor noise
Vert.	2390.0	58.9	47.5	27.6	5.7	32.9	-	59.2	47.9	73.9	53.9	14.7	6.1	
Vert.	4824.0	47.0	43.5	31.5	8.0	32.0	-	54.6	51.1	73.9	53.9	19.3	2.8	
Vert.	7236.0	41.5	30.1	35.8	9.6	32.8	-	54.1	42.7	73.9	53.9	19.8	11.2	Floor noise
Vert.	9648.0	41.1	29.6	38.8	10.2	33.5	-	56.5	45.1	73.9	53.9	17.4	8.8	Floor noise

Result = Reading + Ant Factor + Loss (Cable+Attenuator+Filter+Distance factor(above 1 GHz)) - Gain(Amplifier)

*Other frequency noises omitted in this report were not seen or had enough margin (more than 20 dB).

*QP detector was used up to 1GHz.

20dBc Data Sheet

Polarity	Frequency	Reading (PK)	Ant Factor	Loss	Gain	Result	Limit	Margin	Remark
[Hori/Vert]	[MHz]	[dBuV]	[dB/m]	[dB]	[dB]	[dBuV/m]	[dBuV/m]	[dB]	
Hori.	2412.0	106.7	27.5	5.7	32.9	107.0	-	-	Carrier
Hori.	2400.0	50.7	27.5	5.7	32.9	51.0	87.0	36.0	
Vert.	2412.0	106.4	27.5	5.7	32.9	106.7	-	-	Carrier
Vert.	2400.0	50.3	27.5	5.7	32.9	50.6	86.7	36.2	

Result = Reading + Ant Factor + Loss (Cable+Attenuator+Filter+Distance factor(above 1 GHz)) - Gain(Amplifier)

Distance factor:
 1 GHz - 10 GHz $20\log(3.95\text{ m} / 3.0\text{ m}) = 2.39\text{ dB}$
 10 GHz - 26.5 GHz $20\log(1.0\text{ m} / 3.0\text{ m}) = -9.5\text{ dB}$

Radiated Spurious Emission (Reference Plot for band-edge)

Test place	Ise EMC Lab.
Semi Anechoic Chamber	No.3
Date	March 24, 2022
Temperature / Humidity	21 deg. C / 37 % RH
Engineer	Takafumi Noguchi
	(1 GHz - 10 GHz)
Mode	Tx 11b 2412 MHz

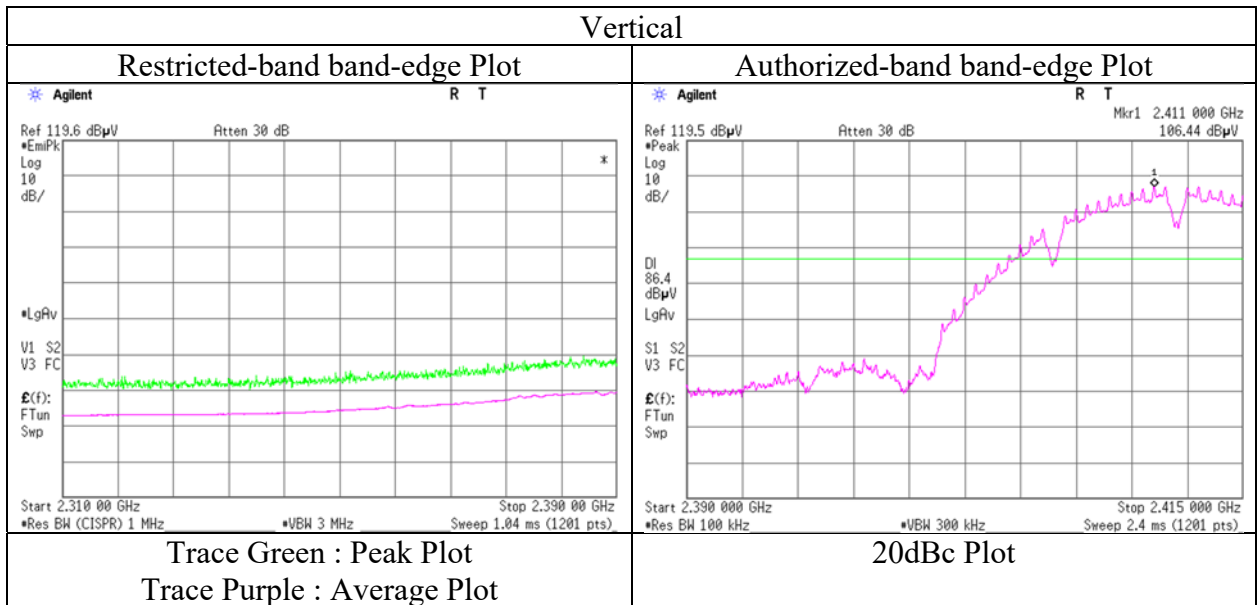
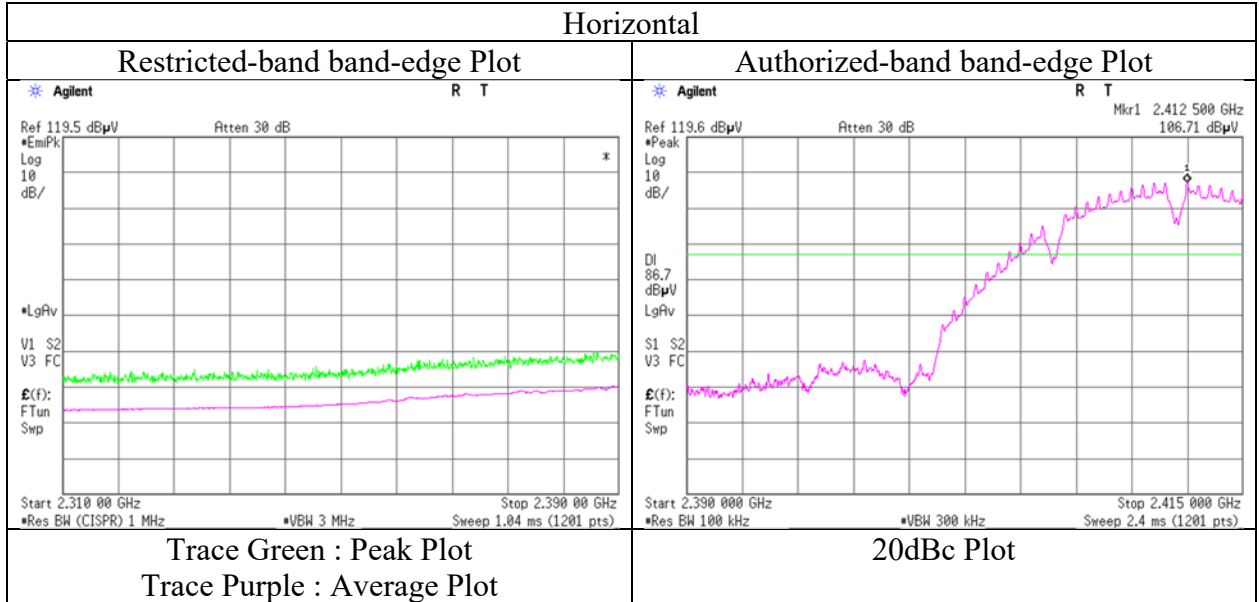

* The measurement was conducted for a sufficiently long enough time to detect any possible spurious emissions. Final result of restricted band edge was shown in tabular data.

Radiated Spurious Emission

Test place	Ise EMC Lab.
Semi Anechoic Chamber	No.3
Date	March 25, 2022
Temperature / Humidity	20 deg. C / 32 % RH
Engineer	Nachi Konegawa (1 GHz - 10 GHz)
Mode	Tx 11b 2417 MHz

Polarity	Frequency	Reading (QP / PK)	Reading (AV)	Ant. Factor	Loss	Gain	Duty Factor	Result (QP / PK)	Result (AV)	Limit (QP / PK)	Limit (AV)	Margin (QP / PK)	Margin (AV)	Remark
[Hori/Vert]	[MHz]	[dBuV]	[dBuV]	[dB/m]	[dB]	[dB]	[dB]	[dBuV/m]	[dBuV/m]	[dBuV/m]	[dBuV/m]	[dB]	[dB]	
Hori.	2390.0	58.1	48.9	27.6	5.7	32.9	-	58.5	49.3	73.9	53.9	15.4	4.6	
Vert.	2390.0	59.1	50.2	27.6	5.7	32.9	-	59.4	50.5	73.9	53.9	14.5	3.4	

Result = Reading + Ant Factor + Loss (Cable+Attenuator+Filter+Distance factor(above 1 GHz)) - Gain(Amplifier)

*Other frequency noises omitted in this report were not seen or had enough margin (more than 20 dB).

*QP detector was used up to 1GHz.

Distance factor:	1 GHz - 10 GHz	$20\log(3.95\text{ m} / 3.0\text{ m}) = 2.39\text{ dB}$
	10 GHz - 26.5 GHz	$20\log(1.0\text{ m} / 3.0\text{ m}) = -9.5\text{ dB}$

Radiated Spurious Emission (Reference Plot for band-edge)

Test place Ise EMC Lab.
Semi Anechoic Chamber No.3
Date March 25, 2022
Temperature / Humidity 20 deg. C / 32 % RH
Engineer Nachi Konegawa
 (1 GHz - 10 GHz)
Mode Tx 11b 2417 MHz

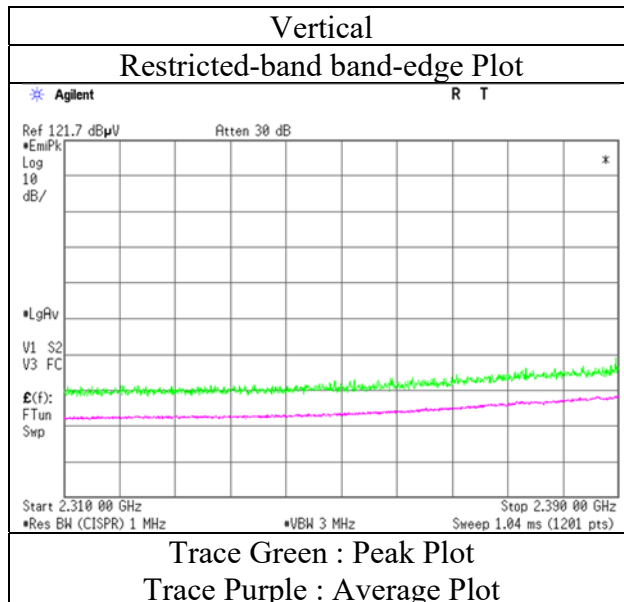
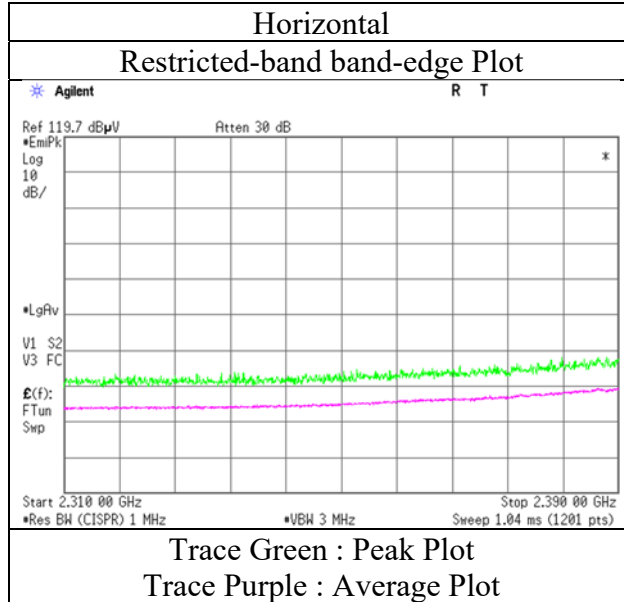

* The measurement was conducted for a sufficiently long enough time to detect any possible spurious emissions. Final result of restricted band edge was shown in tabular data.

Radiated Spurious Emission

Test place	Ise EMC Lab.	
Semi Anechoic Chamber	No.3	No.4
Date	March 25, 2022	April 14, 2022
Temperature / Humidity	20 deg. C / 32 % RH	21 deg. C / 59 % RH
Engineer	Nachi Konegawa (1 GHz - 10 GHz)	Nachi Konegawa (Above 10 GHz)
Mode	Tx 11b 2437 MHz	

Polarity [Hori/Vert]	Frequency [MHz]	Reading (QP / PK) [dBuV]	Reading (AV) [dBuV]	Ant. Factor [dB/m]	Loss [dB]	Gain [dB]	Duty Factor [dB]	Result (QP / PK) [dBuV/m]	Result (AV) [dBuV/m]	Limit (QP / PK) [dBuV/m]	Limit (AV) [dBuV/m]	Margin (QP / PK) [dB]	Margin (AV) [dB]	Remark
Hori.	4874.0	48.4	44.3	31.5	8.0	32.0	-	56.0	51.9	73.9	53.9	17.9	2.0	
Hori.	7311.0	41.4	32.2	35.9	9.6	32.8	-	54.0	44.8	73.9	53.9	19.9	9.1	Floor noise
Hori.	9748.0	41.6	31.9	39.1	10.2	33.6	-	57.4	47.6	73.9	53.9	16.5	6.3	Floor noise
Vert.	4874.0	47.8	43.8	31.5	8.0	32.0	-	55.4	51.4	73.9	53.9	18.5	2.5	
Vert.	7311.0	41.4	32.2	35.9	9.6	32.8	-	54.0	44.8	73.9	53.9	19.9	9.1	Floor noise
Vert.	9748.0	41.6	31.9	39.1	10.2	33.6	-	57.4	47.6	73.9	53.9	16.5	6.3	Floor noise

Result = Reading + Ant Factor + Loss (Cable+Attenuator+Filter+Distance factor(above 1 GHz)) - Gain(Amplifier)

*Other frequency noises omitted in this report were not seen or had enough margin (more than 20 dB).

*QP detector was used up to 1GHz.

Distance factor: 1 GHz - 10 GHz $20\log(3.95\text{ m} / 3.0\text{ m}) = 2.39\text{ dB}$
 10 GHz - 26.5 GHz $20\log(1.0\text{ m} / 3.0\text{ m}) = -9.5\text{ dB}$

Radiated Spurious Emission

Test place	Ise EMC Lab.
Semi Anechoic Chamber	No.3
Date	March 25, 2022
Temperature / Humidity	20 deg. C / 32 % RH
Engineer	Nachi Konegawa (1 GHz - 10 GHz)
Mode	Tx 11b 2457 MHz

Polarity	Frequency	Reading (QP / PK)	Reading (AV)	Ant. Factor	Loss	Gain	Duty Factor	Result (QP / PK)	Result (AV)	Limit (QP / PK)	Limit (AV)	Margin (QP / PK)	Margin (AV)	Remark
[Hori/Vert]	[MHz]	[dBuV]	[dBuV]	[dB/m]	[dB]	[dB]	[dB]	[dBuV/m]	[dBuV/m]	[dBuV/m]	[dBuV/m]	[dB]	[dB]	
Hori.	2483.5	56.8	48.0	27.4	5.7	32.9	-	57.1	48.3	73.9	53.9	16.8	5.6	
Vert.	2483.5	57.6	48.9	27.4	5.7	32.9	-	57.9	49.2	73.9	53.9	16.0	4.7	

Result = Reading + Ant Factor + Loss (Cable+Attenuator+Filter+Distance factor(above 1 GHz)) - Gain(Amplifier)

*Other frequency noises omitted in this report were not seen or had enough margin (more than 20 dB).

*QP detector was used up to 1GHz.

Distance factor: 1 GHz - 10 GHz $20\log(3.95\text{ m} / 3.0\text{ m}) = 2.39\text{ dB}$
 10 GHz - 26.5 GHz $20\log(1.0\text{ m} / 3.0\text{ m}) = -9.5\text{ dB}$

Radiated Spurious Emission (Reference Plot for band-edge)

Test place	Ise EMC Lab.
Semi Anechoic Chamber	No.3
Date	March 25, 2022
Temperature / Humidity	20 deg. C / 32 % RH
Engineer	Nachi Konegawa (1 GHz - 10 GHz)
Mode	Tx 11b 2457MHz

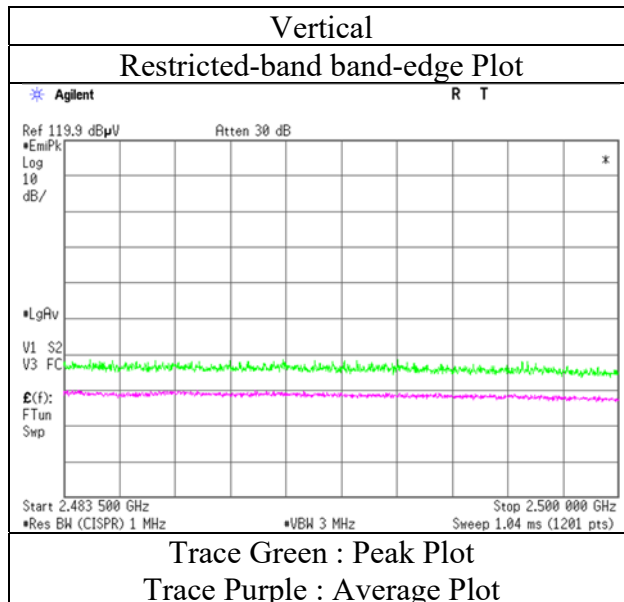
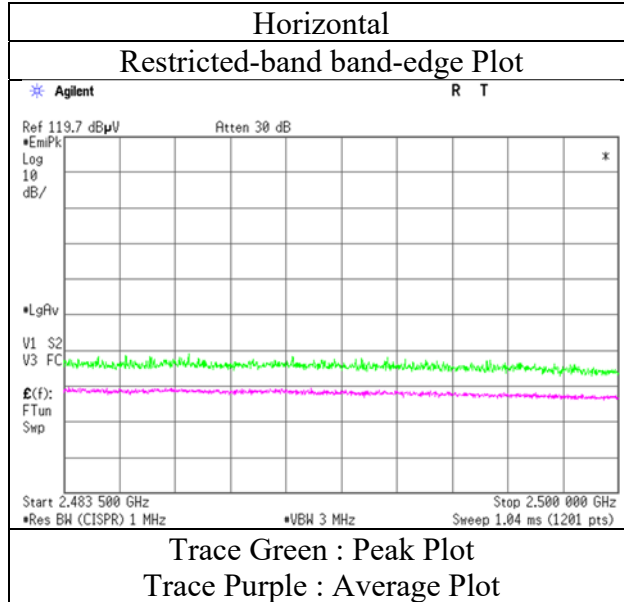

* The measurement was conducted for a sufficiently long enough time to detect any possible spurious emissions. Final result of restricted band edge was shown in tabular data.

Radiated Spurious Emission

Test place	Ise EMC Lab.	
Semi Anechoic Chamber	No.3	No.4
Date	April 6, 2022	April 14, 2022
Temperature / Humidity	21 deg. C / 34 % RH	21 deg. C / 59 % RH
Engineer	Nachi Konegawa (1 GHz - 10 GHz)	Nachi Konegawa (Above 10 GHz)
Mode	Tx 11b 2462 MHz	

Polarity [Hori/Vert]	Frequency [MHz]	Reading (QP / PK) [dBuV]	Reading (AV) [dBuV]	Ant. Factor [dB/m]	Loss [dB]	Gain [dB]	Duty Factor [dB]	Result (QP / PK) [dBuV/m]	Result (AV) [dBuV/m]	Limit (QP / PK) [dBuV/m]	Limit (AV) [dBuV/m]	Margin (QP / PK) [dB]	Margin (AV) [dB]	Remark
Hori.	2483.5	56.0	47.7	27.4	5.7	32.9	-	56.3	48.0	73.9	53.9	17.6	5.9	
Hori.	4924.0	47.7	43.1	31.6	8.1	31.9	-	55.4	50.8	73.9	53.9	18.5	3.1	
Hori.	7386.0	41.8	31.6	36.0	9.6	32.8	-	54.5	44.3	73.9	53.9	19.4	9.6	Floor noise
Hori.	9848.0	41.9	32.0	39.2	10.3	33.6	-	57.7	47.8	73.9	53.9	16.2	6.1	Floor noise
Vert.	2483.5	58.7	50.5	27.4	5.7	32.9	-	59.0	50.8	73.9	53.9	15.0	3.1	
Vert.	4924.0	47.1	42.9	31.6	8.1	31.9	-	54.9	50.7	73.9	53.9	19.1	3.3	
Vert.	7386.0	41.8	31.6	36.0	9.6	32.8	-	54.5	44.3	73.9	53.9	19.4	9.6	Floor noise
Vert.	9848.0	41.9	32.0	39.2	10.3	33.6	-	57.7	47.8	73.9	53.9	16.2	6.1	Floor noise

Result = Reading + Ant Factor + Loss (Cable+Attenuator+Filter+Distance factor(above 1 GHz)) - Gain(Amplifier)

*Other frequency noises omitted in this report were not seen or had enough margin (more than 20 dB).

*QP detector was used up to 1GHz.

Distance factor: 1 GHz - 10 GHz $20\log(3.95\text{ m} / 3.0\text{ m}) = 2.39\text{ dB}$
 10 GHz - 26.5 GHz $20\log(1.0\text{ m} / 3.0\text{ m}) = -9.5\text{ dB}$

Radiated Spurious Emission (Reference Plot for band-edge)

Test place Ise EMC Lab.
Semi Anechoic Chamber No.3
Date April 6, 2022
Temperature / Humidity 21 deg. C / 34 % RH
Engineer Nachi Konegawa
 (1 GHz - 10 GHz)
Mode Tx 11b 2462 MHz

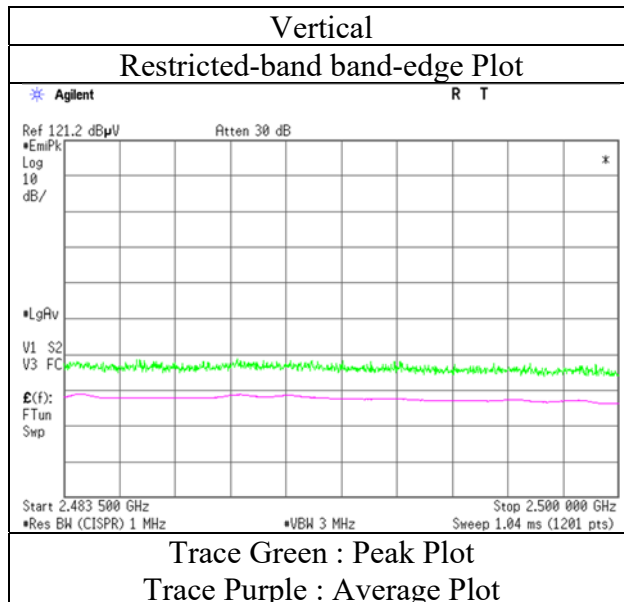
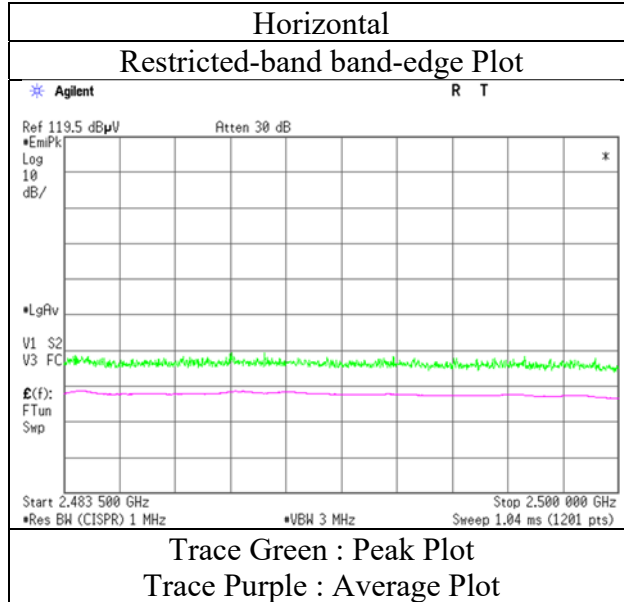

* The measurement was conducted for a sufficiently long enough time to detect any possible spurious emissions. Final result of restricted band edge was shown in tabular data.

Radiated Spurious Emission

Test place	Ise EMC Lab.
Semi Anechoic Chamber	No.3
Date	March 25, 2022
Temperature / Humidity	20 deg. C / 32 % RH
Engineer	Nachi Konegawa (1 GHz - 10 GHz)
Mode	Tx 11g 2412 MHz

Polarity [Hori/Vert]	Frequency [MHz]	Reading (QP / PK) [dBuV]	Reading (AV) [dBuV]	Ant. Factor [dB/m]	Loss [dB]	Gain [dB]	Duty Factor [dB]	Result (QP / PK) [dBuV/m]	Result (AV) [dBuV/m]	Limit (QP / PK) [dBuV/m]	Limit (AV) [dBuV/m]	Margin (QP / PK) [dB]	Margin (AV) [dB]	Remark
Hori.	2390.0	64.1	50.3	27.6	5.7	32.9	-	64.4	50.7	73.9	53.9	9.5	3.2	*1)
Vert.	2390.0	66.2	52.3	27.6	5.7	32.9	-	66.5	52.6	73.9	53.9	7.4	1.3	*1)

Result (QP / PK) = Reading + Ant Factor + Loss (Cable+Attenuator+Filter+Distance factor(above 1 GHz)) - Gain(Amplifier)

*Other frequency noises omitted in this report were not seen or had enough margin (more than 20 dB).

*QP detector was used up to 1GHz.

*1) Not Out of Band emission(Leakage Power)

Distance factor: 1 GHz - 10 GHz $20\log(3.95\text{ m} / 3.0\text{ m}) = 2.39\text{ dB}$
 10 GHz - 26.5 GHz $20\log(1.0\text{ m} / 3.0\text{ m}) = -9.5\text{ dB}$

Radiated Spurious Emission (Reference Plot for band-edge)

Test place Ise EMC Lab.
Semi Anechoic Chamber No.3
Date March 25, 2022
Temperature / Humidity 20 deg. C / 32 % RH
Engineer Nachi Konegawa
 (1 GHz - 10 GHz)
Mode Tx 11g 2412 MHz

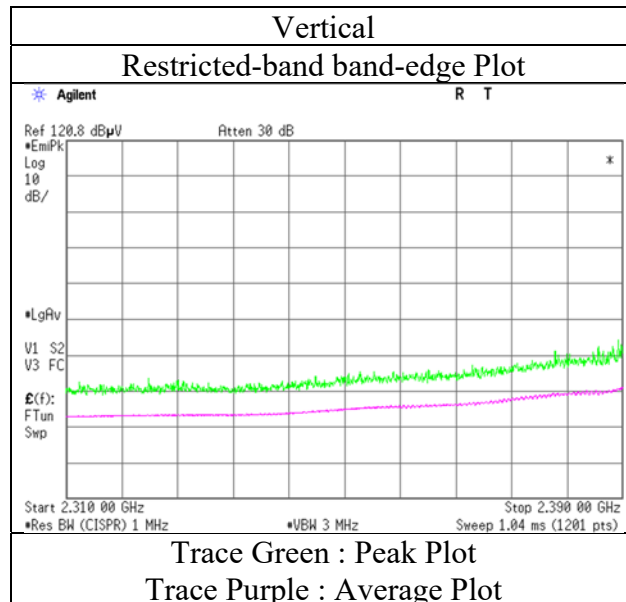
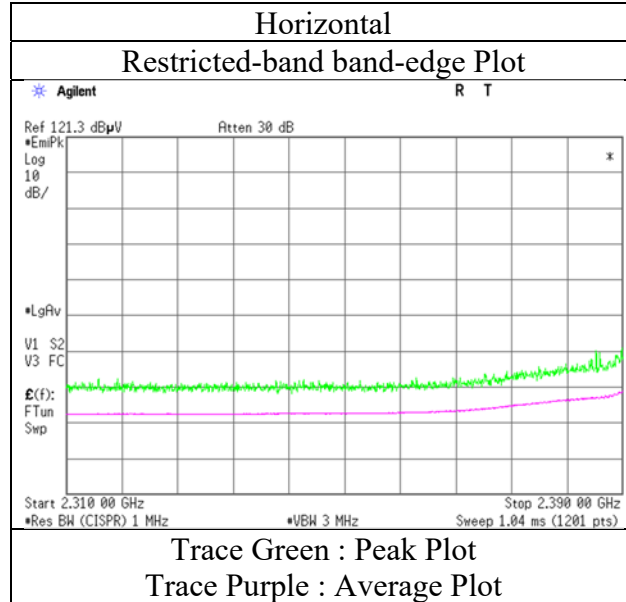

* The measurement was conducted for a sufficiently long enough time to detect any possible spurious emissions. Final result of restricted band edge was shown in tabular data.

Radiated Spurious Emission

Test place	Ise EMC Lab.
Semi Anechoic Chamber	No.3
Date	March 25, 2022
Temperature / Humidity	20 deg. C / 32 % RH
Engineer	Nachi Konegawa (1 GHz - 10 GHz)
Mode	Tx 11g 2417 MHz

Polarity [Hori/Vert]	Frequency [MHz]	Reading (QP / PK) [dBuV]	Reading (AV) [dBuV]	Ant. Factor [dB/m]	Loss [dB]	Gain [dB]	Duty Factor [dB]	Result (QP / PK) [dBuV/m]	Result (AV) [dBuV/m]	Limit (QP / PK) [dBuV/m]	Limit (AV) [dBuV/m]	Margin (QP / PK) [dB]	Margin (AV) [dB]	Remark
Hori.	2390.0	62.2	49.1	27.6	5.7	32.9	-	62.5	49.5	73.9	53.9	11.4	4.4	*1)
Vert.	2390.0	67.3	52.0	27.6	5.7	32.9	-	67.6	52.3	73.9	53.9	6.3	1.6	*1)

Result (QP / PK) = Reading + Ant Factor + Loss (Cable+Attenuator+Filter+Distance factor(above 1 GHz)) - Gain(Amplifier)

*Other frequency noises omitted in this report were not seen or had enough margin (more than 20 dB).

*QP detector was used up to 1GHz.

*1) Not Out of Band emission(Leakage Power)

Distance factor: 1 GHz - 10 GHz $20\log(3.95\text{ m} / 3.0\text{ m}) = 2.39\text{ dB}$
 10 GHz - 26.5 GHz $20\log(1.0\text{ m} / 3.0\text{ m}) = -9.5\text{ dB}$

Radiated Spurious Emission (Reference Plot for band-edge)

Test place Ise EMC Lab.
Semi Anechoic Chamber No.3
Date March 25, 2022
Temperature / Humidity 20 deg. C / 32 % RH
Engineer Nachi Konegawa
 (1 GHz - 10 GHz)
Mode Tx 11g 2417 MHz

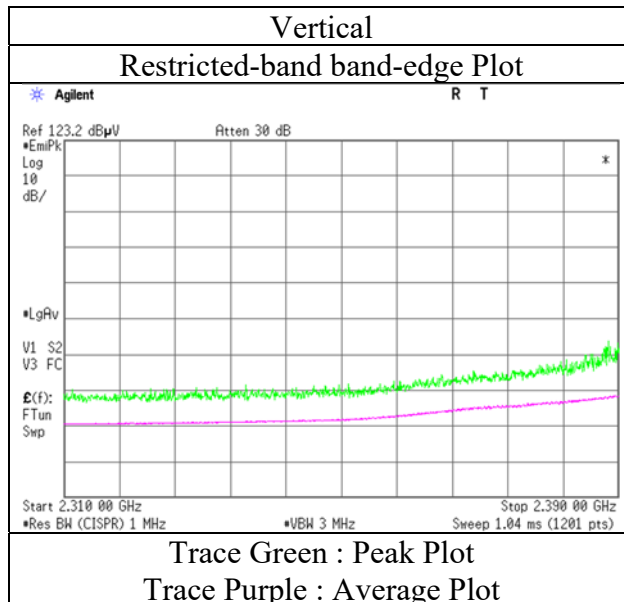
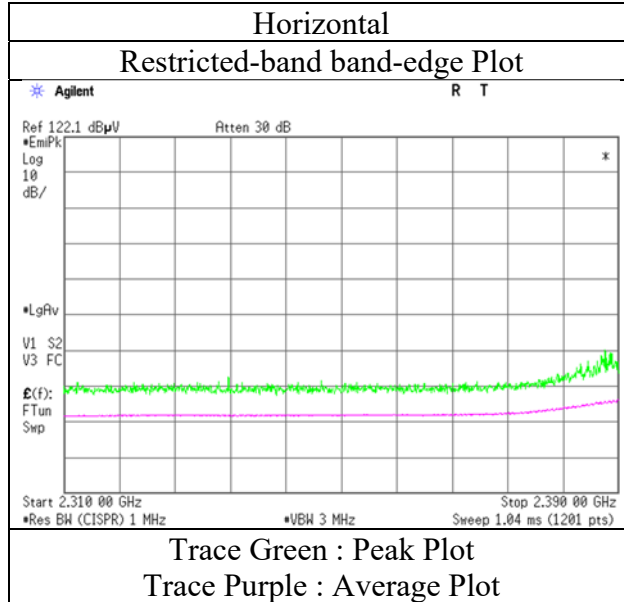

* The measurement was conducted for a sufficiently long enough time to detect any possible spurious emissions. Final result of restricted band edge was shown in tabular data.

Radiated Spurious Emission

Test place	Ise EMC Lab.
Semi Anechoic Chamber	No.3
Date	March 25, 2022
Temperature / Humidity	20 deg. C / 32 % RH
Engineer	Nachi Konegawa (1 GHz - 10 GHz)
Mode	Tx 11g 2457 MHz

Polarity	Frequency	Reading (QP / PK)	Reading (AV)	Ant. Factor	Loss	Gain	Duty Factor	Result (QP / PK)	Result (AV)	Limit (QP / PK)	Limit (AV)	Margin (QP / PK)	Margin (AV)	Remark
[Hori/Vert]	[MHz]	[dBuV]	[dBuV]	[dB/m]	[dB]	[dB]	[dB]	[dBuV/m]	[dBuV/m]	[dBuV/m]	[dBuV/m]	[dB]	[dB]	
Hori.	2483.5	64.4	49.6	27.4	5.7	32.9	-	64.7	49.9	73.9	53.9	9.2	4.0	*1)
Vert.	2483.5	65.7	51.0	27.4	5.7	32.9	-	66.0	51.3	73.9	53.9	7.9	2.6	*1)

Result (QP / PK) = Reading + Ant Factor + Loss (Cable+Attenuator+Filter+Distance factor(above 1 GHz)) - Gain(Amplifier)

*Other frequency noises omitted in this report were not seen or had enough margin (more than 20 dB).

*QP detector was used up to 1GHz.

*1) Not Out of Band emission(Leakage Power)

Distance factor:	1 GHz - 10 GHz	$20\log(3.95\text{ m} / 3.0\text{ m}) = 2.39\text{ dB}$
	10 GHz - 26.5 GHz	$20\log(1.0\text{ m} / 3.0\text{ m}) = -9.5\text{ dB}$

Radiated Spurious Emission (Reference Plot for band-edge)

Test place Ise EMC Lab.
Semi Anechoic Chamber No.3
Date March 25, 2022
Temperature / Humidity 20 deg. C / 32 % RH
Engineer Nachi Konegawa
 (1 GHz - 10 GHz)
Mode Tx 11g 2457 MHz

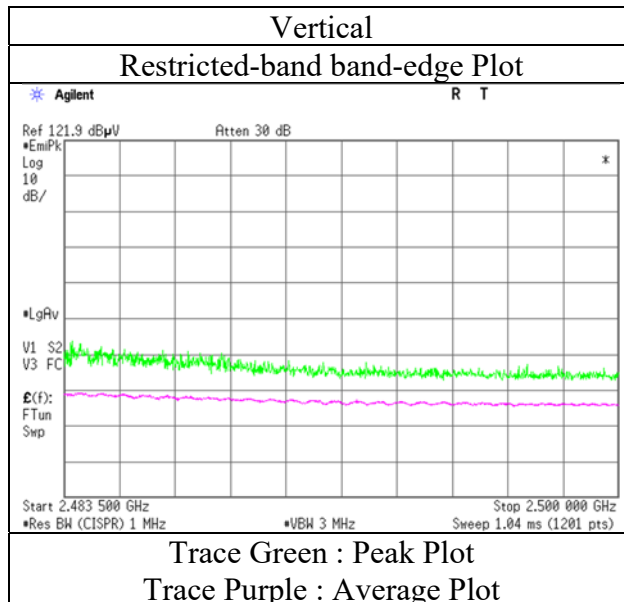
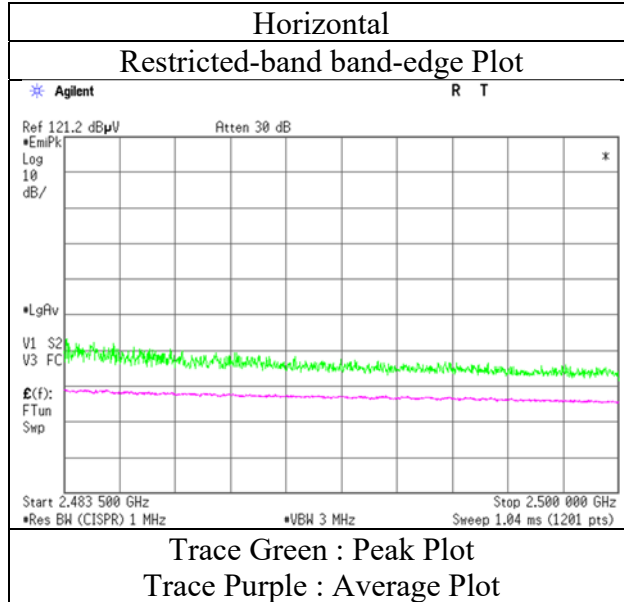

* The measurement was conducted for a sufficiently long enough time to detect any possible spurious emissions. Final result of restricted band edge was shown in tabular data.

Radiated Spurious Emission

Test place	Ise EMC Lab.
Semi Anechoic Chamber	No.3
Date	March 25, 2022
Temperature / Humidity	20 deg. C / 32 % RH
Engineer	Nachi Konegawa (1 GHz - 10 GHz)
Mode	Tx 11g 2462 MHz

Polarity [Hori/Vert]	Frequency [MHz]	Reading (QP / PK) [dBuV]	Reading (AV) [dBuV]	Ant. Factor [dB/m]	Loss [dB]	Gain [dB]	Duty Factor [dB]	Result (QP / PK) [dBuV/m]	Result (AV) [dBuV/m]	Limit (QP / PK) [dBuV/m]	Limit (AV) [dBuV/m]	Margin (QP / PK) [dB]	Margin (AV) [dB]	Remark
Hori.	2483.5	64.1	50.7	27.4	5.7	32.9	-	64.4	51.0	73.9	53.9	9.6	2.9	*1)
Vert.	2483.5	65.4	52.1	27.4	5.7	32.9	-	65.7	52.4	73.9	53.9	8.2	1.5	*1)

Result (QP / PK) = Reading + Ant Factor + Loss (Cable+Attenuator+Filter+Distance factor(above 1 GHz)) - Gain(Amplifier)

*Other frequency noises omitted in this report were not seen or had enough margin (more than 20 dB).

*QP detector was used up to 1GHz.

*1) Not Out of Band emission(Leakage Power)

Distance factor: 1 GHz - 10 GHz $20\log(3.95\text{ m} / 3.0\text{ m}) = 2.39\text{ dB}$
 10 GHz - 26.5 GHz $20\log(1.0\text{ m} / 3.0\text{ m}) = -9.5\text{ dB}$

Radiated Spurious Emission (Reference Plot for band-edge)

Test place Ise EMC Lab.
Semi Anechoic Chamber No.3
Date March 25, 2022
Temperature / Humidity 20 deg. C / 32 % RH
Engineer Nachi Konegawa
 (1 GHz - 10 GHz)
Mode Tx 11g 2462 MHz

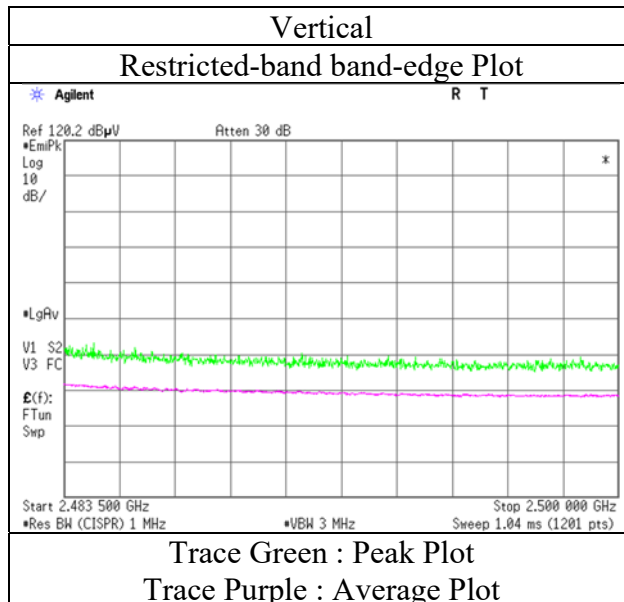
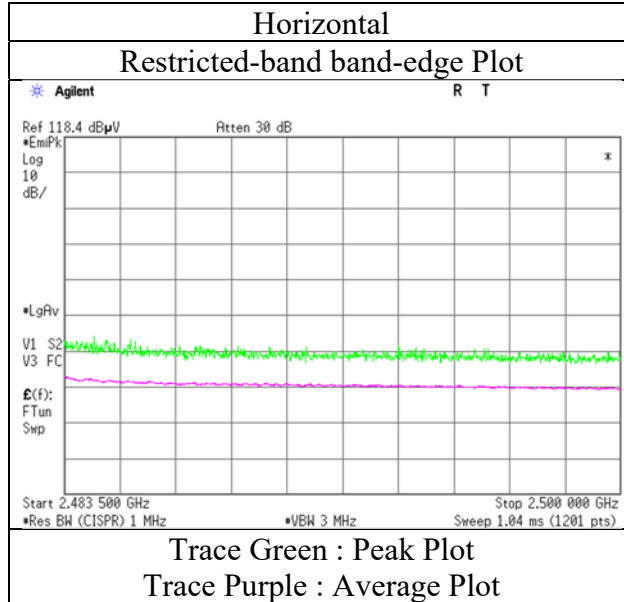

* The measurement was conducted for a sufficiently long enough time to detect any possible spurious emissions. Final result of restricted band edge was shown in tabular data.

Radiated Spurious Emission

Test place	Ise EMC Lab.	
Semi Anechoic Chamber	No.3	No.4
Date	March 25, 2022	April 14, 2022
Temperature / Humidity	21 deg. C / 37 % RH	21 deg. C / 59 % RH
Engineer	Takafumi Noguchi	Nachi Konegawa
	(1 GHz - 10 GHz)	(Above 10 GHz)
Mode	Tx 11n-20 2412 MHz	

Polarity [Hori/Vert]	Frequency [MHz]	Reading (QP / PK) [dBuV]	Reading (AV) [dBuV]	Ant. Factor [dB/m]	Loss [dB]	Gain [dB]	Duty Factor [dB]	Result (QP / PK) [dBuV/m]	Result (AV) [dBuV/m]	Limit (QP / PK) [dBuV/m]	Limit (AV) [dBuV/m]	Margin (QP / PK) [dB]	Margin (AV) [dB]	Remark
Hori.	2390.0	67.4	51.1	27.6	5.7	32.9	-	67.8	51.5	73.9	53.9	6.1	2.4	
Hori.	4824.0	43.1	32.3	31.5	8.0	32.0	-	50.6	39.9	73.9	53.9	23.3	14.1	
Hori.	7236.0	41.3	30.5	35.8	9.6	32.8	-	53.9	43.1	73.9	53.9	20.0	10.9	Floor noise
Hori.	9648.0	40.6	30.7	38.8	10.2	33.5	-	56.1	46.2	73.9	53.9	17.8	7.7	Floor noise
Vert.	2390.0	70.7	53.4	27.6	5.7	32.9	-	71.1	53.7	73.9	53.9	2.8	0.2	
Vert.	4824.0	40.1	29.8	31.5	8.0	32.0	-	47.7	37.4	73.9	53.9	26.2	16.5	Floor noise
Vert.	7236.0	40.8	30.7	35.8	9.6	32.8	-	53.3	43.3	73.9	53.9	20.6	10.7	Floor noise
Vert.	9648.0	40.3	30.9	38.8	10.2	33.5	-	55.8	46.4	73.9	53.9	18.1	7.5	Floor noise

Result = Reading + Ant Factor + Loss (Cable+Attenuator+Filter+Distance factor(above 1 GHz)) - Gain(Amplifier)

*Other frequency noises omitted in this report were not seen or had enough margin (more than 20 dB).

*QP detector was used up to 1GHz.

20dBc Data Sheet

Polarity [Hori/Vert]	Frequency [MHz]	Reading (PK) [dBuV]	Ant Factor [dB/m]	Loss [dB]	Gain [dB]	Result [dBuV/m]	Limit [dBuV/m]	Margin [dB]	Remark
Hori.	2412.0	98.4	27.5	5.7	32.9	98.7	-	-	Carrier
Hori.	2400.0	66.3	27.5	5.7	32.9	66.6	78.7	12.1	
Vert.	2412.0	101.4	27.5	5.7	32.9	101.7	-	-	Carrier
Vert.	2400.0	68.2	27.5	5.7	32.9	68.5	81.7	13.1	

Result = Reading + Ant Factor + Loss (Cable+Attenuator+Filter+Distance factor(above 1 GHz)) - Gain(Amplifier)

Distance factor: 1 GHz - 10 GHz $20\log(3.95\text{ m} / 3.0\text{ m}) = 2.39\text{ dB}$
 10 GHz - 26.5 GHz $20\log(1.0\text{ m} / 3.0\text{ m}) = -9.5\text{ dB}$

Radiated Spurious Emission (Reference Plot for band-edge)

Test place	Ise EMC Lab.
Semi Anechoic Chamber	No.3
Date	March 25, 2022
Temperature / Humidity	21 deg. C / 37 % RH
Engineer	Takafumi Noguchi
	(1 GHz - 10 GHz)
Mode	Tx 11n-20 2412 MHz

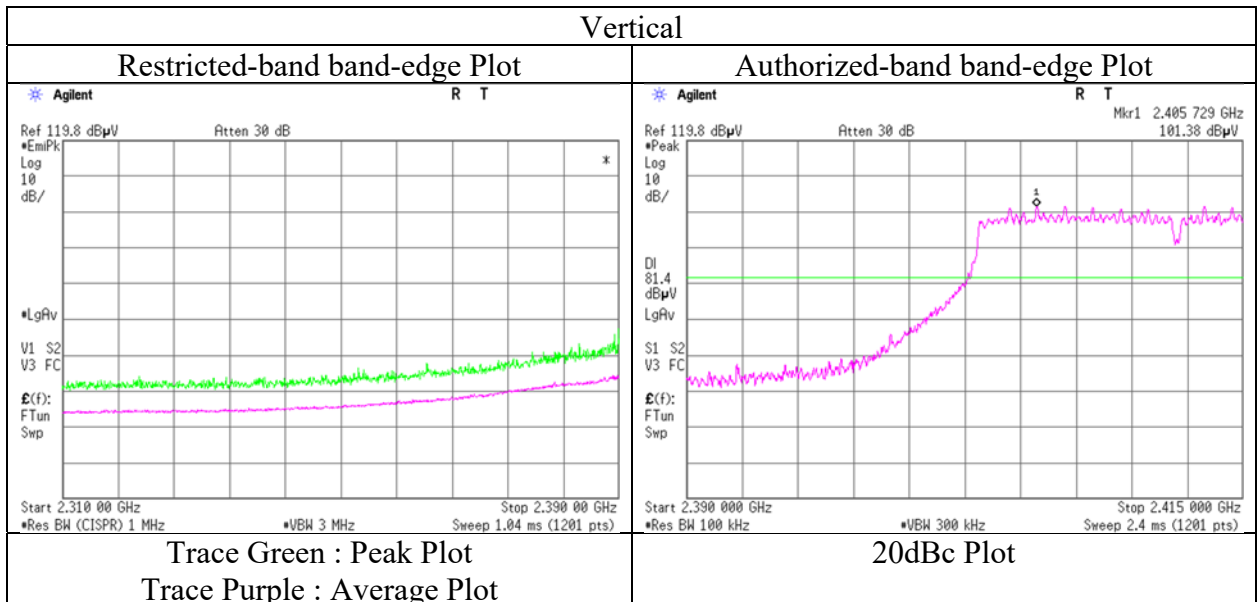
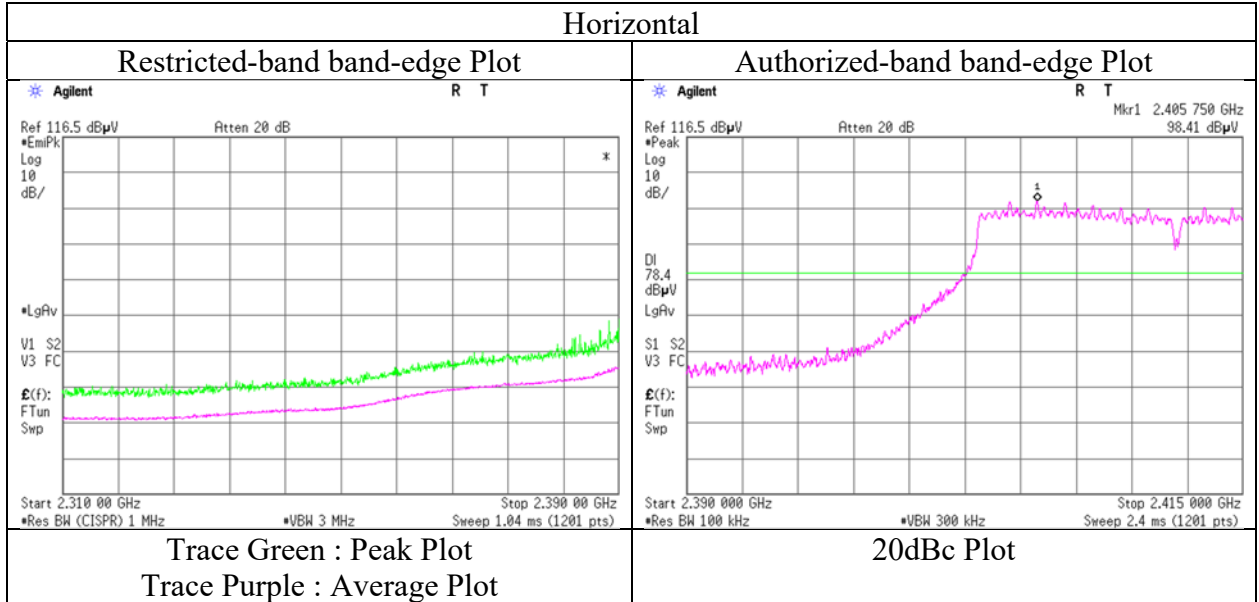

* The measurement was conducted for a sufficiently long enough time to detect any possible spurious emissions. Final result of restricted band edge was shown in tabular data.

Radiated Spurious Emission

Test place	Ise EMC Lab.
Semi Anechoic Chamber	No.3
Date	March 25, 2022
Temperature / Humidity	21 deg. C / 37 % RH
Engineer	Takafumi Noguchi (1 GHz - 10 GHz)
Mode	Tx 11n-20 2417 MHz

Polarity	Frequency	Reading (QP / PK)	Reading (AV)	Ant. Factor	Loss	Gain	Duty Factor	Result (QP / PK)	Result (AV)	Limit (QP / PK)	Limit (AV)	Margin (QP / PK)	Margin (AV)	Remark
[Hori/Vert]	[MHz]	[dBuV]	[dBuV]	[dB/m]	[dB]	[dB]	[dB]	[dBuV/m]	[dBuV/m]	[dBuV/m]	[dBuV/m]	[dB]	[dB]	
Hori.	2390.0	67.8	51.1	27.6	5.7	32.9	-	68.2	51.4	73.9	53.9	5.8	2.5	
Vert.	2390.0	68.1	53.3	27.6	5.7	32.9	-	68.5	53.7	73.9	53.9	5.4	0.2	

Result = Reading + Ant Factor + Loss (Cable+Attenuator+Filter+Distance factor(above 1 GHz)) - Gain(Amplifier)

*Other frequency noises omitted in this report were not seen or had enough margin (more than 20 dB).

*QP detector was used up to 1GHz.

Distance factor: 1 GHz - 10 GHz $20\log(3.95\text{ m} / 3.0\text{ m}) = 2.39\text{ dB}$
 10 GHz - 26.5 GHz $20\log(1.0\text{ m} / 3.0\text{ m}) = -9.5\text{ dB}$

Radiated Spurious Emission (Reference Plot for band-edge)

Test place	Ise EMC Lab.
Semi Anechoic Chamber	No.3
Date	March 25, 2022
Temperature / Humidity	21 deg. C / 37 % RH
Engineer	Takafumi Noguchi (1 GHz - 10 GHz)
Mode	Tx 11n-20 2417 MHz

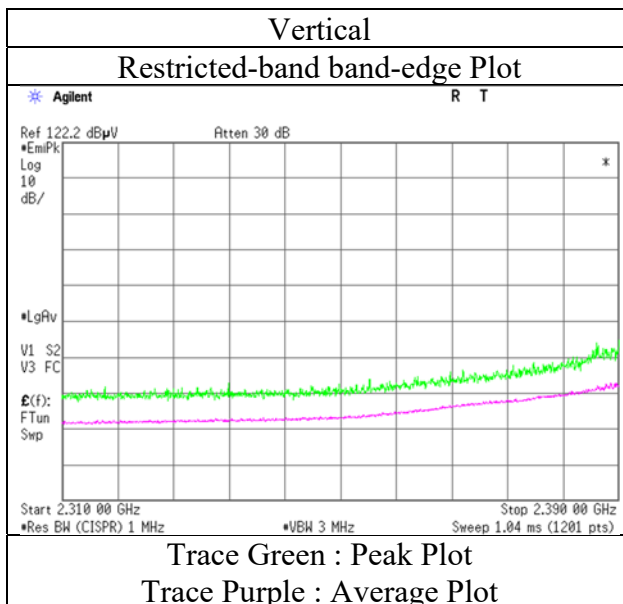
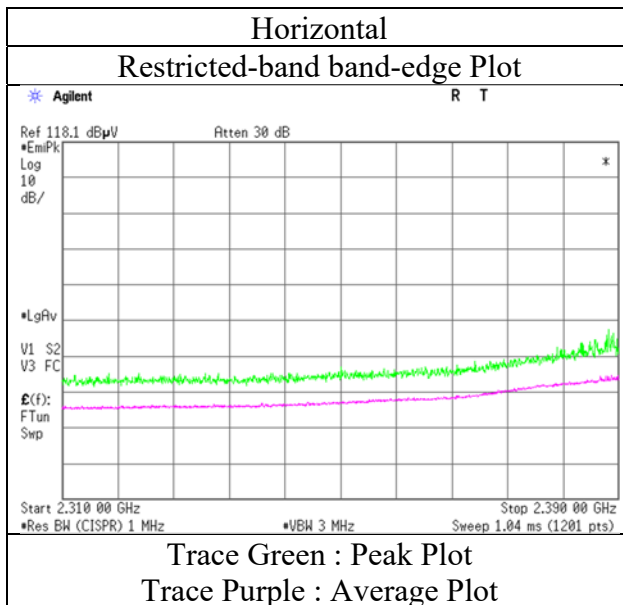

* The measurement was conducted for a sufficiently long enough time to detect any possible spurious emissions. Final result of restricted band edge was shown in tabular data.

Radiated Spurious Emission

Test place	Ise EMC Lab.		
Semi Anechoic Chamber	No.3	No.4	No.4
Date	March 25, 2022	April 14, 2022	April 19, 2022
Temperature / Humidity	21 deg. C / 37 % RH	21 deg. C / 59 % RH	21 deg. C / 43 % RH
Engineer	Takafumi Noguchi (1 GHz - 10 GHz)	Nachi Konegawa (Above 10 GHz)	Kouki Yamada (Below 1 GHz)
Mode	Tx 11n-20 2437 MHz		

Polarity [Hori/Vert]	Frequency [MHz]	Reading (QP / PK) [dBuV]	Reading (AV) [dBuV]	Ant. Factor [dB/m]	Loss [dB]	Gain [dB]	Duty Factor [dB]	Result (QP / PK) [dBuV/m]	Result (AV) [dBuV/m]	Limit (QP / PK) [dBuV/m]	Limit (AV) [dBuV/m]	Margin (QP / PK) [dB]	Margin (AV) [dB]	Remark
Hori.	85.4	31.0	-	7.7	7.7	32.1	-	14.3	-	40.0	-	25.7	-	
Hori.	166.4	27.1	-	15.7	8.4	32.0	-	19.2	-	43.5	-	24.3	-	
Hori.	234.2	36.2	-	11.7	8.9	32.0	-	24.8	-	46.0	-	21.2	-	
Hori.	335.0	39.3	-	15.0	9.6	32.1	-	31.8	-	46.0	-	14.2	-	
Hori.	368.6	33.4	-	15.2	9.9	32.1	-	26.3	-	46.0	-	19.7	-	
Hori.	480.4	27.4	-	17.3	10.6	32.2	-	23.1	-	46.0	-	22.9	-	
Hori.	4874.0	43.5	34.1	31.5	8.0	32.0	-	51.2	41.7	73.9	53.9	22.7	12.2	
Hori.	7311.0	41.5	31.4	35.9	9.6	32.8	-	54.1	44.0	73.9	53.9	19.8	9.9	Floor noise
Hori.	9748.0	40.4	31.1	39.1	10.2	33.6	-	56.2	46.9	73.9	53.9	17.8	7.0	Floor noise
Vert.	49.5	40.8	-	11.4	7.3	32.1	-	27.4	-	40.0	-	12.7	-	
Vert.	84.8	45.1	-	7.6	7.7	32.1	-	28.3	-	40.0	-	11.7	-	
Vert.	96.3	46.4	-	9.7	7.8	32.1	-	31.8	-	43.5	-	11.7	-	
Vert.	186.7	32.7	-	16.4	8.6	32.0	-	25.7	-	43.5	-	17.8	-	
Vert.	335.9	32.8	-	15.0	9.7	32.1	-	25.4	-	46.0	-	20.7	-	
Vert.	373.2	33.7	-	15.2	9.9	32.1	-	26.7	-	46.0	-	19.3	-	
Vert.	4874.0	41.6	30.8	31.5	8.0	32.0	-	49.3	38.4	73.9	53.9	24.7	15.5	Floor noise
Vert.	7311.0	41.0	31.1	35.9	9.6	32.8	-	53.7	43.7	73.9	53.9	20.3	10.2	Floor noise
Vert.	9748.0	40.2	31.1	39.1	10.2	33.6	-	56.0	46.8	73.9	53.9	17.9	7.1	Floor noise

Result = Reading + Ant Factor + Loss (Cable+Attenuator+Filter+Distance factor(above 1 GHz)) - Gain(Amplifier)

*Other frequency noises omitted in this report were not seen or had enough margin (more than 20 dB).

*QP detector was used up to 1GHz.

Distance factor: 1 GHz - 10 GHz 20log(3.95 m / 3.0 m) = 2.39 dB
 10 GHz - 26.5 GHz 20log(1.0 m / 3.0 m) = -9.5 dB

Radiated Spurious Emission

Test place	Ise EMC Lab.
Semi Anechoic Chamber	No.3
Date	March 25, 2022
Temperature / Humidity	21 deg. C / 37 % RH
Engineer	Takafumi Noguchi (1 GHz - 10 GHz)
Mode	Tx 11n-20 2457 MHz

Polarity	Frequency	Reading (QP / PK)	Reading (AV)	Ant. Factor	Loss	Gain	Duty Factor	Result (QP / PK)	Result (AV)	Limit (QP / PK)	Limit (AV)	Margin (QP / PK)	Margin (AV)	Remark
[Hori/Vert]	[MHz]	[dBuV]	[dBuV]	[dB/m]	[dB]	[dB]	[dB]	[dBuV/m]	[dBuV/m]	[dBuV/m]	[dBuV/m]	[dB]	[dB]	
Hori.	2483.5	65.8	50.5	27.4	5.7	32.9	-	66.1	50.8	73.9	53.9	7.8	3.1	
Vert.	2483.5	69.0	52.5	27.4	5.7	32.9	-	69.3	52.8	73.9	53.9	4.6	1.1	

Result = Reading + Ant Factor + Loss (Cable+Attenuator+Filter+Distance factor(above 1 GHz)) - Gain(Amplifier)

*Other frequency noises omitted in this report were not seen or had enough margin (more than 20 dB).

*QP detector was used up to 1GHz.

Distance factor: 1 GHz - 10 GHz $20\log(3.95\text{ m} / 3.0\text{ m}) = 2.39\text{ dB}$
 10 GHz - 26.5 GHz $20\log(1.0\text{ m} / 3.0\text{ m}) = -9.5\text{ dB}$

Radiated Spurious Emission (Reference Plot for band-edge)

Test place Ise EMC Lab.
Semi Anechoic Chamber No.3
Date March 25, 2022
Temperature / Humidity 21 deg. C / 37 % RH
Engineer Takafumi Noguchi
 (1 GHz - 10 GHz)
Mode Tx 11n-20 2457MHz

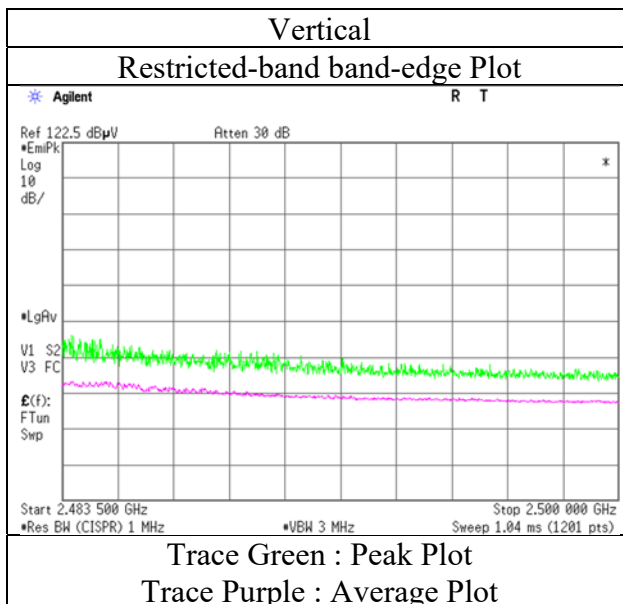
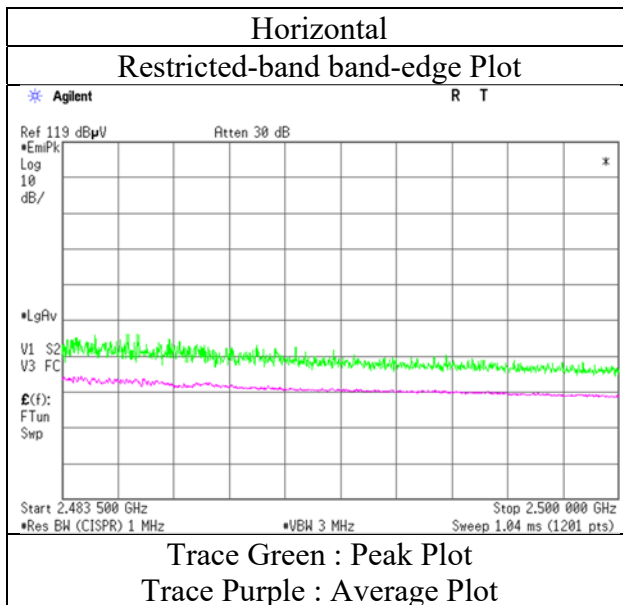

* The measurement was conducted for a sufficiently long enough time to detect any possible spurious emissions. Final result of restricted band edge was shown in tabular data.

Radiated Spurious Emission

Test place	Ise EMC Lab.	
Semi Anechoic Chamber	No.3	No.4
Date	March 25, 2022	April 14, 2022
Temperature / Humidity	21 deg. C / 37 % RH	21 deg. C / 59 % RH
Engineer	Takafumi Noguchi	Nachi Konegawa
	(1 GHz - 10 GHz)	(Above 10 GHz)
Mode	Tx 11n-20 2462 MHz	

Polarity [Hori/Vert]	Frequency [MHz]	Reading (QP / PK) [dBuV]	Reading (AV) [dBuV]	Ant. Factor [dB/m]	Loss [dB]	Gain [dB]	Duty Factor [dB]	Result (QP / PK) [dBuV/m]	Result (AV) [dBuV/m]	Limit (QP / PK) [dBuV/m]	Limit (AV) [dBuV/m]	Margin (QP / PK) [dB]	Margin (AV) [dB]	Remark
Hori.	2483.5	62.5	50.4	27.4	5.7	32.9	-	62.8	50.7	73.9	53.9	11.1	3.2	
Hori.	4924.0	41.1	30.8	31.6	8.1	31.9	-	48.8	38.5	73.9	53.9	25.1	15.4	Floor noise
Hori.	7386.0	41.3	31.1	36.0	9.6	32.8	-	54.1	43.9	73.9	53.9	19.8	10.0	Floor noise
Hori.	9848.0	41.8	31.3	39.2	10.3	33.6	-	57.6	47.1	73.9	53.9	16.3	6.8	Floor noise
Vert.	2483.5	66.5	53.0	27.4	5.7	32.9	-	66.8	53.3	73.9	53.9	7.1	0.6	
Vert.	4924.0	40.1	30.1	31.6	8.1	31.9	-	47.9	37.8	73.9	53.9	26.1	16.1	Floor noise
Vert.	7386.0	41.5	30.9	36.0	9.6	32.8	-	54.3	43.6	73.9	53.9	19.6	10.3	Floor noise
Vert.	9848.0	41.3	31.3	39.2	10.3	33.6	-	57.2	47.1	73.9	53.9	16.8	6.8	Floor noise

Result = Reading + Ant Factor + Loss (Cable+Attenuator+Filter+Distance factor(above 1 GHz)) - Gain(Amplifier)

*Other frequency noises omitted in this report were not seen or had enough margin (more than 20 dB).

*QP detector was used up to 1GHz.

Distance factor: 1 GHz - 10 GHz 20log(3.95 m / 3.0 m) = 2.39 dB
 10 GHz - 26.5 GHz 20log(1.0 m / 3.0 m) = -9.5 dB

Radiated Spurious Emission (Reference Plot for band-edge)

Test place Ise EMC Lab.
Semi Anechoic Chamber No.3
Date March 25, 2022
Temperature / Humidity 21 deg. C / 37 % RH
Engineer Takafumi Noguchi
 (1 GHz - 10 GHz)
Mode Tx 11n-20 2462 MHz

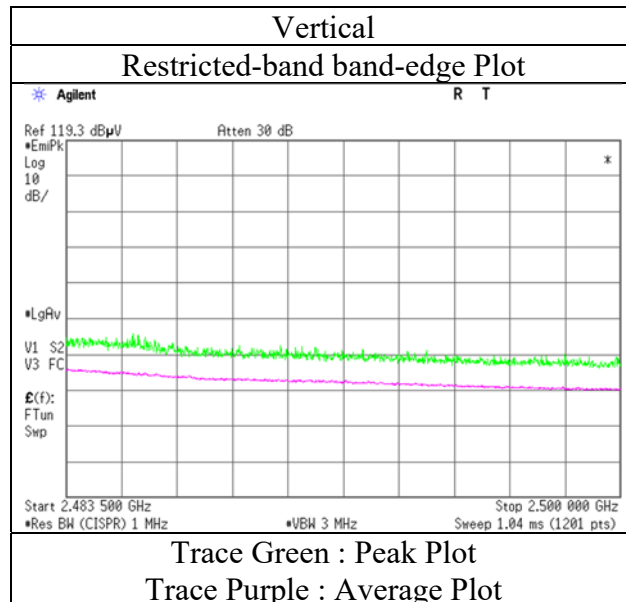
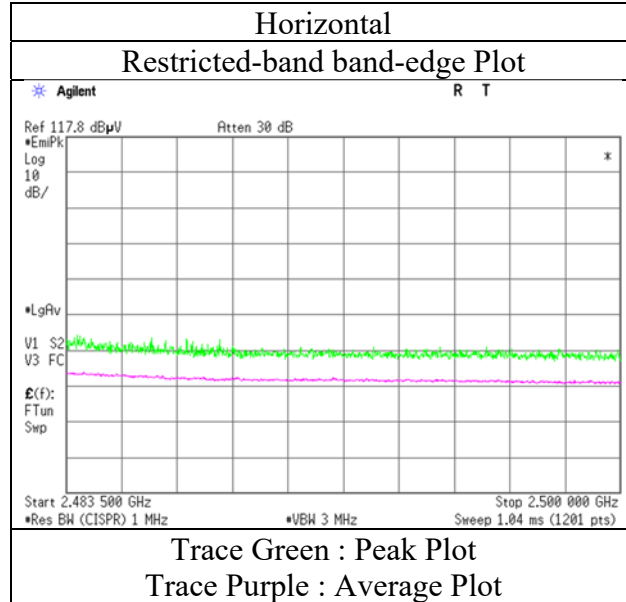

* The measurement was conducted for a sufficiently long enough time to detect any possible spurious emissions. Final result of restricted band edge was shown in tabular data.

Radiated Spurious Emission

Test place	Ise EMC Lab.	
Semi Anechoic Chamber	No.3	No.4
Date	March 27, 2022	April 14, 2022
Temperature / Humidity	22 deg. C / 30 % RH	21 deg. C / 59 % RH
Engineer	Junki Nagatomi	Nachi Konegawa
	(1 GHz - 10 GHz)	(Above 10 GHz)
Mode	Tx 11n-40 2422 MHz	

Polarity	Frequency	Reading (QP / PK)	Reading (AV)	Ant. Factor	Loss	Gain	Duty Factor	Result (QP / PK)	Result (AV)	Limit (QP / PK)	Limit (AV)	Margin (QP / PK)	Margin (AV)	Remark
[Hori/Vert]	[MHz]	[dBuV]	[dBuV]	[dB/m]	[dB]	[dB]	[dB]	[dBuV/m]	[dBuV/m]	[dBuV/m]	[dBuV/m]	[dB]	[dB]	
Hori.	2390.0	66.1	49.0	27.6	5.7	32.9	-	66.4	49.4	73.9	53.9	7.5	4.6	
Hori.	4844.0	40.8	30.3	31.5	8.0	32.0	-	48.4	37.9	73.9	53.9	25.5	16.0	Floor noise
Hori.	7266.0	41.0	30.8	35.8	9.6	32.8	-	53.6	43.4	73.9	53.9	20.3	10.5	Floor noise
Hori.	9688.0	41.9	30.7	39.0	10.2	33.6	-	57.5	46.3	73.9	53.9	16.4	7.6	Floor noise
Vert.	2390.0	67.0	50.7	27.6	5.7	32.9	-	67.4	51.0	73.9	53.9	6.5	2.9	
Vert.	4844.0	41.2	30.3	31.5	8.0	32.0	-	48.8	37.9	73.9	53.9	25.1	16.0	Floor noise
Vert.	7266.0	41.4	30.9	35.8	9.6	32.8	-	53.9	43.4	73.9	53.9	20.0	10.5	Floor noise
Vert.	9688.0	41.5	30.7	39.0	10.2	33.6	-	57.1	46.4	73.9	53.9	16.8	7.6	Floor noise

Result = Reading + Ant Factor + Loss (Cable+Attenuator+Filter+Distance factor(above 1 GHz)) - Gain(Amplifier)

*Other frequency noises omitted in this report were not seen or had enough margin (more than 20 dB).

*QP detector was used up to 1GHz.

20dBc Data Sheet

Polarity	Frequency	Reading (PK)	Ant Factor	Loss	Gain	Result	Limit	Margin	Remark
[Hori/Vert]	[MHz]	[dBuV]	[dB/m]	[dB]	[dB]	[dBuV/m]	[dBuV/m]	[dB]	
Hori.	2422.0	92.9	27.5	5.7	32.9	93.2	-	-	Carrier
Hori.	2400.0	61.9	27.5	5.7	32.9	62.2	73.2	11.0	
Vert.	2422.0	93.9	27.5	5.7	32.9	94.2	-	-	Carrier
Vert.	2400.0	63.6	27.5	5.7	32.9	63.9	74.2	10.2	

Result = Reading + Ant Factor + Loss (Cable+Attenuator+Filter+Distance factor(above 1 GHz)) - Gain(Amplifier)

Distance factor: 1 GHz - 10 GHz $20\log(3.95\text{ m} / 3.0\text{ m}) = 2.39\text{ dB}$
 10 GHz - 26.5 GHz $20\log(1.0\text{ m} / 3.0\text{ m}) = -9.5\text{ dB}$

Radiated Spurious Emission (Reference Plot for band-edge)

Test place	Ise EMC Lab.
Semi Anechoic Chamber	No.3
Date	March 27, 2022
Temperature / Humidity	22 deg. C / 30 % RH
Engineer	Junki Nagatomi
	(1 GHz - 10 GHz)
Mode	Tx 11n-40 2422 MHz

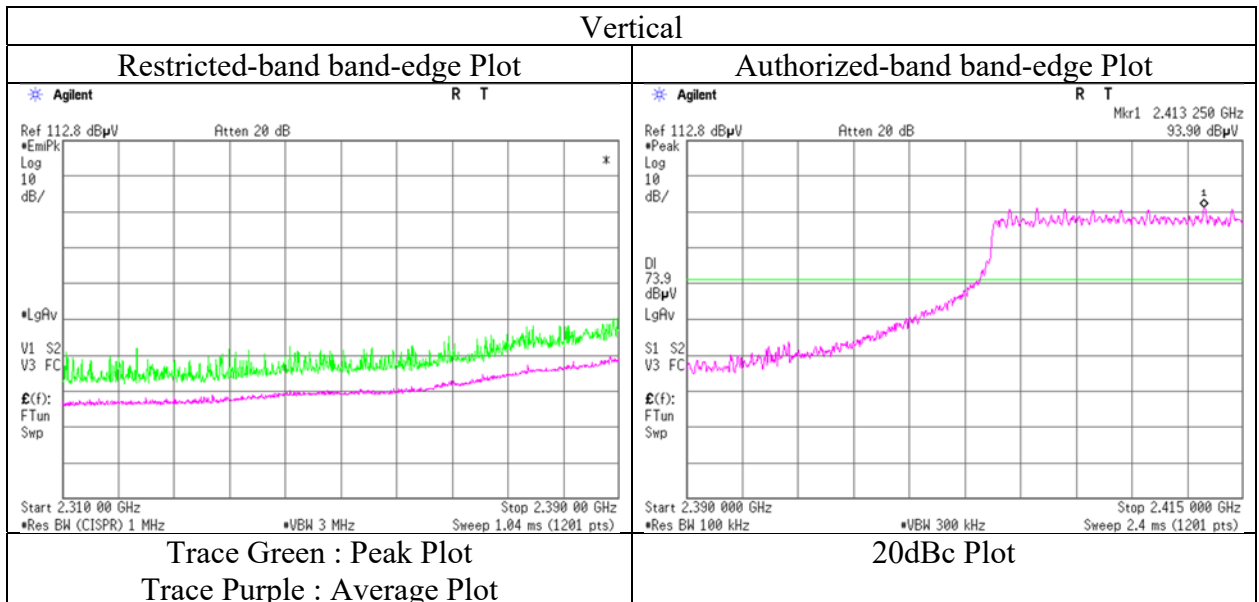
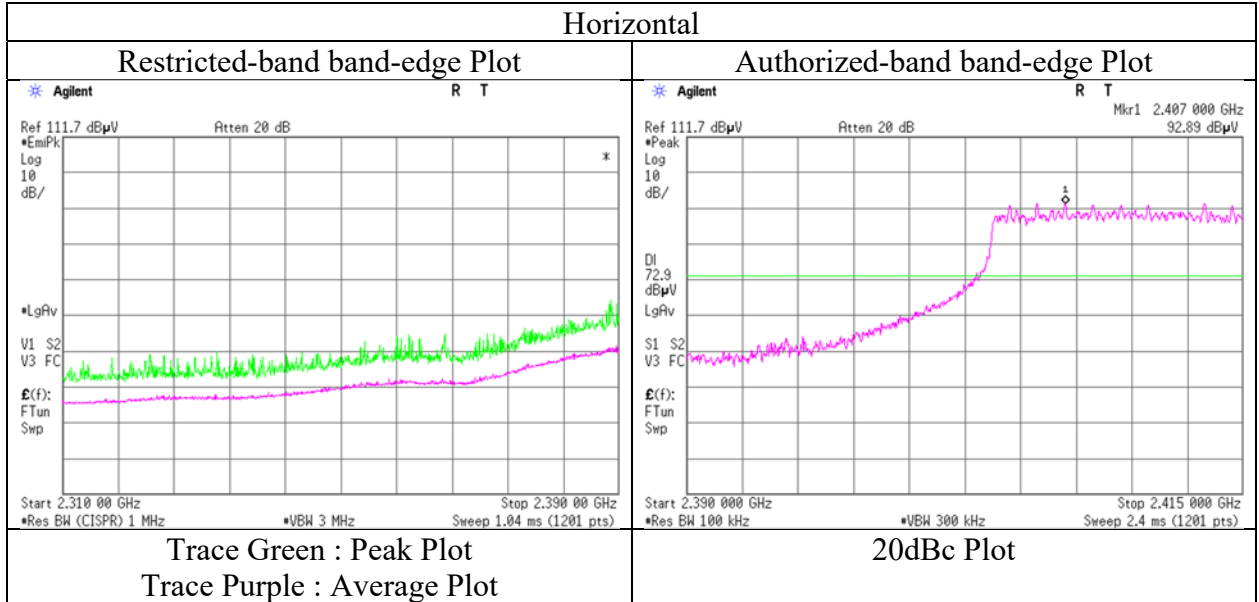

* The measurement was conducted for a sufficiently long enough time to detect any possible spurious emissions. Final result of restricted band edge was shown in tabular data.

Radiated Spurious Emission

Test place	Ise EMC Lab.
Semi Anechoic Chamber	No.3
Date	March 27, 2022
Temperature / Humidity	22 deg. C / 30 % RH
Engineer	Junki Nagatomi (1 GHz - 10 GHz)
Mode	Tx 11n-40 2427 MHz

Polarity	Frequency	Reading (QP / PK)	Reading (AV)	Ant. Factor	Loss	Gain	Duty Factor	Result (QP / PK)	Result (AV)	Limit (QP / PK)	Limit (AV)	Margin (QP / PK)	Margin (AV)	Remark
[Hori/Vert]	[MHz]	[dBuV]	[dBuV]	[dB/m]	[dB]	[dB]	[dB]	[dBuV/m]	[dBuV/m]	[dBuV/m]	[dBuV/m]	[dB]	[dB]	
Hori.	2390.0	63.0	49.9	27.6	5.7	32.9	-	63.3	50.2	73.9	53.9	10.6	3.7	
Vert.	2390.0	64.5	51.0	27.6	5.7	32.9	-	64.8	51.3	73.9	53.9	9.1	2.6	

Result = Reading + Ant Factor + Loss (Cable+Attenuator+Filter+Distance factor(above 1 GHz)) - Gain(Amplifier)

*Other frequency noises omitted in this report were not seen or had enough margin (more than 20 dB).

*QP detector was used up to 1GHz.

Distance factor: 1 GHz - 10 GHz $20\log(3.95\text{ m} / 3.0\text{ m}) = 2.39\text{ dB}$
 10 GHz - 26.5 GHz $20\log(1.0\text{ m} / 3.0\text{ m}) = -9.5\text{ dB}$

Radiated Spurious Emission (Reference Plot for band-edge)

Test place Ise EMC Lab.
Semi Anechoic Chamber No.3
Date March 27, 2022
Temperature / Humidity 22 deg. C / 30 % RH
Engineer Junki Nagatomi
 (1 GHz - 10 GHz)
Mode Tx 11n-40 2427 MHz

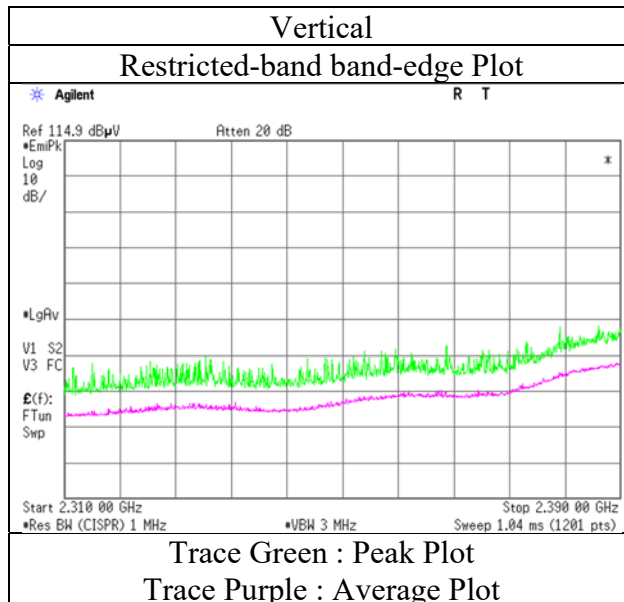
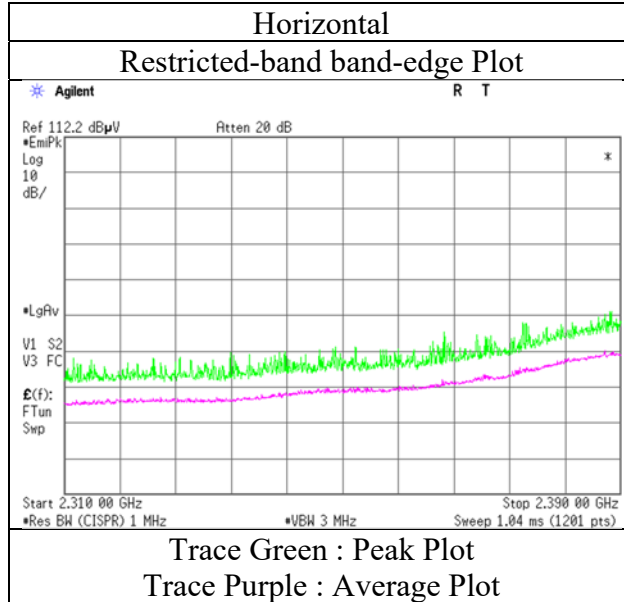

* The measurement was conducted for a sufficiently long enough time to detect any possible spurious emissions. Final result of restricted band edge was shown in tabular data.

Radiated Spurious Emission

Test place	Ise EMC Lab.	
Semi Anechoic Chamber	No.3	No.4
Date	March 27, 2022	April 14, 2022
Temperature / Humidity	22 deg. C / 30 % RH	21 deg. C / 59 % RH
Engineer	Junki Nagatomi	Nachi Konegawa
	(1 GHz - 10 GHz)	(Above 10 GHz)
Mode	Tx 11n-40 2432 MHz	

Polarity [Hori/Vert]	Frequency [MHz]	Reading (QP / PK) [dBuV]	Reading (AV) [dBuV]	Ant. Factor [dB/m]	Loss [dB]	Gain [dB]	Duty Factor [dB]	Result (QP / PK) [dBuV/m]	Result (AV) [dBuV/m]	Limit (QP / PK) [dBuV/m]	Limit (AV) [dBuV/m]	Margin (QP / PK) [dB]	Margin (AV) [dB]	Remark
Hori.	2390.0	63.8	50.0	27.6	5.7	32.9	-	64.1	50.4	73.9	53.9	9.8	3.5	
Hori.	4864.0	40.6	31.0	31.5	8.0	32.0	-	48.2	38.6	73.9	53.9	25.7	15.3	Floor noise
Hori.	7296.0	41.7	31.2	35.8	9.6	32.8	-	54.3	43.8	73.9	53.9	19.6	10.1	Floor noise
Hori.	9728.0	40.9	31.1	39.1	10.2	33.6	-	56.6	46.8	73.9	53.9	17.3	7.1	Floor noise
Vert.	2390.0	66.7	51.6	27.6	5.7	32.9	-	67.1	51.9	73.9	53.9	6.8	2.0	
Vert.	4864.0	41.1	31.0	31.5	8.0	32.0	-	48.7	38.6	73.9	53.9	25.2	15.3	Floor noise
Vert.	7296.0	42.1	31.2	35.8	9.6	32.8	-	54.6	43.8	73.9	53.9	19.3	10.1	Floor noise
Vert.	9728.0	41.9	31.1	39.1	10.2	33.6	-	57.6	46.8	73.9	53.9	16.3	7.1	Floor noise

Result = Reading + Ant Factor + Loss (Cable+Attenuator+Filter+Distance factor(above 1 GHz)) - Gain(Amplifier)

*Other frequency noises omitted in this report were not seen or had enough margin (more than 20 dB).

*QP detector was used up to 1GHz.

Distance factor: 1 GHz - 10 GHz 20log(3.95 m / 3.0 m) = 2.39 dB
 10 GHz - 26.5 GHz 20log(1.0 m / 3.0 m) = -9.5 dB

Radiated Spurious Emission

Test place	Ise EMC Lab.	
Semi Anechoic Chamber	No.3	No.4
Date	March 27, 2022	April 14, 2022
Temperature / Humidity	22 deg. C / 30 % RH	21 deg. C / 59 % RH
Engineer	Junki Nagatomi (1 GHz - 10 GHz)	Nachi Konegawa (Above 10 GHz)
Mode	Tx 11n-40 2437 MHz	

Polarity [Hori/Vert]	Frequency [MHz]	Reading (QP / PK) [dBuV]	Reading (AV) [dBuV]	Ant. Factor [dB/m]	Loss [dB]	Gain [dB]	Duty Factor [dB]	Result (QP / PK) [dBuV/m]	Result (AV) [dBuV/m]	Limit (QP / PK) [dBuV/m]	Limit (AV) [dBuV/m]	Margin (QP / PK) [dB]	Margin (AV) [dB]	Remark
Hori.	4874.0	40.7	30.6	31.5	8.0	32.0	-	48.3	38.2	73.9	53.9	25.6	15.7	Floor noise
Hori.	7311.0	41.6	31.8	35.9	9.6	32.8	-	54.2	44.4	73.9	53.9	19.7	9.5	Floor noise
Hori.	9748.0	41.0	31.1	39.1	10.2	33.6	-	56.8	46.9	73.9	53.9	17.2	7.0	Floor noise
Vert.	4874.0	40.2	30.6	31.5	8.0	32.0	-	47.9	38.2	73.9	53.9	26.0	15.7	Floor noise
Vert.	7311.0	41.0	31.8	35.9	9.6	32.8	-	53.6	44.4	73.9	53.9	20.3	9.5	Floor noise
Vert.	9748.0	40.9	31.1	39.1	10.2	33.6	-	56.6	46.9	73.9	53.9	17.3	7.0	Floor noise

Result = Reading + Ant Factor + Loss (Cable+Attenuator+Filter+Distance factor(above 1 GHz)) - Gain(Amplifier)

*Other frequency noises omitted in this report were not seen or had enough margin (more than 20 dB).

*QP detector was used up to 1GHz.

Distance factor: 1 GHz - 10 GHz $20\log(3.95\text{ m} / 3.0\text{ m}) = 2.39\text{ dB}$
 10 GHz - 26.5 GHz $20\log(1.0\text{ m} / 3.0\text{ m}) = -9.5\text{ dB}$

Radiated Spurious Emission

Test place	Ise EMC Lab.
Semi Anechoic Chamber	No.3
Date	March 27, 2022
Temperature / Humidity	22 deg. C / 30 % RH
Engineer	Junki Nagatomi (1 GHz - 10 GHz)
Mode	Tx 11n-40 2447 MHz

Polarity [Hori/Vert]	Frequency [MHz]	Reading (QP / PK) [dBuV]	Reading (AV) [dBuV]	Ant. Factor [dB/m]	Loss [dB]	Gain [dB]	Duty Factor [dB]	Result (QP / PK) [dBuV/m]	Result (AV) [dBuV/m]	Limit (QP / PK) [dBuV/m]	Limit (AV) [dBuV/m]	Margin (QP / PK) [dB]	Margin (AV) [dB]	Remark
Hori.	2483.5	65.8	52.5	27.4	5.7	32.9	-	66.1	52.8	73.9	53.9	7.8	1.1	
Vert.	2483.5	71.5	53.4	27.4	5.7	32.9	-	71.8	53.7	73.9	53.9	2.1	0.2	

Result = Reading + Ant Factor + Loss (Cable+Attenuator+Filter+Distance factor(above 1 GHz)) - Gain(Amplifier)

*Other frequency noises omitted in this report were not seen or had enough margin (more than 20 dB).

*QP detector was used up to 1GHz.

Distance factor: 1 GHz - 10 GHz $20\log(3.95\text{ m} / 3.0\text{ m}) = 2.39\text{ dB}$
 10 GHz - 26.5 GHz $20\log(1.0\text{ m} / 3.0\text{ m}) = -9.5\text{ dB}$

Radiated Spurious Emission (Reference Plot for band-edge)

Test place Ise EMC Lab.
Semi Anechoic Chamber No.3
Date March 27, 2022
Temperature / Humidity 22 deg. C / 30 % RH
Engineer Junki Nagatomi
 (1 GHz - 10 GHz)
Mode Tx 11n-40 2447MHz

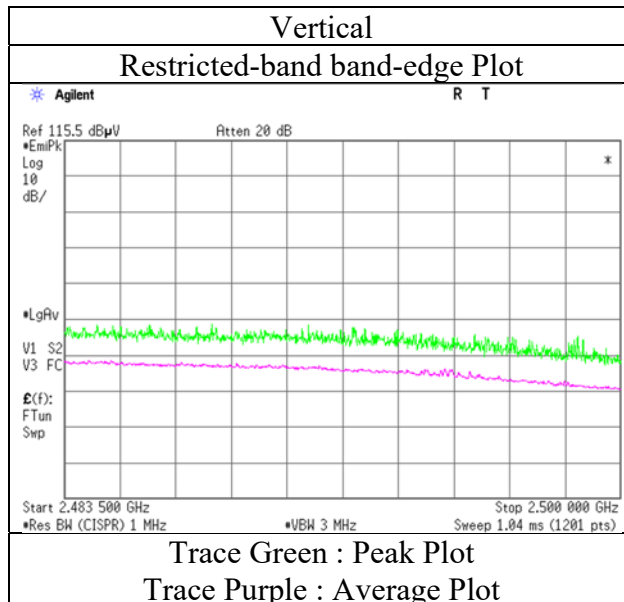
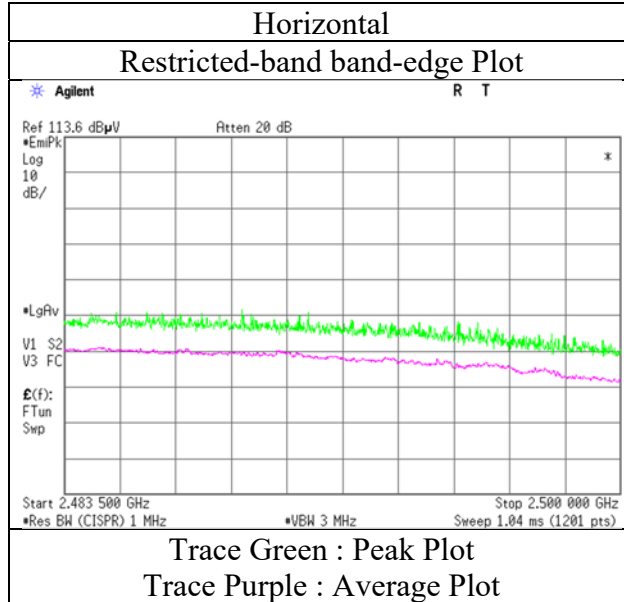

* The measurement was conducted for a sufficiently long enough time to detect any possible spurious emissions. Final result of restricted band edge was shown in tabular data.

Radiated Spurious Emission

Test place	Ise EMC Lab.	
Semi Anechoic Chamber	No.3	No.4
Date	March 27, 2022	April 14, 2022
Temperature / Humidity	22 deg. C / 30 % RH	21 deg. C / 59 % RH
Engineer	Junki Nagatomi	Nachi Konegawa
	(1 GHz - 10 GHz)	(Above 10 GHz)
Mode	Tx 11n-40 2452 MHz	

Polarity [Hori/Vert]	Frequency [MHz]	Reading (QP / PK) [dBuV]	Reading (AV) [dBuV]	Ant. Factor [dB/m]	Loss [dB]	Gain [dB]	Duty Factor [dB]	Result (QP / PK) [dBuV/m]	Result (AV) [dBuV/m]	Limit (QP / PK) [dBuV/m]	Limit (AV) [dBuV/m]	Margin (QP / PK) [dB]	Margin (AV) [dB]	Remark
Hori.	2483.5	65.8	51.0	27.4	5.7	32.9	-	66.1	51.3	73.9	53.9	7.8	2.6	
Hori.	4904.0	40.3	30.4	31.6	8.1	31.9	-	48.0	38.1	73.9	53.9	25.9	15.8	Floor noise
Hori.	7356.0	41.7	30.8	36.0	9.6	32.8	-	54.4	43.5	73.9	53.9	19.5	10.4	Floor noise
Hori.	9808.0	41.3	31.3	39.2	10.3	33.6	-	57.1	47.1	73.9	53.9	16.8	6.8	Floor noise
Vert.	2483.5	66.7	51.5	27.4	5.7	32.9	-	67.0	51.8	73.9	53.9	6.9	2.1	
Vert.	4904.0	41.0	30.4	31.6	8.1	31.9	-	48.7	38.1	73.9	53.9	25.3	15.8	Floor noise
Vert.	7356.0	41.6	30.8	36.0	9.6	32.8	-	54.3	43.5	73.9	53.9	19.6	10.4	Floor noise
Vert.	9808.0	42.3	31.2	39.2	10.3	33.6	-	58.1	47.1	73.9	53.9	15.8	6.8	Floor noise

Result = Reading + Ant Factor + Loss (Cable+Attenuator+Filter+Distance factor(above 1 GHz)) - Gain(Amplifier)

*Other frequency noises omitted in this report were not seen or had enough margin (more than 20 dB).

*QP detector was used up to 1GHz.

Distance factor: 1 GHz - 10 GHz 20log(3.95 m / 3.0 m) = 2.39 dB
 10 GHz - 26.5 GHz 20log(1.0 m / 3.0 m) = -9.5 dB

Radiated Spurious Emission (Reference Plot for band-edge)

Test place Ise EMC Lab.
Semi Anechoic Chamber No.3
Date March 27, 2022
Temperature / Humidity 22 deg. C / 30 % RH
Engineer Junki Nagatomi
 (1 GHz - 10 GHz)
Mode Tx 11n-40 2452 MHz

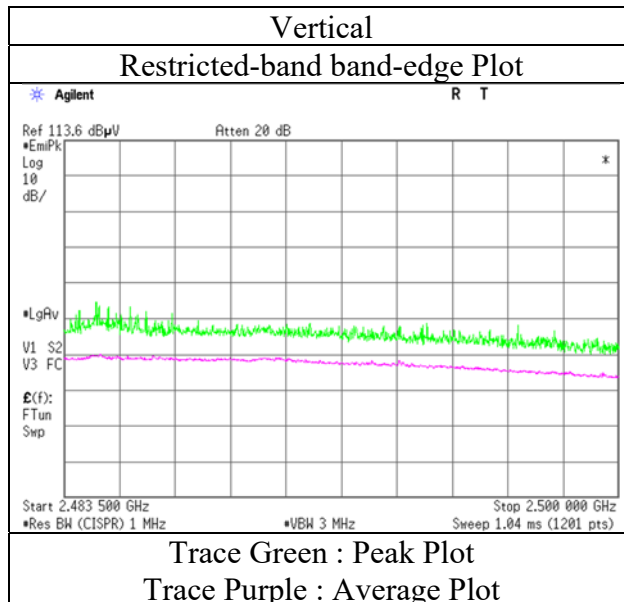
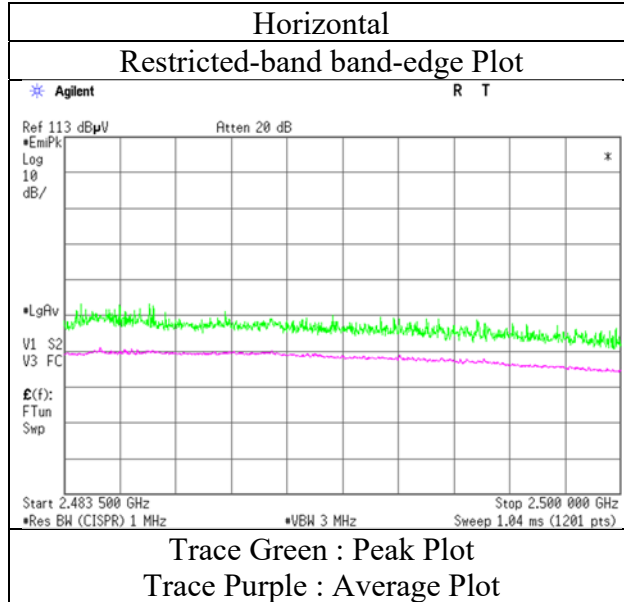

* The measurement was conducted for a sufficiently long enough time to detect any possible spurious emissions. Final result of restricted band edge was shown in tabular data.

Radiated Spurious Emission

Test place	Ise EMC Lab.	
Semi Anechoic Chamber	No.4	No.4
Date	January 25, 2022	January 27, 2022
Temperature / Humidity	19 deg. C / 30 % RH	20 deg. C / 31 % RH
Engineer	Junki Nagatomi	Yuichiro Yamazaki
	(1 GHz - 10 GHz)	(Above 10 GHz)
Mode	Tx BT LE 2402 MHz	

Polarity	Frequency	Reading (QP / PK)	Reading (AV)	Ant. Factor	Loss	Gain	Duty Factor	Result (QP / PK)	Result (AV)	Limit (QP / PK)	Limit (AV)	Margin (QP / PK)	Margin (AV)	Remark
[Hori/Vert]	[MHz]	[dBuV]	[dBuV]	[dB/m]	[dB]	[dB]	[dB]	[dBuV/m]	[dBuV/m]	[dBuV/m]	[dBuV/m]	[dB]	[dB]	
Hori.	2390.0	45.7	34.2	27.8	5.4	31.7	1.7	47.1	37.3	73.9	53.9	26.8	16.6	*1)
Hori.	4804.0	42.1	32.8	31.6	7.6	30.9	-	50.5	41.2	73.9	53.9	23.5	12.7	Floor noise
Hori.	7206.0	42.3	33.5	36.2	8.8	31.9	-	55.2	46.5	73.9	53.9	18.7	7.4	Floor noise
Hori.	9608.0	41.5	32.4	38.0	9.7	32.3	-	56.9	47.9	73.9	53.9	17.0	6.0	Floor noise
Hori.	10440.0	43.1	32.9	39.7	-3.4	32.5	-	46.8	36.6	73.9	53.9	27.1	17.3	
Hori.	20880.0	50.6	46.5	37.9	-1.8	32.6	-	54.1	50.0	73.9	53.9	19.8	3.9	
Vert.	2390.0	46.6	34.3	27.8	5.4	31.7	1.7	48.1	37.4	73.9	53.9	25.9	16.5	*1)
Vert.	4804.0	42.0	32.8	31.6	7.6	30.9	-	50.4	41.2	73.9	53.9	23.5	12.7	Floor noise
Vert.	7206.0	42.7	33.5	36.2	8.8	31.9	-	55.7	46.5	73.9	53.9	18.2	7.4	Floor noise
Vert.	9608.0	41.6	32.4	38.0	9.7	32.3	-	57.1	47.9	73.9	53.9	16.8	6.0	Floor noise
Vert.	10440.0	42.6	32.1	39.7	-3.4	32.5	-	46.3	35.9	73.9	53.9	27.6	18.0	
Vert.	20880.0	49.6	45.5	37.9	-1.8	32.6	-	53.1	49.0	73.9	53.9	20.8	4.9	

Result (QP / PK) = Reading + Ant Factor + Loss (Cable+Attenuator+Filter+Distance factor(above 1 GHz)) - Gain(Amplifier)

Result (AV) = Reading + Ant Factor + Loss (Cable+Attenuator+Filter+Distance factor(above 1 GHz)) - Gain(Amplifier) + Duty factor

*Other frequency noises omitted in this report were not seen or had enough margin (more than 20 dB).

*QP detector was used up to 1GHz.

*1) Not Out of Band emission(Leakage Power)

20dBc Data Sheet

Polarity	Frequency	Reading (PK)	Ant Factor	Loss	Gain	Result	Limit	Margin	Remark
[Hori/Vert]	[MHz]	[dBuV]	[dB/m]	[dB]	[dB]	[dBuV/m]	[dBuV/m]	[dB]	
Hori.	2402.0	96.1	27.8	5.4	31.7	97.5	-	-	Carrier
Hori.	2400.0	42.0	27.8	5.4	31.7	43.5	77.5	34.1	
Hori.	6960.0	39.0	35.4	8.7	31.8	51.3	77.5	26.2	
Vert.	2402.0	96.3	27.8	5.4	31.7	97.8	-	-	Carrier
Vert.	2400.0	41.8	27.8	5.4	31.7	43.3	77.8	34.5	
Vert.	6960.0	38.1	35.4	8.7	31.8	50.5	77.8	27.3	

Result = Reading + Ant Factor + Loss (Cable+Attenuator+Filter+Distance factor(above 1 GHz)) - Gain(Amplifier)

Distance factor: 1 GHz - 10 GHz 20log(3.95 m / 3.0 m) = 2.39 dB

10 GHz - 26.5 GHz 20log(1.0 m / 3.0 m) = -9.5 dB

Radiated Spurious Emission (Reference Plot for band-edge)

Test place	Ise EMC Lab.
Semi Anechoic Chamber	No.4
Date	January 25, 2022
Temperature / Humidity	19 deg. C / 30 % RH
Engineer	Junki Nagatomi
	(1 GHz - 10 GHz)
Mode	Tx BT LE 2402 MHz

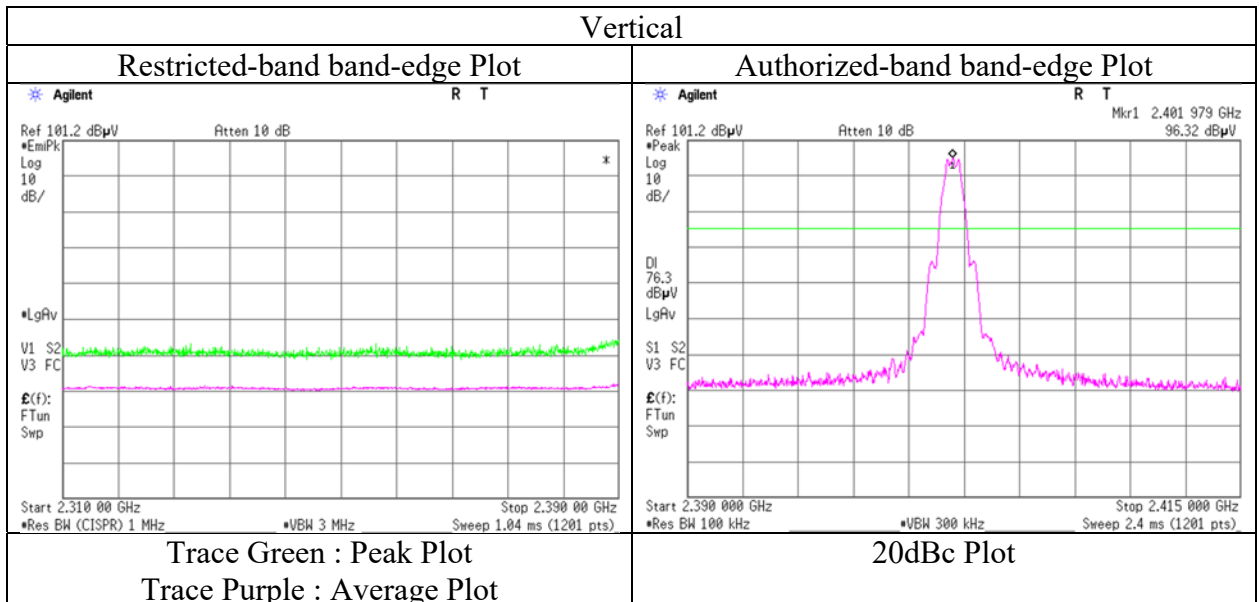
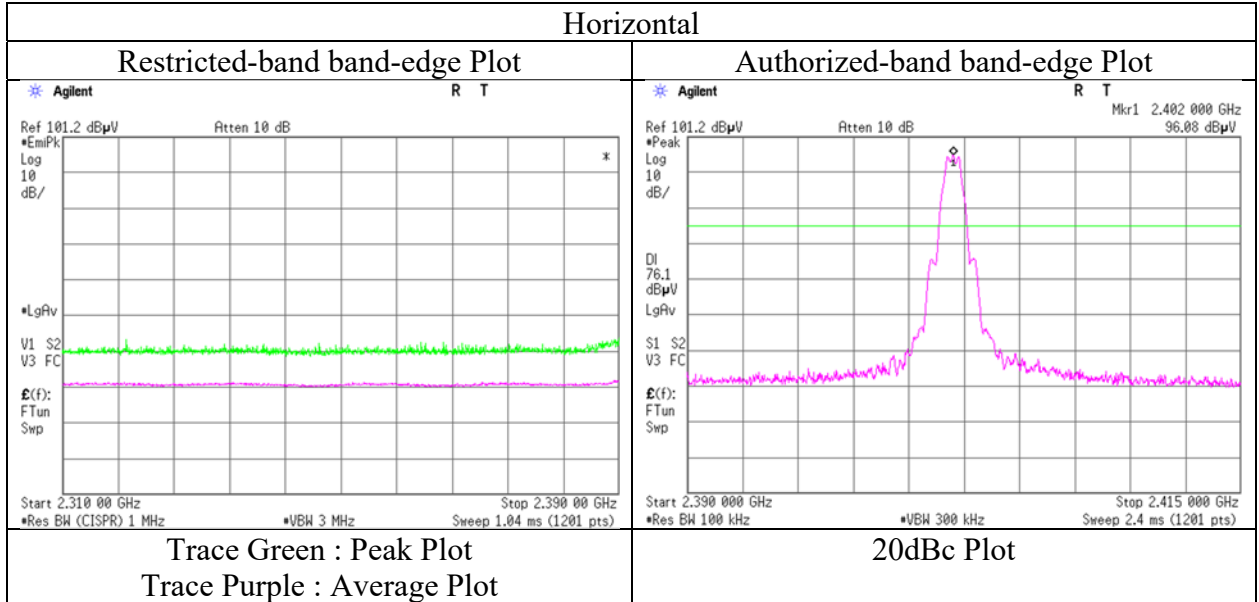

* The measurement was conducted for a sufficiently long enough time to detect any possible spurious emissions. Final result of restricted band edge was shown in tabular data.

Radiated Spurious Emission

Test place	Ise EMC Lab.	
Semi Anechoic Chamber	No.4	No.4
Date	January 25, 2022	January 27, 2022
Temperature / Humidity	19 deg. C / 30 % RH	20 deg. C / 31 % RH
Engineer	Junki Nagatomi	Yuichiro Yamazaki
	(1 GHz - 10 GHz)	(Above 10 GHz)
Mode	Tx BT LE 2440 MHz	

Polarity	Frequency	Reading (QP / PK)	Reading (AV)	Ant. Factor	Loss	Gain	Duty Factor	Result (QP / PK)	Result (AV)	Limit (QP / PK)	Limit (AV)	Margin (QP / PK)	Margin (AV)	Remark
[Hori/Vert]	[MHz]	[dBuV]	[dBuV]	[dB/m]	[dB]	[dB]	[dB]	[dBuV/m]	[dBuV/m]	[dBuV/m]	[dBuV/m]	[dB]	[dB]	
Hori.	4880.0	42.1	31.8	31.6	7.7	30.9	-	50.5	40.2	73.9	53.9	23.4	13.7	Floor noise
Hori.	7320.0	42.3	33.3	36.3	8.8	32.0	-	55.3	46.3	73.9	53.9	18.6	7.6	Floor noise
Hori.	9760.0	41.4	31.9	38.4	9.7	32.3	-	57.2	47.7	73.9	53.9	16.7	6.2	Floor noise
Hori.	10440.0	43.3	33.0	39.7	-3.4	32.5	-	47.0	36.8	73.9	53.9	26.9	17.1	
Hori.	20880.0	50.6	46.8	37.9	-1.8	32.6	-	54.2	50.3	73.9	53.9	19.8	3.6	
Vert.	4880.0	41.0	31.8	31.6	7.7	30.9	-	49.4	40.2	73.9	53.9	24.5	13.7	Floor noise
Vert.	7320.0	42.3	33.3	36.3	8.8	32.0	-	55.3	46.3	73.9	53.9	18.6	7.6	Floor noise
Vert.	9760.0	41.4	31.9	38.4	9.7	32.3	-	57.2	47.7	73.9	53.9	16.7	6.2	Floor noise
Vert.	10440.0	42.7	32.2	39.7	-3.4	32.5	-	46.4	36.0	73.9	53.9	27.5	17.9	
Vert.	20880.0	50.1	45.6	37.9	-1.8	32.6	-	53.6	49.1	73.9	53.9	20.3	4.8	

Result (QP / PK) = Reading + Ant Factor + Loss (Cable+Attenuator+Filter+Distance factor(above 1 GHz)) - Gain(Amplifier)

Result (AV)= Reading + Ant Factor + Loss (Cable+Attenuator+Filter+Distance factor(above 1 GHz)) - Gain(Amplifier) + Duty factor

*Other frequency noises omitted in this report were not seen or had enough margin (more than 20 dB).

*QP detector was used up to 1GHz.

20dBc Data Sheet

Polarity	Frequency	Reading (PK)	Ant Factor	Loss	Gain	Result	Limit	Margin	Remark
[Hori/Vert]	[MHz]	[dBuV]	[dB/m]	[dB]	[dB]	[dBuV/m]	[dBuV/m]	[dB]	
Hori.	2440.0	95.3	27.7	5.4	31.7	96.7	-	-	Carrier
Hori.	6960.0	38.9	35.4	8.7	31.8	51.3	76.7	25.5	
Vert.	2440.0	96.6	27.7	5.4	31.7	98.0	-	-	Carrier
Vert.	6960.0	38.0	35.4	8.7	31.8	50.4	78.0	27.6	

Result = Reading + Ant Factor + Loss (Cable+Attenuator+Filter+Distance factor(above 1 GHz)) - Gain(Amplifier)

Distance factor: 1 GHz - 10 GHz 20log(3.95 m / 3.0 m) = 2.39 dB

10 GHz - 26.5 GHz 20log(1.0 m / 3.0 m) = -9.5 dB

Radiated Spurious Emission

Test place	Ise EMC Lab.		
Semi Anechoic Chamber	No.4	No.4	No.4
Date	January 25, 2022	January 27, 2022	April 19, 2022
Temperature / Humidity	19 deg. C / 30 % RH	20 deg. C / 31 % RH	24 deg. C / 34 % RH
Engineer	Junki Nagatomi (1 GHz - 10 GHz)	Yuichiro Yamazaki (Above 10 GHz)	Junya Okuno (Below 1 GHz)
Mode	Tx BT LE 2480 MHz		

Polarity [Hori/Vert]	Frequency [MHz]	Reading (QP / PK) [dBuV]	Reading (AV) [dBuV]	Ant. Factor [dB/m]	Loss [dB]	Gain [dB]	Duty Factor [dB]	Result (QP / PK) [dBuV/m]	Result (AV) [dBuV/m]	Limit (QP / PK) [dBuV/m]	Limit (AV) [dBuV/m]	Margin (QP / PK) [dB]	Margin (AV) [dB]	Remark
Hori.	219.8	34.4	-	11.5	8.8	32.0	-	22.7	-	46.0	-	23.3	-	
Hori.	233.2	34.2	-	11.7	8.9	32.0	-	22.8	-	46.0	-	23.2	-	
Hori.	287.1	29.5	-	13.7	9.3	32.0	-	20.5	-	46.0	-	25.5	-	
Hori.	334.0	36.5	-	14.9	9.6	32.1	-	29.0	-	46.0	-	17.0	-	
Hori.	360.0	39.1	-	15.2	9.8	32.1	-	32.0	-	46.0	-	14.0	-	
Hori.	477.5	33.8	-	17.2	10.6	32.2	-	29.4	-	46.0	-	16.6	-	
Hori.	2483.5	53.6	37.9	27.7	5.5	31.7	1.7	55.0	41.1	73.9	53.9	18.9	12.8	*1)
Hori.	4960.0	40.5	31.9	31.7	7.7	30.8	-	49.1	40.4	73.9	53.9	24.8	13.5	Floor noise
Hori.	7440.0	42.5	33.9	36.5	8.7	32.1	-	55.6	47.1	73.9	53.9	18.3	6.9	Floor noise
Hori.	9920.0	42.1	31.9	38.6	9.8	32.4	-	58.1	47.9	73.9	53.9	15.9	6.0	Floor noise
Hori.	10440.0	42.8	33.0	39.7	-3.4	32.5	-	46.5	36.7	73.9	53.9	27.4	17.2	
Hori.	20880.0	50.6	46.3	37.9	-1.8	32.6	-	54.1	49.8	73.9	53.9	19.8	4.1	
Vert.	49.5	40.8	-	11.3	7.3	32.1	-	27.3	-	40.0	-	12.7	-	
Vert.	69.6	42.2	-	6.4	7.5	32.1	-	24.0	-	40.0	-	16.0	-	
Vert.	91.7	43.1	-	8.9	7.8	32.1	-	27.7	-	43.5	-	15.8	-	
Vert.	102.6	42.0	-	10.7	7.9	32.1	-	28.5	-	43.5	-	15.0	-	
Vert.	161.9	32.8	-	15.5	8.4	32.0	-	24.7	-	43.5	-	18.8	-	
Vert.	477.5	34.3	-	17.2	10.6	32.2	-	29.9	-	46.0	-	16.1	-	
Vert.	2483.5	53.2	39.0	27.7	5.5	31.7	1.7	54.7	42.1	73.9	53.9	19.2	11.8	*1)
Vert.	4960.0	41.7	31.9	31.7	7.7	30.8	-	50.3	40.4	73.9	53.9	23.6	13.5	Floor noise
Vert.	7440.0	42.3	33.9	36.5	8.7	32.1	-	55.4	47.1	73.9	53.9	18.5	6.9	Floor noise
Vert.	9920.0	42.2	31.9	38.6	9.8	32.4	-	58.1	47.9	73.9	53.9	15.8	6.0	Floor noise
Vert.	10440.0	42.5	32.2	39.7	-3.4	32.5	-	46.2	36.0	73.9	53.9	27.7	17.9	
Vert.	20880.0	49.8	45.3	37.9	-1.8	32.6	-	53.3	48.9	73.9	53.9	20.6	5.1	

Result (QP / PK) = Reading + Ant Factor + Loss (Cable+Attenuator+Filter+Distance factor(above 1 GHz)) - Gain(Amplifier)

Result (AV)= Reading + Ant Factor + Loss (Cable+Attenuator+Filter+Distance factor(above 1 GHz)) - Gain(Amplifier) + Duty factor

*Other frequency noises omitted in this report were not seen or had enough margin (more than 20 dB).

*QP detector was used up to 1GHz.

*1) Not Out of Band emission(Leakage Power)

Distance factor: 1 GHz - 10 GHz 20log(3.95 m / 3.0 m) = 2.39 dB
 10 GHz - 26.5 GHz 20log(1.0 m / 3.0 m) = -9.5 dB

Radiated Spurious Emission (Reference Plot for band-edge)

Test place Ise EMC Lab.
Semi Anechoic Chamber No.4
Date January 25, 2022
Temperature / Humidity 19 deg. C / 30 % RH
Engineer Junki Nagatomi
 (1 GHz - 10 GHz)
Mode Tx BT LE 2480 MHz

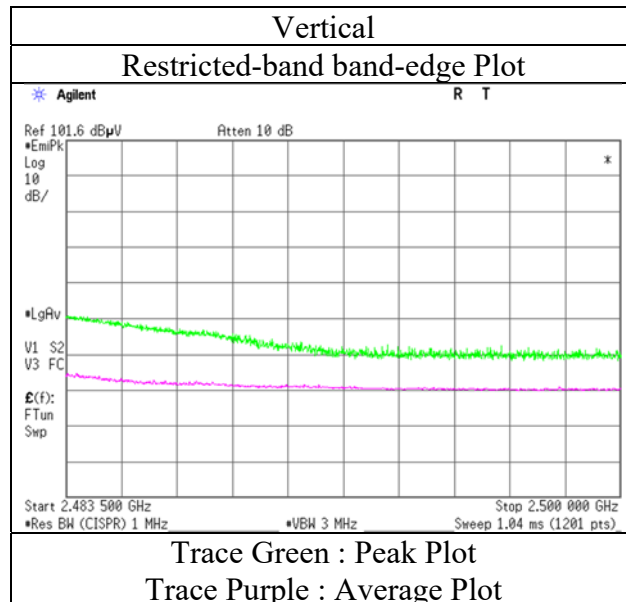
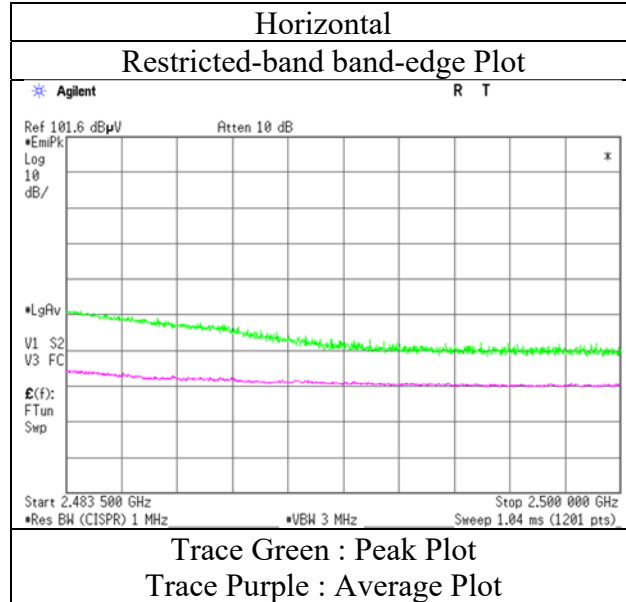

* The measurement was conducted for a sufficiently long enough time to detect any possible spurious emissions. Final result of restricted band edge was shown in tabular data.

Radiated Spurious Emission
(Plot data, Worst case mode for Maximum Peak Output Power)

Test place	Ise EMC Lab.	No.4	No.4
Semi Anechoic Chamber	No.3	April 14, 2022	April 19, 2022
Date	March 25, 2022	21 deg. C / 59 % RH	21 deg. C / 43 % RH
Temperature / Humidity	21 deg. C / 37 % RH	Nachi Konegawa	Kouki Yamada
Engineer	Takafumi Noguchi	(Above 10 GHz)	(Below 1 GHz)
Mode	Tx 11n-20 2437 MHz		

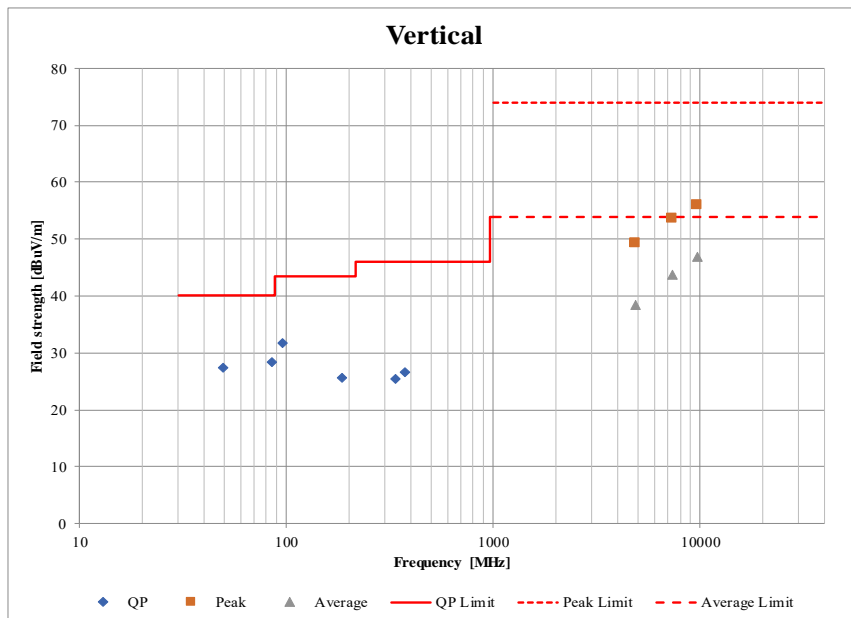
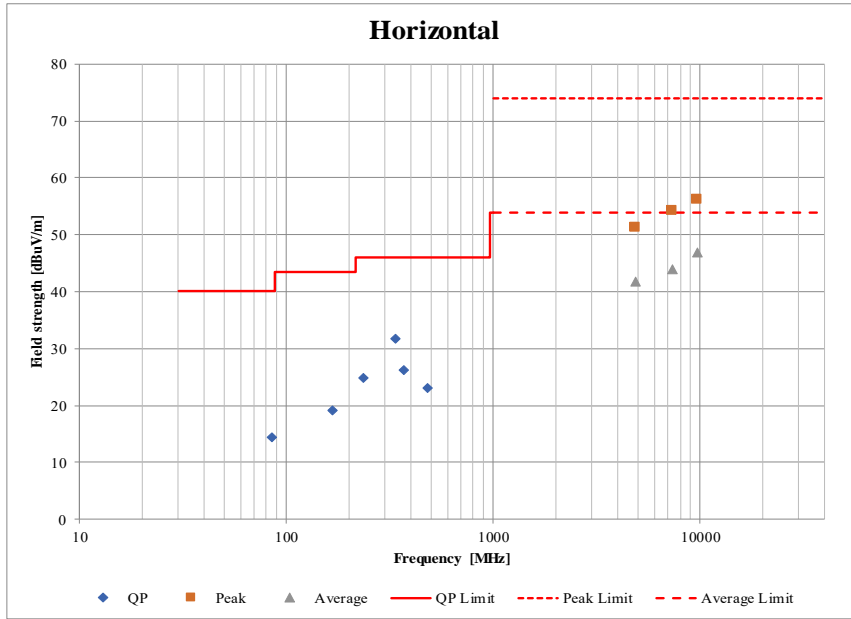

*These plots data contains sufficient number to show the trend of characteristic features for EUT.

Radiated Spurious Emission (Plot data, Worst case mode for Maximum Peak Output Power)

Test place	Ise EMC Lab.	No.4	No.4
Semi Anechoic Chamber	No.4	January 27, 2022	April 19, 2022
Date	January 25, 2022	20 deg. C / 31 % RH	24 deg. C / 34 % RH
Temperature / Humidity	19 deg. C / 30 % RH	Yuichiro Yamazaki	Junya Okuno
Engineer	Junki Nagatomi	(Above 10 GHz)	(Below 1 GHz)
Mode	(1 GHz - 10 GHz) Tx BT LE 2480 MHz		

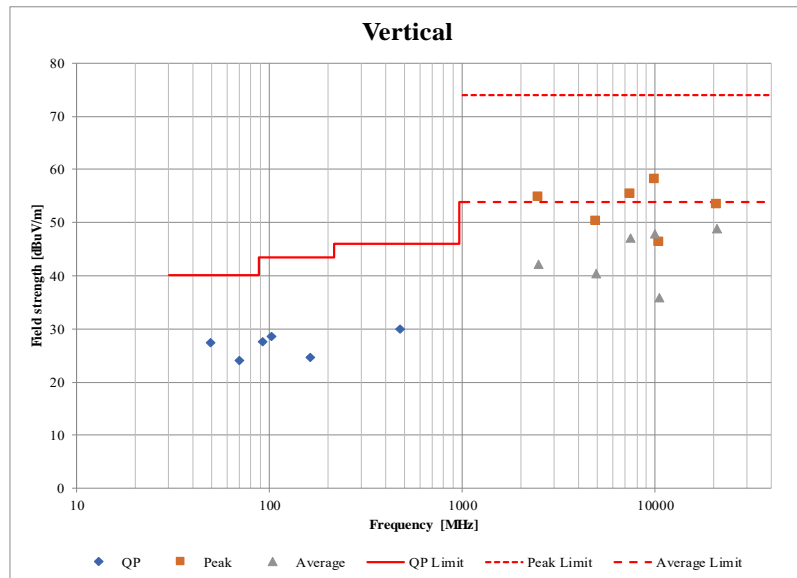
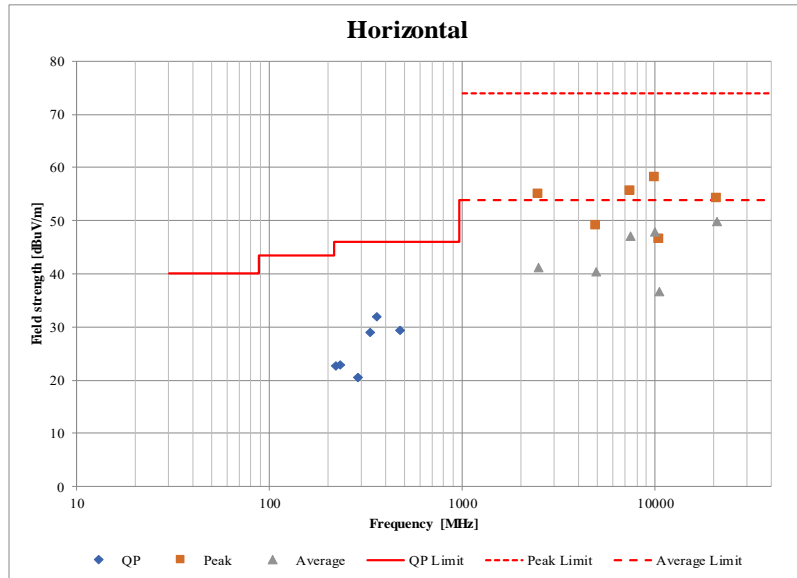

*These plots data contains sufficient number to show the trend of characteristic features for EUT.

APPENDIX 2: Test Instruments

Test Equipment

Test Item	Local ID	LIMS ID	Description	Manufacturer	Model	Serial	Last Calibration Date	Cal Int
RE	COTS-MEMI-02	178648	EMI measurement program	TSJ (Techno Science Japan)	TEPTO-DV	-	-	-
RE	MAEC-03	142008	AC3_Semi Anechoic Chamber(NSA)	TDK	Semi Anechoic Chamber 3m	DA-10005	05/22/2020	24
RE	MAEC-03-SVSWR	142013	AC3_Semi Anechoic Chamber(SVSWR)	TDK	Semi Anechoic Chamber 3m	DA-10005	04/01/2021	24
RE	MAEC-04	142011	AC4_Semi Anechoic Chamber(NSA)	TDK	Semi Anechoic Chamber 3m	DA-10005	05/25/2020	24
RE	MAT-34	141331	Attenuator(6dB)	TME	UFA-01	-	02/25/2022	12
RE	MBA-05	141425	Biconical Antenna	Schwarzbeck Mess-Elektronik OHG	VHA9103+ BBA9106	VHA 91031302	08/28/2021	12
RE	MCC-231	177964	Microwave Cable	Junkosha INC.	MMX221	1901S329(1m) / 1902S579(5m)	03/15/2022	12
RE	MCC-257	208936	Microwave Cable	Huber+Suhner	SF126E/11PC35/11PC35/1000M,5000M	537061/126E / 537076/126E	07/18/2021	12
RE	MCC-50	141397	Coaxial Cable	UL Japan	-	-	11/03/2021	12
RE	MHA-17	141506	Horn Antenna 15-40GHz	Schwarzbeck Mess-Elektronik OHG	BBHA9170	BBHA9170307	07/20/2021	12
RE	MHA-20	141507	Horn Antenna 1-18GHz	Schwarzbeck Mess-Elektronik OHG	BBHA9120D	258	11/09/2021	12
RE	MHA-21	141508	Horn Antenna 1-18GHz	Schwarzbeck Mess-Elektronik OHG	BBHA9120D	557	05/10/2021	12
RE	MHF-06	141404	High Pass Filter 3.5-24GHz	TOKIMEC	TF323DCA	601	05/18/2021	12
RE	MHF-25	141232	High Pass Filter 3.5-18.0GHz	UL Japan	HPF SELECTOR	001	09/30/2021	12
RE	MHF-26	141296	High Pass Filter 3.5-18.0GHz	UL Japan	HPF SELECTOR	002	09/30/2021	12
RE	MJM-16	142183	Measure	KOMELON	KMC-36	-	-	-
RE	MJM-29	142230	Measure	KOMELON	KMC-36	-	-	-
RE	MLA-23	141267	Logperiodic Antenna (200-1000MHz)	Schwarzbeck Mess-Elektronik OHG	VUSLP9111B	9111B-192	08/28/2021	12
RE	MMM-08	141532	DIGITAL HiTESTER	HIOKI E.E. CORPORATION	3805	51201197	01/16/2022	12
RE	MMM-10	141545	DIGITAL HiTESTER	HIOKI E.E. CORPORATION	3805	51201148	01/16/2022	12
RE	MOS-13	141554	Thermo-Hygrometer	CUSTOM. Inc	CTH-201	1301	01/10/2022	12
RE	MOS-15	141562	Thermo-Hygrometer	CUSTOM. Inc	CTH-201	0010	01/10/2022	12
RE	MPA-11	141580	MicroWave System Amplifier	Keysight Technologies Inc	83017A	MY39500779	03/17/2022	12
RE	MPA-12	141581	MicroWave System Amplifier	Keysight Technologies Inc	83017A	00650	10/07/2021	12
RE	MPA-14	141583	Pre Amplifier	SONOMA INSTRUMENT	310	260833	04/04/2022	12
RE	MSA-14	141901	Spectrum Analyzer	Keysight Technologies Inc	E4440A	MY48250080	01/10/2022	12
RE	MSA-22	141978	Spectrum Analyzer	Keysight Technologies Inc	E4448A	MY46180899	03/24/2022	12
RE	MTR-03	141942	Test Receiver	Rohde & Schwarz	ESCI	100300	08/05/2021	12
AT	MOS-14	141561	Thermo-Hygrometer	CUSTOM. Inc	CTH-201	1401	01/10/2022	12
AT	MMM-18	141558	Digital Tester(TRUE RMS MULTIMETER)	Fluke Corporation	115	17930030	05/17/2022	12
AT	MJM-24	142225	Measure	ASKUL	-	-	-	-
AT	MAT-86	141366	Attenuator	Weinschel Associates	WA56-20	56200213	05/14/2021	12
AT	MPM-13	141810	Power Meter	Anritsu Corporation	ML2495A	824014	12/22/2021	12
AT	MPSE-18	141832	Power sensor	Anritsu Corporation	MA2411B	738174	12/22/2021	12
AT	MCC-208	141287	Microwave Cable	RS Pro	R-132G7210200CD	-	02/28/2022	12

*Hyphens for Last Calibration Date and Cal Int (month) are instruments that Calibration is not required (e.g. software), or instruments checked in advance before use.

The expiration date of the calibration is the end of the expired month.

As for some calibrations performed after the tested dates, those test equipment have been controlled by means of an unbroken chains of calibrations.

All equipment is calibrated with valid calibrations. Each measurement data is traceable to the national or international standards.

Test item: RE: Radiated Emission
 AT: Antenna Terminal Conducted test