



RADIO TEST REPORT

Test Report No. : 10604551H-B-R2

Applicant : **silex technology, Inc.**
Type of Equipment : **PCI Express Half mini card WLAN module**
Model No. : **SX-PCEAN2**
FCC ID : **N6C-SXPCEAN2**
Test regulation : **FCC Part 15 Subpart E: 2015**
Test Result : **Complied**

1. This test report shall not be reproduced in full or partial, without the written approval of UL Japan, Inc.
2. The results in this report apply only to the sample tested.
3. This sample tested is in compliance with above regulation.
4. The test results in this report are traceable to the national or international standards.
5. This test report must not be used by the customer to claim product certification, approval, or endorsement by NVLAP, NIST, or any agency of the Federal Government.
6. This test report covers Radio technical requirements. It does not cover administrative issues such as Manual or non-Radio test related Requirements. (if applicable)
7. This report is a revised version of 10604551H-B-R1. 10604551H-B-R1 is replaced with this report.

Date of test: February 20 to May 14, 2015

Representative test engineer: 
Kazuya Yoshioka
Engineer
Consumer Technology Division

Approved by: 
Takahiro Hatakeda
Leader
Consumer Technology Division

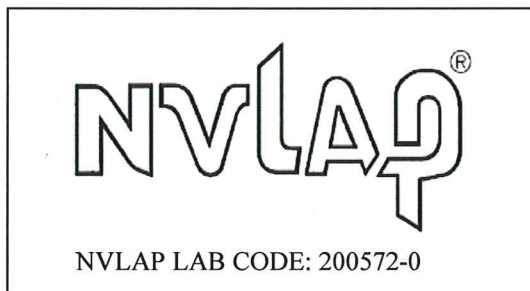

This laboratory is accredited by the NVLAP LAB CODE 200572-0, U.S.A. The tests reported herein have been performed in accordance with its terms of accreditation.
*As for the range of Accreditation in NVLAP, you may refer to the WEB address,
<http://www.ul.com/japan/jpn/pages/services/emc/about/mark1/index.jsp#nvlap>

- The testing in which "Non-accreditation" is displayed is outside the accreditation scopes in UL Japan.
 There is no testing item of "Non-accreditation".

UL Japan, Inc.
Ise EMC Lab.

4383-326 Asama-cho, Ise-shi, Mie-ken 516-0021 JAPAN
Telephone : +81 596 24 8999
Facsimile : +81 596 24 8124

CONTENTS	PAGE
SECTION 1: Customer information.....	4
SECTION 2: Equipment under test (E.U.T.).....	4
SECTION 3: Test specification, procedures & results.....	5
SECTION 4: Operation of E.U.T. during testing.....	8
SECTION 5: Conducted Emission.....	11
SECTION 6: Radiated Spurious Emission and Band Edge Compliance	12
SECTION 7: Antenna Terminal Conducted Tests.....	14
APPENDIX 1: Test data	15
Conducted Emission	15
26dB Emission Bandwidth and 99% Occupied Bandwidth.....	16
20dB Bandwidth	26
Maximum Conducted Output Power	33
Maximum Power Spectral Density	45
Radiated Spurious Emission	57
Conducted Spurious Emission	70
APPENDIX 2: Test instruments	71
APPENDIX 3: Photographs of test setup.....	73
Conducted Emission	73
Radiated Spurious Emission	74
Worst Case Position	75

UL Japan, Inc.

Ise EMC Lab.

4383-326 Asama-cho, Ise-shi, Mie-ken 516-0021 JAPAN

Telephone : +81 596 24 8999

Facsimile : +81 596 24 8124

SECTION 1: Customer information

Company Name : silex technology, Inc.
Address : 2-3-1 Hikaridai, Seika-cho, Kyoto 619-0237, Japan
Telephone Number : +81-774-98-3878
Facsimile Number : +81-774-98-3758
Contact Person : Toshiro Kometani

SECTION 2: Equipment under test (E.U.T.)

2.1 Identification of E.U.T.

Type of Equipment : PCI Express Half mini card WLAN module
Model No. : SX-PCEAN2
Serial No. : Refer to Clause 4.2
Rating : DC3.3V
Receipt Date of Sample : February 12, 2015
Country of Mass-production : Japan
Condition of EUT : Production prototype
(Not for Sale: This sample is equivalent to mass-produced items.)
Modification of EUT : No Modification by the test lab

2.2 Product Description

Model No: SX-PCEAN2 (referred to as the EUT in this report) is the PCI Express Half mini card WLAN module.

General Specification

Clock frequency(ies) in the system : 40MHz

Radio Specification

Radio Type : Transceiver
Method of Frequency Generation : Synthesizer
Power Supply (inner) : DC1.2V

Radio Specification

	IEEE802.11b	IEEE802.11g/n (20 M band)	IEEE802.11a/n (20 M band)	IEEE802.11n (40 M band)
Frequency of operation	2412-2462MHz	2412-2462MHz	5180-5240MHz *1) 5260-5320MHz *1) 5500-5700MHz *1) 5745-5825MHz	2422-2452MHz 5190-5230MHz *1) 5270-5310MHz *1) 5510-5670MHz *1) 5755-5795MHz
Type of modulation	DSSS (CCK, DQPSK, DBPSK)	OFDM-CCK (64QAM, 16QAM, QPSK, BPSK)	OFDM (64QAM, 16QAM, QPSK, BPSK)	
Channel spacing	5MHz		20MHz	2.4GHz: 5MHz 5GHz: 40MHz
Antenna type	WiFi Dual Band PCB antenna			
Antenna Gain	2.4GHz: 1.8dBi 5GHz: 3.9dBi			
Antenna Connector type	U.FL Alternative connector			

*1) 5180-5240MHz, 5190-5230MHz, 5270-5310MHz, 5260-5320MHz, 5500-5700MHz, and 5510-5670MHz are applied for this test report.

UL Japan, Inc.

Ise EMC Lab.

4383-326 Asama-cho, Ise-shi, Mie-ken 516-0021 JAPAN
Telephone : +81 596 24 8999
Facsimile : +81 596 24 8124

SECTION 3: Test specification, procedures & results

3.1 Test Specification

Test Specification : FCC Part 15 Subpart E: 2015, final revised on January 21, 2015
Title : FCC 47CFR Part15 Radio Frequency Device Subpart E
Unlicensed National Information Infrastructure Devices
Section 15.407 General technical requirements

3.2 Procedures and results

Item	Test Procedure	Specification	Worst margin	Results	Remarks
Conducted Emission	FCC :ANSI C63.4:2009	FCC: 15.407(b)(6) / 15.207	QP 21.8dB, 4.46340MHz, N AV 21.6dB, 4.46340MHz, N 4.48494MHz, L	Complied	-
	IC: RSS-Gen 8.8	IC: RSS-Gen 8.8			
26dB Emission Bandwidth	FCC :ANSI C63.4:2009, FCC KDB Publication Number 789033	FCC : 15.407(a)(1)(2)(3)	See data	N/A	Conducted
	IC: -	IC: -			
Maximum Conducted Output Power	FCC :ANSI C63.4:2009, FCC KDB Publication Number 789033	FCC : 15.407(a)(1)(2)(3)		Complied	Conducted
	IC: -	IC: RSS-210 A9.2(1)(2)(3)			
Maximum Power Spectral Density	FCC :ANSI C63.4:2009, FCC KDB Publication Number 789033	FCC : 15.407(a)(1)(2)(3)		Complied	Conducted
	IC: -	IC: RSS-210 A9.2(1)(2)(3)			
Spurious Emission Restricted Band Edge	FCC: ANSI C63.4:2009	FCC : 15.407(b), 15.205 and 15.209	2.8dB 5150.000MHz, AV, Vert.	Complied	Conducted (below 30MHz) / Radiated (above 30MHz) *1)
	IC: -	IC: RSS-210 A.9.2(1)(2)(3)			
20dB Emission Bandwidth	FCC :ANSI C63.4:2009	FCC : 15.215(c)	See data	Complied	Conducted

Note: UL Japan, Inc.'s EMI Work Procedures No. 13-EM-W0420 and 13-EM-W0422.
* For DFS tests, please see the test report number 10604551H-C issued by UL Japan, Inc.
*1) Radiated test was selected over 30 MHz based on section FCC15.407(b) and KDB 789033 D02 G.3.b).

FCC 15.31 (e)

The RF Module has own regulator.

The RF Module is constantly provided voltage through own regulator regardless of input voltage (DC3.3V).

Therefore, this EUT complies with the requirement.

FCC Part 15.203/212 Antenna requirement

The EUT has a unique antenna connector (U.FL on the Module).

Therefore the equipment complies with the requirement of 15.203/212.

UL Japan, Inc.

Ise EMC Lab.

4383-326 Asama-cho, Ise-shi, Mie-ken 516-0021 JAPAN

Telephone : +81 596 24 8999

Facsimile : +81 596 24 8124

3.3 Addition to standard

Item	Test Procedure	Specification	Worst margin	Results	Remarks
99% Occupied Band Width	RSS-Gen 6.6	RSS-210 A9.2 (1)(2)(3)	N/A	N/A	Conducted

Other than above, no addition, exclusion nor deviation has been made from the standard.

3.4 Uncertainty

EMI

The following uncertainties have been calculated to provide a confidence level of 95% using a coverage factor k=2.

Test room (semi-anechoic chamber)	Conducted emission (+dB)
	150kHz-30MHz
No.1	3.5dB
No.2	3.5dB
No.3	3.4dB
No.4	3.5dB

Test room (semi-anechoic chamber)	Radiated emission						
	(3m*)(+dB)				(1m*)(+dB)		(0.5m*)(+dB)
	9kHz -30MHz	30MHz -300MHz	300MHz -1GHz	1GHz -10GHz	10GHz -18GHz	18GHz -26.5GHz	26.5GHz -40GHz
No.1	4.3dB	5.5dB	6.3dB	5.5dB	5.8dB	5.8dB	4.3dB
No.2	4.2dB	5.4dB	6.3dB	5.4dB	5.7dB	5.9dB	5.6dB
No.3	4.4dB	5.4dB	6.4dB	5.2dB	5.5dB	5.8dB	5.5dB
No.4	4.7dB	5.6dB	6.4dB	5.3dB	5.7dB	5.9dB	5.5dB

*3m/1m/0.5m = Measurement distance

Antenna terminal conducted emission and Power density (+dB)			Antenna terminal conducted emission (+dB)		Channel power (±dB)
Below 1GHz	1GHz-3GHz	3GHz-18GHz	18GHz-26.5GHz	26.5GHz-40GHz	
1.5dB	1.7dB	2.8dB	2.8dB	2.9dB	2.6dB

Conducted Emission test

The data listed in this test report has enough margin, more than the site margin.

Radiated emission test(3m)

The data listed in this report meets the limits unless the uncertainty is taken into consideration.

UL Japan, Inc.

Ise EMC Lab.

4383-326 Asama-cho, Ise-shi, Mie-ken 516-0021 JAPAN

Telephone : +81 596 24 8999

Facsimile : +81 596 24 8124

3.5 Test Location

UL Japan, Inc. Ise EMC Lab. *NVLAP Lab. code: 200572-0
4383-326 Asama-cho, Ise-shi, Mie-ken 516-0021 JAPAN
Telephone : +81 596 24 8999 Facsimile : +81 596 24 8124

	IC Registration Number	Width x Depth x Height (m)	Size of reference ground plane (m) / horizontal conducting plane	Other rooms
No.1 semi-anechoic chamber	2973C-1	19.2 x 11.2 x 7.7m	7.0 x 6.0m	No.1 Power source room
No.2 semi-anechoic chamber	2973C-2	7.5 x 5.8 x 5.2m	4.0 x 4.0m	-
No.3 semi-anechoic chamber	2973C-3	12.0 x 8.5 x 5.9m	6.8 x 5.75m	No.3 Preparation room
No.3 shielded room	-	4.0 x 6.0 x 2.7m	N/A	-
No.4 semi-anechoic chamber	2973C-4	12.0 x 8.5 x 5.9m	6.8 x 5.75m	No.4 Preparation room
No.4 shielded room	-	4.0 x 6.0 x 2.7m	N/A	-
No.5 semi-anechoic chamber	-	6.0 x 6.0 x 3.9m	6.0 x 6.0m	-
No.6 shielded room	-	4.0 x 4.5 x 2.7m	4.0 x 4.5 m	-
No.6 measurement room	-	4.75 x 5.4 x 3.0m	4.75 x 4.15 m	-
No.7 shielded room	-	4.7 x 7.5 x 2.7m	4.7 x 7.5m	-
No.8 measurement room	-	3.1 x 5.0 x 2.7m	N/A	-
No.9 measurement room	-	8.8 x 4.6 x 2.8m	2.4 x 2.4m	-
No.11 measurement room	-	6.2 x 4.7 x 3.0m	4.8 x 4.6m	-

* Size of vertical conducting plane (for Conducted Emission test) : 2.0 x 2.0m for No.1, No.2, No.3, and No.4 semi-anechoic chambers and No.3 and No.4 shielded rooms.

3.6 Test data, Test instruments, and Test set up

Refer to APPENDIX.

UL Japan, Inc. Ise EMC Lab.

4383-326 Asama-cho, Ise-shi, Mie-ken 516-0021 JAPAN
Telephone : +81 596 24 8999
Facsimile : +81 596 24 8124

SECTION 4: Operation of E.U.T. during testing

4.1 Operating Modes

Test operating mode was determined as follows according to “Section 1 of 6 802.11 a/b/g/n testing - Managing Complex Regulatory Approvals - ” of TCB Council Workshop October 2009.

Mode	Remarks*
IEEE 802.11a (11a)	18Mbps, PN9
IEEE 802.11n MIMO 20MHz BW (11n-20)	MCS 12 (Short GI), PN9
IEEE 802.11n MIMO 40MHz BW (11n-40)	MCS 11 (Long GI), PN9
*The worst antenna(Ant: 0) and condition was determined based on the test result of Maximum Conducted Output Power.	
*The power value of the EUT was set for testing as follows (setting value might be different from product specification value); Power settings: Refer to the following table Software: Atheros Radio Test Tool (ART2-GUI) Version 2.28.6 *This setting of software is the worst case. Any conditions under the normal use do not exceed the condition of setting. In addition, end users cannot change the settings of the output power of the product.	

[Power setting]

Operation	Rate	Frequency	Power Setting [dBm]
11a	18Mbps	5180MHz	13.5
		5220MHz	13.5
		5240MHz	13.5
		5260MHz	13.5
		5300MHz	13.5
		5320MHz	13.5
		5500MHz	13.5
		5580MHz	13.5
11n MIMO 20Mband	MCS 12 (Short GI)	5700MHz	13.5
		5180MHz	14.5
		5220MHz	14.5
		5240MHz	14.5
		5260MHz	14.5
		5300MHz	14.5
		5320MHz	14.5
		5500MHz	14.0
11n MIMO 40Mband	MCS 11 (Long GI)	5580MHz	14.0
		5700MHz	14.0
		5190MHz	12.0
		5230MHz	12.0
		5270MHz	12.0
		5310MHz	12.0
		5510MHz	12.0
		5550MHz	12.0
		5670MHz	12.0

UL Japan, Inc.

Ise EMC Lab.

4383-326 Asama-cho, Ise-shi, Mie-ken 516-0021 JAPAN

Telephone : +81 596 24 8999

Facsimile : +81 596 24 8124

*The details of Operating mode(s)

Test Item	Operating Mode	Tested Antenna port	Tested Frequency		
			Lower Band	Middle Band	Additional Band
Conducted emission	11n-20 Tx *1)	0+1	-	5260MHz *1)	-
26dB Emission Bandwidth	11a Tx 11n-20 Tx	0 *2)	-	5260MHz 5300MHz 5320MHz	5500MHz 5580MHz 5700MHz
	11n-40 Tx	0 *2)	-	5270MHz 5310MHz	5510MHz 5550MHz 5670MHz
99% Occupied Bandwidth, 20dB Bandwidth,	11a Tx 11n-20 Tx	0 *2)	5180MHz 5220MHz 5240MHz	5260MHz 5300MHz 5320MHz	5500MHz 5580MHz 5700MHz
	11n-40 Tx	0 *2)	5190MHz 5230MHz	5270MHz 5310MHz	5510MHz 5550MHz 5670MHz
Maximum Conducted Output Power, Maximum Power Spectral Density	11a Tx	0, 1	5180MHz 5220MHz 5240MHz	5260MHz 5300MHz 5320MHz	5500MHz 5580MHz 5700MHz
	11n-20 Tx	0, 1, 0+1	5180MHz 5220MHz 5240MHz	5260MHz 5300MHz 5320MHz	5500MHz 5580MHz 5700MHz
	11n-40 Tx	0, 1, 0+1	5190MHz 5230MHz	5270MHz 5310MHz	5510MHz 5550MHz 5670MHz
Radiated Spurious Emission (Below 1GHz)	11n-20 Tx *1)	0+1	-	5260MHz *1)	-
Radiated Spurious Emission (Above 1GHz)	11n-20 Tx *3)	0+1	5180MHz	5260MHz 5320MHz	5500MHz 5580MHz 5700MHz
	11n-40 Tx	0+1	5190MHz	5270MHz 5310MHz	5510MHz 5550MHz 5670MHz
Conducted Spurious Emission	11n-20 Tx *1)	0 *2)	-	5260MHz *1)	-

*1) The operating mode and tested frequency were tested as a representative, because it had the highest power at antenna terminal test.

*2) After the comparison between Antenna port 0 and Antenna port 1, test was performed with the antenna that had higher power as a representative.

*3) Since 11a and 11n-20 have the same modulation method and no differences in transmitting specification, test was performed on the representative mode that had the highest conducted output power.

UL Japan, Inc.

Ise EMC Lab.

4383-326 Asama-cho, Ise-shi, Mie-ken 516-0021 JAPAN

Telephone : +81 596 24 8999

Facsimile : +81 596 24 8124

4.2 Configuration and peripherals

[Conducted emission]

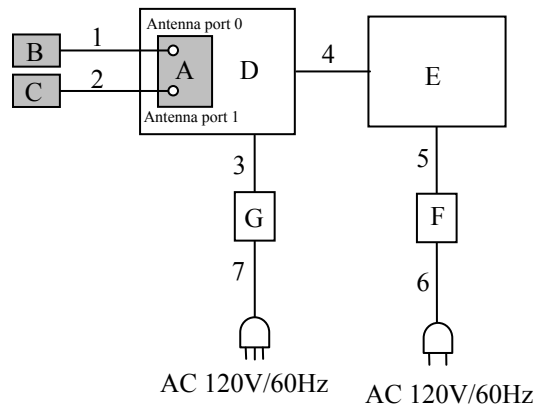

[Radiated emission / Antenna terminal conducted tests]

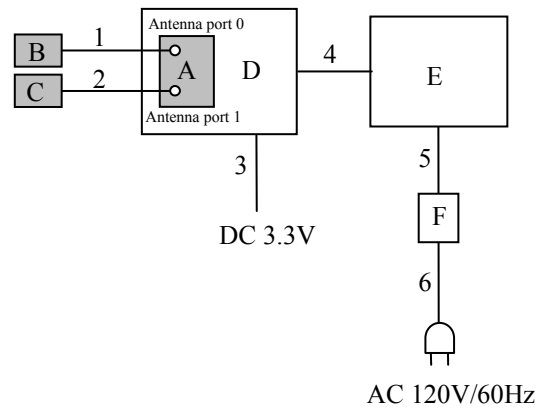

* Cabling and setup(s) were taken into consideration and test data was taken under worse case conditions.

* The test was performed using a typical evaluation board (Jig board).

Description of EUT

No.	Item	Model number	Serial number	Manufacturer	Remarks
A	PCI Express Half Mini Card WLAN Module	SX-PCEAN2	001	Silex	EUT
B	Antenna	H2B1PC1A1C	001	Unictron Technologies Corporation	EUT
C	Antenna	H2B1PC1A1C	002	Unictron Technologies Corporation	EUT
D	Jig board	-	-	-	-
E	Laptop PC	HP ProBook 6550 b	CNU1242 MQ0	HP	-
F	AC Adapter	Series PPP009L-E	CT: WBGST0A1R0PJ9u	HP	-
G	Regulated DC Power Supply	PW16-5ADP	171116437	TEXO	-

List of cables used

No.	Name	Length (m)	Shield		Remarks
			Cable	Connector	
1	Antenna Cable	0.15	Shielded	Shielded	-
2	Antenna Cable	0.15	Shielded	Shielded	-
3	DC Cable	2.7	Unshielded	Unshielded	-
4	Mini PCI Cable	0.3	Shielded	Shielded	-
5	DC Cable	1.8	Unshielded	Unshielded	-
6	AC Cable	1.8	Unshielded	Unshielded	-
7	AC Cable	1.8	Unshielded	Unshielded	-

UL Japan, Inc.

Ise EMC Lab.

4383-326 Asama-cho, Ise-shi, Mie-ken 516-0021 JAPAN

Telephone : +81 596 24 8999

Facsimile : +81 596 24 8124

SECTION 5: Conducted Emission

Test Procedure

EUT was placed on a wooden table of nominal size, 1.0m by 1.5m, raised 0.8m above the conducting ground plane. The rear of tabletop was located 40cm to the vertical conducting plane. The rear of EUT, including peripherals aligned and flushed with rear of tabletop. All other surfaces of tabletop were at least 80cm from any other grounded conducting surface. EUT was located 80cm from a Line Impedance Stabilization Network (LISN)/ Artificial mains Network (AMN) and excess AC cable was bundled in center.

For the tests on EUT with other peripherals (as a whole system)

I/O cable and AC cables that were connected to the peripherals were bundled in center. They were folded back and forth forming a bundle 30cm to 40cm long and were hanged at a 40cm height to the ground plane. All unused 50ohm connectors of the LISN(AMN) were resistivity terminated in 50ohm when not connected to the measuring equipment.

The AC Mains Terminal Continuous disturbance Voltage has been measured with the EUT in a Semi Anechoic Chamber or a Measurement Room.

The EUT was connected to a LISN (AMN).

An overview sweep with peak detection has been performed.

Detector	: QP and CISPR AV
Measurement range	: 0.15-30MHz
Test data	: APPENDIX
Test result	: Pass

UL Japan, Inc.

Ise EMC Lab.

4383-326 Asama-cho, Ise-shi, Mie-ken 516-0021 JAPAN

Telephone : +81 596 24 8999

Facsimile : +81 596 24 8124

SECTION 6: Radiated Spurious Emission and Band Edge Compliance

Test Procedure

EUT was placed on a urethane platform of nominal size, 0.5m by 1.0m, raised 0.8m above the conducting ground plane.

The Radiated Electric Field Strength has been measured in a Semi Anechoic Chamber with a ground plane.

The height of the measuring antenna varied between 1 and 4m and EUT was rotated a full revolution in order to obtain the maximum value of the electric field strength.

The measurements were made with the following detector function of the test receiver and the Spectrum analyzer (in linear mode).

The measurements were performed for both vertical and horizontal antenna polarization with the Test Receiver, or the Spectrum Analyzer.

The test was made with the detector (RBW/VBW) in the following table.

When using Spectrum analyzer, the test was made with adjusting span to zero by using peak hold.

Below 1GHz

The result also satisfied with the general limits specified in section 15.209(a).

Above 1GHz

Inside of restricted bands(Section 15.205): Apply to limit in the Section 15.209(a).

Outside of the restricted bands: Apply to limit 68.2dBuV/m(-27dBm e.i.r.p. *)
in the Section 15.407(b)(1)(2)(3).

Restricted bandedge:

Apply to limit in the Section 15.209(a).

Since this limit is severer than the limit of the inside of restricted bands.

*Electric Field Strength to e.i.r.p. Conversion

$$E = \frac{1000000\sqrt{30P}}{3} \text{ (uV/m)} \quad :P \text{ is the e.i.r.p. (Watts)}$$

Test Antennas are used as below;

Frequency	30MHz to 300MHz	300MHz to 1GHz	Above 1GHz
Antenna Type	Biconical	Logperiodic	Horn

Frequency	Below 1GHz	Above 1GHz	
Instrument used	Test Receiver	Spectrum Analyzer	
Detector	QP	PK	AV
IF Bandwidth	BW 120kHz(T/R)	RBW: 1MHz VBW: 3MHz	Method AD *1) RBW: 1MHz VBW: 3MHz Detector: Power Averaging (RMS) Duty factor was added to the results.
Test Distance	3m	3m (below 10GHz), 1m*2) (above 10GHz), 0.5m*3) (above 26.5GHz)	

*1) The test method was also referred to KDB 789033 D02 General UNII Test Procedures New Rules v01 "Guidelines for Compliance Testing of Unlicensed National Information Infrastructure (U-NII) Devices Part 15, Subpart E (Issued on June 6, 2014)".

*2) Distance Factor: $20 \times \log(3.0\text{m}/1.0\text{m}) = 9.5\text{dB}$

*3) Distance Factor: $20 \times \log(3.0\text{m}/0.5\text{m}) = 15.6\text{dB}$

UL Japan, Inc.

Ise EMC Lab.

4383-326 Asama-cho, Ise-shi, Mie-ken 516-0021 JAPAN

Telephone : +81 596 24 8999

Facsimile : +81 596 24 8124

- The carrier level and noise levels were confirmed at each position of X, Y and Z axes of EUT (Antenna and Module) to see the position of maximum noise, and the test was made at the position that has the maximum noise.

The test results and limit are rounded off to one decimal place, so some differences might be observed.

Measurement range : 30M-40GHz
Test data : APPENDIX
Test result : Pass

UL Japan, Inc.

Ise EMC Lab.

4383-326 Asama-cho, Ise-shi, Mie-ken 516-0021 JAPAN

Telephone : +81 596 24 8999

Facsimile : +81 596 24 8124

SECTION 7: Antenna Terminal Conducted Tests

Test Procedure

The tests were made with below setting connected to the antenna port with Spectrum Analyzer.

Test	Span	RBW	VBW	Sweep time	Detector	Trace	Instrument used and Test method
26dB Bandwidth	40MHz, 80MHz	Close to 1% of EBW	Greater than RBW	Auto	Peak	Max Hold	Spectrum Analyzer
99% Occupied Bandwidth *1)	Enough width to display emission skirts	1 to 5% of OBW	≥ 3 RBW	Auto	Peak	Max Hold	Spectrum Analyzer
20dB Bandwidth	40MHz, 80MHz	100kHz	300kHz	Auto	Peak	Max Hold	Spectrum Analyzer
Maximum Conducted Output Power	-	-	-	Auto	Averaging	-	Power Meter (Sensor: 50MHz BW) (Method PM-G)
Maximum Power Spectral Density	40MHz, 80MHz	1MHz	3MHz	Auto	Power Averaging (200 times)	Clear Write	Spectrum Analyzer
Conducted Spurious Emission*2)	9kHz-150kHz 150kHz-30MHz	200Hz 9.1kHz	620Hz 27kHz	Auto	Peak	Max Hold	Spectrum Analyzer

* The test method was also referred to KDB 789033 D02 General UNII Test Procedures New Rules v01 "Guidelines for Compliance Testing of Unlicensed National Information Infrastructure (U-NII) Devices Part 15, Subpart E (Issued on June 6, 2014)".

*1) Peak hold was applied as Worst-case measurement.

*2) In the frequency range below 30MHz, RBW was narrowed to separate the noise contents.

Then, wide-band noise near the limit was checked separately, however the noise was low enough as shown in the chart.(9kHz-150kHz:RBW=200Hz, 150kHz-30MHz:RBW=9.1kHz).

The test results and limit are rounded off to two decimals place, so some differences might be observed.

Test data : APPENDIX
Test result : Pass

APPENDIX 1: Test data

Conducted Emission

DATA OF CONDUCTED EMISSION TEST

UL Japan, Inc. Ise EMC Lab. No.2 Semi Anechoic Chamber
Date : 2015/03/11

Report No. : 10604551H
 Temp./Humi. : 22deg. C / 38% RH
 Engineer : Kazuya Yoshioka

Mode / Remarks : WLAN 11n-20 5260MHz

LIMIT : FCC15.207 QP
 FCC15.207 AV

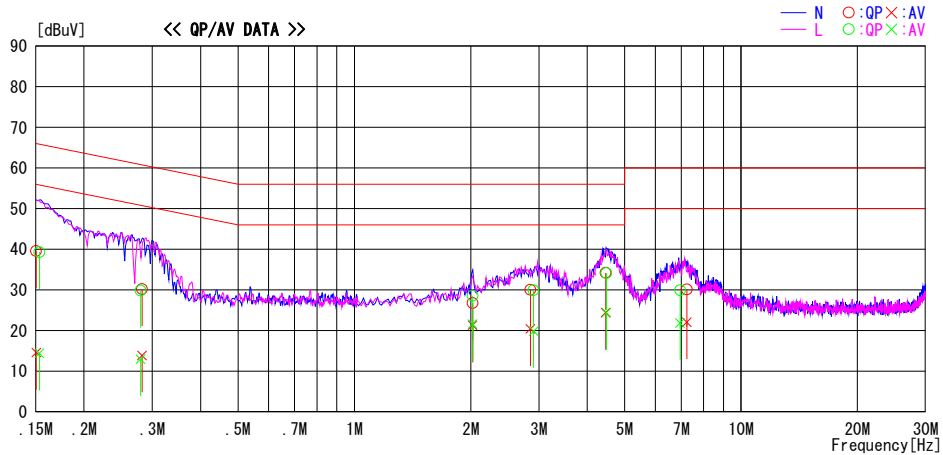

Frequency [MHz]	Reading Level		Corr. Factor	Results		Limit		Margin		Phase	Comment
	QP [dBuV]	AV [dBuV]		QP [dBuV]	AV [dBuV]	QP [dBuV]	AV [dBuV]	QP [dB]	AV [dB]		
0.15030	26.4	1.4	13.2	39.6	14.6	66.0	56.0	26.4	41.4	N	
0.28250	17.0	0.7	13.2	30.2	13.9	60.7	50.7	30.5	36.8	N	
2.02200	13.2	7.8	13.5	26.7	21.3	56.0	46.0	29.3	24.7	N	
2.85200	16.4	6.8	13.6	30.0	20.4	56.0	46.0	26.0	25.6	N	
4.46340	20.5	10.7	13.7	34.2	24.4	56.0	46.0	21.8	21.6	N	
7.24120	16.1	8.1	14.0	30.1	22.1	60.0	50.0	29.9	27.9	N	
0.15330	26.1	1.2	13.2	39.3	14.4	65.8	55.8	26.5	41.4	L	
0.28000	16.6	-0.2	13.2	29.8	13.0	60.8	50.8	31.0	37.8	L	
2.02200	15.1	8.1	13.5	28.6	21.6	56.0	46.0	27.4	24.4	L	
2.90680	16.3	6.3	13.6	29.9	19.9	56.0	46.0	26.1	26.1	L	
4.48494	20.4	10.7	13.7	34.1	24.4	56.0	46.0	21.9	21.6	L	
6.95663	15.9	7.9	14.0	29.9	21.9	60.0	50.0	30.1	28.1	L	

CHART: WITH FACTOR, Peak hold data. CALCULATION: RESULT=READING+C.F (LISN LOSS+ATT LOSS+CABLE LOSS)
 Except for the above table : adequate margin data below the limits.

UL Japan, Inc.
Ise EMC Lab.

4383-326 Asama-cho, Ise-shi, Mie-ken 516-0021 JAPAN
 Telephone : +81 596 24 8999
 Facsimile : +81 596 24 8124

26dB Emission Bandwidth and 99% Occupied Bandwidth

Test place : Ise EMC Lab. No.11 Measurement Room
Report No. : 10604551H
Date : 03/09/2015
Temperature/ Humidity : 23deg. C / 33% RH
Engineer : Shinichi Miyazono
Mode : Tx

11a Antenna port 0

Frequency [MHz]	26dB Emission Bandwidth [MHz]	99% Occupied Bandwidth [MHz]	Limit [MHz]
5180	-	16.8848	-
5220	-	16.9070	-
5240	-	16.9383	-
5260	21.455	16.9598	-
5300	21.306	16.9355	-
5320	21.473	16.9868	-
5500	21.285	16.9790	-
5580	21.174	16.9141	-
5700	21.492	16.8905	-

11n-20 Antenna port 0

Frequency [MHz]	26dB Emission Bandwidth [MHz]	99% Occupied Bandwidth [MHz]	Limit [MHz]
5180	-	17.9054	-
5220	-	17.9725	-
5240	-	17.8955	-
5260	21.017	17.9182	-
5300	21.359	17.8771	-
5320	21.434	17.8727	-
5500	21.464	17.9007	-
5580	21.263	17.8850	-
5700	21.387	17.9111	-

11n-40 Antenna port 0

Frequency [MHz]	26dB Emission Bandwidth [MHz]	99% Occupied Bandwidth [MHz]	Limit [MHz]
5190	-	36.8223	-
5230	-	36.7333	-
5270	43.164	36.6460	-
5310	43.367	36.6771	-
5510	43.265	36.7828	-
5550	43.969	36.7032	-
5670	43.245	36.7007	-

26dB Emission Bandwidth

11a Antenna port 0

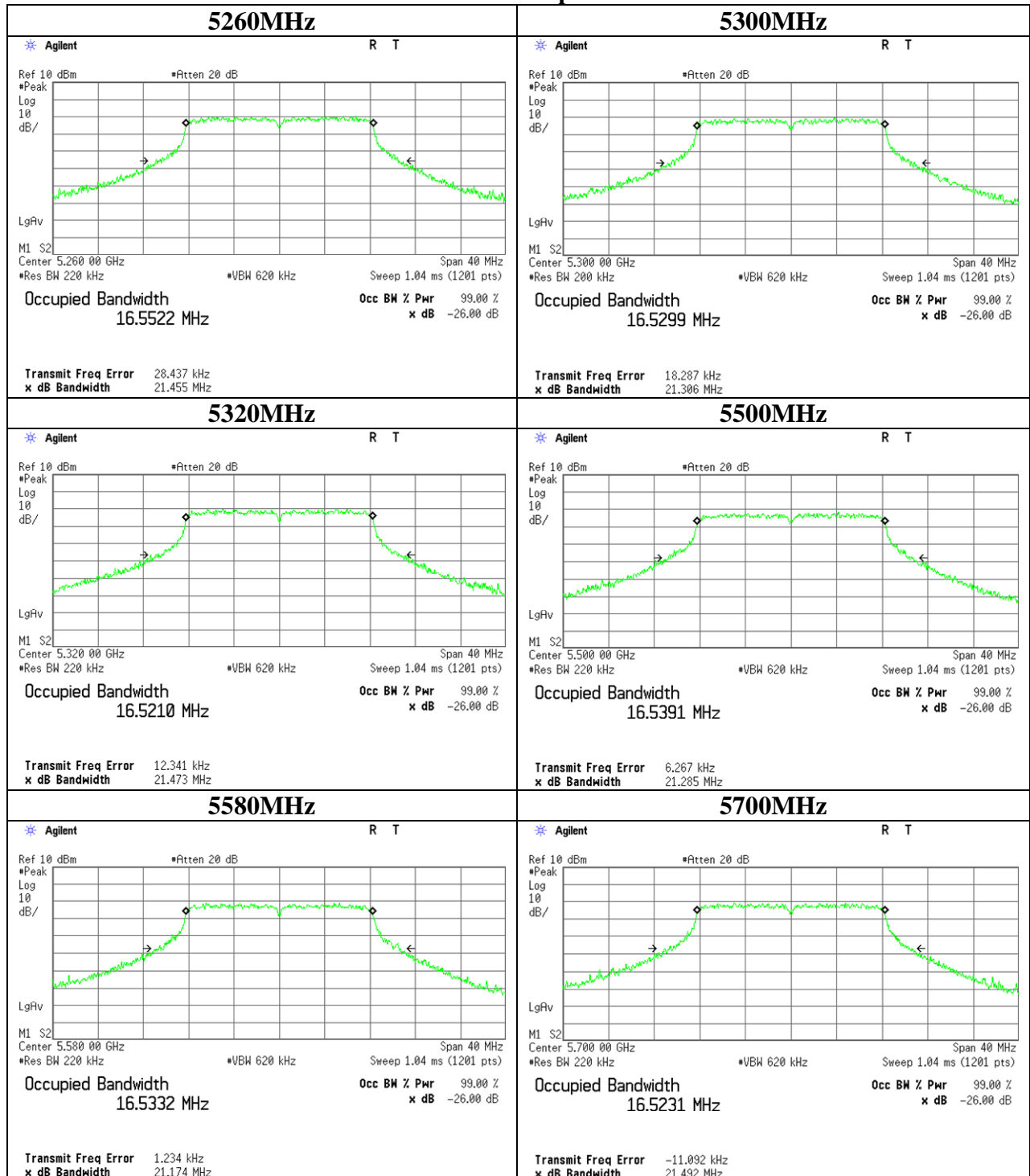

UL Japan, Inc.
Ise EMC Lab.

4383-326 Asama-cho, Ise-shi, Mie-ken 516-0021 JAPAN

Telephone : +81 596 24 8999

Facsimile : +81 596 24 8124

99% Occupied Bandwidth

11a Antenna port 0

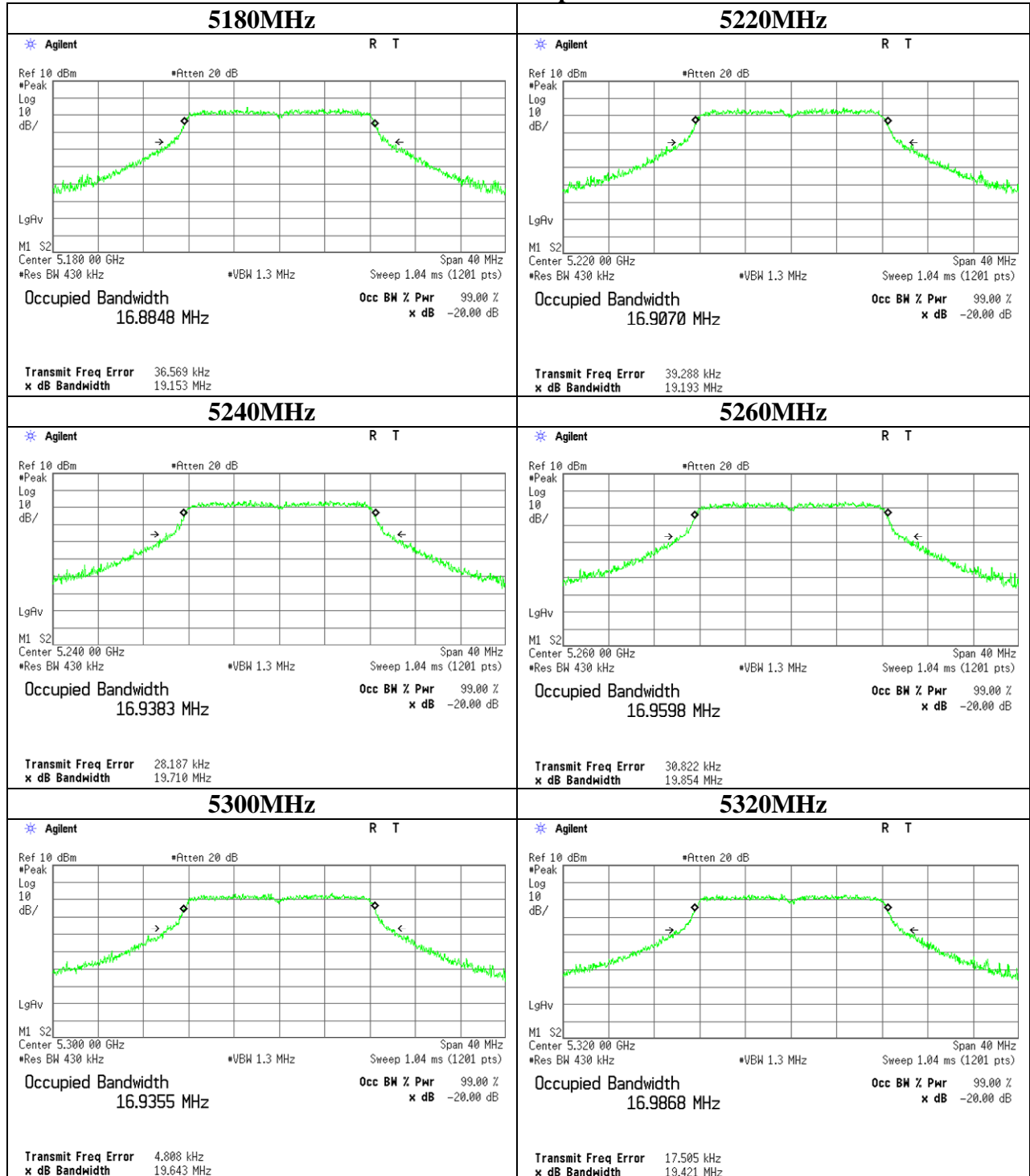

UL Japan, Inc.
Ise EMC Lab.

4383-326 Asama-cho, Ise-shi, Mie-ken 516-0021 JAPAN

Telephone : +81 596 24 8999

Facsimile : +81 596 24 8124

99% Occupied Bandwidth

11a Antenna port 0

5500MHz

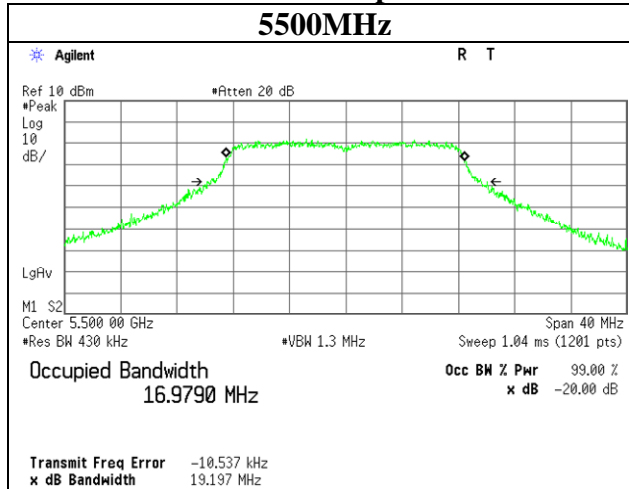

5580MHz

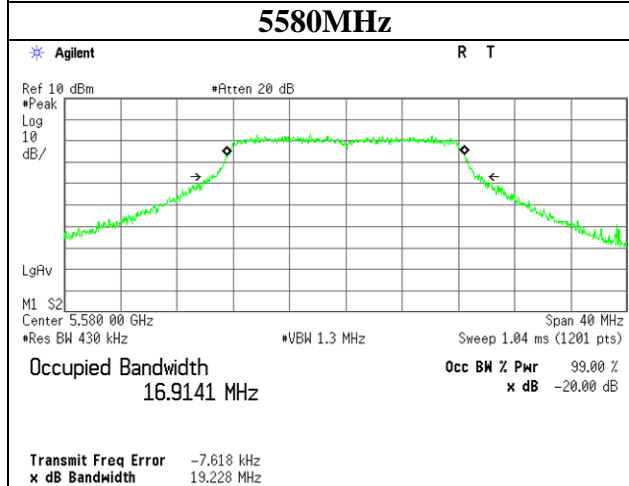

5700MHz

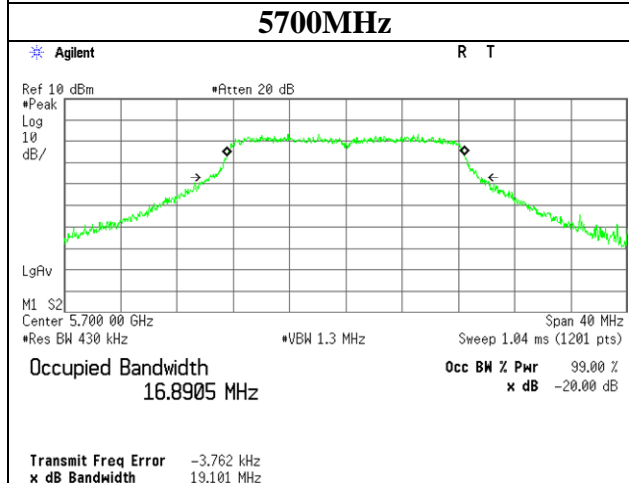

UL Japan, Inc.
Ise EMC Lab.

4383-326 Asama-cho, Ise-shi, Mie-ken 516-0021 JAPAN

Telephone : +81 596 24 8999

Facsimile : +81 596 24 8124

26dB Emission Bandwidth

11n-20 Antenna port 0

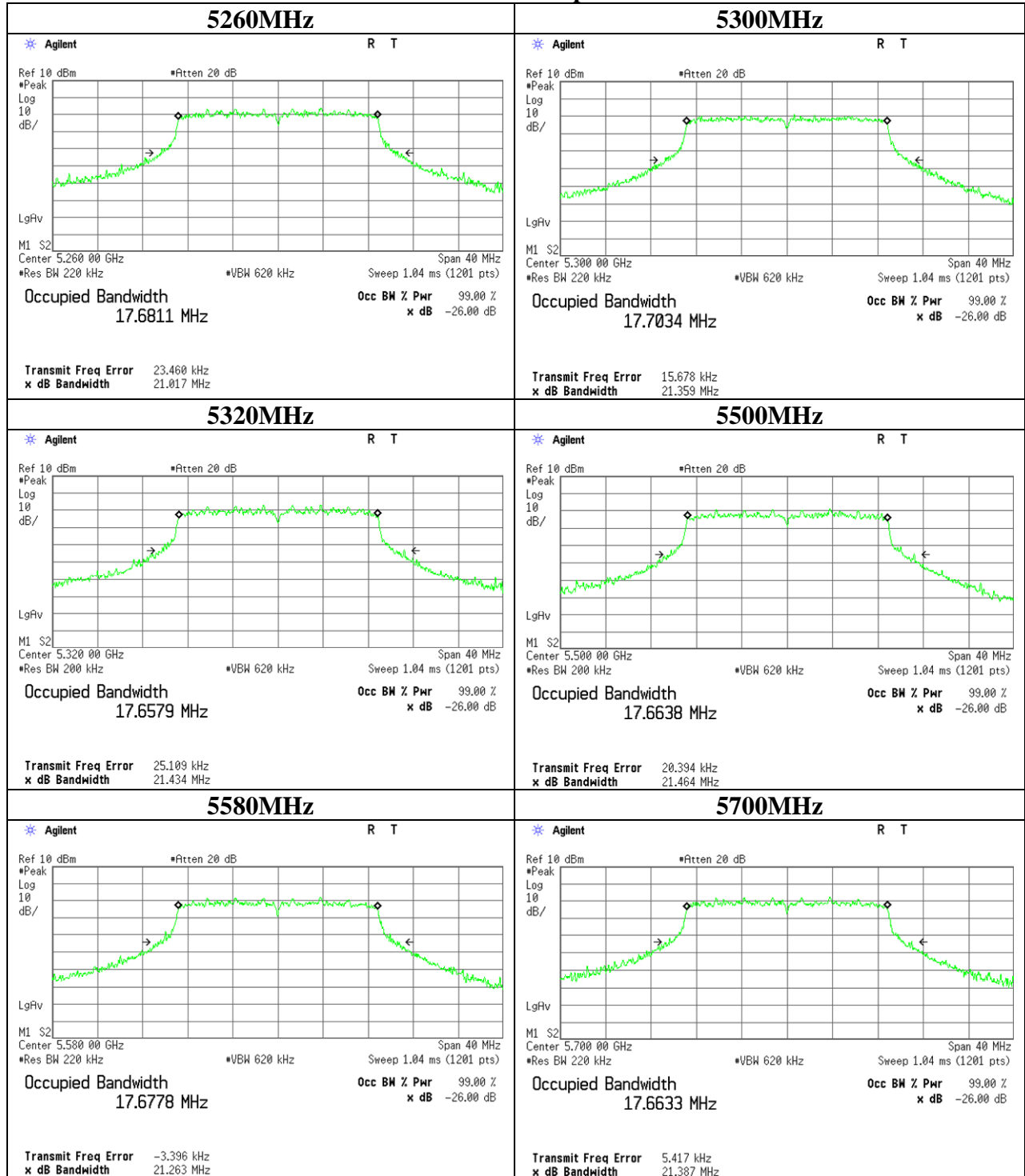

UL Japan, Inc.
Ise EMC Lab.

4383-326 Asama-cho, Ise-shi, Mie-ken 516-0021 JAPAN

Telephone : +81 596 24 8999

Facsimile : +81 596 24 8124

99% Occupied Bandwidth

11n-20 Antenna port 0

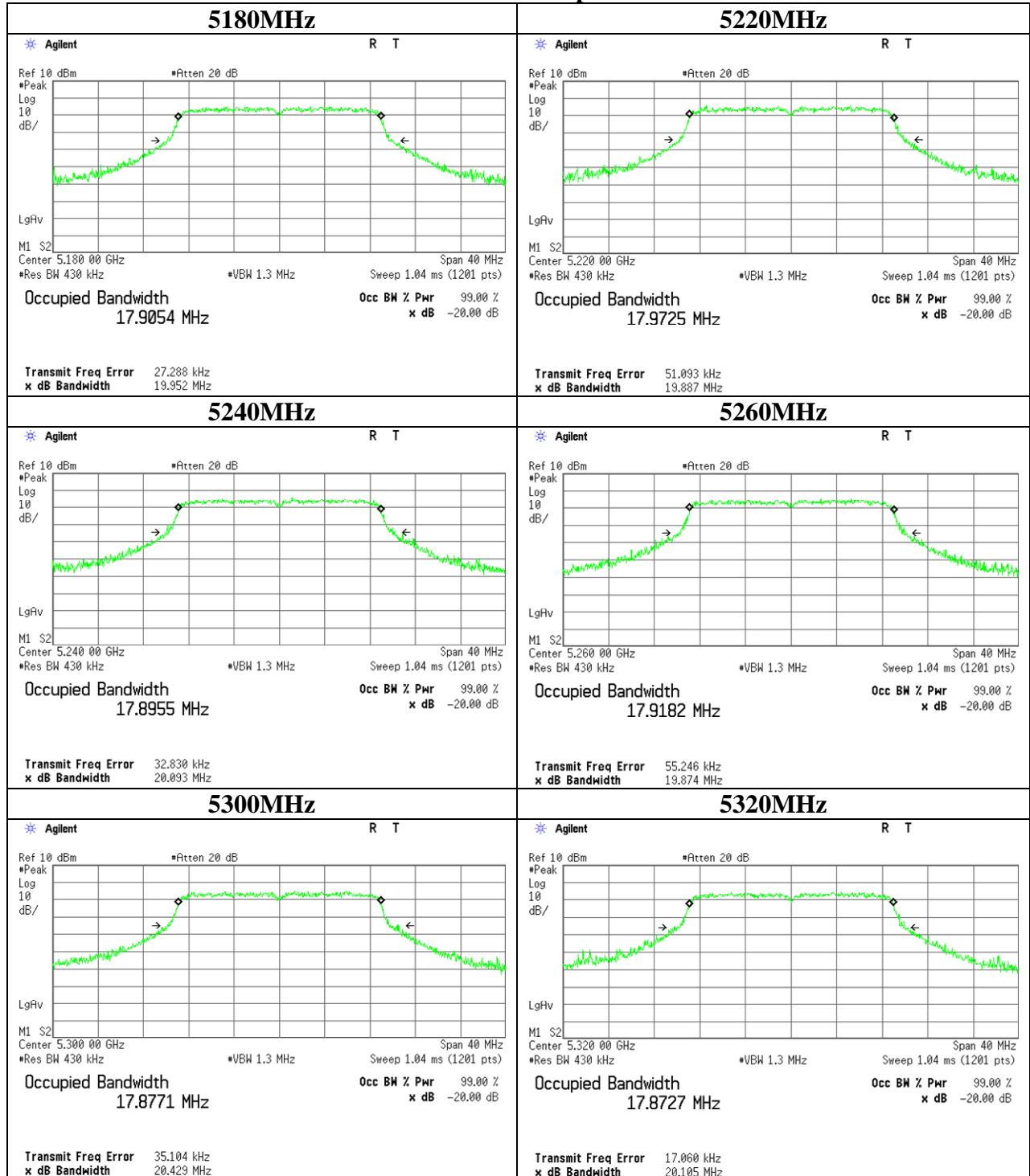

UL Japan, Inc.
Ise EMC Lab.

4383-326 Asama-cho, Ise-shi, Mie-ken 516-0021 JAPAN

Telephone : +81 596 24 8999

Facsimile : +81 596 24 8124

99% Occupied Bandwidth

11n-20 Antenna port 0

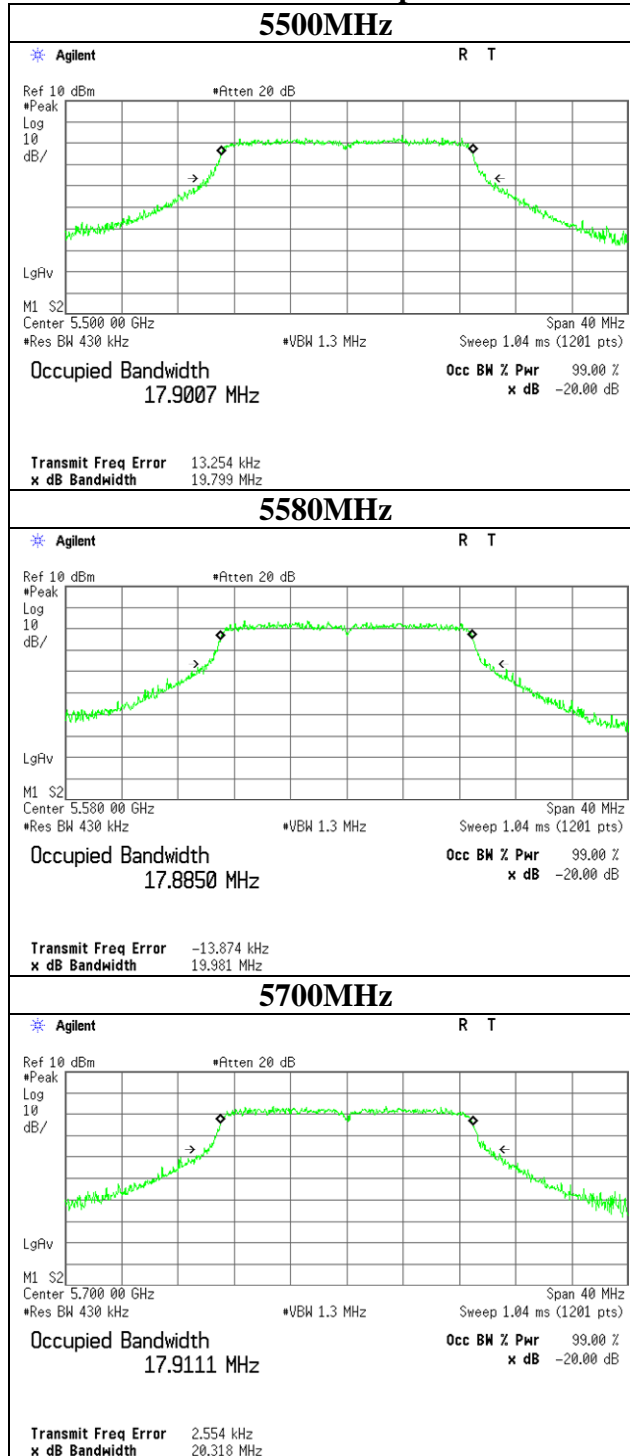

UL Japan, Inc.
Ise EMC Lab.

4383-326 Asama-cho, Ise-shi, Mie-ken 516-0021 JAPAN
 Telephone : +81 596 24 8999
 Facsimile : +81 596 24 8124

26dB Emission Bandwidth

11n-40 Antenna port 0

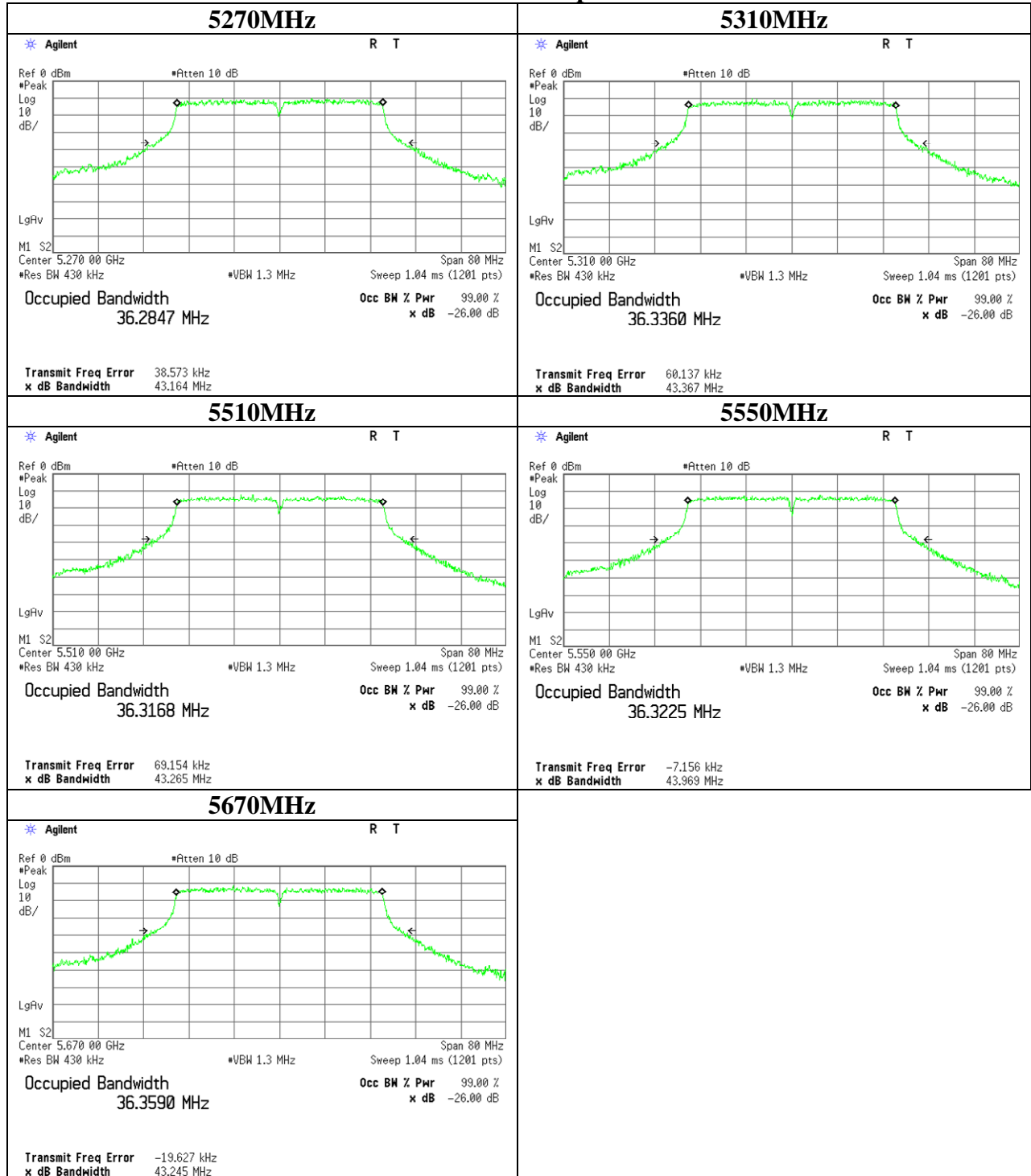

UL Japan, Inc.
Ise EMC Lab.

4383-326 Asama-cho, Ise-shi, Mie-ken 516-0021 JAPAN

Telephone : +81 596 24 8999

Facsimile : +81 596 24 8124

99% Occupied Bandwidth

11n-40 Antenna port 0

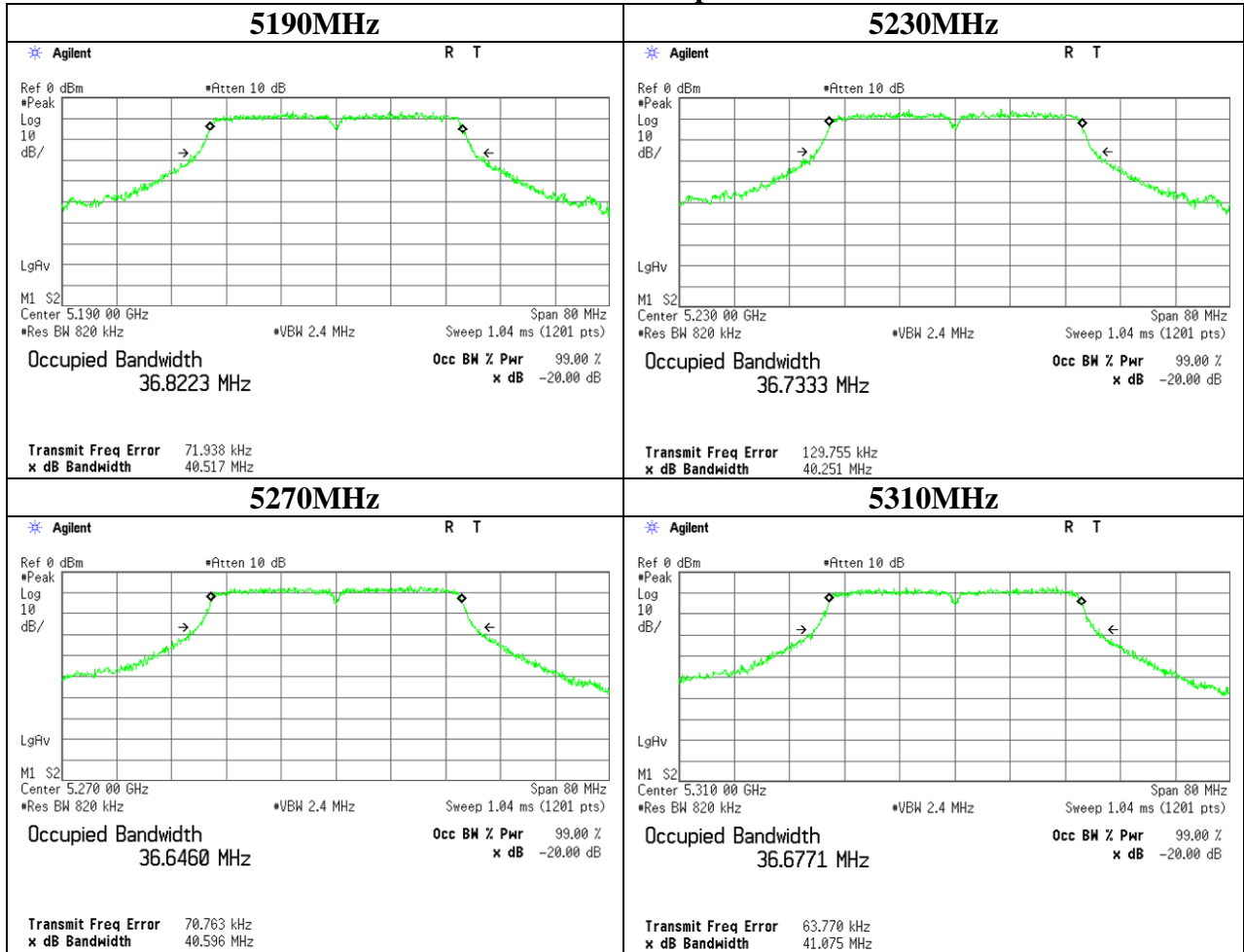

UL Japan, Inc.

Ise EMC Lab.

4383-326 Asama-cho, Ise-shi, Mie-ken 516-0021 JAPAN

Telephone : +81 596 24 8999

Facsimile : +81 596 24 8124

99% Occupied Bandwidth

11n-40 Antenna port 0

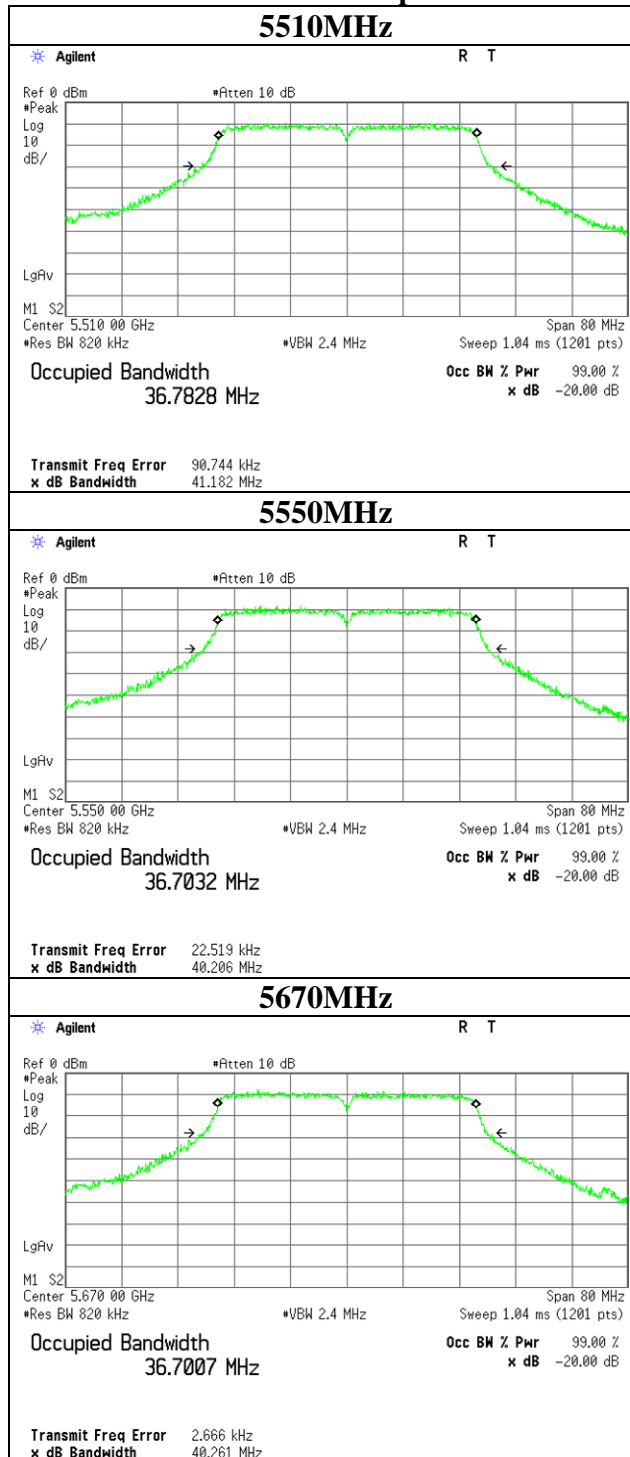

UL Japan, Inc.
Ise EMC Lab.

4383-326 Asama-cho, Ise-shi, Mie-ken 516-0021 JAPAN

Telephone : +81 596 24 8999

Facsimile : +81 596 24 8124

20dB Bandwidth

Test place	Ise EMC Lab. No.11 Measurement Room
Report No.	10604551H
Date	03/09/2015
Temperature/ Humidity	23deg. C / 33% RH
Engineer	Shinichi Miyazono
Mode	Tx

11a Antenna port 0

Frequency [MHz]	20dB Emission Bandwidth [MHz]	Limit [MHz]
5180	17.543	-
5220	17.571	-
5240	17.601	-
5260	17.693	-
5300	17.559	-
5320	17.524	-
5500	17.520	-
5580	17.523	-
5700	17.398	-

11n-20 Antenna port 0

Frequency [MHz]	20dB Emission Bandwidth [MHz]	Limit [MHz]
5180	18.640	-
5220	18.441	-
5240	18.494	-
5260	18.591	-
5300	18.653	-
5320	18.481	-
5500	18.711	-
5580	18.676	-
5700	18.719	-

11n-40 Antenna Port 0

Frequency [MHz]	20dB Emission Bandwidth [MHz]	Limit [MHz]
5190	37.267	-
5230	37.320	-
5270	37.344	-
5310	37.281	-
5510	37.226	-
5550	37.221	-
5670	37.296	-

20dB Bandwidth

11a Antenna port 0

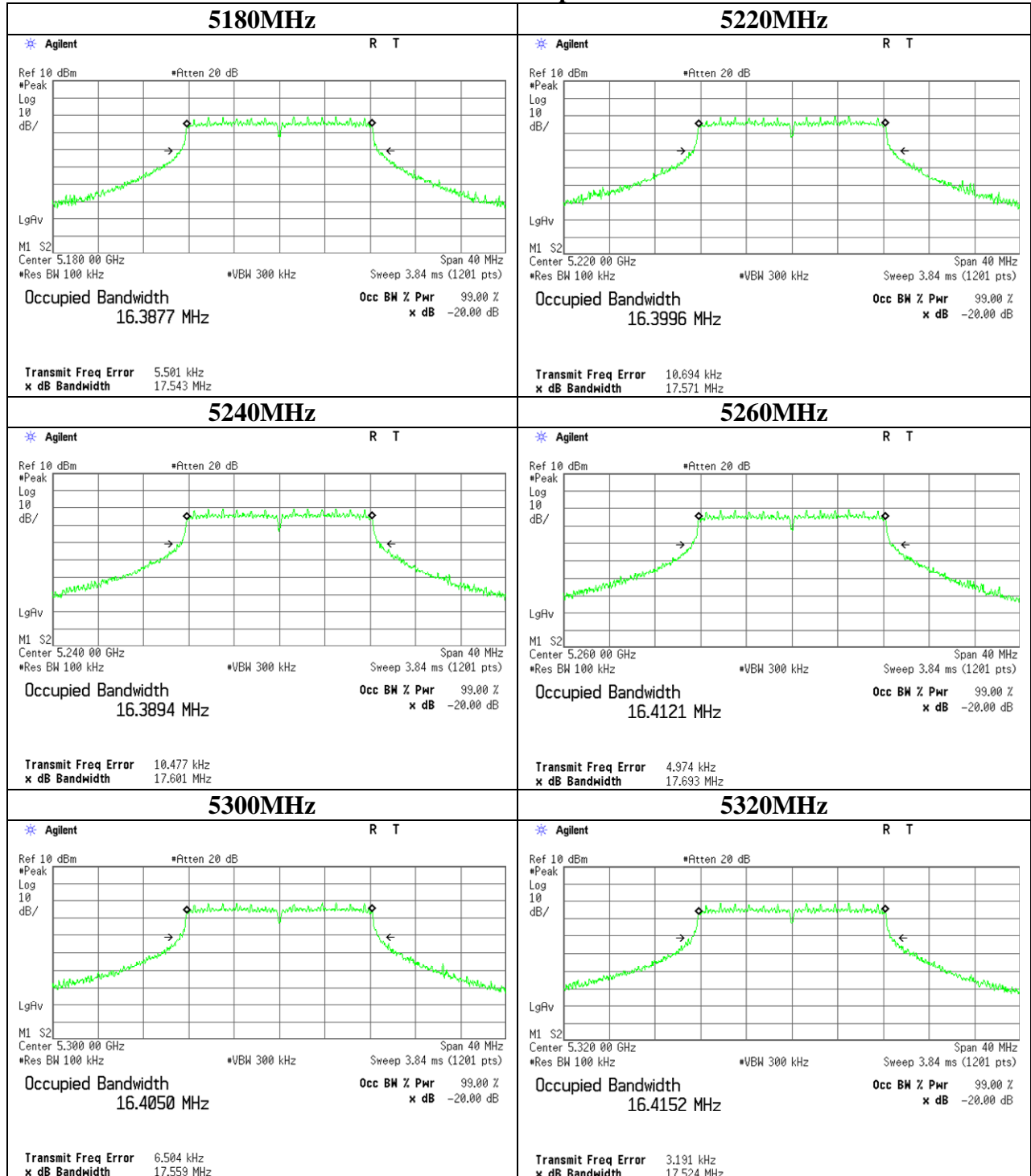

UL Japan, Inc.
Ise EMC Lab.

4383-326 Asama-cho, Ise-shi, Mie-ken 516-0021 JAPAN

Telephone : +81 596 24 8999

Facsimile : +81 596 24 8124

20dB Bandwidth

11a Antenna port 0

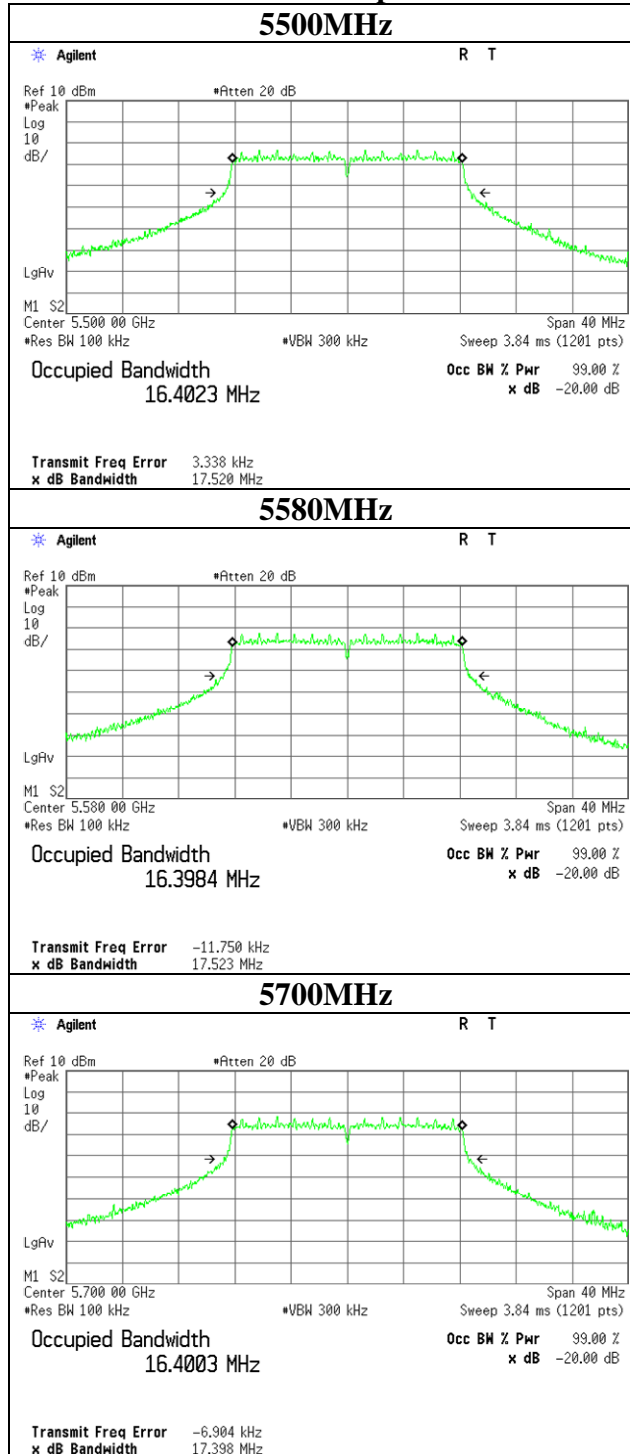

UL Japan, Inc.
Ise EMC Lab.

4383-326 Asama-cho, Ise-shi, Mie-ken 516-0021 JAPAN
 Telephone : +81 596 24 8999
 Facsimile : +81 596 24 8124

20dB Bandwidth

11n-20 Antenna port 0

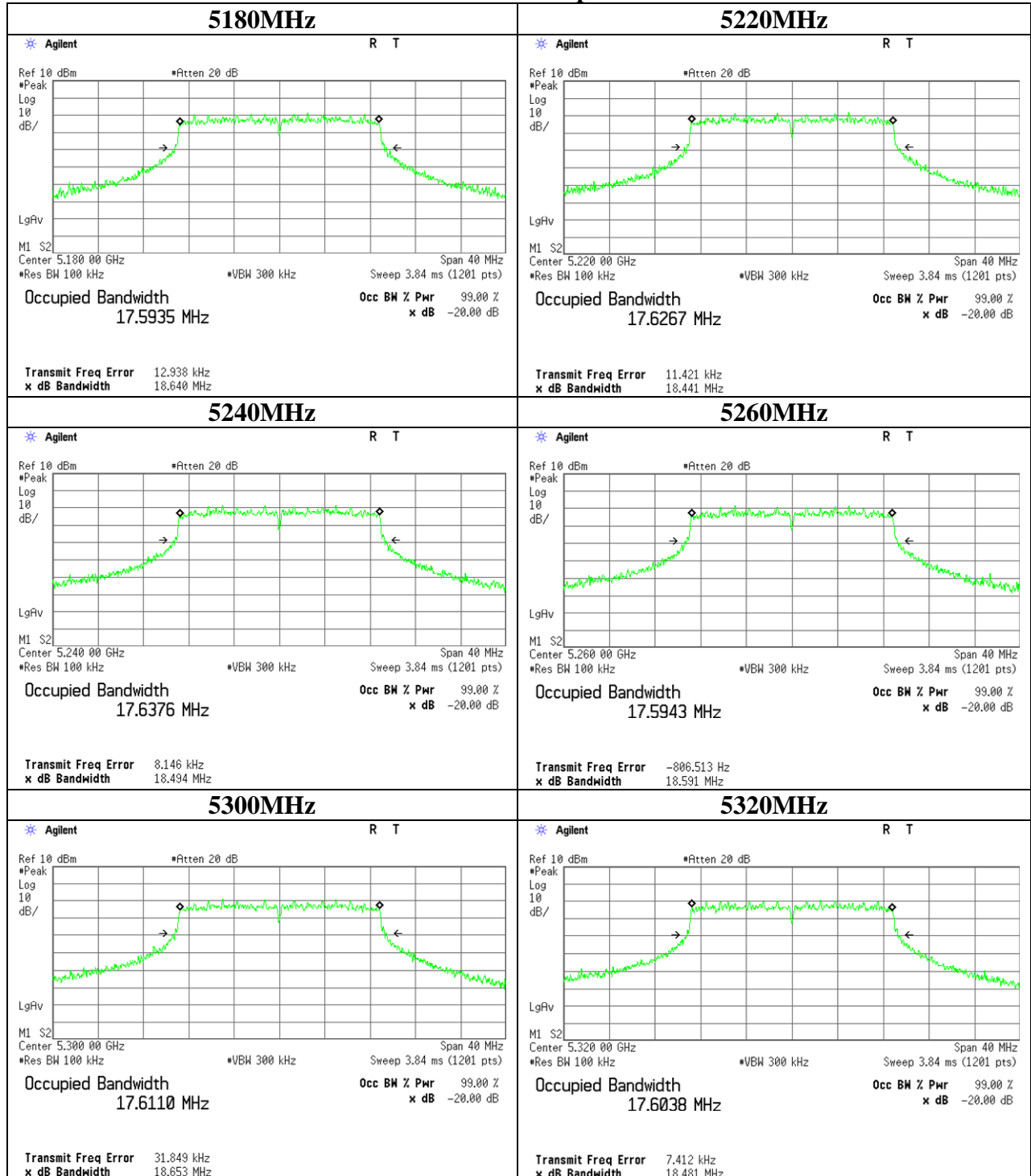

UL Japan, Inc.
Ise EMC Lab.

4383-326 Asama-cho, Ise-shi, Mie-ken 516-0021 JAPAN
 Telephone : +81 596 24 8999
 Facsimile : +81 596 24 8124

20dB Bandwidth

11n-20 Antenna port 0

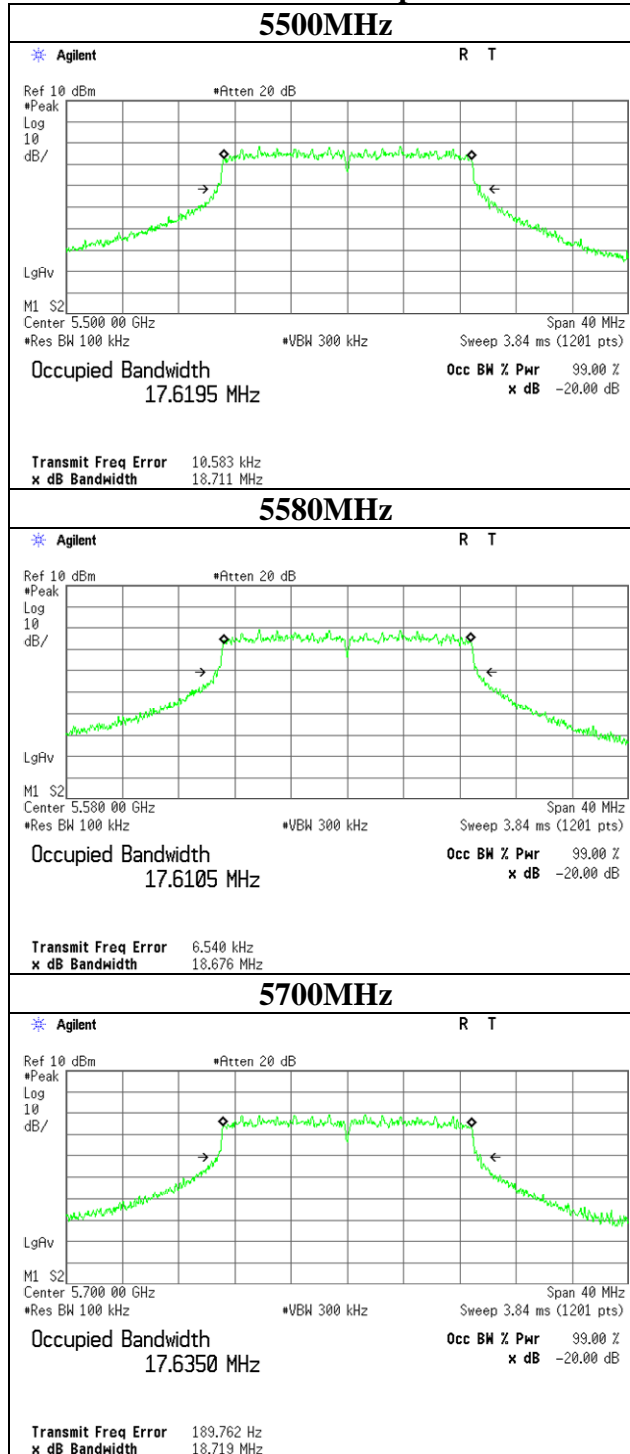

UL Japan, Inc.
Ise EMC Lab.

4383-326 Asama-cho, Ise-shi, Mie-ken 516-0021 JAPAN
 Telephone : +81 596 24 8999
 Facsimile : +81 596 24 8124

20dB Bandwidth

11n-40 Antenna port 0

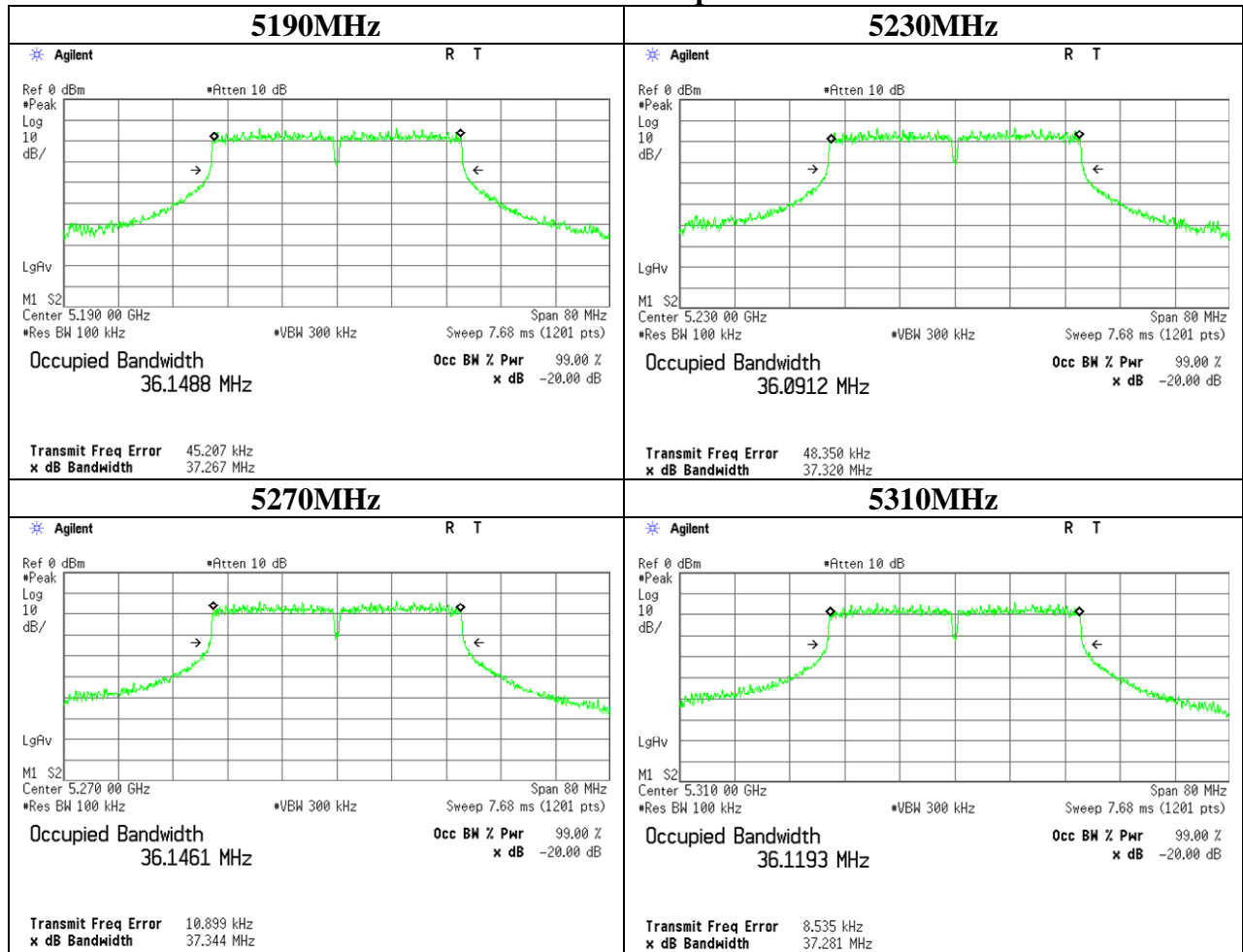

UL Japan, Inc.
Ise EMC Lab.

4383-326 Asama-cho, Ise-shi, Mie-ken 516-0021 JAPAN
 Telephone : +81 596 24 8999
 Facsimile : +81 596 24 8124

20dB Bandwidth

11n-40 Antenna port 0

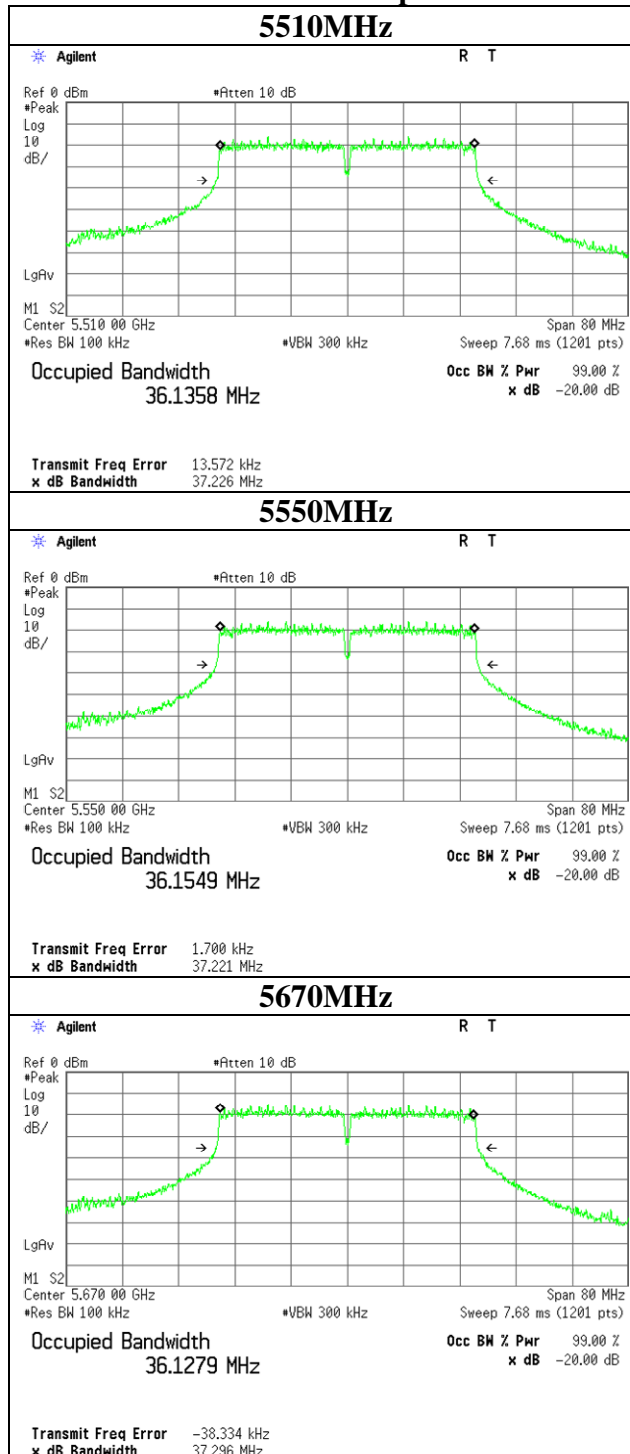

UL Japan, Inc.
Ise EMC Lab.

4383-326 Asama-cho, Ise-shi, Mie-ken 516-0021 JAPAN
 Telephone : +81 596 24 8999
 Facsimile : +81 596 24 8124

Maximum Conducted Output Power

Test place : Ise EMC Lab. No.11 Measurement Room
Report No. : 10604551H
Date : 03/09/2015
Temperature/ Humidity : 23deg. C / 33% RH
Engineer : Shinichi Miyazono
Mode : 11a Tx

Antenna port 0

Freq. [MHz]	P/M Reading [dBm]	Cable Loss [dB]	Atten. Loss [dB]	Antenna Gain [dBi]	Result (Cond.)		Result (e.i.r.p.)		Limit (Cond.)		Limit (e.i.r.p.)		Margin (Cond.) [dB]	Margin (e.i.r.p.) [dB]
					[dBm]	[mW]	[dBm]	[mW]	[dBm]	[mW]	[dBm]	[mW]		
5180.0	2.44	1.23	10.11	3.90	13.78	23.88	17.68	58.61	23.97	250.00	-	-	10.19	-
5220.0	2.71	1.24	10.11	3.90	14.06	25.47	17.96	62.52	23.97	250.00	-	-	9.91	-
5240.0	2.61	1.24	10.11	3.90	13.96	24.89	17.86	61.09	23.97	250.00	-	-	10.01	-
5260.0	2.57	1.24	10.11	3.90	13.92	24.66	17.82	60.53	23.97	250.00	-	-	10.05	-
5300.0	2.25	1.25	10.11	3.90	13.61	22.96	17.51	56.36	23.97	250.00	-	-	10.36	-
5320.0	1.68	1.26	10.11	3.90	13.05	20.18	16.95	49.55	23.97	250.00	-	-	10.92	-
5500.0	1.51	1.29	10.12	3.90	12.92	19.59	16.82	48.08	23.97	250.00	-	-	11.05	-
5580.0	1.49	1.30	10.12	3.90	12.91	19.54	16.81	47.97	23.97	250.00	-	-	11.06	-
5700.0	1.58	1.31	10.11	3.90	13.00	19.95	16.90	48.98	23.97	250.00	-	-	10.97	-

Result(Cond.) = Reading + Cable Loss + Atten.Loss

Result(e.i.r.p.) = Reading + Cable Loss + Atten.Loss + Antenna Gain

15.407(a)(1)(iv) Limit(Cond.) = 23.97dBm(250mW)

Although the EUT operates on Master mode, more stringent limit for Client device was applied.

15.407(a)(2) Limit(Cond.) = 23.97dBm(250mW) or 11 + 10log(26dB BW) dBm

Antenna port 1

Freq. [MHz]	P/M Reading [dBm]	Cable Loss [dB]	Atten. Loss [dB]	Antenna Gain [dBi]	Result (Cond.)		Result (e.i.r.p.)		Limit (Cond.)		Limit (e.i.r.p.)		Margin (Cond.) [dB]	Margin (e.i.r.p.) [dB]
					[dBm]	[mW]	[dBm]	[mW]	[dBm]	[mW]	[dBm]	[mW]		
5180.0	1.45	1.23	10.11	3.90	12.79	19.01	16.69	46.67	23.97	250.00	-	-	11.18	-
5220.0	1.32	1.24	10.11	3.90	12.67	18.49	16.57	45.39	23.97	250.00	-	-	11.30	-
5240.0	1.24	1.24	10.11	3.90	12.59	18.16	16.49	44.57	23.97	250.00	-	-	11.38	-
5260.0	0.81	1.24	10.11	3.90	12.16	16.44	16.06	40.36	23.97	250.00	-	-	11.81	-
5300.0	0.93	1.25	10.11	3.90	12.29	16.94	16.19	41.59	23.97	250.00	-	-	11.68	-
5320.0	0.83	1.26	10.11	3.90	12.20	16.60	16.10	40.74	23.97	250.00	-	-	11.77	-
5500.0	1.06	1.29	10.12	3.90	12.47	17.66	16.37	43.35	23.97	250.00	-	-	11.50	-
5580.0	1.37	1.30	10.12	3.90	12.79	19.01	16.69	46.67	23.97	250.00	-	-	11.18	-
5700.0	0.91	1.31	10.11	3.90	12.33	17.10	16.23	41.98	23.97	250.00	-	-	11.64	-

Result(Cond.) = Reading + Cable Loss + Atten.Loss

Result(e.i.r.p.) = Reading + Cable Loss + Atten.Loss + Antenna Gain

15.407(a)(1)(iv) Limit(Cond.) = 23.97dBm(250mW)

Although the EUT operates on Master mode, more stringent limit for Client device was applied.

15.407(a)(2) Limit(Cond.) = 23.97dBm(250mW) or 11 + 10log(26dB BW) dBm

UL Japan, Inc.

Ise EMC Lab.

4383-326 Asama-cho, Ise-shi, Mie-ken 516-0021 JAPAN

Telephone : +81 596 24 8999

Facsimile : +81 596 24 8124

Maximum Conducted Output Power

Test place : Ise EMC Lab. No.11 Measurement Room
Report No. : 10604551H
Date : 03/09/2015
Temperature/ Humidity : 23deg. C / 33% RH
Engineer : Shinichi Miyazono
Mode : 11n-20 Tx

Antenna port 0+1

Freq. [MHz]	Antenna Port 0 Result		Antenna Port 1 Result		Result Antenna Port 0+1 (Cond.)		Result Antenna Port 0+1 (e.i.r.p.)		Limit (Cond.)		Limit (e.i.r.p.)		Margin (Cond.)	Margin (e.i.r.p.)
	(Cond.)	(e.i.r.p.)	(Cond.)	(e.i.r.p.)	(Cond.)		(e.i.r.p.)		(Cond.)		(e.i.r.p.)		[dB]	[dB]
	[mW]	[mW]	[mW]	[mW]	[dBm]	[mW]	[dBm]	[mW]	[dBm]	[mW]	[dBm]	[mW]	[dB]	[dB]
5180.0	27.86	68.39	20.23	49.66	16.82	48.09	20.72	118.05	23.97	250.00	-	-	7.15	-
5220.0	27.99	68.71	19.86	48.75	16.80	47.85	20.70	117.46	23.97	250.00	-	-	7.17	-
5240.0	28.18	69.18	20.18	49.55	16.85	48.37	20.75	118.73	23.97	250.00	-	-	7.12	-
5260.0	28.38	69.66	20.14	49.43	16.86	48.52	20.76	119.09	23.97	250.00	-	-	7.11	-
5300.0	24.10	59.16	16.83	41.30	16.12	40.93	20.02	100.46	23.97	250.00	-	-	7.85	-
5320.0	23.82	58.48	18.41	45.19	16.26	42.23	20.16	103.66	23.97	250.00	-	-	7.71	-
5500.0	18.37	45.08	17.74	43.55	15.58	36.11	19.48	88.63	23.97	250.00	-	-	8.39	-
5600.0	21.78	53.46	20.75	50.93	16.29	42.53	20.19	104.39	23.97	250.00	-	-	7.68	-
5700.0	19.14	46.99	17.50	42.95	15.64	36.64	19.54	89.94	23.97	250.00	-	-	8.33	-

Antenna port 0

Freq. [MHz]	P/M Reading [dBm]	Cable Loss [dB]	Atten. Loss [dB]	Antenna Gain [dBi]	Result (Cond.)		Result (e.i.r.p.)		Limit (Cond.)		Limit (e.i.r.p.)		Margin (Cond.)	Margin (e.i.r.p.)
					[dBm]	[mW]	[dBm]	[mW]	[dBm]	[mW]	[dBm]	[mW]	[dB]	[dB]
					5180.0	3.11	1.23	10.11	3.90	14.45	27.86	18.35	68.39	23.97
5220.0	3.12	1.24	10.11	3.90	14.47	27.99	18.37	68.71	23.97	250.00	-	-	9.50	-
5240.0	3.15	1.24	10.11	3.90	14.50	28.18	18.40	69.18	23.97	250.00	-	-	9.47	-
5260.0	3.18	1.24	10.11	3.90	14.53	28.38	18.43	69.66	23.97	250.00	-	-	9.44	-
5300.0	2.46	1.25	10.11	3.90	13.82	24.10	17.72	59.16	23.97	250.00	-	-	10.15	-
5320.0	2.40	1.26	10.11	3.90	13.77	23.82	17.67	58.48	23.97	250.00	-	-	10.20	-
5500.0	1.23	1.29	10.12	3.90	12.64	18.37	16.54	45.08	23.97	250.00	-	-	11.33	-
5580.0	1.96	1.30	10.12	3.90	13.38	21.78	17.28	53.46	23.97	250.00	-	-	10.59	-
5700.0	1.40	1.31	10.11	3.90	12.82	19.14	16.72	46.99	23.97	250.00	-	-	11.15	-

Antenna port 1

Freq. [MHz]	P/M Reading [dBm]	Cable Loss [dB]	Atten. Loss [dB]	Antenna Gain [dBi]	Result (Cond.)		Result (e.i.r.p.)		Limit (Cond.)		Limit (e.i.r.p.)		Margin (Cond.)	Margin (e.i.r.p.)
					[dBm]	[mW]	[dBm]	[mW]	[dBm]	[mW]	[dBm]	[mW]	[dB]	[dB]
					5180.0	1.72	1.23	10.11	3.90	13.06	20.23	16.96	49.66	23.97
5220.0	1.63	1.24	10.11	3.90	12.98	19.86	16.88	48.75	23.97	250.00	-	-	10.99	-
5240.0	1.70	1.24	10.11	3.90	13.05	20.18	16.95	49.55	23.97	250.00	-	-	10.92	-
5260.0	1.69	1.24	10.11	3.90	13.04	20.14	16.94	49.43	23.97	250.00	-	-	10.93	-
5300.0	0.90	1.25	10.11	3.90	12.26	16.83	16.16	41.30	23.97	250.00	-	-	11.71	-
5320.0	1.28	1.26	10.11	3.90	12.65	18.41	16.55	45.19	23.97	250.00	-	-	11.32	-
5500.0	1.08	1.29	10.12	3.90	12.49	17.74	16.39	43.55	23.97	250.00	-	-	11.48	-
5580.0	1.75	1.30	10.12	3.90	13.17	20.75	17.07	50.93	23.97	250.00	-	-	10.80	-
5700.0	1.01	1.31	10.11	3.90	12.43	17.50	16.33	42.95	23.97	250.00	-	-	11.54	-

Result(Cond.) = Reading + Cable Loss + Atten.Loss

Result(e.i.r.p.) = Reading + Cable Loss + Atten.Loss + Antenna Gain

15.407(a)(1)(iv) Limit(Cond.) = 23.97dBm(250mW)

Although the EUT operates on Master mode, more stringent limit for Client device was applied.

15.407(a)(2) Limit(Cond.) = 23.97dBm(250mW) or 11 + 10log(26dB BW) dBm

Maximum Conducted Output Power

Test place : Ise EMC Lab. No.11 Measurement Room
Report No. : 10604551H
Date : 03/09/2015
Temperature/ Humidity : 23deg. C / 33% RH
Engineer : Shinichi Miyazono
Mode : 11n-40 Tx

Antenna port 0+1

Freq. [MHz]	Antenna Port 0 Result		Antenna Port 1 Result		Result Antenna Port 0+1 (Cond.)		Result Antenna Port 0+1 (e.i.r.p.)		Limit (Cond.)		Limit (e.i.r.p.)		Margin (Cond.)	Margin (e.i.r.p.)
	(Cond.)	(e.i.r.p.)	(Cond.)	(e.i.r.p.)	(dBm)	[mW]	(dBm)	[mW]	(dBm)	[mW]	(dBm)	[mW]	[dB]	[dB]
	[mW]	[mW]	[mW]	[mW]	[dBm]	[mW]	[dBm]	[mW]	[dBm]	[mW]	[dBm]	[mW]	[dB]	[dB]
5190.0	18.58	45.60	13.21	32.43	15.02	31.79	18.92	78.04	23.97	250.00	-	-	8.95	-
5230.0	17.22	42.27	13.12	32.21	14.82	30.34	18.72	74.48	23.97	250.00	-	-	9.15	-
5270.0	16.11	39.54	12.05	29.58	14.50	28.16	18.40	69.12	23.97	250.00	-	-	9.47	-
5310.0	14.16	34.75	10.99	26.98	14.01	25.15	17.91	61.73	23.97	250.00	-	-	9.96	-
5510.0	11.51	28.25	11.19	27.48	13.56	22.70	17.46	55.73	23.97	250.00	-	-	10.41	-
5550.0	12.62	30.97	12.27	30.13	13.96	24.89	17.86	61.10	23.97	250.00	-	-	10.01	-
5670.0	12.76	31.33	11.80	28.97	13.90	24.57	17.80	60.31	23.97	250.00	-	-	10.07	-

Antenna port 0

Freq. [MHz]	P/M Reading [dBm]	Cable Loss [dB]	Atten. Loss [dB]	Antenna Gain [dBi]	Result (Cond.)		Result (e.i.r.p.)		Limit (Cond.)		Limit (e.i.r.p.)		Margin (Cond.) [dB]	Margin (e.i.r.p.) [dB]
					[dBm]	[mW]	[dBm]	[mW]	[dBm]	[mW]	[dBm]	[mW]		
5190.0	1.35	1.23	10.11	3.90	12.69	18.58	16.59	45.60	23.97	250.00	-	-	11.28	-
5230.0	1.01	1.24	10.11	3.90	12.36	17.22	16.26	42.27	23.97	250.00	-	-	11.61	-
5270.0	0.71	1.25	10.11	3.90	12.07	16.11	15.97	39.54	23.97	250.00	-	-	11.90	-
5310.0	0.15	1.25	10.11	3.90	11.51	14.16	15.41	34.75	23.97	250.00	-	-	12.46	-
5510.0	-0.80	1.29	10.12	3.90	10.61	11.51	14.51	28.25	23.97	250.00	-	-	13.36	-
5550.0	-0.40	1.29	10.12	3.90	11.01	12.62	14.91	30.97	23.97	250.00	-	-	12.96	-
5670.0	-0.35	1.30	10.11	3.90	11.06	12.76	14.96	31.33	23.97	250.00	-	-	12.91	-

Antenna port 1

Freq. [MHz]	P/M Reading [dBm]	Cable Loss [dB]	Atten. Loss [dB]	Antenna Gain [dBi]	Result (Cond.)		Result (e.i.r.p.)		Limit (Cond.)		Limit (e.i.r.p.)		Margin (Cond.) [dB]	Margin (e.i.r.p.) [dB]
					[dBm]	[mW]	[dBm]	[mW]	[dBm]	[mW]	[dBm]	[mW]		
5190.0	-0.13	1.23	10.11	3.90	11.21	13.21	15.11	32.43	23.97	250.00	-	-	12.76	-
5230.0	-0.17	1.24	10.11	3.90	11.18	13.12	15.08	32.21	23.97	250.00	-	-	12.79	-
5270.0	-0.55	1.25	10.11	3.90	10.81	12.05	14.71	29.58	23.97	250.00	-	-	13.16	-
5310.0	-0.95	1.25	10.11	3.90	10.41	10.99	14.31	26.98	23.97	250.00	-	-	13.56	-
5510.0	-0.92	1.29	10.12	3.90	10.49	11.19	14.39	27.48	23.97	250.00	-	-	13.48	-
5550.0	-0.52	1.29	10.12	3.90	10.89	12.27	14.79	30.13	23.97	250.00	-	-	13.08	-
5670.0	-0.69	1.30	10.11	3.90	10.72	11.80	14.62	28.97	23.97	250.00	-	-	13.25	-

Result(Cond.) = Reading + Cable Loss + Atten.Loss

Result(e.i.r.p.) = Reading + Cable Loss + Atten.Loss + Antenna Gain

15.407(a)(1)(iv) Limit(Cond.) = 23.97dBm(250mW)

Although the EUT operates on Master mode, more stringent limit for Client device was applied.

15.407(a)(2) Limit(Cond.) = 23.97dBm(250mW) or 11 + 10log(26dB BW) dBm

UL Japan, Inc.

Ise EMC Lab.

4383-326 Asama-cho, Ise-shi, Mie-ken 516-0021 JAPAN

Telephone : +81 596 24 8999

Facsimile : +81 596 24 8124

Maximum Conducted Output Power
(Reference data)

Test place : Ise EMC Lab. No.6 Measurement Room
Report No. : 10604551H
Date : 02/20/2015
Temperature/ Humidity : 23deg.C. / 34%
Engineer : Takumi Shimada
Mode : 11a Tx

11a, 5180MHz, Antenna port 0

Data Rate [Mbps]	Reading [dBm]	Remark
6	0.78	
9	0.97	
12	0.94	
18	1.01	*
24	0.72	
36	0.70	
48	0.83	
54	-0.57	

* Worst Rate

All comparisons were carried out on same frequency and measurement factors.

11a, 5180MHz, Antenna port 1

MCS Number	Reading [dBm]	Remark
6	-0.15	
9	-0.15	
12	-0.08	
18	-0.01	*
24	-0.04	
36	-0.05	
48	-0.33	
54	-1.82	

* Worst Rate

All comparisons were carried out on same frequency and measurement factors.

Maximum Conducted Output Power
(Reference data)

Test place : Ise EMC Lab. No.6 Measurement Room
Report No. : 10604551H
Date : 02/20/2015
Temperature/ Humidity : 23deg.C. / 34%
Engineer : Takumi Shimada
Mode : 11n-20 Tx

5180MHz

MCS Number	Reading		Reading		Result		Remark
	Antenna port 0		Antenna port 1		Antenna port 0 + 1		
	[dBm]	[mW]	[dBm]	[mW]	[dBm]	[mW]	
0	2.01	1.59	0.73	1.18	-	-	
1	2.15	1.64	0.82	1.21	-	-	*SISO
2	1.84	1.53	0.64	1.16	-	-	
3	1.85	1.53	0.80	1.20	-	-	
4	1.95	1.57	0.77	1.19	-	-	
5	0.90	1.23	-0.57	0.88	-	-	
6	-0.08	0.98	-1.27	0.75	-	-	
7	-2.45	0.57	-3.31	0.47	-	-	
8	2.40	1.74	1.23	1.33	4.86	3.07	
9	2.46	1.76	1.33	1.36	4.94	3.12	
10	2.67	1.85	1.38	1.37	5.08	3.22	
11	2.57	1.81	1.42	1.39	5.04	3.19	
12	2.64	1.84	1.57	1.44	5.15	3.27	*MIMO
13	1.44	1.39	0.18	1.04	3.87	2.44	
14	-0.18	0.96	-0.69	0.85	2.58	1.81	
15	-1.39	0.73	-3.58	0.44	0.66	1.16	

* Worst MCS

All comparisons were carried out on same frequency and measurement factors.

5180MHz

MCS Number	Reading Antenna port 0 [dBm]	Reading Antenna port 1 [dBm]	Result Antenna port 0+1 [dBm]	GI	Remark
1	2.15	0.82	-	Long	
1	2.29	0.98	-	Short	*
12	2.64	1.57	5.15	Long	
12	2.86	1.61	5.29	Short	*

* Worst GI

All comparisons were carried out on same frequency and measurement factors.

Maximum Conducted Output Power
(Reference data)

Test place : Ise EMC Lab. No.6 Measurement Room
Report No. : 10604551H
Date : 02/20/2015
Temperature/ Humidity : 23deg.C. / 34%
Engineer : Takumi Shimada
Mode : 11n-40 Tx

5190MHz

MCS Number	Reading		Reading		Result		Remark
	Antenna port 0		Antenna port 1		Antenna port 0 + 1		
	[dBm]	[mW]	[dBm]	[mW]	[dBm]	[mW]	
0	-0.31	0.93	-1.33	0.74	-	-	
1	-0.33	0.93	-1.52	0.70	-	-	
2	-0.27	0.94	-1.09	0.78	-	-	*SISO
3	-0.61	0.87	-1.25	0.75	-	-	
4	-0.57	0.88	-1.19	0.76	-	-	
5	-0.56	0.88	-1.21	0.76	-	-	
6	-0.44	0.90	-1.12	0.77	-	-	
7	-1.33	0.74	-2.05	0.62	-	-	
8	0.42	1.10	-0.80	0.83	2.86	1.93	
9	0.17	1.04	-0.82	0.83	2.71	1.87	
10	0.41	1.10	-0.87	0.82	2.83	1.92	
11	0.43	1.10	-0.66	0.86	2.93	1.96	*MIMO
12	-0.03	0.99	-1.16	0.77	2.45	1.76	
13	0.12	1.03	-0.99	0.80	2.61	1.82	
14	-0.06	0.99	-1.05	0.79	2.48	1.77	
15	-1.10	0.78	-2.26	0.59	1.37	1.37	

* Worst MCS

All comparisons were carried out on same frequency and measurement factors.

5190MHz

MCS Number	Reading Antenna port 0 [dBm]	Reading Antenna port 1 [dBm]	Result Antenna port 0+1 [dBm]	GI	Remark
2	-0.27	-1.09	-	Long	
2	-0.19	-0.99	-	Short	*
11	0.43	-0.66	2.93	Long	*
11	0.33	-0.99	2.73	Short	

* Worst GI

All comparisons were carried out on same frequency and measurement factors.

Maximum Average Output Power (Reference data for SAR testing)

Test place : Ise EMC Lab. No.11 Measurement Room
Report No. : 10604551H
Date : 03/12/2015 05/14/2015 Night
Temperature/ Humidity : 24deg. C / 31% RH 25deg. C / 52% RH
Engineer : Shinichi Miyazono Shinichi Miyazono
Mode : 11a Tx

[AV]

Antenna port 0

Freq. [MHz]	P/M Reading [dBm]	Cable Loss [dB]	Atten. Loss [dB]	Antenna Gain [dBi]	Result (Cond.)		Result (e.i.r.p.)	
					[dBm]	[mW]	[dBm]	[mW]
5180.0	2.04	1.23	10.08	3.90	13.35	21.63	17.25	53.09
5220.0	2.58	1.24	10.08	3.90	13.90	24.55	17.80	60.26
5240.0	2.35	1.24	10.08	3.90	13.67	23.28	17.57	57.15
5260.0	2.29	1.24	10.08	3.90	13.61	22.96	17.51	56.36
5300.0	1.80	1.25	10.08	3.90	13.13	20.56	17.03	50.47
5320.0	1.59	1.26	10.08	3.90	12.93	19.63	16.83	48.19
5500.0	1.24	1.29	10.09	3.90	12.62	18.28	16.52	44.87
5580.0	1.34	1.30	10.08	3.90	12.72	18.71	16.62	45.92
5700.0	1.23	1.31	10.07	3.90	12.61	18.24	16.51	44.77

Result(Cond.) = Reading + Cable Loss + Atten.Loss

Result(e.i.r.p.) = Reading + Cable Loss + Atten.Loss + Antenna Gain

Antenna port 1

Freq. [MHz]	P/M Reading [dBm]	Cable Loss [dB]	Atten. Loss [dB]	Antenna Gain [dBi]	Result (Cond.)		Result (e.i.r.p.)	
					[dBm]	[mW]	[dBm]	[mW]
5180.0	1.35	1.23	10.08	3.90	12.66	18.45	16.56	45.29
5220.0	1.32	1.24	10.08	3.90	12.64	18.37	16.54	45.08
5240.0	1.16	1.24	10.08	3.90	12.48	17.70	16.38	43.45
5260.0	0.60	1.24	10.08	3.90	11.92	15.56	15.82	38.19
5300.0	0.51	1.25	10.08	3.90	11.84	15.28	15.74	37.50
5320.0	0.69	1.26	10.08	3.90	12.03	15.96	15.93	39.17
5500.0	0.94	1.29	10.09	3.90	12.32	17.06	16.22	41.88
5580.0	1.24	1.30	10.08	3.90	12.62	18.28	16.52	44.87
5700.0	0.92	1.31	10.07	3.90	12.30	16.98	16.20	41.69

Result(Cond.) = Reading + Cable Loss + Atten.Loss

Result(e.i.r.p.) = Reading + Cable Loss + Atten.Loss + Antenna Gain

Maximum Average Output Power (Reference data for SAR testing)

Test place Ise EMC Lab. No.11 Measurement Room
Report No. 10604551H
Date 03/12/2015 05/14/2015 Night
Temperature/ Humidity 24deg. C / 31% RH 25deg. C / 52% RH
Engineer Shinichi Miyazono Shinichi Miyazono
Mode 11n-20 Tx

[AV]

Antenna port 0+1

Freq. [MHz]	Antenna Port 0 Result		Antenna Port 1 Result		Result Antenna Port 0+1 (Cond.)		Result Antenna Port 0+1 (e.i.r.p.)	
	(Cond.)	(e.i.r.p.)	(Cond.)	(e.i.r.p.)	[dBm]	[mW]	[dBm]	[mW]
	[mW]	[mW]	[mW]	[mW]				
5180.0	26.85	65.92	19.54	47.97	16.66	46.40	20.56	113.89
5220.0	27.04	66.37	18.84	46.24	16.62	45.88	20.52	112.61
5240.0	27.35	67.14	19.82	48.64	16.74	47.17	20.64	115.78
5260.0	26.73	65.61	17.66	43.35	16.47	44.39	20.37	108.97
5300.0	23.77	58.34	16.75	41.11	16.08	40.52	19.98	99.46
5320.0	22.80	55.98	16.52	40.55	15.95	39.32	19.85	96.53
5500.0	17.74	43.55	17.14	42.07	15.43	34.88	19.33	85.62
5600.0	20.32	49.89	19.91	48.87	16.05	40.23	19.95	98.75
5700.0	18.66	45.81	16.00	39.26	15.40	34.66	19.30	85.08

Antenna port 0

Freq. [MHz]	P/M Reading [dBm]	Cable Loss [dB]	Atten. Loss [dB]	Antenna Gain [dBi]	Result (Cond.)		Result (e.i.r.p.)	
					[dBm]	[mW]	[dBm]	[mW]
5180.0	2.98	1.23	10.08	3.90	14.29	26.85	18.19	65.92
5220.0	3.00	1.24	10.08	3.90	14.32	27.04	18.22	66.37
5240.0	3.05	1.24	10.08	3.90	14.37	27.35	18.27	67.14
5260.0	2.95	1.24	10.08	3.90	14.27	26.73	18.17	65.61
5300.0	2.43	1.25	10.08	3.90	13.76	23.77	17.66	58.34
5320.0	2.24	1.26	10.08	3.90	13.58	22.80	17.48	55.98
5500.0	1.11	1.29	10.09	3.90	12.49	17.74	16.39	43.55
5580.0	1.70	1.30	10.08	3.90	13.08	20.32	16.98	49.89
5700.0	1.33	1.31	10.07	3.90	12.71	18.66	16.61	45.81

Antenna port 1

Freq. [MHz]	P/M Reading [dBm]	Cable Loss [dB]	Atten. Loss [dB]	Antenna Gain [dBi]	Result (Cond.)		Result (e.i.r.p.)	
					[dBm]	[mW]	[dBm]	[mW]
5180.0	1.60	1.23	10.08	3.90	12.91	19.54	16.81	47.97
5220.0	1.43	1.24	10.08	3.90	12.75	18.84	16.65	46.24
5240.0	1.65	1.24	10.08	3.90	12.97	19.82	16.87	48.64
5260.0	1.15	1.24	10.08	3.90	12.47	17.66	16.37	43.35
5300.0	0.91	1.25	10.08	3.90	12.24	16.75	16.14	41.11
5320.0	0.84	1.26	10.08	3.90	12.18	16.52	16.08	40.55
5500.0	0.96	1.29	10.09	3.90	12.34	17.14	16.24	42.07
5580.0	1.61	1.30	10.08	3.90	12.99	19.91	16.89	48.87
5700.0	0.66	1.31	10.07	3.90	12.04	16.00	15.94	39.26

Maximum Average Output Power (Reference data for SAR testing)

Test place : Ise EMC Lab. No.11 Measurement Room
Report No. : 10604551H
Date : 03/12/2015
Temperature/ Humidity : 24deg. C / 31% RH
Engineer : Shinichi Miyazono
Mode : 11n-40 Tx

[AV]

Antenna port 0+1

Freq. [MHz]	Antenna Port 0 Result		Antenna Port 1 Result		Result Antenna Port 0+1 (Cond.)		Result Antenna Port 0+1 (e.i.r.p.)	
	(Cond.) [mW]	(e.i.r.p.) [mW]	(Cond.) [mW]	(e.i.r.p.) [mW]	[dBm]	[mW]	[dBm]	[mW]
	5190.0	15.28	37.50	12.53	30.76	14.44	27.81	18.34
5230.0	15.67	38.46	11.97	29.38	14.41	27.63	18.31	67.84
5270.0	14.96	36.73	11.22	27.54	14.18	26.18	18.08	64.27
5310.0	14.00	34.36	9.98	24.49	13.80	23.97	17.70	58.85
5510.0	11.38	27.93	10.86	26.67	13.47	22.24	17.37	54.59
5550.0	12.16	29.85	11.53	28.31	13.75	23.70	17.65	58.17
5670.0	11.43	28.05	10.86	26.67	13.48	22.29	17.38	54.72

Antenna port 0

Freq. [MHz]	P/M Reading [dBm]	Cable Loss [dB]	Atten. Loss [dB]	Antenna Gain [dBi]	Result (Cond.)		Result (e.i.r.p.)	
					[dBm]	[mW]	[dBm]	[mW]
5190.0	0.53	1.23	10.08	3.90	11.84	15.28	15.74	37.50
5230.0	0.63	1.24	10.08	3.90	11.95	15.67	15.85	38.46
5270.0	0.42	1.25	10.08	3.90	11.75	14.96	15.65	36.73
5310.0	0.13	1.25	10.08	3.90	11.46	14.00	15.36	34.36
5510.0	-0.82	1.29	10.09	3.90	10.56	11.38	14.46	27.93
5550.0	-0.53	1.29	10.09	3.90	10.85	12.16	14.75	29.85
5670.0	-0.80	1.30	10.08	3.90	10.58	11.43	14.48	28.05

Antenna port 1

Freq. [MHz]	P/M Reading [dBm]	Cable Loss [dB]	Atten. Loss [dB]	Antenna Gain [dBi]	Result (Cond.)		Result (e.i.r.p.)	
					[dBm]	[mW]	[dBm]	[mW]
5190.0	-0.33	1.23	10.08	3.90	10.98	12.53	14.88	30.76
5230.0	-0.54	1.24	10.08	3.90	10.78	11.97	14.68	29.38
5270.0	-0.83	1.25	10.08	3.90	10.50	11.22	14.40	27.54
5310.0	-1.34	1.25	10.08	3.90	9.99	9.98	13.89	24.49
5510.0	-1.02	1.29	10.09	3.90	10.36	10.86	14.26	26.67
5550.0	-0.76	1.29	10.09	3.90	10.62	11.53	14.52	28.31
5670.0	-1.02	1.30	10.08	3.90	10.36	10.86	14.26	26.67

Result(Cond.) = Reading + Cable Loss + Atten.Loss

Maximum Average Output Power (Reference data for SAR testing)

Test place : Ise EMC Lab. No.11 Measurement Room
Report No. : 10604551H
Date : 03/12/2015
Temperature/ Humidity : 24deg. C / 31% RH
Engineer : Shinichi Miyazono
Mode : 11a Tx

[AV]

11a, 5180MHz, Antenna port 0

Data Rate [Mbps]	Reading [dBm]	Remark
6	2.04	*
9	1.99	
12	1.95	
18	1.81	
24	1.67	
36	1.57	
48	1.36	
54	-0.18	

* Worst Rate

All comparisons were carried out on same frequency and measurement factors.

11a, 5180MHz, Antenna port 1

MCS Number	Reading [dBm]	Remark
6	1.35	*
9	1.10	
12	1.09	
18	0.95	
24	0.84	
36	0.73	
48	0.52	
54	-1.05	

* Worst Rate

All comparisons were carried out on same frequency and measurement factors.

UL Japan, Inc.

Ise EMC Lab.

4383-326 Asama-cho, Ise-shi, Mie-ken 516-0021 JAPAN

Telephone : +81 596 24 8999

Facsimile : +81 596 24 8124

Maximum Average Output Power (Reference data for SAR testing)

Test place Ise EMC Lab. No.11 Measurement Room
Report No. 10604551H
Date 03/12/2015
Temperature/ Humidity 24deg. C / 31% RH
Engineer Shinichi Miyazono
Mode 11n-20 Tx

[AV]
5180MHz

MCS Number	Reading		Reading		Result		Remark
	Antenna port 0		Antenna port 1		Antenna port 0 + 1		
	[dBm]	[mW]	[dBm]	[mW]	[dBm]	[mW]	
0	2.71	1.87	2.03	1.60	-	-	
1	3.04	2.01	2.16	1.64	-	-	*SISO
2	2.60	1.82	1.84	1.53	-	-	
3	2.62	1.83	1.79	1.51	-	-	
4	2.12	1.63	1.61	1.45	-	-	
5	1.28	1.34	0.33	1.08	-	-	
6	0.16	1.04	-0.68	0.86	-	-	
7	-2.14	0.61	-2.94	0.51	-	-	
8	3.17	2.07	2.11	1.63	5.68	3.70	*MIMO
9	2.75	1.88	2.12	1.63	5.46	3.51	
10	2.74	1.88	1.96	1.57	5.38	3.45	
11	2.61	1.82	1.79	1.51	5.23	3.33	
12	2.25	1.68	1.41	1.38	4.86	3.06	
13	0.81	1.21	-0.13	0.97	3.38	2.18	
14	-0.28	0.94	-1.31	0.74	2.25	1.68	
15	-2.50	0.56	-3.27	0.47	0.14	1.03	

* Worst MCS

All comparisons were carried out on same frequency and measurement factors.

5180MHz

MCS Number	Reading Antenna port 0 [dBm]	Reading Antenna port 1 [dBm]	Result Antenna port 0+1 [dBm]	GI	Remark
1	3.04	2.16	-	Long	*
1	2.87	1.99	-	Short	
8	3.17	2.11	5.68	Long	
8	3.20	2.19	5.73	Short	*

* Worst GI

All comparisons were carried out on same frequency and measurement factors.

Maximum Average Output Power (Reference data for SAR testing)

Test place : Ise EMC Lab. No.11 Measurement Room
Report No. : 10604551H
Date : 03/12/2015
Temperature/ Humidity : 24deg. C / 31% RH
Engineer : Shinichi Miyazono
Mode : 11n-40 Tx

[AV]
5190MHz

MCS Number	Reading Antenna port 0		Reading Antenna port 1		Result Antenna port 0 + 1		Remark
	[dBm]	[mW]	[dBm]	[mW]	[dBm]	[mW]	
	0	0.60	1.15	-0.24	0.95	-	
1	0.31	1.07	-0.36	0.92	-	-	
2	0.06	1.01	-0.51	0.89	-	-	
3	-0.02	1.00	-0.70	0.85	-	-	
4	-0.30	0.93	-0.92	0.81	-	-	
5	-0.48	0.90	-1.07	0.78	-	-	
6	-0.62	0.87	-1.21	0.76	-	-	
7	-1.47	0.71	-2.17	0.61	-	-	
8	0.45	1.11	-0.40	0.91	3.06	2.02	*MIMO
9	0.12	1.03	-0.71	0.85	2.74	1.88	
10	0.04	1.01	-0.96	0.80	2.58	1.81	
11	-0.23	0.95	-1.09	0.78	2.37	1.73	
12	-0.41	0.91	-1.34	0.73	2.16	1.64	
13	-0.57	0.88	-1.45	0.72	2.02	1.59	
14	-0.87	0.82	-1.59	0.69	1.80	1.51	
15	-1.87	0.65	-2.56	0.55	0.81	1.20	

* Worst MCS

All comparisons were carried out on same frequency and measurement factors.

5190MHz

MCS Number	Reading Antenna port 0 [dBm]	Reading Antenna port 1 [dBm]	Result Antenna port 0+1 [dBm]	GI	Remark
0	0.60	-0.24	-	Long	*
0	0.51	-0.36	-	Short	
8	0.45	-0.40	3.06	Long	
8	0.53	-0.33	3.13	Short	*

* Worst GI

All comparisons were carried out on same frequency and measurement factors.

Maximum Power Spectral Density

Test place : Ise EMC Lab. No.11 Measurement Room
Report No. : 10604551H
Date : 03/10/2015
Temperature/ Humidity : 23deg. C / 30% RH
Engineer : Shinichi Miyazono
Mode : 11a Tx

11a Antenna port 0

Freq. [MHz]	Reading [dBm]	Cable Loss [dB]	Atten. Loss [dB]	Duty factor [dB]	Correction factor [dB]	Result [dBm]	Limit [dBm]	Margin [dB]
5180.0	-10.993	3.13	10.11	0.39	0.00	2.64	11.00	8.36
5220.0	-10.410	3.15	10.11	0.39	0.00	3.24	11.00	7.76
5240.0	-10.561	3.15	10.11	0.39	0.00	3.09	11.00	7.91
5260.0	-10.744	3.15	10.11	0.39	0.00	2.91	11.00	8.09
5300.0	-11.611	3.17	10.11	0.39	0.00	2.06	11.00	8.94
5320.0	-11.858	3.18	10.11	0.39	0.00	1.82	11.00	9.18
5500.0	-11.443	3.24	10.12	0.39	0.00	2.31	11.00	8.69
5580.0	-11.342	3.27	10.12	0.39	0.00	2.44	11.00	8.56
5700.0	-11.472	3.31	10.11	0.39	0.00	2.34	11.00	8.66

Result = Reading + Cable Loss + Attenuator + Duty factor + Correction factor

11a Antenna port 1

Freq. [MHz]	Reading [dBm]	Cable Loss [dB]	Atten. Loss [dB]	Duty factor [dB]	Correction factor [dB]	Result [dBm]	Limit [dBm]	Margin [dB]
5180.0	-11.013	3.13	10.11	0.39	0.00	2.62	11.00	8.38
5220.0	-10.906	3.15	10.11	0.39	0.00	2.74	11.00	8.26
5240.0	-11.206	3.15	10.11	0.39	0.00	2.44	11.00	8.56
5260.0	-11.347	3.15	10.11	0.39	0.00	2.30	11.00	8.70
5300.0	-11.643	3.17	10.11	0.39	0.00	2.03	11.00	8.97
5320.0	-10.951	3.18	10.11	0.39	0.00	2.73	11.00	8.27
5500.0	-11.636	3.24	10.12	0.39	0.00	2.11	11.00	8.89
5580.0	-11.177	3.27	10.12	0.39	0.00	2.60	11.00	8.40
5700.0	-12.487	3.31	10.11	0.39	0.00	1.32	11.00	9.68

Result = Reading + Cable Loss + Attenuator + Duty factor + Correction factor

Maximum Power Spectral Density

11a Antenna port 0

11a Antenna port 1

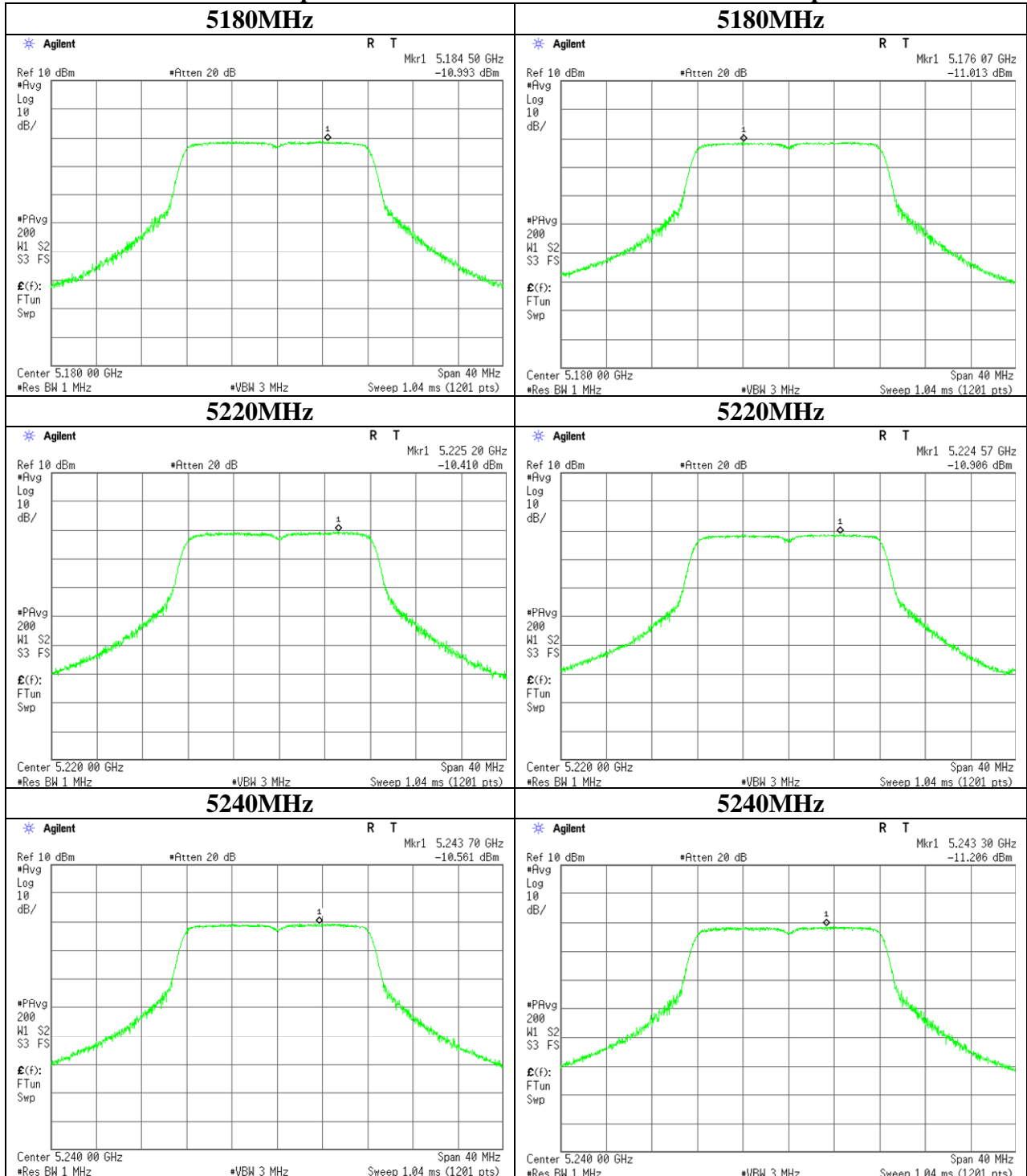

UL Japan, Inc.

Ise EMC Lab.

4383-326 Asama-cho, Ise-shi, Mie-ken 516-0021 JAPAN

Telephone : +81 596 24 8999

Facsimile : +81 596 24 8124

Maximum Power Spectral Density

11a Antenna port 0

11a Antenna port 1

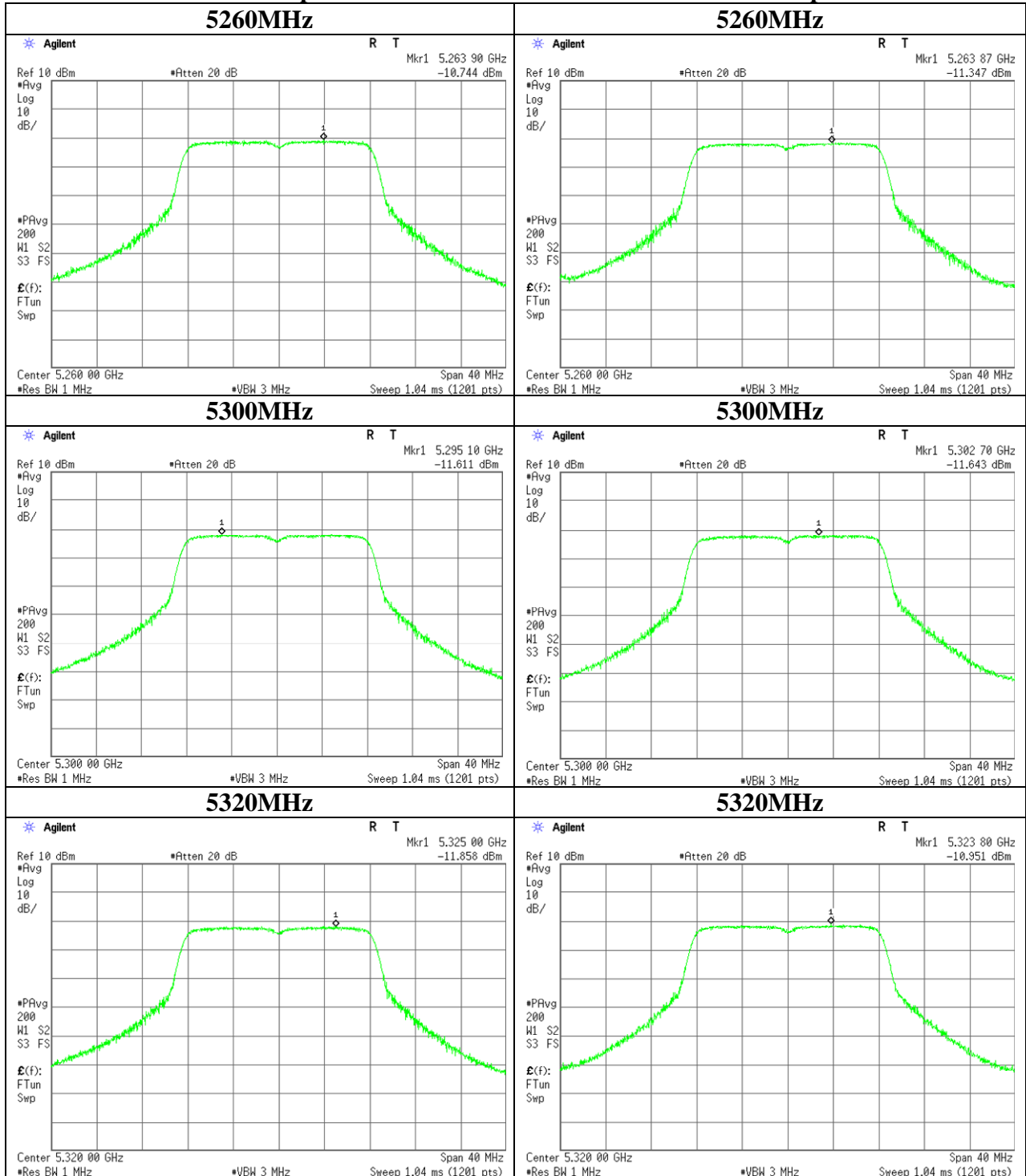

UL Japan, Inc.
Ise EMC Lab.

4383-326 Asama-cho, Ise-shi, Mie-ken 516-0021 JAPAN
 Telephone : +81 596 24 8999
 Facsimile : +81 596 24 8124

Maximum Power Spectral Density

11a Antenna port 0

11a Antenna port 1

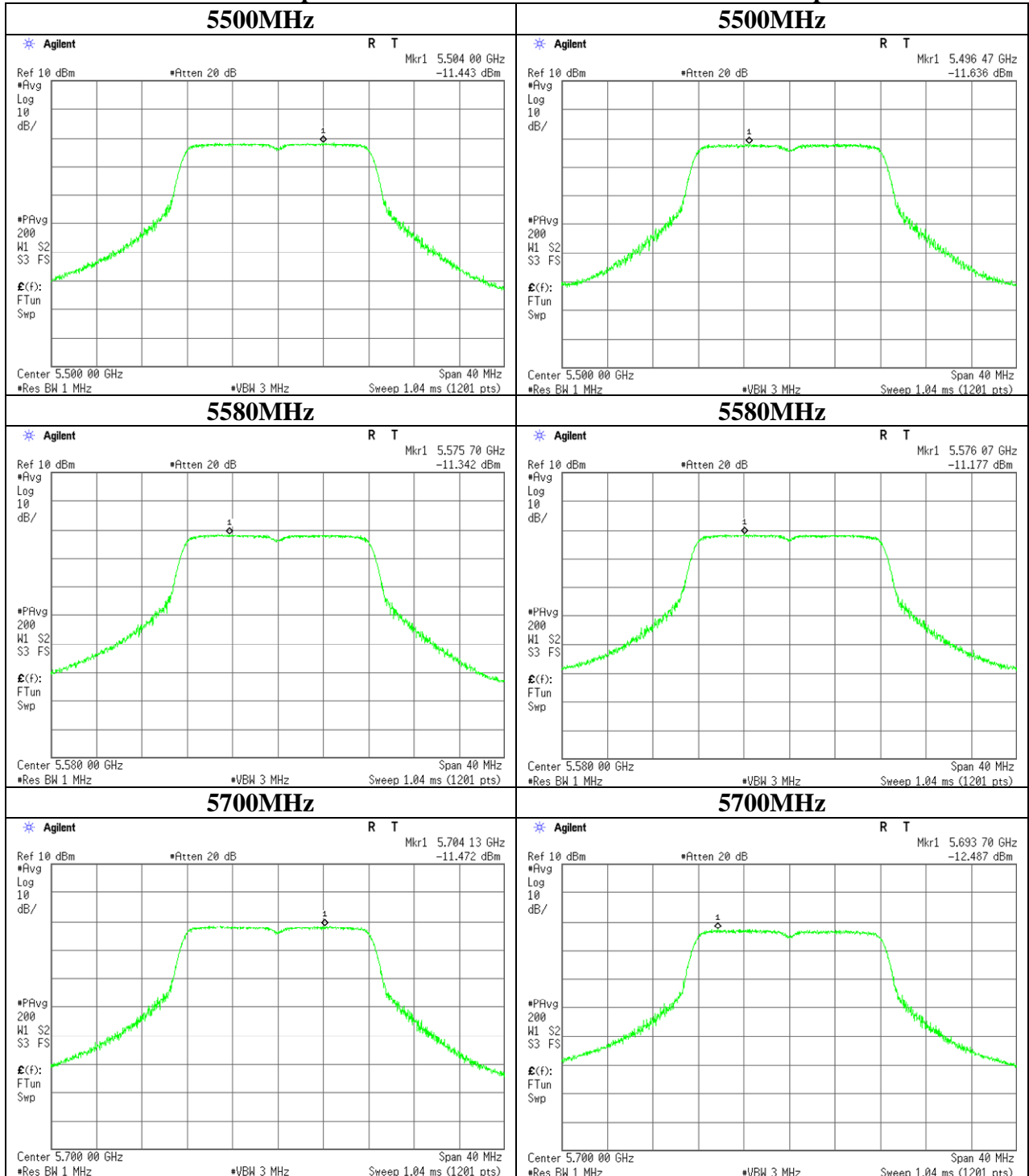

UL Japan, Inc.

Ise EMC Lab.

4383-326 Asama-cho, Ise-shi, Mie-ken 516-0021 JAPAN

Telephone : +81 596 24 8999

Facsimile : +81 596 24 8124

Maximum Power Spectral Density

Test place : Ise EMC Lab. No.11 Measurement Room
Report No. : 10604551H
Date : 03/10/2015
Temperature/ Humidity : 23deg. C / 30% RH
Engineer : Shinichi Miyazono
Mode : 11n-20 Tx

Antenna port 0 + 1

Freq. [MHz]	Antenna port 0 Result [mW]	Antenna port 1 Result [mW]	Result		Limit [dBm]	Margin [dB]
			Antenna port 0+1			
			[dBm]	[mW]		
5180.0	1.65	1.43	4.88	3.08	11.00	6.12
5220.0	1.81	1.39	5.05	3.20	11.00	5.95
5240.0	1.70	1.28	4.75	2.99	11.00	6.25
5260.0	2.65	1.77	6.45	4.42	11.00	4.55
5300.0	2.26	1.63	5.90	3.89	11.00	5.10
5320.0	2.14	1.43	5.53	3.57	11.00	5.47
5500.0	1.33	1.46	4.45	2.79	11.00	6.55
5580.0	1.63	1.64	5.15	3.27	11.00	5.85
5700.0	1.77	1.23	4.76	2.99	11.00	6.24

Result = Antenna Port 0 + 1

Antenna port 0

Freq. [MHz]	Reading [dBm]	Cable Loss [dB]	Atten. Loss [dB]	Duty factor [dB]	Correction factor [dB]	Result	
						[dBm]	[mW]
5180.0	-11.540	2.50	10.04	1.18	0.00	2.18	1.65
5220.0	-11.178	2.53	10.04	1.18	0.00	2.57	1.81
5240.0	-11.435	2.53	10.04	1.18	0.00	2.32	1.70
5260.0	-10.212	3.15	10.11	1.18	0.00	4.23	2.65
5300.0	-10.913	3.17	10.11	1.18	0.00	3.55	2.26
5320.0	-11.160	3.18	10.11	1.18	0.00	3.31	2.14
5500.0	-13.302	3.24	10.12	1.18	0.00	1.24	1.33
5580.0	-12.436	3.27	10.12	1.18	0.00	2.13	1.63
5700.0	-12.132	3.31	10.11	1.18	0.00	2.47	1.77

Result = Reading + Cable Loss + Attenuator + Duty Factor + Correction factor

Antenna port 1

Freq. [MHz]	Reading [dBm]	Cable Loss [dB]	Atten. Loss [dB]	Duty factor [dB]	Correction factor [dB]	Result	
						[dBm]	[mW]
5180.0	-12.181	2.50	10.04	1.18	0.00	1.54	1.43
5220.0	-12.308	2.53	10.04	1.18	0.00	1.44	1.39
5240.0	-12.668	2.53	10.04	1.18	0.00	1.08	1.28
5260.0	-11.956	3.15	10.11	1.18	0.00	2.48	1.77
5300.0	-12.340	3.17	10.11	1.18	0.00	2.12	1.63
5320.0	-12.922	3.18	10.11	1.18	0.00	1.55	1.43
5500.0	-12.898	3.24	10.12	1.18	0.00	1.64	1.46
5580.0	-12.430	3.27	10.12	1.18	0.00	2.14	1.64
5700.0	-13.704	3.31	10.11	1.18	0.00	0.90	1.23

Result = Reading + Cable Loss + Attenuator + Duty Factor + Correction factor

Maximum Power Spectral Density

11n-20 Antenna port 0

11n-20 Antenna port 1

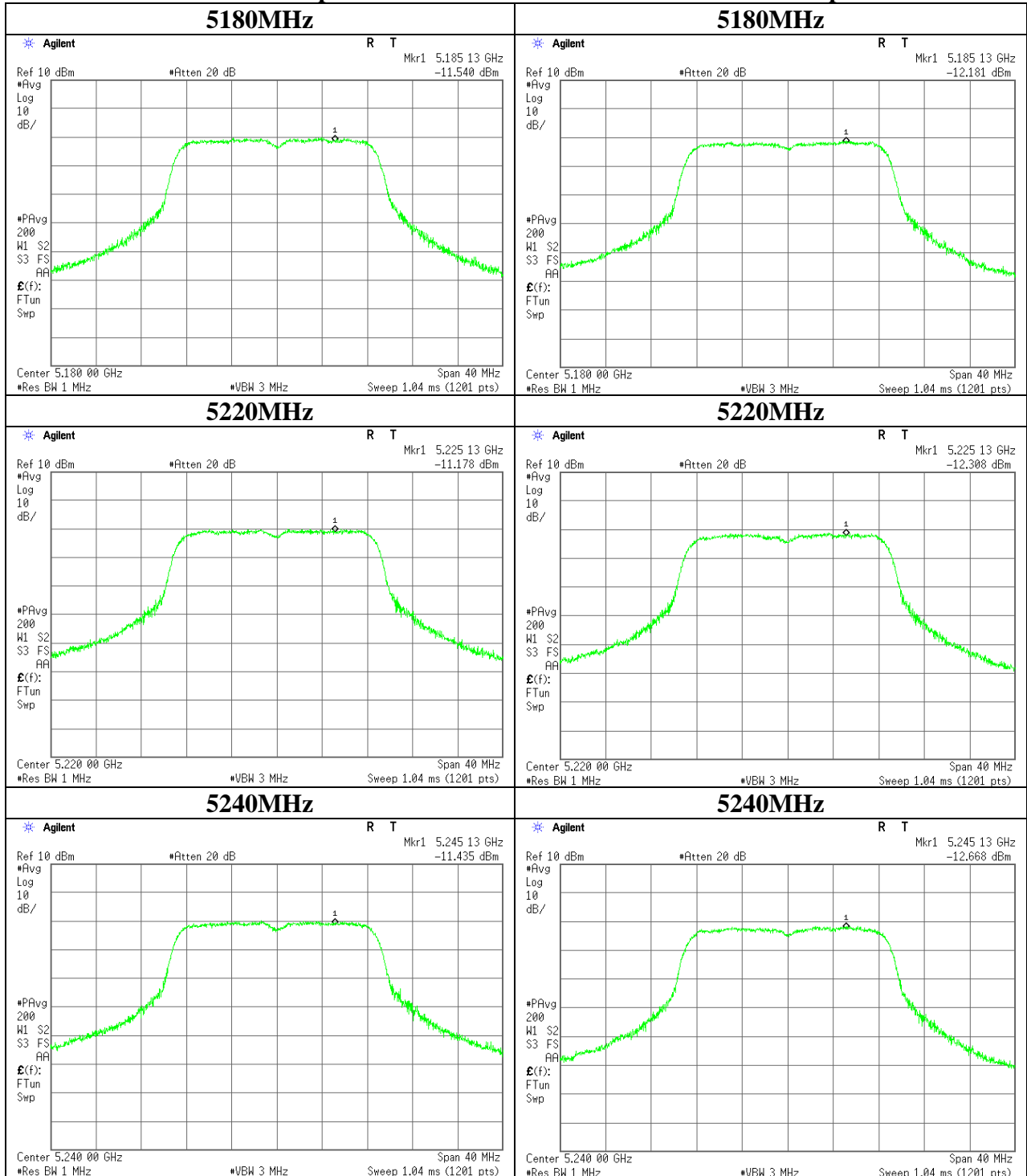

UL Japan, Inc.
Ise EMC Lab.

4383-326 Asama-cho, Ise-shi, Mie-ken 516-0021 JAPAN

Telephone : +81 596 24 8999

Facsimile : +81 596 24 8124

Maximum Power Spectral Density

11n-20 Antenna port 0

11n-20 Antenna port 1

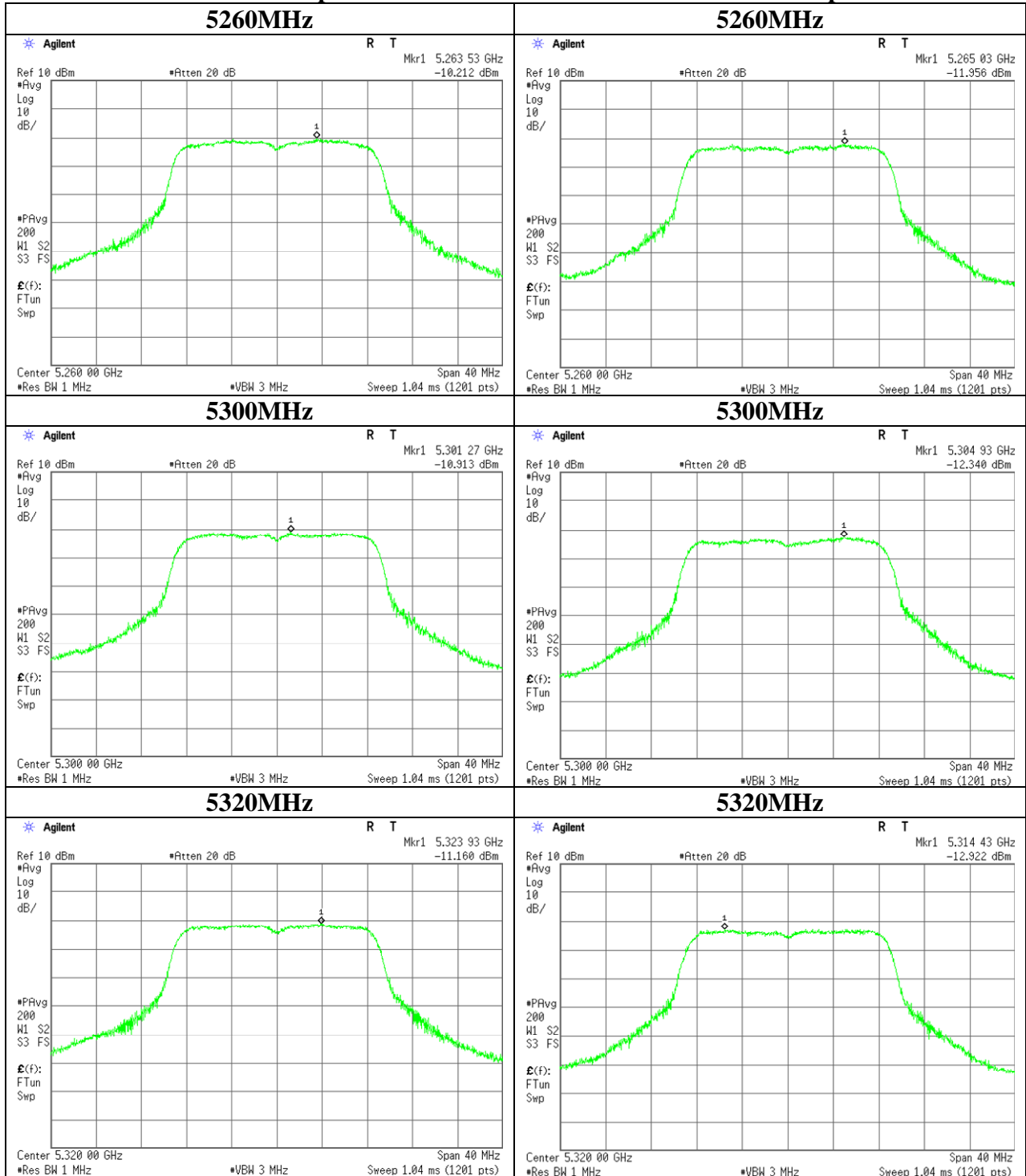

UL Japan, Inc.
Ise EMC Lab.

4383-326 Asama-cho, Ise-shi, Mie-ken 516-0021 JAPAN
 Telephone : +81 596 24 8999
 Facsimile : +81 596 24 8124

Maximum Power Spectral Density

11n-20 Antenna port 0

11n-20 Antenna port 0

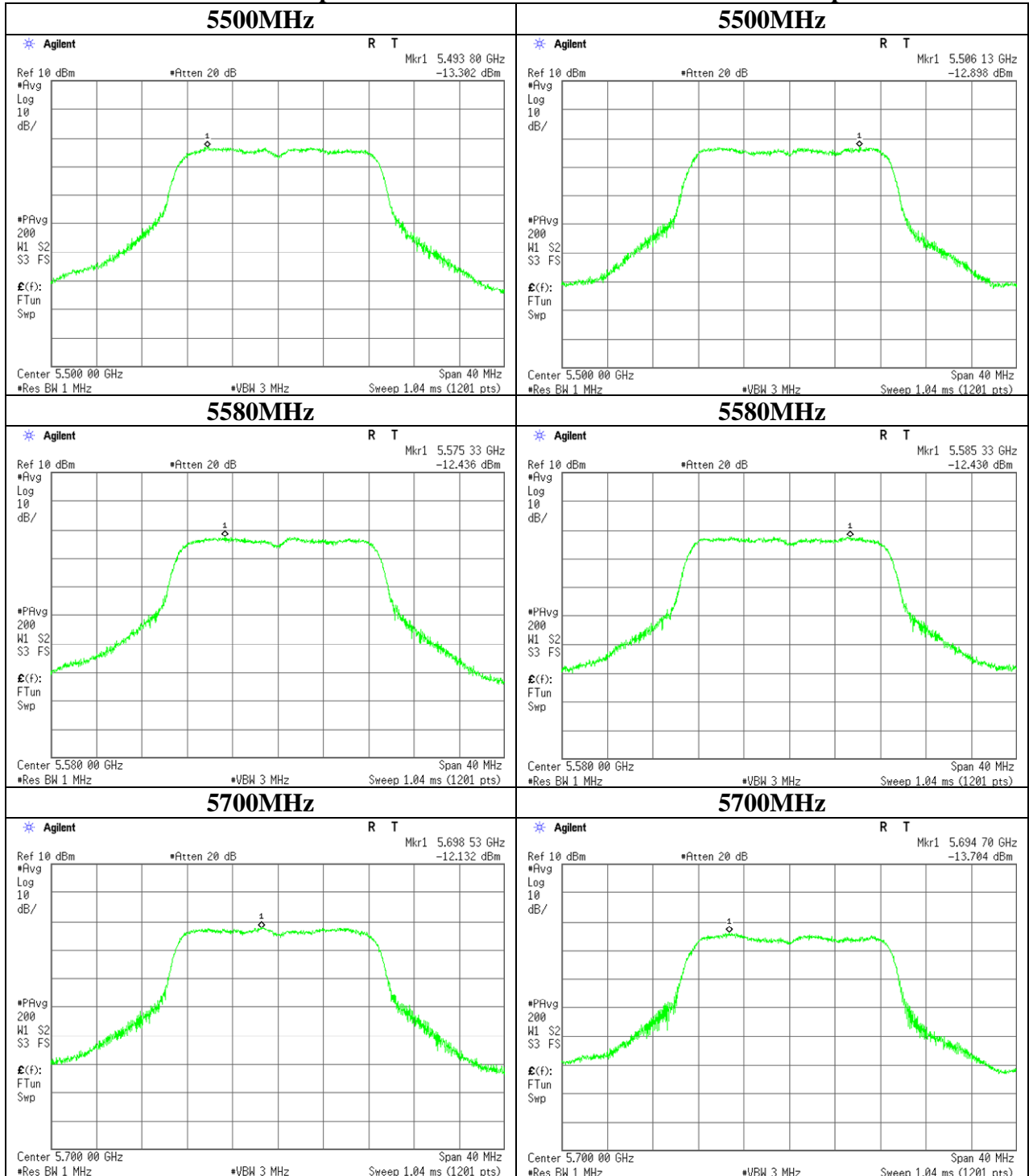

UL Japan, Inc.

Ise EMC Lab.

4383-326 Asama-cho, Ise-shi, Mie-ken 516-0021 JAPAN

Telephone : +81 596 24 8999

Facsimile : +81 596 24 8124

Maximum Power Spectral Density

Test place : Ise EMC Lab. No.11 Measurement Room
Report No. : 10604551H
Date : 03/10/2015
Temperature/ Humidity : 23deg. C / 30% RH
Engineer : Shinichi Miyazono
Mode : 11n-40 Tx

Antenna port 0 + 1

Freq. [MHz]	Antenna port 0 Result [mW]	Antenna port 1 Result [mW]	Result		Limit [dBm]	Margin [dB]
			Antenna port 0 + 1 [dBm]	[mW]		
5190.0	0.65	0.59	0.92	1.23	11.00	10.08
5230.0	0.76	0.59	1.30	1.35	11.00	9.70
5270.0	0.71	0.49	0.79	1.20	11.00	10.21
5310.0	0.62	0.43	0.22	1.05	11.00	10.78
5510.0	0.41	0.41	-0.88	0.82	11.00	11.88
5550.0	0.45	0.47	-0.34	0.92	11.00	11.34
5670.0	0.49	0.42	-0.40	0.91	11.00	11.40

Result = Antenna Port 0 + 1

Antenna port 0

Freq. [MHz]	Reading [dBm]	Cable Loss [dB]	Atten. Loss [dB]	Duty factor [dB]	Correction factor [dB]	Result	
						[dBm]	[mW]
5190.0	-16.160	3.13	10.11	1.02	0.00	-1.90	0.65
5230.0	-15.483	3.15	10.11	1.02	0.00	-1.20	0.76
5270.0	-15.783	3.16	10.11	1.02	0.00	-1.49	0.71
5310.0	-16.356	3.17	10.11	1.02	0.00	-2.06	0.62
5510.0	-18.263	3.24	10.12	1.02	0.00	-3.88	0.41
5550.0	-17.844	3.25	10.12	1.02	0.00	-3.45	0.45
5670.0	-17.514	3.30	10.11	1.02	0.00	-3.08	0.49

Result = Reading + Cable Loss + Attenuator + Duty Factor + Correction factor

Antenna port 1

Freq. [MHz]	Reading [dBm]	Cable Loss [dB]	Atten. Loss [dB]	Duty factor [dB]	Correction factor [dB]	Result	
						[dBm]	[mW]
5190.0	-16.557	3.13	10.11	1.02	0.00	-2.30	0.59
5230.0	-16.569	3.15	10.11	1.02	0.00	-2.29	0.59
5270.0	-17.387	3.16	10.11	1.02	0.00	-3.10	0.49
5310.0	-17.967	3.17	10.11	1.02	0.00	-3.67	0.43
5510.0	-18.268	3.24	10.12	1.02	0.00	-3.89	0.41
5550.0	-17.645	3.25	10.12	1.02	0.00	-3.26	0.47
5670.0	-18.188	3.30	10.11	1.02	0.00	-3.76	0.42

Result = Reading + Cable Loss + Attenuator + Duty Factor + Correction factor

Maximum Power Spectral Density

11n-40 Antenna port 0

11n-40 Antenna port 1

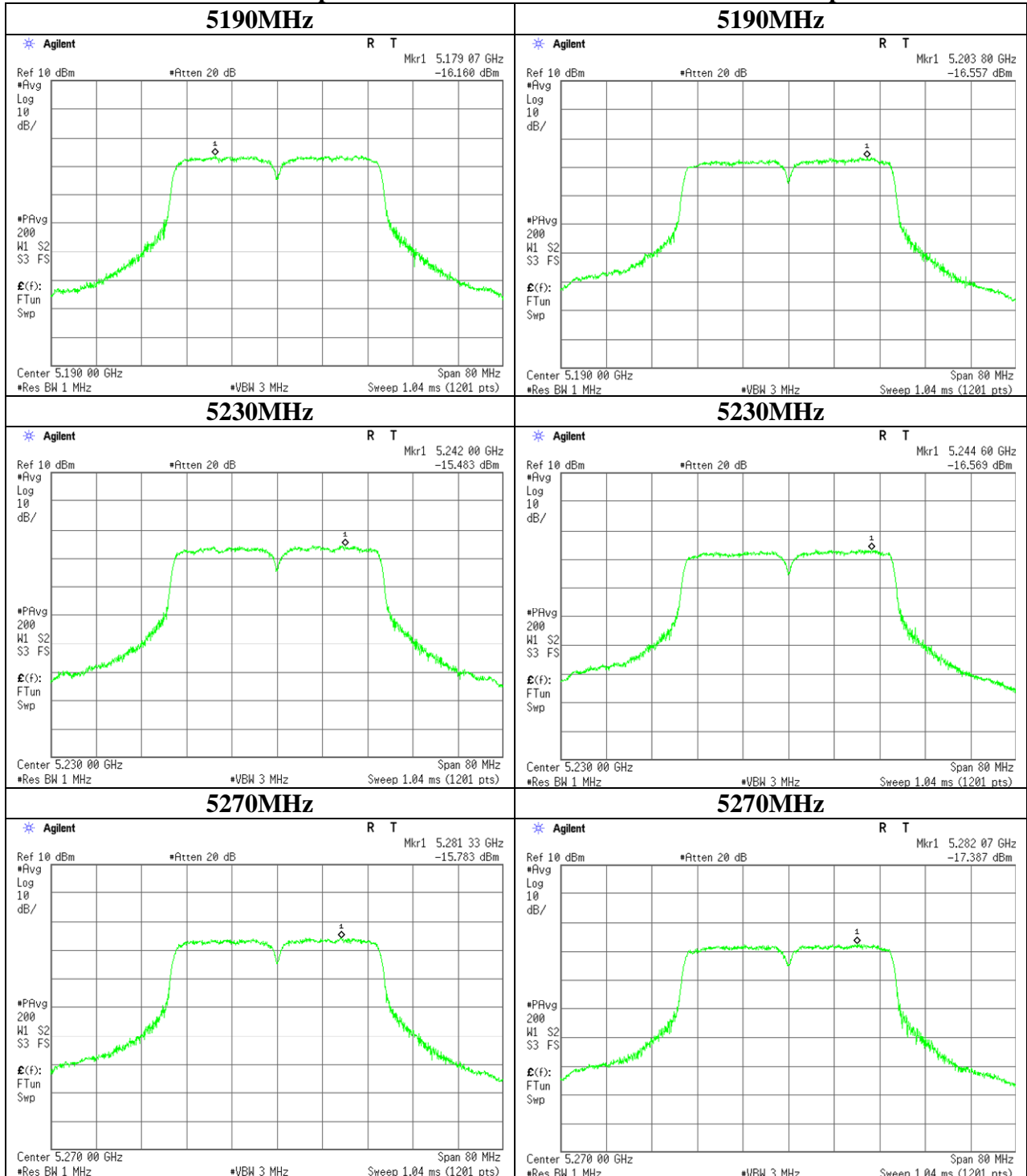

UL Japan, Inc.
Ise EMC Lab.

4383-326 Asama-cho, Ise-shi, Mie-ken 516-0021 JAPAN
 Telephone : +81 596 24 8999
 Facsimile : +81 596 24 8124

Maximum Power Spectral Density

11n-40 Antenna port 0

11n-40 Antenna port 1

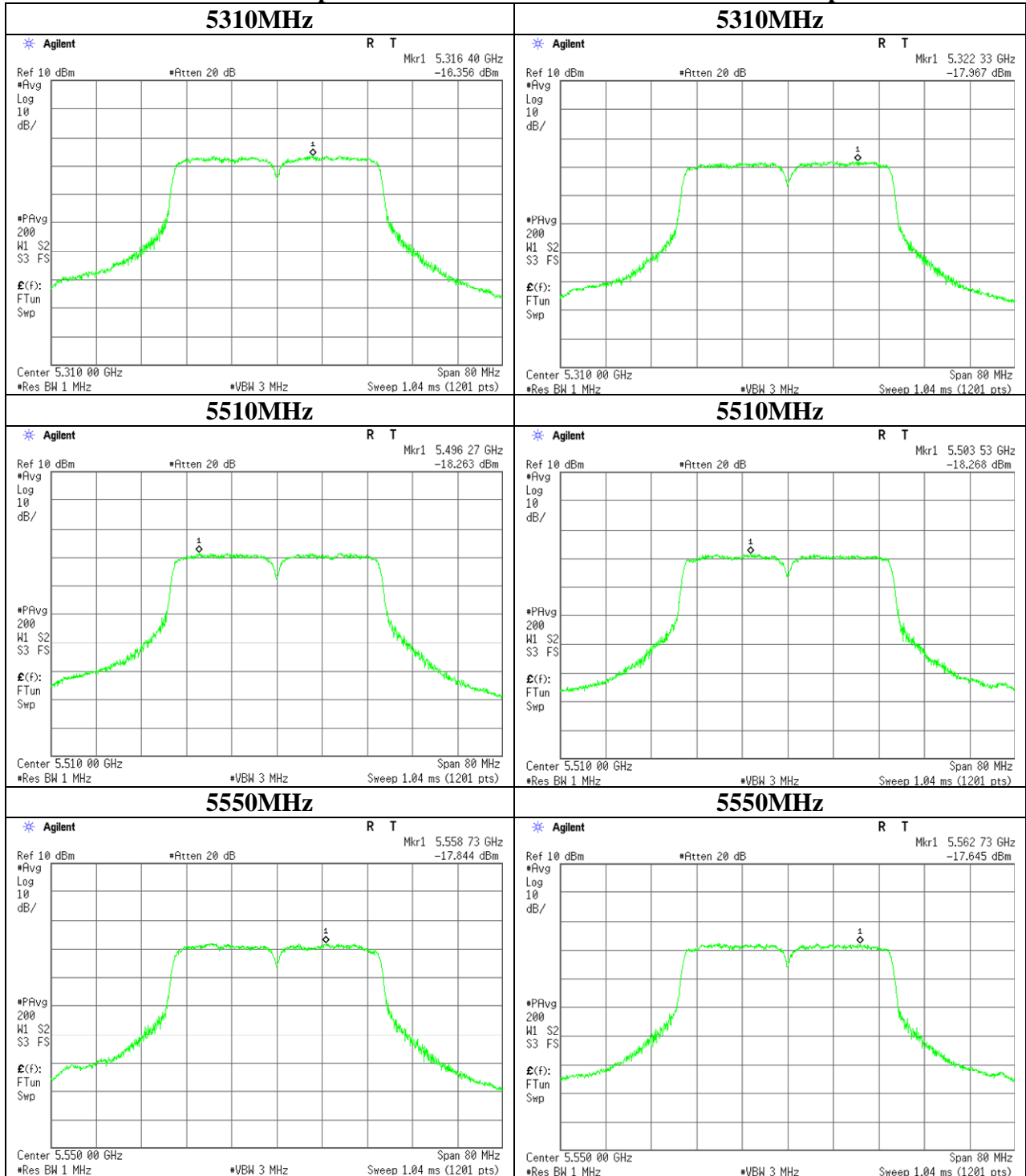

UL Japan, Inc.

Ise EMC Lab.

4383-326 Asama-cho, Ise-shi, Mie-ken 516-0021 JAPAN

Telephone : +81 596 24 8999

Facsimile : +81 596 24 8124

Maximum Power Spectral Density

11n-40 Antenna port 0

5670MHz

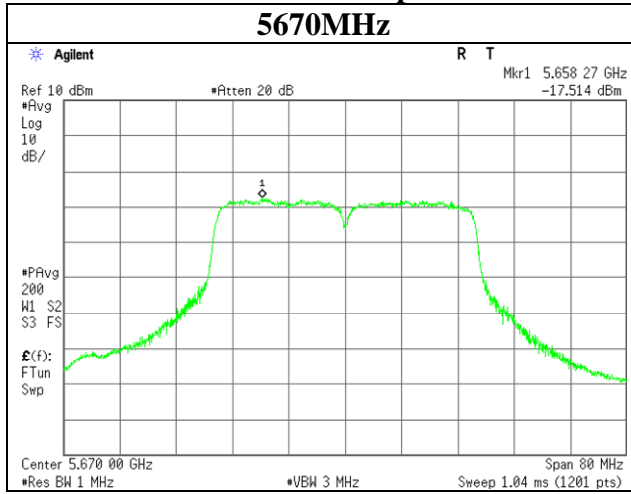

11n-40 Antenna port 1

5670MHz

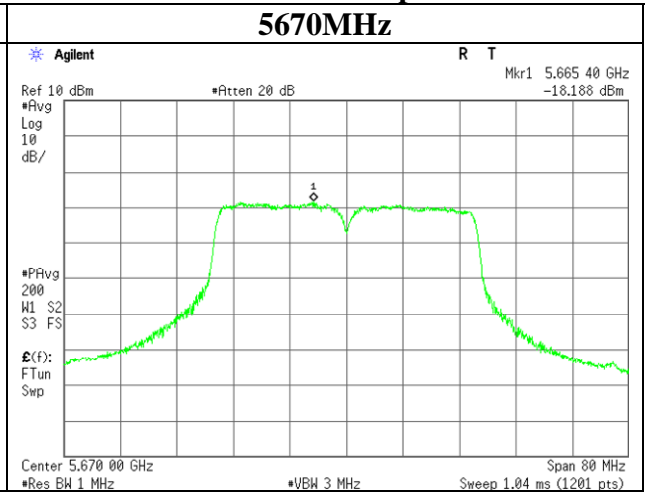

UL Japan, Inc.
Ise EMC Lab.

4383-326 Asama-cho, Ise-shi, Mie-ken 516-0021 JAPAN
 Telephone : +81 596 24 8999
 Facsimile : +81 596 24 8124

Radiated Spurious Emission

Test place	Ise EMC Lab. No.3 Anechoic Chamber		
Report No.	10604551H		
Date	03/06/2015	03/07/2015	03/08/2015
Temperature/ Humidity	23deg. C / 35% RH	23deg. C / 44% RH	23deg. C / 39% RH
Engineer	Koji Yamamoto	Kazuya Yoshioka	Takumi Shimada
	(1-10GHz)	(10-15GHz)	(15-40GHz)
Mode	11n-20 Tx 5180MHz		

Polarity	Frequency [MHz]	Detector	Reading [dBuV]	Ant.Fac. [dB/m]	Loss [dB]	Gain [dB]	Duty Factor [dB]	Result [dBuV/m]	Limit [dBuV/m]	Margin [dB]	Inside or Outside of Restricted Bands	Remark
Hori	5150.000	PK	59.6	31.3	3.7	31.7	-	62.9	68.2	5.3	Bandedge	
Hori	10360.000	PK	52.8	38.8	-2.1	33.6	-	55.9	68.2	12.3	Outside	
Hori	15540.000	PK	44.2	37.9	-2.8	32.1	-	47.2	73.9	26.7	Inside	
Hori	20720.000	PK	44.3	37.6	-1.8	32.2	-	47.9	73.9	26.0	Inside	
Hori	5150.000	AV	44.3	31.3	3.7	31.7	1.2	48.8	53.9	5.1	Bandedge	
Hori	15540.000	AV	35.5	37.9	-2.8	32.1	1.2	39.7	53.9	14.2	Inside	
Hori	20720.000	AV	36.3	37.6	-1.8	32.2	1.2	41.1	53.9	12.8	Inside	
Vert	5150.000	PK	60.0	31.3	3.7	31.7	-	63.3	68.2	4.9	Bandedge	
Vert	10360.000	PK	54.4	38.8	-2.1	33.6	-	57.5	68.2	10.7	Outside	
Vert	15540.000	PK	43.8	37.9	-2.8	32.1	-	46.8	73.9	27.1	Inside	
Vert	20720.000	PK	44.1	37.6	-1.8	32.2	-	47.7	73.9	26.2	Inside	
Vert	5150.000	AV	44.5	31.3	3.7	31.7	1.2	49.0	53.9	4.9	Bandedge	
Vert	15540.000	AV	35.7	37.9	-2.8	32.1	1.2	39.9	53.9	14.0	Inside	
Vert	20720.000	AV	36.5	37.6	-1.8	32.2	1.2	41.3	53.9	12.6	Inside	

Result = Reading + Ant Factor + Loss (Cable+Attenuator+Filter-Distance factor(above 10GHz)) - Gain(Amplifier) + Duty factor

*Other frequency noises omitted in this report were not seen or have enough margin (more than 20dB).

Distance factor: 10GHz-26.5GHz 20log(3.0m/1.0m)= 9.5dB
 26.5GHz-40GHz 20log(3.0m/0.5m)=15.6dB

UL Japan, Inc.

Ise EMC Lab.

4383-326 Asama-cho, Ise-shi, Mie-ken 516-0021 JAPAN

Telephone : +81 596 24 8999

Facsimile : +81 596 24 8124

Radiated Spurious Emission

Test place : Ise EMC Lab. No.2 and No.3 Anechoic Chamber
Report No. : 10604551H
Date : 03/06/2015 03/07/2015 03/08/2015 03/10/2015
Temperature/ Humidity : 23deg. C / 35% RH 23deg. C / 44% RH 23deg. C / 39% RH 22deg. C / 38% RH
Engineer : Koji Yamamoto Kazuya Yoshioka Takumi Shimada Kazuya Yoshioka
Mode : (1-10GHz) (10-15GHz) (15-40GHz) (30-1000MHz)
11n-20 Tx 5260MHz

Polarity	Frequency [MHz]	Detector	Reading [dBuV]	Ant.Fac. [dB/m]	Loss [dB]	Gain [dB]	Duty Factor [dB]	Result [dBuV/m]	Limit [dBuV/m]	Margin [dB]	Inside or Outside of Restricted Bands	Remark
Hori	43.950	QP	23.3	12.9	6.9	28.5	-	14.6	40.0	25.4	Outside	
Hori	75.880	QP	24.9	6.5	7.3	28.4	-	10.3	40.0	29.7	Outside	
Hori	99.616	QP	48.9	10.1	7.4	28.2	-	38.2	43.5	5.3	Outside	
Hori	120.000	QP	37.1	12.7	7.6	28.2	-	29.2	43.5	14.3	Inside	
Hori	497.680	QP	28.5	18.6	9.7	28.5	-	28.3	46.0	17.7	Outside	
Hori	696.828	QP	36.0	20.6	10.6	28.1	-	39.1	46.0	6.9	Outside	
Hori	10520.000	PK	51.5	38.7	-2.1	33.6	-	54.5	68.2	13.7	Outside	
Hori	15780.000	PK	43.7	37.7	-2.8	32.2	-	46.4	73.9	27.5	Inside	
Hori	21040.000	PK	45.4	37.6	-1.7	32.3	-	49.0	73.9	24.9	Inside	
Hori	15780.000	AV	35.5	37.7	-2.8	32.2	1.2	39.4	53.9	14.5	Inside	
Hori	21040.000	AV	36.6	37.6	-1.7	32.3	1.2	41.4	53.9	12.5	Inside	
Vert	44.100	QP	35.9	12.8	6.9	28.5	-	27.1	40.0	12.9	Outside	
Vert	74.760	QP	29.1	6.5	7.2	28.4	-	14.4	40.0	25.6	Outside	
Vert	99.610	QP	43.4	10.1	7.4	28.2	-	32.7	43.5	10.8	Outside	
Vert	119.998	QP	31.9	12.7	7.6	28.2	-	24.0	43.5	19.5	Inside	
Vert	497.840	QP	30.1	18.6	9.7	28.5	-	29.9	46.0	16.1	Outside	
Vert	696.828	QP	30.9	20.6	10.6	28.1	-	34.0	46.0	12.0	Outside	
Vert	10520.000	PK	52.2	38.7	-2.1	33.6	-	55.2	68.2	13.0	Outside	
Vert	15780.000	PK	44.5	37.7	-2.8	32.2	-	47.2	73.9	26.7	Inside	
Vert	21040.000	PK	44.4	37.6	-1.7	32.3	-	48.0	73.9	25.9	Inside	
Vert	15780.000	AV	35.5	37.7	-2.8	32.2	1.2	39.4	53.9	14.5	Inside	
Vert	21040.000	AV	36.8	37.6	-1.7	32.3	1.2	41.6	53.9	12.3	Inside	

Result = Reading + Ant Factor + Loss (Cable+Attenuator+Filter-Distance factor(above 10GHz)) - Gain(Amplifier) + Duty factor

*Other frequency noises omitted in this report were not seen or have enough margin (more than 20dB).

Distance factor: 10GHz-26.5GHz 20log(3.0m/1.0m)= 9.5dB
26.5GHz-40GHz 20log(3.0m/0.5m)=15.6dB

UL Japan, Inc.

Ise EMC Lab.

4383-326 Asama-cho, Ise-shi, Mie-ken 516-0021 JAPAN

Telephone : +81 596 24 8999

Facsimile : +81 596 24 8124

Radiated Spurious Emission

Test place	Ise EMC Lab. No.3 Anechoic Chamber		
Report No.	10604551H		
Date	03/06/2015	03/07/2015	03/08/2015
Temperature/ Humidity	20deg. C / 40% RH	23deg. C / 44% RH	23deg. C / 39% RH
Engineer	Kenshi Shimomura	Kazuya Yoshioka	Takumi Shimada
	(1-10GHz)	(10-15GHz)	(15-40GHz)
Mode	11n-40 Tx 5270MHz		

Polarity	Frequency [MHz]	Detector	Reading [dBuV]	Ant.Fac. [dB/m]	Loss [dB]	Gain [dB]	Duty Factor [dB]	Result [dBuV/m]	Limit [dBuV/m]	Margin [dB]	Inside or Outside of Restricted Bands	Remark
Hori	10540.000	PK	48.2	38.7	-2.1	33.6	-	51.2	68.2	17.0	Outside	
Hori	15810.000	PK	44.5	37.7	-2.8	32.2	-	47.2	73.9	26.7	Inside	
Hori	21080.000	PK	45.1	37.6	-1.7	32.3	-	48.7	73.9	25.2	Inside	
Hori	15810.000	AV	35.3	37.7	-2.8	32.2	1.0	39.0	53.9	14.9	Inside	
Hori	21080.000	AV	36.5	37.6	-1.7	32.3	1.0	41.1	53.9	12.8	Inside	
Vert	10540.000	PK	47.7	38.7	-2.1	33.6	-	50.7	68.2	17.5	Outside	
Vert	15810.000	PK	44.0	37.7	-2.8	32.2	-	46.7	73.9	27.2	Inside	
Vert	21080.000	PK	45.7	37.6	-1.7	32.3	-	49.3	73.9	24.6	Inside	
Vert	15810.000	AV	35.5	37.7	-2.8	32.2	1.0	39.2	53.9	14.7	Inside	
Vert	21080.000	AV	36.4	37.6	-1.7	32.3	1.0	41.0	53.9	12.9	Inside	

Result = Reading + Ant Factor + Loss (Cable+Attenuator+Filter-Distance factor(above 10GHz)) - Gain(Amplifier) + Duty factor

*Other frequency noises omitted in this report were not seen or have enough margin (more than 20dB).

Distance factor: 10GHz-26.5GHz 20log(3.0m/1.0m)= 9.5dB
 26.5GHz-40GHz 20log(3.0m/0.5m)=15.6dB

UL Japan, Inc.

Ise EMC Lab.

4383-326 Asama-cho, Ise-shi, Mie-ken 516-0021 JAPAN

Telephone : +81 596 24 8999

Facsimile : +81 596 24 8124

Radiated Spurious Emission

Test place Ise EMC Lab. No.3 Anechoic Chamber
Report No. 10604551H
Date 03/06/2015 03/07/2015 03/08/2015
Temperature/ Humidity 20deg. C / 40% RH 23deg. C / 44% RH 23deg. C / 39% RH
Engineer Kenshi Shimomura Kazuya Yoshioka Takumi Shimada
(1-10GHz) (10-15GHz) (15-40GHz)
Mode 11n-40 Tx 5550MHz

Polarity	Frequency [MHz]	Detector	Reading [dBuV]	Ant.Fac. [dB/m]	Loss [dB]	Gain [dB]	Duty Factor [dB]	Result [dBuV/m]	Limit [dBuV/m]	Margin [dB]	Inside or Outside of Restricted Bands	Remark
Hori	11100.000	PK	47.9	38.9	-1.8	33.7	-	51.3	73.9	22.6	Inside	
Hori	16650.000	PK	43.4	37.5	-2.6	32.2	-	46.1	68.2	22.1	Outside	
Hori	22200.000	PK	45.6	37.6	-1.3	32.0	-	49.9	73.9	24.0	Inside	
Hori	11100.000	AV	38.4	38.9	-1.8	33.7	1.0	42.8	53.9	11.1	Inside	
Hori	22200.000	AV	37.2	37.6	-1.3	32.0	1.0	42.5	53.9	11.4	Inside	
Vert	11100.000	PK	48.8	38.9	-1.8	33.7	-	52.2	73.9	21.7	Inside	
Vert	16650.000	PK	44.8	37.5	-2.6	32.2	-	47.5	68.2	20.7	Outside	
Vert	22200.000	PK	45.7	37.6	-1.3	32.0	-	50.0	73.9	23.9	Inside	
Vert	11100.000	AV	38.8	38.9	-1.8	33.7	1.0	43.2	53.9	10.7	Inside	
Vert	22200.000	AV	37.1	37.6	-1.3	32.0	1.0	42.4	53.9	11.5	Inside	

Result = Reading + Ant Factor + Loss (Cable+Attenuator+Filter-Distance factor(above 10GHz)) - Gain(Amplifier) + Duty factor

*Other frequency noises omitted in this report were not seen or have enough margin (more than 20dB).

Distance factor: 10GHz-26.5GHz 20log(3.0m/1.0m)= 9.5dB
26.5GHz-40GHz 20log(3.0m/0.5m)=15.6dB

UL Japan, Inc.

Ise EMC Lab.

4383-326 Asama-cho, Ise-shi, Mie-ken 516-0021 JAPAN

Telephone : +81 596 24 8999

Facsimile : +81 596 24 8124

Burst rate confirmation

Test place	Ise EMC Lab. No.3 Semi Anechoic Chamber
Report No.	10604551H
Date	03/07/2015
Temperature/ Humidity	23deg. C / 44% RH
Engineer	Kazuya Yoshioka
Mode	11a / 11n-20 / 11n-40 Tx

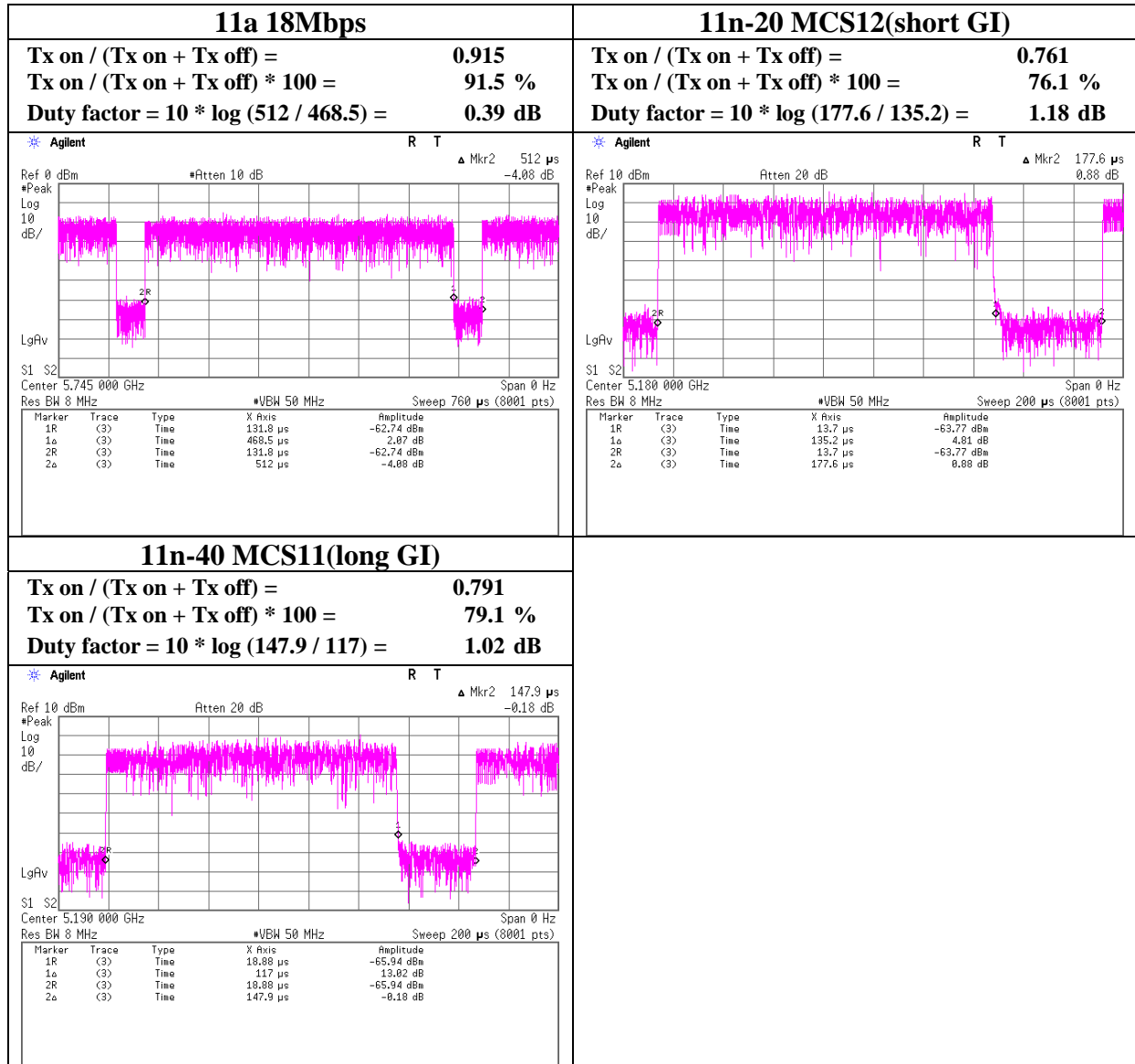

UL Japan, Inc.

Ise EMC Lab.

4383-326 Asama-cho, Ise-shi, Mie-ken 516-0021 JAPAN

Telephone : +81 596 24 8999

Facsimile : +81 596 24 8124

Conducted Spurious Emission

Test place	Ise EMC Lab. No.11 Measurement Room
Report No.	10604551H
Date	03/12/2015
Temperature/ Humidity	24deg. C / 31% RH
Engineer	Shinichi Miyazono
Mode	11n-20 Tx

11n-20 Tx 5260MHz Antenna port 0

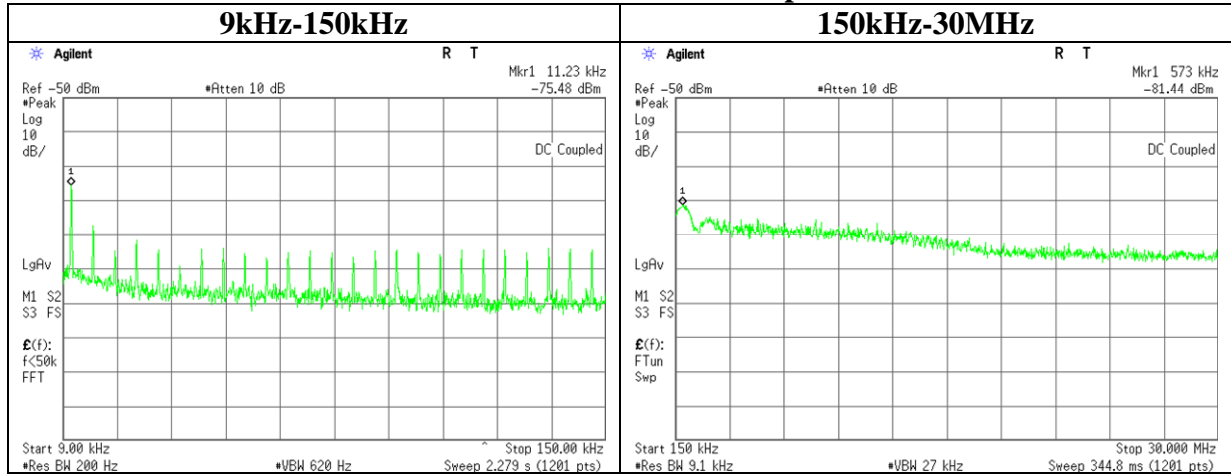

Frequency [kHz]	Reading [dBm]	Cable Loss [dB]	Attenuator [dB]	Antenna Gain [dBi]	N (Number of Output)	EIRP [dBm]	Distance [m]	Ground bounce [dB]	E (field strength) [dBuV/m]	Limit [dBuV/m]	Margin [dB]	Remark
11.23	-75.5	0.00	9.83	2.0	2	-60.6	300	6.0	0.6	46.5	45.9	
573.00	-81.4	0.00	9.82	2.0	2	-66.6	30	6.0	14.6	32.4	17.8	

$E = \text{EIRP} - 20 \log(D) + \text{Ground bounce} + 104.8 [\text{dBuV/m}]$

$\text{EIRP} = \text{Reading} + \text{Cable Loss} + \text{Attenuator} + \text{Antenna Gain} + 10 * \log(N)$

UL Japan, Inc.

Ise EMC Lab.

4383-326 Asama-cho, Ise-shi, Mie-ken 516-0021 JAPAN

Telephone : +81 596 24 8999

Facsimile : +81 596 24 8124

APPENDIX 2: Test instruments

EMI test equipment (1/2)

Control No.	Instrument	Manufacturer	Model No	Serial No	Test Item	Calibration Date * Interval(month)
MPM-16	Power Meter	Agilent	8990B	MY51000271	AT	2014/04/04 * 12
MPSE-22	Power sensor	Agilent	N1923A	MY54070003	AT	2014/04/04 * 12
MAT-24	Attenuator(10dB)(above 1GHz)	Agilent	8493C	71389	AT	2014/06/12 * 12
MCC-144	Microwave Cable	Junkosha	MWX221	1207S407	AT	2014/08/08 * 12
MCC-35	Microwave Cable	Hirose Electric	U.FL-2LP-066-A-(200)	-	AT	2014/09/12 * 12
MOS-14	Thermo-Hygrometer	Custom	CTH-201	1401	AT	2015/01/13 * 12
MAEC-03	Semi Anechoic Chamber(NSA)	TDK	Semi Anechoic Chamber 3m	DA-10005	RE	2015/02/19 * 12
MOS-13	Thermo-Hygrometer	Custom	CTH-180	1301	RE	2015/01/13 * 12
MJM-16	Measure	KOMELON	KMC-36	-	RE	-
COTS-MEMI	EMI measurement program	TSJ	TEPTO-DV	-	RE/CE	-
MSA-03	Spectrum Analyzer	Agilent	E4448A	MY44020357	RE	2014/04/08 * 12
MHA-20	Horn Antenna 1-18GHz	Schwarzbeck	BBHA9120D	258	RE	2014/05/26 * 12
MCC-167	Microwave Cable	Junkosha	MWX221	1404S374(1m) / 1405S074(5m)	RE	2014/05/26 * 12
MPA-11	MicroWave System Amplifier	Agilent	83017A	MY39500779	RE	2014/03/24 * 12
MCC-79	Microwave Cable 1G-26.5GHz	Suhner	SUCOFLEX104	278923/4	RE	2014/12/15 * 12
MHF-22	High Pass Filter 7-20GHz	TOKIMEC	TF37NCCB	602	RE	2015/01/27 * 12
MHA-16	Horn Antenna 15-40GHz	Schwarzbeck	BBHA9170	BBHA9170306	RE	2014/05/26 * 12
MHA-29	Horn Antenna 26.5-40GHz	ETS LINDGREN	3160-10	00152399	RE	2014/09/02 * 12
MPA-22	Pre Amplifier	MITEQ, Inc	AMF-6F-2600400-33-8P / AMF-4F-2600400-33-8P	1871355 / 1871328	RE	2014/09/11 * 12
MCC-54	Microwave Cable	Suhner	SUCOFLEX101	2873(1m) / 2876(5m)	RE	2015/03/09 * 12
MOS-19	Thermo-Hygrometer	Custom	CTH-201	0001	AT	2014/12/22 * 12
MSA-13	Spectrum Analyzer	Agilent	E4440A	MY46185823	AT	2014/06/06 * 12
MCC-36	Microwave Cable	Hirose Electric	U.FL-2LP-066-A-(200)	-	AT	2014/09/12 * 12
MCC-137	Microwave cable	HUBER+SUHNER	SUCOFLEX 102	37954/2	AT	2014/10/02 * 12
MAT-20	Attenuator(10dB)(above 1GHz)	HIROSE ELECTRIC CO.,LTD.	AT-110	-	AT	2015/01/08 * 12
MPM-09	Power Meter	Anritsu	ML2495A	6K00003348	AT	2014/10/06 * 12
MPSE-12	Power sensor	Anritsu	MA2411B	011598	AT	2014/10/06 * 12
MTW-03	Torque wrench	HUBER+SUHNER	74 Z-0-0-21	98142	AT	2015/01/16 * 36
MAEC-02	Semi Anechoic Chamber(NSA)	TDK	Semi Anechoic Chamber 3m	DA-06902	CE/RE	2014/06/25 * 12
MOS-22	Thermo-Hygrometer	Custom	CTH-201	0003	CE/RE	2015/01/13 * 12
MJM-14	Measure	KOMELON	KMC-36	-	CE/RE	-
MSA-14	Spectrum Analyzer	Agilent	E4440A	MY48250080	CE/RE	2014/10/17 * 12
MTR-03	Test Receiver	Rohde & Schwarz	ESCI	100300	CE/RE	2014/06/03 * 12
MLS-25	LISN(AMN)	Schwarzbeck	NSLK8127	8127-731	CE(EUT)	2014/07/09 * 12
MLS-26	LISN(AMN)	Schwarzbeck	NSLK8127	8127-732	CE(AE)	2014/07/09 * 12
MTA-28	Terminator	TME	CT-01	-	CE	2014/11/26 * 12
MCC-13	Coaxial Cable	Fujikura	3D-2W(12m)/5D-2W(5m)/5D-2W(0.8m)/5D-2W(1m)	-	CE	2015/02/06 * 12
MAT-65	Attenuator(13dB)	JFW Industries, Inc.	50FP-013H2 N	-	CE	2015/01/29 * 12

UL Japan, Inc.

Ise EMC Lab.

4383-326 Asama-cho, Ise-shi, Mie-ken 516-0021 JAPAN

Telephone : +81 596 24 8999

Facsimile : +81 596 24 8124

EMI test equipment (2/2)

Control No.	Instrument	Manufacturer	Model No	Serial No	Test Item	Calibration Date * Interval(month)
MBA-02	Biconical Antenna	Schwarzbeck	BBA9106	VHA91032008	RE	2014/10/18 * 12
MLA-02	Logperiodic Antenna	Schwarzbeck	USLP9143	201	RE	2014/10/18 * 12
MCC-12	Coaxial Cable	Fujikura/Agilent	-	-	RE	2015/02/06 * 12
MAT-07	Attenuator(6dB)	Weinschel Corp	2	BK7970	RE	2014/11/11 * 12
MPA-09	Pre Amplifier	Agilent	8447D	2944A10845	RE	2014/09/26 * 12
MSA-10	Spectrum Analyzer	Agilent	E4448A	MY46180655	AT	2015/02/26 * 12
MAT-56	Attenuator(10dB)	Suhner	6810.19.A	-	AT	2015/01/08 * 12
MCC-38	Coaxial Cable	UL Japan	-	-	AT	2014/12/02 * 12
MAT-10	Attenuator(10dB)	Weinschel Corp	2	BL1173	AT	2014/11/19 * 12
MCC-170	Microwave Cable	Junkosha	MWX221	1409S493	AT	2015/03/04 * 12
MCC-37	Microwave Cable	Hirose Electric	U.FL-2LP-066-A-(200)	-	AT	2014/09/25 * 12
MAT-57	Attenuator(10dB)	Suhner	6810.19.A	-	AT	2015/01/08 * 12

The expiration date of the calibration is the end of the expired month.

All equipment is calibrated with valid calibrations. Each measurement data is traceable to the national or international standards.

As for some calibrations performed after the tested dates, those test equipment have been controlled by means of an unbroken chains of calibrations.

Test Item: CE: Conducted Emission

RE: Radiated Emission

AT: Antenna Terminal Conducted test

UL Japan, Inc.

Ise EMC Lab.

4383-326 Asama-cho, Ise-shi, Mie-ken 516-0021 JAPAN

Telephone : +81 596 24 8999

Facsimile : +81 596 24 8124