

ELECTROMAGNETIC EMISSIONS COMPLIANCE REPORT

INTENTIONAL RADIATOR CERTIFICATION TO FCC PART 15 SUBPART E REQUIREMENT

OF

Product Name: SX-PCEAC-DB
Brand Name: SX-PCEAC-DB
Model No.: SX-PCEAC-DB
Model Difference: N/A
FCC ID: N6C-SXPCEACDB
Report No.: ER/2016/20016
Issue Date: Mar. 23, 2016
FCC Rule Part: §15.407
Prepared for: Silex Technology, Inc.
Hikaridai 2-3-1, Seika-cho, Kyoto 619-0237,
Japan
Prepared by: SGS Taiwan Ltd.
Electronics & Communication Laboratory
No.134, Wu Kung Road, New Taipei
Industrial Park, Wuku District, New Taipei
City, Taiwan 24803



Note: This report shall not be reproduced except in full, without the written approval of SGS Taiwan Ltd. This document may be altered or revised by SGS Taiwan Ltd. personnel only, and shall be noted in the revision section of the document.

Unless otherwise stated the results shown in this test report refer only to the sample(s) tested and such sample(s) are retained for 90 days only.

除非另有說明，此報告結果僅對測試之樣品負責，同時此樣品僅保留90天。本報告未經本公司書面許可，不可部份複製。

This document is issued by the Company subject to its General Conditions of Service printed overleaf, available on request or accessible at www.sgs.com/terms_and_conditions.htm and, for electronic format documents, subject to Terms and Conditions for Electronic Documents at www.sgs.com/terms_e-document.htm. Attention is drawn to the limitation of liability, indemnification and jurisdiction issues defined therein. Any holder of this document is advised that information contained hereon reflects the Company's findings at the time of its intervention only and within the limits of Client's instructions, if any. The Company's sole responsibility is to its Client and this document does not exonerate parties to a transaction from exercising all their rights and obligations under the transaction documents. This document cannot be reproduced except in full, without prior written approval of the Company. Any unauthorized alteration, forgery or falsification of the content or appearance of this document is unlawful and offenders may be prosecuted to the fullest extent of the law.

SGS Taiwan Ltd.

No.134,WuKungRoad,NewTaipeiIndustrialPark,WukuDistrict,NewTaipeiCity,Taiwan24803/新北市五股區新北產業園區五工路 134 號

台灣檢驗科技股份有限公司

t (886-2) 2299-3279

f (886-2) 2298-0488

www.tw.sgs.com

Member of SGS Group

VERIFICATION OF COMPLIANCE

Applicant: Silex Technology, Inc.
Hikaridai 2-3-1, Seika-cho, Kyoto 619-0237, Japan

Product Name: SX-PCEAC-DB

Brand Name: SX-PCEAC-DB

Model No.: SX-PCEAC-DB

Model Difference: N/A

FCC ID: N6C-SXPCEACDB

File Number: ER/2016/20016

Date of Test: Feb. 15, 2016 ~ Mar. 21, 2016

Date of EUT Received: Feb. 15, 2016

We hereby certify that:

The above equipment was tested by SGS Taiwan Ltd. Electronics & Communication Laboratory. The test data, data evaluation, test procedures, and equipment configurations shown in this report were made in accordance with the procedures given in ANSI C63.4:2014 & ANSI C63.10: 2013 and the energy emitted by the sample EUT tested as described in this report is in compliance with conducted and radiated emission limits.

The test results of this report relate only to the tested sample identified in this report.

Test By: JJ Chen **Date:** Mar. 23, 2016

JJ Chen / Engineer

Prepared By: Allen Tsai **Date:** Mar. 23, 2016

Allen Tsai / Engineer

Approved By: Jim Chang **Date:** Mar. 23, 2016

Jim Chang / Asst. Manager

Unless otherwise stated the results shown in this test report refer only to the sample(s) tested and such sample(s) are retained for 90 days only.

除非另有說明，此報告結果僅對測試之樣品負責，同時此樣品僅保留90天。本報告未經本公司書面許可，不可部份複製。

This document is issued by the Company subject to its General Conditions of Service printed overleaf, available on request or accessible at www.sgs.com/terms_and_conditions.htm and, for electronic format documents, subject to Terms and Conditions for Electronic Documents at www.sgs.com/terms_e-document.htm. Attention is drawn to the limitation of liability, indemnification and jurisdiction issues defined therein. Any holder of this document is advised that information contained hereon reflects the Company's findings at the time of its intervention only and within the limits of Client's instructions, if any. The Company's sole responsibility is to its Client and this document does not exonerate parties to a transaction from exercising all their rights and obligations under the transaction documents. This document cannot be reproduced except in full, without prior written approval of the Company. Any unauthorized alteration, forgery or falsification of the content or appearance of this document is unlawful and offenders may be prosecuted to the fullest extent of the law.

SGS Taiwan Ltd.

No. 134, WuKungRoad, NewTaipeiIndustrialPark, WukuDistrict, NewTaipeiCity, Taiwan24803/新北市五股區新北產業園區五工路 134 號

台灣檢驗科技股份有限公司

t (886-2) 2299-3279

f (886-2) 2298-0488

www.tw.sgs.com

Member of SGS Group

Revision History

Report Number	Revision	Description	Issue Date
ER/2016/20016	Rev.00	Initial creation of document	Mar. 23, 2016

Unless otherwise stated the results shown in this test report refer only to the sample(s) tested and such sample(s) are retained for 90 days only.

除非另有說明，此報告結果僅對測試之樣品負責，同時此樣品僅保留90天。本報告未經本公司書面許可，不可部份複製。

This document is issued by the Company subject to its General Conditions of Service printed overleaf, available on request or accessible at www.sgs.com/terms_and_conditions.htm and, for electronic format documents, subject to Terms and Conditions for Electronic Documents at www.sgs.com/terms_e-document.htm. Attention is drawn to the limitation of liability, indemnification and jurisdiction issues defined therein. Any holder of this document is advised that information contained hereon reflects the Company's findings at the time of its intervention only and within the limits of Client's instructions, if any. The Company's sole responsibility is to its Client and this document does not exonerate parties to a transaction from exercising all their rights and obligations under the transaction documents. This document cannot be reproduced except in full, without prior written approval of the Company. Any unauthorized alteration, forgery or falsification of the content or appearance of this document is unlawful and offenders may be prosecuted to the fullest extent of the law.

SGS Taiwan Ltd.

No.134,WuKungRoad,NewTaipeiIndustrialPark,WukuDistrict,NewTaipeiCity,Taiwan24803/新北市五股區新北產業園區五工路 134 號

台灣檢驗科技股份有限公司

t (886-2) 2299-3279

f (886-2) 2298-0488

www.tw.sgs.com

Member of SGS Group

Table of Contents

1. GENERAL INFORMATION.....	5
1.1 Product Description.....	5
1.2 Product Feature of Equipment Under Test.....	8
1.3 Test Methodology of Applied Standards.....	9
1.4 Test Facility.....	9
1.5 Special Accessories.....	9
1.6 Equipment Modifications.....	9
2. SUMMARY OF TEST RESULT.....	10
3. MEASUREMENT UNCERTAINTY.....	10
4. TPC and DFS MEASUREMENT.....	11
4.1. TPC: Standard Applicable.....	11
4.2. DFS: Standard Applicable.....	11
UNII Detection Bandwidth.....	29
Channel Availability Check (CAC).....	35

Unless otherwise stated the results shown in this test report refer only to the sample(s) tested and such sample(s) are retained for 90 days only.

除非另有說明，此報告結果僅對測試之樣品負責，同時此樣品僅保留90天。本報告未經本公司書面許可，不可部份複製。

This document is issued by the Company subject to its General Conditions of Service printed overleaf, available on request or accessible at www.sgs.com/terms_and_conditions.htm and, for electronic format documents, subject to Terms and Conditions for Electronic Documents at www.sgs.com/terms_e-document.htm. Attention is drawn to the limitation of liability, indemnification and jurisdiction issues defined therein. Any holder of this document is advised that information contained hereon reflects the Company's findings at the time of its intervention only and within the limits of Client's instructions, if any. The Company's sole responsibility is to its Client and this document does not exonerate parties to a transaction from exercising all their rights and obligations under the transaction documents. This document cannot be reproduced except in full, without prior written approval of the Company. Any unauthorized alteration, forgery or falsification of the content or appearance of this document is unlawful and offenders may be prosecuted to the fullest extent of the law.

SGS Taiwan Ltd.

No.134,WuKungRoad,NewTaipeiIndustrialPark,WukuDistrict,NewTaipeiCity,Taiwan24803/新北市五股區新北產業園區五工路 134 號

台灣檢驗科技股份有限公司

t (886-2) 2299-3279

f (886-2) 2298-0488

www.tw.sgs.com

Member of SGS Group

1. GENERAL INFORMATION

1.1 Product Description

General:

Product Name:	SX-PCEAC-DB
Brand Name:	SX-PCEAC-DB
Model No.:	SX-PCEAC-DB
Model Difference:	N/A
Product SW/HW version:	N/A / Ver.1
Radio SW/HW version:	10.2.00084-2 / BR4A
Test SW Version:	N/A
RF power setting in TEST SW:	N/A
Power Supply:	3.3 VDC from Power supply

Unless otherwise stated the results shown in this test report refer only to the sample(s) tested and such sample(s) are retained for 90 days only.

除非另有說明，此報告結果僅對測試之樣品負責，同時此樣品僅保留90天。本報告未經本公司書面許可，不可部份複製。

This document is issued by the Company subject to its General Conditions of Service printed overleaf, available on request or accessible at www.sgs.com/terms_and_conditions.htm and, for electronic format documents, subject to Terms and Conditions for Electronic Documents at www.sgs.com/terms_e-document.htm. Attention is drawn to the limitation of liability, indemnification and jurisdiction issues defined therein. Any holder of this document is advised that information contained hereon reflects the Company's findings at the time of its intervention only and within the limits of Client's instructions, if any. The Company's sole responsibility is to its Client and this document does not exonerate parties to a transaction from exercising all their rights and obligations under the transaction documents. This document cannot be reproduced except in full, without prior written approval of the Company. Any unauthorized alteration, forgery or falsification of the content or appearance of this document is unlawful and offenders may be prosecuted to the fullest extent of the law.

SGS Taiwan Ltd.

No.134,WuKungRoad,NewTaipeiIndustrialPark,WukuDistrict,NewTaipeiCity,Taiwan24803/新北市五股區新北產業園區五工路 134 號

台灣檢驗科技股份有限公司

t (886-2) 2299-3279

f (886-2) 2298-0488

www.tw.sgs.com

Member of SGS Group

WLAN 5GHz:

Wi-Fi	Frequency Range	Channels	Rated Power (Avg.) / (EIRP)	Modulation Technology
11a	5150~5250	4	16.79 dBm (Avg.) / 26.56 dBm (EIRP)	OFDM
	5250~5350	4	16.76 dBm / 26.53 dBm (EIRP)	
	5470~5725	12	18.75 dBm / 28.52 dBm (EIRP)	
	5725-5850	5	20.79 dBm	
11n / ac_20M	HT20 / VHT20 5150~5250	4	HT: 12.75 dBm (Avg.) / 22.53 dBm (EIRP) (Worst Case)	OFDM
	HT20 / VHT20 5250~5350	4	HT: 12.25 dBm / 22.02 dBm (EIRP) (Worst Case)	
	HT20 / VHT20 5470~5725	12	HT: 15.78 dBm / 25.55 dBm (EIRP) (Worst Case)	
	HT20 / VHT20 5725-5850	5	HT: 21.26 dBm (Worst Case)	
11n / ac_40M	HT40 / VHT40 5150~5250	2	HT: 12.29 dBm (Avg.) / 22.06 dBm (EIRP) (Worst Case)	OFDM
	HT40 / VHT40 5250~5350	2	HT: 13.27 dBm / 23.04 dBm (EIRP) (Worst Case)	
	HT40 / VHT40 5470~5725	6	HT: 16.26 dBm / 26.03 dBm (EIRP) (Worst Case)	
	HT40 / VHT40 5725-5850	2	HT: 19.77 dBm (Worst Case)	
11ac_80M	VHT80 5150~5250	1	12.65 dBm (Avg.) / 22.42 dBm (EIRP)	OFDM
	VHT80 5250~5350	1	12.15 dBm / 21.92 dBm (EIRP)	
	VHT80 5470~5725	2	12.05 dBm / 21.82 dBm (EIRP)	
	VHT80 5725-5850	1	11.49 dBm	

Unless otherwise stated the results shown in this test report refer only to the sample(s) tested and such sample(s) are retained for 90 days only.

除非另有說明，此報告結果僅對測試之樣品負責，同時此樣品僅保留90天。本報告未經本公司書面許可，不可部份複製。

This document is issued by the Company subject to its General Conditions of Service printed overleaf, available on request or accessible at www.sgs.com/terms_and_conditions.htm and, for electronic format documents, subject to Terms and Conditions for Electronic Documents at www.sgs.com/terms_e-document.htm. Attention is drawn to the limitation of liability, indemnification and jurisdiction issues defined therein. Any holder of this document is advised that information contained hereon reflects the Company's findings at the time of its intervention only and within the limits of Client's instructions, if any. The Company's sole responsibility is to its Client and this document does not exonerate parties to a transaction from exercising all their rights and obligations under the transaction documents. This document cannot be reproduced except in full, without prior written approval of the Company. Any unauthorized alteration, forgery or falsification of the content or appearance of this document is unlawful and offenders may be prosecuted to the fullest extent of the law.

<p>Antenna Designation</p>	<p>PCB Antenna (Dipole Antenna) 1. Partl No.: 146153, Supplier: Molex 5GHz Gain: 5dBi (5150MHz-5250MHz) 5GHz Gain: 5dBi (5250MHz-5350MHz) 5GHz Gain: 5dBi (5470MHz-5725MHz) 5GHz Gain: 5dBi (5725MHz-5850MHz)</p> <p>2. Part No.: H2B1PD1A1C (AA222), Supplier: Unictron 5GHz Gain: 4.2dBi (5150MHz-5250MHz) 5GHz Gain: 4.2dBi (5250MHz-5350MHz) 5GHz Gain: 4.2dBi (5470MHz-5725MHz) 5GHz Gain: 4.2dBi (5725MHz-5850MHz)</p> <p>3. Part No.: H2B1PC1A1C (AA258), Supplier: Unictron 5GHz Gain: 4.4dBi (5150MHz-5250MHz) 5GHz Gain: 4.4dBi (5250MHz-5350MHz) 5GHz Gain: 4.4dBi (5470MHz-5725MHz) 5GHz Gain: 4.4dBi (5725MHz-5850MHz)</p>
<p>Modulation type</p>	<p>64QAM, 16QAM, QPSK, BPSK for OFDM 256QAM for OFDM in 802.11ac only</p>
<p>Transition Rate:</p>	<p>802.11 a: 6/9/12/18/24/36/48/54 Mbps 802.11 n_20MHz: 6.5 – 144.4Mbps 802.11 n_40MHz: 13.5 – 300Mbps 802.11 ac_20MHz: 6.5 –144.4Mbps 802.11 ac_40MHz: 13.5 –300Mbps 802.11 ac_80MHz: 29.3 – 650Mbps</p>

Unless otherwise stated the results shown in this test report refer only to the sample(s) tested and such sample(s) are retained for 90 days only.

除非另有說明，此報告結果僅對測試之樣品負責，同時此樣品僅保留90天。本報告未經本公司書面許可，不可部份複製。

This document is issued by the Company subject to its General Conditions of Service printed overleaf, available on request or accessible at www.sgs.com/terms_and_conditions.htm and, for electronic format documents, subject to Terms and Conditions for Electronic Documents at www.sgs.com/terms_e-document.htm. Attention is drawn to the limitation of liability, indemnification and jurisdiction issues defined therein. Any holder of this document is advised that information contained hereon reflects the Company's findings at the time of its intervention only and within the limits of Client's instructions, if any. The Company's sole responsibility is to its Client and this document does not exonerate parties to a transaction from exercising all their rights and obligations under the transaction documents. This document cannot be reproduced except in full, without prior written approval of the Company. Any unauthorized alteration, forgery or falsification of the content or appearance of this document is unlawful and offenders may be prosecuted to the fullest extent of the law.

SGS Taiwan Ltd.

No.134,WuKungRoad,NewTaipeiIndustrialPark,WukuDistrict,NewTaipeiCity,Taiwan24803/新北市五股區新北產業園區五工路 134 號

台灣檢驗科技股份有限公司

t (886-2) 2299-3279

f (886-2) 2298-0488

www.tw.sgs.com

Member of SGS Group

1.2 Product Feature of Equipment Under Test

The equipment under Test (Hereafter Called: EUT) is supporting, Wi-Fi 802.11abgn & ac features, and below is details of information.

Product Feature	
Product Name:	SX-PCEAC-DB
Brand Name:	SX-PCEAC-DB
Model No.:	SX-PCEAC-DB
Model Difference:	N/A
FCC ID:	N6C-SXPCEACDB
IC:	4908A-SXPCEACDB
Wi-Fi Specification	802.11a/b/g/n/ac

Note: The above EUT information was declared by manufacturer. Please refer to the specifications or user's manual for more detailed description.

Unless otherwise stated the results shown in this test report refer only to the sample(s) tested and such sample(s) are retained for 90 days only.

除非另有說明，此報告結果僅對測試之樣品負責，同時此樣品僅保留90天。本報告未經本公司書面許可，不可部份複製。

This document is issued by the Company subject to its General Conditions of Service printed overleaf, available on request or accessible at www.sgs.com/terms_and_conditions.htm and, for electronic format documents, subject to Terms and Conditions for Electronic Documents at www.sgs.com/terms_e-document.htm. Attention is drawn to the limitation of liability, indemnification and jurisdiction issues defined therein. Any holder of this document is advised that information contained hereon reflects the Company's findings at the time of its intervention only and within the limits of Client's instructions, if any. The Company's sole responsibility is to its Client and this document does not exonerate parties to a transaction from exercising all their rights and obligations under the transaction documents. This document cannot be reproduced except in full, without prior written approval of the Company. Any unauthorized alteration, forgery or falsification of the content or appearance of this document is unlawful and offenders may be prosecuted to the fullest extent of the law.

SGS Taiwan Ltd.

No.134,WuKungRoad,NewTaipeiIndustrialPark,WukuDistrict,NewTaipeiCity,Taiwan24803/新北市五股區新北產業園區五工路 134 號

台灣檢驗科技股份有限公司

t (886-2) 2299-3279

f (886-2) 2298-0488

www.tw.sgs.com

Member of SGS Group

1.3 Test Methodology of Applied Standards

FCC Part 15, Subpart E §15.407

FCC KDB 905462 D02 UNII DFS Compliance Procedures New Rules v01r02

Note:

1. All test items have been performed and record as per the above standards.
2. The composite system is compliance with FCC Subpart B is authorized under the certification procedure.

1.4 Test Facility

SGS Taiwan Ltd. Electronics & Communication Laboratory No.134, Wu Kung Road, New Taipei Industrial Park, Wuku District, New Taipei City, Taiwan. (TAF code 0513)

FCC Registration Numbers are: 990257

1.5 Special Accessories

There are no special accessories used while test was conducted.

1.6 Equipment Modifications

There was no modification incorporated into the EUT.

Unless otherwise stated the results shown in this test report refer only to the sample(s) tested and such sample(s) are retained for 90 days only.

除非另有說明，此報告結果僅對測試之樣品負責，同時此樣品僅保留90天。本報告未經本公司書面許可，不可部份複製。

This document is issued by the Company subject to its General Conditions of Service printed overleaf, available on request or accessible at www.sgs.com/terms_and_conditions.htm and, for electronic format documents, subject to Terms and Conditions for Electronic Documents at www.sgs.com/terms_e-document.htm. Attention is drawn to the limitation of liability, indemnification and jurisdiction issues defined therein. Any holder of this document is advised that information contained hereon reflects the Company's findings at the time of its intervention only and within the limits of Client's instructions, if any. The Company's sole responsibility is to its Client and this document does not exonerate parties to a transaction from exercising all their rights and obligations under the transaction documents. This document cannot be reproduced except in full, without prior written approval of the Company. Any unauthorized alteration, forgery or falsification of the content or appearance of this document is unlawful and offenders may be prosecuted to the fullest extent of the law.

SGS Taiwan Ltd.

No.134,WuKungRoad,NewTaipeiIndustrialPark,WukuDistrict,NewTaipeiCity,Taiwan24803/新北市五股區新北產業園區五工路 134 號

台灣檢驗科技股份有限公司

t (886-2) 2299-3279

f (886-2) 2298-0488

www.tw.sgs.com

Member of SGS Group

2. SUMMARY OF TEST RESULT

FCC Rules	Description Of Test	Result
§15.407(h) FCC KDB 905462 D02 & D03	TPC and DFS Measurement	Compliant

3. MEASUREMENT UNCERTAINTY

Test Items	Uncertainty
TPC and DFS Measurement	+/- 123.36 Hz
Temperature	+/- 0.65 °C
Humidity	+/- 4.6 %
DC / AC Power Source	DC= +/- 0.13%, AC= +/- 0.2%

This uncertainty represents an expanded uncertainty expressed at approximately the 95% confidence level using a coverage factor of k=2.

Unless otherwise stated the results shown in this test report refer only to the sample(s) tested and such sample(s) are retained for 90 days only.

除非另有說明，此報告結果僅對測試之樣品負責，同時此樣品僅保留90天。本報告未經本公司書面許可，不可部份複製。

This document is issued by the Company subject to its General Conditions of Service printed overleaf, available on request or accessible at www.sgs.com/terms_and_conditions.htm and, for electronic format documents, subject to Terms and Conditions for Electronic Documents at www.sgs.com/terms_e-document.htm. Attention is drawn to the limitation of liability, indemnification and jurisdiction issues defined therein. Any holder of this document is advised that information contained hereon reflects the Company's findings at the time of its intervention only and within the limits of Client's instructions, if any. The Company's sole responsibility is to its Client and this document does not exonerate parties to a transaction from exercising all their rights and obligations under the transaction documents. This document cannot be reproduced except in full, without prior written approval of the Company. Any unauthorized alteration, forgery or falsification of the content or appearance of this document is unlawful and offenders may be prosecuted to the fullest extent of the law.

SGS Taiwan Ltd.

No.134,WuKungRoad,NewTaipeiIndustrialPark,WukuDistrict,NewTaipeiCity,Taiwan24803/新北市五股區新北產業園區五工路 134 號

台灣檢驗科技股份有限公司

t (886-2) 2299-3279

f (886-2) 2298-0488

www.tw.sgs.com

Member of SGS Group

4. TPC and DFS MEASUREMENT

4.1. TPC: Standard Applicable

According to §15.407(h)(1), Transmit power control (TPC). U-NII devices operating in the 5.25-5.35 GHz band and the 5.47-5.725 GHz band shall employ a TPC mechanism. The U-NII device is required to have the capability to operate at least 6 dB below the mean EIRP value of 30 dBm. A TPC mechanism is not required for systems with an e.i.r.p. of less than 500 mW.

4.1.1. Result: TPC is required since the maximum EIRP is greater than 500 mW.

4.2. DFS: Standard Applicable

According to §15.407(h)(2) and FCC KDB 905462 D02 , Radar Detection Function of Dynamic Frequency Selection (DFS).

U-NII devices operating in the 5.25-5.35 GHz and 5.47-5.725 GHz bands shall employ a DFS radar detection. According to RSS 247 6.3, Note: For IC the band 5600-5650 MHz, no operation is permitted.

Until further notice, devices subject to this annex shall not be capable of transmitting in the band 5600-5650 MHz. This restriction is for the protection of Environment Canada weather radars operating in this band. Devices operating in the bands 5250-5350 MHz, 5470-5600 MHz and 5650-5725 MHz band shall comply with the following:

- (a) Devices shall employ a DFS radar detection mechanism to detect the presence of radar systems and to avoid co-channel operation with radar systems (see Note below). The minimum DFS radar signal detection threshold is -62 dBm for devices with a maximum e.i.r.p. less than 200 mW, and -64 dBm for devices with a maximum e.i.r.p. of 200 mW to 1 W. The detection threshold power is the received power, averaged over a 1-microsecond reference to a 0 dBi antenna. The DFS process shall provide a uniform spreading of the loading over all the available channels.

Note: Test procedures for demonstrating compliance with the DFS radar detection requirements set out in this section are being evaluated by Industry Canada. As an interim measure, the Department will, until further notice, accept utilization of the DFS test procedures published by the U.S. Federal Communications Commission (FCC)³ to demonstrate compliance with the requirements of this section.

- (b) Operational requirements: the requirement for channel availability check time applies in the

Unless otherwise stated the results shown in this test report refer only to the sample(s) tested and such sample(s) are retained for 90 days only.

除非另有說明，此報告結果僅對測試之樣品負責，同時此樣品僅保留90天。本報告未經本公司書面許可，不可部份複製。

This document is issued by the Company subject to its General Conditions of Service printed overleaf, available on request or accessible at www.sgs.com/terms_and_conditions.htm and, for electronic format documents, subject to Terms and Conditions for Electronic Documents at www.sgs.com/terms_e-document.htm. Attention is drawn to the limitation of liability, indemnification and jurisdiction issues defined therein. Any holder of this document is advised that information contained hereon reflects the Company's findings at the time of its intervention only and within the limits of Client's instructions, if any. The Company's sole responsibility is to its Client and this document does not exonerate parties to a transaction from exercising all their rights and obligations under the transaction documents. This document cannot be reproduced except in full, without prior written approval of the Company. Any unauthorized alteration, forgery or falsification of the content or appearance of this document is unlawful and offenders may be prosecuted to the fullest extent of the law.

SGS Taiwan Ltd.

No.134,WuKungRoad,NewTaipeiIndustrialPark,WukuDistrict,NewTaipeiCity,Taiwan24803/新北市五股區新北產業園區五工路 134 號

台灣檢驗科技股份有限公司

t (886-2) 2299-3279

f (886-2) 2298-0488

www.tw.sgs.com

Member of SGS Group

master operational mode. The requirement for channel move time applies in both the master and slave operational modes.

- (i) In-service monitoring: an LE-LAN device should be able to monitor the operating channel to check that a co-channel radar has not moved or started operation within range of the LE-LAN device.

During in-service monitoring, the LE-LAN radar detection function continuously searches for radar signals between normal LE-LAN transmissions.

- (ii) Channel availability check time: the device shall check if there is a radar system already operating on the channel before it initiates a transmission on a channel and when it moves to a channel. The device may start using the channel if no radar signal with a power level greater than the interference threshold value specified in A9.3 (a) above is detected within 60 seconds.

- (iii) Channel move time: after a radar's signal is detected, the device shall cease all transmissions on the operating channel within 10 seconds. Transmission during this period shall consist of normal traffic for a maximum of 200 ms after detection of the radar signal. Intermittent management and control signals may also be sent during the remaining time to facilitate vacating the operating channel.

- (iv) Channel closing time: the maximum channel closing time is 260 ms. (v) Non-occupancy period: a channel that has been flagged as containing a radar signal, either by a channel availability check or in-service monitoring, is subject to a 30-minute non-occupancy period where the channel cannot be used by the LE-LAN device. The non-occupancy period starts from the time that the radar signal is detected.

Unless otherwise stated the results shown in this test report refer only to the sample(s) tested and such sample(s) are retained for 90 days only.

除非另有說明，此報告結果僅對測試之樣品負責，同時此樣品僅保留90天。本報告未經本公司書面許可，不可部份複製。

This document is issued by the Company subject to its General Conditions of Service printed overleaf, available on request or accessible at www.sgs.com/terms_and_conditions.htm and, for electronic format documents, subject to Terms and Conditions for Electronic Documents at www.sgs.com/terms_e-document.htm. Attention is drawn to the limitation of liability, indemnification and jurisdiction issues defined therein. Any holder of this document is advised that information contained hereon reflects the Company's findings at the time of its intervention only and within the limits of Client's instructions, if any. The Company's sole responsibility is to its Client and this document does not exonerate parties to a transaction from exercising all their rights and obligations under the transaction documents. This document cannot be reproduced except in full, without prior written approval of the Company. Any unauthorized alteration, forgery or falsification of the content or appearance of this document is unlawful and offenders may be prosecuted to the fullest extent of the law.

SGS Taiwan Ltd.

台灣檢驗科技股份有限公司

No.134,WuKungRoad,NewTaipeiIndustrialPark,WukuDistrict,NewTaipeiCity,Taiwan24803/新北市五股區新北產業園區五工路 134 號

t (886-2) 2299-3279

f (886-2) 2298-0488

www.tw.sgs.com

Member of SGS Group

4.2.1. Limit

Table 1: Applicability of DFS requirements prior to use of a channel

Requirement	Operational Mode		
	Master	Client(without radar detection)	Client(with radar detection)
Non-occupancy Period	Yes	Yes	Yes
DFS Detection Threshold	Yes	Not required	Yes
Channel Availability Check Time	Yes	Not required	Not required
U-NII Detection Bandwidth	Yes	Not required	Yes

Table 2: Applicability of DFS requirements during normal operation

Requirement	Operational Mode	
	Master Device or Client with Radar Detection	Client Without Radar Detection
DFS Detection Threshold	Yes	Not required
Channel Closing Transmission time	Yes	Yes
Channel Move time	Yes	Yes
U-NII Detection Bandwidth	Yes	Not required

Unless otherwise stated the results shown in this test report refer only to the sample(s) tested and such sample(s) are retained for 90 days only.

除非另有說明，此報告結果僅對測試之樣品負責，同時此樣品僅保留90天。本報告未經本公司書面許可，不可部份複製。

This document is issued by the Company subject to its General Conditions of Service printed overleaf, available on request or accessible at www.sgs.com/terms_and_conditions.htm and, for electronic format documents, subject to Terms and Conditions for Electronic Documents at www.sgs.com/terms_e-document.htm. Attention is drawn to the limitation of liability, indemnification and jurisdiction issues defined therein. Any holder of this document is advised that information contained hereon reflects the Company's findings at the time of its intervention only and within the limits of Client's instructions, if any. The Company's sole responsibility is to its Client and this document does not exonerate parties to a transaction from exercising all their rights and obligations under the transaction documents. This document cannot be reproduced except in full, without prior written approval of the Company. Any unauthorized alteration, forgery or falsification of the content or appearance of this document is unlawful and offenders may be prosecuted to the fullest extent of the law.

SGS Taiwan Ltd.

No.134,WuKungRoad,NewTaipeiIndustrialPark,WukuDistrict,NewTaipeiCity,Taiwan24803/新北市五股區新北產業園區五工路 134 號

台灣檢驗科技股份有限公司

t (886-2) 2299-3279

f (886-2) 2298-0488

www.tw.sgs.com

Member of SGS Group

Additional requirements for devices with multiple bandwidth mode	Master Device or Client with Radar Detection	Client Without Radar Detection
U-NII Detection Bandwidth and Statistical Performance Check	All BW modes must be tested	Not required
Channel Move Time and Channel Closing Transmission Time	Test using widest BW mode available	Test using the widest BW mode available for the link
All other tests	Any single BW mode	Not required
<p>Note: Frequencies selected for statistical performance check (Section 7.8.4) should include several frequencies within the radar detection bandwidth and frequencies near the edge of the radar detection bandwidth. For 802.11 devices it is suggested to select frequencies in each of the bonded 20 MHz channels and the channel center frequency.</p>		

Unless otherwise stated the results shown in this test report refer only to the sample(s) tested and such sample(s) are retained for 90 days only.

除非另有說明，此報告結果僅對測試之樣品負責，同時此樣品僅保留90天。本報告未經本公司書面許可，不可部份複製。

This document is issued by the Company subject to its General Conditions of Service printed overleaf, available on request or accessible at www.sgs.com/terms_and_conditions.htm and, for electronic format documents, subject to Terms and Conditions for Electronic Documents at www.sgs.com/terms_e-document.htm. Attention is drawn to the limitation of liability, indemnification and jurisdiction issues defined therein. Any holder of this document is advised that information contained hereon reflects the Company's findings at the time of its intervention only and within the limits of Client's instructions, if any. The Company's sole responsibility is to its Client and this document does not exonerate parties to a transaction from exercising all their rights and obligations under the transaction documents. This document cannot be reproduced except in full, without prior written approval of the Company. Any unauthorized alteration, forgery or falsification of the content or appearance of this document is unlawful and offenders may be prosecuted to the fullest extent of the law.

SGS Taiwan Ltd.

No.134,WuKungRoad,NewTaipeiIndustrialPark,WukuDistrict,NewTaipeiCity,Taiwan24803/新北市五股區新北產業園區五工路 134 號

台灣檢驗科技股份有限公司

t (886-2) 2299-3279

f (886-2) 2298-0488

www.tw.sgs.com

Member of SGS Group

Table 3: Interference Threshold values, Master or Client incorporating In-Service Monitoring

Maximum Transmit Power	Value (See Notes 1, 2, and 3)
EIRP \geq 200 milliwatt	-64 dBm
EIRP < 200 milliwatt and power spectral density < 10 dBm/MHz	-62 dBm
EIRP < 200 milliwatt that do not meet the power spectral density requirement	-64 dBm
<p>Note 1: This is the level at the input of the receiver assuming a 0 dBi receive antenna.</p> <p>Note 2: Throughout these test procedures an additional 1 dB has been added to the amplitude of the test transmission waveforms to account for variations in measurement equipment. This will ensure that the test signal is at or above the detection threshold level to trigger a DFS response.</p> <p>Note 3: EIRP is based on the highest antenna gain. For MIMO devices refer to KDB Publication 662911 D01.</p>	

Table 4: DFS Response requirement values

Parameter	Value
<i>Non-occupancy period</i>	Minimum 30 minutes
<i>Channel Availability Check Time</i>	60 seconds
<i>Channel Move Time</i>	10 seconds See Note 1.
<i>Channel Closing Transmission Time</i>	200 milliseconds + an aggregate of 60 milliseconds over remaining 10 second period. See Notes 1 and 2.
<i>U-NII Detection Bandwidth</i>	Minimum 100% of the U- NII 99% transmission power bandwidth. See Note 3.
<p>Note 1: <i>Channel Move Time</i> and the <i>Channel Closing Transmission Time</i> should be performed with Radar Type 0. The measurement timing begins at the end of the Radar Type 0 burst.</p> <p>Note 2: The <i>Channel Closing Transmission Time</i> is comprised of 200 milliseconds starting at the beginning of the <i>Channel Move Time</i> plus any additional intermittent control signals required to facilitate a <i>Channel</i> move (an aggregate of 60 milliseconds) during the remainder of the 10 second period. The aggregate duration of control signals will not count quiet periods in between transmissions.</p> <p>Note 3: During the <i>U-NII Detection Bandwidth</i> detection test, radar type 0 should be used. For each frequency step the minimum percentage of detection is 90 percent. Measurements are performed with no data traffic.</p>	

Unless otherwise stated the results shown in this test report refer only to the sample(s) tested and such sample(s) are retained for 90 days only.

除非另有說明，此報告結果僅對測試之樣品負責，同時此樣品僅保留90天。本報告未經本公司書面許可，不可部份複製。

This document is issued by the Company subject to its General Conditions of Service printed overleaf, available on request or accessible at www.sgs.com/terms_and_conditions.htm and, for electronic format documents, subject to Terms and Conditions for Electronic Documents at www.sgs.com/terms_e-document.htm. Attention is drawn to the limitation of liability, indemnification and jurisdiction issues defined therein. Any holder of this document is advised that information contained hereon reflects the Company's findings at the time of its intervention only and within the limits of Client's instructions, if any. The Company's sole responsibility is to its Client and this document does not exonerate parties to a transaction from exercising all their rights and obligations under the transaction documents. This document cannot be reproduced except in full, without prior written approval of the Company. Any unauthorized alteration, forgery or falsification of the content or appearance of this document is unlawful and offenders may be prosecuted to the fullest extent of the law.

SGS Taiwan Ltd.

No.134,WuKungRoad,NewTaipeiIndustrialPark,WukuDistrict,NewTaipeiCity,Taiwan24803/新北市五股區新北產業園區五工路 134 號

台灣檢驗科技股份有限公司

t (886-2) 2299-3279

f (886-2) 2298-0488

www.tw.sgs.com

Member of SGS Group

Table 5: Radar Test Waveforms
Short Pulse Radar

Radar Type	Pulse Width (μsec)	PRI (μsec)	Number of Pulses	Minimum Percentage of Successful Detection	Minimum Number of Trials
0	1	1428	18	See Note 1	See Note 1
1	1	Test A: 15 unique PRI values randomly selected from the list of 23 PRI values in Table 5a	Roundup $\left\{ \left(\frac{1}{360} \right) \cdot \left(\frac{19 \cdot 10^6}{\text{PRI}_{\mu\text{sec}}} \right) \right\}$	60%	30
		Test B: 15 unique PRI values randomly selected within the range of 518-3066 μsec, with a minimum increment of 1 μsec, excluding PRI values selected in Test A			
2	1-5	150-230	23-29	60%	30
3	6-10	200-500	16-18	60%	30
4	11-20	200-500	12-16	60%	30
Aggregate (Radar Types 1-4)				80%	120
Note 1: Short Pulse Radar Type 0 should be used for the detection bandwidth test, channel move time, and channel closing time tests.					

Long Pulse Radar

Radar Type	Pulse Width (μsec)	Chirp Width (MHz)	PRI (μsec)	Number of Pulses per Burst	Number of Bursts	Minimum Percentage of Successful Detection	Minimum Number of Trials
5	50-100	5-20	1000-2000	1-3	8-20	80%	30

Frequency Hopping Radar

Radar Type	Pulse Width (μsec)	PRI (μsec)	Pulses per Hop	Hopping Rate (kHz)	Hopping Sequence Length (msec)	Minimum Percentage of Successful Detection	Minimum Number of Trials
6	1	333	9	0.333	300	70%	30

The applicant of this given application confirms that information regarding the parameters of the detected Radar Waveforms is not available to the end user.

Unless otherwise stated the results shown in this test report refer only to the sample(s) tested and such sample(s) are retained for 90 days only.

除非另有說明，此報告結果僅對測試之樣品負責，同時此樣品僅保留90天。本報告未經本公司書面許可，不可部份複製。

This document is issued by the Company subject to its General Conditions of Service printed overleaf, available on request or accessible at www.sgs.com/terms_and_conditions.htm and, for electronic format documents, subject to Terms and Conditions for Electronic Documents at www.sgs.com/terms_e-document.htm. Attention is drawn to the limitation of liability, indemnification and jurisdiction issues defined therein. Any holder of this document is advised that information contained hereon reflects the Company's findings at the time of its intervention only and within the limits of Client's instructions, if any. The Company's sole responsibility is to its Client and this document does not exonerate parties to a transaction from exercising all their rights and obligations under the transaction documents. This document cannot be reproduced except in full, without prior written approval of the Company. Any unauthorized alteration, forgery or falsification of the content or appearance of this document is unlawful and offenders may be prosecuted to the fullest extent of the law.

SGS Taiwan Ltd.

No.134,WuKungRoad,NewTaipeiIndustrialPark,WukuDistrict,NewTaipeiCity,Taiwan24803/新北市五股區新北產業園區五工路 134 號

台灣檢驗科技股份有限公司

t (886-2) 2299-3279

f (886-2) 2298-0488

www.tw.sgs.com

Member of SGS Group

4.2.2. Test Setup

Setup for Master with injection at the Master

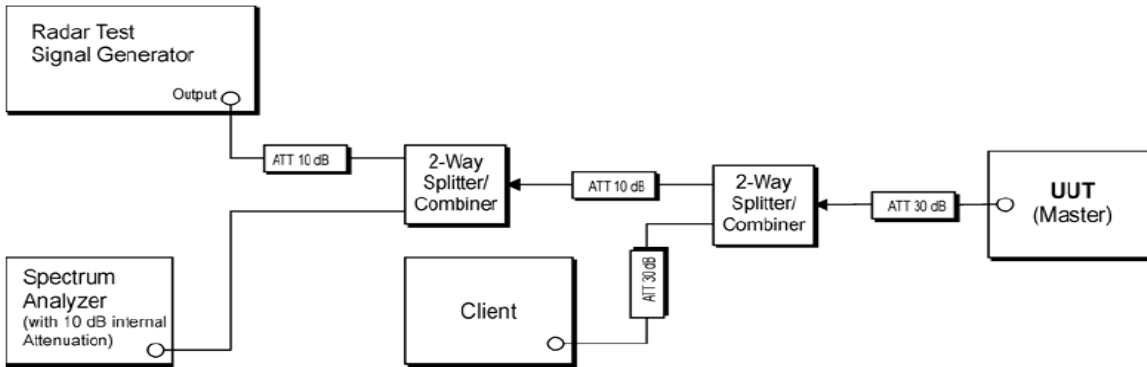

Setup for Client with injection at the Master

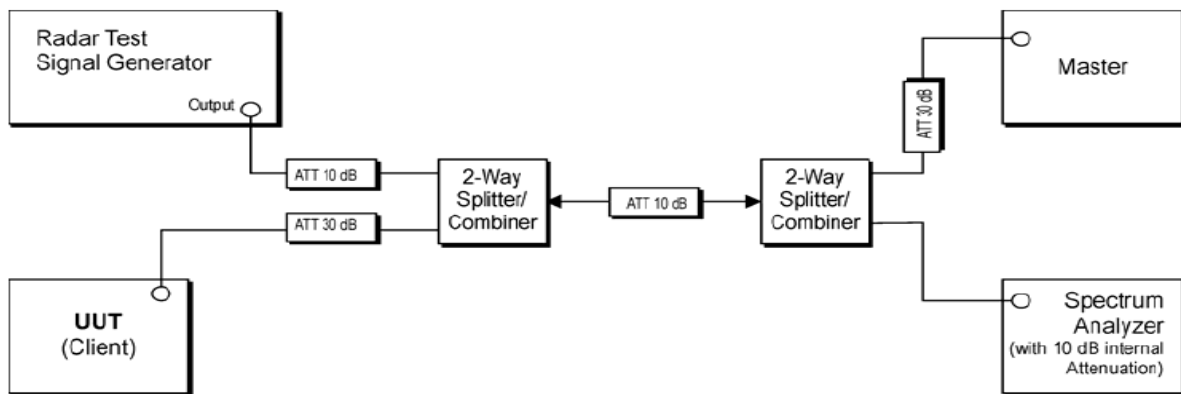

Setup for Client with injection at the Client

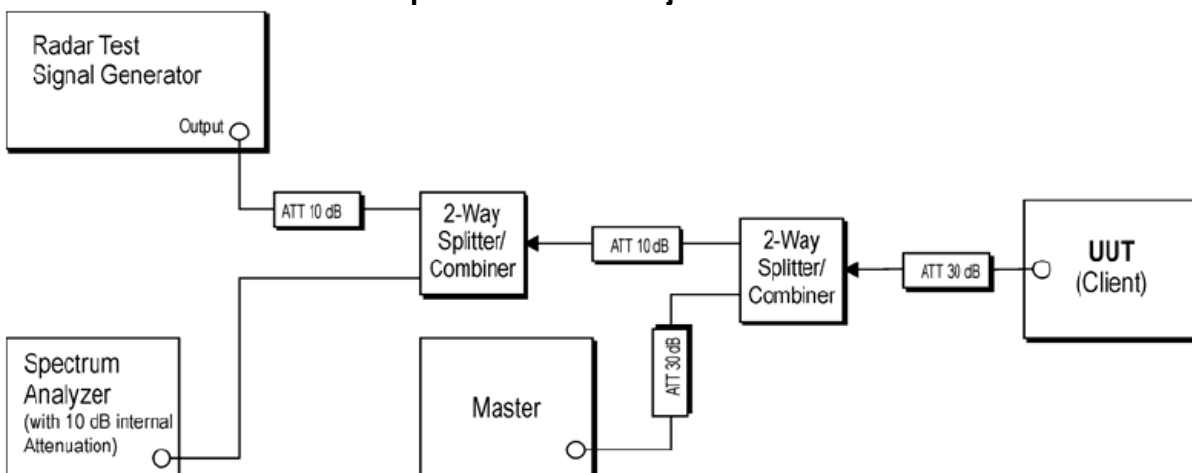

Unless otherwise stated the results shown in this test report refer only to the sample(s) tested and such sample(s) are retained for 90 days only.

除非另有說明，此報告結果僅對測試之樣品負責，同時此樣品僅保留90天。本報告未經本公司書面許可，不可部份複製。

This document is issued by the Company subject to its General Conditions of Service printed overleaf, available on request or accessible at www.sgs.com/terms_and_conditions.htm and, for electronic format documents, subject to Terms and Conditions for Electronic Documents at www.sgs.com/terms_e-document.htm. Attention is drawn to the limitation of liability, indemnification and jurisdiction issues defined therein. Any holder of this document is advised that information contained hereon reflects the Company's findings at the time of its intervention only and within the limits of Client's instructions, if any. The Company's sole responsibility is to its Client and this document does not exonerate parties to a transaction from exercising all their rights and obligations under the transaction documents. This document cannot be reproduced except in full, without prior written approval of the Company. Any unauthorized alteration, forgery or falsification of the content or appearance of this document is unlawful and offenders may be prosecuted to the fullest extent of the law.

4.2.3. Test Equipment Used:

Conducted Emission Test Site					
EQUIPMENT TYPE	MFR	MODEL NUMBER	SERIAL NUMBER	LAST CAL.	CAL DUE.
Signal Generator	Agilent	E4438C	MY45093613	07/31/2015	07/30/2016
Spectrum Analyzer	Agilent	E4446A	MY51100003	01/28/2016	01/27/2017
DC Block	Mini-Circuits	BLK-18-S+	1	01/02/2016	01/01/2017
Attenuator	Mini-Circuit	BW-S10W2+	002	01/02/2016	01/01/2017
Power Splitter	Mini-Circuits	ZN2PD-9G-S+	N/A	01/02/2016	01/01/2017
Power Splitter	Mini-Circuits	ZN2PD-9G-S+	N/A	01/02/2016	01/01/2017
Attenuator	Agilent	8495B	3308A22470	01/02/2016	01/01/2017
Attenuator	HP	8494B	2812A170605	01/02/2016	01/01/2017
Horn antenna	ETS.LINDGREN	3117	123995	05/05/2015	05/04/2016
BBHA9120D	Schwarzbeck	9120D	603	09/10/2015	09/09/2016

4.2.4. Description of EUT:

EUT operates over the 5250-5350MHz and 5470-5725MHz ranges and EUT is a Master device w/o radar detection and DFS capability. EUT has a gain of 4.2dBi in the 5GHz Band.

For FCC the EUT operates over the 5250-5350 MHz and 5470-5725 MHz ranges.

Three identical antennas are utilized to meet the diversity and MIMO operational requirements. TPC is required since the maximum EIRP is greater than 500 mW (27 dBm).

The EUT utilizes the 802.11ac architecture. Three nominal channel bandwidths are implemented: 20 MHz, 40 MHz and 80 MHz.

WLAN traffic is generated by streaming the mpeg file from the master to slave in full monitor video mode using the media player.

The rated output power of the Master unit is > 23dBm (EIRP). Therefore the required interference threshold level is -64 dBm.

While calibrate the path on antenna port of DFS test equipment (master), measurements equipments (spectrum) is ensured to be 50 Ohms, and therefore verification on antenna gain measurement can be ignored.

Unless otherwise stated the results shown in this test report refer only to the sample(s) tested and such sample(s) are retained for 90 days only.

除非另有說明，此報告結果僅對測試之樣品負責，同時此樣品僅保留90天。本報告未經本公司書面許可，不可部份複製。

This document is issued by the Company subject to its General Conditions of Service printed overleaf, available on request or accessible at www.sgs.com/terms_and_conditions.htm and, for electronic format documents, subject to Terms and Conditions for Electronic Documents at www.sgs.com/terms_e-document.htm. Attention is drawn to the limitation of liability, indemnification and jurisdiction issues defined therein. Any holder of this document is advised that information contained hereon reflects the Company's findings at the time of its intervention only and within the limits of Client's instructions, if any. The Company's sole responsibility is to its Client and this document does not exonerate parties to a transaction from exercising all their rights and obligations under the transaction documents. This document cannot be reproduced except in full, without prior written approval of the Company. Any unauthorized alteration, forgery or falsification of the content or appearance of this document is unlawful and offenders may be prosecuted to the fullest extent of the law.

SGS Taiwan Ltd.

No.134,WuKungRoad,NewTaipeiIndustrialPark,WukuDistrict,NewTaipeiCity,Taiwan24803/新北市五股區新北產業園區五工路 134 號

台灣檢驗科技股份有限公司

t (886-2) 2299-3279

f (886-2) 2298-0488

www.tw.sgs.com

Member of SGS Group

The EUT uses three transmitter/receiver chains and three receive only chain, each connected to an antenna to perform radiated tests.

The Slave device associated with the EUT during these tests does not have radar detection capability.

The software installed in the access point is firmware-venom-arm revision 2.0.0.

Unless otherwise stated the results shown in this test report refer only to the sample(s) tested and such sample(s) are retained for 90 days only.

除非另有說明，此報告結果僅對測試之樣品負責，同時此樣品僅保留90天。本報告未經本公司書面許可，不可部份複製。

This document is issued by the Company subject to its General Conditions of Service printed overleaf, available on request or accessible at www.sgs.com/terms_and_conditions.htm and, for electronic format documents, subject to Terms and Conditions for Electronic Documents at www.sgs.com/terms_e-document.htm. Attention is drawn to the limitation of liability, indemnification and jurisdiction issues defined therein. Any holder of this document is advised that information contained hereon reflects the Company's findings at the time of its intervention only and within the limits of Client's instructions, if any. The Company's sole responsibility is to its Client and this document does not exonerate parties to a transaction from exercising all their rights and obligations under the transaction documents. This document cannot be reproduced except in full, without prior written approval of the Company. Any unauthorized alteration, forgery or falsification of the content or appearance of this document is unlawful and offenders may be prosecuted to the fullest extent of the law.

SGS Taiwan Ltd.

No.134,WuKungRoad,NewTaipeiIndustrialPark,WukuDistrict,NewTaipeiCity,Taiwan24803/新北市五股區新北產業園區五工路 134 號

台灣檢驗科技股份有限公司

t (886-2) 2299-3279

f (886-2) 2298-0488

www.tw.sgs.com

Member of SGS Group

4.2.5. Test results

Calibration plots for each of the required radar waveforms

Radar type 0

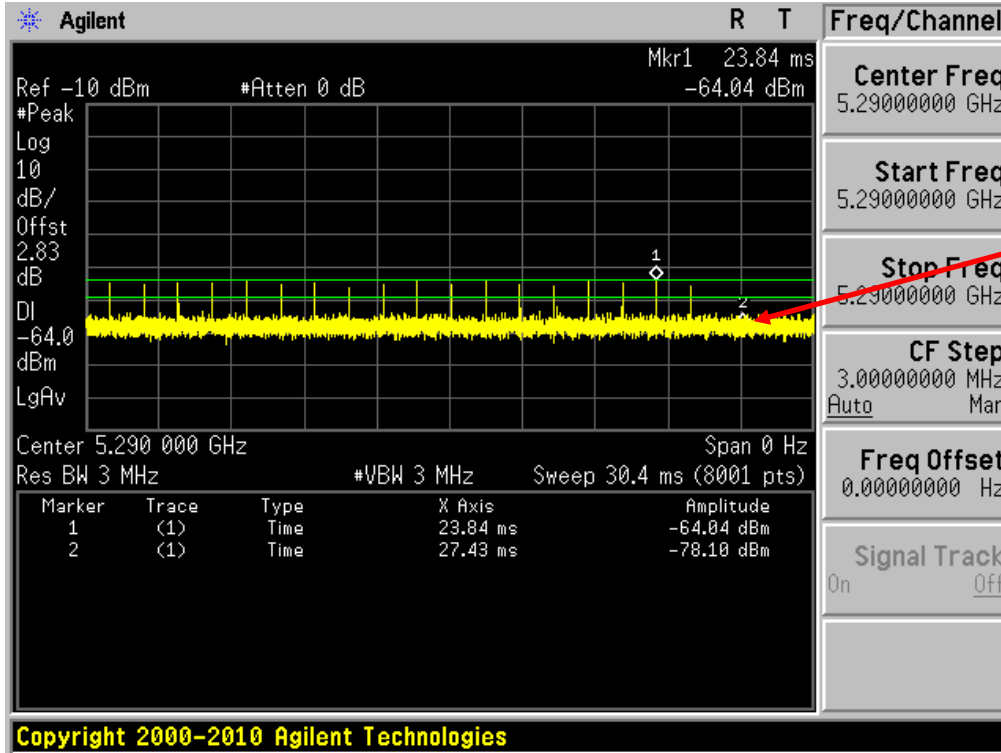

Noise Floor

Unless otherwise stated the results shown in this test report refer only to the sample(s) tested and such sample(s) are retained for 90 days only.

除非另有說明，此報告結果僅對測試之樣品負責，同時此樣品僅保留90天。本報告未經本公司書面許可，不可部份複製。

This document is issued by the Company subject to its General Conditions of Service printed overleaf, available on request or accessible at www.sgs.com/terms_and_conditions.htm and, for electronic format documents, subject to Terms and Conditions for Electronic Documents at www.sgs.com/terms_e-document.htm. Attention is drawn to the limitation of liability, indemnification and jurisdiction issues defined therein. Any holder of this document is advised that information contained hereon reflects the Company's findings at the time of its intervention only and within the limits of Client's instructions, if any. The Company's sole responsibility is to its Client and this document does not exonerate parties to a transaction from exercising all their rights and obligations under the transaction documents. This document cannot be reproduced except in full, without prior written approval of the Company. Any unauthorized alteration, forgery or falsification of the content or appearance of this document is unlawful and offenders may be prosecuted to the fullest extent of the law.

SGS Taiwan Ltd.

No.134,WuKungRoad,NewTaipeiIndustrialPark,WukuDistrict,NewTaipeiCity,Taiwan24803/新北市五股區新北產業園區五工路 134 號

台灣檢驗科技股份有限公司

t (886-2) 2299-3279

f (886-2) 2298-0488

www.tw.sgs.com

Member of SGS Group

Radar type 1

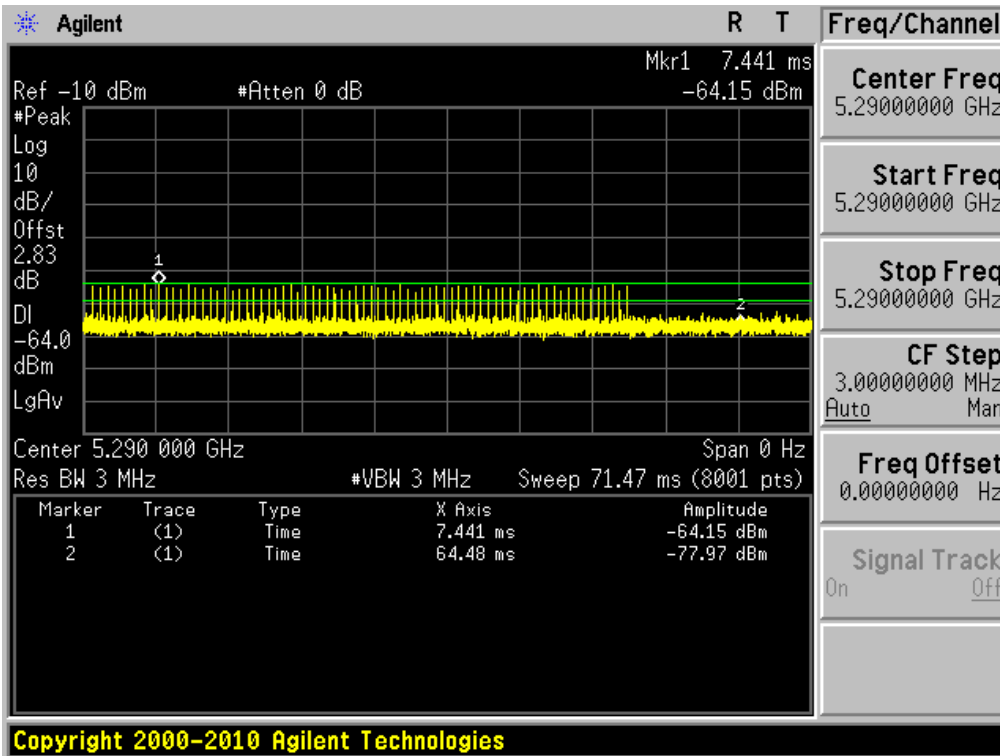

Radar type 2

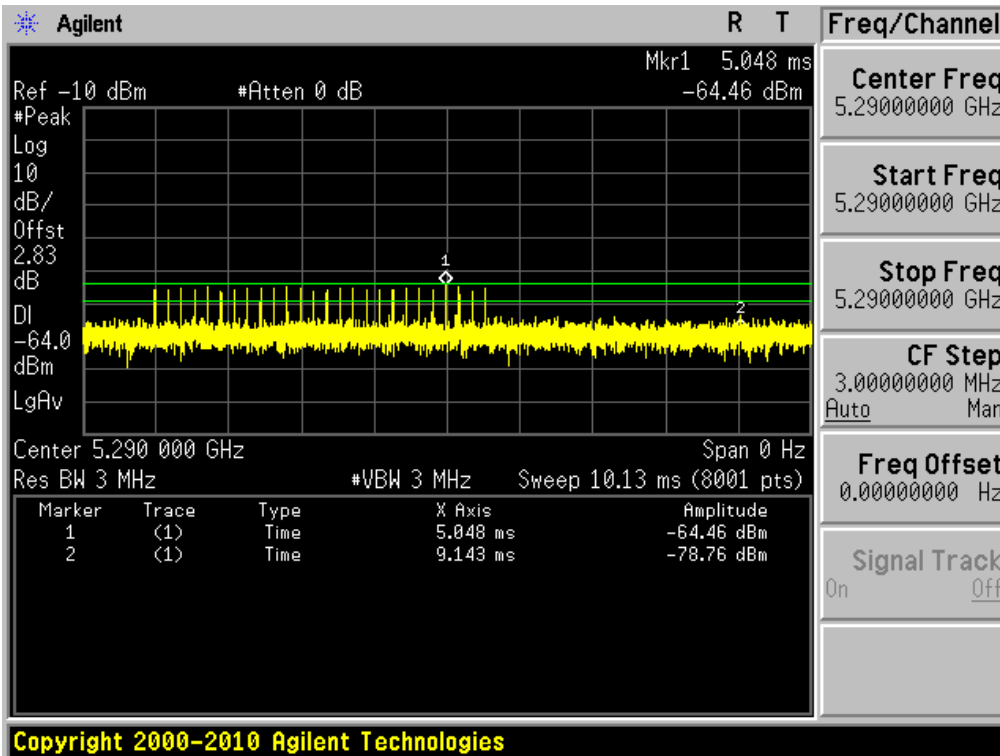

Unless otherwise stated the results shown in this test report refer only to the sample(s) tested and such sample(s) are retained for 90 days only.

除非另有說明，此報告結果僅對測試之樣品負責，同時此樣品僅保留90天。本報告未經本公司書面許可，不可部份複製。

This document is issued by the Company subject to its General Conditions of Service printed overleaf, available on request or accessible at www.sgs.com/terms_and_conditions.htm and, for electronic format documents, subject to Terms and Conditions for Electronic Documents at www.sgs.com/terms_e-document.htm. Attention is drawn to the limitation of liability, indemnification and jurisdiction issues defined therein. Any holder of this document is advised that information contained hereon reflects the Company's findings at the time of its intervention only and within the limits of Client's instructions, if any. The Company's sole responsibility is to its Client and this document does not exonerate parties to a transaction from exercising all their rights and obligations under the transaction documents. This document cannot be reproduced except in full, without prior written approval of the Company. Any unauthorized alteration, forgery or falsification of the content or appearance of this document is unlawful and offenders may be prosecuted to the fullest extent of the law.

SGS Taiwan Ltd.

No.134,WuKungRoad,NewTaipeiIndustrialPark,WukuDistrict,NewTaipeiCity,Taiwan24803/新北市五股區新北產業園區五工路 134 號

台灣檢驗科技股份有限公司

t (886-2) 2299-3279

f (886-2) 2298-0488

www.tw.sgs.com

Member of SGS Group

Radar type 3

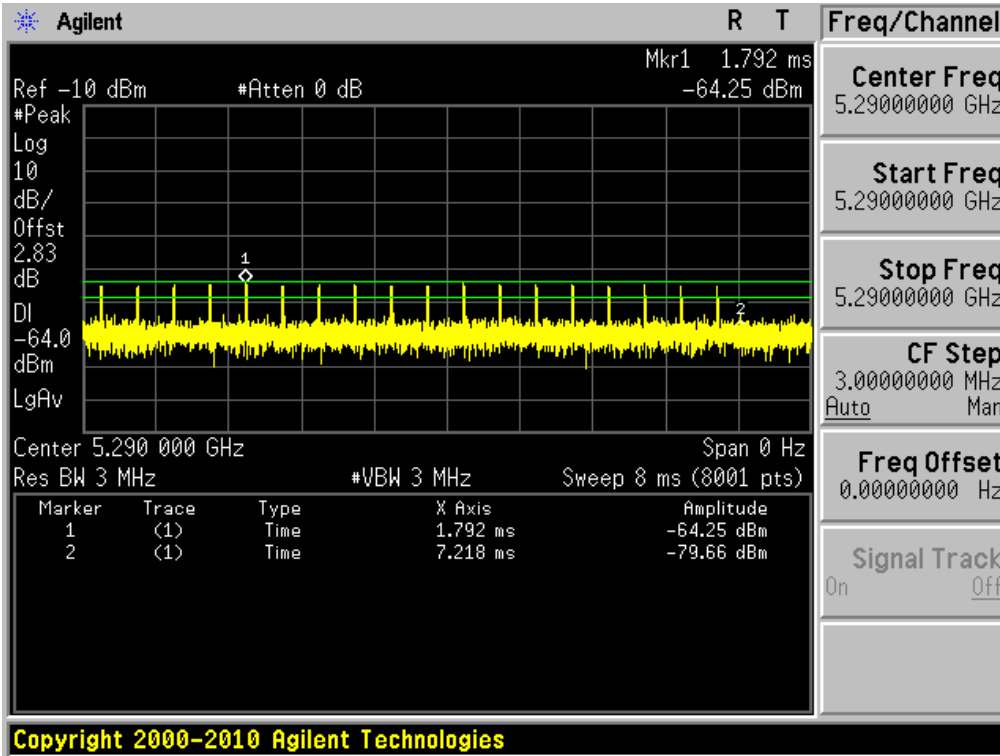

Radar type 4

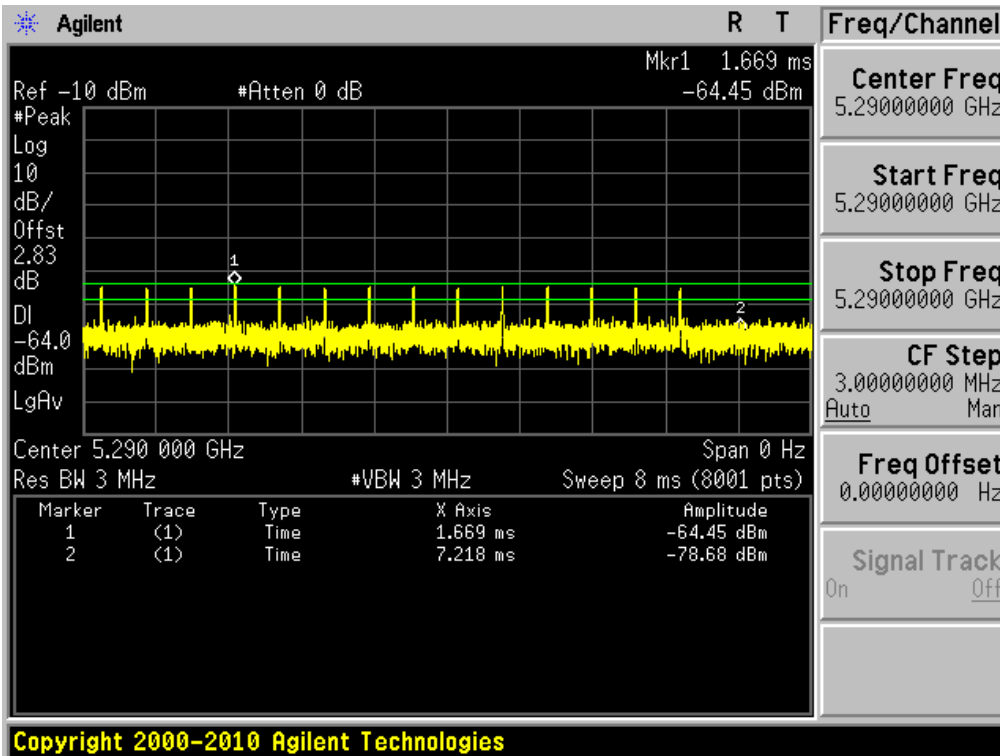

Unless otherwise stated the results shown in this test report refer only to the sample(s) tested and such sample(s) are retained for 90 days only.

除非另有說明，此報告結果僅對測試之樣品負責，同時此樣品僅保留90天。本報告未經本公司書面許可，不可部份複製。

This document is issued by the Company subject to its General Conditions of Service printed overleaf, available on request or accessible at www.sgs.com/terms_and_conditions.htm and, for electronic format documents, subject to Terms and Conditions for Electronic Documents at www.sgs.com/terms_e-document.htm. Attention is drawn to the limitation of liability, indemnification and jurisdiction issues defined therein. Any holder of this document is advised that information contained hereon reflects the Company's findings at the time of its intervention only and within the limits of Client's instructions, if any. The Company's sole responsibility is to its Client and this document does not exonerate parties to a transaction from exercising all their rights and obligations under the transaction documents. This document cannot be reproduced except in full, without prior written approval of the Company. Any unauthorized alteration, forgery or falsification of the content or appearance of this document is unlawful and offenders may be prosecuted to the fullest extent of the law.

SGS Taiwan Ltd.

No. 134, WuKungRoad, NewTaipeiIndustrialPark, WukuDistrict, NewTaipeiCity, Taiwan24803/新北市五股區新北產業園區五工路 134 號

台灣檢驗科技股份有限公司

t (886-2) 2299-3279

f (886-2) 2298-0488

www.tw.sgs.com

Member of SGS Group

Radar type 5

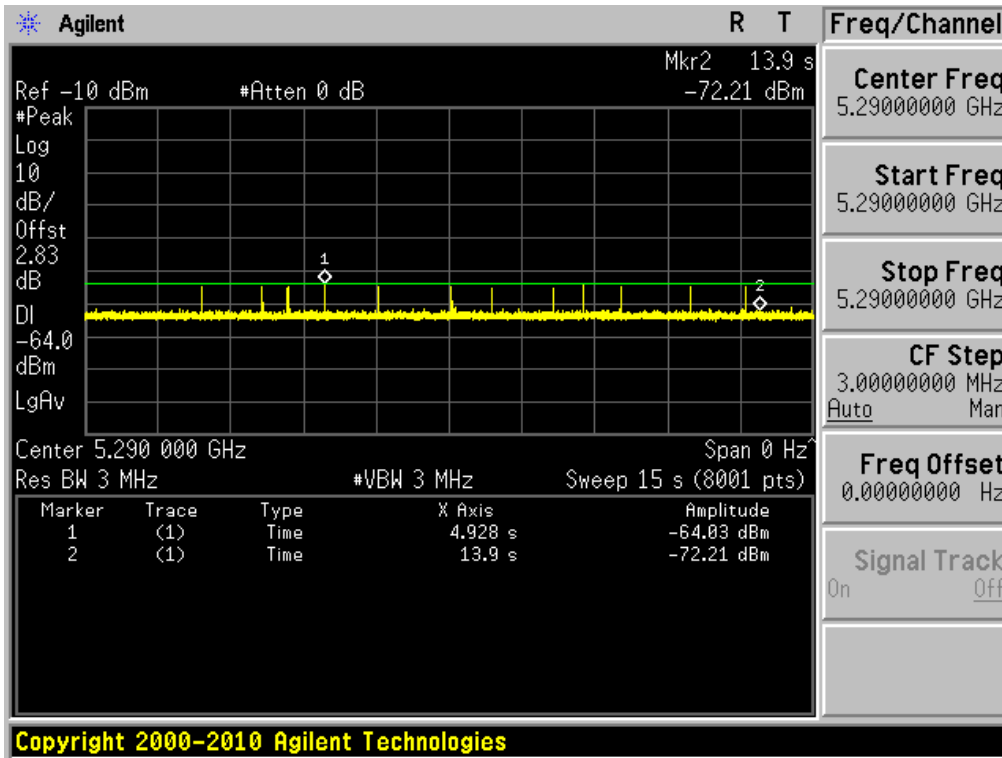

Radar type 6

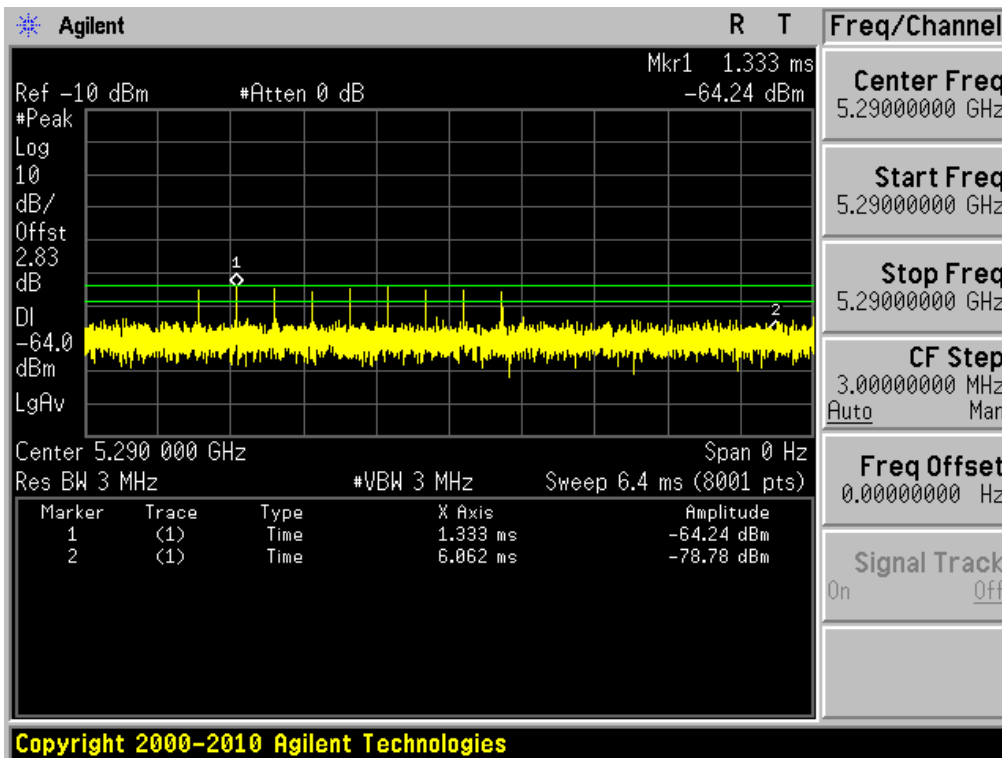

Unless otherwise stated the results shown in this test report refer only to the sample(s) tested and such sample(s) are retained for 90 days only.

除非另有說明，此報告結果僅對測試之樣品負責，同時此樣品僅保留90天。本報告未經本公司書面許可，不可部份複製。

This document is issued by the Company subject to its General Conditions of Service printed overleaf, available on request or accessible at www.sgs.com/terms_and_conditions.htm and, for electronic format documents, subject to Terms and Conditions for Electronic Documents at www.sgs.com/terms_e-document.htm. Attention is drawn to the limitation of liability, indemnification and jurisdiction issues defined therein. Any holder of this document is advised that information contained hereon reflects the Company's findings at the time of its intervention only and within the limits of Client's instructions, if any. The Company's sole responsibility is to its Client and this document does not exonerate parties to a transaction from exercising all their rights and obligations under the transaction documents. This document cannot be reproduced except in full, without prior written approval of the Company. Any unauthorized alteration, forgery or falsification of the content or appearance of this document is unlawful and offenders may be prosecuted to the fullest extent of the law.

WLAN traffic

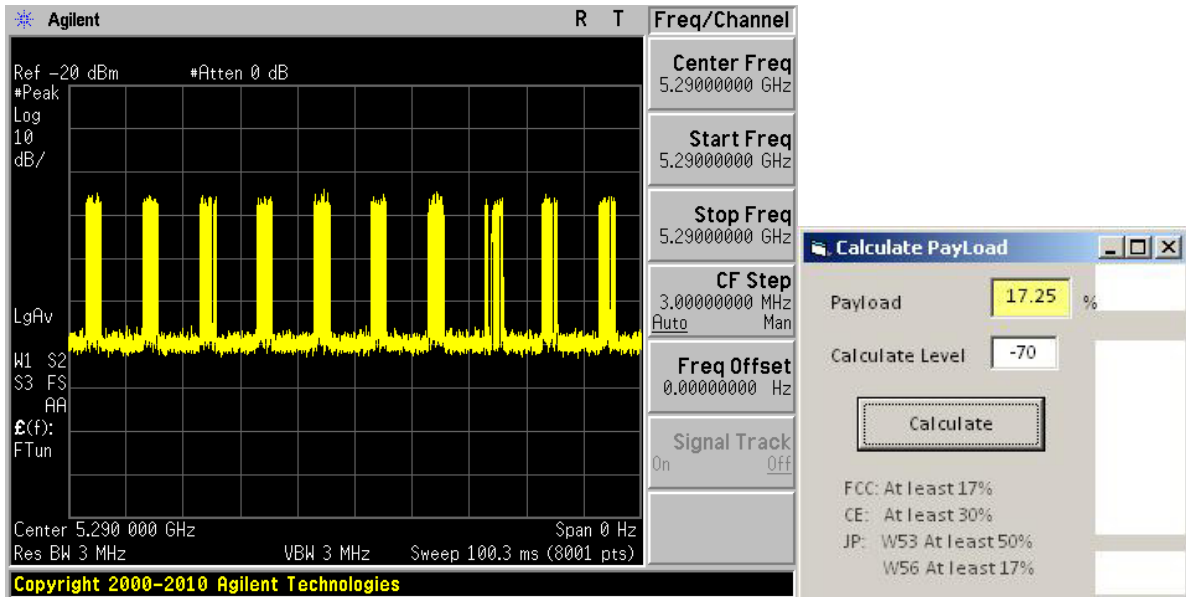

Radar Type 0 Channel Move Time

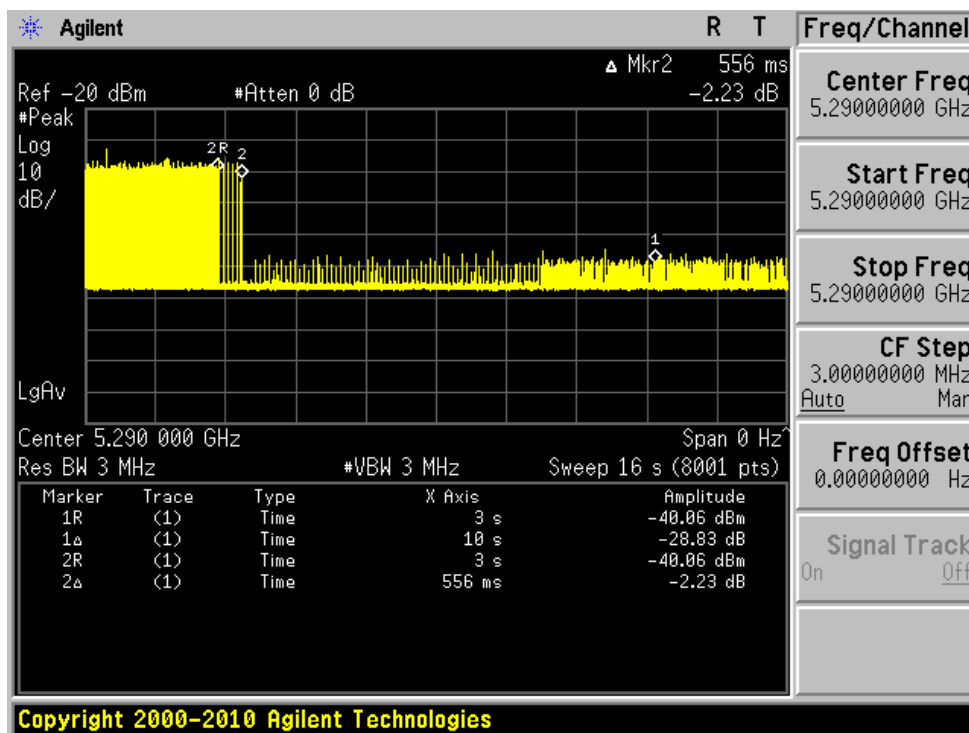

Unless otherwise stated the results shown in this test report refer only to the sample(s) tested and such sample(s) are retained for 90 days only.

除非另有說明，此報告結果僅對測試之樣品負責，同時此樣品僅保留90天。本報告未經本公司書面許可，不可部份複製。

This document is issued by the Company subject to its General Conditions of Service printed overleaf, available on request or accessible at www.sgs.com/terms_and_conditions.htm and, for electronic format documents, subject to Terms and Conditions for Electronic Documents at www.sgs.com/terms_e-document.htm. Attention is drawn to the limitation of liability, indemnification and jurisdiction issues defined therein. Any holder of this document is advised that information contained hereon reflects the Company's findings at the time of its intervention only and within the limits of Client's instructions, if any. The Company's sole responsibility is to its Client and this document does not exonerate parties to a transaction from exercising all their rights and obligations under the transaction documents. This document cannot be reproduced except in full, without prior written approval of the Company. Any unauthorized alteration, forgery or falsification of the content or appearance of this document is unlawful and offenders may be prosecuted to the fullest extent of the law.

SGS Taiwan Ltd.

No.134,WuKungRoad,NewTaipeiIndustrialPark,WukuDistrict,NewTaipeiCity,Taiwan24803/新北市五股區新北產業園區五工路 134 號

台灣檢驗科技股份有限公司

t (886-2) 2299-3279

f (886-2) 2298-0488

www.tw.sgs.com

Member of SGS Group

Radar Type 0 Channel Closing Transmission Time - 1

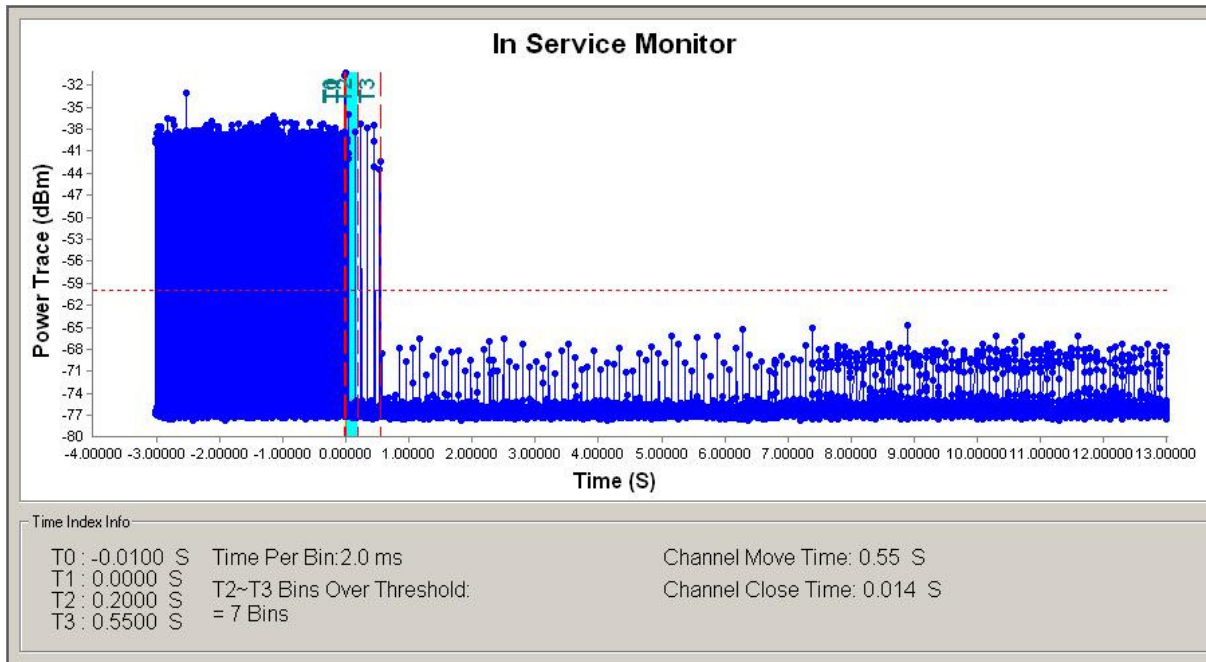

Radar Type 0 Channel Closing Transmission Time - 2

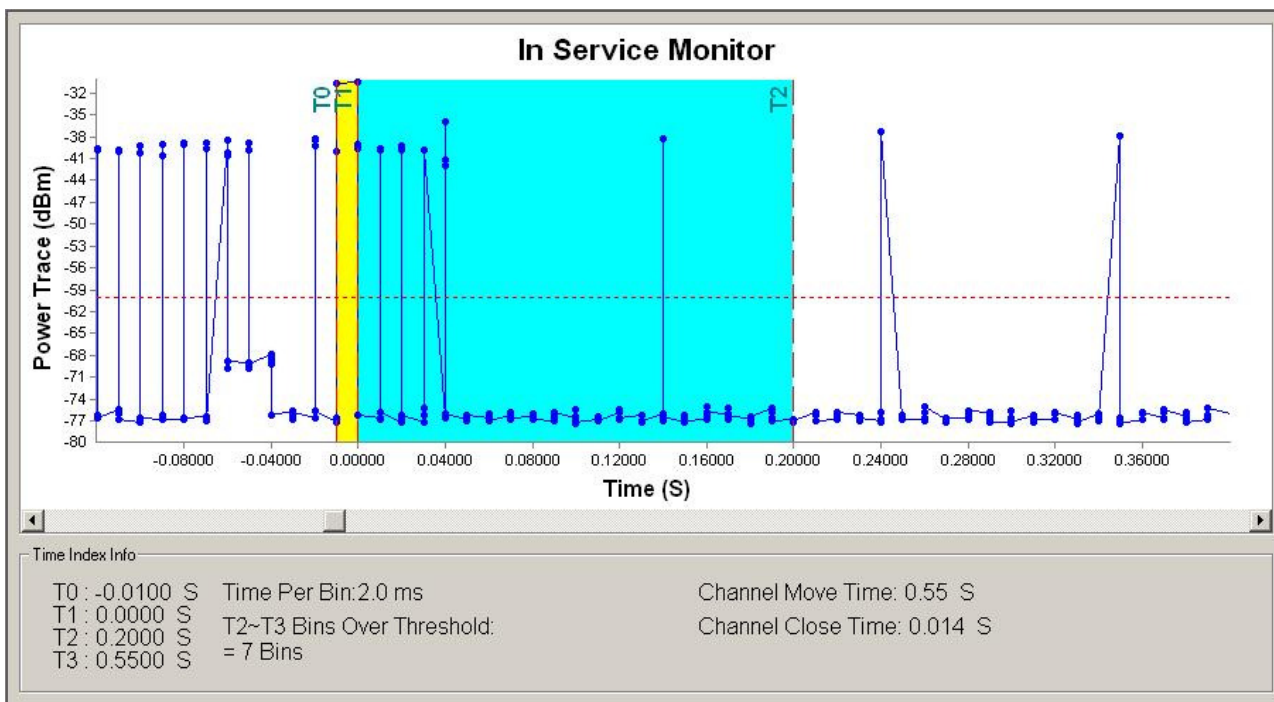

Unless otherwise stated the results shown in this test report refer only to the sample(s) tested and such sample(s) are retained for 90 days only.

除非另有說明，此報告結果僅對測試之樣品負責，同時此樣品僅保留90天。本報告未經本公司書面許可，不可部份複製。

This document is issued by the Company subject to its General Conditions of Service printed overleaf, available on request or accessible at www.sgs.com/terms_and_conditions.htm and, for electronic format documents, subject to Terms and Conditions for Electronic Documents at www.sgs.com/terms_e-document.htm. Attention is drawn to the limitation of liability, indemnification and jurisdiction issues defined therein. Any holder of this document is advised that information contained hereon reflects the Company's findings at the time of its intervention only and within the limits of Client's instructions, if any. The Company's sole responsibility is to its Client and this document does not exonerate parties to a transaction from exercising all their rights and obligations under the transaction documents. This document cannot be reproduced except in full, without prior written approval of the Company. Any unauthorized alteration, forgery or falsification of the content or appearance of this document is unlawful and offenders may be prosecuted to the fullest extent of the law.

Radar Type 0 Channel Closing Transmission Time - 3

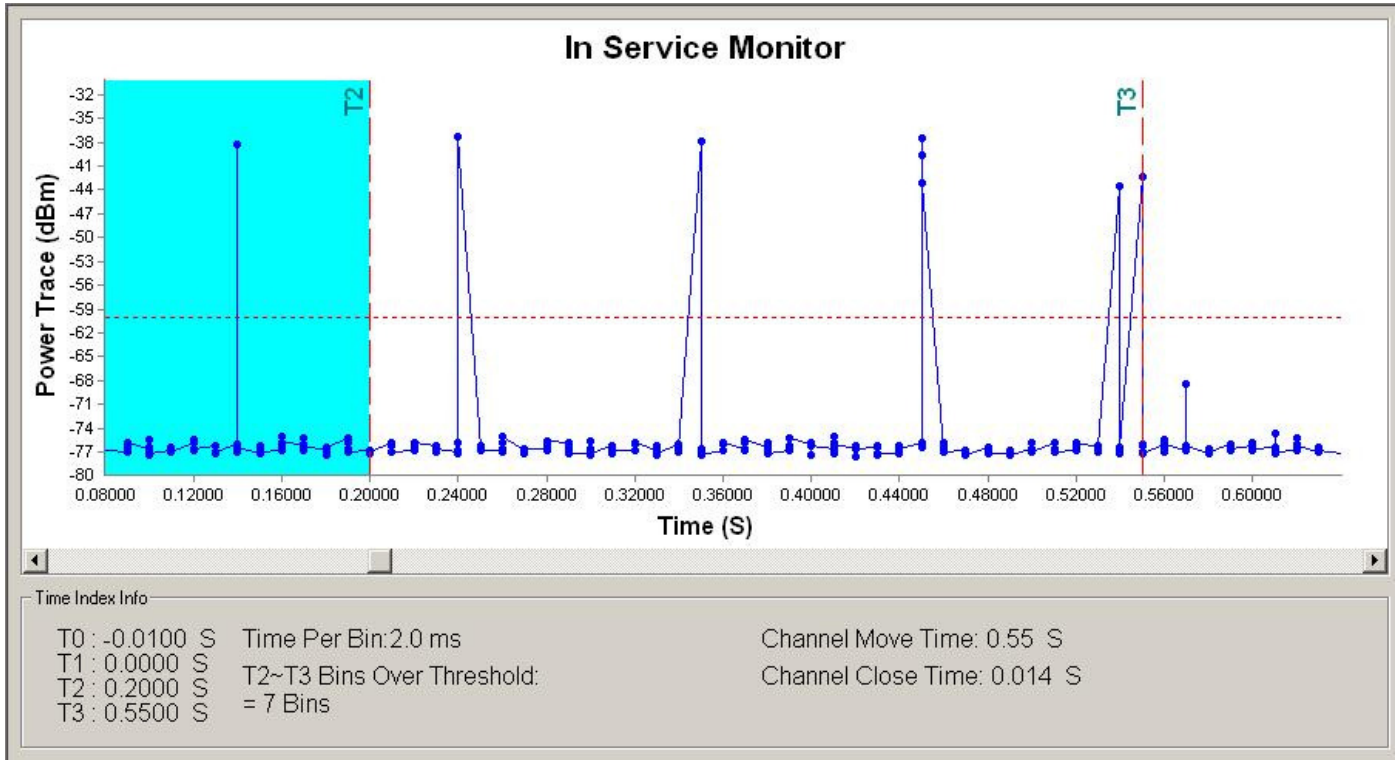

Verdict:

Time per bin: 2.0ms, Total Bins after 200ms: 7Bins, Total time intermittent control remains: 14.0ms.
14.0ms < 60ms in the period of 10s.

Unless otherwise stated the results shown in this test report refer only to the sample(s) tested and such sample(s) are retained for 90 days only.

除非另有說明，此報告結果僅對測試之樣品負責，同時此樣品僅保留90天。本報告未經本公司書面許可，不可部份複製。

This document is issued by the Company subject to its General Conditions of Service printed overleaf, available on request or accessible at www.sgs.com/terms_and_conditions.htm and, for electronic format documents, subject to Terms and Conditions for Electronic Documents at www.sgs.com/terms_e-document.htm. Attention is drawn to the limitation of liability, indemnification and jurisdiction issues defined therein. Any holder of this document is advised that information contained hereon reflects the Company's findings at the time of its intervention only and within the limits of Client's instructions, if any. The Company's sole responsibility is to its Client and this document does not exonerate parties to a transaction from exercising all their rights and obligations under the transaction documents. This document cannot be reproduced except in full, without prior written approval of the Company. Any unauthorized alteration, forgery or falsification of the content or appearance of this document is unlawful and offenders may be prosecuted to the fullest extent of the law.

SGS Taiwan Ltd.

No. 134, WuKungRoad, NewTaipeiIndustrialPark, WukuDistrict, NewTaipeiCity, Taiwan24803/新北市五股區新北產業園區五工路 134 號

台灣檢驗科技股份有限公司

t (886-2) 2299-3279

f (886-2) 2298-0488

www.tw.sgs.com

Member of SGS Group

Radar Type 0 Channel Closing Transmission Time - 4

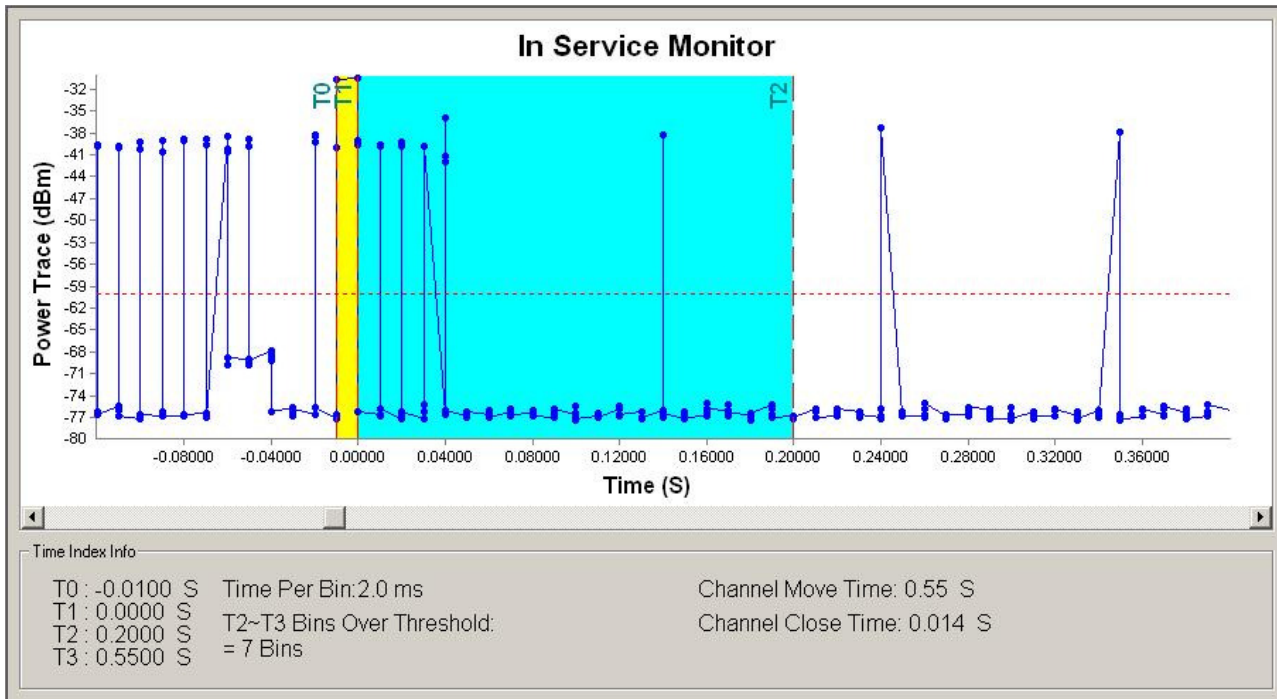

Verdict:

Note: narrowing the sweep time as the good engineering process for the verification of transmission closing in 200ms

Unless otherwise stated the results shown in this test report refer only to the sample(s) tested and such sample(s) are retained for 90 days only.

除非另有說明，此報告結果僅對測試之樣品負責，同時此樣品僅保留90天。本報告未經本公司書面許可，不可部份複製。

This document is issued by the Company subject to its General Conditions of Service printed overleaf, available on request or accessible at www.sgs.com/terms_and_conditions.htm and, for electronic format documents, subject to Terms and Conditions for Electronic Documents at www.sgs.com/terms_e-document.htm. Attention is drawn to the limitation of liability, indemnification and jurisdiction issues defined therein. Any holder of this document is advised that information contained hereon reflects the Company's findings at the time of its intervention only and within the limits of Client's instructions, if any. The Company's sole responsibility is to its Client and this document does not exonerate parties to a transaction from exercising all their rights and obligations under the transaction documents. This document cannot be reproduced except in full, without prior written approval of the Company. Any unauthorized alteration, forgery or falsification of the content or appearance of this document is unlawful and offenders may be prosecuted to the fullest extent of the law.

SGS Taiwan Ltd.

No. 134, WuKungRoad, NewTaipeiIndustrialPark, WukuDistrict, NewTaipeiCity, Taiwan24803/新北市五股區新北產業園區五工路 134 號

台灣檢驗科技股份有限公司

t (886-2) 2299-3279

f (886-2) 2298-0488

www.tw.sgs.com

Member of SGS Group

Non-occupancy Period (without radar detection)

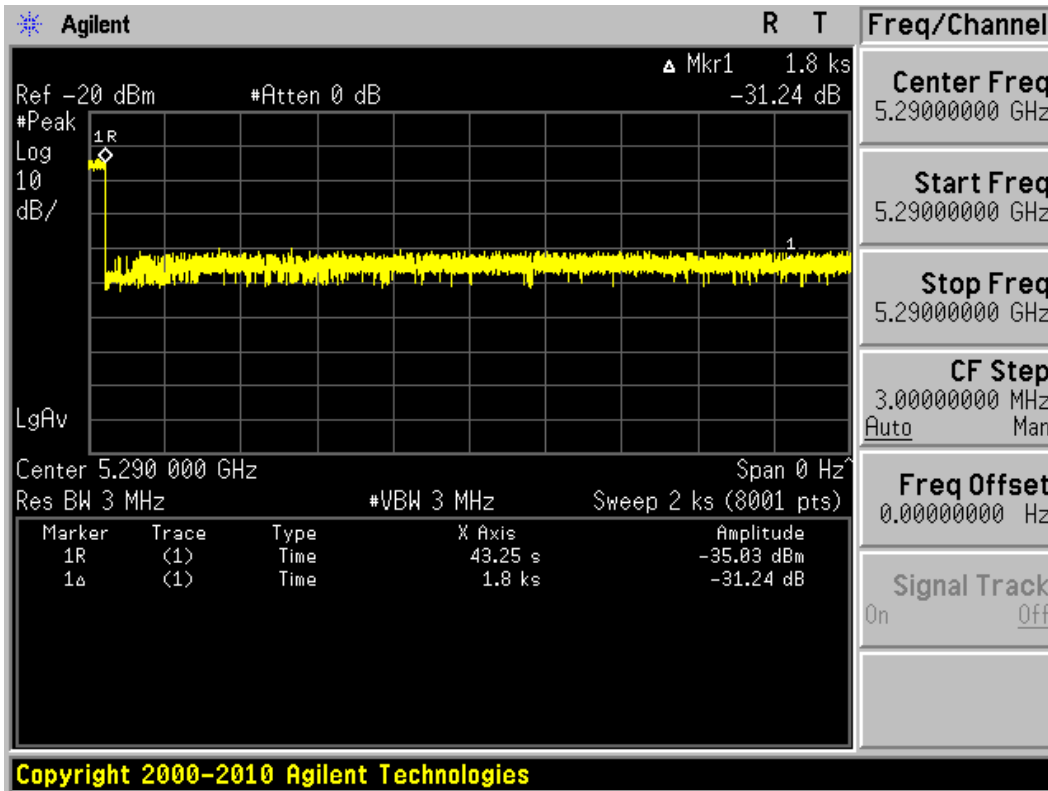

Verdict:

To verify whether channel is unavailable to be operated in 30 minutes.

$$1.8ks = 1800s = 1800 \text{ s/min} / 60 = 30\text{minute}$$

Unless otherwise stated the results shown in this test report refer only to the sample(s) tested and such sample(s) are retained for 90 days only.

除非另有說明，此報告結果僅對測試之樣品負責，同時此樣品僅保留90天。本報告未經本公司書面許可，不可部份複製。

This document is issued by the Company subject to its General Conditions of Service printed overleaf, available on request or accessible at www.sgs.com/terms_and_conditions.htm and, for electronic format documents, subject to Terms and Conditions for Electronic Documents at www.sgs.com/terms_e-document.htm. Attention is drawn to the limitation of liability, indemnification and jurisdiction issues defined therein. Any holder of this document is advised that information contained hereon reflects the Company's findings at the time of its intervention only and within the limits of Client's instructions, if any. The Company's sole responsibility is to its Client and this document does not exonerate parties to a transaction from exercising all their rights and obligations under the transaction documents. This document cannot be reproduced except in full, without prior written approval of the Company. Any unauthorized alteration, forgery or falsification of the content or appearance of this document is unlawful and offenders may be prosecuted to the fullest extent of the law.

UNII Detection Bandwidth

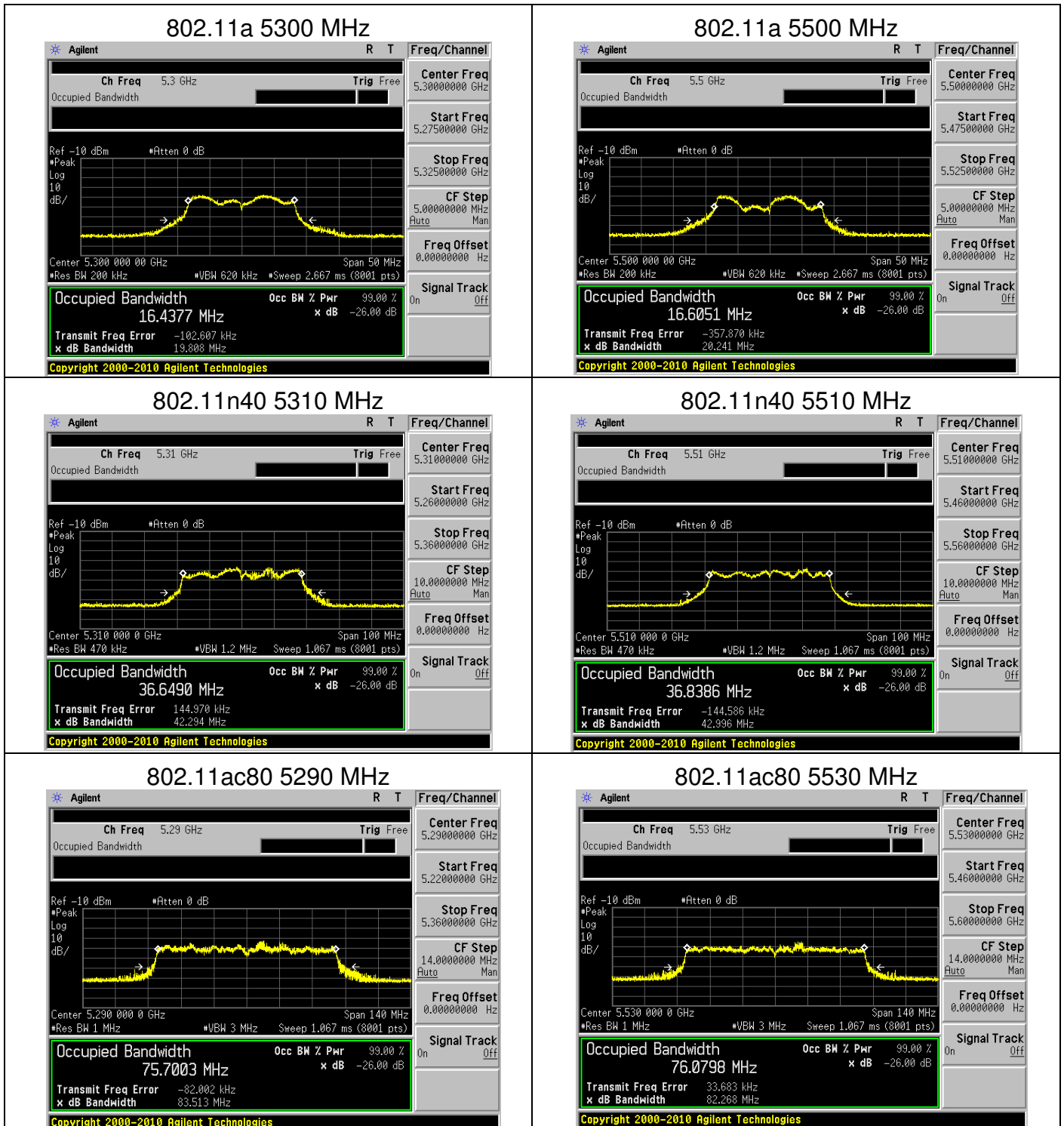

Unless otherwise stated the results shown in this test report refer only to the sample(s) tested and such sample(s) are retained for 90 days only.

除非另有說明，此報告結果僅對測試之樣品負責，同時此樣品僅保留90天。本報告未經本公司書面許可，不可部份複製。

This document is issued by the Company subject to its General Conditions of Service printed overleaf, available on request or accessible at www.sgs.com/terms_and_conditions.htm and, for electronic format documents, subject to Terms and Conditions for Electronic Documents at www.sgs.com/terms_e-document.htm. Attention is drawn to the limitation of liability, indemnification and jurisdiction issues defined therein. Any holder of this document is advised that information contained hereon reflects the Company's findings at the time of its intervention only and within the limits of Client's instructions, if any. The Company's sole responsibility is to its Client and this document does not exonerate parties to a transaction from exercising all their rights and obligations under the transaction documents. This document cannot be reproduced except in full, without prior written approval of the Company. Any unauthorized alteration, forgery or falsification of the content or appearance of this document is unlawful and offenders may be prosecuted to the fullest extent of the law.

SGS Taiwan Ltd.

No. 134, WuKung Road, New Taipei Industrial Park, Wuku District, New Taipei City, Taiwan 24803 / 新北市五股區新北產業園區五工路 134 號

台灣檢驗科技股份有限公司

t (886-2) 2299-3279

f (886-2) 2298-0488

www.tw.sgs.com

Member of SGS Group

Channel Bandwidth 20MHz 5300MHz

U-NII Detection Bandwidth												
802.11a_CH100_5300 MHz											Radar type 0	
DFS Detection Trials (1=Detection, 0= No Detection)												
Radio Frequency (MHz)	1	2	3	4	5	6	7	8	9	10	Detection Rate (%)	Mark
5290	1	1	1	1	1	1	1	1	1	1	100%	FL
5295	1	1	1	1	1	1	1	1	1	1	100%	
5300	1	1	1	1	1	1	1	1	1	1	100%	
5305	1	1	1	1	1	1	1	1	1	1	100%	
5310	1	1	1	1	1	1	1	1	1	1	100%	FH
Detection Bandwidth = FH-FL = 5310-5290=20MHz												
EUT 99% Bandwidth = 16.4377 MHz												

Channel Bandwidth 20MHz 5500MHz

U-NII Detection Bandwidth												
802.11a_CH100_5500 MHz											Radar type 0	
DFS Detection Trials (1=Detection, 0= No Detection)												
Radio Frequency (MHz)	1	2	3	4	5	6	7	8	9	10	Detection Rate (%)	Mark
5490	1	1	1	1	1	1	1	1	1	1	100%	FL
5495	1	1	1	1	1	1	1	1	1	1	100%	
5500	1	1	1	1	1	1	1	1	1	1	100%	
5505	1	1	1	1	1	1	1	1	1	1	100%	
5510	1	1	1	1	1	1	1	1	1	1	100%	FH
Detection Bandwidth = FH-FL = 5510-5490=20MHz												
EUT 99% Bandwidth = 16.6051 MHz												

Unless otherwise stated the results shown in this test report refer only to the sample(s) tested and such sample(s) are retained for 90 days only.

除非另有說明，此報告結果僅對測試之樣品負責，同時此樣品僅保留90天。本報告未經本公司書面許可，不可部份複製。

This document is issued by the Company subject to its General Conditions of Service printed overleaf, available on request or accessible at www.sgs.com/terms_and_conditions.htm and, for electronic format documents, subject to Terms and Conditions for Electronic Documents at www.sgs.com/terms_e-document.htm. Attention is drawn to the limitation of liability, indemnification and jurisdiction issues defined therein. Any holder of this document is advised that information contained hereon reflects the Company's findings at the time of its intervention only and within the limits of Client's instructions, if any. The Company's sole responsibility is to its Client and this document does not exonerate parties to a transaction from exercising all their rights and obligations under the transaction documents. This document cannot be reproduced except in full, without prior written approval of the Company. Any unauthorized alteration, forgery or falsification of the content or appearance of this document is unlawful and offenders may be prosecuted to the fullest extent of the law.

SGS Taiwan Ltd.

No.134,WuKungRoad,NewTaipeiIndustrialPark,WukuDistrict,NewTaipeiCity,Taiwan24803/新北市五股區新北產業園區五工路 134 號

台灣檢驗科技股份有限公司

t (886-2) 2299-3279

f (886-2) 2298-0488

www.tw.sgs.com

Member of SGS Group

Channel Bandwidth 40MHz 5310MHz

U-NII Detection Bandwidth												
802.11n HT40_CH62_5310 MHz										Radar type 0		
DFS Detection Trials (1=Detection, 0= No Detection)												
Radio Frequency (MHz)	1	2	3	4	5	6	7	8	9	10	Detection Rate (%)	Mark
5290	0	0	0	1	0	0	0	0	0	0	10%	
5291	1	1	1	1	1	1	1	1	1	1	100%	FL
5295	1	1	1	1	1	1	1	1	1	1	100%	
5300	1	1	1	1	1	1	1	1	1	1	100%	
5305	1	1	1	1	1	1	1	1	1	1	100%	
5310	1	1	1	1	1	1	1	1	1	1	100%	
5315	1	1	1	1	1	1	1	1	1	1	100%	
5320	1	1	1	1	1	1	1	1	1	1	100%	
5325	1	1	1	1	1	1	1	1	1	1	100%	
5329	1	1	1	1	1	1	1	1	1	1	100%	FH
5330	0	0	0	0	0	0	0	0	0	0	0%	
Detection Bandwidth = FH-FL = 5329-5291= 38MHz												
EUT 99% Bandwidth = 36.6490 MHz												

Unless otherwise stated the results shown in this test report refer only to the sample(s) tested and such sample(s) are retained for 90 days only.

除非另有說明，此報告結果僅對測試之樣品負責，同時此樣品僅保留90天。本報告未經本公司書面許可，不可部份複製。

This document is issued by the Company subject to its General Conditions of Service printed overleaf, available on request or accessible at www.sgs.com/terms_and_conditions.htm and, for electronic format documents, subject to Terms and Conditions for Electronic Documents at www.sgs.com/terms_e-document.htm. Attention is drawn to the limitation of liability, indemnification and jurisdiction issues defined therein. Any holder of this document is advised that information contained hereon reflects the Company's findings at the time of its intervention only and within the limits of Client's instructions, if any. The Company's sole responsibility is to its Client and this document does not exonerate parties to a transaction from exercising all their rights and obligations under the transaction documents. This document cannot be reproduced except in full, without prior written approval of the Company. Any unauthorized alteration, forgery or falsification of the content or appearance of this document is unlawful and offenders may be prosecuted to the fullest extent of the law.

SGS Taiwan Ltd.

No.134,WuKungRoad,NewTaipeiIndustrialPark,WukuDistrict,NewTaipeiCity,Taiwan24803/新北市五股區新北產業園區五工路 134 號

台灣檢驗科技股份有限公司

t (886-2) 2299-3279

f (886-2) 2298-0488

www.tw.sgs.com

Member of SGS Group

Channel Bandwidth 40MHz 5510MHz

U-NII Detection Bandwidth												
802.11n HT40_CH102_5510 MHz											Radar type 0	
DFS Detection Trials (1=Detection, 0= No Detection)												
Radio Frequency (MHz)	1	2	3	4	5	6	7	8	9	10	Detection Rate (%)	Mark
5490	0	0	0	0	0	0	0	0	0	0	0%	
5491	1	1	1	1	1	1	1	1	1	1	100%	FL
5495	1	1	1	1	1	1	1	1	1	1	100%	
5500	1	1	1	1	1	1	1	1	1	1	100%	
5505	1	1	1	1	1	1	1	1	1	1	100%	
5510	1	1	1	1	1	1	1	1	1	1	100%	
5515	1	1	1	1	1	1	1	1	1	1	100%	
5520	1	1	1	1	1	1	1	1	1	1	100%	
5525	1	1	1	1	1	1	1	1	1	1	100%	
5529	1	1	1	1	1	1	1	1	1	1	100%	FH
5530	0	0	0	0	0	0	0	0	0	0	0%	
Detection Bandwidth = FH-FL = 5529-5491= 38MHz												
EUT 99% Bandwidth = 36.8386 MHz												

Unless otherwise stated the results shown in this test report refer only to the sample(s) tested and such sample(s) are retained for 90 days only.

除非另有說明，此報告結果僅對測試之樣品負責，同時此樣品僅保留90天。本報告未經本公司書面許可，不可部份複製。

This document is issued by the Company subject to its General Conditions of Service printed overleaf, available on request or accessible at www.sgs.com/terms_and_conditions.htm and, for electronic format documents, subject to Terms and Conditions for Electronic Documents at www.sgs.com/terms_e-document.htm. Attention is drawn to the limitation of liability, indemnification and jurisdiction issues defined therein. Any holder of this document is advised that information contained hereon reflects the Company's findings at the time of its intervention only and within the limits of Client's instructions, if any. The Company's sole responsibility is to its Client and this document does not exonerate parties to a transaction from exercising all their rights and obligations under the transaction documents. This document cannot be reproduced except in full, without prior written approval of the Company. Any unauthorized alteration, forgery or falsification of the content or appearance of this document is unlawful and offenders may be prosecuted to the fullest extent of the law.

SGS Taiwan Ltd.

No.134,WuKungRoad,NewTaipeiIndustrialPark,WukuDistrict,NewTaipeiCity,Taiwan24803/新北市五股區新北產業園區五工路 134 號

台灣檢驗科技股份有限公司

t (886-2) 2299-3279

f (886-2) 2298-0488

www.tw.sgs.com

Member of SGS Group

Channel Bandwidth 80MHz 5290MHz

U-NII Detection Bandwidth												
802.11ac VHT80_CH58_5290 MHz											Radar type 0	
DFS Detection Trials (1=Detection, 0= No Detection)												
Radio Frequency (MHz)	1	2	3	4	5	6	7	8	9	10	Detection Rate (%)	Mark
5250	1	1	1	1	1	1	1	1	1	1	100%	FL
5255	1	1	1	1	1	1	1	1	1	1	100%	
5260	1	1	1	1	1	1	1	1	1	1	100%	
5265	1	1	1	1	1	1	1	1	1	1	100%	
5270	1	1	1	1	1	1	1	1	1	1	100%	
5275	1	1	1	1	1	1	1	1	1	1	100%	
5280	1	1	1	1	1	1	1	1	1	1	100%	
5285	1	1	1	1	1	1	1	1	1	1	100%	
5290	1	1	1	1	1	1	1	1	1	1	100%	
5295	1	1	1	1	1	1	1	1	1	1	100%	
5300	1	1	1	1	1	1	1	1	1	1	100%	
5305	1	1	1	1	1	1	1	1	1	1	100%	
5310	1	1	1	1	1	1	1	1	1	1	100%	
5315	1	1	1	1	1	1	1	1	1	1	100%	
5320	1	1	1	1	1	1	1	1	1	1	100%	
5325	1	1	1	1	1	1	1	1	1	1	100%	
5330	1	1	1	1	1	1	1	1	1	1	100%	FH
Detection Bandwidth = FH-FL = 5330-5250= 80MHz												
EUT 99% Bandwidth = 75.7003 MHz												

Unless otherwise stated the results shown in this test report refer only to the sample(s) tested and such sample(s) are retained for 90 days only.

除非另有說明，此報告結果僅對測試之樣品負責，同時此樣品僅保留90天。本報告未經本公司書面許可，不可部份複製。

This document is issued by the Company subject to its General Conditions of Service printed overleaf, available on request or accessible at www.sgs.com/terms_and_conditions.htm and, for electronic format documents, subject to Terms and Conditions for Electronic Documents at www.sgs.com/terms_e-document.htm. Attention is drawn to the limitation of liability, indemnification and jurisdiction issues defined therein. Any holder of this document is advised that information contained hereon reflects the Company's findings at the time of its intervention only and within the limits of Client's instructions, if any. The Company's sole responsibility is to its Client and this document does not exonerate parties to a transaction from exercising all their rights and obligations under the transaction documents. This document cannot be reproduced except in full, without prior written approval of the Company. Any unauthorized alteration, forgery or falsification of the content or appearance of this document is unlawful and offenders may be prosecuted to the fullest extent of the law.

SGS Taiwan Ltd.

No.134,WuKungRoad,NewTaipeiIndustrialPark,WukuDistrict,NewTaipeiCity,Taiwan24803/新北市五股區新北產業園區五工路 134 號

台灣檢驗科技股份有限公司

t (886-2) 2299-3279

f (886-2) 2298-0488

www.tw.sgs.com

Member of SGS Group

Channel Bandwidth 80MHz 5530MHz

U-NII Detection Bandwidth												
802.11ac VHT80_CH106_5530 MHz											Radar type 0	
DFS Detection Trials (1=Detection, 0= No Detection)												
Radio Frequency (MHz)	1	2	3	4	5	6	7	8	9	10	Detection Rate (%)	Mark
5490	1	1	1	1	1	1	1	1	1	1	100%	FL
5495	1	1	1	1	1	1	1	1	1	1	100%	
5500	1	1	1	1	1	1	1	1	1	1	100%	
5505	1	1	1	1	1	1	1	1	1	1	100%	
5510	1	1	1	1	1	1	1	1	1	1	100%	
5515	1	1	1	1	1	1	1	1	1	1	100%	
5520	1	1	1	1	1	1	1	1	1	1	100%	
5525	1	1	1	1	1	1	1	1	1	1	100%	
5530	1	1	1	1	1	1	1	1	1	1	100%	
5535	1	1	1	1	1	1	1	1	1	1	100%	
5540	1	1	1	1	1	1	1	1	1	1	100%	
5545	1	1	1	1	1	1	1	1	1	1	100%	
5550	1	1	1	1	1	1	1	1	1	1	100%	
5555	1	1	1	1	1	1	1	1	1	1	100%	
5560	1	1	1	1	1	1	1	1	1	1	100%	
5565	1	1	1	1	1	1	1	1	1	1	100%	
5570	1	1	1	1	1	1	1	1	1	1	100%	FH
Detection Bandwidth = FH-FL = 5570-5490= 80MHz												
EUT 99% Bandwidth = 76.0798 MHz												

Unless otherwise stated the results shown in this test report refer only to the sample(s) tested and such sample(s) are retained for 90 days only.

除非另有說明，此報告結果僅對測試之樣品負責，同時此樣品僅保留90天。本報告未經本公司書面許可，不可部份複製。

This document is issued by the Company subject to its General Conditions of Service printed overleaf, available on request or accessible at www.sgs.com/terms_and_conditions.htm and, for electronic format documents, subject to Terms and Conditions for Electronic Documents at www.sgs.com/terms_e-document.htm. Attention is drawn to the limitation of liability, indemnification and jurisdiction issues defined therein. Any holder of this document is advised that information contained hereon reflects the Company's findings at the time of its intervention only and within the limits of Client's instructions, if any. The Company's sole responsibility is to its Client and this document does not exonerate parties to a transaction from exercising all their rights and obligations under the transaction documents. This document cannot be reproduced except in full, without prior written approval of the Company. Any unauthorized alteration, forgery or falsification of the content or appearance of this document is unlawful and offenders may be prosecuted to the fullest extent of the law.

SGS Taiwan Ltd.

No.134,WuKungRoad,NewTaipeiIndustrialPark,WukuDistrict,NewTaipeiCity,Taiwan24803/新北市五股區新北產業園區五工路 134 號

台灣檢驗科技股份有限公司

t (886-2) 2299-3279

f (886-2) 2298-0488

www.tw.sgs.com

Member of SGS Group

Channel Availability Check (CAC)

The time of channel availability check (60s)

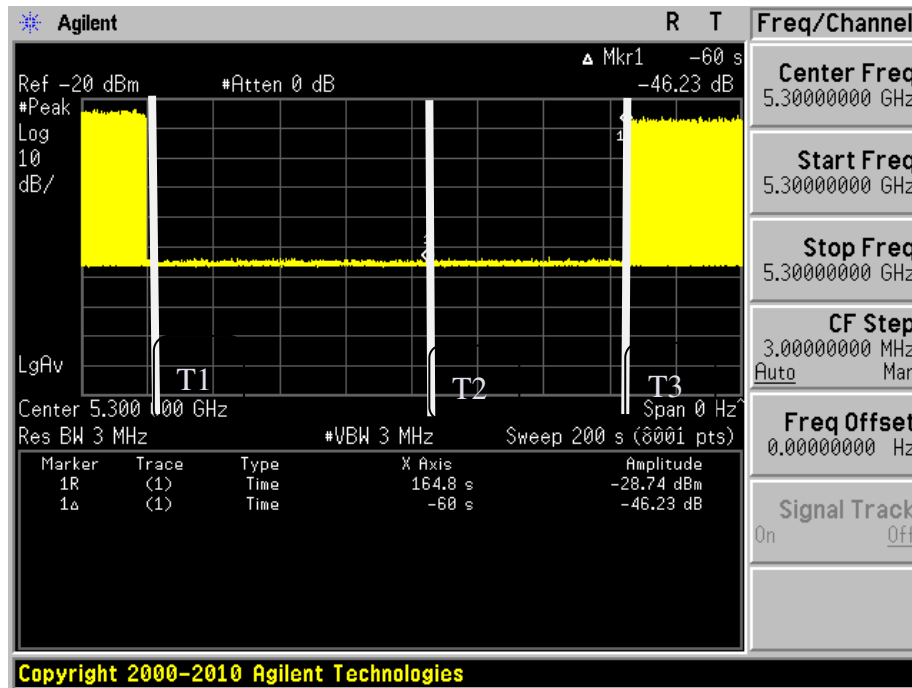

Where T1~T2 indicates the time to power up, where T2~T3 represents the channel availability time.

Radar type 0 for 802.11a:

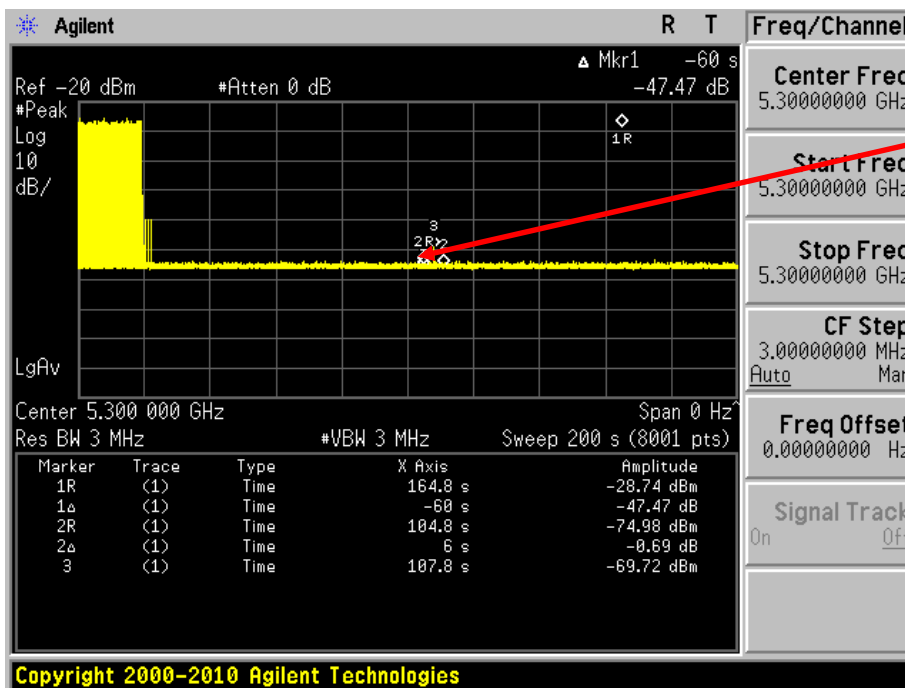

Radar signal

Unless otherwise stated the results shown in this test report refer only to the sample(s) tested and such sample(s) are retained for 90 days only.

除非另有說明，此報告結果僅對測試之樣品負責，同時此樣品僅保留90天。本報告未經本公司書面許可，不可部份複製。

This document is issued by the Company subject to its General Conditions of Service printed overleaf, available on request or accessible at www.sgs.com/terms_and_conditions.htm and, for electronic format documents, subject to Terms and Conditions for Electronic Documents at www.sgs.com/terms_e-document.htm. Attention is drawn to the limitation of liability, indemnification and jurisdiction issues defined therein. Any holder of this document is advised that information contained hereon reflects the Company's findings at the time of its intervention only and within the limits of Client's instructions, if any. The Company's sole responsibility is to its Client and this document does not exonerate parties to a transaction from exercising all their rights and obligations under the transaction documents. This document cannot be reproduced except in full, without prior written approval of the Company. Any unauthorized alteration, forgery or falsification of the content or appearance of this document is unlawful and offenders may be prosecuted to the fullest extent of the law.

Radar type 0 for 802.11a:

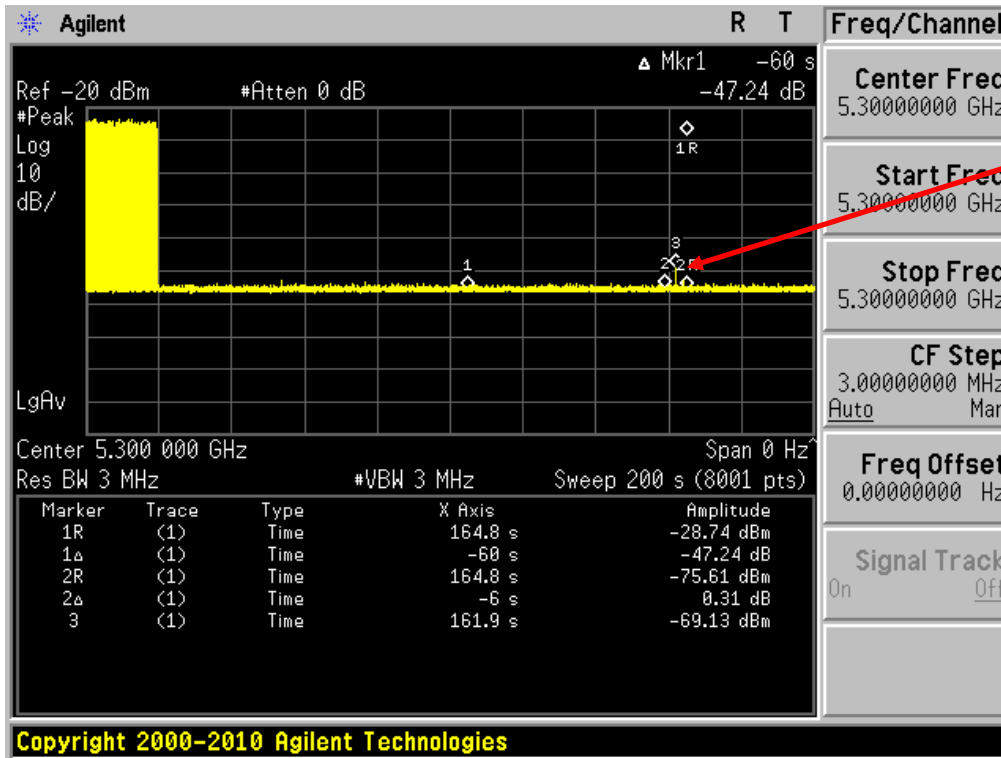

Radar type 1 for 802.11a:

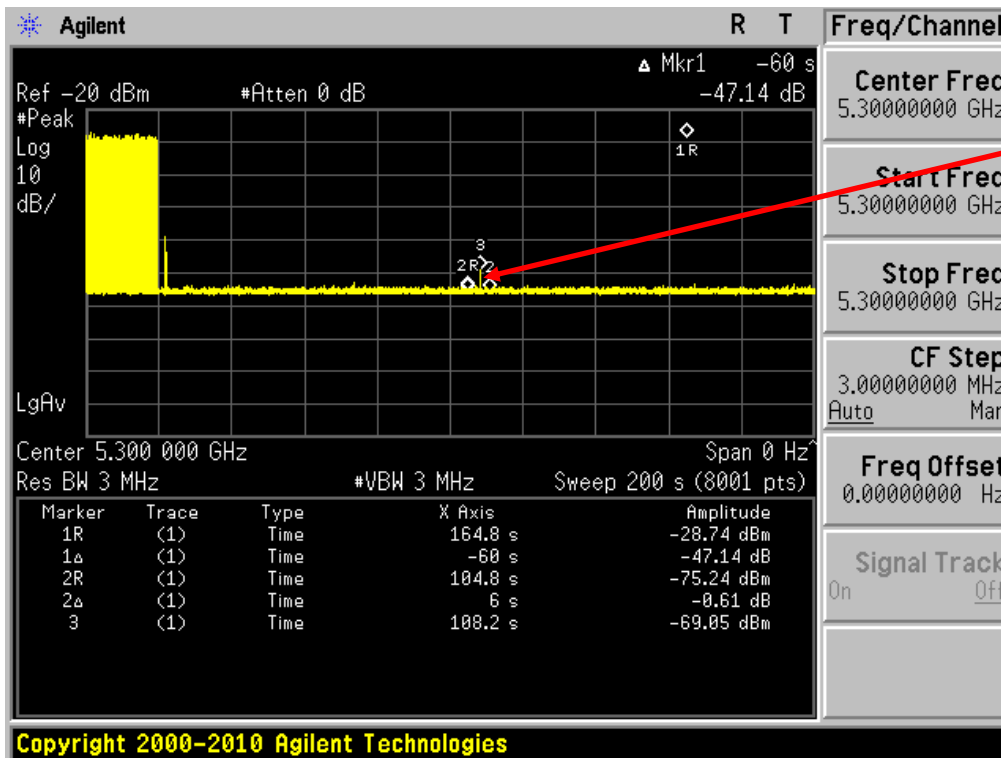

Unless otherwise stated the results shown in this test report refer only to the sample(s) tested and such sample(s) are retained for 90 days only.

除非另有說明，此報告結果僅對測試之樣品負責，同時此樣品僅保留90天。本報告未經本公司書面許可，不可部份複製。

This document is issued by the Company subject to its General Conditions of Service printed overleaf, available on request or accessible at www.sgs.com/terms_and_conditions.htm and, for electronic format documents, subject to Terms and Conditions for Electronic Documents at www.sgs.com/terms_e-document.htm. Attention is drawn to the limitation of liability, indemnification and jurisdiction issues defined therein. Any holder of this document is advised that information contained hereon reflects the Company's findings at the time of its intervention only and within the limits of Client's instructions, if any. The Company's sole responsibility is to its Client and this document does not exonerate parties to a transaction from exercising all their rights and obligations under the transaction documents. This document cannot be reproduced except in full, without prior written approval of the Company. Any unauthorized alteration, forgery or falsification of the content or appearance of this document is unlawful and offenders may be prosecuted to the fullest extent of the law.

Radar type 1 for 802.11a:

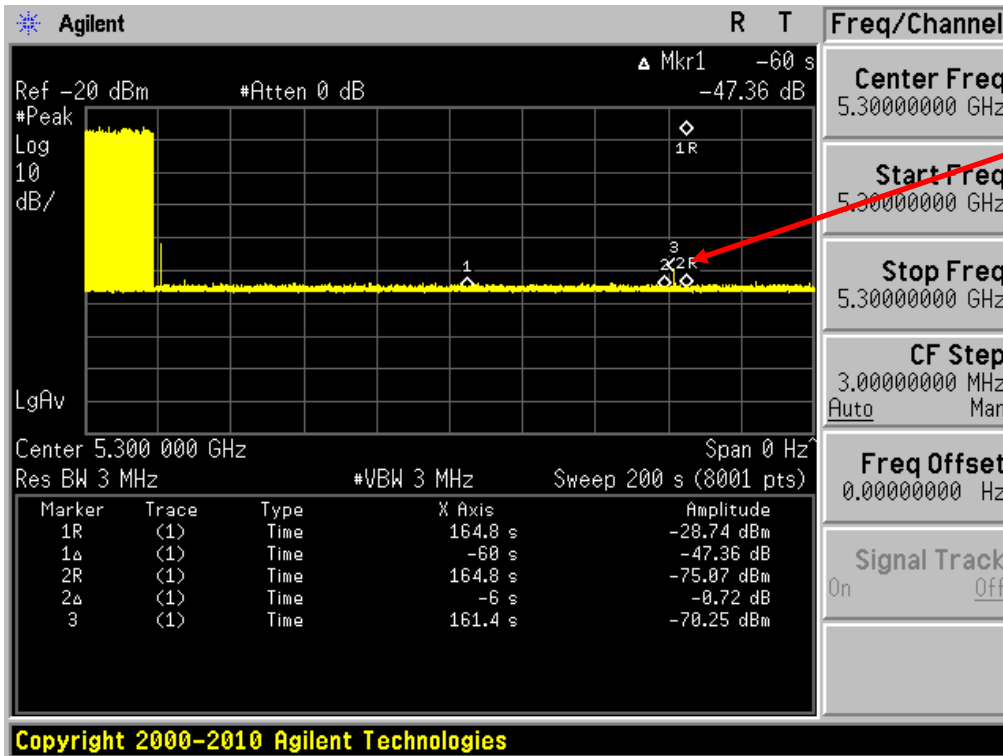

Radar signal

Radar type 2 for 802.11a:

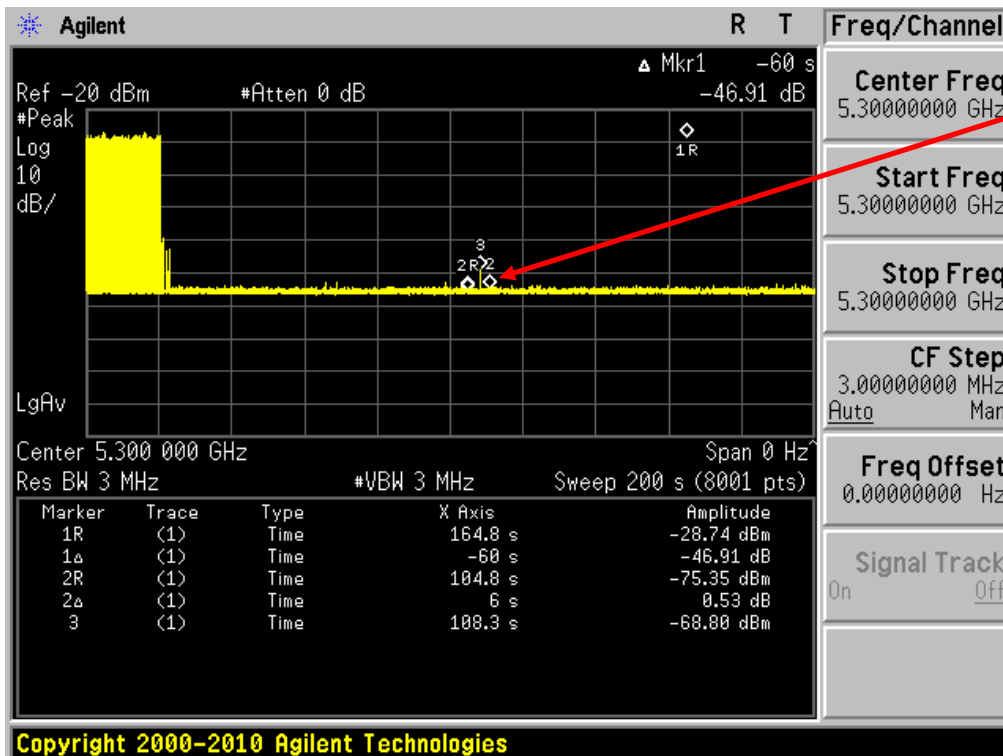

Radar signal

Unless otherwise stated the results shown in this test report refer only to the sample(s) tested and such sample(s) are retained for 90 days only.

除非另有說明，此報告結果僅對測試之樣品負責，同時此樣品僅保留90天。本報告未經本公司書面許可，不可部份複製。

This document is issued by the Company subject to its General Conditions of Service printed overleaf, available on request or accessible at www.sgs.com/terms_and_conditions.htm and, for electronic format documents, subject to Terms and Conditions for Electronic Documents at www.sgs.com/terms_e-document.htm. Attention is drawn to the limitation of liability, indemnification and jurisdiction issues defined therein. Any holder of this document is advised that information contained hereon reflects the Company's findings at the time of its intervention only and within the limits of Client's instructions, if any. The Company's sole responsibility is to its Client and this document does not exonerate parties to a transaction from exercising all their rights and obligations under the transaction documents. This document cannot be reproduced except in full, without prior written approval of the Company. Any unauthorized alteration, forgery or falsification of the content or appearance of this document is unlawful and offenders may be prosecuted to the fullest extent of the law.

Radar type 2 for 802.11a:

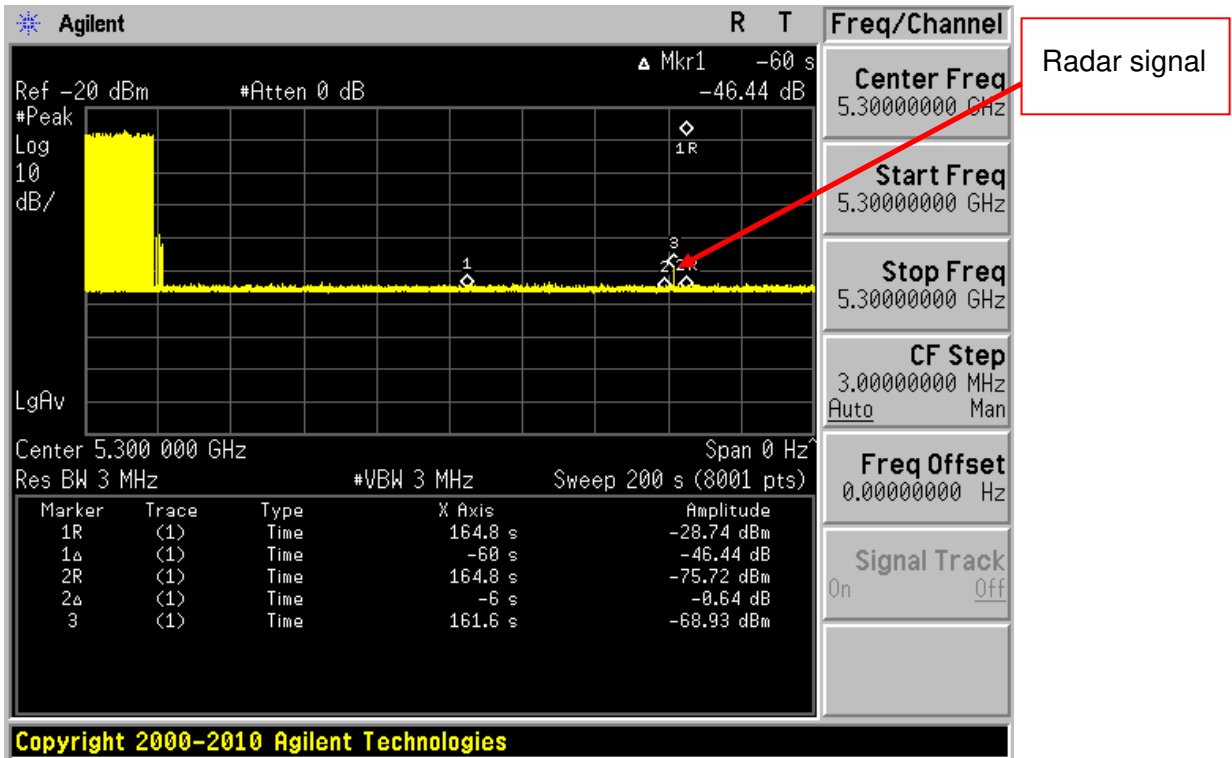

Radar type 3 for 802.11a:

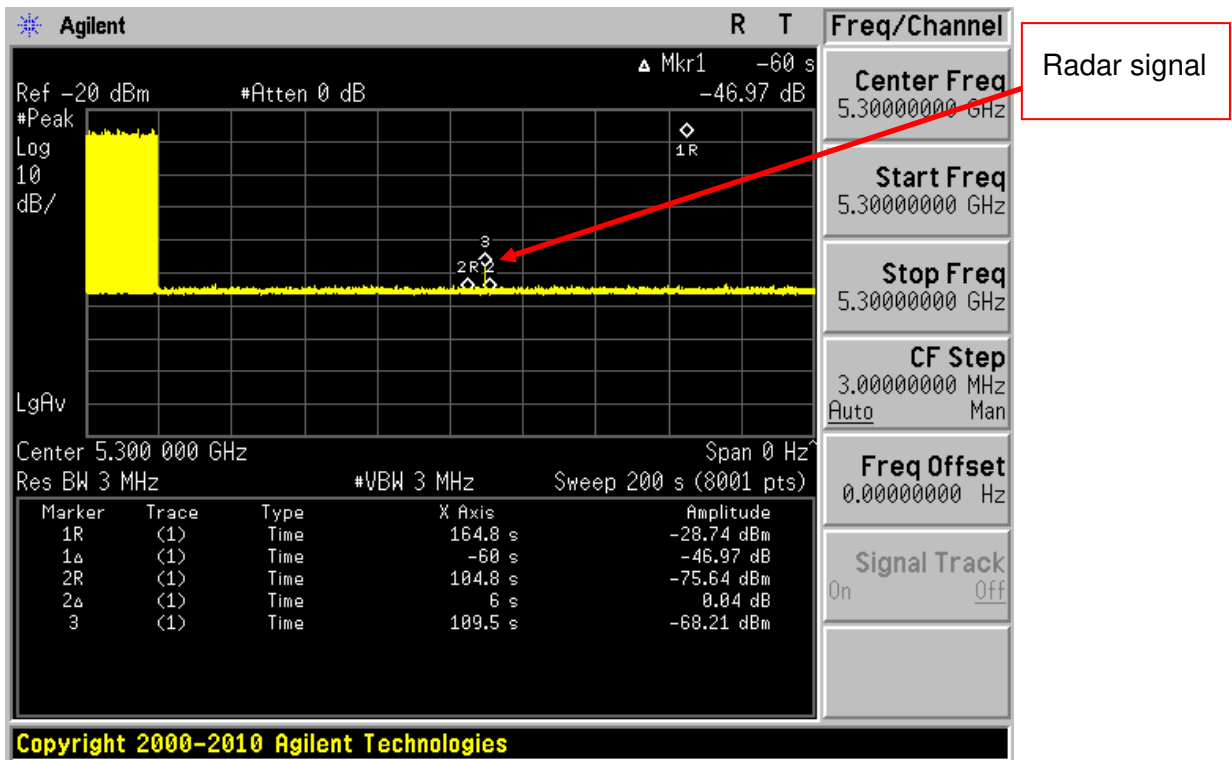

Unless otherwise stated the results shown in this test report refer only to the sample(s) tested and such sample(s) are retained for 90 days only.

除非另有說明，此報告結果僅對測試之樣品負責，同時此樣品僅保留90天。本報告未經本公司書面許可，不可部份複製。

This document is issued by the Company subject to its General Conditions of Service printed overleaf, available on request or accessible at www.sgs.com/terms_and_conditions.htm and, for electronic format documents, subject to Terms and Conditions for Electronic Documents at www.sgs.com/terms_e-document.htm. Attention is drawn to the limitation of liability, indemnification and jurisdiction issues defined therein. Any holder of this document is advised that information contained hereon reflects the Company's findings at the time of its intervention only and within the limits of Client's instructions, if any. The Company's sole responsibility is to its Client and this document does not exonerate parties to a transaction from exercising all their rights and obligations under the transaction documents. This document cannot be reproduced except in full, without prior written approval of the Company. Any unauthorized alteration, forgery or falsification of the content or appearance of this document is unlawful and offenders may be prosecuted to the fullest extent of the law.

SGS Taiwan Ltd.

No.134,WuKungRoad,NewTaipeiIndustrialPark,WukuDistrict,NewTaipeiCity,Taiwan24803/新北市五股區新北產業園區五工路 134 號

台灣檢驗科技股份有限公司

t (886-2) 2299-3279

f (886-2) 2298-0488

www.tw.sgs.com

Member of SGS Group

Radar type 3 for 802.11a:

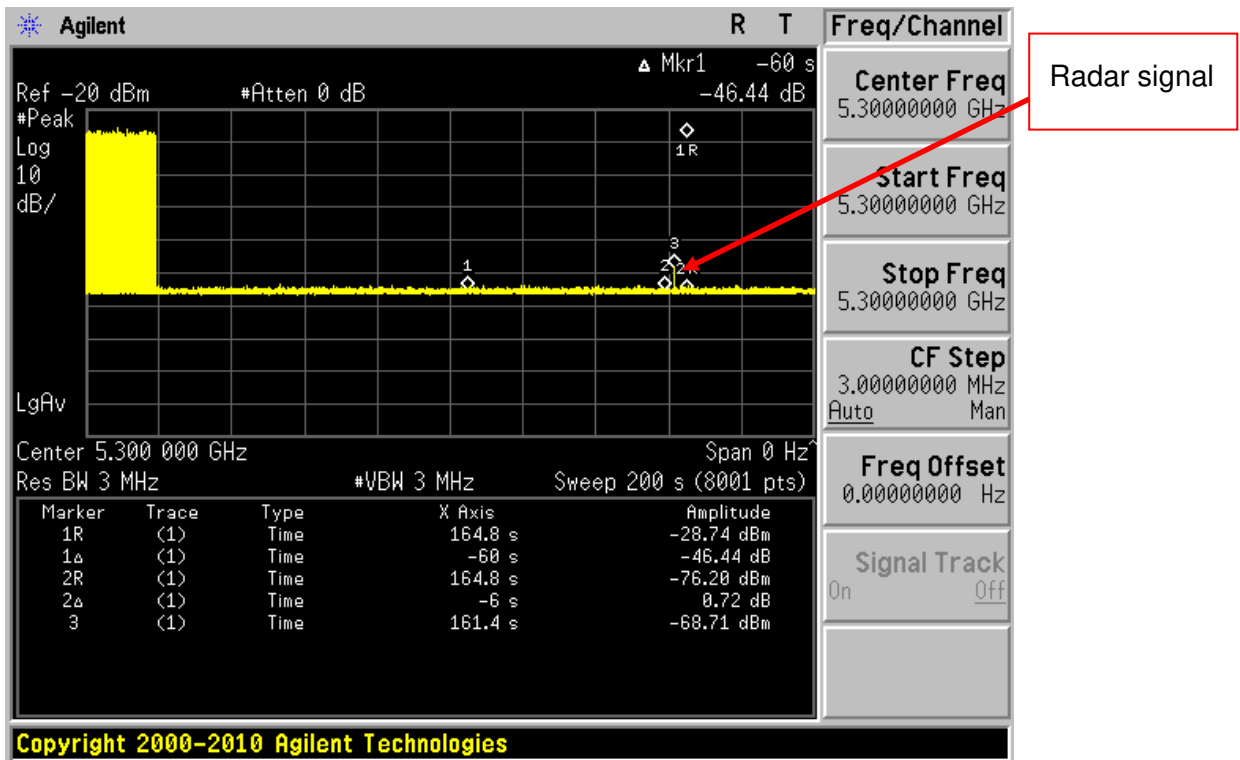

Radar type 4 for 802.11a:

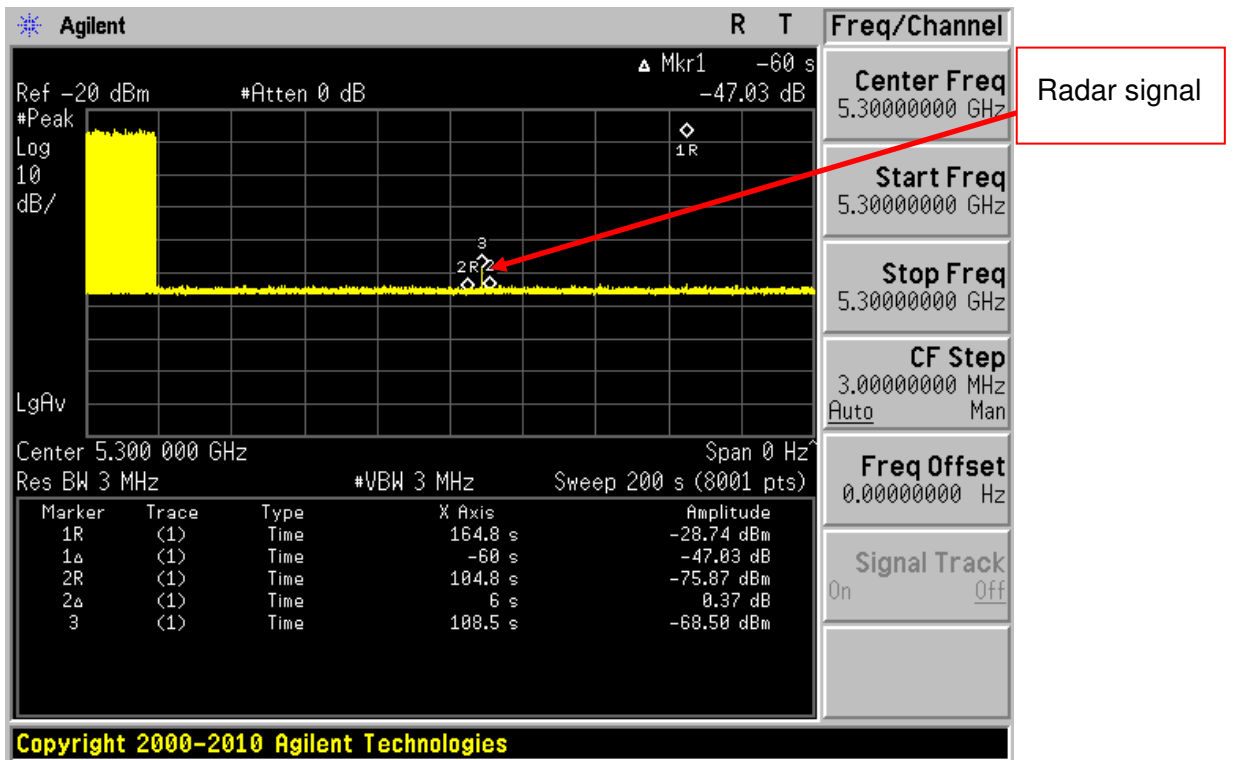

Unless otherwise stated the results shown in this test report refer only to the sample(s) tested and such sample(s) are retained for 90 days only.

除非另有說明，此報告結果僅對測試之樣品負責，同時此樣品僅保留90天。本報告未經本公司書面許可，不可部份複製。

This document is issued by the Company subject to its General Conditions of Service printed overleaf, available on request or accessible at www.sgs.com/terms_and_conditions.htm and, for electronic format documents, subject to Terms and Conditions for Electronic Documents at www.sgs.com/terms_e-document.htm. Attention is drawn to the limitation of liability, indemnification and jurisdiction issues defined therein. Any holder of this document is advised that information contained hereon reflects the Company's findings at the time of its intervention only and within the limits of Client's instructions, if any. The Company's sole responsibility is to its Client and this document does not exonerate parties to a transaction from exercising all their rights and obligations under the transaction documents. This document cannot be reproduced except in full, without prior written approval of the Company. Any unauthorized alteration, forgery or falsification of the content or appearance of this document is unlawful and offenders may be prosecuted to the fullest extent of the law.

Radar type 4 for 802.11a:

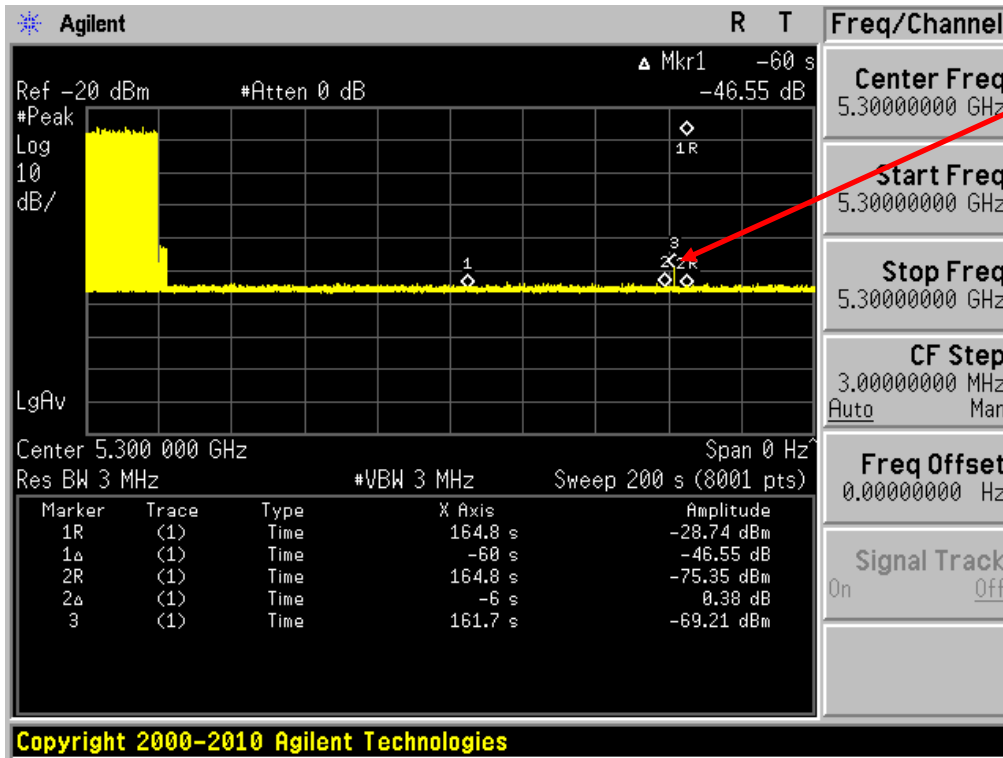

Radar type 0 for 802.11n40:

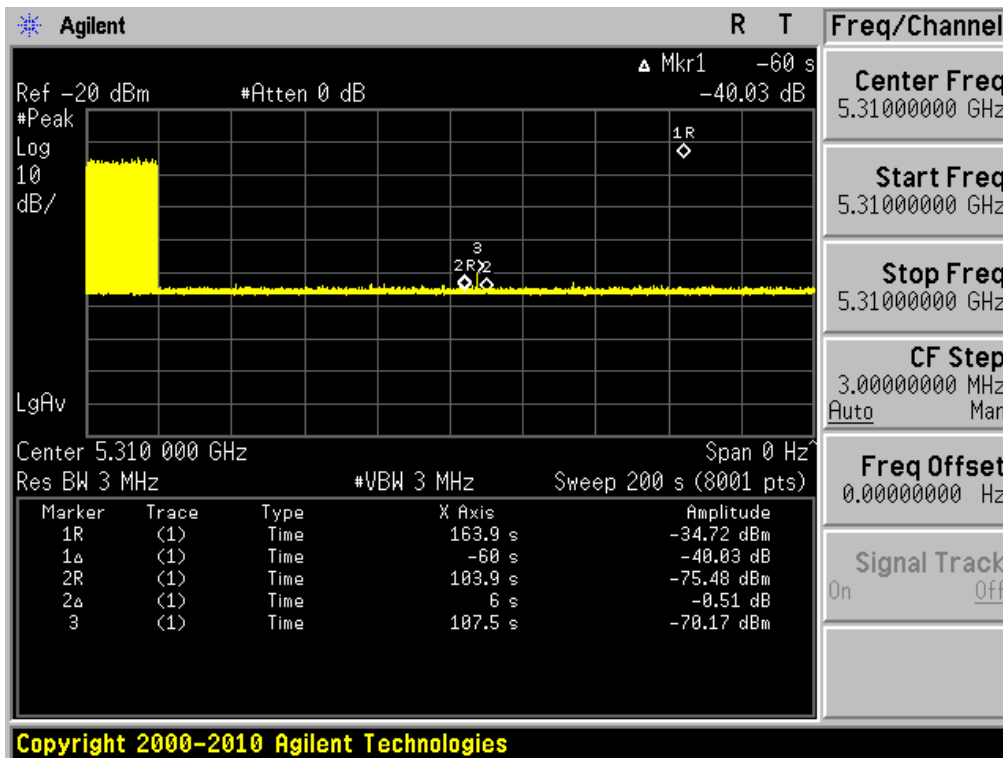

Unless otherwise stated the results shown in this test report refer only to the sample(s) tested and such sample(s) are retained for 90 days only.

除非另有說明，此報告結果僅對測試之樣品負責，同時此樣品僅保留90天。本報告未經本公司書面許可，不可部份複製。

This document is issued by the Company subject to its General Conditions of Service printed overleaf, available on request or accessible at www.sgs.com/terms_and_conditions.htm and, for electronic format documents, subject to Terms and Conditions for Electronic Documents at www.sgs.com/terms_e-document.htm. Attention is drawn to the limitation of liability, indemnification and jurisdiction issues defined therein. Any holder of this document is advised that information contained hereon reflects the Company's findings at the time of its intervention only and within the limits of Client's instructions, if any. The Company's sole responsibility is to its Client and this document does not exonerate parties to a transaction from exercising all their rights and obligations under the transaction documents. This document cannot be reproduced except in full, without prior written approval of the Company. Any unauthorized alteration, forgery or falsification of the content or appearance of this document is unlawful and offenders may be prosecuted to the fullest extent of the law.

SGS Taiwan Ltd.

No.134,WuKungRoad,NewTaipeiIndustrialPark,WukuDistrict,NewTaipeiCity,Taiwan24803/新北市五股區新北產業園區五工路 134 號

台灣檢驗科技股份有限公司

t (886-2) 2299-3279

f (886-2) 2298-0488

www.tw.sgs.com

Member of SGS Group

Radar type 0 for 802.11n40:

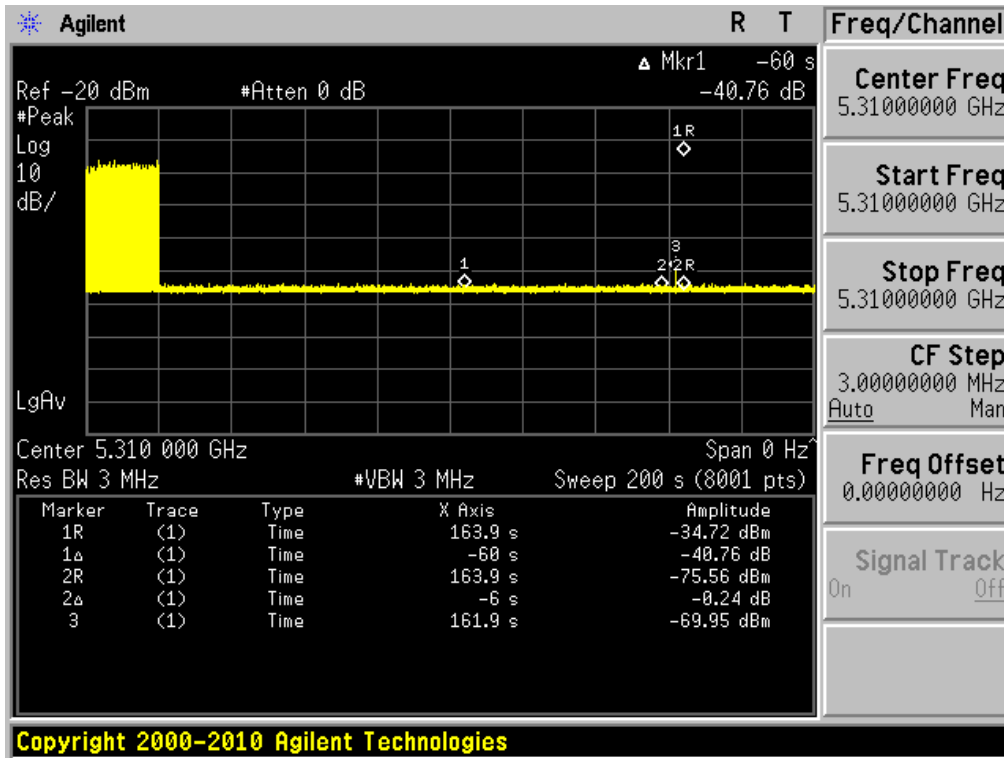

Radar type 1 for 802.11n40:

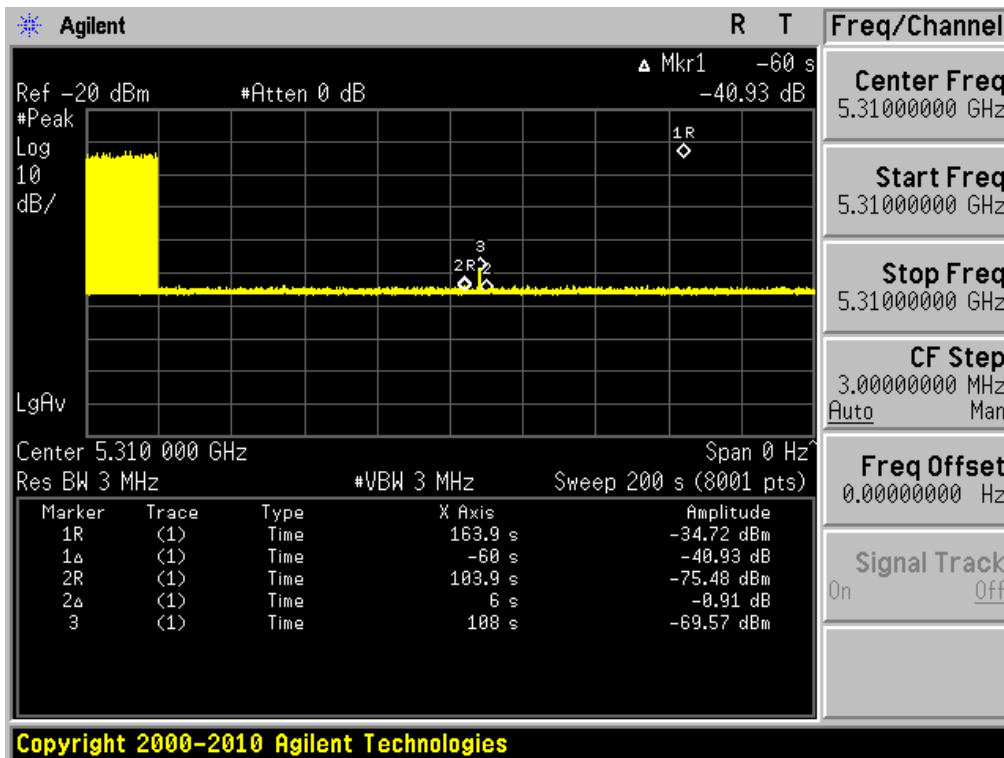

Unless otherwise stated the results shown in this test report refer only to the sample(s) tested and such sample(s) are retained for 90 days only.

除非另有說明，此報告結果僅對測試之樣品負責，同時此樣品僅保留90天。本報告未經本公司書面許可，不可部份複製。

This document is issued by the Company subject to its General Conditions of Service printed overleaf, available on request or accessible at www.sgs.com/terms_and_conditions.htm and, for electronic format documents, subject to Terms and Conditions for Electronic Documents at www.sgs.com/terms_e-document.htm. Attention is drawn to the limitation of liability, indemnification and jurisdiction issues defined therein. Any holder of this document is advised that information contained hereon reflects the Company's findings at the time of its intervention only and within the limits of Client's instructions, if any. The Company's sole responsibility is to its Client and this document does not exonerate parties to a transaction from exercising all their rights and obligations under the transaction documents. This document cannot be reproduced except in full, without prior written approval of the Company. Any unauthorized alteration, forgery or falsification of the content or appearance of this document is unlawful and offenders may be prosecuted to the fullest extent of the law.

Radar type 1 for 802.11n40:

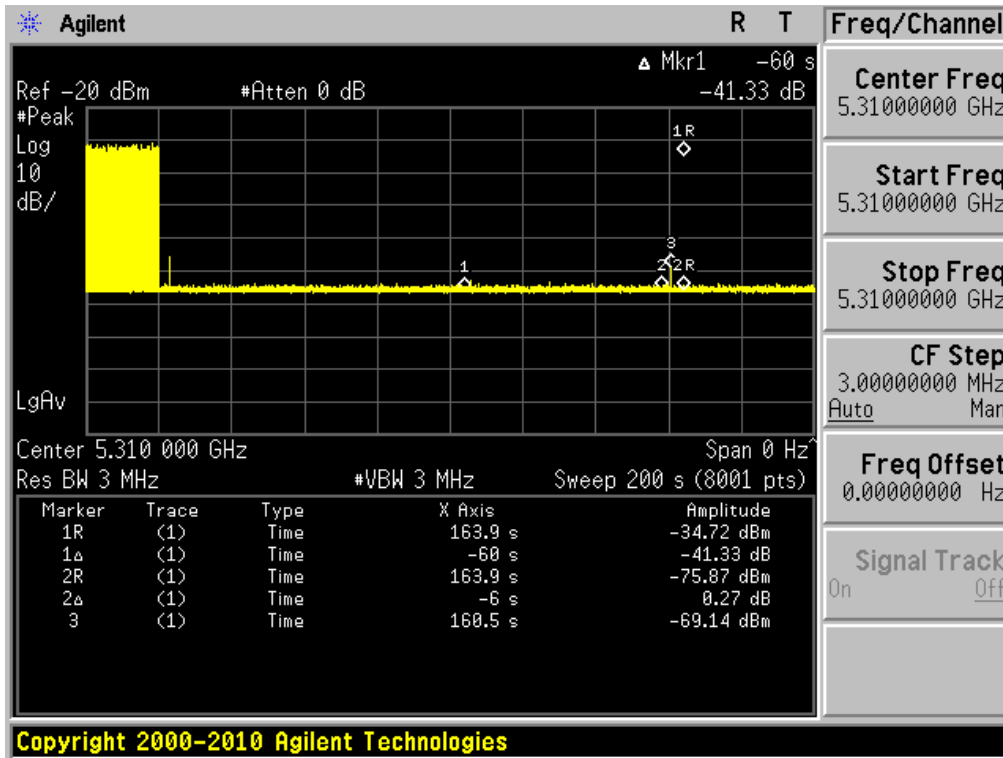

Radar type 2 for 802.11n40:

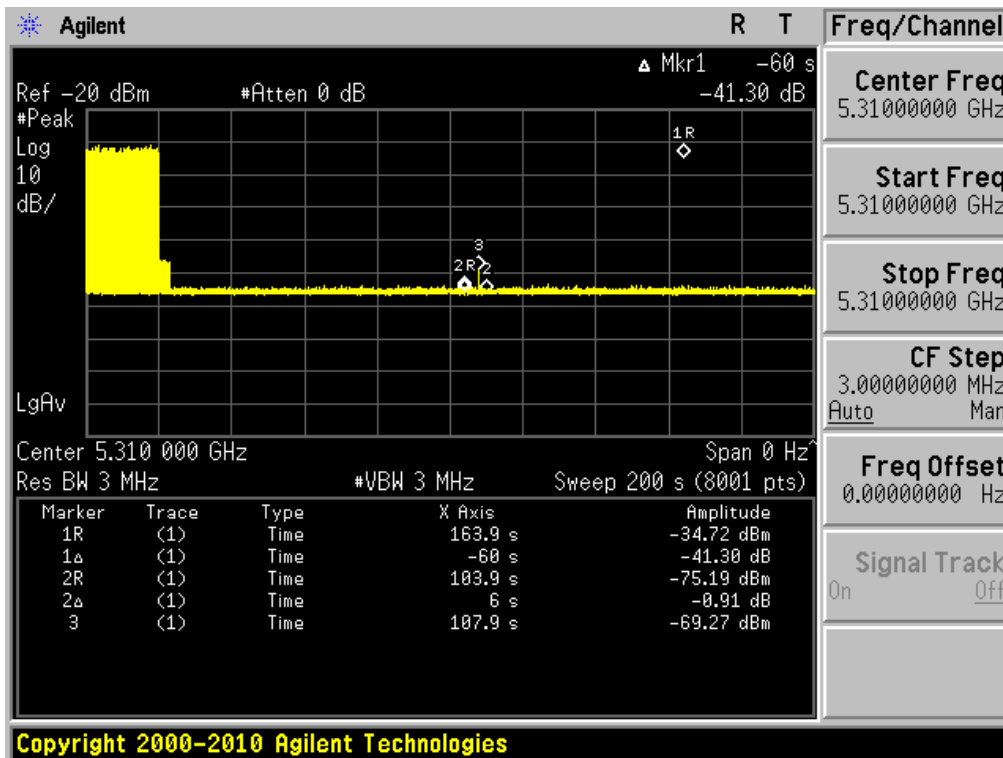

Unless otherwise stated the results shown in this test report refer only to the sample(s) tested and such sample(s) are retained for 90 days only.

除非另有說明，此報告結果僅對測試之樣品負責，同時此樣品僅保留90天。本報告未經本公司書面許可，不可部份複製。

This document is issued by the Company subject to its General Conditions of Service printed overleaf, available on request or accessible at www.sgs.com/terms_and_conditions.htm and, for electronic format documents, subject to Terms and Conditions for Electronic Documents at www.sgs.com/terms_e-document.htm. Attention is drawn to the limitation of liability, indemnification and jurisdiction issues defined therein. Any holder of this document is advised that information contained hereon reflects the Company's findings at the time of its intervention only and within the limits of Client's instructions, if any. The Company's sole responsibility is to its Client and this document does not exonerate parties to a transaction from exercising all their rights and obligations under the transaction documents. This document cannot be reproduced except in full, without prior written approval of the Company. Any unauthorized alteration, forgery or falsification of the content or appearance of this document is unlawful and offenders may be prosecuted to the fullest extent of the law.

Radar type 2 for 802.11n40:

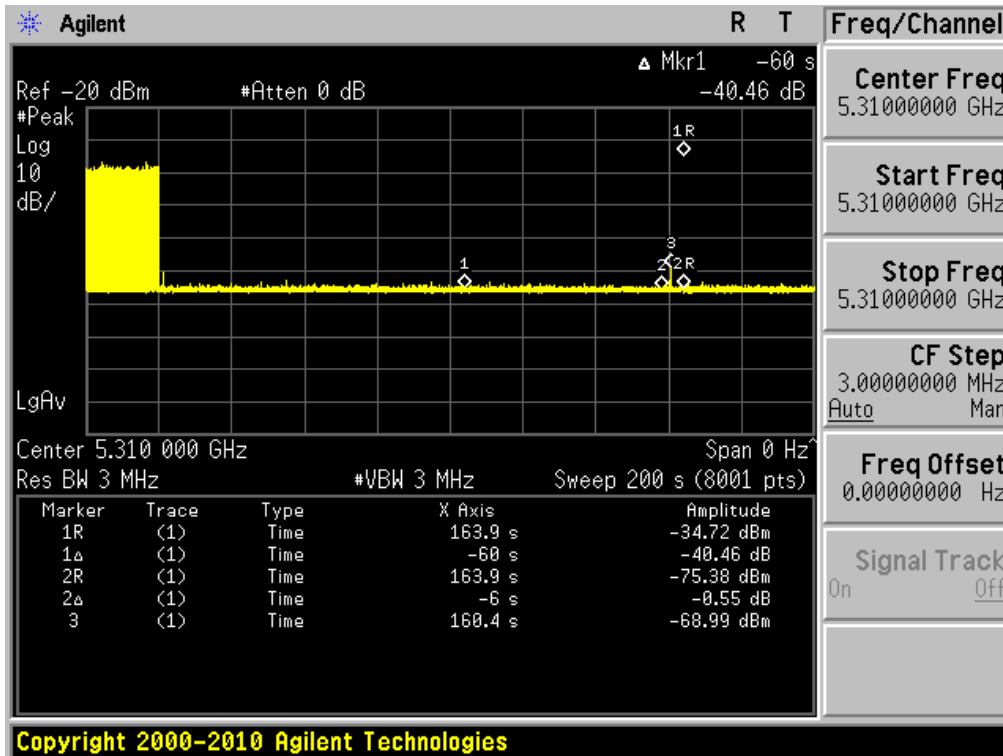

Radar type 3 for 802.11n40:

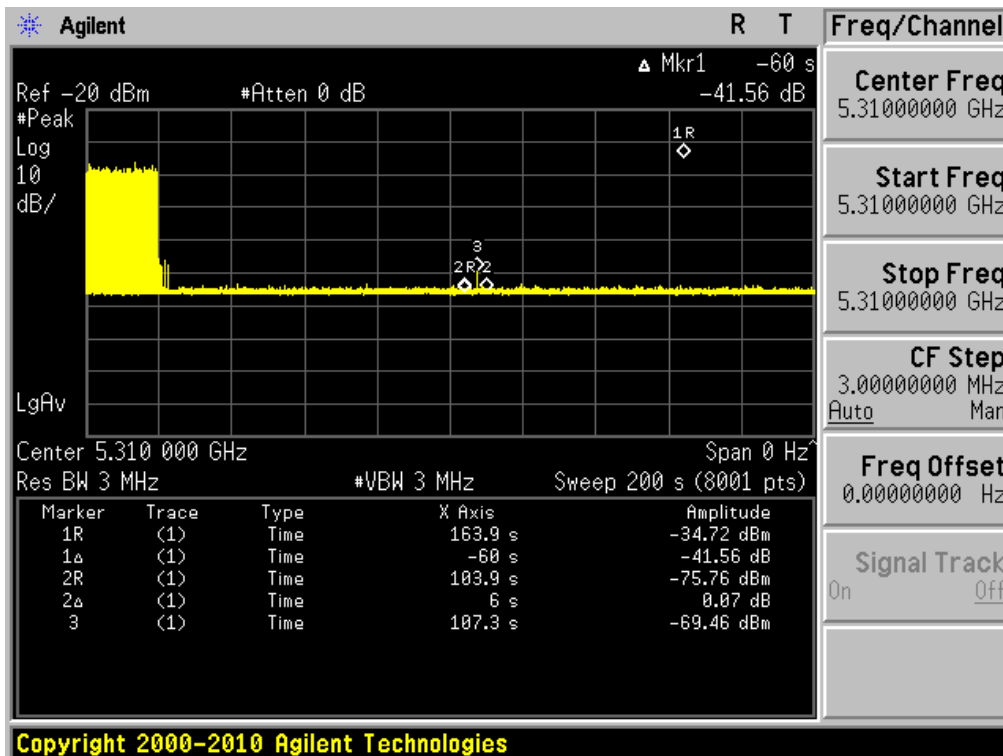

Unless otherwise stated the results shown in this test report refer only to the sample(s) tested and such sample(s) are retained for 90 days only.

除非另有說明，此報告結果僅對測試之樣品負責，同時此樣品僅保留90天。本報告未經本公司書面許可，不可部份複製。

This document is issued by the Company subject to its General Conditions of Service printed overleaf, available on request or accessible at www.sgs.com/terms_and_conditions.htm and, for electronic format documents, subject to Terms and Conditions for Electronic Documents at www.sgs.com/terms_e-document.htm. Attention is drawn to the limitation of liability, indemnification and jurisdiction issues defined therein. Any holder of this document is advised that information contained hereon reflects the Company's findings at the time of its intervention only and within the limits of Client's instructions, if any. The Company's sole responsibility is to its Client and this document does not exonerate parties to a transaction from exercising all their rights and obligations under the transaction documents. This document cannot be reproduced except in full, without prior written approval of the Company. Any unauthorized alteration, forgery or falsification of the content or appearance of this document is unlawful and offenders may be prosecuted to the fullest extent of the law.

Radar type 3 for 802.11n40:

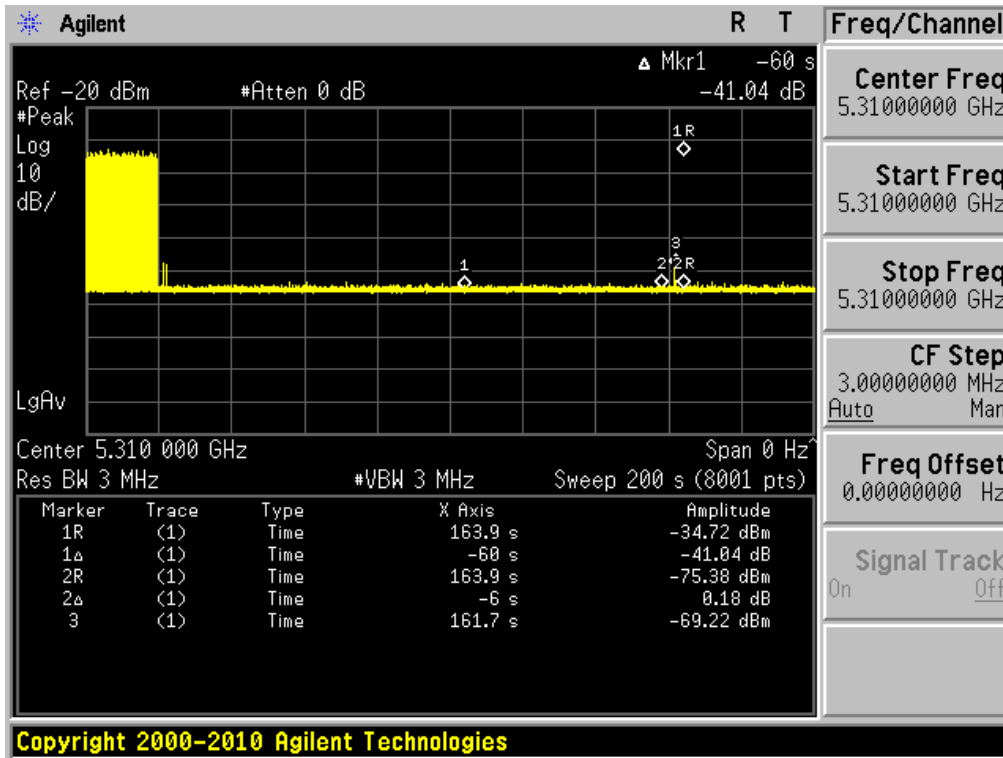

Radar type 4 for 802.11n40:

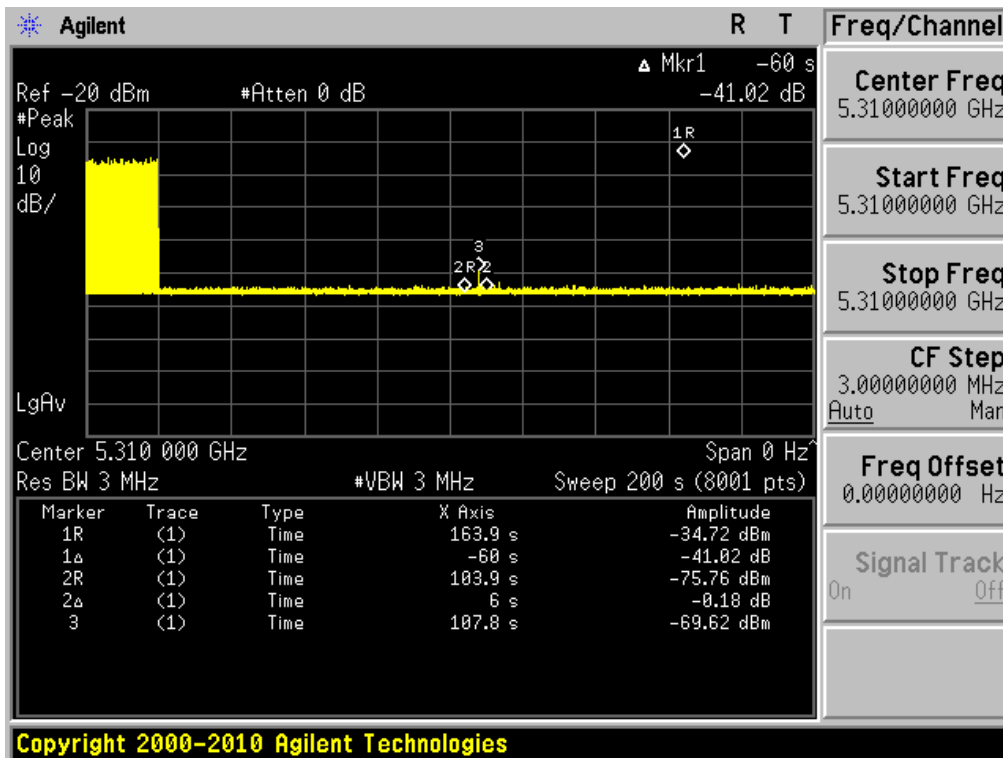

Unless otherwise stated the results shown in this test report refer only to the sample(s) tested and such sample(s) are retained for 90 days only.

除非另有說明，此報告結果僅對測試之樣品負責，同時此樣品僅保留90天。本報告未經本公司書面許可，不可部份複製。

This document is issued by the Company subject to its General Conditions of Service printed overleaf, available on request or accessible at www.sgs.com/terms_and_conditions.htm and, for electronic format documents, subject to Terms and Conditions for Electronic Documents at www.sgs.com/terms_e-document.htm. Attention is drawn to the limitation of liability, indemnification and jurisdiction issues defined therein. Any holder of this document is advised that information contained hereon reflects the Company's findings at the time of its intervention only and within the limits of Client's instructions, if any. The Company's sole responsibility is to its Client and this document does not exonerate parties to a transaction from exercising all their rights and obligations under the transaction documents. This document cannot be reproduced except in full, without prior written approval of the Company. Any unauthorized alteration, forgery or falsification of the content or appearance of this document is unlawful and offenders may be prosecuted to the fullest extent of the law.

Radar type 4 for 802.11n40:

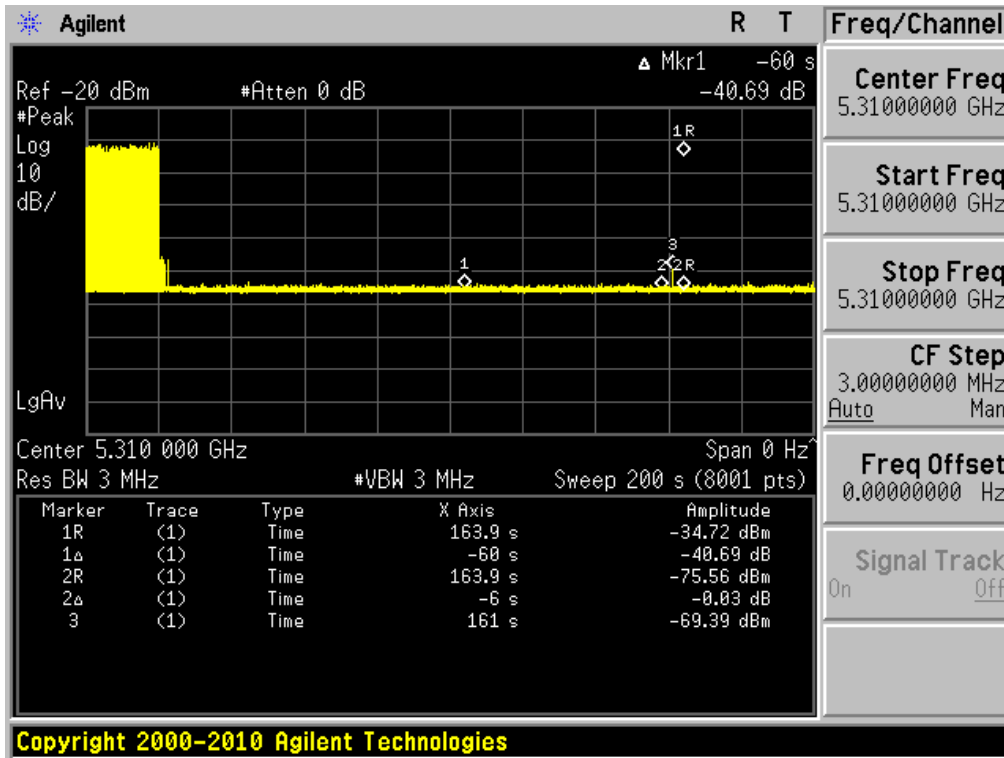

Radar type 0 for 802.11n80:

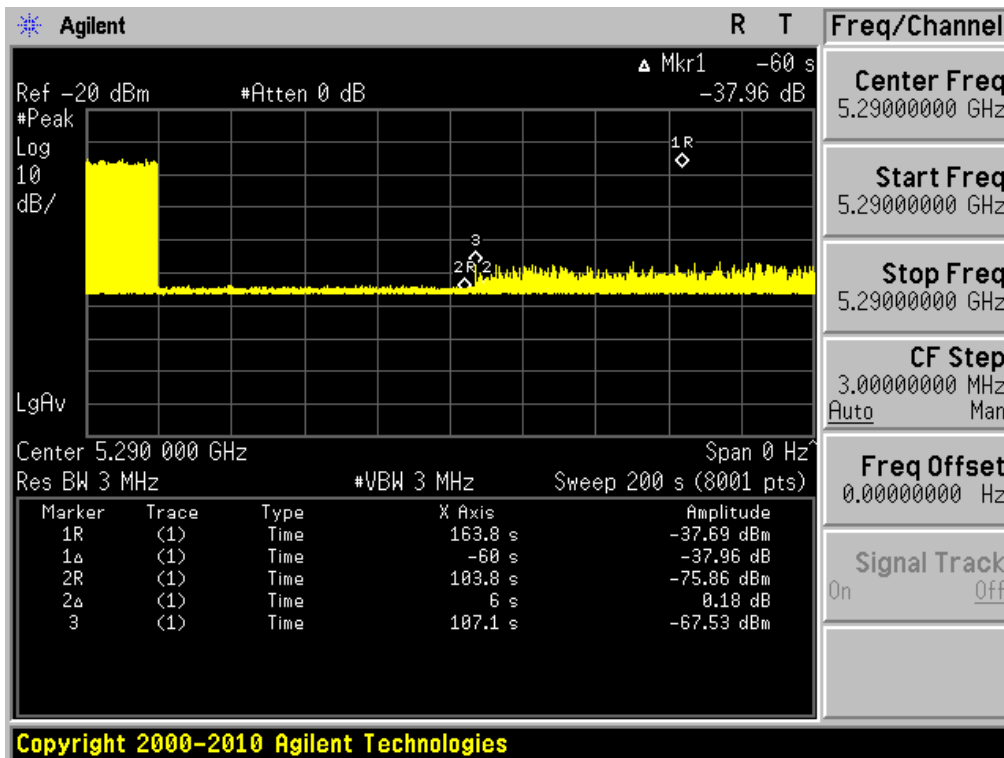

Unless otherwise stated the results shown in this test report refer only to the sample(s) tested and such sample(s) are retained for 90 days only.

除非另有說明，此報告結果僅對測試之樣品負責，同時此樣品僅保留90天。本報告未經本公司書面許可，不可部份複製。

This document is issued by the Company subject to its General Conditions of Service printed overleaf, available on request or accessible at www.sgs.com/terms_and_conditions.htm and, for electronic format documents, subject to Terms and Conditions for Electronic Documents at www.sgs.com/terms_e-document.htm. Attention is drawn to the limitation of liability, indemnification and jurisdiction issues defined therein. Any holder of this document is advised that information contained hereon reflects the Company's findings at the time of its intervention only and within the limits of Client's instructions, if any. The Company's sole responsibility is to its Client and this document does not exonerate parties to a transaction from exercising all their rights and obligations under the transaction documents. This document cannot be reproduced except in full, without prior written approval of the Company. Any unauthorized alteration, forgery or falsification of the content or appearance of this document is unlawful and offenders may be prosecuted to the fullest extent of the law.

Radar type 0 for 802.11n80:

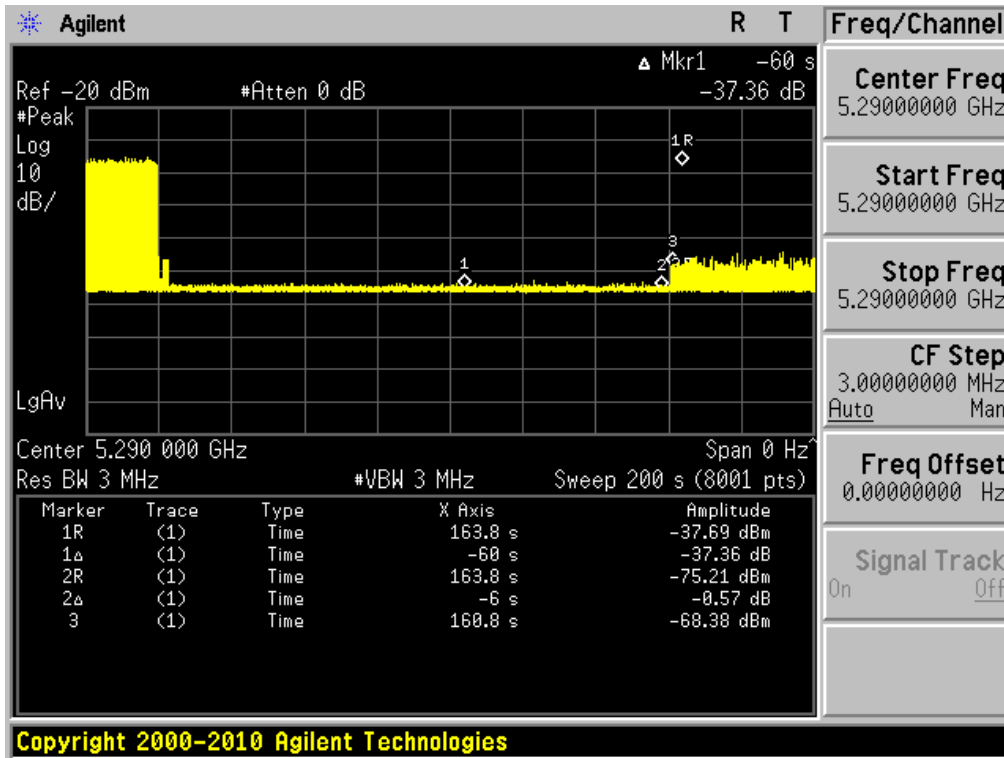

Radar type 1 for 802.11n80:

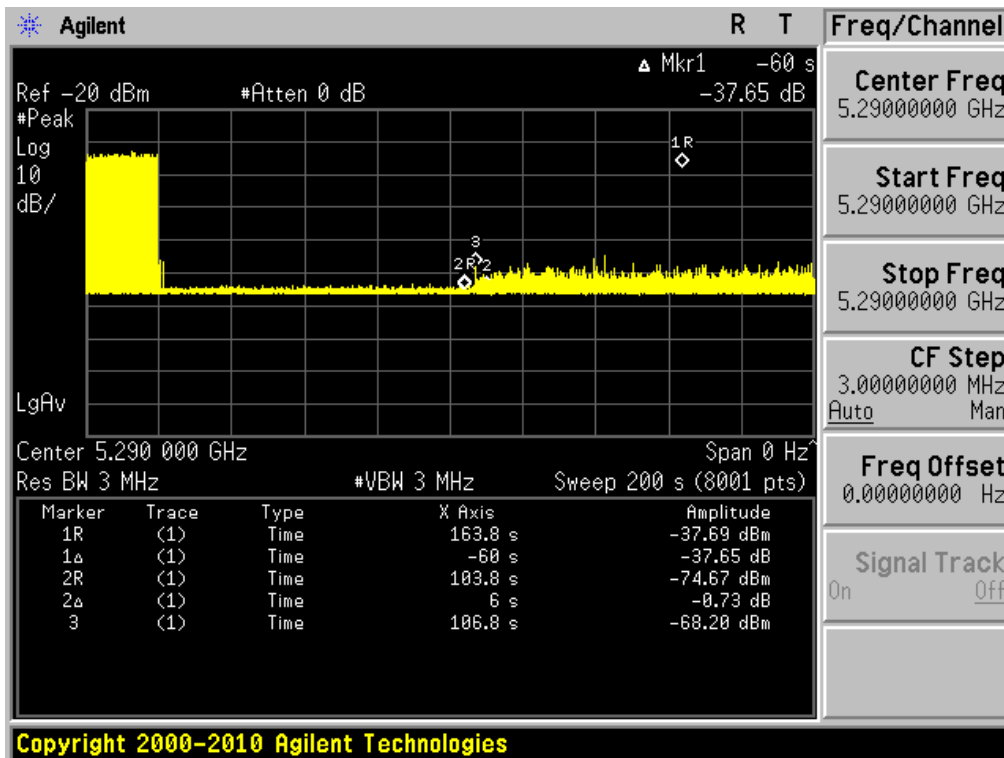

Unless otherwise stated the results shown in this test report refer only to the sample(s) tested and such sample(s) are retained for 90 days only.

除非另有說明，此報告結果僅對測試之樣品負責，同時此樣品僅保留90天。本報告未經本公司書面許可，不可部份複製。

This document is issued by the Company subject to its General Conditions of Service printed overleaf, available on request or accessible at www.sgs.com/terms_and_conditions.htm and, for electronic format documents, subject to Terms and Conditions for Electronic Documents at www.sgs.com/terms_e-document.htm. Attention is drawn to the limitation of liability, indemnification and jurisdiction issues defined therein. Any holder of this document is advised that information contained hereon reflects the Company's findings at the time of its intervention only and within the limits of Client's instructions, if any. The Company's sole responsibility is to its Client and this document does not exonerate parties to a transaction from exercising all their rights and obligations under the transaction documents. This document cannot be reproduced except in full, without prior written approval of the Company. Any unauthorized alteration, forgery or falsification of the content or appearance of this document is unlawful and offenders may be prosecuted to the fullest extent of the law.

Radar type 1 for 802.11n80:

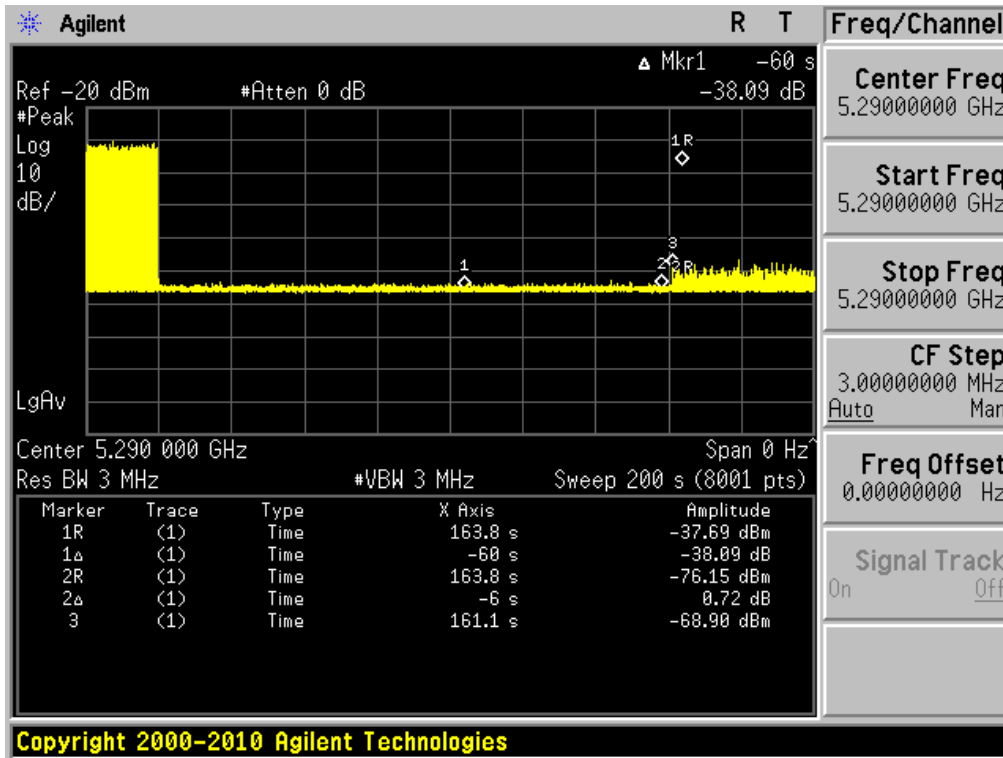

Radar type 2 for 802.11n80:

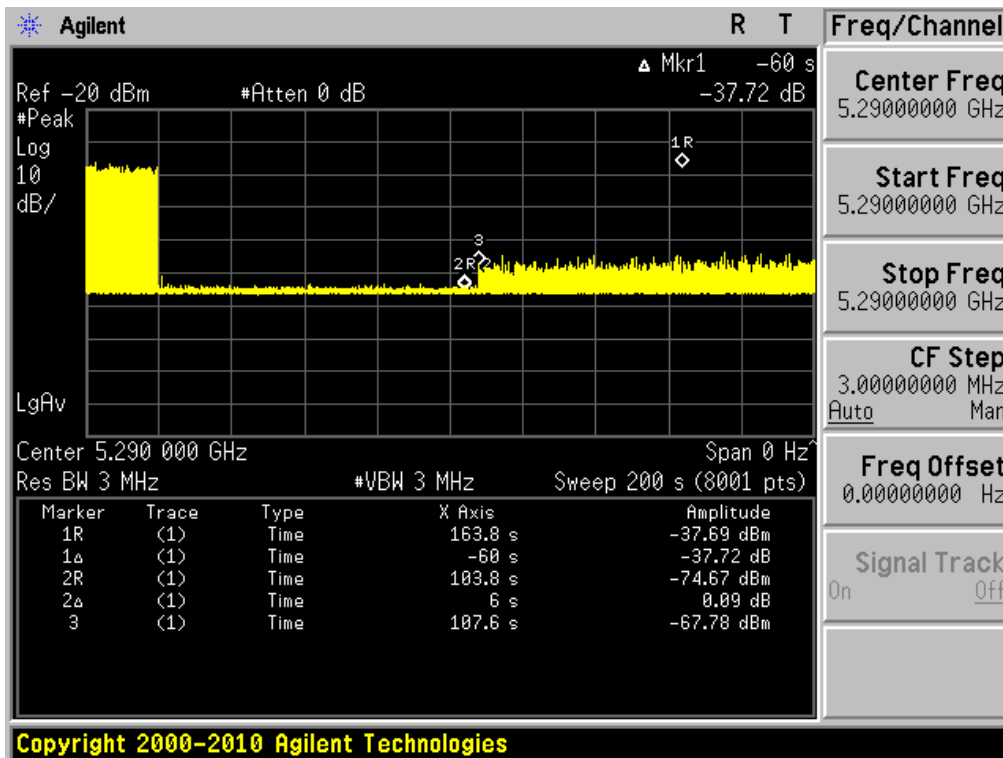

Unless otherwise stated the results shown in this test report refer only to the sample(s) tested and such sample(s) are retained for 90 days only.

除非另有說明，此報告結果僅對測試之樣品負責，同時此樣品僅保留90天。本報告未經本公司書面許可，不可部份複製。

This document is issued by the Company subject to its General Conditions of Service printed overleaf, available on request or accessible at www.sgs.com/terms_and_conditions.htm and, for electronic format documents, subject to Terms and Conditions for Electronic Documents at www.sgs.com/terms_e-document.htm. Attention is drawn to the limitation of liability, indemnification and jurisdiction issues defined therein. Any holder of this document is advised that information contained hereon reflects the Company's findings at the time of its intervention only and within the limits of Client's instructions, if any. The Company's sole responsibility is to its Client and this document does not exonerate parties to a transaction from exercising all their rights and obligations under the transaction documents. This document cannot be reproduced except in full, without prior written approval of the Company. Any unauthorized alteration, forgery or falsification of the content or appearance of this document is unlawful and offenders may be prosecuted to the fullest extent of the law.

Radar type 2 for 802.11n80:

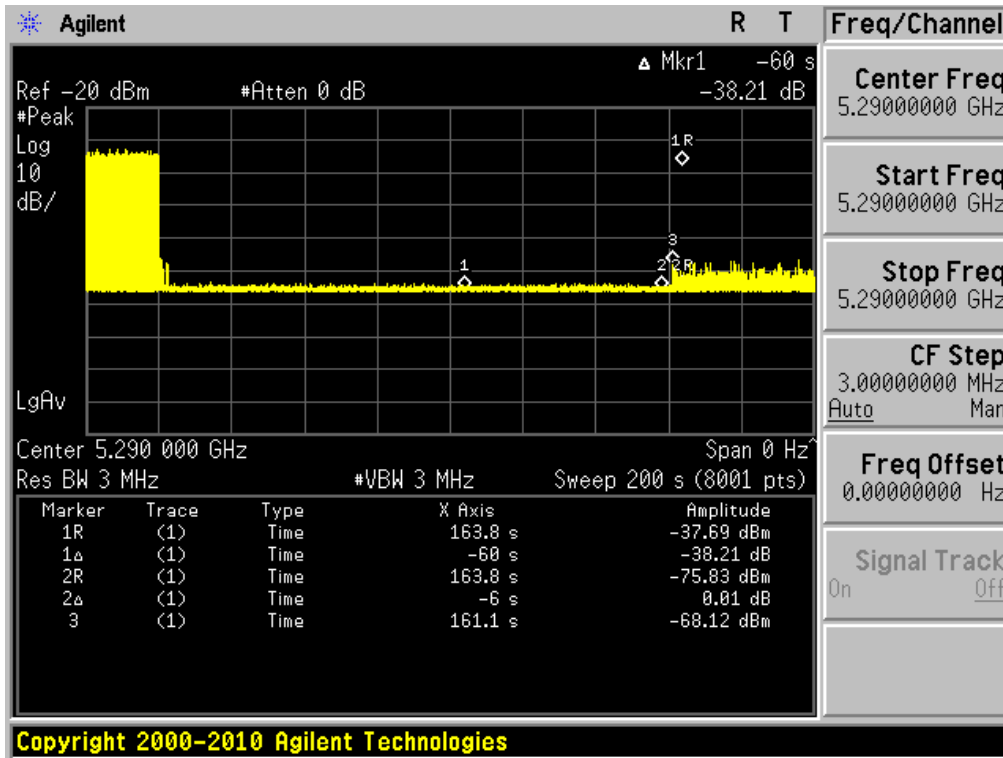

Radar type 3 for 802.11n80:

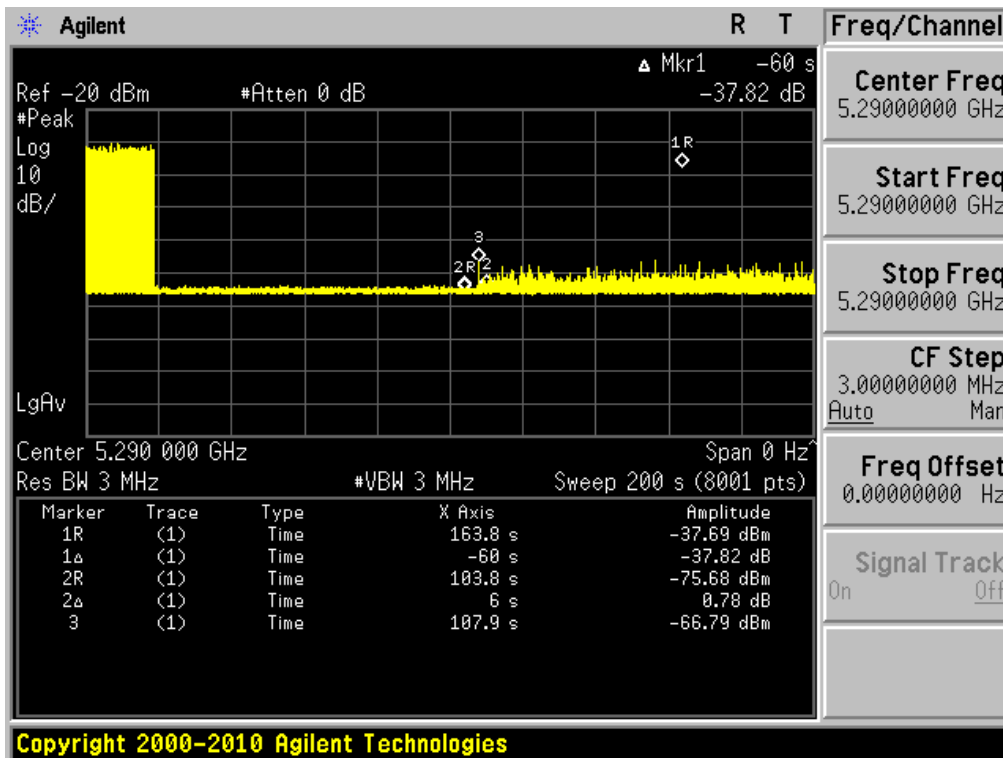

Unless otherwise stated the results shown in this test report refer only to the sample(s) tested and such sample(s) are retained for 90 days only.

除非另有說明，此報告結果僅對測試之樣品負責，同時此樣品僅保留90天。本報告未經本公司書面許可，不可部份複製。

This document is issued by the Company subject to its General Conditions of Service printed overleaf, available on request or accessible at www.sgs.com/terms_and_conditions.htm and, for electronic format documents, subject to Terms and Conditions for Electronic Documents at www.sgs.com/terms_e-document.htm. Attention is drawn to the limitation of liability, indemnification and jurisdiction issues defined therein. Any holder of this document is advised that information contained hereon reflects the Company's findings at the time of its intervention only and within the limits of Client's instructions, if any. The Company's sole responsibility is to its Client and this document does not exonerate parties to a transaction from exercising all their rights and obligations under the transaction documents. This document cannot be reproduced except in full, without prior written approval of the Company. Any unauthorized alteration, forgery or falsification of the content or appearance of this document is unlawful and offenders may be prosecuted to the fullest extent of the law.

Radar type 3 for 802.11n80:

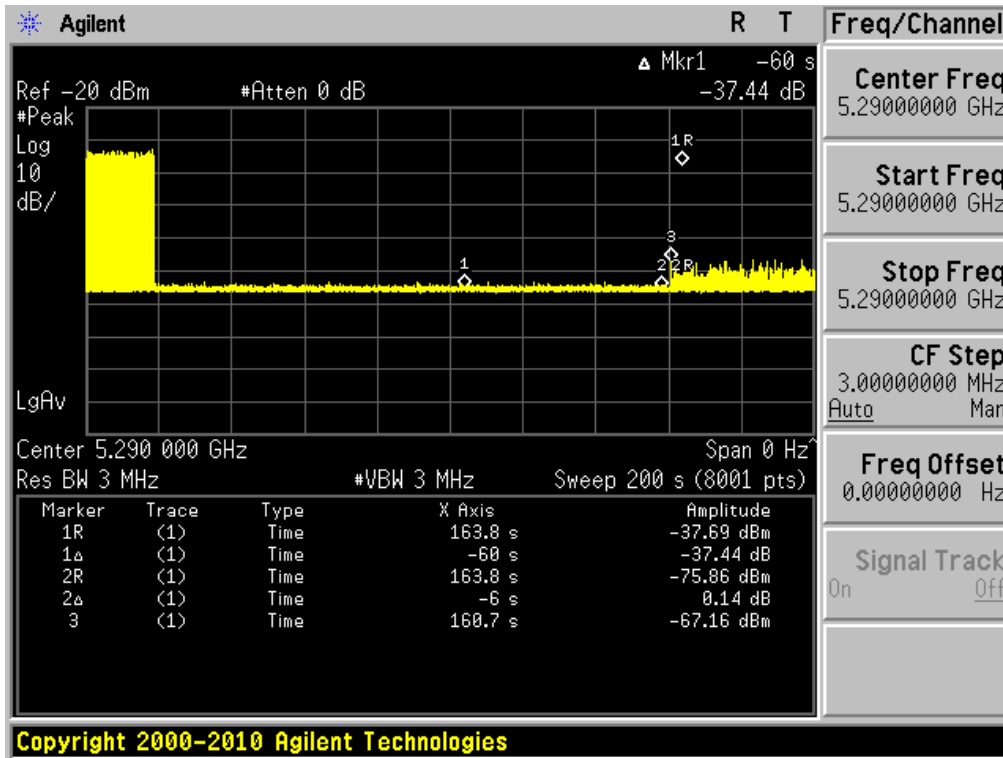

Radar type 4 for 802.11n80:

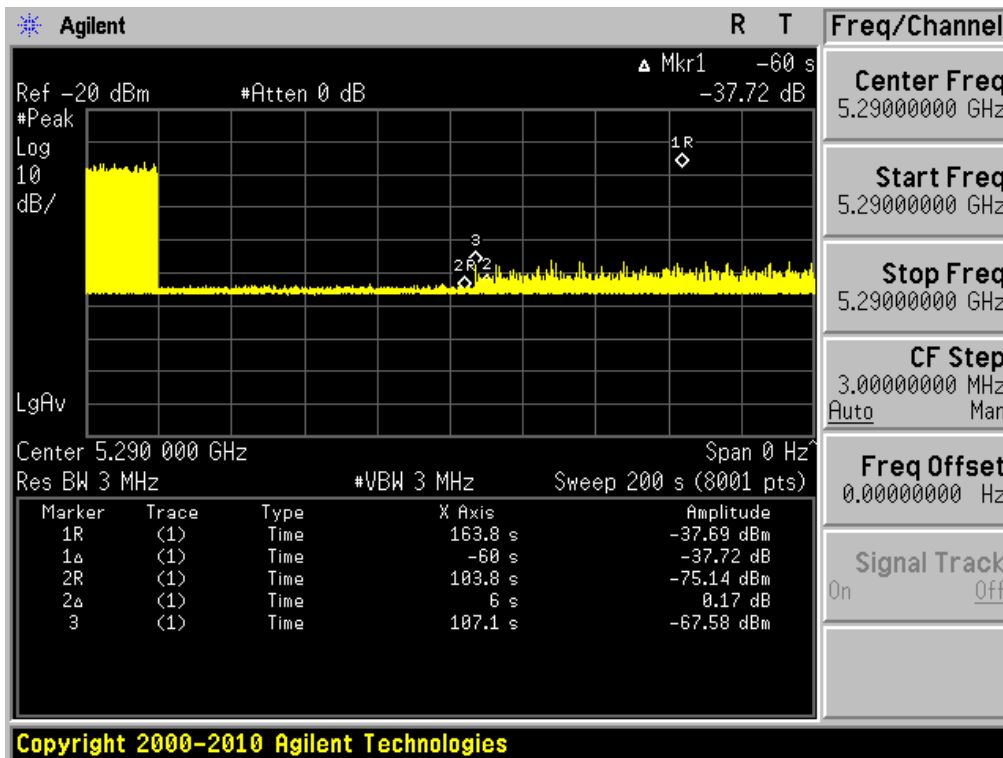

Unless otherwise stated the results shown in this test report refer only to the sample(s) tested and such sample(s) are retained for 90 days only.

除非另有說明，此報告結果僅對測試之樣品負責，同時此樣品僅保留90天。本報告未經本公司書面許可，不可部份複製。

This document is issued by the Company subject to its General Conditions of Service printed overleaf, available on request or accessible at www.sgs.com/terms_and_conditions.htm and, for electronic format documents, subject to Terms and Conditions for Electronic Documents at www.sgs.com/terms_e-document.htm. Attention is drawn to the limitation of liability, indemnification and jurisdiction issues defined therein. Any holder of this document is advised that information contained hereon reflects the Company's findings at the time of its intervention only and within the limits of Client's instructions, if any. The Company's sole responsibility is to its Client and this document does not exonerate parties to a transaction from exercising all their rights and obligations under the transaction documents. This document cannot be reproduced except in full, without prior written approval of the Company. Any unauthorized alteration, forgery or falsification of the content or appearance of this document is unlawful and offenders may be prosecuted to the fullest extent of the law.

**In-Service Monitoring:
802.11a 5300 MHz:**

Short Pulse Radar Type	Minimum Number of Trials	Detection(%)	Minimum Percentage of Successful Detection(%)	Pass/Fail
1	30	96.66	60	Pass
2	30	100.00	60	Pass
3	30	100.00	60	Pass
4	30	100.00	60	Pass
Aggregate (Radar Types 1-4)	120	99.17	80	Pass
Long Pulse Radar Test Waveform	Minimum Number of Trials	Detection	Minimum Percentage of Successful Detection(Limit)	Pass/Fail
5 - Variable	30	100.00	80	Pass
Frequency Hopping Radar Test Waveform	Minimum Number of Trials	Detection	Minimum Percentage of Successful Detection(Limit)	Pass/Fail
6	30	100.00	70	Pass

Unless otherwise stated the results shown in this test report refer only to the sample(s) tested and such sample(s) are retained for 90 days only.

除非另有說明，此報告結果僅對測試之樣品負責，同時此樣品僅保留90天。本報告未經本公司書面許可，不可部份複製。

This document is issued by the Company subject to its General Conditions of Service printed overleaf, available on request or accessible at www.sgs.com/terms_and_conditions.htm and, for electronic format documents, subject to Terms and Conditions for Electronic Documents at www.sgs.com/terms_e-document.htm. Attention is drawn to the limitation of liability, indemnification and jurisdiction issues defined therein. Any holder of this document is advised that information contained hereon reflects the Company's findings at the time of its intervention only and within the limits of Client's instructions, if any. The Company's sole responsibility is to its Client and this document does not exonerate parties to a transaction from exercising all their rights and obligations under the transaction documents. This document cannot be reproduced except in full, without prior written approval of the Company. Any unauthorized alteration, forgery or falsification of the content or appearance of this document is unlawful and offenders may be prosecuted to the fullest extent of the law.

SGS Taiwan Ltd.

No.134,WuKungRoad,NewTaipeiIndustrialPark,WukuDistrict,NewTaipeiCity,Taiwan24803/新北市五股區新北產業園區五工路 134 號

台灣檢驗科技股份有限公司

t (886-2) 2299-3279

f (886-2) 2298-0488

www.tw.sgs.com

Member of SGS Group

Radar Type 1 for 802.11a 5300 MHz:

Data Sheet for FCC Variable Radar Type 1				
1 us Pulse Width, PRI Test A&Test B				
Trial	PRI	Pulses Per Burst	Test	Successful Detection

Unless otherwise stated the results shown in this test report refer only to the sample(s) tested and such sample(s) are retained for 90 days only.

除非另有說明，此報告結果僅對測試之樣品負責，同時此樣品僅保留90天。本報告未經本公司書面許可，不可部份複製。

This document is issued by the Company subject to its General Conditions of Service printed overleaf, available on request or accessible at www.sgs.com/terms_and_conditions.htm and, for electronic format documents, subject to Terms and Conditions for Electronic Documents at www.sgs.com/terms_e-document.htm. Attention is drawn to the limitation of liability, indemnification and jurisdiction issues defined therein. Any holder of this document is advised that information contained hereon reflects the Company's findings at the time of its intervention only and within the limits of Client's instructions, if any. The Company's sole responsibility is to its Client and this document does not exonerate parties to a transaction from exercising all their rights and obligations under the transaction documents. This document cannot be reproduced except in full, without prior written approval of the Company. Any unauthorized alteration, forgery or falsification of the content or appearance of this document is unlawful and offenders may be prosecuted to the fullest extent of the law.

SGS Taiwan Ltd.

No.134,WuKungRoad,NewTaipeiIndustrialPark,WukuDistrict,NewTaipeiCity,Taiwan24803/新北市五股區新北產業園區五工路 134 號

台灣檢驗科技股份有限公司

t (886-2) 2299-3279

f (886-2) 2298-0488

www.tw.sgs.com

Member of SGS Group

Radar Type 2 for 802.11a 5300 MHz:

Data Sheet for FCC Variable Radar Type 2				
1-5 us Pulse Width, PRI 150-230 us, 23-29 Pulses per Burst				
Trial	Pulse Width	PRI	Pulses Per Burst	Successful Detection

Unless otherwise stated the results shown in this test report refer only to the sample(s) tested and such sample(s) are retained for 90 days only.

除非另有說明，此報告結果僅對測試之樣品負責，同時此樣品僅保留90天。本報告未經本公司書面許可，不可部份複製。

This document is issued by the Company subject to its General Conditions of Service printed overleaf, available on request or accessible at www.sgs.com/terms_and_conditions.htm and, for electronic format documents, subject to Terms and Conditions for Electronic Documents at www.sgs.com/terms_e-document.htm. Attention is drawn to the limitation of liability, indemnification and jurisdiction issues defined therein. Any holder of this document is advised that information contained hereon reflects the Company's findings at the time of its intervention only and within the limits of Client's instructions, if any. The Company's sole responsibility is to its Client and this document does not exonerate parties to a transaction from exercising all their rights and obligations under the transaction documents. This document cannot be reproduced except in full, without prior written approval of the Company. Any unauthorized alteration, forgery or falsification of the content or appearance of this document is unlawful and offenders may be prosecuted to the fullest extent of the law.

SGS Taiwan Ltd.

No.134,WuKungRoad,NewTaipeiIndustrialPark,WukuDistrict,NewTaipeiCity,Taiwan24803/新北市五股區新北產業園區五工路 134 號

台灣檢驗科技股份有限公司

t (886-2) 2299-3279

f (886-2) 2298-0488

www.tw.sgs.com

Member of SGS Group

Radar Type 3 for 802.11a 5300 MHz:

Data Sheet for FCC Variable Radar Type 3				
6-10 us Pulse Width, PRI 200-500 us, 16-18 Pulses per Burst				
Trial	Pulse Width	PRI	Pulses Per Burst	Successful Detection

Unless otherwise stated the results shown in this test report refer only to the sample(s) tested and such sample(s) are retained for 90 days only.

除非另有說明，此報告結果僅對測試之樣品負責，同時此樣品僅保留90天。本報告未經本公司書面許可，不可部份複製。

This document is issued by the Company subject to its General Conditions of Service printed overleaf, available on request or accessible at www.sgs.com/terms_and_conditions.htm and, for electronic format documents, subject to Terms and Conditions for Electronic Documents at www.sgs.com/terms_e-document.htm. Attention is drawn to the limitation of liability, indemnification and jurisdiction issues defined therein. Any holder of this document is advised that information contained hereon reflects the Company's findings at the time of its intervention only and within the limits of Client's instructions, if any. The Company's sole responsibility is to its Client and this document does not exonerate parties to a transaction from exercising all their rights and obligations under the transaction documents. This document cannot be reproduced except in full, without prior written approval of the Company. Any unauthorized alteration, forgery or falsification of the content or appearance of this document is unlawful and offenders may be prosecuted to the fullest extent of the law.

SGS Taiwan Ltd.

No.134,WuKungRoad,NewTaipeiIndustrialPark,WukuDistrict,NewTaipeiCity,Taiwan24803/新北市五股區新北產業園區五工路 134 號

台灣檢驗科技股份有限公司

t (886-2) 2299-3279

f (886-2) 2298-0488

www.tw.sgs.com

Member of SGS Group

Radar Type 4 for 802.11a 5300 MHz:

Data Sheet for FCC Variable Radar Type 4				
11-20 us Pulse Width, PRI 200-500 us, 12-16 Pulses per Burst				
Trial	Pulse Width	PRI	Pulses Per Burst	Successful Detection

Unless otherwise stated the results shown in this test report refer only to the sample(s) tested and such sample(s) are retained for 90 days only.

除非另有說明，此報告結果僅對測試之樣品負責，同時此樣品僅保留90天。本報告未經本公司書面許可，不可部份複製。

This document is issued by the Company subject to its General Conditions of Service printed overleaf, available on request or accessible at www.sgs.com/terms_and_conditions.htm and, for electronic format documents, subject to Terms and Conditions for Electronic Documents at www.sgs.com/terms_e-document.htm. Attention is drawn to the limitation of liability, indemnification and jurisdiction issues defined therein. Any holder of this document is advised that information contained hereon reflects the Company's findings at the time of its intervention only and within the limits of Client's instructions, if any. The Company's sole responsibility is to its Client and this document does not exonerate parties to a transaction from exercising all their rights and obligations under the transaction documents. This document cannot be reproduced except in full, without prior written approval of the Company. Any unauthorized alteration, forgery or falsification of the content or appearance of this document is unlawful and offenders may be prosecuted to the fullest extent of the law.

SGS Taiwan Ltd.

No.134,WuKungRoad,NewTaipeiIndustrialPark,WukuDistrict,NewTaipeiCity,Taiwan24803/新北市五股區新北產業園區五工路 134 號

台灣檢驗科技股份有限公司

t (886-2) 2299-3279

f (886-2) 2298-0488

www.tw.sgs.com

Member of SGS Group

Radar Type 5 for 802.11a 5300 MHz

Wave form Num = 1
Num of Bursts = 13
Burst Interval (us) = 923077

Burst #	OffTime (us)	# Pulses	Chirp (MHz)	PW (us)	Pulse1 Pri(us)	Pulse2 Pri(us)	Pulse3 Pri(us)	StartLoc (us)	StartBurst Interval(us)	EndBurst Interval(us)
1	0	1	20	85	1711	0	0	169342	0	923076
2	0	1	14	95	1085	0	0	1714261	923077	1846153
3	0	2	19	100	1119	1917	0	2473491	1846154	2769230
4	0	3	7	65	1384	1403	1757	3595524	2769231	3692307
5	0	2	10	100	1526	1255	0	4321252	3692308	4615384
6	0	3	5	80	1428	1176	1907	5051268	4615385	5538461
7	0	2	17	80	1282	1563	0	6421030	5538462	6461538
8	0	2	11	50	1053	1545	0	6923869	6461539	7384615
9	0	1	8	50	1283	0	0	7727818	7384616	8307692
10	0	3	14	70	1665	1139	1499	9005206	8307693	9230769
11	0	3	19	50	1799	1922	1667	9711588	9230770	10153846
12	0	2	14	100	1059	1559	0	10895173	10153847	11076923
13	0	1	20	50	1119	0	0	11417289	11076924	12000000
Total	number	of	pulses	in	waveform	=	26			

Radar Type 5 for 802.11a 5300 MHz

Wave form Num = 2
Num of Bursts = 11
Burst Interval (us) = 1E+06

Burst #	OffTime (us)	# Pulses	Chirp (MHz)	PW (us)	Pulse1 Pri(us)	Pulse2 Pri(us)	Pulse3 Pri(us)	StartLoc (us)	StartBurst Interval(us)	EndBurst Interval(us)
1	783213	3	6	60	1760	1899	1271	783213	0	1090908
2	1213357	3	11	70	1123	1113	1524	2001500	1090909	2181817
3	403866	1	11	65	1459	0	0	2409126	2181818	3272726
4	897216	3	20	95	1848	1886	1125	3307801	3272727	4363635
5	1925231	2	10	95	1701	1002	0	5237891	4363636	5454544
6	565937	3	16	80	1863	1679	1668	5806531	5454545	6545453
7	1191575	3	6	55	1255	1501	1012	7003316	6545454	7636362
8	711823	1	13	85	1548	0	0	7718907	7636363	8727271
9	1545030	3	7	75	1749	1433	1727	9265485	8727272	9818180
10	889923	1	10	85	1924	0	0	10160317	9818181	10909089
11	1253277	3	7	50	1817	1287	1742	11415518	10909090	11999998
Total	number	of	pulses	in	waveform	=	26			

Unless otherwise stated the results shown in this test report refer only to the sample(s) tested and such sample(s) are retained for 90 days only.

除非另有說明，此報告結果僅對測試之樣品負責，同時此樣品僅保留90天。本報告未經本公司書面許可，不可部份複製。

This document is issued by the Company subject to its General Conditions of Service printed overleaf, available on request or accessible at www.sgs.com/terms_and_conditions.htm and, for electronic format documents, subject to Terms and Conditions for Electronic Documents at www.sgs.com/terms_e-document.htm. Attention is drawn to the limitation of liability, indemnification and jurisdiction issues defined therein. Any holder of this document is advised that information contained hereon reflects the Company's findings at the time of its intervention only and within the limits of Client's instructions, if any. The Company's sole responsibility is to its Client and this document does not exonerate parties to a transaction from exercising all their rights and obligations under the transaction documents. This document cannot be reproduced except in full, without prior written approval of the Company. Any unauthorized alteration, forgery or falsification of the content or appearance of this document is unlawful and offenders may be prosecuted to the fullest extent of the law.

SGS Taiwan Ltd.

No.134,WuKungRoad,NewTaipeiIndustrialPark,WukuDistrict,NewTaipeiCity,Taiwan24803/新北市五股區新北產業園區五工路 134 號

台灣檢驗科技股份有限公司

t (886-2) 2299-3279

f (886-2) 2298-0488

www.tw.sgs.com

Member of SGS Group

Radar Type 5 for 802.11a 5300 MHz

Wave form Num = 3
Num of Bursts = 14
Burst Interval (us) = 857143

Burst #	OffTime (us)	# Pulses	Chirp (MHz)	PW (us)	Pulse1 Pri(us)	Pulse2 Pri(us)	Pulse3 Pri(us)	StartLoc (us)	StartBurst Interval(us)	EndBurst Interval(us)
1	585266	1	7	55	1716	0	0	585266	0	857142
2	972599	3	8	80	1272	1277	1146	1559581	857143	1714285
3	586452	1	15	75	1568	0	0	2149728	1714286	2571428
4	647944	3	17	100	1213	1474	1234	2799240	2571429	3428571
5	893123	2	15	80	1659	1762	0	3696284	3428572	4285714
6	1320913	3	5	85	1066	1501	1084	5020618	4285715	5142857
7	817295	2	19	100	1356	1205	0	5841564	5142858	6000000
8	765245	2	10	85	1379	1417	0	6609370	6000001	6857143
9	419785	1	7	75	1396	0	0	7031951	6857144	7714286
10	1279091	1	17	70	1977	0	0	8312438	7714287	8571429
11	800564	1	18	100	1407	0	0	9114979	8571430	9428572
12	1027994	1	11	95	1938	0	0	10144380	9428573	10285715
13	345164	3	9	70	1166	1208	1513	10491482	10285716	11142858
14	1230417	1	17	55	1762	0	0	11725786	11142859	12000001
Total	number	of	pulses	in	waveform	=	25			

Radar Type 5 for 802.11a 5300 MHz

Wave form Num = 4
Num of Bursts = 9
Burst Interval (us) = 1E+06

Burst #	OffTime (us)	# Pulses	Chirp (MHz)	PW (us)	Pulse1 Pri(us)	Pulse2 Pri(us)	Pulse3 Pri(us)	StartLoc (us)	StartBurst Interval(us)	EndBurst Interval(us)
1	721734	3	5	80	1389	1149	1540	721734	0	1333332
2	1337683	2	15	55	1674	1815	0	2063495	1333333	2666665
3	906592	3	17	95	1140	1876	1368	2973576	2666666	3999998
4	2155857	1	5	60	1101	0	0	5133817	3999999	5333331
5	541735	1	15	60	1230	0	0	5676653	5333332	6666664
6	2105653	1	16	75	1422	0	0	7783536	6666665	7999997
7	779956	2	13	70	1053	1726	0	8564914	7999998	9333330
8	1637430	1	18	80	1282	0	0	10205123	9333331	10666663
9	518649	1	8	55	1328	0	0	10725054	10666664	11999996
Total	number	of	pulses	in	waveform	=	15			

Unless otherwise stated the results shown in this test report refer only to the sample(s) tested and such sample(s) are retained for 90 days only.

除非另有說明，此報告結果僅對測試之樣品負責，同時此樣品僅保留90天。本報告未經本公司書面許可，不可部份複製。

This document is issued by the Company subject to its General Conditions of Service printed overleaf, available on request or accessible at www.sgs.com/terms_and_conditions.htm and, for electronic format documents, subject to Terms and Conditions for Electronic Documents at www.sgs.com/terms_e-document.htm. Attention is drawn to the limitation of liability, indemnification and jurisdiction issues defined therein. Any holder of this document is advised that information contained hereon reflects the Company's findings at the time of its intervention only and within the limits of Client's instructions, if any. The Company's sole responsibility is to its Client and this document does not exonerate parties to a transaction from exercising all their rights and obligations under the transaction documents. This document cannot be reproduced except in full, without prior written approval of the Company. Any unauthorized alteration, forgery or falsification of the content or appearance of this document is unlawful and offenders may be prosecuted to the fullest extent of the law.

SGS Taiwan Ltd.

No.134,WuKungRoad,NewTaipeiIndustrialPark,WukuDistrict,NewTaipeiCity,Taiwan24803/新北市五股區新北產業園區五工路 134 號

台灣檢驗科技股份有限公司

t (886-2) 2299-3279

f (886-2) 2298-0488

www.tw.sgs.com

Member of SGS Group

Radar Type 5 for 802.11a 5300 MHz

Wave form Num = 5
Num of Bursts = 20
Burst Interval (us) = 600000

Burst #	OffTime (us)	# Pulses	Chirp (MHz)	PW (us)	Pulse1 Pri(us)	Pulse2 Pri(us)	Pulse3 Pri(us)	StartLoc (us)	StartBurst Interval(us)	EndBurst Interval(us)
1	292225	2	17	60	1297	1671	0	292225	0	599999
2	327142	2	20	100	1015	1315	0	622335	600000	1199999
3	1004821	3	7	80	1304	1957	1466	1629486	1200000	1799999
4	548329	1	13	90	1213	0	0	2182542	1800000	2399999
5	299282	3	7	90	1633	1638	1166	2483037	2400000	2999999
6	711842	3	18	100	1498	1584	1267	3199316	3000000	3599999
7	822252	3	5	85	1137	1702	1621	4025917	3600000	4199999
8	720332	3	13	85	1069	1607	1863	4750709	4200000	4799999
9	305081	3	8	80	1472	1739	1757	5060329	4800000	5399999
10	809261	2	5	90	1845	1267	0	5874558	5400000	5999999
11	446210	3	11	65	1763	1734	1111	6323880	6000000	6599999
12	859752	1	7	90	1537	0	0	7188240	6600000	7199999
13	173014	3	9	50	1452	1189	1933	7362791	7200000	7799999
14	864392	1	11	50	1057	0	0	8231757	7800000	8399999
15	394544	2	13	75	1150	1525	0	8627358	8400000	8999999
16	692215	1	16	95	1551	0	0	9322248	9000000	9599999
17	871330	1	20	50	1078	0	0	10195129	9600000	10199999
18	525282	3	5	95	1407	1884	1915	10721489	10200000	10799999
19	382598	2	20	80	1119	1267	0	11109293	10800000	11399999
20	804921	3	19	55	1490	1744	1199	11916600	11400000	11999999
Total	number	of	pulses	in	waveform	=	45			

Radar Type 5 for 802.11a 5300 MHz

Wave form Num = 6
Num of Bursts = 11
Burst Interval (us) = 1E+06

Burst #	OffTime (us)	# Pulses	Chirp (MHz)	PW (us)	Pulse1 Pri(us)	Pulse2 Pri(us)	Pulse3 Pri(us)	StartLoc (us)	StartBurst Interval(us)	EndBurst Interval(us)
1	706019	1	18	60	1967	0	0	706019	0	1090908
2	1463614	3	14	50	1191	1528	1616	2171600	1090909	2181817
3	332771	1	11	65	1302	0	0	2508706	2181818	3272726
4	963620	3	13	80	1971	1820	1605	3473628	3272727	4363635
5	1696488	3	8	95	1411	1341	1323	5175512	4363636	5454544
6	491748	1	10	75	1894	0	0	5671335	5454545	6545453
7	1743598	3	11	85	1364	1242	1086	7416827	6545454	7636362
8	914348	3	9	80	1417	1669	1108	8334867	7636363	8727271
9	1176795	1	7	90	1807	0	0	9515856	8727272	9818180
10	780255	2	10	75	1463	1170	0	10297918	9818181	10909089
11	1539009	3	11	50	1583	1203	1543	11839560	10909090	11999998
Total	number	of	pulses	in	waveform	=	24			

Unless otherwise stated the results shown in this test report refer only to the sample(s) tested and such sample(s) are retained for 90 days only.

除非另有說明，此報告結果僅對測試之樣品負責，同時此樣品僅保留90天。本報告未經本公司書面許可，不可部份複製。

This document is issued by the Company subject to its General Conditions of Service printed overleaf, available on request or accessible at www.sgs.com/terms_and_conditions.htm and, for electronic format documents, subject to Terms and Conditions for Electronic Documents at www.sgs.com/terms_e-document.htm. Attention is drawn to the limitation of liability, indemnification and jurisdiction issues defined therein. Any holder of this document is advised that information contained hereon reflects the Company's findings at the time of its intervention only and within the limits of Client's instructions, if any. The Company's sole responsibility is to its Client and this document does not exonerate parties to a transaction from exercising all their rights and obligations under the transaction documents. This document cannot be reproduced except in full, without prior written approval of the Company. Any unauthorized alteration, forgery or falsification of the content or appearance of this document is unlawful and offenders may be prosecuted to the fullest extent of the law.

SGS Taiwan Ltd.

No.134,WuKungRoad,NewTaipeiIndustrialPark,WukuDistrict,NewTaipeiCity,Taiwan24803/新北市五股區新北產業園區五工路 134 號

台灣檢驗科技股份有限公司

t (886-2) 2299-3279

f (886-2) 2298-0488

www.tw.sgs.com

Member of SGS Group

Radar Type 5 for 802.11a 5300 MHz

Wave form Num = 7
Num of Bursts = 18
Burst Interval (us) = 666667

Burst #	OffTime (us)	# Pulses	Chirp (MHz)	PW (us)	Pulse1 Pri(us)	Pulse2 Pri(us)	Pulse3 Pri(us)	StartLoc (us)	StartBurst Interval(us)	EndBurst Interval(us)
1	100822	3	9	75	1045	1343	1033	100822	0	666666
2	948871	2	8	95	1945	1705	0	1053114	666667	1333333
3	365822	1	16	65	1994	0	0	1422586	1333334	2000000
4	801658	2	13	90	1198	1084	0	2226238	2000001	2666667
5	999629	1	6	90	1653	0	0	3228149	2666668	3333334
6	283234	1	20	85	1660	0	0	3513036	3333335	4000001
7	908705	2	7	65	1557	1496	0	4423401	4000002	4666668
8	573505	3	10	80	1192	1897	1895	4999959	4666669	5333335
9	884417	1	15	85	1074	0	0	5889360	5333336	6000002
10	345723	1	7	60	1767	0	0	6236157	6000003	6666669
11	497998	3	7	65	1683	1844	1739	6735922	6666670	7333336
12	1195876	1	14	50	1750	0	0	7937064	7333337	8000003
13	433187	1	11	70	1881	0	0	8372001	8000004	8666670
14	714391	2	10	70	1332	1417	0	9088273	8666671	9333337
15	519836	1	13	50	1271	0	0	9610858	9333338	10000004
16	688373	2	10	80	1481	1485	0	10300502	10000005	10666671
17	470602	3	12	50	1510	1734	1582	10774070	10666672	11333338
18	909139	3	5	90	1704	1639	1464	11688035	11333339	12000005
Total	number	of	pulses	in	waveform	=	33			

Unless otherwise stated the results shown in this test report refer only to the sample(s) tested and such sample(s) are retained for 90 days only.

除非另有說明，此報告結果僅對測試之樣品負責，同時此樣品僅保留90天。本報告未經本公司書面許可，不可部份複製。

This document is issued by the Company subject to its General Conditions of Service printed overleaf, available on request or accessible at www.sgs.com/terms_and_conditions.htm and, for electronic format documents, subject to Terms and Conditions for Electronic Documents at www.sgs.com/terms_e-document.htm. Attention is drawn to the limitation of liability, indemnification and jurisdiction issues defined therein. Any holder of this document is advised that information contained hereon reflects the Company's findings at the time of its intervention only and within the limits of Client's instructions, if any. The Company's sole responsibility is to its Client and this document does not exonerate parties to a transaction from exercising all their rights and obligations under the transaction documents. This document cannot be reproduced except in full, without prior written approval of the Company. Any unauthorized alteration, forgery or falsification of the content or appearance of this document is unlawful and offenders may be prosecuted to the fullest extent of the law.

SGS Taiwan Ltd.

No.134,WuKungRoad,NewTaipeiIndustrialPark,WukuDistrict,NewTaipeiCity,Taiwan24803/新北市五股區新北產業園區五工路 134 號

台灣檢驗科技股份有限公司

t (886-2) 2299-3279

f (886-2) 2298-0488

www.tw.sgs.com

Member of SGS Group

Radar Type 5 for 802.11a 5300 MHz

Wave form Num = 8
Num of Bursts = 15
Burst Interval (us) = 800000

Burst #	OffTime (us)	# Pulses	Chirp (MHz)	PW (us)	Pulse1 Pri(us)	Pulse2 Pri(us)	Pulse3 Pri(us)	StartLoc (us)	StartBurst Interval(us)	EndBurst Interval(us)
1	525671	1	19	50	1036	0	0	525671	0	799999
2	689989	3	13	70	1145	1187	1383	1216696	800000	1599999
3	482840	3	17	85	1640	1688	1000	1703251	1600000	2399999
4	1176805	1	11	75	1461	0	0	2884384	2400000	3199999
5	817599	2	12	60	1639	1375	0	3703444	3200000	3999999
6	715584	3	15	85	1077	1943	1656	4422042	4000000	4799999
7	1148589	1	13	90	1875	0	0	5575307	4800000	5599999
8	591086	1	5	50	1809	0	0	6168268	5600000	6399999
9	234139	1	6	80	1886	0	0	6404216	6400000	7199999
10	840330	3	12	70	1674	1337	1287	7246432	7200000	7999999
11	1021248	2	12	75	1491	1155	0	8271978	8000000	8799999
12	700627	2	15	60	1876	1078	0	8975251	8800000	9599999
13	811410	1	18	65	1386	0	0	9789615	9600000	10399999
14	1007397	2	8	95	1625	1126	0	10798398	10400000	11199999
15	517538	1	11	90	1518	0	0	11318687	11200000	11999999
Total	number	of	pulses	in	waveform	=	27			

Radar Type 5 for 802.11a 5300 MHz

Wave form Num = 9
Num of Bursts = 11
Burst Interval (us) = 1E+06

Burst #	OffTime (us)	# Pulses	Chirp (MHz)	PW (us)	Pulse1 Pri(us)	Pulse2 Pri(us)	Pulse3 Pri(us)	StartLoc (us)	StartBurst Interval(us)	EndBurst Interval(us)
1	747812	3	5	75	1379	1924	1679	747812	0	1090908
2	956591	2	11	95	1525	1941	0	1709385	1090909	2181817
3	1405755	1	20	65	1788	0	0	3118606	2181818	3272726
4	1148865	2	10	55	1561	1632	0	4269259	3272727	4363635
5	385463	2	14	65	1971	1187	0	4657915	4363636	5454544
6	1060385	1	9	65	1346	0	0	5721458	5454545	6545453
7	1718857	3	16	50	1310	1420	1378	7441661	6545454	7636362
8	393265	3	17	75	1097	1714	1097	7839034	7636363	8727271
9	1268520	2	18	50	1561	1610	0	9111462	8727272	9818180
10	1357174	1	15	85	1382	0	0	10471807	9818181	10909089
11	1391277	3	9	80	1050	1801	1122	11864466	10909090	11999998
Total	number	of	pulses	in	waveform	=	23			

Unless otherwise stated the results shown in this test report refer only to the sample(s) tested and such sample(s) are retained for 90 days only.

除非另有說明，此報告結果僅對測試之樣品負責，同時此樣品僅保留90天。本報告未經本公司書面許可，不可部份複製。

This document is issued by the Company subject to its General Conditions of Service printed overleaf, available on request or accessible at www.sgs.com/terms_and_conditions.htm and, for electronic format documents, subject to Terms and Conditions for Electronic Documents at www.sgs.com/terms_e-document.htm. Attention is drawn to the limitation of liability, indemnification and jurisdiction issues defined therein. Any holder of this document is advised that information contained hereon reflects the Company's findings at the time of its intervention only and within the limits of Client's instructions, if any. The Company's sole responsibility is to its Client and this document does not exonerate parties to a transaction from exercising all their rights and obligations under the transaction documents. This document cannot be reproduced except in full, without prior written approval of the Company. Any unauthorized alteration, forgery or falsification of the content or appearance of this document is unlawful and offenders may be prosecuted to the fullest extent of the law.

SGS Taiwan Ltd.

No.134,WuKungRoad,NewTaipeiIndustrialPark,WukuDistrict,NewTaipeiCity,Taiwan24803/新北市五股區新北產業園區五工路 134 號

台灣檢驗科技股份有限公司

t (886-2) 2299-3279

f (886-2) 2298-0488

www.tw.sgs.com

Member of SGS Group

Radar Type 5 for 802.11a 5300 MHz

Wave form Num = 10
Num of Bursts = 10
Burst Interval (us) = 1E+06

Burst #	OffTime (us)	# Pulses	Chirp (MHz)	PW (us)	Pulse1 Pri(us)	Pulse2 Pri(us)	Pulse3 Pri(us)	StartLoc (us)	StartBurst Interval(us)	EndBurst Interval(us)
1	105027	3	20	75	1044	1171	1448	105027	0	1199999
2	1921941	2	12	60	1831	1171	0	2030631	1200000	2399999
3	894813	3	13	65	1706	1146	1833	2928446	2400000	3599999
4	1275314	2	14	85	1336	1766	0	4208445	3600000	4799999
5	1406612	2	19	50	1750	1679	0	5618159	4800000	5999999
6	599658	1	6	65	1773	0	0	6221246	6000000	7199999
7	2006448	3	17	55	1484	1292	1460	8229467	7200000	8399999
8	836811	3	10	95	1189	1260	1360	9070514	8400000	9599999
9	1632442	1	16	50	1255	0	0	10706765	9600000	10799999
10	592020	1	7	80	1257	0	0	11300040	10800000	11999999
Total	number	of	pulses	in	waveform	=	21			

Radar Type 5 for 802.11a 5300 MHz

Wave form Num = 11
Num of Bursts = 16
Burst Interval (us) = 750000

Burst #	OffTime (us)	# Pulses	Chirp (MHz)	PW (us)	Pulse1 Pri(us)	Pulse2 Pri(us)	Pulse3 Pri(us)	StartLoc (us)	StartBurst Interval(us)	EndBurst Interval(us)
1	180248	3	10	95	1296	1782	1403	180248	0	749999
2	734165	3	10	95	1025	1482	1448	918894	750000	1499999
3	680672	3	13	65	1737	1409	1540	1603521	1500000	2249999
4	1110940	1	6	90	1703	0	0	2719147	2250000	2999999
5	467116	3	11	80	1076	1095	1117	3187966	3000000	3749999
6	852373	3	13	100	1638	1600	1347	4043627	3750000	4499999
7	802324	3	13	75	1616	1354	1589	4850536	4500000	5249999
8	1074121	1	5	50	1079	0	0	5929216	5250000	5999999
9	405664	3	7	85	1618	1636	1628	6335959	6000000	6749999
10	634468	3	19	50	1206	1132	1168	6975309	6750000	7499999
11	1234543	1	8	95	1047	0	0	8213358	7500000	8249999
12	633793	3	10	70	1420	1677	1727	8848198	8250000	8999999
13	539944	3	7	75	1314	1010	1741	9392966	9000000	9749999
14	664027	3	10	60	1327	1603	1382	10061058	9750000	10499999
15	1080019	2	16	55	1893	1101	0	11145389	10500000	11249999
16	840313	2	17	70	1652	1338	0	11988696	11250000	11999999
Total	number	of	pulses	in	waveform	=	40			

Unless otherwise stated the results shown in this test report refer only to the sample(s) tested and such sample(s) are retained for 90 days only.

除非另有說明，此報告結果僅對測試之樣品負責，同時此樣品僅保留90天。本報告未經本公司書面許可，不可部份複製。

This document is issued by the Company subject to its General Conditions of Service printed overleaf, available on request or accessible at www.sgs.com/terms_and_conditions.htm and, for electronic format documents, subject to Terms and Conditions for Electronic Documents at www.sgs.com/terms_e-document.htm. Attention is drawn to the limitation of liability, indemnification and jurisdiction issues defined therein. Any holder of this document is advised that information contained hereon reflects the Company's findings at the time of its intervention only and within the limits of Client's instructions, if any. The Company's sole responsibility is to its Client and this document does not exonerate parties to a transaction from exercising all their rights and obligations under the transaction documents. This document cannot be reproduced except in full, without prior written approval of the Company. Any unauthorized alteration, forgery or falsification of the content or appearance of this document is unlawful and offenders may be prosecuted to the fullest extent of the law.

SGS Taiwan Ltd.

No.134,WuKungRoad,NewTaipeiIndustrialPark,WukuDistrict,NewTaipeiCity,Taiwan24803/新北市五股區新北產業園區五工路 134 號

台灣檢驗科技股份有限公司

t (886-2) 2299-3279

f (886-2) 2298-0488

www.tw.sgs.com

Member of SGS Group

Radar Type 5 for 802.11a 5300 MHz

Wave form Num = 12
Num of Bursts = 17
Burst Interval (us) = 705882

Burst #	OffTime (us)	# Pulses	Chirp (MHz)	PW (us)	Pulse1 Pri(us)	Pulse2 Pri(us)	Pulse3 Pri(us)	StartLoc (us)	StartBurst Interval(us)	EndBurst Interval(us)
1	504947	2	16	60	1339	1903	0	504947	0	705881
2	653299	3	16	90	1216	1987	1204	1161488	705882	1411763
3	583293	3	9	100	1550	1815	1292	1749188	1411764	2117645
4	915668	3	12	55	1228	1203	1168	2669513	2117646	2823527
5	665618	3	15	55	1953	1273	1792	3338730	2823528	3529409
6	641424	2	11	80	1137	1155	0	3985172	3529410	4235291
7	818922	1	9	95	1198	0	0	4806386	4235292	4941173
8	469162	1	9	50	1781	0	0	5276746	4941174	5647055
9	890463	1	17	60	1594	0	0	6168990	5647056	6352937
10	655403	1	15	60	1422	0	0	6825987	6352938	7058819
11	637751	3	6	55	1114	1442	1262	7465160	7058820	7764701
12	813325	3	14	95	1755	1688	1586	8282303	7764702	8470583
13	851408	3	19	55	1871	1364	1296	9138740	8470584	9176465
14	273239	2	7	70	1999	1175	0	9416510	9176466	9882347
15	967343	1	9	100	1071	0	0	10387027	9882348	10588229
16	807325	3	10	70	1824	1738	1104	11195423	10588230	11294111
17	322388	2	18	55	1896	1353	0	11522477	11294112	11999993
Total	number	of	pulses	in	waveform	=	37			

Unless otherwise stated the results shown in this test report refer only to the sample(s) tested and such sample(s) are retained for 90 days only.

除非另有說明，此報告結果僅對測試之樣品負責，同時此樣品僅保留90天。本報告未經本公司書面許可，不可部份複製。

This document is issued by the Company subject to its General Conditions of Service printed overleaf, available on request or accessible at www.sgs.com/terms_and_conditions.htm and, for electronic format documents, subject to Terms and Conditions for Electronic Documents at www.sgs.com/terms_e-document.htm. Attention is drawn to the limitation of liability, indemnification and jurisdiction issues defined therein. Any holder of this document is advised that information contained hereon reflects the Company's findings at the time of its intervention only and within the limits of Client's instructions, if any. The Company's sole responsibility is to its Client and this document does not exonerate parties to a transaction from exercising all their rights and obligations under the transaction documents. This document cannot be reproduced except in full, without prior written approval of the Company. Any unauthorized alteration, forgery or falsification of the content or appearance of this document is unlawful and offenders may be prosecuted to the fullest extent of the law.

SGS Taiwan Ltd.

No.134,WuKungRoad,NewTaipeiIndustrialPark,WukuDistrict,NewTaipeiCity,Taiwan24803/新北市五股區新北產業園區五工路 134 號

台灣檢驗科技股份有限公司

t (886-2) 2299-3279

f (886-2) 2298-0488

www.tw.sgs.com

Member of SGS Group

Radar Type 5 for 802.11a 5300 MHz

Wave form Num = 13
Num of Bursts = 17
Burst Interval (us) = 705882

Burst #	OffTime (us)	# Pulses	Chirp (MHz)	PW (us)	Pulse1 Pri(us)	Pulse2 Pri(us)	Pulse3 Pri(us)	StartLoc (us)	StartBurst Interval(us)	EndBurst Interval(us)
1	268623	3	14	100	1302	1370	1382	268623	0	705881
2	1124262	1	12	100	1217	0	0	1396939	705882	1411763
3	378171	2	17	50	1203	1954	0	1776327	1411764	2117645
4	510626	1	15	75	1760	0	0	2290110	2117646	2823527
5	651754	2	6	60	1840	1775	0	2943624	2823528	3529409
6	906014	3	5	90	1704	1234	1020	3853253	3529410	4235291
7	884552	3	14	100	1542	1132	1890	4741763	4235292	4941173
8	647804	3	17	75	1360	1441	1742	5394131	4941174	5647055
9	944688	1	15	50	1153	0	0	6343362	5647056	6352937
10	517441	2	11	70	1352	1748	0	6861956	6352938	7058819
11	508364	3	13	85	1026	1884	1216	7373420	7058820	7764701
12	389600	1	17	100	1899	0	0	7767146	7764702	8470583
13	917019	2	12	60	1683	1509	0	8686064	8470584	9176465
14	616517	1	17	65	1931	0	0	9305773	9176466	9882347
15	687672	2	9	95	1547	1248	0	9995376	9882348	10588229
16	1155207	1	11	75	1144	0	0	11153378	10588230	11294111
17	486248	2	11	80	1458	1544	0	11640770	11294112	11999993
Total	number	of	pulses	in	waveform	=	33			

Unless otherwise stated the results shown in this test report refer only to the sample(s) tested and such sample(s) are retained for 90 days only.

除非另有說明，此報告結果僅對測試之樣品負責，同時此樣品僅保留90天。本報告未經本公司書面許可，不可部份複製。

This document is issued by the Company subject to its General Conditions of Service printed overleaf, available on request or accessible at www.sgs.com/terms_and_conditions.htm and, for electronic format documents, subject to Terms and Conditions for Electronic Documents at www.sgs.com/terms_e-document.htm. Attention is drawn to the limitation of liability, indemnification and jurisdiction issues defined therein. Any holder of this document is advised that information contained hereon reflects the Company's findings at the time of its intervention only and within the limits of Client's instructions, if any. The Company's sole responsibility is to its Client and this document does not exonerate parties to a transaction from exercising all their rights and obligations under the transaction documents. This document cannot be reproduced except in full, without prior written approval of the Company. Any unauthorized alteration, forgery or falsification of the content or appearance of this document is unlawful and offenders may be prosecuted to the fullest extent of the law.

SGS Taiwan Ltd.

No.134,WuKungRoad,NewTaipeiIndustrialPark,WukuDistrict,NewTaipeiCity,Taiwan24803/新北市五股區新北產業園區五工路 134 號

台灣檢驗科技股份有限公司

t (886-2) 2299-3279

f (886-2) 2298-0488

www.tw.sgs.com

Member of SGS Group

Radar Type 5 for 802.11a 5300 MHz

Wave form Num = 14
Num of Bursts = 20
Burst Interval (us) = 600000

Burst #	OffTime (us)	# Pulses	Chirp (MHz)	PW (us)	Pulse1 Pri(us)	Pulse2 Pri(us)	Pulse3 Pri(us)	StartLoc (us)	StartBurst Interval(us)	EndBurst Interval(us)
1	429180	3	17	60	1742	1497	1531	429180	0	599999
2	318541	3	16	85	1087	1459	1217	752491	600000	1199999
3	858807	2	15	70	1236	1792	0	1615061	1200000	1799999
4	711693	3	7	85	1229	1205	1149	2329782	1800000	2399999
5	483567	2	11	95	1490	1983	0	2816932	2400000	2999999
6	328584	3	11	100	1798	1765	1614	3148989	3000000	3599999
7	553415	2	10	70	1741	1642	0	3707581	3600000	4199999
8	755694	1	13	75	1039	0	0	4466658	4200000	4799999
9	684645	2	5	65	1482	1096	0	5152342	4800000	5399999
10	839149	1	6	55	1101	0	0	5994069	5400000	5999999
11	290744	1	10	100	1112	0	0	6285914	6000000	6599999
12	549031	3	17	55	1407	1333	1842	6836057	6600000	7199999
13	737469	3	11	55	1166	1724	1476	7578108	7200000	7799999
14	679902	3	10	100	1708	1704	1784	8262376	7800000	8399999
15	535563	3	16	55	1758	1335	1865	8803135	8400000	8999999
16	453061	2	6	60	1112	1968	0	9261154	9000000	9599999
17	646082	3	9	75	1216	1687	1561	9910316	9600000	10199999
18	546280	2	12	85	1992	1264	0	10461060	10200000	10799999
19	767407	1	18	100	1632	0	0	11231723	10800000	11399999
20	595711	3	8	50	1527	1336	1991	11829066	11400000	11999999
Total	number	of	pulses	in	waveform	=	46			

Radar Type 5 for 802.11a 5300 MHz

Wave form Num = 15
Num of Bursts = 10
Burst Interval (us) = 1E+06

Burst #	OffTime (us)	# Pulses	Chirp (MHz)	PW (us)	Pulse1 Pri(us)	Pulse2 Pri(us)	Pulse3 Pri(us)	StartLoc (us)	StartBurst Interval(us)	EndBurst Interval(us)
1	622919	2	20	90	1041	1393	0	622919	0	1199999
2	888534	2	13	100	1982	1589	0	1513887	1200000	2399999
3	1437498	1	8	75	1756	0	0	2954956	2400000	3599999
4	1668223	2	8	50	1421	1257	0	4624935	3600000	4799999
5	720032	3	13	90	1523	1179	1280	5347645	4800000	5999999
6	1759307	2	8	55	1053	1287	0	7110934	6000000	7199999
7	1238402	2	11	50	1645	1790	0	8351676	7200000	8399999
8	545462	2	14	70	1788	1062	0	8900573	8400000	9599999
9	1158099	1	16	60	2000	0	0	10061522	9600000	10799999
10	1894758	3	5	80	2000	1483	1552	11958280	10800000	11999999
Total	number	of	pulses	in	waveform	=	20			

Unless otherwise stated the results shown in this test report refer only to the sample(s) tested and such sample(s) are retained for 90 days only.

除非另有說明，此報告結果僅對測試之樣品負責，同時此樣品僅保留90天。本報告未經本公司書面許可，不可部份複製。

This document is issued by the Company subject to its General Conditions of Service printed overleaf, available on request or accessible at www.sgs.com/terms_and_conditions.htm and, for electronic format documents, subject to Terms and Conditions for Electronic Documents at www.sgs.com/terms_e-document.htm. Attention is drawn to the limitation of liability, indemnification and jurisdiction issues defined therein. Any holder of this document is advised that information contained hereon reflects the Company's findings at the time of its intervention only and within the limits of Client's instructions, if any. The Company's sole responsibility is to its Client and this document does not exonerate parties to a transaction from exercising all their rights and obligations under the transaction documents. This document cannot be reproduced except in full, without prior written approval of the Company. Any unauthorized alteration, forgery or falsification of the content or appearance of this document is unlawful and offenders may be prosecuted to the fullest extent of the law.

SGS Taiwan Ltd.

No.134,WuKungRoad,NewTaipeiIndustrialPark,WukuDistrict,NewTaipeiCity,Taiwan24803/新北市五股區新北產業園區五工路 134 號

台灣檢驗科技股份有限公司

t (886-2) 2299-3279

f (886-2) 2298-0488

www.tw.sgs.com

Member of SGS Group

Radar Type 5 for 802.11a 5300 MHz

Wave form Num = 16
Num of Bursts = 10
Burst Interval (us) = 1E+06

Burst #	OffTime (us)	# Pulses	Chirp (MHz)	PW (us)	Pulse1 Pri(us)	Pulse2 Pri(us)	Pulse3 Pri(us)	StartLoc (us)	StartBurst Interval(us)	EndBurst Interval(us)
1	319220	1	7	85	1766	0	0	319220	0	1199999
2	2023304	2	5	70	1552	1910	0	2344290	1200000	2399999
3	740892	3	13	60	1381	1402	1917	3088644	2400000	3599999
4	638164	1	6	100	1608	0	0	3731508	3600000	4799999
5	1855277	2	15	75	1911	1108	0	5588393	4800000	5999999
6	412488	2	14	95	1220	1483	0	6003900	6000000	7199999
7	1880083	3	8	95	1719	1485	1876	7886686	7200000	8399999
8	1025549	1	9	55	1832	0	0	8917315	8400000	9599999
9	1211806	3	19	65	1938	1070	1144	10130953	9600000	10799999
10	1006317	1	14	65	1254	0	0	11141422	10800000	11999999
Total	number	of	pulses	in	waveform	=	19			

Radar Type 5 for 802.11a 5300 MHz

Wave form Num = 17
Num of Bursts = 18
Burst Interval (us) = 666667

Burst #	OffTime (us)	# Pulses	Chirp (MHz)	PW (us)	Pulse1 Pri(us)	Pulse2 Pri(us)	Pulse3 Pri(us)	StartLoc (us)	StartBurst Interval(us)	EndBurst Interval(us)
1	547285	3	8	100	1646	1304	1052	547285	0	666666
2	568672	3	8	75	1109	1746	1800	1119959	666667	1333333
3	674258	1	8	75	1409	0	0	1798872	1333334	2000000
4	576172	1	10	95	1281	0	0	2376453	2000001	2666667
5	621227	1	10	60	1953	0	0	2998961	2666668	3333334
6	470515	2	7	65	1282	1980	0	3471429	3333335	4000001
7	1024120	3	19	70	1651	1063	1771	4498811	4000002	4666668
8	233595	3	16	95	1740	1503	1145	4736891	4666669	5333335
9	1059198	2	15	75	1759	1891	0	5800477	5333336	6000002
10	233178	1	8	95	1795	0	0	6037305	6000003	6666669
11	1016560	3	6	50	1057	1018	1813	7055660	6666670	7333336
12	625856	1	6	55	1462	0	0	7685404	7333337	8000003
13	866198	3	7	55	1210	1565	1911	8553064	8000004	8666670
14	256515	2	10	50	1621	1156	0	8814265	8666671	9333337
15	972136	3	8	80	1483	1363	1603	9789178	9333338	10000004
16	699707	3	17	65	1622	1564	1469	10493334	10000005	10666671
17	404943	2	17	80	1416	1817	0	10902932	10666672	11333338
18	576276	2	8	60	1920	1479	0	11482441	11333339	12000005
Total	number	of	pulses	in	waveform	=	39			

Unless otherwise stated the results shown in this test report refer only to the sample(s) tested and such sample(s) are retained for 90 days only.

除非另有說明，此報告結果僅對測試之樣品負責，同時此樣品僅保留90天。本報告未經本公司書面許可，不可部份複製。

This document is issued by the Company subject to its General Conditions of Service printed overleaf, available on request or accessible at www.sgs.com/terms_and_conditions.htm and, for electronic format documents, subject to Terms and Conditions for Electronic Documents at www.sgs.com/terms_e-document.htm. Attention is drawn to the limitation of liability, indemnification and jurisdiction issues defined therein. Any holder of this document is advised that information contained hereon reflects the Company's findings at the time of its intervention only and within the limits of Client's instructions, if any. The Company's sole responsibility is to its Client and this document does not exonerate parties to a transaction from exercising all their rights and obligations under the transaction documents. This document cannot be reproduced except in full, without prior written approval of the Company. Any unauthorized alteration, forgery or falsification of the content or appearance of this document is unlawful and offenders may be prosecuted to the fullest extent of the law.

SGS Taiwan Ltd.

No.134,WuKungRoad,NewTaipeiIndustrialPark,WukuDistrict,NewTaipeiCity,Taiwan24803/新北市五股區新北產業園區五工路 134 號

台灣檢驗科技股份有限公司

t (886-2) 2299-3279

f (886-2) 2298-0488

www.tw.sgs.com

Member of SGS Group

Radar Type 5 for 802.11a 5300 MHz

Wave form Num = 18
Num of Bursts = 13
Burst Interval (us) = 923077

Burst #	OffTime (us)	# Pulses	Chirp (MHz)	PW (us)	Pulse1 Pri(us)	Pulse2 Pri(us)	Pulse3 Pri(us)	StartLoc (us)	StartBurst Interval(us)	EndBurst Interval(us)
1	904249	2	6	60	1099	1302	0	904249	0	923076
2	600546	1	19	60	1379	0	0	1507196	923077	1846153
3	881144	2	11	70	1832	1738	0	2389719	1846154	2769230
4	1143968	1	17	55	1166	0	0	3537257	2769231	3692307
5	760601	2	13	70	1636	1364	0	4299024	3692308	4615384
6	810206	1	7	65	1492	0	0	5112230	4615385	5538461
7	527109	3	7	65	1612	1000	1367	5640831	5538462	6461538
8	1019272	1	17	65	1866	0	0	6664082	6461539	7384615
9	1630475	1	19	75	1944	0	0	8296423	7384616	8307692
10	686232	1	20	60	1644	0	0	8984599	8307693	9230769
11	915674	1	16	85	1569	0	0	9901917	9230770	10153846
12	447910	3	5	60	1925	1604	1496	10351396	10153847	11076923
13	927392	1	20	55	1255	0	0	11283813	11076924	12000000
Total	number	of	pulses	in	waveform	=	20			

Unless otherwise stated the results shown in this test report refer only to the sample(s) tested and such sample(s) are retained for 90 days only.

除非另有說明，此報告結果僅對測試之樣品負責，同時此樣品僅保留90天。本報告未經本公司書面許可，不可部份複製。

This document is issued by the Company subject to its General Conditions of Service printed overleaf, available on request or accessible at www.sgs.com/terms_and_conditions.htm and, for electronic format documents, subject to Terms and Conditions for Electronic Documents at www.sgs.com/terms_e-document.htm. Attention is drawn to the limitation of liability, indemnification and jurisdiction issues defined therein. Any holder of this document is advised that information contained hereon reflects the Company's findings at the time of its intervention only and within the limits of Client's instructions, if any. The Company's sole responsibility is to its Client and this document does not exonerate parties to a transaction from exercising all their rights and obligations under the transaction documents. This document cannot be reproduced except in full, without prior written approval of the Company. Any unauthorized alteration, forgery or falsification of the content or appearance of this document is unlawful and offenders may be prosecuted to the fullest extent of the law.

SGS Taiwan Ltd.

No.134,WuKungRoad,NewTaipeiIndustrialPark,WukuDistrict,NewTaipeiCity,Taiwan24803/新北市五股區新北產業園區五工路 134 號

台灣檢驗科技股份有限公司

t (886-2) 2299-3279

f (886-2) 2298-0488

www.tw.sgs.com

Member of SGS Group

Radar Type 5 for 802.11a 5300 MHz

Wave form Num = 19
Num of Bursts = 19
Burst Interval (us) = 631579

Burst #	OffTime (us)	# Pulses	Chirp (MHz)	PW (us)	Pulse1 Pri(us)	Pulse2 Pri(us)	Pulse3 Pri(us)	StartLoc (us)	StartBurst Interval(us)	EndBurst Interval(us)
1	230619	3	10	70	1501	1510	1811	230619	0	631578
2	940894	1	6	95	1651	0	0	1176335	631579	1263157
3	364586	2	8	60	1708	1553	0	1542572	1263158	1894736
4	769062	3	16	80	1414	1070	1357	2314895	1894737	2526315
5	485542	2	15	65	1050	1738	0	2804278	2526316	3157894
6	507847	3	15	80	1667	1557	1853	3314913	3157895	3789473
7	769928	2	11	55	1034	1827	0	4089918	3789474	4421052
8	337498	2	9	55	1562	1343	0	4430277	4421053	5052631
9	640765	2	17	55	1965	1131	0	5073947	5052632	5684210
10	640065	1	20	80	1214	0	0	5717108	5684211	6315789
11	666273	2	5	55	1770	1922	0	6384595	6315790	6947368
12	689383	1	10	70	1874	0	0	7077670	6947369	7578947
13	1001857	2	16	80	1638	1723	0	8081401	7578948	8210526
14	167588	1	16	70	1935	0	0	8252350	8210527	8842105
15	625792	2	19	95	1429	1254	0	8880077	8842106	9473684
16	1004292	3	15	55	1303	1043	1326	9887052	9473685	10105263
17	410743	1	19	90	1661	0	0	10301467	10105264	10736842
18	1008171	2	14	85	1571	1669	0	11311299	10736843	11368421
19	449249	1	20	95	1397	0	0	11763788	11368422	12000000
Total	number	of	pulses	in	waveform	=	36			

Unless otherwise stated the results shown in this test report refer only to the sample(s) tested and such sample(s) are retained for 90 days only.

除非另有說明，此報告結果僅對測試之樣品負責，同時此樣品僅保留90天。本報告未經本公司書面許可，不可部份複製。

This document is issued by the Company subject to its General Conditions of Service printed overleaf, available on request or accessible at www.sgs.com/terms_and_conditions.htm and, for electronic format documents, subject to Terms and Conditions for Electronic Documents at www.sgs.com/terms_e-document.htm. Attention is drawn to the limitation of liability, indemnification and jurisdiction issues defined therein. Any holder of this document is advised that information contained hereon reflects the Company's findings at the time of its intervention only and within the limits of Client's instructions, if any. The Company's sole responsibility is to its Client and this document does not exonerate parties to a transaction from exercising all their rights and obligations under the transaction documents. This document cannot be reproduced except in full, without prior written approval of the Company. Any unauthorized alteration, forgery or falsification of the content or appearance of this document is unlawful and offenders may be prosecuted to the fullest extent of the law.

SGS Taiwan Ltd.

No.134,WuKungRoad,NewTaipeiIndustrialPark,WukuDistrict,NewTaipeiCity,Taiwan24803/新北市五股區新北產業園區五工路 134 號

台灣檢驗科技股份有限公司

t (886-2) 2299-3279

f (886-2) 2298-0488

www.tw.sgs.com

Member of SGS Group

Radar Type 5 for 802.11a 5300 MHz

Wave form Num = 20
Num of Bursts = 16
Burst Interval (us) = 750000

Burst #	OffTime (us)	# Pulses	Chirp (MHz)	PW (us)	Pulse1 Pri(us)	Pulse2 Pri(us)	Pulse3 Pri(us)	StartLoc (us)	StartBurst Interval(us)	EndBurst Interval(us)
1	204515	1	17	50	1941	0	0	204515	0	749999
2	679501	3	17	65	1586	1643	1620	885957	750000	1499999
3	1255196	1	12	75	1963	0	0	2146002	1500000	2249999
4	524734	3	7	95	1122	1614	1726	2672699	2250000	2999999
5	845972	3	17	95	1709	1048	1644	3523133	3000000	3749999
6	713412	3	8	100	1586	1722	1778	4240946	3750000	4499999
7	514297	2	8	70	1562	1380	0	4760329	4500000	5249999
8	554076	2	20	90	1324	1093	0	5317347	5250000	5999999
9	1260731	3	7	80	1662	1818	1583	6580495	6000000	6749999
10	849906	1	18	60	1675	0	0	7435464	6750000	7499999
11	734343	2	6	85	1763	1738	0	8171482	7500000	8249999
12	753446	2	16	65	1299	1911	0	8928429	8250000	8999999
13	491924	1	18	90	1120	0	0	9423563	9000000	9749999
14	911199	2	8	50	1172	1006	0	10335882	9750000	10499999
15	513928	1	6	60	1295	0	0	10851988	10500000	11249999
16	664862	1	17	80	1541	0	0	11518145	11250000	11999999
Total	number	of	pulses	in	waveform	=	31			

Radar Type 5 for 802.11a 5300 MHz

Wave form Num = 21
Num of Bursts = 8
Burst Interval (us) = 2E+06

Burst #	OffTime (us)	# Pulses	Chirp (MHz)	PW (us)	Pulse1 Pri(us)	Pulse2 Pri(us)	Pulse3 Pri(us)	StartLoc (us)	StartBurst Interval(us)	EndBurst Interval(us)
1	1269615	1	6	90	1397	0	0	1269615	0	1499999
2	269634	1	19	70	1713	0	0	1540646	1500000	2999999
3	2025840	1	11	100	1959	0	0	3568199	3000000	4499999
4	1278975	1	12	65	1027	0	0	4849133	4500000	5999999
5	1534833	3	10	100	1802	1282	1159	6384993	6000000	7499999
6	1446228	3	9	55	1563	1446	1388	7835464	7500000	8999999
7	1219131	2	15	85	1912	1032	0	9058992	9000000	10499999
8	1555662	1	6	60	1488	0	0	10617598	10500000	11999999
Total	number	of	pulses	in	waveform	=	13			

Unless otherwise stated the results shown in this test report refer only to the sample(s) tested and such sample(s) are retained for 90 days only.

除非另有說明，此報告結果僅對測試之樣品負責，同時此樣品僅保留90天。本報告未經本公司書面許可，不可部份複製。

This document is issued by the Company subject to its General Conditions of Service printed overleaf, available on request or accessible at www.sgs.com/terms_and_conditions.htm and, for electronic format documents, subject to Terms and Conditions for Electronic Documents at www.sgs.com/terms_e-document.htm. Attention is drawn to the limitation of liability, indemnification and jurisdiction issues defined therein. Any holder of this document is advised that information contained hereon reflects the Company's findings at the time of its intervention only and within the limits of Client's instructions, if any. The Company's sole responsibility is to its Client and this document does not exonerate parties to a transaction from exercising all their rights and obligations under the transaction documents. This document cannot be reproduced except in full, without prior written approval of the Company. Any unauthorized alteration, forgery or falsification of the content or appearance of this document is unlawful and offenders may be prosecuted to the fullest extent of the law.

SGS Taiwan Ltd.

No.134,WuKungRoad,NewTaipeiIndustrialPark,WukuDistrict,NewTaipeiCity,Taiwan24803/新北市五股區新北產業園區五工路 134 號

台灣檢驗科技股份有限公司

t (886-2) 2299-3279

f (886-2) 2298-0488

www.tw.sgs.com

Member of SGS Group

Radar Type 5 for 802.11a 5300 MHz

Wave form Num = 22
Num of Bursts = 11
Burst Interval (us) = 1E+06

Burst #	OffTime (us)	# Pulses	Chirp (MHz)	PW (us)	Pulse1 Pri(us)	Pulse2 Pri(us)	Pulse3 Pri(us)	StartLoc (us)	StartBurst Interval(us)	EndBurst Interval(us)
1	357360	2	13	75	1923	1426	0	357360	0	1090908
2	1609852	2	11	90	1841	1449	0	1970561	1090909	2181817
3	808460	3	9	80	1425	1115	1423	2782311	2181818	3272726
4	1275237	2	14	75	1017	1604	0	4061511	3272727	4363635
5	465288	2	7	60	1980	1651	0	4529420	4363636	5454544
6	1815877	2	11	90	1114	1067	0	6348928	5454545	6545453
7	567377	2	6	75	1753	1251	0	6918486	6545454	7636362
8	1264954	3	7	95	1110	1022	1873	8186444	7636363	8727271
9	946986	1	13	90	1702	0	0	9137435	8727272	9818180
10	1450826	1	15	60	1240	0	0	10589963	9818181	10909089
11	1288724	2	9	60	1561	1500	0	11879927	10909090	11999998
Total	number	of	pulses	in	waveform	=	22			

Radar Type 5 for 802.11a 5300 MHz

Wave form Num = 23
Num of Bursts = 11
Burst Interval (us) = 1E+06

Burst #	OffTime (us)	# Pulses	Chirp (MHz)	PW (us)	Pulse1 Pri(us)	Pulse2 Pri(us)	Pulse3 Pri(us)	StartLoc (us)	StartBurst Interval(us)	EndBurst Interval(us)
1	902722	2	19	70	1822	1213	0	902722	0	1090908
2	1243334	2	19	95	1654	1003	0	2149091	1090909	2181817
3	668778	2	14	75	1975	1149	0	2820526	2181818	3272726
4	603737	1	7	100	1253	0	0	3427387	3272727	4363635
5	1480616	2	17	80	1222	1302	0	4909256	4363636	5454544
6	719225	1	17	100	1732	0	0	5631005	5454545	6545453
7	1876488	2	6	70	1914	1087	0	7509225	6545454	7636362
8	719567	3	20	50	1547	1373	1839	8231793	7636363	8727271
9	857968	1	19	70	1128	0	0	9094520	8727272	9818180
10	1520352	2	14	100	1237	1814	0	10616000	9818181	10909089
11	926610	3	12	90	1184	1030	1284	11545661	10909090	11999998
Total	number	of	pulses	in	waveform	=	21			

Unless otherwise stated the results shown in this test report refer only to the sample(s) tested and such sample(s) are retained for 90 days only.

除非另有說明，此報告結果僅對測試之樣品負責，同時此樣品僅保留90天。本報告未經本公司書面許可，不可部份複製。

This document is issued by the Company subject to its General Conditions of Service printed overleaf, available on request or accessible at www.sgs.com/terms_and_conditions.htm and, for electronic format documents, subject to Terms and Conditions for Electronic Documents at www.sgs.com/terms_e-document.htm. Attention is drawn to the limitation of liability, indemnification and jurisdiction issues defined therein. Any holder of this document is advised that information contained hereon reflects the Company's findings at the time of its intervention only and within the limits of Client's instructions, if any. The Company's sole responsibility is to its Client and this document does not exonerate parties to a transaction from exercising all their rights and obligations under the transaction documents. This document cannot be reproduced except in full, without prior written approval of the Company. Any unauthorized alteration, forgery or falsification of the content or appearance of this document is unlawful and offenders may be prosecuted to the fullest extent of the law.

SGS Taiwan Ltd.

No.134,WuKungRoad,NewTaipeiIndustrialPark,WukuDistrict,NewTaipeiCity,Taiwan24803/新北市五股區新北產業園區五工路 134 號

台灣檢驗科技股份有限公司

t (886-2) 2299-3279

f (886-2) 2298-0488

www.tw.sgs.com

Member of SGS Group

Radar Type 5 for 802.11a 5300 MHz

Wave form Num = 24
Num of Bursts = 18
Burst Interval (us) = 666667

Burst #	OffTime (us)	# Pulses	Chirp (MHz)	PW (us)	Pulse1 Pri(us)	Pulse2 Pri(us)	Pulse3 Pri(us)	StartLoc (us)	StartBurst Interval(us)	EndBurst Interval(us)
1	255615	1	11	55	1959	0	0	255615	0	666666
2	1036766	3	11	50	1996	1893	1004	1294340	666667	1333333
3	78641	1	10	90	1893	0	0	1377874	1333334	2000000
4	1265742	3	13	85	1265	1716	1390	2645509	2000001	2666667
5	681217	1	6	80	1235	0	0	3331097	2666668	3333334
6	495454	1	12	70	1848	0	0	3827786	3333335	4000001
7	337779	3	12	60	1383	1978	1440	4167413	4000002	4666668
8	840749	2	14	85	1480	1454	0	5012963	4666669	5333335
9	318566	1	9	70	1739	0	0	5334463	5333336	6000002
10	1139390	3	19	80	1260	1170	1511	6475592	6000003	6666669
11	728466	1	19	100	1996	0	0	7207999	6666670	7333336
12	622624	2	20	95	1408	1869	0	7832619	7333337	8000003
13	609116	3	13	90	1463	1843	1781	8445012	8000004	8666670
14	498628	1	6	100	1387	0	0	8948727	8666671	9333337
15	968283	3	20	80	1618	1420	1672	9918397	9333338	10000004
16	335514	2	8	55	1579	1662	0	10258621	10000005	10666671
17	712555	3	19	60	1205	1236	1173	10974417	10666672	11333338
18	733819	3	8	90	1228	1197	1766	11711850	11333339	12000005
Total	number	of	pulses	in	waveform	=	37			

Unless otherwise stated the results shown in this test report refer only to the sample(s) tested and such sample(s) are retained for 90 days only.

除非另有說明，此報告結果僅對測試之樣品負責，同時此樣品僅保留90天。本報告未經本公司書面許可，不可部份複製。

This document is issued by the Company subject to its General Conditions of Service printed overleaf, available on request or accessible at www.sgs.com/terms_and_conditions.htm and, for electronic format documents, subject to Terms and Conditions for Electronic Documents at www.sgs.com/terms_e-document.htm. Attention is drawn to the limitation of liability, indemnification and jurisdiction issues defined therein. Any holder of this document is advised that information contained hereon reflects the Company's findings at the time of its intervention only and within the limits of Client's instructions, if any. The Company's sole responsibility is to its Client and this document does not exonerate parties to a transaction from exercising all their rights and obligations under the transaction documents. This document cannot be reproduced except in full, without prior written approval of the Company. Any unauthorized alteration, forgery or falsification of the content or appearance of this document is unlawful and offenders may be prosecuted to the fullest extent of the law.

SGS Taiwan Ltd.

No.134,WuKungRoad,NewTaipeiIndustrialPark,WukuDistrict,NewTaipeiCity,Taiwan24803/新北市五股區新北產業園區五工路 134 號

台灣檢驗科技股份有限公司

t (886-2) 2299-3279

f (886-2) 2298-0488

www.tw.sgs.com

Member of SGS Group

Radar Type 5 for 802.11a 5300 MHz

Wave form Num = 25
Num of Bursts = 18
Burst Interval (us) = 666667

Burst #	OffTime (us)	# Pulses	Chirp (MHz)	PW (us)	Pulse1 Pri(us)	Pulse2 Pri(us)	Pulse3 Pri(us)	StartLoc (us)	StartBurst Interval(us)	EndBurst Interval(us)
1	423451	1	8	70	1133	0	0	423451	0	666666
2	382237	2	17	70	1270	1342	0	806821	666667	1333333
3	1102227	2	8	95	1561	1609	0	1911660	1333334	2000000
4	88567	2	5	55	1647	1603	0	2003397	2000001	2666667
5	759140	1	20	65	1981	0	0	2765787	2666668	3333334
6	1071079	2	5	60	1463	1053	0	3838847	3333335	4000001
7	492660	1	15	70	1642	0	0	4334023	4000002	4666668
8	411995	3	13	55	1268	1019	1786	4747660	4666669	5333335
9	695635	1	7	60	1346	0	0	5447368	5333336	6000002
10	801297	1	19	55	1647	0	0	6250011	6000003	6666669
11	667124	3	11	60	1663	1210	1779	6918782	6666670	7333336
12	1028895	3	6	50	1930	1412	1977	7952329	7333337	8000003
13	238262	1	20	90	1029	0	0	8195910	8000004	8666670
14	1025583	3	14	100	1132	1772	1745	9222522	8666671	9333337
15	198455	2	6	50	1042	1518	0	9425626	9333338	10000004
16	1113677	2	6	55	1601	1797	0	10541863	10000005	10666671
17	607962	3	14	70	1974	1022	1480	11153223	10666672	11333338
18	297319	3	8	75	1178	1921	1569	11455018	11333339	12000005
Total	number	of	pulses	in	waveform	=	36			

Unless otherwise stated the results shown in this test report refer only to the sample(s) tested and such sample(s) are retained for 90 days only.

除非另有說明，此報告結果僅對測試之樣品負責，同時此樣品僅保留90天。本報告未經本公司書面許可，不可部份複製。

This document is issued by the Company subject to its General Conditions of Service printed overleaf, available on request or accessible at www.sgs.com/terms_and_conditions.htm and, for electronic format documents, subject to Terms and Conditions for Electronic Documents at www.sgs.com/terms_e-document.htm. Attention is drawn to the limitation of liability, indemnification and jurisdiction issues defined therein. Any holder of this document is advised that information contained hereon reflects the Company's findings at the time of its intervention only and within the limits of Client's instructions, if any. The Company's sole responsibility is to its Client and this document does not exonerate parties to a transaction from exercising all their rights and obligations under the transaction documents. This document cannot be reproduced except in full, without prior written approval of the Company. Any unauthorized alteration, forgery or falsification of the content or appearance of this document is unlawful and offenders may be prosecuted to the fullest extent of the law.

SGS Taiwan Ltd.

No.134,WuKungRoad,NewTaipeiIndustrialPark,WukuDistrict,NewTaipeiCity,Taiwan24803/新北市五股區新北產業園區五工路 134 號

台灣檢驗科技股份有限公司

t (886-2) 2299-3279

f (886-2) 2298-0488

www.tw.sgs.com

Member of SGS Group

Radar Type 5 for 802.11a 5300 MHz

Wave form Num = 26
Num of Bursts = 17
Burst Interval (us) = 705882

Burst #	OffTime (us)	# Pulses	Chirp (MHz)	PW (us)	Pulse1 Pri(us)	Pulse2 Pri(us)	Pulse3 Pri(us)	StartLoc (us)	StartBurst Interval(us)	EndBurst Interval(us)
1	106524	3	7	60	1965	1698	1325	106524	0	705881
2	771807	3	8	55	1560	1364	1527	883319	705882	1411763
3	734245	2	10	70	1279	1459	0	1622015	1411764	2117645
4	961856	1	13	60	1620	0	0	2586609	2117646	2823527
5	838052	3	12	80	1044	1830	1499	3426281	2823528	3529409
6	726320	2	5	80	1637	1261	0	4156974	3529410	4235291
7	568558	3	17	95	1316	1938	1603	4728430	4235292	4941173
8	879195	1	9	65	1921	0	0	5612482	4941174	5647055
9	453127	1	8	90	1693	0	0	6067530	5647056	6352937
10	854245	3	7	80	1752	1187	1866	6923468	6352938	7058819
11	794942	1	17	80	1702	0	0	7723215	7058820	7764701
12	75017	2	8	75	1414	1120	0	7799934	7764702	8470583
13	873921	1	18	75	1145	0	0	8676389	8470584	9176465
14	857915	3	17	100	1272	1110	1458	9535449	9176466	9882347
15	548414	1	17	60	1385	0	0	10087703	9882348	10588229
16	510887	2	19	70	1892	1880	0	10599975	10588230	11294111
17	1072650	3	19	100	1848	1539	1331	11676397	11294112	11999993
Total	number	of	pulses	in	waveform	=	35			

Unless otherwise stated the results shown in this test report refer only to the sample(s) tested and such sample(s) are retained for 90 days only.

除非另有說明，此報告結果僅對測試之樣品負責，同時此樣品僅保留90天。本報告未經本公司書面許可，不可部份複製。

This document is issued by the Company subject to its General Conditions of Service printed overleaf, available on request or accessible at www.sgs.com/terms_and_conditions.htm and, for electronic format documents, subject to Terms and Conditions for Electronic Documents at www.sgs.com/terms_e-document.htm. Attention is drawn to the limitation of liability, indemnification and jurisdiction issues defined therein. Any holder of this document is advised that information contained hereon reflects the Company's findings at the time of its intervention only and within the limits of Client's instructions, if any. The Company's sole responsibility is to its Client and this document does not exonerate parties to a transaction from exercising all their rights and obligations under the transaction documents. This document cannot be reproduced except in full, without prior written approval of the Company. Any unauthorized alteration, forgery or falsification of the content or appearance of this document is unlawful and offenders may be prosecuted to the fullest extent of the law.

SGS Taiwan Ltd.

No.134,WuKungRoad,NewTaipeiIndustrialPark,WukuDistrict,NewTaipeiCity,Taiwan24803/新北市五股區新北產業園區五工路 134 號

台灣檢驗科技股份有限公司

t (886-2) 2299-3279

f (886-2) 2298-0488

www.tw.sgs.com

Member of SGS Group

Radar Type 5 for 802.11a 5300 MHz

Wave form Num = 27
Num of Bursts = 17
Burst Interval (us) = 705882

Burst #	OffTime (us)	# Pulses	Chirp (MHz)	PW (us)	Pulse1 Pri(us)	Pulse2 Pri(us)	Pulse3 Pri(us)	StartLoc (us)	StartBurst Interval(us)	EndBurst Interval(us)
1	195837	2	5	100	1854	1956	0	195837	0	705881
2	905344	2	7	80	1000	1833	0	1104991	705882	1411763
3	849064	2	20	75	1312	1143	0	1956888	1411764	2117645
4	440722	3	20	90	1215	1283	1675	2400065	2117646	2823527
5	707569	2	17	90	1593	1773	0	3111807	2823528	3529409
6	493544	2	11	70	1394	1682	0	3608717	3529410	4235291
7	1228607	3	14	95	1542	1993	1294	4840400	4235292	4941173
8	560212	2	18	65	1095	1153	0	5405441	4941174	5647055
9	453392	1	11	85	1678	0	0	5861081	5647056	6352937
10	1081004	2	19	95	1686	1874	0	6943763	6352938	7058819
11	296484	1	6	85	1470	0	0	7243807	7058820	7764701
12	1045732	3	17	90	1274	1438	1219	8291009	7764702	8470583
13	804615	2	13	50	1079	1294	0	9099555	8470584	9176465
14	479475	3	15	65	1711	1631	1572	9581403	9176466	9882347
15	789222	1	13	70	1609	0	0	10375539	9882348	10588229
16	405791	3	15	70	1120	1199	1229	10782939	10588230	11294111
17	940885	3	7	90	1748	1301	1779	11727372	11294112	11999993
Total	number	of	pulses	in	waveform	=	37			

Unless otherwise stated the results shown in this test report refer only to the sample(s) tested and such sample(s) are retained for 90 days only.

除非另有說明，此報告結果僅對測試之樣品負責，同時此樣品僅保留90天。本報告未經本公司書面許可，不可部份複製。

This document is issued by the Company subject to its General Conditions of Service printed overleaf, available on request or accessible at www.sgs.com/terms_and_conditions.htm and, for electronic format documents, subject to Terms and Conditions for Electronic Documents at www.sgs.com/terms_e-document.htm. Attention is drawn to the limitation of liability, indemnification and jurisdiction issues defined therein. Any holder of this document is advised that information contained hereon reflects the Company's findings at the time of its intervention only and within the limits of Client's instructions, if any. The Company's sole responsibility is to its Client and this document does not exonerate parties to a transaction from exercising all their rights and obligations under the transaction documents. This document cannot be reproduced except in full, without prior written approval of the Company. Any unauthorized alteration, forgery or falsification of the content or appearance of this document is unlawful and offenders may be prosecuted to the fullest extent of the law.

SGS Taiwan Ltd.

No.134,WuKungRoad,NewTaipeiIndustrialPark,WukuDistrict,NewTaipeiCity,Taiwan24803/新北市五股區新北產業園區五工路 134 號

台灣檢驗科技股份有限公司

t (886-2) 2299-3279

f (886-2) 2298-0488

www.tw.sgs.com

Member of SGS Group

Radar Type 5 for 802.11a 5300 MHz

Wave form Num = 28
Num of Bursts = 15
Burst Interval (us) = 800000

Burst #	OffTime (us)	# Pulses	Chirp (MHz)	PW (us)	Pulse1 Pri(us)	Pulse2 Pri(us)	Pulse3 Pri(us)	StartLoc (us)	StartBurst Interval(us)	EndBurst Interval(us)
1	778400	1	16	50	1320	0	0	778400	0	799999
2	689613	1	8	65	1494	0	0	1469333	800000	1599999
3	776497	1	12	80	1650	0	0	2247324	1600000	2399999
4	750829	1	12	85	1881	0	0	2999803	2400000	3199999
5	954287	3	10	90	1488	1712	1399	3955971	3200000	3999999
6	181483	2	20	50	1222	1325	0	4142053	4000000	4799999
7	772406	2	8	85	1275	1146	0	4917006	4800000	5599999
8	1022356	1	18	90	1608	0	0	5941783	5600000	6399999
9	932445	3	11	100	1570	1258	1889	6875836	6400000	7199999
10	1030606	2	10	60	1880	1971	0	7911159	7200000	7999999
11	826373	3	18	85	1768	1242	1638	8741383	8000000	8799999
12	670374	3	11	85	1352	1821	1725	9416405	8800000	9599999
13	719117	1	5	75	1591	0	0	10140420	9600000	10399999
14	329504	2	8	60	1635	1127	0	10471515	10400000	11199999
15	1517549	2	20	80	1905	1885	0	11991826	11200000	11999999
Total	number	of	pulses	in	waveform	=	28			

Radar Type 5 for 802.11a 5300 MHz

Wave form Num = 29
Num of Bursts = 12
Burst Interval (us) = 1E+06

Burst #	OffTime (us)	# Pulses	Chirp (MHz)	PW (us)	Pulse1 Pri(us)	Pulse2 Pri(us)	Pulse3 Pri(us)	StartLoc (us)	StartBurst Interval(us)	EndBurst Interval(us)
1	543677	2	9	50	1906	1656	0	543677	0	999999
2	803371	3	12	85	1321	1300	1315	1350610	1000000	1999999
3	1267222	1	9	95	1540	0	0	2621768	2000000	2999999
4	1152610	1	14	50	1343	0	0	3775918	3000000	3999999
5	1032427	1	15	95	1257	0	0	4809688	4000000	4999999
6	751084	3	9	50	1284	1728	1450	5562029	5000000	5999999
7	516439	1	20	60	1911	0	0	6082930	6000000	6999999
8	1318549	3	7	75	1757	1880	1040	7403390	7000000	7999999
9	662622	2	18	70	1134	1194	0	8070689	8000000	8999999
10	1650882	2	15	80	1097	1953	0	9723899	9000000	9999999
11	606580	1	19	90	1261	0	0	10333529	10000000	10999999
12	1348136	3	10	60	1004	1191	1443	11682926	11000000	11999999
Total	number	of	pulses	in	waveform	=	23			

Unless otherwise stated the results shown in this test report refer only to the sample(s) tested and such sample(s) are retained for 90 days only.

除非另有說明，此報告結果僅對測試之樣品負責，同時此樣品僅保留90天。本報告未經本公司書面許可，不可部份複製。

This document is issued by the Company subject to its General Conditions of Service printed overleaf, available on request or accessible at www.sgs.com/terms_and_conditions.htm and, for electronic format documents, subject to Terms and Conditions for Electronic Documents at www.sgs.com/terms_e-document.htm. Attention is drawn to the limitation of liability, indemnification and jurisdiction issues defined therein. Any holder of this document is advised that information contained hereon reflects the Company's findings at the time of its intervention only and within the limits of Client's instructions, if any. The Company's sole responsibility is to its Client and this document does not exonerate parties to a transaction from exercising all their rights and obligations under the transaction documents. This document cannot be reproduced except in full, without prior written approval of the Company. Any unauthorized alteration, forgery or falsification of the content or appearance of this document is unlawful and offenders may be prosecuted to the fullest extent of the law.

SGS Taiwan Ltd.

No.134,WuKungRoad,NewTaipeiIndustrialPark,WukuDistrict,NewTaipeiCity,Taiwan24803/新北市五股區新北產業園區五工路 134 號

台灣檢驗科技股份有限公司

t (886-2) 2299-3279

f (886-2) 2298-0488

www.tw.sgs.com

Member of SGS Group

Radar Type 5 for 802.11a 5300 MHz

Wave form Num = 30
Num of Bursts = 17
Burst Interval (us) = 705882

Burst #	OffTime (us)	# Pulses	Chirp (MHz)	PW (us)	Pulse1 Pri(us)	Pulse2 Pri(us)	Pulse3 Pri(us)	StartLoc (us)	StartBurst Interval(us)	EndBurst Interval(us)
1	359719	1	17	65	1967	0	0	359719	0	705881
2	799609	2	17	70	1124	1341	0	1161295	705882	1411763
3	824048	2	10	85	1839	1387	0	1987808	1411764	2117645
4	493540	2	6	60	1971	1551	0	2484574	2117646	2823527
5	380917	1	13	90	1400	0	0	2869013	2823528	3529409
6	730959	2	9	55	1224	1126	0	3601372	3529410	4235291
7	1162136	2	16	85	1865	1452	0	4765858	4235292	4941173
8	287967	2	5	60	1542	1764	0	5057142	4941174	5647055
9	873884	1	6	75	1461	0	0	5934332	5647056	6352937
10	668777	2	17	85	1557	1136	0	6604570	6352938	7058819
11	980470	1	14	50	1100	0	0	7587733	7058820	7764701
12	529888	2	5	75	1570	1563	0	8118721	7764702	8470583
13	963916	3	12	55	1543	1111	1824	9085770	8470584	9176465
14	576396	3	14	90	1393	1509	1100	9666644	9176466	9882347
15	605051	1	11	80	1160	0	0	10275697	9882348	10588229
16	665665	2	11	95	1998	1493	0	10942522	10588230	11294111
17	606562	1	13	50	1477	0	0	11552575	11294112	11999993
Total	number	of	pulses	in	waveform	=	30			

802.11a 5500 MHz:

Short Pulse Radar Type	Minimum Number of Trials	Detection(%)	Minimum Percentage of Successful Detection(%)	Pass/Fail
1	30	100.00	60	Pass
2	30	100.00	60	Pass
3	30	100.00	60	Pass
4	30	96.66	60	Pass
Aggregate (Radar Types 1-4)	120	99.17	80	Pass
Long Pulse Radar Test Waveform	Minimum Number of Trials	Detection	Minimum Percentage of Successful Detection(Limit)	Pass/Fail
5 - Variable	30	100.00	80	Pass
Frequency Hopping Radar Test Waveform	Minimum Number of Trials	Detection	Minimum Percentage of Successful Detection(Limit)	Pass/Fail
6	30	100.00	70	Pass

Unless otherwise stated the results shown in this test report refer only to the sample(s) tested and such sample(s) are retained for 90 days only.

除非另有說明，此報告結果僅對測試之樣品負責，同時此樣品僅保留90天。本報告未經本公司書面許可，不可部份複製。

This document is issued by the Company subject to its General Conditions of Service printed overleaf, available on request or accessible at www.sgs.com/terms_and_conditions.htm and, for electronic format documents, subject to Terms and Conditions for Electronic Documents at www.sgs.com/terms_e-document.htm. Attention is drawn to the limitation of liability, indemnification and jurisdiction issues defined therein. Any holder of this document is advised that information contained hereon reflects the Company's findings at the time of its intervention only and within the limits of Client's instructions, if any. The Company's sole responsibility is to its Client and this document does not exonerate parties to a transaction from exercising all their rights and obligations under the transaction documents. This document cannot be reproduced except in full, without prior written approval of the Company. Any unauthorized alteration, forgery or falsification of the content or appearance of this document is unlawful and offenders may be prosecuted to the fullest extent of the law.

SGS Taiwan Ltd.

No.134,WuKungRoad,NewTaipeiIndustrialPark,WukuDistrict,NewTaipeiCity,Taiwan24803/新北市五股區新北產業園區五工路 134 號

台灣檢驗科技股份有限公司

t (886-2) 2299-3279

f (886-2) 2298-0488

www.tw.sgs.com

Member of SGS Group

Radar Type 1 for 802.11a 5500 MHz:

Data Sheet for FCC Variable Radar Type 1				
1 us Pulse Width, PRI Test A&Test B				
Trial	PRI	Pulses Per Burst	Test	Successful Detection

Unless otherwise stated the results shown in this test report refer only to the sample(s) tested and such sample(s) are retained for 90 days only.

除非另有說明，此報告結果僅對測試之樣品負責，同時此樣品僅保留90天。本報告未經本公司書面許可，不可部份複製。

This document is issued by the Company subject to its General Conditions of Service printed overleaf, available on request or accessible at www.sgs.com/terms_and_conditions.htm and, for electronic format documents, subject to Terms and Conditions for Electronic Documents at www.sgs.com/terms_e-document.htm. Attention is drawn to the limitation of liability, indemnification and jurisdiction issues defined therein. Any holder of this document is advised that information contained hereon reflects the Company's findings at the time of its intervention only and within the limits of Client's instructions, if any. The Company's sole responsibility is to its Client and this document does not exonerate parties to a transaction from exercising all their rights and obligations under the transaction documents. This document cannot be reproduced except in full, without prior written approval of the Company. Any unauthorized alteration, forgery or falsification of the content or appearance of this document is unlawful and offenders may be prosecuted to the fullest extent of the law.

SGS Taiwan Ltd.

No.134,WuKungRoad,NewTaipeiIndustrialPark,WukuDistrict,NewTaipeiCity,Taiwan24803/新北市五股區新北產業園區五工路 134 號

台灣檢驗科技股份有限公司

t (886-2) 2299-3279

f (886-2) 2298-0488

www.tw.sgs.com

Member of SGS Group

Radar Type 2 for 802.11a 5500 MHz:

Data Sheet for FCC Variable Radar Type 2				
1-5 us Pulse Width, PRI 150-230 us, 23-29 Pulses per Burst				
Trial	Pulse Width	PRI	Pulses Per Burst	Successful Detection

Unless otherwise stated the results shown in this test report refer only to the sample(s) tested and such sample(s) are retained for 90 days only.

除非另有說明，此報告結果僅對測試之樣品負責，同時此樣品僅保留90天。本報告未經本公司書面許可，不可部份複製。

This document is issued by the Company subject to its General Conditions of Service printed overleaf, available on request or accessible at www.sgs.com/terms_and_conditions.htm and, for electronic format documents, subject to Terms and Conditions for Electronic Documents at www.sgs.com/terms_e-document.htm. Attention is drawn to the limitation of liability, indemnification and jurisdiction issues defined therein. Any holder of this document is advised that information contained hereon reflects the Company's findings at the time of its intervention only and within the limits of Client's instructions, if any. The Company's sole responsibility is to its Client and this document does not exonerate parties to a transaction from exercising all their rights and obligations under the transaction documents. This document cannot be reproduced except in full, without prior written approval of the Company. Any unauthorized alteration, forgery or falsification of the content or appearance of this document is unlawful and offenders may be prosecuted to the fullest extent of the law.

SGS Taiwan Ltd.

No.134,WuKungRoad,NewTaipeiIndustrialPark,WukuDistrict,NewTaipeiCity,Taiwan24803/新北市五股區新北產業園區五工路 134 號

台灣檢驗科技股份有限公司

t (886-2) 2299-3279

f (886-2) 2298-0488

www.tw.sgs.com

Member of SGS Group

Radar Type 3 for 802.11a 5500 MHz:

Data Sheet for FCC Variable Radar Type 3				
6-10 us Pulse Width, PRI 200-500 us, 16-18 Pulses per Burst				
Trial	Pulse Width	PRI	Pulses Per Burst	Successful Detection

Unless otherwise stated the results shown in this test report refer only to the sample(s) tested and such sample(s) are retained for 90 days only.

除非另有說明，此報告結果僅對測試之樣品負責，同時此樣品僅保留90天。本報告未經本公司書面許可，不可部份複製。

This document is issued by the Company subject to its General Conditions of Service printed overleaf, available on request or accessible at www.sgs.com/terms_and_conditions.htm and, for electronic format documents, subject to Terms and Conditions for Electronic Documents at www.sgs.com/terms_e-document.htm. Attention is drawn to the limitation of liability, indemnification and jurisdiction issues defined therein. Any holder of this document is advised that information contained hereon reflects the Company's findings at the time of its intervention only and within the limits of Client's instructions, if any. The Company's sole responsibility is to its Client and this document does not exonerate parties to a transaction from exercising all their rights and obligations under the transaction documents. This document cannot be reproduced except in full, without prior written approval of the Company. Any unauthorized alteration, forgery or falsification of the content or appearance of this document is unlawful and offenders may be prosecuted to the fullest extent of the law.

SGS Taiwan Ltd.

No.134,WuKungRoad,NewTaipeiIndustrialPark,WukuDistrict,NewTaipeiCity,Taiwan24803/新北市五股區新北產業園區五工路 134 號

台灣檢驗科技股份有限公司

t (886-2) 2299-3279

f (886-2) 2298-0488

www.tw.sgs.com

Member of SGS Group

Radar Type 4 for 802.11a 5500 MHz:

Data Sheet for FCC Variable Radar Type 4				
11-20 us Pulse Width, PRI 200-500 us, 12-16 Pulses per Burst				
Trial	Pulse Width	PRI	Pulses Per Burst	Successful Detection

Unless otherwise stated the results shown in this test report refer only to the sample(s) tested and such sample(s) are retained for 90 days only.

除非另有說明，此報告結果僅對測試之樣品負責，同時此樣品僅保留90天。本報告未經本公司書面許可，不可部份複製。

This document is issued by the Company subject to its General Conditions of Service printed overleaf, available on request or accessible at www.sgs.com/terms_and_conditions.htm and, for electronic format documents, subject to Terms and Conditions for Electronic Documents at www.sgs.com/terms_e-document.htm. Attention is drawn to the limitation of liability, indemnification and jurisdiction issues defined therein. Any holder of this document is advised that information contained hereon reflects the Company's findings at the time of its intervention only and within the limits of Client's instructions, if any. The Company's sole responsibility is to its Client and this document does not exonerate parties to a transaction from exercising all their rights and obligations under the transaction documents. This document cannot be reproduced except in full, without prior written approval of the Company. Any unauthorized alteration, forgery or falsification of the content or appearance of this document is unlawful and offenders may be prosecuted to the fullest extent of the law.

SGS Taiwan Ltd.

No.134,WuKungRoad,NewTaipeiIndustrialPark,WukuDistrict,NewTaipeiCity,Taiwan24803/新北市五股區新北產業園區五工路 134 號

台灣檢驗科技股份有限公司

t (886-2) 2299-3279

f (886-2) 2298-0488

www.tw.sgs.com

Member of SGS Group

Radar Type 5 for 802.11a 5500 MHz

Waveform Num =	1
Num of Bursts =	13
Burst Interval (us)	923077

Burst #	OffTime (us)	# Pulses	Chirp (MHz)	PW (us)	Pulse1 Pri(us)	Pulse2 Pri(us)	Pulse3 Pri(us)	StartLoc (us)	StartBurst Interval(us)	EndBurst Interval(us)
1	791750	3	9	75	1338	1174	1920	791750	0	923076
2	1014018	3	16	95	1570	1985	1780	1810200	923077	1846153
3	135903	2	7	75	1581	1089	0	1951438	1846154	2769230
4	854953	3	5	70	1572	1537	1887	2809061	2769231	3692307
5	1487703	1	14	95	1430	0	0	4301760	3692308	4615384
6	726568	1	11	50	1755	0	0	5029758	4615385	5538461
7	1203462	2	17	85	1275	1494	0	6234975	5538462	6461538
8	565521	2	15	55	1926	1894	0	6803265	6461539	7384615
9	615068	2	12	90	1486	1088	0	7422153	7384616	8307692
10	1235993	1	15	70	1495	0	0	8660720	8307693	9230769
11	814141	1	16	85	1063	0	0	9476356	9230770	10153846
12	988220	2	17	100	1625	1663	0	10465639	10153847	11076923
13	610422	1	16	90	1294	0	0	11079349	11076924	12000000
Total	number	of	pulses	in	waveform	=	24			

Radar Type 5 for 802.11a 5500 MHz

Waveform Num =	2
Num of Bursts =	14
Burst Interval (us)	857143

Burst #	OffTime (us)	# Pulses	Chirp (MHz)	PW (us)	Pulse1 Pri(us)	Pulse2 Pri(us)	Pulse3 Pri(us)	StartLoc (us)	StartBurst Interval(us)	EndBurst Interval(us)
1	549577	3	15	55	1502	1622	1440	549577	0	857142
2	489747	2	9	100	1097	1526	0	1043888	857143	1714285
3	864374	1	13	60	1191	0	0	1910885	1714286	2571428
4	934493	2	17	55	1690	1632	0	2846569	2571429	3428571
5	1335210	2	16	65	1211	1233	0	4185101	3428572	4285714
6	597902	3	5	75	1961	1311	1562	4785447	4285715	5142857
7	608939	1	19	95	1597	0	0	5399220	5142858	6000000
8	1106150	3	7	95	1855	1513	1048	6506967	6000001	6857143
9	514334	2	15	55	1874	1137	0	7025717	6857144	7714286
10	760103	3	18	95	1382	1287	1086	7788831	7714287	8571429
11	828708	1	13	75	1503	0	0	8621294	8571430	9428572
12	1044610	1	6	70	1565	0	0	9667407	9428573	10285715
13	745141	1	20	55	1936	0	0	10414113	10285716	11142858
14	1211894	3	18	55	1541	1261	1191	11627943	11142859	12000001
Total	number	of	pulses	in	waveform	=	28			

Unless otherwise stated the results shown in this test report refer only to the sample(s) tested and such sample(s) are retained for 90 days only.

除非另有說明，此報告結果僅對測試之樣品負責，同時此樣品僅保留90天。本報告未經本公司書面許可，不可部份複製。

This document is issued by the Company subject to its General Conditions of Service printed overleaf, available on request or accessible at www.sgs.com/terms_and_conditions.htm and, for electronic format documents, subject to Terms and Conditions for Electronic Documents at www.sgs.com/terms_e-document.htm. Attention is drawn to the limitation of liability, indemnification and jurisdiction issues defined therein. Any holder of this document is advised that information contained hereon reflects the Company's findings at the time of its intervention only and within the limits of Client's instructions, if any. The Company's sole responsibility is to its Client and this document does not exonerate parties to a transaction from exercising all their rights and obligations under the transaction documents. This document cannot be reproduced except in full, without prior written approval of the Company. Any unauthorized alteration, forgery or falsification of the content or appearance of this document is unlawful and offenders may be prosecuted to the fullest extent of the law.

SGS Taiwan Ltd.

No.134,WuKungRoad,NewTaipeiIndustrialPark,WukuDistrict,NewTaipeiCity,Taiwan24803/新北市五股區新北產業園區五工路 134 號

台灣檢驗科技股份有限公司

t (886-2) 2299-3279

f (886-2) 2298-0488

www.tw.sgs.com

Member of SGS Group

Radar Type 5 for 802.11a 5500 MHz

Waveform Num =	3
Num of Bursts =	12
Burst Interval (us)	1000000

Burst #	OffTime (us)	# Pulses	Chirp (MHz)	PW (us)	Pulse1 Pri(us)	Pulse2 Pri(us)	Pulse3 Pri(us)	StartLoc (us)	StartBurst Interval(us)	EndBurst Interval(us)
1	612301	2	18	60	1604	1013	0	612301	0	999999
2	1137818	3	7	65	1890	1567	1096	1752736	1000000	1999999
3	491741	1	19	60	1120	0	0	2249030	2000000	2999999
4	1374459	3	10	60	1540	1104	1771	3624609	3000000	3999999
5	660859	3	6	100	1304	1612	1659	4289883	4000000	4999999
6	1275896	1	7	55	1744	0	0	5570354	5000000	5999999
7	940776	1	11	95	1523	0	0	6512874	6000000	6999999
8	543055	1	16	50	1301	0	0	7057452	7000000	7999999
9	1533063	3	20	85	1292	1976	1459	8591816	8000000	8999999
10	412818	3	15	65	1527	1005	1731	9009361	9000000	9999999
11	1450893	3	20	90	1941	1059	1501	10464517	10000000	10999999
12	647348	2	7	50	1710	1478	0	11116366	11000000	11999999
Total	number	of	pulses	in	waveform	=	26			

Radar Type 5 for 802.11a 5500 MHz

Waveform Num =	4
Num of Bursts =	10
Burst Interval (us)	1200000

Burst #	OffTime (us)	# Pulses	Chirp (MHz)	PW (us)	Pulse1 Pri(us)	Pulse2 Pri(us)	Pulse3 Pri(us)	StartLoc (us)	StartBurst Interval(us)	EndBurst Interval(us)
1	879145	3	11	50	1074	1963	1246	879145	0	1199999
2	1410444	3	9	60	1604	1135	1009	2293872	1200000	2399999
3	987619	3	16	95	1820	1116	1996	3285239	2400000	3599999
4	361545	1	12	100	1234	0	0	3651716	3600000	4799999
5	2216424	3	14	95	1753	1060	1679	5869374	4800000	5999999
6	699448	3	17	90	1237	1245	1272	6573314	6000000	7199999
7	1229972	3	13	90	1927	1343	1797	7807040	7200000	8399999
8	1564779	2	10	100	1676	1309	0	9376886	8400000	9599999
9	668377	1	12	75	1033	0	0	10048248	9600000	10799999
10	1111304	2	15	100	1581	1548	0	11160585	10800000	11999999
Total	number	of	pulses	in	waveform	=	24			

Unless otherwise stated the results shown in this test report refer only to the sample(s) tested and such sample(s) are retained for 90 days only.

除非另有說明，此報告結果僅對測試之樣品負責，同時此樣品僅保留90天。本報告未經本公司書面許可，不可部份複製。

This document is issued by the Company subject to its General Conditions of Service printed overleaf, available on request or accessible at www.sgs.com/terms_and_conditions.htm and, for electronic format documents, subject to Terms and Conditions for Electronic Documents at www.sgs.com/terms_e-document.htm. Attention is drawn to the limitation of liability, indemnification and jurisdiction issues defined therein. Any holder of this document is advised that information contained hereon reflects the Company's findings at the time of its intervention only and within the limits of Client's instructions, if any. The Company's sole responsibility is to its Client and this document does not exonerate parties to a transaction from exercising all their rights and obligations under the transaction documents. This document cannot be reproduced except in full, without prior written approval of the Company. Any unauthorized alteration, forgery or falsification of the content or appearance of this document is unlawful and offenders may be prosecuted to the fullest extent of the law.

SGS Taiwan Ltd.

No.134,WuKungRoad,NewTaipeiIndustrialPark,WukuDistrict,NewTaipeiCity,Taiwan24803/新北市五股區新北產業園區五工路 134 號

台灣檢驗科技股份有限公司

t (886-2) 2299-3279

f (886-2) 2298-0488

www.tw.sgs.com

Member of SGS Group

Radar Type 5 for 802.11a 5500 MHz

Waveform Num =	5
Num of Bursts =	9
Burst Interval (us)	1333333

Burst #	OffTime (us)	# Pulses	Chirp (MHz)	PW (us)	Pulse1 Pri(us)	Pulse2 Pri(us)	Pulse3 Pri(us)	StartLoc (us)	StartBurst Interval(us)	EndBurst Interval(us)
1	363804	3	6	70	1729	1922	1792	363804	0	1333332
2	1905891	1	5	85	1837	0	0	2275138	1333333	2666665
3	1186249	2	13	50	1838	1248	0	3463224	2666666	3999998
4	1392608	1	19	100	1891	0	0	4858918	3999999	5333331
5	1475944	1	11	75	1637	0	0	6336753	5333332	6666664
6	383001	3	20	80	1174	1790	1320	6721391	6666665	7999997
7	1805218	2	13	100	1624	1488	0	8530893	7999998	9333330
8	831436	2	19	85	1872	1992	0	9365441	9333331	10666663
9	2189500	2	15	100	1666	1171	0	11558805	10666664	11999996
Total	number	of	pulses	in	waveform	=	17			

Radar Type 5 for 802.11a 5500 MHz

Waveform Num =	6
Num of Bursts =	11
Burst Interval (us)	1090909

Burst #	OffTime (us)	# Pulses	Chirp (MHz)	PW (us)	Pulse1 Pri(us)	Pulse2 Pri(us)	Pulse3 Pri(us)	StartLoc (us)	StartBurst Interval(us)	EndBurst Interval(us)
1	753842	1	6	100	1171	0	0	753842	0	1090908
2	983834	2	14	85	1241	1946	0	1738847	1090909	2181817
3	703546	2	12	60	1417	1386	0	2445580	2181818	3272726
4	1240397	1	10	75	1546	0	0	3688780	3272727	4363635
5	1475460	3	20	100	1934	1373	1996	5165786	4363636	5454544
6	1098468	2	19	70	1229	1355	0	6269557	5454545	6545453
7	1034937	2	8	55	1699	1138	0	7307078	6545454	7636362
8	1144255	1	17	65	1059	0	0	8454170	7636363	8727271
9	853592	2	8	55	1143	1717	0	9308821	8727272	9818180
10	1582330	3	5	50	1265	1084	1616	10894011	9818181	10909089
11	245316	1	9	90	1648	0	0	11143292	10909090	11999998
Total	number	of	pulses	in	waveform	=	20			

Unless otherwise stated the results shown in this test report refer only to the sample(s) tested and such sample(s) are retained for 90 days only.

除非另有說明，此報告結果僅對測試之樣品負責，同時此樣品僅保留90天。本報告未經本公司書面許可，不可部份複製。

This document is issued by the Company subject to its General Conditions of Service printed overleaf, available on request or accessible at www.sgs.com/terms_and_conditions.htm and, for electronic format documents, subject to Terms and Conditions for Electronic Documents at www.sgs.com/terms_e-document.htm. Attention is drawn to the limitation of liability, indemnification and jurisdiction issues defined therein. Any holder of this document is advised that information contained hereon reflects the Company's findings at the time of its intervention only and within the limits of Client's instructions, if any. The Company's sole responsibility is to its Client and this document does not exonerate parties to a transaction from exercising all their rights and obligations under the transaction documents. This document cannot be reproduced except in full, without prior written approval of the Company. Any unauthorized alteration, forgery or falsification of the content or appearance of this document is unlawful and offenders may be prosecuted to the fullest extent of the law.

SGS Taiwan Ltd.

No.134,WuKungRoad,NewTaipeiIndustrialPark,WukuDistrict,NewTaipeiCity,Taiwan24803/新北市五股區新北產業園區五工路 134 號

台灣檢驗科技股份有限公司

t (886-2) 2299-3279

f (886-2) 2298-0488

www.tw.sgs.com

Member of SGS Group

Radar Type 5 for 802.11a 5500 MHz

Waveform Num =	7
Num of Bursts =	19
Burst Interval (us)	631579

Burst #	OffTime (us)	# Pulses	Chirp (MHz)	PW (us)	Pulse1 Pri(us)	Pulse2 Pri(us)	Pulse3 Pri(us)	StartLoc (us)	StartBurst Interval(us)	EndBurst Interval(us)
1	560924	1	8	70	1734	0	0	560924	0	631578
2	560942	1	19	65	1865	0	0	1123600	631579	1263157
3	429516	1	5	100	1471	0	0	1554981	1263158	1894736
4	597583	1	5	100	1922	0	0	2154035	1894737	2526315
5	428042	2	13	85	1757	1757	0	2583999	2526316	3157894
6	610030	1	15	70	1141	0	0	3197543	3157895	3789473
7	591795	3	11	65	1256	1093	1392	3790479	3789474	4421052
8	669558	3	16	70	1135	1978	1982	4463778	4421053	5052631
9	599773	2	13	100	1465	1821	0	5068646	5052632	5684210
10	1129913	1	18	95	1489	0	0	6201845	5684211	6315789
11	238020	1	5	50	1910	0	0	6441354	6315790	6947368
12	606535	1	8	60	1566	0	0	7049799	6947369	7578947
13	543570	1	16	65	1764	0	0	7594935	7578948	8210526
14	1169121	3	13	50	1321	1569	1448	8765820	8210527	8842105
15	666697	2	7	70	1326	1448	0	9436855	8842106	9473684
16	595045	2	11	55	1716	1351	0	10034674	9473685	10105263
17	268482	1	10	85	1578	0	0	10306223	10105264	10736842
18	857001	1	19	75	1515	0	0	11164802	10736843	11368421
19	419217	2	18	80	1922	1634	0	11585534	11368422	12000000
Total	number	of	pulses	in	waveform	=	30			

Unless otherwise stated the results shown in this test report refer only to the sample(s) tested and such sample(s) are retained for 90 days only.

除非另有說明，此報告結果僅對測試之樣品負責，同時此樣品僅保留90天。本報告未經本公司書面許可，不可部份複製。

This document is issued by the Company subject to its General Conditions of Service printed overleaf, available on request or accessible at www.sgs.com/terms_and_conditions.htm and, for electronic format documents, subject to Terms and Conditions for Electronic Documents at www.sgs.com/terms_e-document.htm. Attention is drawn to the limitation of liability, indemnification and jurisdiction issues defined therein. Any holder of this document is advised that information contained hereon reflects the Company's findings at the time of its intervention only and within the limits of Client's instructions, if any. The Company's sole responsibility is to its Client and this document does not exonerate parties to a transaction from exercising all their rights and obligations under the transaction documents. This document cannot be reproduced except in full, without prior written approval of the Company. Any unauthorized alteration, forgery or falsification of the content or appearance of this document is unlawful and offenders may be prosecuted to the fullest extent of the law.

SGS Taiwan Ltd.

No.134,WuKungRoad,NewTaipeiIndustrialPark,WukuDistrict,NewTaipeiCity,Taiwan24803/新北市五股區新北產業園區五工路 134 號

台灣檢驗科技股份有限公司

t (886-2) 2299-3279

f (886-2) 2298-0488

www.tw.sgs.com

Member of SGS Group

Radar Type 5 for 802.11a 5500 MHz

Waveform Num =	8
Num of Bursts =	13
Burst Interval (us)	923077

Burst #	OffTime (us)	# Pulses	Chirp (MHz)	PW (us)	Pulse1 Pri(us)	Pulse2 Pri(us)	Pulse3 Pri(us)	StartLoc (us)	StartBurst Interval(us)	EndBurst Interval(us)
1	557085	1	5	75	1871	0	0	557085	0	923076
2	868027	2	8	90	1777	1776	0	1426983	923077	1846153
3	608723	1	8	65	1993	0	0	2039259	1846154	2769230
4	1128462	3	14	60	1111	1426	1445	3169714	2769231	3692307
5	1381967	2	14	60	1780	1810	0	4555663	3692308	4615384
6	892948	2	12	70	1049	1556	0	5452201	4615385	5538461
7	967783	2	14	80	1897	1256	0	6422589	5538462	6461538
8	346461	1	12	100	1967	0	0	6772203	6461539	7384615
9	1354781	3	9	95	1771	1896	1575	8128951	7384616	8307692
10	511840	3	18	65	1947	1668	1667	8646033	8307693	9230769
11	896605	2	14	75	1211	1084	0	9547920	9230770	10153846
12	1322819	3	14	50	1684	1781	1293	10873034	10153847	11076923
13	1053870	3	15	60	1406	1631	1003	11931662	11076924	12000000
Total	number	of	pulses	in	waveform	=	28			

Radar Type 5 for 802.11a 5500 MHz

Waveform Num =	9
Num of Bursts =	10
Burst Interval (us)	1200000

Burst #	OffTime (us)	# Pulses	Chirp (MHz)	PW (us)	Pulse1 Pri(us)	Pulse2 Pri(us)	Pulse3 Pri(us)	StartLoc (us)	StartBurst Interval(us)	EndBurst Interval(us)
1	63783	3	7	85	1780	1090	1376	63783	0	1199999
2	1859999	3	14	90	1343	1062	1045	1928028	1200000	2399999
3	967285	2	7	80	1701	1599	0	2898763	2400000	3599999
4	1681207	1	13	100	1920	0	0	4583270	3600000	4799999
5	1184223	3	6	75	1725	1311	1242	5769413	4800000	5999999
6	1140524	3	7	80	1298	1711	1995	6914215	6000000	7199999
7	652080	1	7	90	1873	0	0	7571299	7200000	8399999
8	1723606	3	19	50	1714	1351	1161	9296778	8400000	9599999
9	1434248	2	6	60	1960	1446	0	10735252	9600000	10799999
10	765976	2	19	100	1540	1530	0	11504634	10800000	11999999
Total	number	of	pulses	in	waveform	=	23			

Unless otherwise stated the results shown in this test report refer only to the sample(s) tested and such sample(s) are retained for 90 days only.

除非另有說明，此報告結果僅對測試之樣品負責，同時此樣品僅保留90天。本報告未經本公司書面許可，不可部份複製。

This document is issued by the Company subject to its General Conditions of Service printed overleaf, available on request or accessible at www.sgs.com/terms_and_conditions.htm and, for electronic format documents, subject to Terms and Conditions for Electronic Documents at www.sgs.com/terms_e-document.htm. Attention is drawn to the limitation of liability, indemnification and jurisdiction issues defined therein. Any holder of this document is advised that information contained hereon reflects the Company's findings at the time of its intervention only and within the limits of Client's instructions, if any. The Company's sole responsibility is to its Client and this document does not exonerate parties to a transaction from exercising all their rights and obligations under the transaction documents. This document cannot be reproduced except in full, without prior written approval of the Company. Any unauthorized alteration, forgery or falsification of the content or appearance of this document is unlawful and offenders may be prosecuted to the fullest extent of the law.

Radar Type 5 for 802.11a 5500 MHz

Waveform Num =	10
Num of Bursts =	12
Burst Interval (us)	1000000

Burst #	OffTime (us)	# Pulses	Chirp (MHz)	PW (us)	Pulse1 Pri(us)	Pulse2 Pri(us)	Pulse3 Pri(us)	StartLoc (us)	StartBurst Interval(us)	EndBurst Interval(us)
1	455815	3	5	50	1934	1242	1081	455815	0	999999
2	1096196	1	14	90	1429	0	0	1556268	1000000	1999999
3	773292	1	15	55	1523	0	0	2330989	2000000	2999999
4	1190833	3	19	95	1722	1103	1019	3523345	3000000	3999999
5	1105760	3	19	85	1579	1569	1812	4632949	4000000	4999999
6	1260796	3	10	50	1318	1808	1295	5898705	5000000	5999999
7	1076892	1	6	55	1299	0	0	6980018	6000000	6999999
8	237212	1	8	95	1367	0	0	7218529	7000000	7999999
9	919058	1	19	60	1795	0	0	8138954	8000000	8999999
10	960404	3	7	50	1592	1281	1364	9101153	9000000	9999999
11	1308075	2	18	50	1219	1051	0	10413465	10000000	10999999
12	1241421	3	20	85	1978	1150	1875	11657156	11000000	11999999
Total	number	of	pulses	in	waveform	=	25			

Radar Type 5 for 802.11a 5500 MHz

Waveform Num =	11
Num of Bursts =	10
Burst Interval (us)	1200000

Burst #	OffTime (us)	# Pulses	Chirp (MHz)	PW (us)	Pulse1 Pri(us)	Pulse2 Pri(us)	Pulse3 Pri(us)	StartLoc (us)	StartBurst Interval(us)	EndBurst Interval(us)
1	102694	1	13	95	1642	0	0	102694	0	1199999
2	1821953	3	10	90	1434	1935	1487	1926289	1200000	2399999
3	628204	1	12	70	1213	0	0	2559349	2400000	3599999
4	1882222	1	16	70	1161	0	0	4442784	3600000	4799999
5	402971	1	18	100	1665	0	0	4846916	4800000	5999999
6	2305130	3	12	70	1969	1042	1412	7153711	6000000	7199999
7	1168120	1	16	55	1369	0	0	8326254	7200000	8399999
8	112487	3	5	80	1440	1351	1062	8440110	8400000	9599999
9	2135024	2	20	60	1671	1098	0	10578987	9600000	10799999
10	356590	3	15	60	1304	1801	1781	10938346	10800000	11999999
Total	number	of	pulses	in	waveform	=	19			

Unless otherwise stated the results shown in this test report refer only to the sample(s) tested and such sample(s) are retained for 90 days only.

除非另有說明，此報告結果僅對測試之樣品負責，同時此樣品僅保留90天。本報告未經本公司書面許可，不可部份複製。

This document is issued by the Company subject to its General Conditions of Service printed overleaf, available on request or accessible at www.sgs.com/terms_and_conditions.htm and, for electronic format documents, subject to Terms and Conditions for Electronic Documents at www.sgs.com/terms_e-document.htm. Attention is drawn to the limitation of liability, indemnification and jurisdiction issues defined therein. Any holder of this document is advised that information contained hereon reflects the Company's findings at the time of its intervention only and within the limits of Client's instructions, if any. The Company's sole responsibility is to its Client and this document does not exonerate parties to a transaction from exercising all their rights and obligations under the transaction documents. This document cannot be reproduced except in full, without prior written approval of the Company. Any unauthorized alteration, forgery or falsification of the content or appearance of this document is unlawful and offenders may be prosecuted to the fullest extent of the law.

Radar Type 5 for 802.11a 5500 MHz

Waveform Num =	12
Num of Bursts =	18
Burst Interval (us)	666667

Burst #	OffTime (us)	# Pulses	Chirp (MHz)	PW (us)	Pulse1 Pri(us)	Pulse2 Pri(us)	Pulse3 Pri(us)	StartLoc (us)	StartBurst Interval(us)	EndBurst Interval(us)
1	197524	2	17	80	1254	1372	0	197524	0	666666
2	659509	2	13	100	1276	1486	0	859659	666667	1333333
3	759178	3	7	70	1491	1706	1912	1621599	1333334	2000000
4	756700	2	8	55	1652	1198	0	2383408	2000001	2666667
5	331191	3	15	70	1484	1631	1865	2717449	2666668	3333334
6	1020485	3	13	100	1428	1070	1543	3742914	3333335	4000001
7	290126	3	20	80	1366	1972	1753	4037081	4000002	4666668
8	672810	3	6	85	1974	1454	1704	4714982	4666669	5333335
9	974907	1	14	80	1834	0	0	5695021	5333336	6000002
10	871954	3	18	95	1593	1903	1191	6568809	6000003	6666669
11	647832	3	10	90	1622	1477	1052	7221328	6666670	7333336
12	281259	1	16	55	1230	0	0	7506738	7333337	8000003
13	695065	3	14	70	1562	1455	1464	8203033	8000004	8666670
14	839702	2	19	95	1118	1071	0	9047216	8666671	9333337
15	351573	3	13	90	1016	1805	1965	9400978	9333338	10000004
16	1013800	1	16	70	1182	0	0	10419564	10000005	10666671
17	715416	1	9	55	1679	0	0	11136162	10666672	11333338
18	236567	2	12	75	1800	1312	0	11374408	11333339	12000005
Total	number	of	pulses	in	waveform	=	41			

Radar Type 5 for 802.11a 5500 MHz

Waveform Num =	13
Num of Bursts =	12
Burst Interval (us)	1000000

Burst #	OffTime (us)	# Pulses	Chirp (MHz)	PW (us)	Pulse1 Pri(us)	Pulse2 Pri(us)	Pulse3 Pri(us)	StartLoc (us)	StartBurst Interval(us)	EndBurst Interval(us)
1	6662	3	9	95	1123	1013	1250	6662	0	999999
2	1393861	3	5	75	1452	1818	1030	1403909	1000000	1999999
3	1581755	2	11	55	1750	1346	0	2989964	2000000	2999999
4	950241	2	19	60	1587	1577	0	3943301	3000000	3999999
5	876058	1	17	70	1814	0	0	4822523	4000000	4999999
6	1107466	1	5	60	1662	0	0	5931803	5000000	5999999
7	870824	3	10	95	1366	1531	1216	6804289	6000000	6999999
8	795788	2	14	90	1453	1094	0	7604190	7000000	7999999
9	1133495	3	16	60	1613	1422	1588	8740232	8000000	8999999
10	1143864	3	5	95	1057	1791	1688	9888719	9000000	9999999
11	647335	1	6	75	1614	0	0	10540590	10000000	10999999
12	933337	3	7	100	1599	1348	1212	11475541	11000000	11999999
Total	number	of	pulses	in	waveform	=	27			

Unless otherwise stated the results shown in this test report refer only to the sample(s) tested and such sample(s) are retained for 90 days only.

除非另有說明，此報告結果僅對測試之樣品負責，同時此樣品僅保留90天。本報告未經本公司書面許可，不可部份複製。

This document is issued by the Company subject to its General Conditions of Service printed overleaf, available on request or accessible at www.sgs.com/terms_and_conditions.htm and, for electronic format documents, subject to Terms and Conditions for Electronic Documents at www.sgs.com/terms_e-document.htm. Attention is drawn to the limitation of liability, indemnification and jurisdiction issues defined therein. Any holder of this document is advised that information contained hereon reflects the Company's findings at the time of its intervention only and within the limits of Client's instructions, if any. The Company's sole responsibility is to its Client and this document does not exonerate parties to a transaction from exercising all their rights and obligations under the transaction documents. This document cannot be reproduced except in full, without prior written approval of the Company. Any unauthorized alteration, forgery or falsification of the content or appearance of this document is unlawful and offenders may be prosecuted to the fullest extent of the law.

SGS Taiwan Ltd.

No.134,WuKungRoad,NewTaipeiIndustrialPark,WukuDistrict,NewTaipeiCity,Taiwan24803/新北市五股區新北產業園區五工路 134 號

台灣檢驗科技股份有限公司

t (886-2) 2299-3279

f (886-2) 2298-0488

www.tw.sgs.com

Member of SGS Group

Radar Type 5 for 802.11a 5500 MHz

Waveform Num =	14
Num of Bursts =	8
Burst Interval (us)	1500000

Burst #	OffTime (us)	# Pulses	Chirp (MHz)	PW (us)	Pulse1 Pri(us)	Pulse2 Pri(us)	Pulse3 Pri(us)	StartLoc (us)	StartBurst Interval(us)	EndBurst Interval(us)
1	163278	2	16	80	1269	1943	0	163278	0	1499999
2	2448245	1	11	100	1005	0	0	2614735	1500000	2999999
3	1340322	2	16	60	1729	1801	0	3956062	3000000	4499999
4	1604425	3	20	80	1761	1002	1514	5564017	4500000	5999999
5	1474510	2	10	100	1964	1054	0	7042804	6000000	7499999
6	1940862	1	17	75	1124	0	0	8986684	7500000	8999999
7	1099186	2	10	85	1215	1307	0	10086994	9000000	10499999
8	1813420	1	7	55	1455	0	0	11902936	10500000	11999999
Total	number	of	pulses	in	waveform	=	14			

Radar Type 5 for 802.11a 5500 MHz

Waveform Num =	15
Num of Bursts =	11
Burst Interval (us)	1090909

Burst #	OffTime (us)	# Pulses	Chirp (MHz)	PW (us)	Pulse1 Pri(us)	Pulse2 Pri(us)	Pulse3 Pri(us)	StartLoc (us)	StartBurst Interval(us)	EndBurst Interval(us)
1	648360	1	14	90	1975	0	0	648360	0	1090908
2	618329	3	10	50	1370	1860	1956	1268664	1090909	2181817
3	1479134	2	10	55	1766	1431	0	2752984	2181818	3272726
4	649329	3	19	90	1088	1363	1405	3405510	3272727	4363635
5	962651	1	14	50	1764	0	0	4372017	4363636	5454544
6	2160564	3	7	65	1588	1685	1735	6534345	5454545	6545453
7	410685	3	8	50	1539	1716	1303	6950038	6545454	7636362
8	1327682	1	17	55	1304	0	0	8282278	7636363	8727271
9	1435418	3	10	90	1150	1652	1934	9719000	8727272	9818180
10	949656	3	15	100	1683	1138	1777	10673392	9818181	10909089
11	812340	1	8	50	1315	0	0	11490330	10909090	11999998
Total	number	of	pulses	in	waveform	=	24			

Unless otherwise stated the results shown in this test report refer only to the sample(s) tested and such sample(s) are retained for 90 days only.

除非另有說明，此報告結果僅對測試之樣品負責，同時此樣品僅保留90天。本報告未經本公司書面許可，不可部份複製。

This document is issued by the Company subject to its General Conditions of Service printed overleaf, available on request or accessible at www.sgs.com/terms_and_conditions.htm and, for electronic format documents, subject to Terms and Conditions for Electronic Documents at www.sgs.com/terms_e-document.htm. Attention is drawn to the limitation of liability, indemnification and jurisdiction issues defined therein. Any holder of this document is advised that information contained hereon reflects the Company's findings at the time of its intervention only and within the limits of Client's instructions, if any. The Company's sole responsibility is to its Client and this document does not exonerate parties to a transaction from exercising all their rights and obligations under the transaction documents. This document cannot be reproduced except in full, without prior written approval of the Company. Any unauthorized alteration, forgery or falsification of the content or appearance of this document is unlawful and offenders may be prosecuted to the fullest extent of the law.

SGS Taiwan Ltd.

No.134,WuKungRoad,NewTaipeiIndustrialPark,WukuDistrict,NewTaipeiCity,Taiwan24803/新北市五股區新北產業園區五工路 134 號

台灣檢驗科技股份有限公司

t (886-2) 2299-3279

f (886-2) 2298-0488

www.tw.sgs.com

Member of SGS Group

Radar Type 5 for 802.11a 5500 MHz

Waveform Num =	16
Num of Bursts =	9
Burst Interval (us)	1333333

Burst #	OffTime (us)	# Pulses	Chirp (MHz)	PW (us)	Pulse1 Pri(us)	Pulse2 Pri(us)	Pulse3 Pri(us)	StartLoc (us)	StartBurst Interval(us)	EndBurst Interval(us)
1	1240924	3	9	65	1762	1437	1961	1240924	0	1333332
2	992020	3	11	90	1574	1213	1557	2238104	1333333	2666665
3	547053	1	9	70	1208	0	0	2789501	2666666	3999998
4	2445860	2	10	100	1829	1228	0	5236569	3999999	5333331
5	410904	1	7	90	1774	0	0	5650530	5333332	6666664
6	2146300	3	5	80	1754	1910	1578	7798604	6666665	7999997
7	648693	1	7	95	1128	0	0	8452539	7999998	9333330
8	1046685	3	7	95	1183	1088	1389	9500352	9333331	10666663
9	1547122	3	14	80	1082	1243	1431	11051134	10666664	11999996
Total	number	of	pulses	in	waveform	=	20			

Radar Type 5 for 802.11a 5500 MHz

Waveform Num =	17
Num of Bursts =	9
Burst Interval (us)	1333333

Burst #	OffTime (us)	# Pulses	Chirp (MHz)	PW (us)	Pulse1 Pri(us)	Pulse2 Pri(us)	Pulse3 Pri(us)	StartLoc (us)	StartBurst Interval(us)	EndBurst Interval(us)
1	766481	2	8	100	1701	1375	0	766481	0	1333332
2	1339217	3	15	80	1706	1966	1361	2108774	1333333	2666665
3	1879978	3	13	85	1074	1699	1453	3993785	2666666	3999998
4	396355	3	19	70	1090	1366	1370	4394366	3999999	5333331
5	1617113	2	11	80	1678	1180	0	6015305	5333332	6666664
6	1437084	1	14	85	1183	0	0	7455247	6666665	7999997
7	578776	2	16	80	1366	1198	0	8035206	7999998	9333330
8	1845609	2	10	65	1626	1306	0	9883379	9333331	10666663
9	1782224	1	17	75	1025	0	0	11668535	10666664	11999996
Total	number	of	pulses	in	waveform	=	19			

Unless otherwise stated the results shown in this test report refer only to the sample(s) tested and such sample(s) are retained for 90 days only.

除非另有說明，此報告結果僅對測試之樣品負責，同時此樣品僅保留90天。本報告未經本公司書面許可，不可部份複製。

This document is issued by the Company subject to its General Conditions of Service printed overleaf, available on request or accessible at www.sgs.com/terms_and_conditions.htm and, for electronic format documents, subject to Terms and Conditions for Electronic Documents at www.sgs.com/terms_e-document.htm. Attention is drawn to the limitation of liability, indemnification and jurisdiction issues defined therein. Any holder of this document is advised that information contained hereon reflects the Company's findings at the time of its intervention only and within the limits of Client's instructions, if any. The Company's sole responsibility is to its Client and this document does not exonerate parties to a transaction from exercising all their rights and obligations under the transaction documents. This document cannot be reproduced except in full, without prior written approval of the Company. Any unauthorized alteration, forgery or falsification of the content or appearance of this document is unlawful and offenders may be prosecuted to the fullest extent of the law.

SGS Taiwan Ltd.

No.134,WuKungRoad,NewTaipeiIndustrialPark,WukuDistrict,NewTaipeiCity,Taiwan24803/新北市五股區新北產業園區五工路 134 號

台灣檢驗科技股份有限公司

t (886-2) 2299-3279

f (886-2) 2298-0488

www.tw.sgs.com

Member of SGS Group

Radar Type 5 for 802.11a 5500 MHz

Waveform Num =	18
Num of Bursts =	17
Burst Interval (us)	705882

Burst #	OffTime (us)	# Pulses	Chirp (MHz)	PW (us)	Pulse1 Pri(us)	Pulse2 Pri(us)	Pulse3 Pri(us)	StartLoc (us)	StartBurst Interval(us)	EndBurst Interval(us)
1	291820	3	13	60	1087	1496	1864	291820	0	705881
2	999893	2	5	60	1518	1906	0	1296160	705882	1411763
3	804107	3	11	70	1890	1976	1956	2103691	1411764	2117645
4	296117	3	9	55	1111	1420	1355	2405630	2117646	2823527
5	906806	2	7	50	1871	1610	0	3316322	2823528	3529409
6	373339	3	11	95	1373	1360	1547	3693142	3529410	4235291
7	1159232	2	13	85	1914	1170	0	4856654	4235292	4941173
8	424856	3	19	55	1296	1706	1600	5284594	4941174	5647055
9	751239	1	19	85	1321	0	0	6040435	5647056	6352937
10	1005489	1	13	55	1778	0	0	7047245	6352938	7058819
11	83640	2	9	85	1151	1162	0	7132663	7058820	7764701
12	968269	2	18	85	1927	1417	0	8103245	7764702	8470583
13	599586	2	11	65	1889	1143	0	8706175	8470584	9176465
14	1040886	1	10	95	1317	0	0	9750093	9176466	9882347
15	207899	1	11	55	1389	0	0	9959309	9882348	10588229
16	1180032	3	18	65	1943	1802	1897	11140730	10588230	11294111
17	441626	1	9	75	1066	0	0	11587998	11294112	11999993
Total	number	of	pulses	in	waveform	=	35			

Radar Type 5 for 802.11a 5500 MHz

Waveform Num =	19
Num of Bursts =	13
Burst Interval (us)	923077

Burst #	OffTime (us)	# Pulses	Chirp (MHz)	PW (us)	Pulse1 Pri(us)	Pulse2 Pri(us)	Pulse3 Pri(us)	StartLoc (us)	StartBurst Interval(us)	EndBurst Interval(us)
1	593333	2	9	100	1817	1856	0	593333	0	923076
2	638682	3	12	75	1471	1796	1489	1235688	923077	1846153
3	1163128	1	19	85	1557	0	0	2403572	1846154	2769230
4	1181043	3	13	90	1815	1676	1870	3586172	2769231	3692307
5	903256	1	13	75	1893	0	0	4494789	3692308	4615384
6	333485	3	5	50	1078	1484	1392	4830167	4615385	5538461
7	1382529	1	9	95	1660	0	0	6216650	5538462	6461538
8	243807	2	6	85	1661	1968	0	6462117	6461539	7384615
9	1172437	3	20	75	1871	1944	1633	7638183	7384616	8307692
10	1131603	3	9	70	1466	1866	1055	8775234	8307693	9230769
11	1028392	2	6	75	1872	1255	0	9808013	9230770	10153846
12	880396	3	8	75	1744	1626	1933	10691536	10153847	11076923
13	491262	2	14	80	1829	1186	0	11188101	11076924	12000000
Total	number	of	pulses	in	waveform	=	29			

Unless otherwise stated the results shown in this test report refer only to the sample(s) tested and such sample(s) are retained for 90 days only.

除非另有說明，此報告結果僅對測試之樣品負責，同時此樣品僅保留90天。本報告未經本公司書面許可，不可部份複製。

This document is issued by the Company subject to its General Conditions of Service printed overleaf, available on request or accessible at www.sgs.com/terms_and_conditions.htm and, for electronic format documents, subject to Terms and Conditions for Electronic Documents at www.sgs.com/terms_e-document.htm. Attention is drawn to the limitation of liability, indemnification and jurisdiction issues defined therein. Any holder of this document is advised that information contained hereon reflects the Company's findings at the time of its intervention only and within the limits of Client's instructions, if any. The Company's sole responsibility is to its Client and this document does not exonerate parties to a transaction from exercising all their rights and obligations under the transaction documents. This document cannot be reproduced except in full, without prior written approval of the Company. Any unauthorized alteration, forgery or falsification of the content or appearance of this document is unlawful and offenders may be prosecuted to the fullest extent of the law.

SGS Taiwan Ltd.

No.134,WuKungRoad,NewTaipeiIndustrialPark,WukuDistrict,NewTaipeiCity,Taiwan24803/新北市五股區新北產業園區五工路 134 號

台灣檢驗科技股份有限公司

t (886-2) 2299-3279

f (886-2) 2298-0488

www.tw.sgs.com

Member of SGS Group

Radar Type 5 for 802.11a 5500 MHz

Waveform Num =	20
Num of Bursts =	8
Burst Interval (us)	1500000

Burst #	OffTime (us)	# Pulses	Chirp (MHz)	PW (us)	Pulse1 Pri(us)	Pulse2 Pri(us)	Pulse3 Pri(us)	StartLoc (us)	StartBurst Interval(us)	EndBurst Interval(us)
1	509564	3	8	100	1609	1437	1152	509564	0	1499999
2	1308966	3	20	100	1834	1957	1822	1822728	1500000	2999999
3	1669109	1	19	95	1856	0	0	3497450	3000000	4499999
4	2365439	2	20	85	1830	1572	0	5864745	4500000	5999999
5	1462349	3	20	50	1339	1328	1673	7330496	6000000	7499999
6	862228	3	11	100	1272	1004	1781	8197064	7500000	8999999
7	2123947	2	9	90	1148	1642	0	10325068	9000000	10499999
8	452749	3	16	75	1593	1619	1896	10780607	10500000	11999999
Total	number	of	pulses	in	waveform	=	20			

Radar Type 5 for 802.11a 5500 MHz

Waveform Num =	21
Num of Bursts =	8
Burst Interval (us)	1500000

Burst #	OffTime (us)	# Pulses	Chirp (MHz)	PW (us)	Pulse1 Pri(us)	Pulse2 Pri(us)	Pulse3 Pri(us)	StartLoc (us)	StartBurst Interval(us)	EndBurst Interval(us)
1	788564	3	14	65	1303	1710	1452	788564	0	1499999
2	1218327	3	20	60	1754	1064	1836	2011356	1500000	2999999
3	2244385	2	7	60	1129	1301	0	4260395	3000000	4499999
4	985169	3	11	75	1299	1208	1751	5247994	4500000	5999999
5	1077381	2	7	100	1047	1935	0	6329633	6000000	7499999
6	2250305	2	15	95	1732	1554	0	8582920	7500000	8999999
7	1515654	3	17	60	1282	1502	1447	10101860	9000000	10499999
8	724835	3	18	50	1138	1746	1094	10830926	10500000	11999999
Total	number	of	pulses	in	waveform	=	21			

Unless otherwise stated the results shown in this test report refer only to the sample(s) tested and such sample(s) are retained for 90 days only.

除非另有說明，此報告結果僅對測試之樣品負責，同時此樣品僅保留90天。本報告未經本公司書面許可，不可部份複製。

This document is issued by the Company subject to its General Conditions of Service printed overleaf, available on request or accessible at www.sgs.com/terms_and_conditions.htm and, for electronic format documents, subject to Terms and Conditions for Electronic Documents at www.sgs.com/terms_e-document.htm. Attention is drawn to the limitation of liability, indemnification and jurisdiction issues defined therein. Any holder of this document is advised that information contained hereon reflects the Company's findings at the time of its intervention only and within the limits of Client's instructions, if any. The Company's sole responsibility is to its Client and this document does not exonerate parties to a transaction from exercising all their rights and obligations under the transaction documents. This document cannot be reproduced except in full, without prior written approval of the Company. Any unauthorized alteration, forgery or falsification of the content or appearance of this document is unlawful and offenders may be prosecuted to the fullest extent of the law.

SGS Taiwan Ltd.

No.134,WuKungRoad,NewTaipeiIndustrialPark,WukuDistrict,NewTaipeiCity,Taiwan24803/新北市五股區新北產業園區五工路 134 號

台灣檢驗科技股份有限公司

t (886-2) 2299-3279

f (886-2) 2298-0488

www.tw.sgs.com

Member of SGS Group

Radar Type 5 for 802.11a 5500 MHz

Waveform Num =	22
Num of Bursts =	17
Burst Interval (us)	705882

Burst #	OffTime (us)	# Pulses	Chirp (MHz)	PW (us)	Pulse1 Pri(us)	Pulse2 Pri(us)	Pulse3 Pri(us)	StartLoc (us)	StartBurst Interval(us)	EndBurst Interval(us)
1	323647	2	15	85	1648	1170	0	323647	0	705881
2	699520	3	13	70	1980	1494	1412	1025985	705882	1411763
3	630545	2	8	100	1069	1963	0	1661416	1411764	2117645
4	497674	3	9	80	1067	1246	1048	2162122	2117646	2823527
5	1357533	2	20	75	1970	1287	0	3523016	2823528	3529409
6	194528	1	15	55	1125	0	0	3720801	3529410	4235291
7	734621	2	8	85	1366	1608	0	4456547	4235292	4941173
8	956376	3	13	55	1095	1935	1163	5415897	4941174	5647055
9	629610	1	8	70	1561	0	0	6049700	5647056	6352937
10	989943	2	8	55	1611	1484	0	7041204	6352938	7058819
11	275962	2	7	55	1295	1121	0	7320261	7058820	7764701
12	920822	2	10	50	1818	1682	0	8243499	7764702	8470583
13	447554	2	6	85	1476	1483	0	8694553	8470584	9176465
14	1153523	1	15	70	1385	0	0	9851035	9176466	9882347
15	497419	3	15	95	1524	1093	1291	10349839	9882348	10588229
16	771373	2	19	55	1585	1934	0	11125120	10588230	11294111
17	472826	1	11	85	1496	0	0	11601465	11294112	11999993
Total	number	of	pulses	in	waveform	=	34			

Waveform Num =	
Num of Bursts =	
Burst Interval (us) =	14

Burst Interval (us)=	857143
----------------------	--------

Burst #	OffTime (us)	# Pulses	Chirp (MHz)	PW (us)	Pulse1 Pri(us)	Pulse2 Pri(us)	Pulse3 Pri(us)	StartLoc (us)	StartBurst Interval(us)	EndBurst Interval(us)
1	48690	3	8	65	1230	1076	1846	48690	0	857142
2	1434212	2	14	100	1708	1764	0	1487054	857143	1714285
3	933321	2	8	80	1523	1506	0	2423847	1714286	2571428
4	776581	3	11	75	1062	1311	1014	3203457	2571429	3428571
5	821679	2	7	70	1050	1142	0	4028523	3428572	4285714
6	449803	2	6	100	1697	1314	0	4480518	4285715	5142857
7	840955	2	16	75	1962	1481	0	5324484	5142858	6000000
8	1335007	1	12	95	1685	0	0	6662934	6000001	6857143
9	891800	1	16	55	1873	0	0	7556419	6857144	7714286
10	415240	1	18	50	1093	0	0	7973532	7714287	8571429
11	1226832	1	10	90	1397	0	0	9201457	8571430	9428572
12	1013446	3	17	65	1311	1356	1449	10216300	9428573	10285715
13	320863	3	14	95	1837	1162	1187	10541279	10285716	11142858
14	850881	3	9	85	1298	1316	1676	11396346	11142859	12000001
Total	number	of	pulses	in	waveform	=	29			

Unless otherwise stated the results shown in this test report refer only to the sample(s) tested and such sample(s) are retained for 90 days only.

除非另有說明，此報告結果僅對測試之樣品負責，同時此樣品僅保留90天。本報告未經本公司書面許可，不可部份複製。

This document is issued by the Company subject to its General Conditions of Service printed overleaf, available on request or accessible at www.sgs.com/terms_and_conditions.htm and, for electronic format documents, subject to Terms and Conditions for Electronic Documents at www.sgs.com/terms_e-document.htm. Attention is drawn to the limitation of liability, indemnification and jurisdiction issues defined therein. Any holder of this document is advised that information contained hereon reflects the Company's findings at the time of its intervention only and within the limits of Client's instructions, if any. The Company's sole responsibility is to its Client and this document does not exonerate parties to a transaction from exercising all their rights and obligations under the transaction documents. This document cannot be reproduced except in full, without prior written approval of the Company. Any unauthorized alteration, forgery or falsification of the content or appearance of this document is unlawful and offenders may be prosecuted to the fullest extent of the law.

SGS Taiwan Ltd.

No.134,WuKungRoad,NewTaipeiIndustrialPark,WukuDistrict,NewTaipeiCity,Taiwan24803/新北市五股區新北產業園區五工路 134 號

台灣檢驗科技股份有限公司

t (886-2) 2299-3279

f (886-2) 2298-0488

www.tw.sgs.com

Member of SGS Group

Radar Type 5 for 802.11a 5500 MHz

Waveform Num =	24
Num of Bursts =	14
Burst Interval (us)	857143

Burst #	OffTime (us)	# Pulses	Chirp (MHz)	PW (us)	Pulse1 Pri(us)	Pulse2 Pri(us)	Pulse3 Pri(us)	StartLoc (us)	StartBurst Interval(us)	EndBurst Interval(us)
1	583322	3	14	65	1625	1436	1514	583322	0	857142
2	321634	1	8	55	1772	0	0	909531	857143	1714285
3	1142087	1	7	100	1315	0	0	2053390	1714286	2571428
4	922108	1	7	60	1546	0	0	2976813	2571429	3428571
5	539617	3	5	95	1909	1046	1674	3517976	3428572	4285714
6	1180407	2	19	50	1758	1856	0	4703012	4285715	5142857
7	747435	3	16	85	1636	1331	1610	5454061	5142858	6000000
8	609640	1	9	75	1571	0	0	6068278	6000001	6857143
9	1100096	3	13	80	1489	1651	1755	7169945	6857144	7714286
10	548446	3	10	90	1956	1134	1725	7723286	7714287	8571429
11	967975	3	5	100	1470	1956	1481	8696076	8571430	9428572
12	1275378	3	9	65	1652	1797	1355	9976361	9428573	10285715
13	536716	1	10	80	1610	0	0	10517881	10285716	11142858
14	1315591	3	18	50	1688	1389	1229	11835082	11142859	12000001
Total	number	of	pulses	in	waveform	=	31			

Radar Type 5 for 802.11a 5500 MHz

Waveform Num =	25
Num of Bursts =	17
Burst Interval (us)	705882

Burst #	OffTime (us)	# Pulses	Chirp (MHz)	PW (us)	Pulse1 Pri(us)	Pulse2 Pri(us)	Pulse3 Pri(us)	StartLoc (us)	StartBurst Interval(us)	EndBurst Interval(us)
1	7479	1	10	60	1644	0	0	7479	0	705881
2	1217810	2	16	70	1639	1825	0	1226933	705882	1411763
3	509618	3	18	95	1010	1289	1489	1740015	1411764	2117645
4	1053300	3	12	100	1077	1157	1739	2797103	2117646	2823527
5	548770	1	11	80	1603	0	0	3349846	2823528	3529409
6	560472	3	12	75	1712	1902	1318	3911921	3529410	4235291
7	657664	1	14	95	1332	0	0	4574517	4235292	4941173
8	897645	2	19	75	1604	1782	0	5473494	4941174	5647055
9	702285	3	17	85	1192	1545	1255	6179165	5647056	6352937
10	767890	2	17	100	1737	1931	0	6951047	6352938	7058819
11	527112	1	11	100	1792	0	0	7481827	7058820	7764701
12	813853	1	12	100	1476	0	0	8297472	7764702	8470583
13	422619	2	15	70	1801	1084	0	8721567	8470584	9176465
14	926590	3	10	50	1645	1348	1053	9651042	9176466	9882347
15	616407	1	5	95	1102	0	0	10271495	9882348	10588229
16	827369	1	18	50	1872	0	0	11099966	10588230	11294111
17	683818	2	11	75	1447	1901	0	11785656	11294112	11999993
Total	number	of	pulses	in	waveform	=	32			

Unless otherwise stated the results shown in this test report refer only to the sample(s) tested and such sample(s) are retained for 90 days only.

除非另有說明，此報告結果僅對測試之樣品負責，同時此樣品僅保留90天。本報告未經本公司書面許可，不可部份複製。

This document is issued by the Company subject to its General Conditions of Service printed overleaf, available on request or accessible at www.sgs.com/terms_and_conditions.htm and, for electronic format documents, subject to Terms and Conditions for Electronic Documents at www.sgs.com/terms_e-document.htm. Attention is drawn to the limitation of liability, indemnification and jurisdiction issues defined therein. Any holder of this document is advised that information contained hereon reflects the Company's findings at the time of its intervention only and within the limits of Client's instructions, if any. The Company's sole responsibility is to its Client and this document does not exonerate parties to a transaction from exercising all their rights and obligations under the transaction documents. This document cannot be reproduced except in full, without prior written approval of the Company. Any unauthorized alteration, forgery or falsification of the content or appearance of this document is unlawful and offenders may be prosecuted to the fullest extent of the law.

SGS Taiwan Ltd.

No.134,WuKungRoad,NewTaipeiIndustrialPark,WukuDistrict,NewTaipeiCity,Taiwan24803/新北市五股區新北產業園區五工路 134 號

台灣檢驗科技股份有限公司

t (886-2) 2299-3279

f (886-2) 2298-0488

www.tw.sgs.com

Member of SGS Group

Radar Type 5 for 802.11a 5500 MHz

Waveform Num =	26
Num of Bursts =	17
Burst Interval (us)	705882

Burst #	OffTime (us)	# Pulses	Chirp (MHz)	PW (us)	Pulse1 Pri(us)	Pulse2 Pri(us)	Pulse3 Pri(us)	StartLoc (us)	StartBurst Interval(us)	EndBurst Interval(us)
1	302938	2	15	95	1567	1485	0	302938	0	705881
2	601498	3	6	100	1893	1852	1175	907488	705882	1411763
3	820338	2	16	75	1903	1634	0	1732746	1411764	2117645
4	548187	2	7	55	1256	1035	0	2284470	2117646	2823527
5	900010	3	5	80	1408	1545	1191	3186771	2823528	3529409
6	773354	2	20	85	1801	1269	0	3964269	3529410	4235291
7	564964	2	13	50	1386	1903	0	4532303	4235292	4941173
8	1094766	2	6	80	1191	1415	0	5630358	4941174	5647055
9	599699	3	11	55	1887	1096	1509	6232663	5647056	6352937
10	761940	1	16	100	1526	0	0	6999095	6352938	7058819
11	268809	3	20	65	1198	1999	1036	7269430	7058820	7764701
12	681682	1	5	50	1136	0	0	7955345	7764702	8470583
13	541492	1	15	80	1075	0	0	8497973	8470584	9176465
14	1075459	2	20	70	1064	1727	0	9574507	9176466	9882347
15	716128	2	12	80	1840	1290	0	10293426	9882348	10588229
16	432810	1	14	90	1418	0	0	10729366	10588230	11294111
17	1255806	1	15	95	1804	0	0	11986590	11294112	11999993
Total	number	of	pulses	in	waveform	=	33			

Radar Type 5 for 802.11a 5500 MHz

Waveform Num =	27
Num of Bursts =	11
Burst Interval (us)	1090909

Burst #	OffTime (us)	# Pulses	Chirp (MHz)	PW (us)	Pulse1 Pri(us)	Pulse2 Pri(us)	Pulse3 Pri(us)	StartLoc (us)	StartBurst Interval(us)	EndBurst Interval(us)
1	426532	1	20	55	1981	0	0	426532	0	1090908
2	1588205	1	14	50	1581	0	0	2016718	1090909	2181817
3	594110	3	20	55	1030	1845	1105	2612409	2181818	3272726
4	1140492	3	17	75	1077	1383	1008	3756881	3272727	4363635
5	862088	2	8	65	1095	1954	0	4622437	4363636	5454544
6	1820215	2	10	60	1937	1392	0	6445701	5454545	6545453
7	543357	3	18	55	1874	1978	1841	6992387	6545454	7636362
8	1202036	1	16	55	1512	0	0	8200116	7636363	8727271
9	1400437	3	19	100	1635	1572	1175	9602065	8727272	9818180
10	581957	2	16	85	1200	1206	0	10188404	9818181	10909089
11	1072929	3	20	75	1010	1355	1528	11263739	10909090	11999998
Total	number	of	pulses	in	waveform	=	24			

Unless otherwise stated the results shown in this test report refer only to the sample(s) tested and such sample(s) are retained for 90 days only.

除非另有說明，此報告結果僅對測試之樣品負責，同時此樣品僅保留90天。本報告未經本公司書面許可，不可部份複製。

This document is issued by the Company subject to its General Conditions of Service printed overleaf, available on request or accessible at www.sgs.com/terms_and_conditions.htm and, for electronic format documents, subject to Terms and Conditions for Electronic Documents at www.sgs.com/terms_e-document.htm. Attention is drawn to the limitation of liability, indemnification and jurisdiction issues defined therein. Any holder of this document is advised that information contained hereon reflects the Company's findings at the time of its intervention only and within the limits of Client's instructions, if any. The Company's sole responsibility is to its Client and this document does not exonerate parties to a transaction from exercising all their rights and obligations under the transaction documents. This document cannot be reproduced except in full, without prior written approval of the Company. Any unauthorized alteration, forgery or falsification of the content or appearance of this document is unlawful and offenders may be prosecuted to the fullest extent of the law.

Radar Type 5 for 802.11a 5500 MHz

Waveform Num =	28
Num of Bursts =	11
Burst Interval (us)	1090909

Burst #	OffTime (us)	# Pulses	Chirp (MHz)	PW (us)	Pulse1 Pri(us)	Pulse2 Pri(us)	Pulse3 Pri(us)	StartLoc (us)	StartBurst Interval(us)	EndBurst Interval(us)
1	427873	3	8	65	1679	1608	1316	427873	0	1090908
2	1677503	2	11	75	1474	1822	0	2109979	1090909	2181817
3	100195	2	13	55	1793	1557	0	2213470	2181818	3272726
4	1253479	1	18	85	1101	0	0	3470299	3272727	4363635
5	1272046	3	11	75	1833	1278	1400	4743446	4363636	5454544
6	840651	2	9	90	1440	1758	0	5588608	5454545	6545453
7	1561534	2	14	85	1824	1505	0	7153340	6545454	7636362
8	777911	1	18	55	1727	0	0	7934580	7636363	8727271
9	1729338	1	8	80	1042	0	0	9665645	8727272	9818180
10	922379	2	19	80	1273	1640	0	10589066	9818181	10909089
11	698275	3	7	55	1880	1789	1728	11290254	10909090	11999998
Total	number	of	pulses	in	waveform	=	22			

Radar Type 5 for 802.11a 5500 MHz

Waveform Num =	29
Num of Bursts =	8
Burst Interval (us)	1500000

Burst #	OffTime (us)	# Pulses	Chirp (MHz)	PW (us)	Pulse1 Pri(us)	Pulse2 Pri(us)	Pulse3 Pri(us)	StartLoc (us)	StartBurst Interval(us)	EndBurst Interval(us)
1	499220	2	13	75	1325	1603	0	499220	0	1499999
2	1931547	3	15	50	1164	1373	1535	2433695	1500000	2999999
3	900424	3	9	65	1649	1624	1485	3338191	3000000	4499999
4	2197455	3	5	70	1316	1476	1431	5540404	4500000	5999999
5	1380929	1	16	60	1991	0	0	6925556	6000000	7499999
6	719790	3	7	95	1404	1564	1857	7647337	7500000	8999999
7	1671086	3	18	90	1271	1420	1231	9323248	9000000	10499999
8	2629396	2	19	100	1509	1200	0	11956566	10500000	11999999
Total	number	of	pulses	in	waveform	=	20			

Unless otherwise stated the results shown in this test report refer only to the sample(s) tested and such sample(s) are retained for 90 days only.

除非另有說明，此報告結果僅對測試之樣品負責，同時此樣品僅保留90天。本報告未經本公司書面許可，不可部份複製。

This document is issued by the Company subject to its General Conditions of Service printed overleaf, available on request or accessible at www.sgs.com/terms_and_conditions.htm and, for electronic format documents, subject to Terms and Conditions for Electronic Documents at www.sgs.com/terms_e-document.htm. Attention is drawn to the limitation of liability, indemnification and jurisdiction issues defined therein. Any holder of this document is advised that information contained hereon reflects the Company's findings at the time of its intervention only and within the limits of Client's instructions, if any. The Company's sole responsibility is to its Client and this document does not exonerate parties to a transaction from exercising all their rights and obligations under the transaction documents. This document cannot be reproduced except in full, without prior written approval of the Company. Any unauthorized alteration, forgery or falsification of the content or appearance of this document is unlawful and offenders may be prosecuted to the fullest extent of the law.

SGS Taiwan Ltd.

No.134,WuKungRoad,NewTaipeiIndustrialPark,WukuDistrict,NewTaipeiCity,Taiwan24803/新北市五股區新北產業園區五工路 134 號

台灣檢驗科技股份有限公司

t (886-2) 2299-3279

f (886-2) 2298-0488

www.tw.sgs.com

Member of SGS Group

Radar Type 5 for 802.11a 5500 MHz

Waveform Num =	30
Num of Bursts =	14
Burst Interval (us)	857143

Burst #	OffTime (us)	# Pulses	Chirp (MHz)	PW (us)	Pulse1 Pri(us)	Pulse2 Pri(us)	Pulse3 Pri(us)	StartLoc (us)	StartBurst Interval(us)	EndBurst Interval(us)
1	396276	2	9	100	1799	1152	0	396276	0	857142
2	1282691	1	11	50	1078	0	0	1681918	857143	1714285
3	431487	3	8	50	1467	1822	1742	2114483	1714286	2571428
4	1160561	2	15	85	1558	1390	0	3280075	2571429	3428571
5	279552	3	5	75	1618	1720	1186	3562575	3428572	4285714
6	1173253	1	5	70	1116	0	0	4740352	4285715	5142857
7	955218	3	11	85	1258	1559	1137	5696686	5142858	6000000
8	888856	1	19	85	1077	0	0	6589496	6000001	6857143
9	1119676	1	18	85	1727	0	0	7710249	6857144	7714286
10	686506	1	5	90	1905	0	0	8398482	7714287	8571429
11	460186	2	19	65	1256	1342	0	8860573	8571430	9428572
12	1047670	3	15	60	1689	1613	1696	9910841	9428573	10285715
13	893687	2	6	80	1503	1415	0	10809526	10285716	11142858
14	683740	2	10	100	1486	1035	0	11496184	11142859	12000001
Total	number	of	pulses	in	waveform	=	27			

Unless otherwise stated the results shown in this test report refer only to the sample(s) tested and such sample(s) are retained for 90 days only.

除非另有說明，此報告結果僅對測試之樣品負責，同時此樣品僅保留90天。本報告未經本公司書面許可，不可部份複製。

This document is issued by the Company subject to its General Conditions of Service printed overleaf, available on request or accessible at www.sgs.com/terms_and_conditions.htm and, for electronic format documents, subject to Terms and Conditions for Electronic Documents at www.sgs.com/terms_e-document.htm. Attention is drawn to the limitation of liability, indemnification and jurisdiction issues defined therein. Any holder of this document is advised that information contained hereon reflects the Company's findings at the time of its intervention only and within the limits of Client's instructions, if any. The Company's sole responsibility is to its Client and this document does not exonerate parties to a transaction from exercising all their rights and obligations under the transaction documents. This document cannot be reproduced except in full, without prior written approval of the Company. Any unauthorized alteration, forgery or falsification of the content or appearance of this document is unlawful and offenders may be prosecuted to the fullest extent of the law.

SGS Taiwan Ltd.

No.134,WuKungRoad,NewTaipeiIndustrialPark,WukuDistrict,NewTaipeiCity,Taiwan24803/新北市五股區新北產業園區五工路 134 號

台灣檢驗科技股份有限公司

t (886-2) 2299-3279

f (886-2) 2298-0488

www.tw.sgs.com

Member of SGS Group

802.11n40 5310 MHz

FCC13-22 Radar Test Summary				
Short Pulse Radar Type	Minimum Number of Trials	Detection(%)	Minimum Percentage of Successful Detection(%)	Pass/Fail
1	30	100.00	60	Pass
2	30	100.00	60	Pass
3	30	93.33	60	Pass
4	30	86.66	60	Pass
Aggregate (Radar Types 1-4)	120	95.00	80	Pass
Long Pulse Radar Test Waveform	Minimum Number of Trials	Detection	Minimum Percentage of Successful Detection(Limit)	Pass/Fail
5 - Variable	30	100.00	80	Pass
Frequency Hopping Radar Test Waveform	Minimum Number of Trials	Detection	Minimum Percentage of Successful Detection(Limit)	Pass/Fail
6	30	96.66	70	Pass

Unless otherwise stated the results shown in this test report refer only to the sample(s) tested and such sample(s) are retained for 90 days only.

除非另有說明，此報告結果僅對測試之樣品負責，同時此樣品僅保留90天。本報告未經本公司書面許可，不可部份複製。

This document is issued by the Company subject to its General Conditions of Service printed overleaf, available on request or accessible at www.sgs.com/terms_and_conditions.htm and, for electronic format documents, subject to Terms and Conditions for Electronic Documents at www.sgs.com/terms_e-document.htm. Attention is drawn to the limitation of liability, indemnification and jurisdiction issues defined therein. Any holder of this document is advised that information contained hereon reflects the Company's findings at the time of its intervention only and within the limits of Client's instructions, if any. The Company's sole responsibility is to its Client and this document does not exonerate parties to a transaction from exercising all their rights and obligations under the transaction documents. This document cannot be reproduced except in full, without prior written approval of the Company. Any unauthorized alteration, forgery or falsification of the content or appearance of this document is unlawful and offenders may be prosecuted to the fullest extent of the law.

SGS Taiwan Ltd.

No.134,WuKungRoad,NewTaipeiIndustrialPark,WukuDistrict,NewTaipeiCity,Taiwan24803/新北市五股區新北產業園區五工路 134 號

台灣檢驗科技股份有限公司

t (886-2) 2299-3279

f (886-2) 2298-0488

www.tw.sgs.com

Member of SGS Group

Radar Type 1 for 802.11n40 5310 MHz:

Data Sheet for FCC Variable Radar Type 1				
1 us Pulse Width, PRI Test A&Test B				
Trial	PRI	Pulses Per Burst	Test	Successful Detection

Unless otherwise stated the results shown in this test report refer only to the sample(s) tested and such sample(s) are retained for 90 days only.

除非另有說明，此報告結果僅對測試之樣品負責，同時此樣品僅保留90天。本報告未經本公司書面許可，不可部份複製。

This document is issued by the Company subject to its General Conditions of Service printed overleaf, available on request or accessible at www.sgs.com/terms_and_conditions.htm and, for electronic format documents, subject to Terms and Conditions for Electronic Documents at www.sgs.com/terms_e-document.htm. Attention is drawn to the limitation of liability, indemnification and jurisdiction issues defined therein. Any holder of this document is advised that information contained hereon reflects the Company's findings at the time of its intervention only and within the limits of Client's instructions, if any. The Company's sole responsibility is to its Client and this document does not exonerate parties to a transaction from exercising all their rights and obligations under the transaction documents. This document cannot be reproduced except in full, without prior written approval of the Company. Any unauthorized alteration, forgery or falsification of the content or appearance of this document is unlawful and offenders may be prosecuted to the fullest extent of the law.

SGS Taiwan Ltd.

No.134,WuKungRoad,NewTaipeiIndustrialPark,WukuDistrict,NewTaipeiCity,Taiwan24803/新北市五股區新北產業園區五工路 134 號

台灣檢驗科技股份有限公司

t (886-2) 2299-3279

f (886-2) 2298-0488

www.tw.sgs.com

Member of SGS Group

Radar Type 2 for 802.11n40 5310 MHz:

Data Sheet for FCC Variable Radar Type 2				
1-5 us Pulse Width, PRI 150-230 us, 23-29 Pulses per Burst				
Trial	Pulse Width	PRI	Pulses Per Burst	Successful Detection

Unless otherwise stated the results shown in this test report refer only to the sample(s) tested and such sample(s) are retained for 90 days only.

除非另有說明，此報告結果僅對測試之樣品負責，同時此樣品僅保留90天。本報告未經本公司書面許可，不可部份複製。

This document is issued by the Company subject to its General Conditions of Service printed overleaf, available on request or accessible at www.sgs.com/terms_and_conditions.htm and, for electronic format documents, subject to Terms and Conditions for Electronic Documents at www.sgs.com/terms_e-document.htm. Attention is drawn to the limitation of liability, indemnification and jurisdiction issues defined therein. Any holder of this document is advised that information contained hereon reflects the Company's findings at the time of its intervention only and within the limits of Client's instructions, if any. The Company's sole responsibility is to its Client and this document does not exonerate parties to a transaction from exercising all their rights and obligations under the transaction documents. This document cannot be reproduced except in full, without prior written approval of the Company. Any unauthorized alteration, forgery or falsification of the content or appearance of this document is unlawful and offenders may be prosecuted to the fullest extent of the law.

SGS Taiwan Ltd.

No.134,WuKungRoad,NewTaipeiIndustrialPark,WukuDistrict,NewTaipeiCity,Taiwan24803/新北市五股區新北產業園區五工路 134 號

台灣檢驗科技股份有限公司

t (886-2) 2299-3279

f (886-2) 2298-0488

www.tw.sgs.com

Member of SGS Group

Radar Type 3 for 802.11n40 5310 MHz:

Data Sheet for FCC Variable Radar Type 3				
6-10 us Pulse Width, PRI 200-500 us, 16-18 Pulses per Burst				
Trial	Pulse Width	PRI	Pulses Per Burst	Successful Detection

Unless otherwise stated the results shown in this test report refer only to the sample(s) tested and such sample(s) are retained for 90 days only.

除非另有說明，此報告結果僅對測試之樣品負責，同時此樣品僅保留90天。本報告未經本公司書面許可，不可部份複製。

This document is issued by the Company subject to its General Conditions of Service printed overleaf, available on request or accessible at www.sgs.com/terms_and_conditions.htm and, for electronic format documents, subject to Terms and Conditions for Electronic Documents at www.sgs.com/terms_e-document.htm. Attention is drawn to the limitation of liability, indemnification and jurisdiction issues defined therein. Any holder of this document is advised that information contained hereon reflects the Company's findings at the time of its intervention only and within the limits of Client's instructions, if any. The Company's sole responsibility is to its Client and this document does not exonerate parties to a transaction from exercising all their rights and obligations under the transaction documents. This document cannot be reproduced except in full, without prior written approval of the Company. Any unauthorized alteration, forgery or falsification of the content or appearance of this document is unlawful and offenders may be prosecuted to the fullest extent of the law.

SGS Taiwan Ltd.

No.134,WuKungRoad,NewTaipeiIndustrialPark,WukuDistrict,NewTaipeiCity,Taiwan24803/新北市五股區新北產業園區五工路 134 號

台灣檢驗科技股份有限公司

t (886-2) 2299-3279

f (886-2) 2298-0488

www.tw.sgs.com

Member of SGS Group

Radar Type 4 for 802.11n40 5310 MHz:

Data Sheet for FCC Variable Radar Type 4				
11-20 us Pulse Width, PRI 200-500 us, 12-16 Pulses per Burst				
Trial	Pulse Width	PRI	Pulses Per Burst	Successful Detection

Unless otherwise stated the results shown in this test report refer only to the sample(s) tested and such sample(s) are retained for 90 days only.

除非另有說明，此報告結果僅對測試之樣品負責，同時此樣品僅保留90天。本報告未經本公司書面許可，不可部份複製。

This document is issued by the Company subject to its General Conditions of Service printed overleaf, available on request or accessible at www.sgs.com/terms_and_conditions.htm and, for electronic format documents, subject to Terms and Conditions for Electronic Documents at www.sgs.com/terms_e-document.htm. Attention is drawn to the limitation of liability, indemnification and jurisdiction issues defined therein. Any holder of this document is advised that information contained hereon reflects the Company's findings at the time of its intervention only and within the limits of Client's instructions, if any. The Company's sole responsibility is to its Client and this document does not exonerate parties to a transaction from exercising all their rights and obligations under the transaction documents. This document cannot be reproduced except in full, without prior written approval of the Company. Any unauthorized alteration, forgery or falsification of the content or appearance of this document is unlawful and offenders may be prosecuted to the fullest extent of the law.

SGS Taiwan Ltd.

No.134,WuKungRoad,NewTaipeiIndustrialPark,WukuDistrict,NewTaipeiCity,Taiwan24803/新北市五股區新北產業園區五工路 134 號

台灣檢驗科技股份有限公司

t (886-2) 2299-3279

f (886-2) 2298-0488

www.tw.sgs.com

Member of SGS Group

Radar Type 5 for 802.11n40 5310 MHz:

Radar Type 5 for 802.11n40 5310 MHz

Waveform Num =	1
Number of Bursts =	9
Burst Interval (us) =	1333333

Burst #	OffTime (us)	# Pulses	Chirp (MHz)	PW (us)	Pulse1 Pri(us)	Pulse2 Pri(us)	Pulse3 Pri(us)	StartLoc (us)	StartBurst Interval(us)	EndBurst Interval(us)
1	750172	2	6	100	1574	1869	0	750172	0	1333332
2	850753	3	19	75	1270	1519	1271	1604368	1333333	2666665
3	1449395	3	7	65	1776	1273	1261	3057823	2666666	3999998
4	2159921	3	20	70	1704	1693	1705	5222054	3999999	5333331
5	1080207	3	12	100	1716	1441	1666	6307363	5333332	6666664
6	784825	2	17	100	1321	1726	0	7097011	6666665	7999997
7	2204495	3	14	90	1967	1104	1118	9304553	7999998	9333330
8	1297436	1	9	55	1674	0	0	10606178	9333331	10666663
9	1350506	1	6	80	1013	0	0	11958358	10666664	11999996
Total	number	of	pulses	in	waveform	=	21			

Radar Type 5 for 802.11n40 5310 MHz

Waveform Num =	2
Number of Bursts =	20
Burst Interval (us) =	600000

Burst #	OffTime (us)	# Pulses	Chirp (MHz)	PW (us)	Pulse1 Pri(us)	Pulse2 Pri(us)	Pulse3 Pri(us)	StartLoc (us)	StartBurst Interval(us)	EndBurst Interval(us)
1	342579	3	20	50	1899	1174	1935	342579	0	599999
2	696517	3	16	70	1864	1160	1396	1044104	600000	1199999
3	195894	1	7	70	1013	0	0	1244418	1200000	1799999
4	566362	3	16	95	1908	1147	1828	1811793	1800000	2399999
5	1156853	2	7	65	1422	1072	0	2973529	2400000	2999999
6	191887	3	10	80	1439	1304	1288	3167910	3000000	3599999
7	688884	2	19	55	1743	1001	0	3860825	3600000	4199999
8	598429	3	16	65	1559	1289	1733	4461998	4200000	4799999
9	798151	2	16	90	1254	1042	0	5264730	4800000	5399999
10	301910	3	7	70	1523	1475	1637	5568936	5400000	5999999
11	941790	2	15	100	1699	1100	0	6515361	6000000	6599999
12	100038	2	12	50	1516	1409	0	6618198	6600000	7199999
13	812306	3	16	65	1538	1442	1012	7433429	7200000	7799999
14	788418	1	13	50	1625	0	0	8225839	7800000	8399999
15	355984	2	6	85	1396	1230	0	8583448	8400000	8999999
16	586045	1	20	75	1544	0	0	9172119	9000000	9599999
17	753752	1	11	60	1717	0	0	9927415	9600000	10199999
18	352341	2	14	55	1834	1102	0	10281473	10200000	10799999
19	926893	2	12	50	1320	1511	0	11211302	10800000	11399999
20	312466	2	13	75	1993	1476	0	11526599	11400000	11999999
Total	number	of	pulses	in	waveform	=	43			

Unless otherwise stated the results shown in this test report refer only to the sample(s) tested and such sample(s) are retained for 90 days only.

除非另有說明，此報告結果僅對測試之樣品負責，同時此樣品僅保留90天。本報告未經本公司書面許可，不可部份複製。

This document is issued by the Company subject to its General Conditions of Service printed overleaf, available on request or accessible at www.sgs.com/terms_and_conditions.htm and, for electronic format documents, subject to Terms and Conditions for Electronic Documents at www.sgs.com/terms_e-document.htm. Attention is drawn to the limitation of liability, indemnification and jurisdiction issues defined therein. Any holder of this document is advised that information contained hereon reflects the Company's findings at the time of its intervention only and within the limits of Client's instructions, if any. The Company's sole responsibility is to its Client and this document does not exonerate parties to a transaction from exercising all their rights and obligations under the transaction documents. This document cannot be reproduced except in full, without prior written approval of the Company. Any unauthorized alteration, forgery or falsification of the content or appearance of this document is unlawful and offenders may be prosecuted to the fullest extent of the law.

SGS Taiwan Ltd.

No.134,WuKungRoad,NewTaipeiIndustrialPark,WukuDistrict,NewTaipeiCity,Taiwan24803/新北市五股區新北產業園區五工路 134 號

台灣檢驗科技股份有限公司

t (886-2) 2299-3279

f (886-2) 2298-0488

www.tw.sgs.com

Member of SGS Group

Radar Type 5 for 802.11n40 5310 MHz

Waveform Num =	3
Number of Bursts =	15
Time Interval (us) =	800000

Burst #	OffTime (us)	# Pulses	Chirp (MHz)	PW (us)	Pulse1 Pri(us)	Pulse2 Pri(us)	Pulse3 Pri(us)	StartLoc (us)	StartBurst Interval(us)	EndBurst Interval(us)
1	588788	1	20	60	1305	0	0	588788	0	799999
2	585255	2	20	85	1505	1623	0	1175348	800000	1599999
3	480937	1	6	70	1723	0	0	1659413	1600000	2399999
4	1002722	1	18	85	1655	0	0	2663858	2400000	3199999
5	842539	3	18	85	1443	1901	1366	3508052	3200000	3999999
6	652603	1	9	100	1523	0	0	4165365	4000000	4799999
7	1008376	2	16	70	1489	1105	0	5175264	4800000	5599999
8	1134785	2	11	85	1023	1295	0	6312643	5600000	6399999
9	344000	1	7	55	1448	0	0	6658961	6400000	7199999
10	1202497	1	15	55	1452	0	0	7862906	7200000	7999999
11	159218	2	18	80	1556	1641	0	8023576	8000000	8799999
12	1262275	2	13	75	1484	1213	0	9289048	8800000	9599999
13	647246	2	10	80	1251	1991	0	9938991	9600000	10399999
14	786577	2	10	65	1936	1695	0	10728810	10400000	11199999
15	1116324	1	7	90	1217	0	0	11848765	11200000	11999999
Total	number	of	pulses	in	waveform	=	24			

Radar Type 5 for 802.11n40 5310 MHz

Waveform Num =	4
Number of Bursts =	11
Time Interval (us) =	1090909

Burst #	OffTime (us)	# Pulses	Chirp (MHz)	PW (us)	Pulse1 Pri(us)	Pulse2 Pri(us)	Pulse3 Pri(us)	StartLoc (us)	StartBurst Interval(us)	EndBurst Interval(us)
1	765680	2	9	60	1980	1373	0	765680	0	1090908
2	863130	1	18	55	1585	0	0	1632163	1090909	2181817
3	1019695	3	17	80	1720	1998	1348	2653443	2181818	3272726
4	1563352	3	13	85	1101	1049	1666	4221861	3272727	4363635
5	824027	3	12	70	1823	1407	1348	5049704	4363636	5454544
6	877929	3	11	90	1225	1004	1703	5932211	5454545	6545453
7	1537833	3	18	85	1361	1983	1426	7473976	6545454	7636362
8	630179	1	10	95	1579	0	0	8108925	7636363	8727271
9	1369422	3	9	95	1192	1897	1207	9479926	8727272	9818180
10	1403425	3	10	55	1395	1894	1465	10887647	9818181	10909089
11	526352	2	6	60	1547	1217	0	11418753	10909090	11999998
Total	number	of	pulses	in	waveform	=	27			

Unless otherwise stated the results shown in this test report refer only to the sample(s) tested and such sample(s) are retained for 90 days only.

除非另有說明，此報告結果僅對測試之樣品負責，同時此樣品僅保留90天。本報告未經本公司書面許可，不可部份複製。

This document is issued by the Company subject to its General Conditions of Service printed overleaf, available on request or accessible at www.sgs.com/terms_and_conditions.htm and, for electronic format documents, subject to Terms and Conditions for Electronic Documents at www.sgs.com/terms_e-document.htm. Attention is drawn to the limitation of liability, indemnification and jurisdiction issues defined therein. Any holder of this document is advised that information contained hereon reflects the Company's findings at the time of its intervention only and within the limits of Client's instructions, if any. The Company's sole responsibility is to its Client and this document does not exonerate parties to a transaction from exercising all their rights and obligations under the transaction documents. This document cannot be reproduced except in full, without prior written approval of the Company. Any unauthorized alteration, forgery or falsification of the content or appearance of this document is unlawful and offenders may be prosecuted to the fullest extent of the law.

SGS Taiwan Ltd.

No.134,WuKungRoad,NewTaipeiIndustrialPark,WukuDistrict,NewTaipeiCity,Taiwan24803/新北市五股區新北產業園區五工路 134 號

台灣檢驗科技股份有限公司

t (886-2) 2299-3279

f (886-2) 2298-0488

www.tw.sgs.com

Member of SGS Group

Radar Type 5 for 802.11n40 5310 MHz

Waveform Num =	5
Number of Bursts =	9
Burst Interval (us) =	1333333

Burst #	OffTime (us)	# Pulses	Chirp (MHz)	PW (us)	Pulse1 Pri(us)	Pulse2 Pri(us)	Pulse3 Pri(us)	StartLoc (us)	StartBurst Interval(us)	EndBurst Interval(us)
1	698105	3	8	85	1875	1839	1352	698105	0	1333332
2	955953	1	17	70	1886	0	0	1659124	1333333	2666665
3	1349669	2	17	60	1191	1003	0	3010679	2666666	3999998
4	1554539	2	15	75	1668	1991	0	4567412	3999999	5333331
5	1149209	2	14	90	1776	1747	0	5720280	5333332	6666664
6	1547076	1	19	95	1839	0	0	7270879	6666665	7999997
7	1017142	3	9	85	1473	1559	1209	8289860	7999998	9333330
8	2155696	1	7	100	1922	0	0	10449797	9333331	10666663
9	1351875	2	12	70	1724	1366	0	11803594	10666664	11999996
Total	number	of	pulses	in	waveform	=	17			

Radar Type 5 for 802.11n40 5310 MHz

Waveform Num =	6
Number of Bursts =	13
Burst Interval (us) =	923077

Burst #	OffTime (us)	# Pulses	Chirp (MHz)	PW (us)	Pulse1 Pri(us)	Pulse2 Pri(us)	Pulse3 Pri(us)	StartLoc (us)	StartBurst Interval(us)	EndBurst Interval(us)
1	80075	2	17	65	1257	1705	0	80075	0	923076
2	888692	1	17	60	1558	0	0	971729	923077	1846153
3	1059120	3	12	70	1234	1531	1900	2032407	1846154	2769230
4	1523239	2	15	50	1587	1102	0	3560311	2769231	3692307
5	180175	2	12	100	1870	1876	0	3743175	3692308	4615384
6	1744890	2	14	65	1872	1452	0	5491811	4615385	5538461
7	209503	2	6	75	1734	1683	0	5704638	5538462	6461538
8	1235265	1	18	100	1583	0	0	6943320	6461539	7384615
9	761363	3	9	100	1757	1501	1629	7706266	7384616	8307692
10	1100385	1	17	65	1958	0	0	8811538	8307693	9230769
11	1176185	1	11	90	1228	0	0	9989681	9230770	10153846
12	447997	1	17	60	1833	0	0	10438906	10153847	11076923
13	932337	1	14	80	1731	0	0	11373076	11076924	12000000
Total	number	of	pulses	in	waveform	=	22			

Unless otherwise stated the results shown in this test report refer only to the sample(s) tested and such sample(s) are retained for 90 days only.

除非另有說明，此報告結果僅對測試之樣品負責，同時此樣品僅保留90天。本報告未經本公司書面許可，不可部份複製。

This document is issued by the Company subject to its General Conditions of Service printed overleaf, available on request or accessible at www.sgs.com/terms_and_conditions.htm and, for electronic format documents, subject to Terms and Conditions for Electronic Documents at www.sgs.com/terms_e-document.htm. Attention is drawn to the limitation of liability, indemnification and jurisdiction issues defined therein. Any holder of this document is advised that information contained hereon reflects the Company's findings at the time of its intervention only and within the limits of Client's instructions, if any. The Company's sole responsibility is to its Client and this document does not exonerate parties to a transaction from exercising all their rights and obligations under the transaction documents. This document cannot be reproduced except in full, without prior written approval of the Company. Any unauthorized alteration, forgery or falsification of the content or appearance of this document is unlawful and offenders may be prosecuted to the fullest extent of the law.

Radar Type 5 for 802.11n40 5310 MHz

Waveform Num =	7
Number of Bursts =	20
Burst Interval (us) =	600000

Burst #	OffTime (us)	# Pulses	Chirp (MHz)	PW (us)	Pulse1 Pri(us)	Pulse2 Pri(us)	Pulse3 Pri(us)	StartLoc (us)	StartBurst Interval(us)	EndBurst Interval(us)
1	483752	3	17	50	1390	1723	1343	483752	0	599999
2	515750	3	6	65	1971	1189	1886	1003958	600000	1199999
3	310407	3	7	65	1102	1253	1129	1319411	1200000	1799999
4	683216	3	15	80	1309	1420	1323	2006111	1800000	2399999
5	481570	3	20	55	1819	1018	1469	2491733	2400000	2999999
6	794270	2	10	70	1945	1419	0	3290309	3000000	3599999
7	353352	3	16	95	1763	1995	1047	3647025	3600000	4199999
8	903490	1	14	80	1776	0	0	4555320	4200000	4799999
9	332109	2	6	60	1151	1687	0	4889205	4800000	5399999
10	797548	3	12	95	1139	1408	1297	5689591	5400000	5999999
11	306777	2	20	90	1320	1822	0	6000212	6000000	6599999
12	1072783	1	18	90	1981	0	0	7076137	6600000	7199999
13	320176	1	7	75	1522	0	0	7398294	7200000	7799999
14	471591	2	19	90	1456	1933	0	7871407	7800000	8399999
15	667740	2	20	55	1510	1811	0	8542536	8400000	8999999
16	959172	1	9	100	1615	0	0	9505029	9000000	9599999
17	282408	3	18	65	1600	1130	1326	9789052	9600000	10199999
18	419922	3	12	95	1249	1350	1973	10213030	10200000	10799999
19	891936	1	14	80	1562	0	0	11109538	10800000	11399999
20	784193	1	18	70	1129	0	0	11895293	11400000	11999999
Total	number	of	pulses	in	waveform	=	43			

Unless otherwise stated the results shown in this test report refer only to the sample(s) tested and such sample(s) are retained for 90 days only.

除非另有說明，此報告結果僅對測試之樣品負責，同時此樣品僅保留90天。本報告未經本公司書面許可，不可部份複製。

This document is issued by the Company subject to its General Conditions of Service printed overleaf, available on request or accessible at www.sgs.com/terms_and_conditions.htm and, for electronic format documents, subject to Terms and Conditions for Electronic Documents at www.sgs.com/terms_e-document.htm. Attention is drawn to the limitation of liability, indemnification and jurisdiction issues defined therein. Any holder of this document is advised that information contained hereon reflects the Company's findings at the time of its intervention only and within the limits of Client's instructions, if any. The Company's sole responsibility is to its Client and this document does not exonerate parties to a transaction from exercising all their rights and obligations under the transaction documents. This document cannot be reproduced except in full, without prior written approval of the Company. Any unauthorized alteration, forgery or falsification of the content or appearance of this document is unlawful and offenders may be prosecuted to the fullest extent of the law.

SGS Taiwan Ltd.

No.134,WuKungRoad,NewTaipeiIndustrialPark,WukuDistrict,NewTaipeiCity,Taiwan24803/新北市五股區新北產業園區五工路 134 號

台灣檢驗科技股份有限公司

t (886-2) 2299-3279

f (886-2) 2298-0488

www.tw.sgs.com

Member of SGS Group

Radar Type 5 for 802.11n40 5310 MHz

Waveform Num =	8
Number of Bursts =	18
Burst Interval (us) =	666667

Burst #	OffTime (us)	# Pulses	Chirp (MHz)	PW (us)	Pulse1 Pri(us)	Pulse2 Pri(us)	Pulse3 Pri(us)	StartLoc (us)	StartBurst Interval(us)	EndBurst Interval(us)
1	415982	1	14	80	1331	0	0	415982	0	666666
2	847216	1	9	55	1968	0	0	1264529	666667	1333333
3	474746	1	6	85	1044	0	0	1741243	1333334	2000000
4	445456	3	9	100	1385	1391	1190	2187743	2000001	2666667
5	638416	3	16	75	1644	1811	1160	2830125	2666668	3333334
6	965452	2	9	85	1970	1408	0	3800192	3333335	4000001
7	617956	2	7	60	1506	1845	0	4421526	4000002	4666668
8	824523	3	20	100	1197	1033	1648	5249400	4666669	5333335
9	506632	2	18	95	1602	1980	0	5759910	5333336	6000002
10	329544	2	6	90	1844	1180	0	6093036	6000003	6666669
11	1214877	1	19	85	1600	0	0	7310937	6666670	7333336
12	444188	2	9	70	1306	1623	0	7756725	7333337	8000003
13	843519	1	16	80	1054	0	0	8603173	8000004	8666670
14	511092	2	17	80	1259	1781	0	9115319	8666671	9333337
15	510398	3	12	50	1350	1396	1041	9628757	9333338	10000004
16	699147	1	12	75	1866	0	0	10331691	10000005	10666671
17	630621	3	12	60	1103	1436	1773	10964178	10666672	11333338
18	832682	1	9	50	1167	0	0	11801172	11333339	12000005
Total	number	of	pulses	in	waveform	=	34			

Unless otherwise stated the results shown in this test report refer only to the sample(s) tested and such sample(s) are retained for 90 days only.

除非另有說明，此報告結果僅對測試之樣品負責，同時此樣品僅保留90天。本報告未經本公司書面許可，不可部份複製。

This document is issued by the Company subject to its General Conditions of Service printed overleaf, available on request or accessible at www.sgs.com/terms_and_conditions.htm and, for electronic format documents, subject to Terms and Conditions for Electronic Documents at www.sgs.com/terms_e-document.htm. Attention is drawn to the limitation of liability, indemnification and jurisdiction issues defined therein. Any holder of this document is advised that information contained hereon reflects the Company's findings at the time of its intervention only and within the limits of Client's instructions, if any. The Company's sole responsibility is to its Client and this document does not exonerate parties to a transaction from exercising all their rights and obligations under the transaction documents. This document cannot be reproduced except in full, without prior written approval of the Company. Any unauthorized alteration, forgery or falsification of the content or appearance of this document is unlawful and offenders may be prosecuted to the fullest extent of the law.

SGS Taiwan Ltd.

No.134,WuKungRoad,NewTaipeiIndustrialPark,WukuDistrict,NewTaipeiCity,Taiwan24803/新北市五股區新北產業園區五工路 134 號

台灣檢驗科技股份有限公司

t (886-2) 2299-3279

f (886-2) 2298-0488

www.tw.sgs.com

Member of SGS Group

Radar Type 5 for 802.11n40 5310 MHz

Waveform Num =	8
Number of Bursts =	18
Burst Interval (us) =	666667

Burst #	OffTime (us)	# Pulses	Chirp (MHz)	PW (us)	Pulse1 Pri(us)	Pulse2 Pri(us)	Pulse3 Pri(us)	StartLoc (us)	StartBurst Interval(us)	EndBurst Interval(us)
1	415982	1	14	80	1331	0	0	415982	0	666666
2	847216	1	9	55	1968	0	0	1264529	666667	1333333
3	474746	1	6	85	1044	0	0	1741243	1333334	2000000
4	445456	3	9	100	1385	1391	1190	2187743	2000001	2666667
5	638416	3	16	75	1644	1811	1160	2830125	2666668	3333334
6	965452	2	9	85	1970	1408	0	3800192	3333335	4000001
7	617956	2	7	60	1506	1845	0	4421526	4000002	4666668
8	824523	3	20	100	1197	1033	1648	5249400	4666669	5333335
9	506632	2	18	95	1602	1980	0	5759910	5333336	6000002
10	329544	2	6	90	1844	1180	0	6093036	6000003	6666669
11	1214877	1	19	85	1600	0	0	7310937	6666670	7333336
12	444188	2	9	70	1306	1623	0	7756725	7333337	8000003
13	843519	1	16	80	1054	0	0	8603173	8000004	8666670
14	511092	2	17	80	1259	1781	0	9115319	8666671	9333337
15	510398	3	12	50	1350	1396	1041	9628757	9333338	10000004
16	699147	1	12	75	1866	0	0	10331691	10000005	10666671
17	630621	3	12	60	1103	1436	1773	10964178	10666672	11333338
18	832682	1	9	50	1167	0	0	11801172	11333339	12000005
Total	number	of	pulses	in	waveform	=	34			

Unless otherwise stated the results shown in this test report refer only to the sample(s) tested and such sample(s) are retained for 90 days only.

除非另有說明，此報告結果僅對測試之樣品負責，同時此樣品僅保留90天。本報告未經本公司書面許可，不可部份複製。

This document is issued by the Company subject to its General Conditions of Service printed overleaf, available on request or accessible at www.sgs.com/terms_and_conditions.htm and, for electronic format documents, subject to Terms and Conditions for Electronic Documents at www.sgs.com/terms_e-document.htm. Attention is drawn to the limitation of liability, indemnification and jurisdiction issues defined therein. Any holder of this document is advised that information contained hereon reflects the Company's findings at the time of its intervention only and within the limits of Client's instructions, if any. The Company's sole responsibility is to its Client and this document does not exonerate parties to a transaction from exercising all their rights and obligations under the transaction documents. This document cannot be reproduced except in full, without prior written approval of the Company. Any unauthorized alteration, forgery or falsification of the content or appearance of this document is unlawful and offenders may be prosecuted to the fullest extent of the law.

SGS Taiwan Ltd.

No.134,WuKungRoad,NewTaipeiIndustrialPark,WukuDistrict,NewTaipeiCity,Taiwan24803/新北市五股區新北產業園區五工路 134 號

台灣檢驗科技股份有限公司

t (886-2) 2299-3279

f (886-2) 2298-0488

www.tw.sgs.com

Member of SGS Group

Radar Type 5 for 802.11n40 5310 MHz

veform Num =	10
m of Bursts =	19
t Interval (us) =	631579

Burst #	OffTime (us)	# Pulses	Chirp (MHz)	PW (us)	Pulse1 Pri(us)	Pulse2 Pri(us)	Pulse3 Pri(us)	StartLoc (us)	StartBurst Interval(us)	EndBurst Interval(us)
1	283652	3	12	80	1894	1693	1740	283652	0	631578
2	547895	1	5	60	1546	0	0	836874	631579	1263157
3	777827	2	16	90	1396	1761	0	1616247	1263158	1894736
4	402663	2	9	65	1464	1531	0	2022067	1894737	2526315
5	719995	1	17	60	1409	0	0	2745057	2526316	3157894
6	734237	3	12	65	1044	1967	1685	3480703	3157895	3789473
7	599858	3	17	80	1727	1260	1094	4085257	3789474	4421052
8	730305	1	11	80	1196	0	0	4819643	4421053	5052631
9	667863	1	18	55	1012	0	0	5488702	5052632	5684210
10	556377	3	18	75	1778	1891	1037	6046091	5684211	6315789
11	760613	3	5	55	1852	1076	1567	6811410	6315790	6947368
12	635000	2	5	70	1446	1573	0	7450905	6947369	7578947
13	646712	1	17	50	1202	0	0	8100636	7578948	8210526
14	116315	3	13	90	1834	1663	1839	8218153	8210527	8842105
15	871917	1	6	55	1569	0	0	9095406	8842106	9473684
16	836782	3	6	60	1107	1910	1639	9933757	9473685	10105263
17	524656	2	5	65	1997	1265	0	10463069	10105264	10736842
18	400273	3	14	100	1633	1578	1339	10866604	10736843	11368421
19	744430	1	8	75	1852	0	0	11615584	11368422	12000000
Total	number	of	pulses	in	waveform	=	39			

Radar Type 5 for 802.11n40 5310 MHz

veform Num =	11
m of Bursts =	10
t Interval (us) =	1200000

Burst #	OffTime (us)	# Pulses	Chirp (MHz)	PW (us)	Pulse1 Pri(us)	Pulse2 Pri(us)	Pulse3 Pri(us)	StartLoc (us)	StartBurst Interval(us)	EndBurst Interval(us)
1	1110129	2	6	60	1713	1141	0	1110129	0	1199999
2	590465	2	8	65	1755	1642	0	1703448	1200000	2399999
3	1256796	2	8	85	1692	1040	0	2963641	2400000	3599999
4	1704798	3	16	85	1032	1243	1070	4671171	3600000	4799999
5	854486	2	19	75	1242	1514	0	5529002	4800000	5999999
6	935842	1	10	85	1956	0	0	6467600	6000000	7199999
7	1554792	1	17	90	1960	0	0	8024348	7200000	8399999
8	882618	3	11	85	1131	1604	1076	8908926	8400000	9599999
9	1354553	3	13	50	1322	1591	1751	10267290	9600000	10799999
10	1272046	3	8	90	1952	1076	1731	11544000	10800000	11999999
Total	number	of	pulses	in	waveform	=	22			

Unless otherwise stated the results shown in this test report refer only to the sample(s) tested and such sample(s) are retained for 90 days only.

除非另有說明，此報告結果僅對測試之樣品負責，同時此樣品僅保留90天。本報告未經本公司書面許可，不可部份複製。

This document is issued by the Company subject to its General Conditions of Service printed overleaf, available on request or accessible at www.sgs.com/terms_and_conditions.htm and, for electronic format documents, subject to Terms and Conditions for Electronic Documents at www.sgs.com/terms_e-document.htm. Attention is drawn to the limitation of liability, indemnification and jurisdiction issues defined therein. Any holder of this document is advised that information contained hereon reflects the Company's findings at the time of its intervention only and within the limits of Client's instructions, if any. The Company's sole responsibility is to its Client and this document does not exonerate parties to a transaction from exercising all their rights and obligations under the transaction documents. This document cannot be reproduced except in full, without prior written approval of the Company. Any unauthorized alteration, forgery or falsification of the content or appearance of this document is unlawful and offenders may be prosecuted to the fullest extent of the law.

SGS Taiwan Ltd.

No.134,WuKungRoad,NewTaipeiIndustrialPark,WukuDistrict,NewTaipeiCity,Taiwan24803/新北市五股區新北產業園區五工路 134 號

台灣檢驗科技股份有限公司

t (886-2) 2299-3279

f (886-2) 2298-0488

www.tw.sgs.com

Member of SGS Group

Radar Type 5 for 802.11n40 5310 MHz

veform Num =	12
m of Bursts =	19
t Interval (us) =	631579

Burst #	OffTime (us)	# Pulses	Chirp (MHz)	PW (us)	Pulse1 Pri(us)	Pulse2 Pri(us)	Pulse3 Pri(us)	StartLoc (us)	StartBurst Interval(us)	EndBurst Interval(us)
1	528081	2	9	75	1221	1570	0	528081	0	631578
2	498090	1	15	80	1149	0	0	1028962	631579	1263157
3	833989	2	10	100	1369	1674	0	1864100	1263158	1894736
4	85730	1	6	85	1718	0	0	1952873	1894737	2526315
5	755165	1	12	65	1196	0	0	2709756	2526316	3157894
6	1075209	1	16	60	1652	0	0	3786161	3157895	3789473
7	77234	2	8	70	1874	1044	0	3865047	3789474	4421052
8	1075841	1	19	95	1305	0	0	4943806	4421053	5052631
9	616401	3	7	85	1282	1091	1229	5561512	5052632	5684210
10	263521	1	16	50	1412	0	0	5828635	5684211	6315789
11	1013141	1	20	50	1593	0	0	6843188	6315790	6947368
12	128497	3	20	70	1475	1686	1622	6973278	6947369	7578947
13	820987	1	13	85	1447	0	0	7799048	7578948	8210526
14	709110	3	7	55	1108	1794	1011	8509605	8210527	8842105
15	948646	3	13	80	1655	1882	1389	9462164	8842106	9473684
16	34177	3	20	70	1758	1438	1180	9501267	9473685	10105263
17	664198	3	6	70	1695	1894	1331	10169841	10105264	10736842
18	853083	3	13	70	1209	1584	1121	11027844	10736843	11368421
19	935786	3	10	95	1232	1307	1380	11967544	11368422	12000000
Total	number	of	pulses	in	waveform	=	38			

Unless otherwise stated the results shown in this test report refer only to the sample(s) tested and such sample(s) are retained for 90 days only.

除非另有說明，此報告結果僅對測試之樣品負責，同時此樣品僅保留90天。本報告未經本公司書面許可，不可部份複製。

This document is issued by the Company subject to its General Conditions of Service printed overleaf, available on request or accessible at www.sgs.com/terms_and_conditions.htm and, for electronic format documents, subject to Terms and Conditions for Electronic Documents at www.sgs.com/terms_e-document.htm. Attention is drawn to the limitation of liability, indemnification and jurisdiction issues defined therein. Any holder of this document is advised that information contained hereon reflects the Company's findings at the time of its intervention only and within the limits of Client's instructions, if any. The Company's sole responsibility is to its Client and this document does not exonerate parties to a transaction from exercising all their rights and obligations under the transaction documents. This document cannot be reproduced except in full, without prior written approval of the Company. Any unauthorized alteration, forgery or falsification of the content or appearance of this document is unlawful and offenders may be prosecuted to the fullest extent of the law.

SGS Taiwan Ltd.

No.134,WuKungRoad,NewTaipeiIndustrialPark,WukuDistrict,NewTaipeiCity,Taiwan24803/新北市五股區新北產業園區五工路 134 號

台灣檢驗科技股份有限公司

t (886-2) 2299-3279

f (886-2) 2298-0488

www.tw.sgs.com

Member of SGS Group

Radar Type 5 for 802.11n40 5310 MHz

Waveform Num =	13
Number of Bursts =	14
Time Interval (us) =	857143

Burst #	OffTime (us)	# Pulses	Chirp (MHz)	PW (us)	Pulse1 Pri(us)	Pulse2 Pri(us)	Pulse3 Pri(us)	StartLoc (us)	StartBurst Interval(us)	EndBurst Interval(us)
1	412215	1	7	60	1362	0	0	412215	0	857142
2	1048514	3	7	75	1282	1939	1590	1462091	857143	1714285
3	550007	1	5	95	1107	0	0	2016909	1714286	2571428
4	1384379	2	8	85	1442	1926	0	3402395	2571429	3428571
5	541396	1	8	65	1084	0	0	3947159	3428572	4285714
6	585909	2	20	100	1768	1061	0	4534152	4285715	5142857
7	684855	3	18	95	1459	1272	1682	5221836	5142858	6000000
8	1479750	2	15	65	1127	1004	0	6705999	6000001	6857143
9	862285	3	5	95	1716	1024	1793	7570415	6857144	7714286
10	695684	2	17	80	1081	1719	0	8270632	7714287	8571429
11	927082	2	11	100	1360	1098	0	9200514	8571430	9428572
12	861171	3	18	85	1875	1761	1006	10064143	9428573	10285715
13	298787	2	18	95	1147	1598	0	10367572	10285716	11142858
14	1318508	3	10	80	1413	1066	1262	11688825	11142859	12000001
Total	number	of	pulses	in	waveform	=	30			

Radar Type 5 for 802.11n40 5310 MHz

Waveform Num =	14
Number of Bursts =	13
Time Interval (us) =	923077

Burst #	OffTime (us)	# Pulses	Chirp (MHz)	PW (us)	Pulse1 Pri(us)	Pulse2 Pri(us)	Pulse3 Pri(us)	StartLoc (us)	StartBurst Interval(us)	EndBurst Interval(us)
1	260001	1	7	60	1026	0	0	260001	0	923076
2	1411159	3	6	95	1806	1499	1324	1672186	923077	1846153
3	505192	2	17	95	1708	1817	0	2182007	1846154	2769230
4	980267	2	9	60	1163	1685	0	3165799	2769231	3692307
5	1305973	1	6	65	1567	0	0	4474620	3692308	4615384
6	146186	1	6	70	1321	0	0	4622373	4615385	5538461
7	1434918	1	19	55	1134	0	0	6058612	5538462	6461538
8	1102753	2	11	50	1809	1191	0	7162499	6461539	7384615
9	238086	1	12	50	1974	0	0	7403585	7384616	8307692
10	1071988	1	12	60	1380	0	0	8477547	8307693	9230769
11	1582795	2	11	70	1525	1427	0	10061722	9230770	10153846
12	652617	1	20	75	1371	0	0	10717291	10153847	11076923
13	576014	1	18	95	1669	0	0	11294676	11076924	12000000
Total	number	of	pulses	in	waveform	=	19			

Unless otherwise stated the results shown in this test report refer only to the sample(s) tested and such sample(s) are retained for 90 days only.

除非另有說明，此報告結果僅對測試之樣品負責，同時此樣品僅保留90天。本報告未經本公司書面許可，不可部份複製。

This document is issued by the Company subject to its General Conditions of Service printed overleaf, available on request or accessible at www.sgs.com/terms_and_conditions.htm and, for electronic format documents, subject to Terms and Conditions for Electronic Documents at www.sgs.com/terms_e-document.htm. Attention is drawn to the limitation of liability, indemnification and jurisdiction issues defined therein. Any holder of this document is advised that information contained hereon reflects the Company's findings at the time of its intervention only and within the limits of Client's instructions, if any. The Company's sole responsibility is to its Client and this document does not exonerate parties to a transaction from exercising all their rights and obligations under the transaction documents. This document cannot be reproduced except in full, without prior written approval of the Company. Any unauthorized alteration, forgery or falsification of the content or appearance of this document is unlawful and offenders may be prosecuted to the fullest extent of the law.

SGS Taiwan Ltd.

No.134,WuKungRoad,NewTaipeiIndustrialPark,WukuDistrict,NewTaipeiCity,Taiwan24803/新北市五股區新北產業園區五工路 134 號

台灣檢驗科技股份有限公司

t (886-2) 2299-3279

f (886-2) 2298-0488

www.tw.sgs.com

Member of SGS Group

Radar Type 5 for 802.11n40 5310 MHz

veform Num =	15
m of Bursts =	19
t Interval (us) =	631579

Burst #	OffTime (us)	# Pulses	Chirp (MHz)	PW (us)	Pulse1 Pri(us)	Pulse2 Pri(us)	Pulse3 Pri(us)	StartLoc (us)	StartBurst Interval(us)	EndBurst Interval(us)
1	41837	1	10	90	1505	0	0	41837	0	631578
2	633612	2	14	50	1744	1383	0	676954	631579	1263157
3	1114588	3	18	55	1277	1421	1915	1794669	1263158	1894736
4	642174	1	7	55	1264	0	0	2441456	1894737	2526315
5	622392	3	6	85	1858	1179	1902	3065112	2526316	3157894
6	649402	1	20	85	1487	0	0	3719453	3157895	3789473
7	185808	2	5	80	1226	1870	0	3906748	3789474	4421052
8	678561	3	9	95	1985	1407	1012	4588405	4421053	5052631
9	725169	1	10	75	1422	0	0	5317978	5052632	5684210
10	675196	1	16	90	1594	0	0	5994596	5684211	6315789
11	893820	3	16	75	1514	1862	1212	6890010	6315790	6947368
12	400806	3	20	90	1426	1554	1660	7295404	6947369	7578947
13	319885	1	14	95	1922	0	0	7619929	7578948	8210526
14	735597	1	13	100	1162	0	0	8357448	8210527	8842105
15	494749	3	19	65	1239	1618	1645	8853359	8842106	9473684
16	633926	3	14	90	1633	1733	1230	9491787	9473685	10105263
17	864409	3	16	55	1253	1600	1501	10360792	10105264	10736842
18	590418	2	12	90	1916	1017	0	10955564	10736843	11368421
19	1029543	2	11	50	1487	1200	0	11988040	11368422	12000000
Total	number	of	pulses	in	waveform	=	39			

Unless otherwise stated the results shown in this test report refer only to the sample(s) tested and such sample(s) are retained for 90 days only.

除非另有說明，此報告結果僅對測試之樣品負責，同時此樣品僅保留90天。本報告未經本公司書面許可，不可部份複製。

This document is issued by the Company subject to its General Conditions of Service printed overleaf, available on request or accessible at www.sgs.com/terms_and_conditions.htm and, for electronic format documents, subject to Terms and Conditions for Electronic Documents at www.sgs.com/terms_e-document.htm. Attention is drawn to the limitation of liability, indemnification and jurisdiction issues defined therein. Any holder of this document is advised that information contained hereon reflects the Company's findings at the time of its intervention only and within the limits of Client's instructions, if any. The Company's sole responsibility is to its Client and this document does not exonerate parties to a transaction from exercising all their rights and obligations under the transaction documents. This document cannot be reproduced except in full, without prior written approval of the Company. Any unauthorized alteration, forgery or falsification of the content or appearance of this document is unlawful and offenders may be prosecuted to the fullest extent of the law.

SGS Taiwan Ltd.

No.134,WuKungRoad,NewTaipeiIndustrialPark,WukuDistrict,NewTaipeiCity,Taiwan24803/新北市五股區新北產業園區五工路 134 號

台灣檢驗科技股份有限公司

t (886-2) 2299-3279

f (886-2) 2298-0488

www.tw.sgs.com

Member of SGS Group

Radar Type 5 for 802.11n40 5310 MHz

Waveform Num =	16
Number of Bursts =	14
Burst Interval (us) =	857143

Burst #	OffTime (us)	# Pulses	Chirp (MHz)	PW (us)	Pulse1 Pri(us)	Pulse2 Pri(us)	Pulse3 Pri(us)	StartLoc (us)	StartBurst Interval(us)	EndBurst Interval(us)
1	516646	3	5	80	1253	1356	1209	516646	0	857142
2	1012742	1	18	95	1952	0	0	1533206	857143	1714285
3	675692	2	7	85	1268	1064	0	2210850	1714286	2571428
4	502902	3	16	60	1764	1658	1935	2716084	2571429	3428571
5	913200	2	6	75	1475	1175	0	3634641	3428572	4285714
6	812332	1	15	65	1676	0	0	4449623	4285715	5142857
7	1248256	1	15	60	1276	0	0	5699555	5142858	6000000
8	1128682	2	12	80	1988	1952	0	6829513	6000001	6857143
9	737614	3	10	90	1193	1163	1721	7571067	6857144	7714286
10	864546	2	19	70	1484	1633	0	8439690	7714287	8571429
11	816995	1	14	85	1891	0	0	9259802	8571430	9428572
12	948131	2	11	70	1337	1519	0	10209824	9428573	10285715
13	228879	2	19	60	1187	1178	0	10441559	10285716	11142858
14	1159081	2	10	65	1167	1462	0	11603005	11142859	12000001
Total	number	of	pulses	in	waveform	=	27			

Radar Type 5 for 802.11n40 5310 MHz

Waveform Num =	17
Number of Bursts =	14
Burst Interval (us) =	857143

Burst #	OffTime (us)	# Pulses	Chirp (MHz)	PW (us)	Pulse1 Pri(us)	Pulse2 Pri(us)	Pulse3 Pri(us)	StartLoc (us)	StartBurst Interval(us)	EndBurst Interval(us)
1	830316	1	15	70	1565	0	0	830316	0	857142
2	427570	3	16	95	1343	1560	1124	1259451	857143	1714285
3	1125350	1	15	80	1875	0	0	2388828	1714286	2571428
4	525310	1	17	85	1406	0	0	2916013	2571429	3428571
5	1183135	1	19	60	1443	0	0	4100554	3428572	4285714
6	800042	2	17	90	1443	1122	0	4902039	4285715	5142857
7	701896	1	11	85	1209	0	0	5606500	5142858	6000000
8	706856	1	5	55	1206	0	0	6314565	6000001	6857143
9	610463	1	16	70	1152	0	0	6926234	6857144	7714286
10	924980	2	11	75	1442	1790	0	7852366	7714287	8571429
11	1464650	1	6	55	1181	0	0	9320248	8571430	9428572
12	304643	2	6	75	1045	1800	0	9626072	9428573	10285715
13	898238	1	16	50	1807	0	0	10527155	10285716	11142858
14	888033	2	9	100	1952	1561	0	11416995	11142859	12000001
Total	number	of	pulses	in	waveform	=	20			

Unless otherwise stated the results shown in this test report refer only to the sample(s) tested and such sample(s) are retained for 90 days only.

除非另有說明，此報告結果僅對測試之樣品負責，同時此樣品僅保留90天。本報告未經本公司書面許可，不可部份複製。

This document is issued by the Company subject to its General Conditions of Service printed overleaf, available on request or accessible at www.sgs.com/terms_and_conditions.htm and, for electronic format documents, subject to Terms and Conditions for Electronic Documents at www.sgs.com/terms_e-document.htm. Attention is drawn to the limitation of liability, indemnification and jurisdiction issues defined therein. Any holder of this document is advised that information contained hereon reflects the Company's findings at the time of its intervention only and within the limits of Client's instructions, if any. The Company's sole responsibility is to its Client and this document does not exonerate parties to a transaction from exercising all their rights and obligations under the transaction documents. This document cannot be reproduced except in full, without prior written approval of the Company. Any unauthorized alteration, forgery or falsification of the content or appearance of this document is unlawful and offenders may be prosecuted to the fullest extent of the law.

SGS Taiwan Ltd.

No.134,WuKungRoad,NewTaipeiIndustrialPark,WukuDistrict,NewTaipeiCity,Taiwan24803/新北市五股區新北產業園區五工路 134 號

台灣檢驗科技股份有限公司

t (886-2) 2299-3279

f (886-2) 2298-0488

www.tw.sgs.com

Member of SGS Group

Radar Type 5 for 802.11n40 5310 MHz

veform Num =	18
m of Bursts =	10
t Interval (us) =	1200000

Burst #	OffTime (us)	# Pulses	Chirp (MHz)	PW (us)	Pulse1 Pri(us)	Pulse2 Pri(us)	Pulse3 Pri(us)	StartLoc (us)	StartBurst Interval(us)	EndBurst Interval(us)
1	903753	1	11	55	1000	0	0	903753	0	1199999
2	1066702	2	16	65	1966	1279	0	1971455	1200000	2399999
3	593248	2	20	90	1926	1485	0	2567948	2400000	3599999
4	1463594	2	14	75	1494	1658	0	4034953	3600000	4799999
5	1857102	2	6	75	1057	1784	0	5895207	4800000	5999999
6	1137894	1	18	90	1018	0	0	7035942	6000000	7199999
7	617505	1	16	90	1750	0	0	7654465	7200000	8399999
8	905150	3	12	80	1314	1533	1106	8561365	8400000	9599999
9	1764782	2	6	80	1504	1883	0	10330100	9600000	10799999
10	556311	1	12	100	1268	0	0	10889798	10800000	11999999
Total	number	of	pulses	in	waveform	=	17			

Radar Type 5 for 802.11n40 5310 MHz

veform Num =	19
m of Bursts =	11
t Interval (us) =	1090909

Burst #	OffTime (us)	# Pulses	Chirp (MHz)	PW (us)	Pulse1 Pri(us)	Pulse2 Pri(us)	Pulse3 Pri(us)	StartLoc (us)	StartBurst Interval(us)	EndBurst Interval(us)
1	980542	3	10	50	1886	1179	1143	980542	0	1090908
2	845205	1	16	60	1098	0	0	1829955	1090909	2181817
3	1392482	3	17	100	1675	1742	1416	3223535	2181818	3272726
4	559332	1	8	70	1307	0	0	3787700	3272727	4363635
5	1309191	3	17	90	1136	1651	1558	5098198	4363636	5454544
6	785018	1	12	100	1308	0	0	5887561	5454545	6545453
7	1365897	1	5	70	1418	0	0	7254766	6545454	7636362
8	1081497	3	7	65	1608	1065	1014	8337681	7636363	8727271
9	1351487	1	6	75	1867	0	0	9692855	8727272	9818180
10	134274	1	20	60	1006	0	0	9828996	9818181	10909089
11	1979924	2	19	90	1979	1947	0	11809926	10909090	11999998
Total	number	of	pulses	in	waveform	=	20			

Unless otherwise stated the results shown in this test report refer only to the sample(s) tested and such sample(s) are retained for 90 days only.

除非另有說明，此報告結果僅對測試之樣品負責，同時此樣品僅保留90天。本報告未經本公司書面許可，不可部份複製。

This document is issued by the Company subject to its General Conditions of Service printed overleaf, available on request or accessible at www.sgs.com/terms_and_conditions.htm and, for electronic format documents, subject to Terms and Conditions for Electronic Documents at www.sgs.com/terms_e-document.htm. Attention is drawn to the limitation of liability, indemnification and jurisdiction issues defined therein. Any holder of this document is advised that information contained hereon reflects the Company's findings at the time of its intervention only and within the limits of Client's instructions, if any. The Company's sole responsibility is to its Client and this document does not exonerate parties to a transaction from exercising all their rights and obligations under the transaction documents. This document cannot be reproduced except in full, without prior written approval of the Company. Any unauthorized alteration, forgery or falsification of the content or appearance of this document is unlawful and offenders may be prosecuted to the fullest extent of the law.

SGS Taiwan Ltd.

No.134,WuKungRoad,NewTaipeiIndustrialPark,WukuDistrict,NewTaipeiCity,Taiwan24803/新北市五股區新北產業園區五工路 134 號

台灣檢驗科技股份有限公司

t (886-2) 2299-3279

f (886-2) 2298-0488

www.tw.sgs.com

Member of SGS Group

Radar Type 5 for 802.11n40 5310 MHz

Waveform Num =	20
Number of Bursts =	15
Burst Interval (us) =	800000

Burst #	OffTime (us)	# Pulses	Chirp (MHz)	PW (us)	Pulse1 Pri(us)	Pulse2 Pri(us)	Pulse3 Pri(us)	StartLoc (us)	StartBurst Interval(us)	EndBurst Interval(us)
1	443682	2	11	60	1425	1833	0	443682	0	799999
2	455585	3	14	100	1258	1593	1872	902525	800000	1599999
3	1450517	1	14	55	1806	0	0	2357765	1600000	2399999
4	259034	2	20	85	1404	1266	0	2618605	2400000	3199999
5	1132085	2	16	100	1186	1751	0	3753360	3200000	3999999
6	659010	2	11	50	1423	1821	0	4415307	4000000	4799999
7	575408	3	14	50	1828	1232	1790	4993959	4800000	5599999
8	816370	1	11	95	1433	0	0	5815179	5600000	6399999
9	645547	2	7	90	1013	1863	0	6462159	6400000	7199999
10	1517063	2	10	65	1856	1012	0	7982098	7200000	7999999
11	673357	3	19	85	1945	1483	1732	8658323	8000000	8799999
12	651282	3	13	100	1496	1033	1780	9314765	8800000	9599999
13	453052	1	19	80	1985	0	0	9772126	9600000	10399999
14	1108372	3	19	100	1393	1078	1177	10882483	10400000	11199999
15	845087	2	13	100	1121	1832	0	11731218	11200000	11999999
Total	number	of	pulses	in	waveform	=	32			

Radar Type 5 for 802.11n40 5310 MHz

Waveform Num =	21
Number of Bursts =	12
Burst Interval (us) =	1000000

Burst #	OffTime (us)	# Pulses	Chirp (MHz)	PW (us)	Pulse1 Pri(us)	Pulse2 Pri(us)	Pulse3 Pri(us)	StartLoc (us)	StartBurst Interval(us)	EndBurst Interval(us)
1	75313	2	14	90	1015	1058	0	75313	0	999999
2	1233692	1	18	90	1560	0	0	1311078	1000000	1999999
3	1106322	2	14	75	1954	1146	0	2418960	2000000	2999999
4	658189	2	10	80	1437	1373	0	3080249	3000000	3999999
5	1380705	2	13	70	1051	1117	0	4463764	4000000	4999999
6	1284022	1	9	55	1491	0	0	5749954	5000000	5999999
7	970362	1	16	55	1161	0	0	6721807	6000000	6999999
8	327586	2	12	70	1915	1391	0	7050554	7000000	7999999
9	1530007	1	18	70	1895	0	0	8583867	8000000	8999999
10	944541	2	5	55	1946	1691	0	9530303	9000000	9999999
11	842171	3	8	70	1703	1335	1727	10376111	10000000	10999999
12	1096881	3	7	70	1106	1480	1295	11477757	11000000	11999999
Total	number	of	pulses	in	waveform	=	22			

Unless otherwise stated the results shown in this test report refer only to the sample(s) tested and such sample(s) are retained for 90 days only.

除非另有說明，此報告結果僅對測試之樣品負責，同時此樣品僅保留90天。本報告未經本公司書面許可，不可部份複製。

This document is issued by the Company subject to its General Conditions of Service printed overleaf, available on request or accessible at www.sgs.com/terms_and_conditions.htm and, for electronic format documents, subject to Terms and Conditions for Electronic Documents at www.sgs.com/terms_e-document.htm. Attention is drawn to the limitation of liability, indemnification and jurisdiction issues defined therein. Any holder of this document is advised that information contained hereon reflects the Company's findings at the time of its intervention only and within the limits of Client's instructions, if any. The Company's sole responsibility is to its Client and this document does not exonerate parties to a transaction from exercising all their rights and obligations under the transaction documents. This document cannot be reproduced except in full, without prior written approval of the Company. Any unauthorized alteration, forgery or falsification of the content or appearance of this document is unlawful and offenders may be prosecuted to the fullest extent of the law.

Radar Type 5 for 802.11n40 5310 MHz

Waveform Num =	22
Number of Bursts =	15
Burst Interval (us) =	800000

Burst #	OffTime (us)	# Pulses	Chirp (MHz)	PW (us)	Pulse1 Pri(us)	Pulse2 Pri(us)	Pulse3 Pri(us)	StartLoc (us)	StartBurst Interval(us)	EndBurst Interval(us)
1	694685	2	9	80	1808	1582	0	694685	0	799999
2	366158	2	10	70	1617	1019	0	1064233	800000	1599999
3	1314099	3	12	85	1811	1135	1270	2380968	1600000	2399999
4	249812	1	13	100	1807	0	0	2634996	2400000	3199999
5	883894	2	8	95	1600	1554	0	3520697	3200000	3999999
6	1112151	1	15	95	1336	0	0	4636002	4000000	4799999
7	637886	3	6	100	1932	1837	1292	5275224	4800000	5599999
8	893738	1	5	100	1155	0	0	6174023	5600000	6399999
9	717524	2	11	95	1819	1910	0	6892702	6400000	7199999
10	475287	3	6	80	1443	1192	1176	7371718	7200000	7999999
11	1059047	1	18	55	1294	0	0	8434576	8000000	8799999
12	914804	2	6	80	1762	1587	0	9350674	8800000	9599999
13	376531	1	13	90	1775	0	0	9730554	9600000	10399999
14	668327	3	16	65	1858	1265	1072	10400656	10400000	11199999
15	1143780	3	10	100	1335	1245	1205	11548631	11200000	11999999
Total	number	of	pulses	in	waveform	=	30			

Radar Type 5 for 802.11n40 5310 MHz

Waveform Num =	23
Number of Bursts =	15
Burst Interval (us) =	800000

Burst #	OffTime (us)	# Pulses	Chirp (MHz)	PW (us)	Pulse1 Pri(us)	Pulse2 Pri(us)	Pulse3 Pri(us)	StartLoc (us)	StartBurst Interval(us)	EndBurst Interval(us)
1	735969	3	8	100	1035	1845	1809	735969	0	799999
2	319901	3	9	100	1296	1340	1050	1060559	800000	1599999
3	797610	2	14	65	1805	1500	0	1861855	1600000	2399999
4	766416	3	13	55	1065	1547	1570	2631576	2400000	3199999
5	792969	1	20	55	1266	0	0	3428727	3200000	3999999
6	1144435	3	5	100	1590	1134	1075	4574428	4000000	4799999
7	770590	3	7	60	1786	1114	1995	5348817	4800000	5599999
8	945810	3	11	75	1124	1604	1824	6299522	5600000	6399999
9	284912	2	12	75	1123	1880	0	6588986	6400000	7199999
10	1057807	3	9	80	1035	1879	1412	7649796	7200000	7999999
11	779827	1	9	60	1083	0	0	8433949	8000000	8799999
12	953761	3	17	80	1352	1910	1127	9388793	8800000	9599999
13	264976	1	19	100	1073	0	0	9658158	9600000	10399999
14	1246614	2	17	65	1356	1444	0	10905845	10400000	11199999
15	349574	2	6	90	1203	1329	0	11258219	11200000	11999999
Total	number	of	pulses	in	waveform	=	35			

Unless otherwise stated the results shown in this test report refer only to the sample(s) tested and such sample(s) are retained for 90 days only.

除非另有說明，此報告結果僅對測試之樣品負責，同時此樣品僅保留90天。本報告未經本公司書面許可，不可部份複製。

This document is issued by the Company subject to its General Conditions of Service printed overleaf, available on request or accessible at www.sgs.com/terms_and_conditions.htm and, for electronic format documents, subject to Terms and Conditions for Electronic Documents at www.sgs.com/terms_e-document.htm. Attention is drawn to the limitation of liability, indemnification and jurisdiction issues defined therein. Any holder of this document is advised that information contained hereon reflects the Company's findings at the time of its intervention only and within the limits of Client's instructions, if any. The Company's sole responsibility is to its Client and this document does not exonerate parties to a transaction from exercising all their rights and obligations under the transaction documents. This document cannot be reproduced except in full, without prior written approval of the Company. Any unauthorized alteration, forgery or falsification of the content or appearance of this document is unlawful and offenders may be prosecuted to the fullest extent of the law.

SGS Taiwan Ltd.

No.134,WuKungRoad,NewTaipeiIndustrialPark,WukuDistrict,NewTaipeiCity,Taiwan24803/新北市五股區新北產業園區五工路 134 號

台灣檢驗科技股份有限公司

t (886-2) 2299-3279

f (886-2) 2298-0488

www.tw.sgs.com

Member of SGS Group

Radar Type 5 for 802.11n40 5310 MHz

Waveform Num =	24
Number of Bursts =	17
Burst Interval (us) =	705882

Burst #	OffTime (us)	# Pulses	Chirp (MHz)	PW (us)	Pulse1 Pri(us)	Pulse2 Pri(us)	Pulse3 Pri(us)	StartLoc (us)	StartBurst Interval(us)	EndBurst Interval(us)
1	588897	2	13	75	1414	1105	0	588897	0	705881
2	387608	2	18	95	1914	1576	0	979024	705882	1411763
3	993669	1	17	55	1440	0	0	1976183	1411764	2117645
4	452156	1	18	95	1540	0	0	2429779	2117646	2823527
5	820433	3	15	85	1198	1316	1383	3251752	2823528	3529409
6	573802	2	18	95	1086	1654	0	3829451	3529410	4235291
7	1090684	1	16	100	1348	0	0	4922875	4235292	4941173
8	686986	2	13	85	1088	1157	0	5611209	4941174	5647055
9	60041	3	8	95	1714	1060	1779	5673495	5647056	6352937
10	1120647	3	9	75	1907	1311	1605	6798695	6352938	7058819
11	486363	2	5	70	1971	1813	0	7289881	7058820	7764701
12	923875	3	13	65	1193	1281	1387	8217540	7764702	8470583
13	372900	1	10	70	1482	0	0	8594301	8470584	9176465
14	911077	2	17	95	1723	1099	0	9506860	9176466	9882347
15	875556	2	16	60	1891	1785	0	10385238	9882348	10588229
16	287428	1	5	60	1105	0	0	10676342	10588230	11294111
17	1267157	2	7	70	1417	1762	0	11944604	11294112	11999993
Total	number	of	pulses	in	waveform	=	33			

Unless otherwise stated the results shown in this test report refer only to the sample(s) tested and such sample(s) are retained for 90 days only.

除非另有說明，此報告結果僅對測試之樣品負責，同時此樣品僅保留90天。本報告未經本公司書面許可，不可部份複製。

This document is issued by the Company subject to its General Conditions of Service printed overleaf, available on request or accessible at www.sgs.com/terms_and_conditions.htm and, for electronic format documents, subject to Terms and Conditions for Electronic Documents at www.sgs.com/terms_e-document.htm. Attention is drawn to the limitation of liability, indemnification and jurisdiction issues defined therein. Any holder of this document is advised that information contained hereon reflects the Company's findings at the time of its intervention only and within the limits of Client's instructions, if any. The Company's sole responsibility is to its Client and this document does not exonerate parties to a transaction from exercising all their rights and obligations under the transaction documents. This document cannot be reproduced except in full, without prior written approval of the Company. Any unauthorized alteration, forgery or falsification of the content or appearance of this document is unlawful and offenders may be prosecuted to the fullest extent of the law.

SGS Taiwan Ltd.

No.134,WuKungRoad,NewTaipeiIndustrialPark,WukuDistrict,NewTaipeiCity,Taiwan24803/新北市五股區新北產業園區五工路 134 號

台灣檢驗科技股份有限公司

t (886-2) 2299-3279

f (886-2) 2298-0488

www.tw.sgs.com

Member of SGS Group

Radar Type 5 for 802.11n40 5310 MHz

veform Num =	25
m of Bursts =	19
t Interval (us) =	631579

Burst #	OffTime (us)	# Pulses	Chirp (MHz)	PW (us)	Pulse1 Pri(us)	Pulse2 Pri(us)	Pulse3 Pri(us)	StartLoc (us)	StartBurst Interval(us)	EndBurst Interval(us)
1	89588	1	5	85	1910	0	0	89588	0	631578
2	685880	1	9	85	1138	0	0	777378	631579	1263157
3	493111	2	15	100	1061	1271	0	1271627	1263158	1894736
4	811659	3	14	70	1823	1872	1434	2085618	1894737	2526315
5	545378	3	11	65	1630	1570	1043	2636125	2526316	3157894
6	923582	3	16	85	1344	1671	1325	3563950	3157895	3789473
7	769933	1	10	55	1684	0	0	4338223	3789474	4421052
8	122840	2	10	70	1120	1174	0	4462747	4421053	5052631
9	674561	2	16	75	1263	1927	0	5139602	5052632	5684210
10	837630	2	19	100	1922	1530	0	5980422	5684211	6315789
11	483846	2	7	80	1288	1329	0	6467720	6315790	6947368
12	680353	1	16	70	1948	0	0	7150690	6947369	7578947
13	828323	1	14	80	1773	0	0	7980961	7578948	8210526
14	693437	2	17	80	1939	1772	0	8676171	8210527	8842105
15	284208	1	6	50	1817	0	0	8964090	8842106	9473684
16	1030680	1	5	70	1028	0	0	9996587	9473685	10105263
17	315595	3	16	90	1802	1387	1281	10313210	10105264	10736842
18	442702	3	6	55	1060	1212	1061	10760382	10736843	11368421
19	803431	1	9	75	1043	0	0	11567146	11368422	12000000
Total	number	of	pulses	in	waveform	=	35			

Unless otherwise stated the results shown in this test report refer only to the sample(s) tested and such sample(s) are retained for 90 days only.

除非另有說明，此報告結果僅對測試之樣品負責，同時此樣品僅保留90天。本報告未經本公司書面許可，不可部份複製。

This document is issued by the Company subject to its General Conditions of Service printed overleaf, available on request or accessible at www.sgs.com/terms_and_conditions.htm and, for electronic format documents, subject to Terms and Conditions for Electronic Documents at www.sgs.com/terms_e-document.htm. Attention is drawn to the limitation of liability, indemnification and jurisdiction issues defined therein. Any holder of this document is advised that information contained hereon reflects the Company's findings at the time of its intervention only and within the limits of Client's instructions, if any. The Company's sole responsibility is to its Client and this document does not exonerate parties to a transaction from exercising all their rights and obligations under the transaction documents. This document cannot be reproduced except in full, without prior written approval of the Company. Any unauthorized alteration, forgery or falsification of the content or appearance of this document is unlawful and offenders may be prosecuted to the fullest extent of the law.

SGS Taiwan Ltd.

No.134,WuKungRoad,NewTaipeiIndustrialPark,WukuDistrict,NewTaipeiCity,Taiwan24803/新北市五股區新北產業園區五工路 134 號

台灣檢驗科技股份有限公司

t (886-2) 2299-3279

f (886-2) 2298-0488

www.tw.sgs.com

Member of SGS Group

Radar Type 5 for 802.11n40 5310 MHz

Waveform Num =	26
Number of Bursts =	16
Burst Interval (us) =	750000

Burst #	OffTime (us)	# Pulses	Chirp (MHz)	PW (us)	Pulse1 Pri(us)	Pulse2 Pri(us)	Pulse3 Pri(us)	StartLoc (us)	StartBurst Interval(us)	EndBurst Interval(us)
1	115978	1	12	80	1751	0	0	115978	0	749999
2	805376	2	6	90	1509	1365	0	923105	750000	1499999
3	656522	1	12	65	1803	0	0	1582501	1500000	2249999
4	1373345	2	18	95	1363	1475	0	2957649	2250000	2999999
5	63878	3	11	70	1556	1279	1263	3024365	3000000	3749999
6	1093019	3	20	70	1230	1727	1066	4121482	3750000	4499999
7	669165	1	10	65	1566	0	0	4794670	4500000	5249999
8	689818	3	9	70	1909	1244	1612	5486054	5250000	5999999
9	948476	3	7	95	1753	1059	1939	6439295	6000000	6749999
10	382471	3	10	100	1198	1985	1434	6826517	6750000	7499999
11	1404678	3	18	80	1438	1421	1975	8235812	7500000	8249999
12	137483	2	15	75	1202	1835	0	8378129	8250000	8999999
13	831311	2	8	95	1570	1327	0	9212477	9000000	9749999
14	918961	1	20	60	1532	0	0	10134335	9750000	10499999
15	373777	3	17	65	1636	1638	1396	10509644	10500000	11249999
16	1454144	3	14	60	1398	1149	1022	11968458	11250000	11999999
Total	number	of	pulses	in	waveform	=	36			

Radar Type 5 for 802.11n40 5310 MHz

Waveform Num =	27
Number of Bursts =	14
Burst Interval (us) =	857143

Burst #	OffTime (us)	# Pulses	Chirp (MHz)	PW (us)	Pulse1 Pri(us)	Pulse2 Pri(us)	Pulse3 Pri(us)	StartLoc (us)	StartBurst Interval(us)	EndBurst Interval(us)
1	220957	2	6	90	1027	1916	0	220957	0	857142
2	725579	1	19	90	1574	0	0	949479	857143	1714285
3	1250032	2	11	90	1791	1730	0	2201085	1714286	2571428
4	371342	3	20	50	1962	1616	1598	2575948	2571429	3428571
5	1040232	1	9	60	1788	0	0	3621356	3428572	4285714
6	1345582	1	5	95	1759	0	0	4968726	4285715	5142857
7	534498	1	9	55	1868	0	0	5504983	5142858	6000000
8	1052366	3	6	90	1996	1751	1348	6559217	6000001	6857143
9	1013644	2	12	90	1590	1955	0	7577956	6857144	7714286
10	557780	2	12	65	1069	1022	0	8139281	7714287	8571429
11	544037	1	18	80	1128	0	0	8685409	8571430	9428572
12	752664	3	18	90	1796	1368	1948	9439201	9428573	10285715
13	1474125	2	20	85	1272	1031	0	10918438	10285716	11142858
14	398770	1	9	100	1598	0	0	11319511	11142859	12000001
Total	number	of	pulses	in	waveform	=	25			

Unless otherwise stated the results shown in this test report refer only to the sample(s) tested and such sample(s) are retained for 90 days only.

除非另有說明，此報告結果僅對測試之樣品負責，同時此樣品僅保留90天。本報告未經本公司書面許可，不可部份複製。

This document is issued by the Company subject to its General Conditions of Service printed overleaf, available on request or accessible at www.sgs.com/terms_and_conditions.htm and, for electronic format documents, subject to Terms and Conditions for Electronic Documents at www.sgs.com/terms_e-document.htm. Attention is drawn to the limitation of liability, indemnification and jurisdiction issues defined therein. Any holder of this document is advised that information contained hereon reflects the Company's findings at the time of its intervention only and within the limits of Client's instructions, if any. The Company's sole responsibility is to its Client and this document does not exonerate parties to a transaction from exercising all their rights and obligations under the transaction documents. This document cannot be reproduced except in full, without prior written approval of the Company. Any unauthorized alteration, forgery or falsification of the content or appearance of this document is unlawful and offenders may be prosecuted to the fullest extent of the law.

SGS Taiwan Ltd.

No.134,WuKungRoad,NewTaipeiIndustrialPark,WukuDistrict,NewTaipeiCity,Taiwan24803/新北市五股區新北產業園區五工路 134 號

台灣檢驗科技股份有限公司

t (886-2) 2299-3279

f (886-2) 2298-0488

www.tw.sgs.com

Member of SGS Group

Radar Type 5 for 802.11n40 5310 MHz

Waveform Num =	28
Number of Bursts =	17
Burst Interval (us) =	705882

Burst #	OffTime (us)	# Pulses	Chirp (MHz)	PW (us)	Pulse1 Pri(us)	Pulse2 Pri(us)	Pulse3 Pri(us)	StartLoc (us)	StartBurst Interval(us)	EndBurst Interval(us)
1	87273	1	17	85	1791	0	0	87273	0	705881
2	738748	1	17	100	1299	0	0	827812	705882	1411763
3	626515	1	11	55	1916	0	0	1455626	1411764	2117645
4	1302700	1	9	95	1320	0	0	2760242	2117646	2823527
5	355754	2	10	50	1834	1077	0	3117316	2823528	3529409
6	860242	2	5	85	1379	1951	0	3980469	3529410	4235291
7	549560	1	11	70	1934	0	0	4533359	4235292	4941173
8	585572	1	14	95	1595	0	0	5120865	4941174	5647055
9	710920	3	14	65	1072	1711	1838	5833380	5647056	6352937
10	999495	3	12	75	1592	1811	1378	6837496	6352938	7058819
11	358972	2	10	55	1964	1792	0	7201249	7058820	7764701
12	784018	3	14	80	1756	1095	1627	7989023	7764702	8470583
13	779427	2	9	70	1242	1535	0	8772928	8470584	9176465
14	414279	1	19	60	1615	0	0	9189984	9176466	9882347
15	746932	1	12	60	1402	0	0	9938531	9882348	10588229
16	659689	1	15	55	1692	0	0	10599622	10588230	11294111
17	1030810	2	10	90	1854	1266	0	11632124	11294112	11999993
Total	number	of	pulses	in	waveform	=	28			

Unless otherwise stated the results shown in this test report refer only to the sample(s) tested and such sample(s) are retained for 90 days only.

除非另有說明，此報告結果僅對測試之樣品負責，同時此樣品僅保留90天。本報告未經本公司書面許可，不可部份複製。

This document is issued by the Company subject to its General Conditions of Service printed overleaf, available on request or accessible at www.sgs.com/terms_and_conditions.htm and, for electronic format documents, subject to Terms and Conditions for Electronic Documents at www.sgs.com/terms_e-document.htm. Attention is drawn to the limitation of liability, indemnification and jurisdiction issues defined therein. Any holder of this document is advised that information contained hereon reflects the Company's findings at the time of its intervention only and within the limits of Client's instructions, if any. The Company's sole responsibility is to its Client and this document does not exonerate parties to a transaction from exercising all their rights and obligations under the transaction documents. This document cannot be reproduced except in full, without prior written approval of the Company. Any unauthorized alteration, forgery or falsification of the content or appearance of this document is unlawful and offenders may be prosecuted to the fullest extent of the law.

SGS Taiwan Ltd.

No.134,WuKungRoad,NewTaipeiIndustrialPark,WukuDistrict,NewTaipeiCity,Taiwan24803/新北市五股區新北產業園區五工路 134 號

台灣檢驗科技股份有限公司

t (886-2) 2299-3279

f (886-2) 2298-0488

www.tw.sgs.com

Member of SGS Group

Radar Type 5 for 802.11n40 5310 MHz

Waveform Num =	29
Number of Bursts =	18
Time Interval (us) =	666667

Burst #	OffTime (us)	# Pulses	Chirp (MHz)	PW (us)	Pulse1 Pri(us)	Pulse2 Pri(us)	Pulse3 Pri(us)	StartLoc (us)	StartBurst Interval(us)	EndBurst Interval(us)
1	342539	1	14	50	1301	0	0	342539	0	666666
2	536906	3	20	65	1660	1159	1615	880746	666667	1333333
3	659582	1	8	55	1289	0	0	1544762	1333334	2000000
4	598824	3	9	95	1130	1797	1301	2144875	2000001	2666667
5	1028543	2	16	50	1685	1855	0	3177646	2666668	3333334
6	309361	2	7	55	1231	1271	0	3490547	3333335	4000001
7	1058214	1	17	100	1150	0	0	4551263	4000002	4666668
8	426785	2	6	70	1336	1544	0	4979198	4666669	5333335
9	392491	3	17	90	1187	1821	1519	5374569	5333336	6000002
10	629268	1	11	60	1092	0	0	6008364	6000003	6666669
11	1003664	2	9	70	1555	1727	0	7013120	6666670	7333336
12	670327	2	12	65	1706	1061	0	7686729	7333337	8000003
13	795079	2	19	65	1344	1467	0	8484575	8000004	8666670
14	710127	2	9	80	1852	1256	0	9197513	8666671	9333337
15	298396	3	19	80	1671	1129	1567	9499017	9333338	10000004
16	862916	3	17	90	1152	1579	1853	10366300	10000005	10666671
17	669348	1	6	75	1475	0	0	11040232	10666672	11333338
18	515540	2	12	50	1189	1735	0	11557247	11333339	12000005
Total	number	of	pulses	in	waveform	=	36			

Radar Type 5 for 802.11n40 5310 MHz

Waveform Num =	30
Number of Bursts =	14
Time Interval (us) =	857143

Burst #	OffTime (us)	# Pulses	Chirp (MHz)	PW (us)	Pulse1 Pri(us)	Pulse2 Pri(us)	Pulse3 Pri(us)	StartLoc (us)	StartBurst Interval(us)	EndBurst Interval(us)
1	442015	1	11	65	1362	0	0	442015	0	857142
2	1042255	2	11	90	1928	1352	0	1485632	857143	1714285
3	351880	3	11	95	1646	1182	1160	1840792	1714286	2571428
4	945027	2	11	85	1236	1291	0	2789807	2571429	3428571
5	838398	2	12	85	1001	1376	0	3630732	3428572	4285714
6	1236491	2	15	60	1057	1946	0	4869600	4285715	5142857
7	496809	3	15	90	1607	1734	1387	5369412	5142858	6000000
8	813225	1	14	55	1217	0	0	6187365	6000001	6857143
9	807722	3	5	75	1978	1238	1772	6996304	6857144	7714286
10	1221969	1	19	55	1424	0	0	8223261	7714287	8571429
11	448807	2	13	60	1264	1377	0	8673492	8571430	9428572
12	1284746	2	9	60	1819	1857	0	9960879	9428573	10285715
13	675317	1	20	75	1022	0	0	10639872	10285716	11142858
14	1295921	3	17	75	1889	1748	1202	11936815	11142859	12000001
Total	number	of	pulses	in	waveform	=	28			

Unless otherwise stated the results shown in this test report refer only to the sample(s) tested and such sample(s) are retained for 90 days only.

除非另有說明，此報告結果僅對測試之樣品負責，同時此樣品僅保留90天。本報告未經本公司書面許可，不可部份複製。

This document is issued by the Company subject to its General Conditions of Service printed overleaf, available on request or accessible at www.sgs.com/terms_and_conditions.htm and, for electronic format documents, subject to Terms and Conditions for Electronic Documents at www.sgs.com/terms_e-document.htm. Attention is drawn to the limitation of liability, indemnification and jurisdiction issues defined therein. Any holder of this document is advised that information contained hereon reflects the Company's findings at the time of its intervention only and within the limits of Client's instructions, if any. The Company's sole responsibility is to its Client and this document does not exonerate parties to a transaction from exercising all their rights and obligations under the transaction documents. This document cannot be reproduced except in full, without prior written approval of the Company. Any unauthorized alteration, forgery or falsification of the content or appearance of this document is unlawful and offenders may be prosecuted to the fullest extent of the law.

802.11n40 5510 MHz:

FCC13-22 Radar Test Summary				
Short Pulse Radar Type	Minimum Number of Trials	Detection(%)	Minimum Percentage of Successful Detection(%)	Pass/Fail
1	30	100.00	60	Pass
2	30	100.00	60	Pass
3	30	100.00	60	Pass
4	30	93.33	60	Pass
Aggregate (Radar Types 1-4)	120	98.33	80	Pass
Long Pulse Radar Test Waveform	Minimum Number of Trials	Detection	Minimum Percentage of Successful Detection(Limit)	Pass/Fail
5 - Variable	30	100.00	80	Pass
Frequency Hopping Radar Test Waveform	Minimum Number of Trials	Detection	Minimum Percentage of Successful Detection(Limit)	Pass/Fail
6	30	100.00	70	Pass

Unless otherwise stated the results shown in this test report refer only to the sample(s) tested and such sample(s) are retained for 90 days only.

除非另有說明，此報告結果僅對測試之樣品負責，同時此樣品僅保留90天。本報告未經本公司書面許可，不可部份複製。

This document is issued by the Company subject to its General Conditions of Service printed overleaf, available on request or accessible at www.sgs.com/terms_and_conditions.htm and, for electronic format documents, subject to Terms and Conditions for Electronic Documents at www.sgs.com/terms_e-document.htm. Attention is drawn to the limitation of liability, indemnification and jurisdiction issues defined therein. Any holder of this document is advised that information contained hereon reflects the Company's findings at the time of its intervention only and within the limits of Client's instructions, if any. The Company's sole responsibility is to its Client and this document does not exonerate parties to a transaction from exercising all their rights and obligations under the transaction documents. This document cannot be reproduced except in full, without prior written approval of the Company. Any unauthorized alteration, forgery or falsification of the content or appearance of this document is unlawful and offenders may be prosecuted to the fullest extent of the law.

SGS Taiwan Ltd.

No.134,WuKungRoad,NewTaipeiIndustrialPark,WukuDistrict,NewTaipeiCity,Taiwan24803/新北市五股區新北產業園區五工路 134 號

台灣檢驗科技股份有限公司

t (886-2) 2299-3279

f (886-2) 2298-0488

www.tw.sgs.com

Member of SGS Group

Radar Type 1 for 802.11n40 5510 MHz:

Data Sheet for FCC Variable Radar Type 1				
1 us Pulse Width, PRI Test A&Test B				
Trial	PRI	Pulses Per Burst	Test	Successful Detection

Unless otherwise stated the results shown in this test report refer only to the sample(s) tested and such sample(s) are retained for 90 days only.

除非另有說明，此報告結果僅對測試之樣品負責，同時此樣品僅保留90天。本報告未經本公司書面許可，不可部份複製。

This document is issued by the Company subject to its General Conditions of Service printed overleaf, available on request or accessible at www.sgs.com/terms_and_conditions.htm and, for electronic format documents, subject to Terms and Conditions for Electronic Documents at www.sgs.com/terms_e-document.htm. Attention is drawn to the limitation of liability, indemnification and jurisdiction issues defined therein. Any holder of this document is advised that information contained hereon reflects the Company's findings at the time of its intervention only and within the limits of Client's instructions, if any. The Company's sole responsibility is to its Client and this document does not exonerate parties to a transaction from exercising all their rights and obligations under the transaction documents. This document cannot be reproduced except in full, without prior written approval of the Company. Any unauthorized alteration, forgery or falsification of the content or appearance of this document is unlawful and offenders may be prosecuted to the fullest extent of the law.

SGS Taiwan Ltd.

No.134,WuKungRoad,NewTaipeiIndustrialPark,WukuDistrict,NewTaipeiCity,Taiwan24803/新北市五股區新北產業園區五工路 134 號

台灣檢驗科技股份有限公司

t (886-2) 2299-3279

f (886-2) 2298-0488

www.tw.sgs.com

Member of SGS Group

Radar Type 2 for 802.11n40 5510 MHz:

Data Sheet for FCC Variable Radar Type 2				
1-5 us Pulse Width, PRI 150-230 us, 23-29 Pulses per Burst				
Trial	Pulse Width	PRI	Pulses Per Burst	Successful Detection

Unless otherwise stated the results shown in this test report refer only to the sample(s) tested and such sample(s) are retained for 90 days only.

除非另有說明，此報告結果僅對測試之樣品負責，同時此樣品僅保留90天。本報告未經本公司書面許可，不可部份複製。

This document is issued by the Company subject to its General Conditions of Service printed overleaf, available on request or accessible at www.sgs.com/terms_and_conditions.htm and, for electronic format documents, subject to Terms and Conditions for Electronic Documents at www.sgs.com/terms_e-document.htm. Attention is drawn to the limitation of liability, indemnification and jurisdiction issues defined therein. Any holder of this document is advised that information contained hereon reflects the Company's findings at the time of its intervention only and within the limits of Client's instructions, if any. The Company's sole responsibility is to its Client and this document does not exonerate parties to a transaction from exercising all their rights and obligations under the transaction documents. This document cannot be reproduced except in full, without prior written approval of the Company. Any unauthorized alteration, forgery or falsification of the content or appearance of this document is unlawful and offenders may be prosecuted to the fullest extent of the law.

SGS Taiwan Ltd.

No.134,WuKungRoad,NewTaipeiIndustrialPark,WukuDistrict,NewTaipeiCity,Taiwan24803/新北市五股區新北產業園區五工路 134 號

台灣檢驗科技股份有限公司

t (886-2) 2299-3279

f (886-2) 2298-0488

www.tw.sgs.com

Member of SGS Group

Radar Type 3 for 802.11n40 5510 MHz:

Data Sheet for FCC Variable Radar Type 3				
6-10 us Pulse Width, PRI 200-500 us, 16-18 Pulses per Burst				
Trial	Pulse Width	PRI	Pulses Per Burst	Successful Detection

Unless otherwise stated the results shown in this test report refer only to the sample(s) tested and such sample(s) are retained for 90 days only.

除非另有說明，此報告結果僅對測試之樣品負責，同時此樣品僅保留90天。本報告未經本公司書面許可，不可部份複製。

This document is issued by the Company subject to its General Conditions of Service printed overleaf, available on request or accessible at www.sgs.com/terms_and_conditions.htm and, for electronic format documents, subject to Terms and Conditions for Electronic Documents at www.sgs.com/terms_e-document.htm. Attention is drawn to the limitation of liability, indemnification and jurisdiction issues defined therein. Any holder of this document is advised that information contained hereon reflects the Company's findings at the time of its intervention only and within the limits of Client's instructions, if any. The Company's sole responsibility is to its Client and this document does not exonerate parties to a transaction from exercising all their rights and obligations under the transaction documents. This document cannot be reproduced except in full, without prior written approval of the Company. Any unauthorized alteration, forgery or falsification of the content or appearance of this document is unlawful and offenders may be prosecuted to the fullest extent of the law.

SGS Taiwan Ltd.

No.134,WuKungRoad,NewTaipeiIndustrialPark,WukuDistrict,NewTaipeiCity,Taiwan24803/新北市五股區新北產業園區五工路 134 號

台灣檢驗科技股份有限公司

t (886-2) 2299-3279

f (886-2) 2298-0488

www.tw.sgs.com

Member of SGS Group

Radar Type 4 for 802.11n40 5510 MHz:

Data Sheet for FCC Variable Radar Type 4				
11-20 us Pulse Width, PRI 200-500 us, 12-16 Pulses per Burst				
Trial	Pulse Width	PRI	Pulses Per Burst	Successful Detection

Unless otherwise stated the results shown in this test report refer only to the sample(s) tested and such sample(s) are retained for 90 days only.

除非另有說明，此報告結果僅對測試之樣品負責，同時此樣品僅保留90天。本報告未經本公司書面許可，不可部份複製。

This document is issued by the Company subject to its General Conditions of Service printed overleaf, available on request or accessible at www.sgs.com/terms_and_conditions.htm and, for electronic format documents, subject to Terms and Conditions for Electronic Documents at www.sgs.com/terms_e-document.htm. Attention is drawn to the limitation of liability, indemnification and jurisdiction issues defined therein. Any holder of this document is advised that information contained hereon reflects the Company's findings at the time of its intervention only and within the limits of Client's instructions, if any. The Company's sole responsibility is to its Client and this document does not exonerate parties to a transaction from exercising all their rights and obligations under the transaction documents. This document cannot be reproduced except in full, without prior written approval of the Company. Any unauthorized alteration, forgery or falsification of the content or appearance of this document is unlawful and offenders may be prosecuted to the fullest extent of the law.

SGS Taiwan Ltd.

No.134,WuKungRoad,NewTaipeiIndustrialPark,WukuDistrict,NewTaipeiCity,Taiwan24803/新北市五股區新北產業園區五工路 134 號

台灣檢驗科技股份有限公司

t (886-2) 2299-3279

f (886-2) 2298-0488

www.tw.sgs.com

Member of SGS Group

Radar Type 5 for 802.11n40 5510 MHz

Waveform Num =	1
Num of Bursts =	9
Burst Interval (us) =	1333333

Burst #	OffTime (us)	# Pulses	Chirp (MHz)	PW (us)	Pulse1 Pri(us)	Pulse2 Pri(us)	Pulse3 Pri(us)	StartLoc (us)	StartBurst Interval(us)	EndBurst Interval(us)
1	1289320	2	5	50	1403	1600	0	1289320	0	1333332
2	304327	1	6	75	1618	0	0	1596650	1333333	2666665
3	2236364	1	6	70	1798	0	0	3834632	2666666	3999998
4	625763	2	15	100	1562	1131	0	4462193	3999999	5333331
5	1317721	1	5	70	1708	0	0	5782607	5333332	6666664
6	903568	3	15	85	1051	1159	1582	6687883	6666665	7999997
7	1623557	3	15	55	1247	1308	1750	8315232	7999998	9333330
8	1881027	1	18	70	1347	0	0	10200564	9333331	10666663
9	1094900	3	11	50	1965	1576	1433	11296811	10666664	11999996
Total	number	of	pulses	in	waveform	=	17			

Radar Type 5 for 802.11n40 5510 MHz

Waveform Num =	2
Num of Bursts =	20
Burst Interval (us) =	600000

Burst #	OffTime (us)	# Pulses	Chirp (MHz)	PW (us)	Pulse1 Pri(us)	Pulse2 Pri(us)	Pulse3 Pri(us)	StartLoc (us)	StartBurst Interval(us)	EndBurst Interval(us)
1	169452	1	7	55	1586	0	0	169452	0	599999
2	752028	1	14	55	1605	0	0	923066	600000	1199999
3	789973	1	7	60	1771	0	0	1714644	1200000	1799999
4	591213	1	5	80	1356	0	0	2307628	1800000	2399999
5	250558	2	11	65	1156	1940	0	2559542	2400000	2999999
6	763123	3	19	65	1678	1397	1710	3325761	3000000	3599999
7	442693	1	16	100	1718	0	0	3773239	3600000	4199999
8	695682	2	16	70	1075	1636	0	4470639	4200000	4799999
9	722066	3	10	100	1297	1928	1583	5195416	4800000	5399999
10	216153	1	10	100	1901	0	0	5416377	5400000	5999999
11	897600	2	11	50	1836	1420	0	6315878	6000000	6599999
12	317595	1	15	95	1980	0	0	6636729	6600000	7199999
13	824175	1	13	85	1223	0	0	7462884	7200000	7799999
14	833432	1	20	60	1261	0	0	8297539	7800000	8399999
15	492503	1	11	90	1183	0	0	8791303	8400000	8999999
16	404748	3	19	80	1135	1640	1632	9197234	9000000	9599999
17	679686	2	7	60	1505	1707	0	9881327	9600000	10199999
18	510839	1	6	55	1595	0	0	10395378	10200000	10799999
19	501585	1	8	75	1516	0	0	10898558	10800000	11399999
20	1002608	3	11	70	1274	1458	1037	11902682	11400000	11999999
Total	number	of	pulses	in	waveform	=	32			

Unless otherwise stated the results shown in this test report refer only to the sample(s) tested and such sample(s) are retained for 90 days only.

除非另有說明，此報告結果僅對測試之樣品負責，同時此樣品僅保留90天。本報告未經本公司書面許可，不可部份複製。

This document is issued by the Company subject to its General Conditions of Service printed overleaf, available on request or accessible at www.sgs.com/terms_and_conditions.htm and, for electronic format documents, subject to Terms and Conditions for Electronic Documents at www.sgs.com/terms_e-document.htm. Attention is drawn to the limitation of liability, indemnification and jurisdiction issues defined therein. Any holder of this document is advised that information contained hereon reflects the Company's findings at the time of its intervention only and within the limits of Client's instructions, if any. The Company's sole responsibility is to its Client and this document does not exonerate parties to a transaction from exercising all their rights and obligations under the transaction documents. This document cannot be reproduced except in full, without prior written approval of the Company. Any unauthorized alteration, forgery or falsification of the content or appearance of this document is unlawful and offenders may be prosecuted to the fullest extent of the law.

SGS Taiwan Ltd.

No.134,WuKungRoad,NewTaipeiIndustrialPark,WukuDistrict,NewTaipeiCity,Taiwan24803/新北市五股區新北產業園區五工路 134 號

台灣檢驗科技股份有限公司

t (886-2) 2299-3279

f (886-2) 2298-0488

www.tw.sgs.com

Member of SGS Group

Radar Type 5 for 802.11n40 5510 MHz

Waveform Num =	3
Num of Bursts =	16
Burst Interval (us) =	750000

Burst #	OffTime (us)	# Pulses	Chirp (MHz)	PW (us)	Pulse1 Pri(us)	Pulse2 Pri(us)	Pulse3 Pri(us)	StartLoc (us)	StartBurst Interval(us)	EndBurst Interval(us)
1	407001	2	20	65	1477	1653	0	407001	0	749999
2	979682	2	15	65	1917	1337	0	1389813	750000	1499999
3	165694	2	7	80	1224	1068	0	1558761	1500000	2249999
4	708968	2	17	55	1004	1802	0	2270021	2250000	2999999
5	840124	3	7	90	1614	1309	1876	3112951	3000000	3749999
6	1039078	2	19	85	1189	1636	0	4156828	3750000	4499999
7	871177	3	8	85	1204	1637	1281	5030830	4500000	5249999
8	875313	3	9	85	1853	1647	1957	5910265	5250000	5999999
9	735999	3	19	55	1729	1905	1331	6651721	6000000	6749999
10	124013	3	20	60	1863	1700	1412	6780699	6750000	7499999
11	1069079	2	17	100	1223	1869	0	7854753	7500000	8249999
12	773765	1	17	75	1996	0	0	8631610	8250000	8999999
13	531600	2	10	50	1913	1178	0	9165206	9000000	9749999
14	864294	2	14	100	1696	1874	0	10032591	9750000	10499999
15	942565	1	12	65	1625	0	0	10978726	10500000	11249999
16	324998	3	15	60	1375	1031	1879	11305349	11250000	11999999
Total	number	of	pulses	in	waveform	=	36			

Radar Type 5 for 802.11n40 5510 MHz

Waveform Num =	4
Num of Bursts =	8
Burst Interval (us) =	1500000

Burst #	OffTime (us)	# Pulses	Chirp (MHz)	PW (us)	Pulse1 Pri(us)	Pulse2 Pri(us)	Pulse3 Pri(us)	StartLoc (us)	StartBurst Interval(us)	EndBurst Interval(us)
1	1326689	2	20	50	1191	1056	0	1326689	0	1499999
2	424982	1	16	50	1308	0	0	1753918	1500000	2999999
3	1665153	1	18	65	1532	0	0	3420379	3000000	4499999
4	1095347	1	12	80	1829	0	0	4517258	4500000	5999999
5	2906673	2	13	80	1707	1344	0	7425760	6000000	7499999
6	1137090	1	19	100	1836	0	0	8565901	7500000	8999999
7	1132385	3	12	65	1160	1198	1313	9700122	9000000	10499999
8	1378093	3	11	70	1378	1612	1424	11081886	10500000	11999999
Total	number	of	pulses	in	waveform	=	14			

Unless otherwise stated the results shown in this test report refer only to the sample(s) tested and such sample(s) are retained for 90 days only.

除非另有說明，此報告結果僅對測試之樣品負責，同時此樣品僅保留90天。本報告未經本公司書面許可，不可部份複製。

This document is issued by the Company subject to its General Conditions of Service printed overleaf, available on request or accessible at www.sgs.com/terms_and_conditions.htm and, for electronic format documents, subject to Terms and Conditions for Electronic Documents at www.sgs.com/terms_e-document.htm. Attention is drawn to the limitation of liability, indemnification and jurisdiction issues defined therein. Any holder of this document is advised that information contained hereon reflects the Company's findings at the time of its intervention only and within the limits of Client's instructions, if any. The Company's sole responsibility is to its Client and this document does not exonerate parties to a transaction from exercising all their rights and obligations under the transaction documents. This document cannot be reproduced except in full, without prior written approval of the Company. Any unauthorized alteration, forgery or falsification of the content or appearance of this document is unlawful and offenders may be prosecuted to the fullest extent of the law.

SGS Taiwan Ltd.

No.134,WuKungRoad,NewTaipeiIndustrialPark,WukuDistrict,NewTaipeiCity,Taiwan24803/新北市五股區新北產業園區五工路 134 號

台灣檢驗科技股份有限公司

t (886-2) 2299-3279

f (886-2) 2298-0488

www.tw.sgs.com

Member of SGS Group

Radar Type 5 for 802.11n40 5510 MHz

Waveform Num =	5
Num of Bursts =	8
Burst Interval (us) =	150000

Burst #	OffTime (us)	# Pulses	Chirp (MHz)	PW (us)	Pulse1 Pri(us)	Pulse2 Pri(us)	Pulse3 Pri(us)	StartLoc (us)	StartBurst Interval(us)	EndBurst Interval(us)
1	705284	2	19	90	1324	1603	0	705284	0	1499999
2	2025990	3	17	90	1691	1072	1724	2734201	150000	2999999
3	909828	1	17	85	1975	0	0	3648516	300000	4499999
4	1656034	1	5	60	1382	0	0	5306525	450000	5999999
5	1376924	2	19	75	1918	1517	0	6684831	600000	7499999
6	1338132	1	15	80	1306	0	0	8026398	750000	8999999
7	1303459	3	17	65	1238	1613	1305	9331163	900000	10499999
8	2178551	1	6	50	1360	0	0	11513870	1050000	11999999
Total	number	of	pulses	in	waveform	=	14			

Radar Type 5 for 802.11n40 5510 MHz

Waveform Num =	6
Num of Bursts =	13
Burst Interval (us) =	923077

Burst #	OffTime (us)	# Pulses	Chirp (MHz)	PW (us)	Pulse1 Pri(us)	Pulse2 Pri(us)	Pulse3 Pri(us)	StartLoc (us)	StartBurst Interval(us)	EndBurst Interval(us)
1	257102	2	9	70	1215	1517	0	257102	0	923076
2	753138	3	11	85	1757	1333	1381	1012972	923077	1846153
3	1237253	3	17	65	1196	1693	1836	2254696	1846154	2769230
4	1126793	3	7	85	1108	1258	1043	3386214	2769231	3692307
5	938815	3	15	90	1780	1752	1101	4328438	3692308	4615384
6	692138	3	10	85	1125	1935	1212	5025209	4615385	5538461
7	1193197	3	11	55	1194	1475	1904	6222678	5538462	6461538
8	999686	1	7	70	1784	0	0	7226937	6461539	7384615
9	213675	1	18	70	1104	0	0	7442396	7384616	8307692
10	1725019	3	20	50	1707	1734	1682	9168519	8307693	9230769
11	153500	1	13	100	1593	0	0	9327142	9230770	10153846
12	920027	1	16	65	1053	0	0	10248762	10153847	11076923
13	975583	1	19	75	1070	0	0	11225398	11076924	12000000
Total	number	of	pulses	in	waveform	=	28			

Unless otherwise stated the results shown in this test report refer only to the sample(s) tested and such sample(s) are retained for 90 days only.

除非另有說明，此報告結果僅對測試之樣品負責，同時此樣品僅保留90天。本報告未經本公司書面許可，不可部份複製。

This document is issued by the Company subject to its General Conditions of Service printed overleaf, available on request or accessible at www.sgs.com/terms_and_conditions.htm and, for electronic format documents, subject to Terms and Conditions for Electronic Documents at www.sgs.com/terms_e-document.htm. Attention is drawn to the limitation of liability, indemnification and jurisdiction issues defined therein. Any holder of this document is advised that information contained hereon reflects the Company's findings at the time of its intervention only and within the limits of Client's instructions, if any. The Company's sole responsibility is to its Client and this document does not exonerate parties to a transaction from exercising all their rights and obligations under the transaction documents. This document cannot be reproduced except in full, without prior written approval of the Company. Any unauthorized alteration, forgery or falsification of the content or appearance of this document is unlawful and offenders may be prosecuted to the fullest extent of the law.

SGS Taiwan Ltd.

No.134,WuKungRoad,NewTaipeiIndustrialPark,WukuDistrict,NewTaipeiCity,Taiwan24803/新北市五股區新北產業園區五工路 134 號

台灣檢驗科技股份有限公司

t (886-2) 2299-3279

f (886-2) 2298-0488

www.tw.sgs.com

Member of SGS Group

Radar Type 5 for 802.11n40 5510 MHz

Waveform Num =	7
Num of Bursts =	8
Burst Interval (us) =	1500000

Burst #	OffTime (us)	# Pulses	Chirp (MHz)	PW (us)	Pulse1 Pri(us)	Pulse2 Pri(us)	Pulse3 Pri(us)	StartLoc (us)	StartBurst Interval(us)	EndBurst Interval(us)
1	539884	1	9	50	1314	0	0	539884	0	1499999
2	2397939	1	14	75	1500	0	0	2939137	1500000	2999999
3	365718	3	7	75	1120	1311	1677	3306355	3000000	4499999
4	2437879	2	8	80	1815	1963	0	5748342	4500000	5999999
5	563039	2	9	65	1562	1091	0	6315159	6000000	7499999
6	1418344	2	5	85	1696	1379	0	7736156	7500000	8999999
7	2404493	2	17	90	1595	1742	0	10143724	9000000	10499999
8	367473	3	10	70	1232	1129	1576	10514534	10500000	11999999
Total	number	of	pulses	in	waveform	=	16			

Radar Type 5 for 802.11n40 5510 MHz

Waveform Num =	8
Num of Bursts =	15
Burst Interval (us) =	800000

Burst #	OffTime (us)	# Pulses	Chirp (MHz)	PW (us)	Pulse1 Pri(us)	Pulse2 Pri(us)	Pulse3 Pri(us)	StartLoc (us)	StartBurst Interval(us)	EndBurst Interval(us)
1	437253	1	14	75	1766	0	0	437253	0	799999
2	1150126	3	15	95	1100	1445	1803	1589145	800000	1599999
3	448261	1	13	70	1774	0	0	2041754	1600000	2399999
4	733143	2	12	100	1154	1211	0	2776671	2400000	3199999
5	900478	3	5	80	1594	1820	1243	3679514	3200000	3999999
6	477462	3	16	55	1729	1658	1814	4161633	4000000	4799999
7	1271777	2	19	75	1023	1561	0	5438611	4800000	5599999
8	523392	3	13	80	1239	1235	1186	5964587	5600000	6399999
9	760279	2	12	55	1041	1798	0	6728526	6400000	7199999
10	1172912	2	18	95	1231	1747	0	7904277	7200000	7999999
11	388118	2	12	70	1757	1355	0	8295373	8000000	8799999
12	710696	2	6	60	1324	1501	0	9009181	8800000	9599999
13	691150	1	16	85	1053	0	0	9703156	9600000	10399999
14	1366815	3	16	50	1127	1224	1513	11071024	10400000	11199999
15	662566	2	8	85	1827	1117	0	11737454	11200000	11999999
Total	number	of	pulses	in	waveform	=	32			

Unless otherwise stated the results shown in this test report refer only to the sample(s) tested and such sample(s) are retained for 90 days only.

除非另有說明，此報告結果僅對測試之樣品負責，同時此樣品僅保留90天。本報告未經本公司書面許可，不可部份複製。

This document is issued by the Company subject to its General Conditions of Service printed overleaf, available on request or accessible at www.sgs.com/terms_and_conditions.htm and, for electronic format documents, subject to Terms and Conditions for Electronic Documents at www.sgs.com/terms_e-document.htm. Attention is drawn to the limitation of liability, indemnification and jurisdiction issues defined therein. Any holder of this document is advised that information contained hereon reflects the Company's findings at the time of its intervention only and within the limits of Client's instructions, if any. The Company's sole responsibility is to its Client and this document does not exonerate parties to a transaction from exercising all their rights and obligations under the transaction documents. This document cannot be reproduced except in full, without prior written approval of the Company. Any unauthorized alteration, forgery or falsification of the content or appearance of this document is unlawful and offenders may be prosecuted to the fullest extent of the law.

SGS Taiwan Ltd.

No.134,WuKungRoad,NewTaipeiIndustrialPark,WukuDistrict,NewTaipeiCity,Taiwan24803/新北市五股區新北產業園區五工路 134 號

台灣檢驗科技股份有限公司

t (886-2) 2299-3279

f (886-2) 2298-0488

www.tw.sgs.com

Member of SGS Group

Radar Type 5 for 802.11n40 5510 MHz

Waveform Num =	9
Num of Bursts =	8
Burst Interval (us) =	1500000

Burst #	OffTime (us)	# Pulses	Chirp (MHz)	PW (us)	Pulse1 Pri(us)	Pulse2 Pri(us)	Pulse3 Pri(us)	StartLoc (us)	StartBurst Interval(us)	EndBurst Interval(us)
1	112651	1	12	70	1105	0	0	112651	0	1499999
2	2018938	2	17	55	1228	1348	0	2132694	1500000	2999999
3	2068504	2	19	95	1914	1570	0	4203774	3000000	4499999
4	1453837	3	17	50	1584	1190	1919	5661095	4500000	5999999
5	1445244	1	5	55	1060	0	0	7111032	6000000	7499999
6	430626	2	17	55	1145	1121	0	7542718	7500000	8999999
7	1919177	2	12	75	1794	1581	0	9464161	9000000	10499999
8	1669189	1	13	90	1048	0	0	11136725	10500000	11999999
Total	number	of	pulses	in	waveform	=	14			

Radar Type 5 for 802.11n40 5510 MHz

Waveform Num =	10
Num of Bursts =	19
Burst Interval (us) =	631579

Burst #	OffTime (us)	# Pulses	Chirp (MHz)	PW (us)	Pulse1 Pri(us)	Pulse2 Pri(us)	Pulse3 Pri(us)	StartLoc (us)	StartBurst Interval(us)	EndBurst Interval(us)
1	431790	1	17	50	1639	0	0	431790	0	631578
2	288159	3	16	80	1255	1355	1704	721588	631579	1263157
3	1072040	1	13	75	1652	0	0	1797942	1263158	1894736
4	302037	2	6	55	1049	1184	0	2101631	1894737	2526315
5	891091	3	20	55	1935	1949	1151	2994955	2526316	3157894
6	707145	2	19	65	1502	1946	0	3707135	3157895	3789473
7	320749	3	18	90	1776	1038	1733	4031332	3789474	4421052
8	511517	2	18	55	1625	1447	0	4547396	4421053	5052631
9	1129653	1	13	100	1136	0	0	5680121	5052632	5684210
10	568211	3	9	60	1190	1139	1017	6249468	5684211	6315789
11	85302	2	12	65	1362	1222	0	6338116	6315790	6947368
12	1050085	3	10	50	1700	1889	1373	7390785	6947369	7578947
13	748153	2	5	65	1155	1921	0	8143900	7578948	8210526
14	623430	3	10	100	1093	1708	1602	8770406	8210527	8842105
15	214567	2	16	90	1130	1975	0	8989376	8842106	9473684
16	954338	1	7	85	1908	0	0	9946819	9473685	10105263
17	573484	3	14	80	1636	1527	1432	10522211	10105264	10736842
18	690707	1	17	65	1248	0	0	11217513	10736843	11368421
19	455722	2	13	55	1719	1018	0	11674483	11368422	12000000
Total	number	of	pulses	in	waveform	=	40			

Unless otherwise stated the results shown in this test report refer only to the sample(s) tested and such sample(s) are retained for 90 days only.

除非另有說明，此報告結果僅對測試之樣品負責，同時此樣品僅保留90天。本報告未經本公司書面許可，不可部份複製。

This document is issued by the Company subject to its General Conditions of Service printed overleaf, available on request or accessible at www.sgs.com/terms_and_conditions.htm and, for electronic format documents, subject to Terms and Conditions for Electronic Documents at www.sgs.com/terms_e-document.htm. Attention is drawn to the limitation of liability, indemnification and jurisdiction issues defined therein. Any holder of this document is advised that information contained hereon reflects the Company's findings at the time of its intervention only and within the limits of Client's instructions, if any. The Company's sole responsibility is to its Client and this document does not exonerate parties to a transaction from exercising all their rights and obligations under the transaction documents. This document cannot be reproduced except in full, without prior written approval of the Company. Any unauthorized alteration, forgery or falsification of the content or appearance of this document is unlawful and offenders may be prosecuted to the fullest extent of the law.

SGS Taiwan Ltd.

No.134,WuKungRoad,NewTaipeiIndustrialPark,WukuDistrict,NewTaipeiCity,Taiwan24803/新北市五股區新北產業園區五工路 134 號

台灣檢驗科技股份有限公司

t (886-2) 2299-3279

f (886-2) 2298-0488

www.tw.sgs.com

Member of SGS Group

Radar Type 5 for 802.11n40 5510 MHz

Waveform Num =	11
Num of Bursts =	20
Burst Interval (us) =	600000

Burst #	OffTime (us)	# Pulses	Chirp (MHz)	PW (us)	Pulse1 Pri(us)	Pulse2 Pri(us)	Pulse3 Pri(us)	StartLoc (us)	StartBurst Interval(us)	EndBurst Interval(us)
1	487934	3	7	95	1966	1070	1019	487934	0	599999
2	298429	1	17	50	1266	0	0	790418	600000	1199999
3	826247	1	19	60	1978	0	0	1617931	1200000	1799999
4	691050	3	16	90	1901	1719	1155	2310959	1800000	2399999
5	289304	2	17	65	1565	1200	0	2605038	2400000	2999999
6	626253	1	11	65	1152	0	0	3234056	3000000	3599999
7	893530	1	16	65	1483	0	0	4128738	3600000	4199999
8	666638	2	7	100	1437	1450	0	4796859	4200000	4799999
9	83365	1	15	80	1251	0	0	4883111	4800000	5399999
10	878752	3	8	75	1306	1735	1026	5763114	5400000	5999999
11	676550	3	12	60	1855	1794	1300	6443731	6000000	6599999
12	240880	3	11	65	1441	1537	1379	6689560	6600000	7199999
13	1051333	3	17	65	1505	1162	1115	7745250	7200000	7799999
14	329460	1	6	65	1845	0	0	8078492	7800000	8399999
15	623936	2	15	85	1119	1133	0	8704273	8400000	8999999
16	620457	2	13	50	1239	1009	0	9326982	9000000	9599999
17	288341	1	20	70	1499	0	0	9617571	9600000	10199999
18	635118	2	13	95	1078	1003	0	10254188	10200000	10799999
19	610678	3	5	100	1957	1620	1365	10866947	10800000	11399999
20	1075677	2	18	80	1783	1382	0	11947566	11400000	11999999
Total	number	of	pulses	in	waveform	=	40			

Unless otherwise stated the results shown in this test report refer only to the sample(s) tested and such sample(s) are retained for 90 days only.

除非另有說明，此報告結果僅對測試之樣品負責，同時此樣品僅保留90天。本報告未經本公司書面許可，不可部份複製。

This document is issued by the Company subject to its General Conditions of Service printed overleaf, available on request or accessible at www.sgs.com/terms_and_conditions.htm and, for electronic format documents, subject to Terms and Conditions for Electronic Documents at www.sgs.com/terms_e-document.htm. Attention is drawn to the limitation of liability, indemnification and jurisdiction issues defined therein. Any holder of this document is advised that information contained hereon reflects the Company's findings at the time of its intervention only and within the limits of Client's instructions, if any. The Company's sole responsibility is to its Client and this document does not exonerate parties to a transaction from exercising all their rights and obligations under the transaction documents. This document cannot be reproduced except in full, without prior written approval of the Company. Any unauthorized alteration, forgery or falsification of the content or appearance of this document is unlawful and offenders may be prosecuted to the fullest extent of the law.

SGS Taiwan Ltd.

No.134,WuKungRoad,NewTaipeiIndustrialPark,WukuDistrict,NewTaipeiCity,Taiwan24803/新北市五股區新北產業園區五工路 134 號

台灣檢驗科技股份有限公司

t (886-2) 2299-3279

f (886-2) 2298-0488

www.tw.sgs.com

Member of SGS Group

Radar Type 5 for 802.11n40 5510 MHz

Waveform Num =	12
Num of Bursts =	19
Burst Interval (us) =	631579

Burst #	OffTime (us)	# Pulses	Chirp (MHz)	PW (us)	Pulse1 Pri(us)	Pulse2 Pri(us)	Pulse3 Pri(us)	StartLoc (us)	StartBurst Interval(us)	EndBurst Interval(us)
1	463478	1	15	70	1092	0	0	463478	0	631578
2	379825	3	7	60	1036	1127	1910	844395	631579	1263157
3	426265	3	6	85	1460	1392	1327	1274733	1263158	1894736
4	1188674	2	6	90	1743	1881	0	2467586	1894737	2526315
5	589867	3	9	50	1569	1016	1031	3061077	2526316	3157894
6	349970	3	9	55	1312	1452	1546	3414663	3157895	3789473
7	501145	1	9	95	1488	0	0	3920118	3789474	4421052
8	511673	2	16	70	1323	1148	0	4433279	4421053	5052631
9	952498	1	20	70	1893	0	0	5388248	5052632	5684210
10	615990	2	10	55	1977	1639	0	6006131	5684211	6315789
11	725219	3	7	70	1280	1448	1290	6734966	6315790	6947368
12	638357	1	20	85	1442	0	0	7377341	6947369	7578947
13	688491	1	11	65	1709	0	0	8067274	7578948	8210526
14	557372	1	19	50	1604	0	0	8626355	8210527	8842105
15	648206	1	11	60	1855	0	0	9276165	8842106	9473684
16	457367	1	17	90	1359	0	0	9735387	9473685	10105263
17	958866	3	12	95	1275	1803	1212	10695612	10105264	10736842
18	332487	1	7	50	1858	0	0	11032389	10736843	11368421
19	623586	3	6	65	1212	1197	1159	11657833	11368422	12000000
Total	number	of	pulses	in	waveform	=	36			

Unless otherwise stated the results shown in this test report refer only to the sample(s) tested and such sample(s) are retained for 90 days only.

除非另有說明，此報告結果僅對測試之樣品負責，同時此樣品僅保留90天。本報告未經本公司書面許可，不可部份複製。

This document is issued by the Company subject to its General Conditions of Service printed overleaf, available on request or accessible at www.sgs.com/terms_and_conditions.htm and, for electronic format documents, subject to Terms and Conditions for Electronic Documents at www.sgs.com/terms_e-document.htm. Attention is drawn to the limitation of liability, indemnification and jurisdiction issues defined therein. Any holder of this document is advised that information contained hereon reflects the Company's findings at the time of its intervention only and within the limits of Client's instructions, if any. The Company's sole responsibility is to its Client and this document does not exonerate parties to a transaction from exercising all their rights and obligations under the transaction documents. This document cannot be reproduced except in full, without prior written approval of the Company. Any unauthorized alteration, forgery or falsification of the content or appearance of this document is unlawful and offenders may be prosecuted to the fullest extent of the law.

SGS Taiwan Ltd.

No.134,WuKungRoad,NewTaipeiIndustrialPark,WukuDistrict,NewTaipeiCity,Taiwan24803/新北市五股區新北產業園區五工路 134 號

台灣檢驗科技股份有限公司

t (886-2) 2299-3279

f (886-2) 2298-0488

www.tw.sgs.com

Member of SGS Group

Radar Type 5 for 802.11n40 5510 MHz

Waveform Num =	13
Num of Bursts =	13
Burst Interval (us) =	923077

Burst #	OffTime (us)	# Pulses	Chirp (MHz)	PW (us)	Pulse1 Pri(us)	Pulse2 Pri(us)	Pulse3 Pri(us)	StartLoc (us)	StartBurst Interval(us)	EndBurst Interval(us)
1	669990	1	15	75	1814	0	0	669990	0	923076
2	714932	1	17	90	1935	0	0	1386736	923077	1846153
3	722092	2	13	95	1530	1388	0	2110763	1846154	2769230
4	1117381	2	9	60	1590	1491	0	3231062	2769231	3692307
5	915465	1	17	60	1579	0	0	4149608	3692308	4615384
6	1181851	3	11	55	1342	1878	1471	5333038	4615385	5538461
7	586972	2	13	70	1826	1172	0	5924701	5538462	6461538
8	1055237	1	16	65	1712	0	0	6982936	6461539	7384615
9	592520	2	10	50	1147	1150	0	7577168	7384616	8307692
10	1350650	1	6	55	1144	0	0	8930115	8307693	9230769
11	1002110	3	7	70	1398	1504	1648	9933369	9230770	10153846
12	982962	3	8	85	1406	1836	1399	10920881	10153847	11076923
13	643325	1	18	80	1232	0	0	11568847	11076924	12000000
Total	number	of	pulses	in	waveform	=	23			

Radar Type 5 for 802.11n40 5510 MHz

Waveform Num =	14
Num of Bursts =	17
Burst Interval (us) =	705882

Burst #	OffTime (us)	# Pulses	Chirp (MHz)	PW (us)	Pulse1 Pri(us)	Pulse2 Pri(us)	Pulse3 Pri(us)	StartLoc (us)	StartBurst Interval(us)	EndBurst Interval(us)
1	445033	3	14	95	1853	1438	1832	445033	0	705881
2	708581	3	16	70	1970	1270	1091	1158737	705882	1411763
3	296395	2	16	50	1036	1435	0	1459463	1411764	2117645
4	1336083	2	17	65	1450	1727	0	2798017	2117646	2823527
5	588029	2	20	65	1953	1729	0	3389223	2823528	3529409
6	259748	1	18	75	1182	0	0	3652653	3529410	4235291
7	1108053	2	11	50	1464	1149	0	4761888	4235292	4941173
8	568927	3	15	75	1959	1595	1494	5333428	4941174	5647055
9	656491	2	18	50	1900	1611	0	5994967	5647056	6352937
10	662454	3	14	95	1104	1872	1464	6660932	6352938	7058819
11	743260	3	6	100	1116	1064	1509	7408632	7058820	7764701
12	841839	3	17	80	1116	1185	1346	8254160	7764702	8470583
13	877751	1	17	100	1710	0	0	9135558	8470584	9176465
14	603668	1	19	100	1813	0	0	9740936	9176466	9882347
15	630559	1	8	100	1222	0	0	10373308	9882348	10588229
16	423892	1	17	100	1019	0	0	10798422	10588230	11294111
17	522226	3	7	95	1221	1677	1521	11321667	11294112	11999993
Total	number	of	pulses	in	waveform	=	36			

Unless otherwise stated the results shown in this test report refer only to the sample(s) tested and such sample(s) are retained for 90 days only.

除非另有說明，此報告結果僅對測試之樣品負責，同時此樣品僅保留90天。本報告未經本公司書面許可，不可部份複製。

This document is issued by the Company subject to its General Conditions of Service printed overleaf, available on request or accessible at www.sgs.com/terms_and_conditions.htm and, for electronic format documents, subject to Terms and Conditions for Electronic Documents at www.sgs.com/terms_e-document.htm. Attention is drawn to the limitation of liability, indemnification and jurisdiction issues defined therein. Any holder of this document is advised that information contained hereon reflects the Company's findings at the time of its intervention only and within the limits of Client's instructions, if any. The Company's sole responsibility is to its Client and this document does not exonerate parties to a transaction from exercising all their rights and obligations under the transaction documents. This document cannot be reproduced except in full, without prior written approval of the Company. Any unauthorized alteration, forgery or falsification of the content or appearance of this document is unlawful and offenders may be prosecuted to the fullest extent of the law.

SGS Taiwan Ltd.

No.134,WuKungRoad,NewTaipeiIndustrialPark,WukuDistrict,NewTaipeiCity,Taiwan24803/新北市五股區新北產業園區五工路 134 號

台灣檢驗科技股份有限公司

t (886-2) 2299-3279

f (886-2) 2298-0488

www.tw.sgs.com

Member of SGS Group

Radar Type 5 for 802.11n40 5510 MHz

Waveform Num =	15
Num of Bursts =	12
Burst Interval (us) =	1000000

Burst #	OffTime (us)	# Pulses	Chirp (MHz)	PW (us)	Pulse1 Pri(us)	Pulse2 Pri(us)	Pulse3 Pri(us)	StartLoc (us)	StartBurst Interval(us)	EndBurst Interval(us)
1	388424	2	19	90	1670	1775	0	388424	0	999999
2	1309734	2	13	95	1837	1619	0	1701603	1000000	1999999
3	454980	2	8	100	1485	1716	0	2160039	2000000	2999999
4	1294141	1	11	70	1065	0	0	3457381	3000000	3999999
5	544938	2	15	65	1540	1211	0	4003384	4000000	4999999
6	1138856	2	10	60	1743	1279	0	5144991	5000000	5999999
7	1672897	1	5	80	1282	0	0	6820910	6000000	6999999
8	1120973	2	12	75	1579	1902	0	7943165	7000000	7999999
9	844639	2	19	90	1837	1186	0	8791285	8000000	8999999
10	585672	1	17	65	1827	0	0	9379980	9000000	9999999
11	1380035	2	5	75	1864	1620	0	10761842	10000000	10999999
12	1180133	1	10	85	1778	0	0	11945459	11000000	11999999
Total	number	of	pulses	in	waveform	=	20			

Radar Type 5 for 802.11n40 5510 MHz

Waveform Num =	16
Num of Bursts =	14
Burst Interval (us) =	857143

Burst #	OffTime (us)	# Pulses	Chirp (MHz)	PW (us)	Pulse1 Pri(us)	Pulse2 Pri(us)	Pulse3 Pri(us)	StartLoc (us)	StartBurst Interval(us)	EndBurst Interval(us)
1	801366	2	16	75	1277	1689	0	801366	0	857142
2	310628	2	8	65	1020	1492	0	1114960	857143	1714285
3	607976	2	5	55	1610	1802	0	1725448	1714286	2571428
4	1211445	3	14	65	1665	1752	1697	2940305	2571429	3428571
5	546448	3	19	70	1095	1177	1838	3491867	3428572	4285714
6	1376095	3	9	65	1749	1089	1293	4872072	4285715	5142857
7	719998	2	15	55	1813	1130	0	5596201	5142858	6000000
8	1042271	3	16	50	1372	1954	1935	6641415	6000001	6857143
9	705748	1	14	100	1180	0	0	7352424	6857144	7714286
10	1077330	3	20	60	1904	1997	1648	8430934	7714287	8571429
11	946841	1	16	80	1817	0	0	9383324	8571430	9428572
12	394850	2	14	100	1151	1956	0	9779991	9428573	10285715
13	1189021	2	15	85	1754	1215	0	10972119	10285716	11142858
14	827092	2	11	70	1913	1378	0	11802180	11142859	12000001
Total	number	of	pulses	in	waveform	=	31			

Unless otherwise stated the results shown in this test report refer only to the sample(s) tested and such sample(s) are retained for 90 days only.

除非另有說明，此報告結果僅對測試之樣品負責，同時此樣品僅保留90天。本報告未經本公司書面許可，不可部份複製。

This document is issued by the Company subject to its General Conditions of Service printed overleaf, available on request or accessible at www.sgs.com/terms_and_conditions.htm and, for electronic format documents, subject to Terms and Conditions for Electronic Documents at www.sgs.com/terms_e-document.htm. Attention is drawn to the limitation of liability, indemnification and jurisdiction issues defined therein. Any holder of this document is advised that information contained hereon reflects the Company's findings at the time of its intervention only and within the limits of Client's instructions, if any. The Company's sole responsibility is to its Client and this document does not exonerate parties to a transaction from exercising all their rights and obligations under the transaction documents. This document cannot be reproduced except in full, without prior written approval of the Company. Any unauthorized alteration, forgery or falsification of the content or appearance of this document is unlawful and offenders may be prosecuted to the fullest extent of the law.

SGS Taiwan Ltd.

No.134,WuKungRoad,NewTaipeiIndustrialPark,WukuDistrict,NewTaipeiCity,Taiwan24803/新北市五股區新北產業園區五工路 134 號

台灣檢驗科技股份有限公司

t (886-2) 2299-3279

f (886-2) 2298-0488

www.tw.sgs.com

Member of SGS Group

Radar Type 5 for 802.11n40 5510 MHz

Waveform Num =	17
Num of Bursts =	18
Burst Interval (us) =	666667

Burst #	OffTime (us)	# Pulses	Chirp (MHz)	PW (us)	Pulse1 Pri(us)	Pulse2 Pri(us)	Pulse3 Pri(us)	StartLoc (us)	StartBurst Interval(us)	EndBurst Interval(us)
1	161182	1	7	75	1133	0	0	161182	0	666666
2	648968	2	6	65	1825	1227	0	811283	666667	1333333
3	698776	2	15	75	1785	1341	0	1513111	1333334	2000000
4	734017	1	10	65	1618	0	0	2250254	2000001	2666667
5	481453	3	15	70	1808	1408	1225	2733325	2666668	3333334
6	901173	3	16	65	1867	1973	1872	3638939	3333335	4000001
7	681201	1	18	75	1764	0	0	4325852	4000002	4666668
8	506572	2	13	50	1780	1331	0	4834188	4666669	5333335
9	817664	3	19	50	1169	1373	1871	5654963	5333336	6000002
10	891364	1	9	50	1267	0	0	6550740	6000003	6666669
11	500395	2	9	95	1530	1838	0	7052402	6666670	7333336
12	394677	3	13	55	1913	1138	1713	7450447	7333337	8000003
13	656294	2	9	85	1476	1353	0	8111505	8000004	8666670
14	884172	1	8	60	1141	0	0	8998506	8666671	9333337
15	709695	1	6	100	1272	0	0	9709342	9333338	10000004
16	396610	1	20	85	1749	0	0	10107224	10000005	10666671
17	565720	3	14	85	1541	1126	1883	10674693	10666672	11333338
18	705463	2	9	80	1871	1734	0	11384706	11333339	12000005
Total	number	of	pulses	in	waveform	=	34			

Radar Type 5 for 802.11n40 5510 MHz

Waveform Num =	18
Num of Bursts =	11
Burst Interval (us) =	1090909

Burst #	OffTime (us)	# Pulses	Chirp (MHz)	PW (us)	Pulse1 Pri(us)	Pulse2 Pri(us)	Pulse3 Pri(us)	StartLoc (us)	StartBurst Interval(us)	EndBurst Interval(us)
1	147473	1	16	100	1050	0	0	147473	0	1090908
2	1590502	1	19	100	1404	0	0	1739025	1090909	2181817
3	1071907	3	8	80	1232	1375	1665	2812336	2181818	3272726
4	1028206	3	10	60	1888	1184	1719	3844814	3272727	4363635
5	822161	3	5	80	1030	1430	1027	4671766	4363636	5454544
6	1140607	1	5	65	1155	0	0	5815860	5454545	6545453
7	1471763	3	14	55	1662	1580	1194	7288778	6545454	7636362
8	1194625	3	7	100	1401	1135	1521	8487839	7636363	8727271
9	374146	1	7	85	1953	0	0	8866042	8727272	9818180
10	1696930	1	10	65	1602	0	0	10564925	9818181	10909089
11	590443	1	16	70	1824	0	0	11156970	10909090	11999998
Total	number	of	pulses	in	waveform	=	21			

Unless otherwise stated the results shown in this test report refer only to the sample(s) tested and such sample(s) are retained for 90 days only.

除非另有說明，此報告結果僅對測試之樣品負責，同時此樣品僅保留90天。本報告未經本公司書面許可，不可部份複製。

This document is issued by the Company subject to its General Conditions of Service printed overleaf, available on request or accessible at www.sgs.com/terms_and_conditions.htm and, for electronic format documents, subject to Terms and Conditions for Electronic Documents at www.sgs.com/terms_e-document.htm. Attention is drawn to the limitation of liability, indemnification and jurisdiction issues defined therein. Any holder of this document is advised that information contained hereon reflects the Company's findings at the time of its intervention only and within the limits of Client's instructions, if any. The Company's sole responsibility is to its Client and this document does not exonerate parties to a transaction from exercising all their rights and obligations under the transaction documents. This document cannot be reproduced except in full, without prior written approval of the Company. Any unauthorized alteration, forgery or falsification of the content or appearance of this document is unlawful and offenders may be prosecuted to the fullest extent of the law.

Radar Type 5 for 802.11n40 5510 MHz

Waveform Num =	19
Num of Bursts =	9
Burst Interval (us) =	1333333

Burst #	OffTime (us)	# Pulses	Chirp (MHz)	PW (us)	Pulse1 Pri(us)	Pulse2 Pri(us)	Pulse3 Pri(us)	StartLoc (us)	StartBurst Interval(us)	EndBurst Interval(us)
1	1243734	2	11	100	1905	1738	0	1243734	0	1333332
2	797654	1	6	100	1422	0	0	2045031	1333333	2666665
3	968098	3	9	75	1313	1426	1193	3014551	2666666	3999998
4	1823003	3	16	80	1608	1538	1933	4841486	3999999	5333331
5	1747881	2	14	55	1139	1290	0	6594446	5333332	6666664
6	882857	3	5	80	1425	1483	1091	7479732	6666665	7999997
7	1576962	3	11	50	1771	1560	1580	9060693	7999998	9333330
8	1420788	3	17	70	1883	1146	1365	10486392	9333331	10666663
9	981619	1	16	50	1690	0	0	11472405	10666664	11999996
Total	number	of	pulses	in	waveform	=	21			

Radar Type 5 for 802.11n40 5510 MHz

Waveform Num =	20
Num of Bursts =	9
Burst Interval (us) =	1333333

Burst #	OffTime (us)	# Pulses	Chirp (MHz)	PW (us)	Pulse1 Pri(us)	Pulse2 Pri(us)	Pulse3 Pri(us)	StartLoc (us)	StartBurst Interval(us)	EndBurst Interval(us)
1	1136748	3	10	80	1152	1698	1572	1136748	0	1333332
2	597963	3	15	85	1832	1423	1419	1739133	1333333	2666665
3	1356731	2	9	50	1318	1970	0	3100538	2666666	3999998
4	962616	1	15	70	1083	0	0	4066442	3999999	5333331
5	2507175	1	11	60	1596	0	0	6574700	5333332	6666664
6	951009	1	16	70	1023	0	0	7527305	6666665	7999997
7	1094231	3	15	50	1434	1067	1885	8622559	7999998	9333330
8	980438	1	5	100	1930	0	0	9607383	9333331	10666663
9	1849830	1	19	50	1063	0	0	11459143	10666664	11999996
Total	number	of	pulses	in	waveform	=	16			

Unless otherwise stated the results shown in this test report refer only to the sample(s) tested and such sample(s) are retained for 90 days only.

除非另有說明，此報告結果僅對測試之樣品負責，同時此樣品僅保留90天。本報告未經本公司書面許可，不可部份複製。

This document is issued by the Company subject to its General Conditions of Service printed overleaf, available on request or accessible at www.sgs.com/terms_and_conditions.htm and, for electronic format documents, subject to Terms and Conditions for Electronic Documents at www.sgs.com/terms_e-document.htm. Attention is drawn to the limitation of liability, indemnification and jurisdiction issues defined therein. Any holder of this document is advised that information contained hereon reflects the Company's findings at the time of its intervention only and within the limits of Client's instructions, if any. The Company's sole responsibility is to its Client and this document does not exonerate parties to a transaction from exercising all their rights and obligations under the transaction documents. This document cannot be reproduced except in full, without prior written approval of the Company. Any unauthorized alteration, forgery or falsification of the content or appearance of this document is unlawful and offenders may be prosecuted to the fullest extent of the law.

SGS Taiwan Ltd.

No.134,WuKungRoad,NewTaipeiIndustrialPark,WukuDistrict,NewTaipeiCity,Taiwan24803/新北市五股區新北產業園區五工路 134 號

台灣檢驗科技股份有限公司

t (886-2) 2299-3279

f (886-2) 2298-0488

www.tw.sgs.com

Member of SGS Group

Radar Type 5 for 802.11n40 5510 MHz

Waveform Num =	21
Num of Bursts =	20
Burst Interval (us) =	600000

Burst #	OffTime (us)	# Pulses	Chirp (MHz)	PW (us)	Pulse1 Pri(us)	Pulse2 Pri(us)	Pulse3 Pri(us)	StartLoc (us)	StartBurst Interval(us)	EndBurst Interval(us)
1	490324	2	12	75	1100	1683	0	490324	0	599999
2	228473	2	12	50	1814	1528	0	721580	600000	1199999
3	821625	3	6	75	1423	1180	1675	1546547	1200000	1799999
4	735382	2	10	50	1277	1720	0	2286207	1800000	2399999
5	118805	3	8	50	1437	1945	1404	2408009	2400000	2999999
6	1112756	2	20	85	1337	1317	0	3525551	3000000	3599999
7	518562	2	9	75	1552	1329	0	4046767	3600000	4199999
8	691963	2	5	50	1436	1956	0	4741611	4200000	4799999
9	211403	1	17	100	1257	0	0	4956406	4800000	5399999
10	679081	2	19	75	1482	1358	0	5636744	5400000	5999999
11	752623	3	7	85	1896	1209	1942	6392207	6000000	6599999
12	522360	3	8	90	1071	1421	1906	6919614	6600000	7199999
13	827630	1	6	90	1560	0	0	7751642	7200000	7799999
14	71067	2	19	95	1096	1151	0	7824269	7800000	8399999
15	926487	3	16	70	1416	1607	1304	8753003	8400000	8999999
16	362381	1	13	85	1542	0	0	9119711	9000000	9599999
17	1073751	1	10	85	1329	0	0	10195004	9600000	10199999
18	69109	2	14	95	1056	1210	0	10265442	10200000	10799999
19	1097087	3	11	85	1663	1648	1402	11364795	10800000	11399999
20	579224	1	19	80	1896	0	0	11948732	11400000	11999999
Total	number	of	pulses	in	waveform	=	41			

Unless otherwise stated the results shown in this test report refer only to the sample(s) tested and such sample(s) are retained for 90 days only.

除非另有說明，此報告結果僅對測試之樣品負責，同時此樣品僅保留90天。本報告未經本公司書面許可，不可部份複製。

This document is issued by the Company subject to its General Conditions of Service printed overleaf, available on request or accessible at www.sgs.com/terms_and_conditions.htm and, for electronic format documents, subject to Terms and Conditions for Electronic Documents at www.sgs.com/terms_e-document.htm. Attention is drawn to the limitation of liability, indemnification and jurisdiction issues defined therein. Any holder of this document is advised that information contained hereon reflects the Company's findings at the time of its intervention only and within the limits of Client's instructions, if any. The Company's sole responsibility is to its Client and this document does not exonerate parties to a transaction from exercising all their rights and obligations under the transaction documents. This document cannot be reproduced except in full, without prior written approval of the Company. Any unauthorized alteration, forgery or falsification of the content or appearance of this document is unlawful and offenders may be prosecuted to the fullest extent of the law.

SGS Taiwan Ltd.

No.134,WuKungRoad,NewTaipeiIndustrialPark,WukuDistrict,NewTaipeiCity,Taiwan24803/新北市五股區新北產業園區五工路 134 號

台灣檢驗科技股份有限公司

t (886-2) 2299-3279

f (886-2) 2298-0488

www.tw.sgs.com

Member of SGS Group

Radar Type 5 for 802.11n40 5510 MHz

Waveform Num =	22
Num of Bursts =	18
Burst Interval (us) =	666667

Burst #	OffTime (us)	# Pulses	Chirp (MHz)	PW (us)	Pulse1 Pri(us)	Pulse2 Pri(us)	Pulse3 Pri(us)	StartLoc (us)	StartBurst Interval(us)	EndBurst Interval(us)
1	379706	3	9	50	1523	1550	1935	379706	0	666666
2	431084	3	18	90	1103	1082	1078	815798	666667	1333333
3	1004961	2	14	100	1551	1102	0	1824022	1333334	2000000
4	465782	2	11	90	1912	1424	0	2292457	2000001	2666667
5	792202	3	10	60	1108	1015	1997	3087995	2666668	3333334
6	705137	3	16	100	1153	1727	1387	3797252	3333335	4000001
7	216007	2	12	70	1246	1700	0	4017526	4000002	4666668
8	714928	1	18	65	1270	0	0	4735400	4666669	5333335
9	981299	1	12	80	1114	0	0	5717969	5333336	6000002
10	937454	3	12	95	1629	1076	1326	6656537	6000003	6666669
11	141767	1	16	90	1825	0	0	6802335	6666670	7333336
12	620014	2	20	50	1298	1728	0	7424174	7333337	8000003
13	1029519	1	13	55	1605	0	0	8456719	8000004	8666670
14	640267	2	13	95	1637	1436	0	9098591	8666671	9333337
15	609322	1	14	95	1472	0	0	9710986	9333338	10000004
16	945532	3	10	100	1711	1714	1389	10657990	10000005	10666671
17	310660	1	13	95	1561	0	0	10973464	10666672	11333338
18	469666	1	13	60	1031	0	0	11444691	11333339	12000005
Total	number	of	pulses	in	waveform	=	35			

Unless otherwise stated the results shown in this test report refer only to the sample(s) tested and such sample(s) are retained for 90 days only.

除非另有說明，此報告結果僅對測試之樣品負責，同時此樣品僅保留90天。本報告未經本公司書面許可，不可部份複製。

This document is issued by the Company subject to its General Conditions of Service printed overleaf, available on request or accessible at www.sgs.com/terms_and_conditions.htm and, for electronic format documents, subject to Terms and Conditions for Electronic Documents at www.sgs.com/terms_e-document.htm. Attention is drawn to the limitation of liability, indemnification and jurisdiction issues defined therein. Any holder of this document is advised that information contained hereon reflects the Company's findings at the time of its intervention only and within the limits of Client's instructions, if any. The Company's sole responsibility is to its Client and this document does not exonerate parties to a transaction from exercising all their rights and obligations under the transaction documents. This document cannot be reproduced except in full, without prior written approval of the Company. Any unauthorized alteration, forgery or falsification of the content or appearance of this document is unlawful and offenders may be prosecuted to the fullest extent of the law.

SGS Taiwan Ltd.

No.134,WuKungRoad,NewTaipeiIndustrialPark,WukuDistrict,NewTaipeiCity,Taiwan24803/新北市五股區新北產業園區五工路 134 號

台灣檢驗科技股份有限公司

t (886-2) 2299-3279

f (886-2) 2298-0488

www.tw.sgs.com

Member of SGS Group

Radar Type 5 for 802.11n40 5510 MHz

Waveform Num =	23
Num of Bursts =	20
Burst Interval (us) =	600000

Burst #	OffTime (us)	# Pulses	Chirp (MHz)	PW (us)	Pulse1 Pri(us)	Pulse2 Pri(us)	Pulse3 Pri(us)	StartLoc (us)	StartBurst Interval(us)	EndBurst Interval(us)
1	310129	1	16	50	1342	0	0	310129	0	599999
2	836948	2	7	85	1343	1854	0	1148419	600000	1199999
3	399957	2	17	65	1643	1021	0	1551573	1200000	1799999
4	539610	3	5	65	1231	1184	1694	2093847	1800000	2399999
5	563252	3	15	95	1541	1630	1546	2661208	2400000	2999999
6	442533	1	19	70	1656	0	0	3108458	3000000	3599999
7	785145	3	12	60	1749	1282	1516	3895259	3600000	4199999
8	751933	3	6	50	1257	1017	1087	4651739	4200000	4799999
9	662664	1	12	60	1972	0	0	5317764	4800000	5399999
10	330648	2	20	95	1529	1846	0	5650384	5400000	5999999
11	804354	1	8	95	1373	0	0	6458113	6000000	6599999
12	283553	3	6	50	1650	1816	1570	6743039	6600000	7199999
13	922471	2	17	90	1060	1175	0	7670546	7200000	7799999
14	549772	2	10	90	1761	1199	0	8222553	7800000	8399999
15	320051	2	14	90	1823	1080	0	8545564	8400000	8999999
16	911074	2	17	55	1539	1148	0	9459541	9000000	9599999
17	163056	2	16	55	1174	1377	0	9625284	9600000	10199999
18	883933	2	14	60	1340	1779	0	10511768	10200000	10799999
19	678604	1	11	50	1732	0	0	11193491	10800000	11399999
20	269100	1	13	75	1497	0	0	11464323	11400000	11999999
Total	number	of	pulses	in	waveform	=	39			

Unless otherwise stated the results shown in this test report refer only to the sample(s) tested and such sample(s) are retained for 90 days only.

除非另有說明，此報告結果僅對測試之樣品負責，同時此樣品僅保留90天。本報告未經本公司書面許可，不可部份複製。

This document is issued by the Company subject to its General Conditions of Service printed overleaf, available on request or accessible at www.sgs.com/terms_and_conditions.htm and, for electronic format documents, subject to Terms and Conditions for Electronic Documents at www.sgs.com/terms_e-document.htm. Attention is drawn to the limitation of liability, indemnification and jurisdiction issues defined therein. Any holder of this document is advised that information contained hereon reflects the Company's findings at the time of its intervention only and within the limits of Client's instructions, if any. The Company's sole responsibility is to its Client and this document does not exonerate parties to a transaction from exercising all their rights and obligations under the transaction documents. This document cannot be reproduced except in full, without prior written approval of the Company. Any unauthorized alteration, forgery or falsification of the content or appearance of this document is unlawful and offenders may be prosecuted to the fullest extent of the law.

Radar Type 5 for 802.11n40 5510 MHz

Waveform Num =	24
Num of Bursts =	15
Burst Interval (us) =	800000

Burst #	OffTime (us)	# Pulses	Chirp (MHz)	PW (us)	Pulse1 Pri(us)	Pulse2 Pri(us)	Pulse3 Pri(us)	StartLoc (us)	StartBurst Interval(us)	EndBurst Interval(us)
1	391380	3	13	75	1679	1801	1280	391380	0	799999
2	1037221	2	5	65	1876	1346	0	1433361	800000	1599999
3	652633	3	19	90	1425	1365	1111	2089216	1600000	2399999
4	793035	2	9	85	1453	1960	0	2886152	2400000	3199999
5	387319	2	13	70	1319	1391	0	3276884	3200000	3999999
6	1087553	3	14	60	1691	1220	1656	4367147	4000000	4799999
7	826630	1	12	65	1406	0	0	5198344	4800000	5599999
8	551476	1	14	75	1250	0	0	5751226	5600000	6399999
9	1308011	2	6	100	1758	1455	0	7060487	6400000	7199999
10	327492	3	14	65	1542	1808	1030	7391192	7200000	7999999
11	930471	1	7	70	1621	0	0	8326043	8000000	8799999
12	930405	2	11	100	1895	1814	0	9258069	8800000	9599999
13	408960	3	12	65	1539	1220	1708	9670738	9600000	10399999
14	1266385	1	13	100	1046	0	0	10941590	10400000	11199999
15	483748	3	5	55	1041	1694	1089	11426384	11200000	11999999
Total	number	of	pulses	in	waveform	=	32			

Radar Type 5 for 802.11n40 5510 MHz

Waveform Num =	25
Num of Bursts =	17
Burst Interval (us) =	705882

Burst #	OffTime (us)	# Pulses	Chirp (MHz)	PW (us)	Pulse1 Pri(us)	Pulse2 Pri(us)	Pulse3 Pri(us)	StartLoc (us)	StartBurst Interval(us)	EndBurst Interval(us)
1	203734	2	6	90	1698	1760	0	203734	0	705881
2	998158	3	16	100	1129	1494	1381	1205350	705882	1411763
3	266318	3	6	95	1812	1450	1310	1475672	1411764	2117645
4	668712	2	16	100	1381	1650	0	2148956	2117646	2823527
5	1050135	3	19	85	1460	1465	1828	3202122	2823528	3529409
6	695424	1	10	65	1910	0	0	3902299	3529410	4235291
7	734760	1	9	80	1924	0	0	4638969	4235292	4941173
8	690726	3	17	65	1533	1038	1663	5331619	4941174	5647055
9	547420	1	19	70	1587	0	0	5883273	5647056	6352937
10	710323	3	11	55	1938	1434	1396	6595183	6352938	7058819
11	747428	2	6	65	1073	1823	0	7347379	7058820	7764701
12	1006574	1	20	50	1104	0	0	8356849	7764702	8470583
13	481367	2	18	90	1151	1864	0	8839320	8470584	9176465
14	1027563	3	20	75	1435	1816	1133	9869898	9176466	9882347
15	562313	2	16	95	1536	1649	0	10436595	9882348	10588229
16	706624	3	9	75	1390	1247	1883	11146404	10588230	11294111
17	187173	1	5	60	1663	0	0	11338097	11294112	11999993
Total	number	of	pulses	in	waveform	=	36			

Unless otherwise stated the results shown in this test report refer only to the sample(s) tested and such sample(s) are retained for 90 days only.

除非另有說明，此報告結果僅對測試之樣品負責，同時此樣品僅保留90天。本報告未經本公司書面許可，不可部份複製。

This document is issued by the Company subject to its General Conditions of Service printed overleaf, available on request or accessible at www.sgs.com/terms_and_conditions.htm and, for electronic format documents, subject to Terms and Conditions for Electronic Documents at www.sgs.com/terms_e-document.htm. Attention is drawn to the limitation of liability, indemnification and jurisdiction issues defined therein. Any holder of this document is advised that information contained hereon reflects the Company's findings at the time of its intervention only and within the limits of Client's instructions, if any. The Company's sole responsibility is to its Client and this document does not exonerate parties to a transaction from exercising all their rights and obligations under the transaction documents. This document cannot be reproduced except in full, without prior written approval of the Company. Any unauthorized alteration, forgery or falsification of the content or appearance of this document is unlawful and offenders may be prosecuted to the fullest extent of the law.

Radar Type 5 for 802.11n40 5510 MHz

Waveform Num =	26
Num of Bursts =	14
Burst Interval (us) =	857143

Burst #	OffTime (us)	# Pulses	Chirp (MHz)	PW (us)	Pulse1 Pri(us)	Pulse2 Pri(us)	Pulse3 Pri(us)	StartLoc (us)	StartBurst Interval(us)	EndBurst Interval(us)
1	294886	3	17	80	1924	1487	1838	294886	0	857142
2	718102	1	10	85	1937	0	0	1018237	857143	1714285
3	1200021	2	11	75	1149	1647	0	2220195	1714286	2571428
4	768625	1	10	75	1115	0	0	2991616	2571429	3428571
5	1127694	3	8	80	1380	1315	1820	4120425	3428572	4285714
6	795168	1	18	65	1501	0	0	4920108	4285715	5142857
7	540583	2	5	65	1038	1194	0	5462192	5142858	6000000
8	601315	1	15	100	1292	0	0	6065739	6000001	6857143
9	1219981	1	13	85	1798	0	0	7287012	6857144	7714286
10	595082	1	14	60	1100	0	0	7883892	7714287	8571429
11	879244	3	18	100	1627	1576	1474	8764236	8571430	9428572
12	1371651	2	20	50	1716	1726	0	10140564	9428573	10285715
13	767492	2	5	80	1731	1282	0	10911498	10285716	11142858
14	605465	1	13	75	1697	0	0	11519976	11142859	12000001
Total	number	of	pulses	in	waveform	=	24			

Radar Type 5 for 802.11n40 5510 MHz

Waveform Num =	27
Num of Bursts =	9
Burst Interval (us) =	1333333

Burst #	OffTime (us)	# Pulses	Chirp (MHz)	PW (us)	Pulse1 Pri(us)	Pulse2 Pri(us)	Pulse3 Pri(us)	StartLoc (us)	StartBurst Interval(us)	EndBurst Interval(us)
1	117724	3	20	85	1678	1939	1025	117724	0	1333332
2	2518291	1	18	100	1544	0	0	2640657	1333333	2666665
3	563521	3	16	90	1069	1231	1493	3205722	2666666	3999998
4	900116	3	18	95	1872	1627	1713	4109631	3999999	5333331
5	2130023	1	8	50	1233	0	0	6244866	5333332	6666664
6	1143740	1	14	60	1511	0	0	7389839	6666665	7999997
7	1275182	1	14	60	1358	0	0	8666532	7999998	9333330
8	1462112	3	17	75	1764	1485	1402	10130002	9333331	10666663
9	1220494	2	12	50	1719	1961	0	11355147	10666664	11999996
Total	number	of	pulses	in	waveform	=	18			

Unless otherwise stated the results shown in this test report refer only to the sample(s) tested and such sample(s) are retained for 90 days only.

除非另有說明，此報告結果僅對測試之樣品負責，同時此樣品僅保留90天。本報告未經本公司書面許可，不可部份複製。

This document is issued by the Company subject to its General Conditions of Service printed overleaf, available on request or accessible at www.sgs.com/terms_and_conditions.htm and, for electronic format documents, subject to Terms and Conditions for Electronic Documents at www.sgs.com/terms_e-document.htm. Attention is drawn to the limitation of liability, indemnification and jurisdiction issues defined therein. Any holder of this document is advised that information contained hereon reflects the Company's findings at the time of its intervention only and within the limits of Client's instructions, if any. The Company's sole responsibility is to its Client and this document does not exonerate parties to a transaction from exercising all their rights and obligations under the transaction documents. This document cannot be reproduced except in full, without prior written approval of the Company. Any unauthorized alteration, forgery or falsification of the content or appearance of this document is unlawful and offenders may be prosecuted to the fullest extent of the law.

SGS Taiwan Ltd.

No.134,WuKungRoad,NewTaipeiIndustrialPark,WukuDistrict,NewTaipeiCity,Taiwan24803/新北市五股區新北產業園區五工路 134 號

台灣檢驗科技股份有限公司

t (886-2) 2299-3279

f (886-2) 2298-0488

www.tw.sgs.com

Member of SGS Group

Radar Type 5 for 802.11n40 5510 MHz

Waveform Num =	28
Num of Bursts =	12
Burst Interval (us) =	1000000

Burst #	OffTime (us)	# Pulses	Chirp (MHz)	PW (us)	Pulse1 Pri(us)	Pulse2 Pri(us)	Pulse3 Pri(us)	StartLoc (us)	StartBurst Interval(us)	EndBurst Interval(us)
1	486429	1	18	65	1439	0	0	486429	0	999999
2	1098585	3	16	85	1714	1022	1942	1586453	1000000	1999999
3	502070	2	5	100	1565	1690	0	2093201	2000000	2999999
4	979564	1	16	95	1281	0	0	3076020	3000000	3999999
5	1257935	1	12	55	1522	0	0	4335236	4000000	4999999
6	1169736	3	13	60	1554	1834	1333	5506494	5000000	5999999
7	1222561	3	7	70	1158	1617	1255	6733776	6000000	6999999
8	783336	3	6	100	1335	1952	1965	7521142	7000000	7999999
9	661182	2	10	75	1132	1312	0	8187576	8000000	8999999
10	1778853	1	7	75	1032	0	0	9968873	9000000	9999999
11	791489	2	8	80	1707	1031	0	10761394	10000000	10999999
12	888144	1	8	75	1515	0	0	11652276	11000000	11999999
Total	number	of	pulses	in	waveform	=	23			

Radar Type 5 for 802.11n40 5510 MHz

Waveform Num =	29
Num of Bursts =	14
Burst Interval (us) =	857143

Burst #	OffTime (us)	# Pulses	Chirp (MHz)	PW (us)	Pulse1 Pri(us)	Pulse2 Pri(us)	Pulse3 Pri(us)	StartLoc (us)	StartBurst Interval(us)	EndBurst Interval(us)
1	567226	1	8	60	1060	0	0	567226	0	857142
2	687054	3	15	80	1464	1150	1990	1255340	857143	1714285
3	717678	3	17	95	1093	1943	1629	1977622	1714286	2571428
4	849868	3	20	95	1750	1031	1506	2832155	2571429	3428571
5	1381530	3	20	100	1822	1097	1023	4217972	3428572	4285714
6	247208	2	5	90	1201	1965	0	4469122	4285715	5142857
7	1323708	2	9	50	1227	1147	0	5795996	5142858	6000000
8	610867	3	15	70	1549	2000	1631	6409237	6000001	6857143
9	461494	2	8	85	1444	1935	0	6875911	6857144	7714286
10	1457311	2	11	70	1473	1671	0	8336601	7714287	8571429
11	324901	2	10	85	1267	1811	0	8664646	8571430	9428572
12	811297	3	9	90	1246	1688	1407	9479021	9428573	10285715
13	1569650	3	14	80	1862	1500	1809	11053012	10285716	11142858
14	860305	2	8	100	1932	1390	0	11918488	11142859	12000001
Total	number	of	pulses	in	waveform	=	34			

Unless otherwise stated the results shown in this test report refer only to the sample(s) tested and such sample(s) are retained for 90 days only.

除非另有說明，此報告結果僅對測試之樣品負責，同時此樣品僅保留90天。本報告未經本公司書面許可，不可部份複製。

This document is issued by the Company subject to its General Conditions of Service printed overleaf, available on request or accessible at www.sgs.com/terms_and_conditions.htm and, for electronic format documents, subject to Terms and Conditions for Electronic Documents at www.sgs.com/terms_e-document.htm. Attention is drawn to the limitation of liability, indemnification and jurisdiction issues defined therein. Any holder of this document is advised that information contained hereon reflects the Company's findings at the time of its intervention only and within the limits of Client's instructions, if any. The Company's sole responsibility is to its Client and this document does not exonerate parties to a transaction from exercising all their rights and obligations under the transaction documents. This document cannot be reproduced except in full, without prior written approval of the Company. Any unauthorized alteration, forgery or falsification of the content or appearance of this document is unlawful and offenders may be prosecuted to the fullest extent of the law.

SGS Taiwan Ltd.

No.134,WuKungRoad,NewTaipeiIndustrialPark,WukuDistrict,NewTaipeiCity,Taiwan24803/新北市五股區新北產業園區五工路 134 號

台灣檢驗科技股份有限公司

t (886-2) 2299-3279

f (886-2) 2298-0488

www.tw.sgs.com

Member of SGS Group

Radar Type 5 for 802.11n40 5510 MHz

Waveform Num =	30
Num of Bursts =	20
Burst Interval (us) =	600000

Burst #	OffTime (us)	# Pulses	Chirp (MHz)	PW (us)	Pulse1 Pri(us)	Pulse2 Pri(us)	Pulse3 Pri(us)	StartLoc (us)	StartBurst Interval(us)	EndBurst Interval(us)
1	477324	3	20	85	1917	1036	1605	477324	0	599999
2	401180	2	5	60	1412	1325	0	883062	600000	1199999
3	536492	3	8	90	1790	1938	1772	1422291	1200000	1799999
4	628653	2	5	80	1036	1594	0	2056444	1800000	2399999
5	545107	1	14	95	1984	0	0	2604181	2400000	2999999
6	872119	1	14	90	1563	0	0	3478284	3000000	3599999
7	609805	3	9	55	1255	1108	1368	4089652	3600000	4199999
8	174456	3	13	50	1192	1710	1385	4267839	4200000	4799999
9	533905	2	9	85	1262	1888	0	4806031	4800000	5399999
10	736797	3	8	50	1400	1250	1459	5545978	5400000	5999999
11	574690	2	15	85	1696	1193	0	6124777	6000000	6599999
12	775984	1	11	75	1278	0	0	6903650	6600000	7199999
13	720759	2	15	55	1006	1237	0	7625687	7200000	7799999
14	540929	3	13	70	1107	1499	1107	8168859	7800000	8399999
15	640404	1	8	95	1950	0	0	8812976	8400000	8999999
16	230164	2	15	55	1114	1286	0	9045090	9000000	9599999
17	752405	2	19	50	1990	1576	0	9799895	9600000	10199999
18	540601	3	7	85	1976	1842	1740	10344062	10200000	10799999
19	814160	1	16	90	1276	0	0	11163780	10800000	11399999
20	675440	2	14	85	1331	1934	0	11840496	11400000	11999999
Total	number	of	pulses	in	waveform	=	42			

Unless otherwise stated the results shown in this test report refer only to the sample(s) tested and such sample(s) are retained for 90 days only.

除非另有說明，此報告結果僅對測試之樣品負責，同時此樣品僅保留90天。本報告未經本公司書面許可，不可部份複製。

This document is issued by the Company subject to its General Conditions of Service printed overleaf, available on request or accessible at www.sgs.com/terms_and_conditions.htm and, for electronic format documents, subject to Terms and Conditions for Electronic Documents at www.sgs.com/terms_e-document.htm. Attention is drawn to the limitation of liability, indemnification and jurisdiction issues defined therein. Any holder of this document is advised that information contained hereon reflects the Company's findings at the time of its intervention only and within the limits of Client's instructions, if any. The Company's sole responsibility is to its Client and this document does not exonerate parties to a transaction from exercising all their rights and obligations under the transaction documents. This document cannot be reproduced except in full, without prior written approval of the Company. Any unauthorized alteration, forgery or falsification of the content or appearance of this document is unlawful and offenders may be prosecuted to the fullest extent of the law.

SGS Taiwan Ltd.

No.134,WuKungRoad,NewTaipeiIndustrialPark,WukuDistrict,NewTaipeiCity,Taiwan24803/新北市五股區新北產業園區五工路 134 號

台灣檢驗科技股份有限公司

t (886-2) 2299-3279

f (886-2) 2298-0488

www.tw.sgs.com

Member of SGS Group

802.11ac80 5290 MHz:

FCC13-22 Radar Test Summary

Short Pulse Radar Type	Minimum Number of Trials	Detection(%)	Minimum Percentage of Successful Detection(%)	Pass/Fail
1	30	100.00	60	Pass
2	30	93.33	60	Pass
3	30	83.33	60	Pass
4	30	83.33	60	Pass
Aggregate (Radar Types 1-4)	120	90.00	80	Pass
Long Pulse Radar Test Waveform	Minimum Number of Trials	Detection	Minimum Percentage of Successful Detection(Limit)	Pass/Fail
5 - Variable	30	100.00	80	Pass
Frequency Hopping Radar Test Waveform	Minimum Number of Trials	Detection	Minimum Percentage of Successful Detection(Limit)	Pass/Fail
6	30	96.66	70	Pass

Unless otherwise stated the results shown in this test report refer only to the sample(s) tested and such sample(s) are retained for 90 days only.

除非另有說明，此報告結果僅對測試之樣品負責，同時此樣品僅保留90天。本報告未經本公司書面許可，不可部份複製。

This document is issued by the Company subject to its General Conditions of Service printed overleaf, available on request or accessible at www.sgs.com/terms_and_conditions.htm and, for electronic format documents, subject to Terms and Conditions for Electronic Documents at www.sgs.com/terms_e-document.htm. Attention is drawn to the limitation of liability, indemnification and jurisdiction issues defined therein. Any holder of this document is advised that information contained hereon reflects the Company's findings at the time of its intervention only and within the limits of Client's instructions, if any. The Company's sole responsibility is to its Client and this document does not exonerate parties to a transaction from exercising all their rights and obligations under the transaction documents. This document cannot be reproduced except in full, without prior written approval of the Company. Any unauthorized alteration, forgery or falsification of the content or appearance of this document is unlawful and offenders may be prosecuted to the fullest extent of the law.

SGS Taiwan Ltd.

No.134,WuKungRoad,NewTaipeiIndustrialPark,WukuDistrict,NewTaipeiCity,Taiwan24803/新北市五股區新北產業園區五工路 134 號

台灣檢驗科技股份有限公司

t (886-2) 2299-3279

f (886-2) 2298-0488

www.tw.sgs.com

Member of SGS Group

Radar Type 1 for 802.11ac80 5290 MHz:

Data Sheet for FCC Variable Radar Type 1				
1 us Pulse Width, PRI Test A&Test B				
Trial	PRI	Pulses Per Burst	Test	Successful Detection

Unless otherwise stated the results shown in this test report refer only to the sample(s) tested and such sample(s) are retained for 90 days only.

除非另有說明，此報告結果僅對測試之樣品負責，同時此樣品僅保留90天。本報告未經本公司書面許可，不可部份複製。

This document is issued by the Company subject to its General Conditions of Service printed overleaf, available on request or accessible at www.sgs.com/terms_and_conditions.htm and, for electronic format documents, subject to Terms and Conditions for Electronic Documents at www.sgs.com/terms_e-document.htm. Attention is drawn to the limitation of liability, indemnification and jurisdiction issues defined therein. Any holder of this document is advised that information contained hereon reflects the Company's findings at the time of its intervention only and within the limits of Client's instructions, if any. The Company's sole responsibility is to its Client and this document does not exonerate parties to a transaction from exercising all their rights and obligations under the transaction documents. This document cannot be reproduced except in full, without prior written approval of the Company. Any unauthorized alteration, forgery or falsification of the content or appearance of this document is unlawful and offenders may be prosecuted to the fullest extent of the law.

SGS Taiwan Ltd.

No.134,WuKungRoad,NewTaipeiIndustrialPark,WukuDistrict,NewTaipeiCity,Taiwan24803/新北市五股區新北產業園區五工路 134 號

台灣檢驗科技股份有限公司

t (886-2) 2299-3279

f (886-2) 2298-0488

www.tw.sgs.com

Member of SGS Group

Radar Type 2 for 802.11ac80 5290 MHz:

Data Sheet for FCC Variable Radar Type 2				
1-5 us Pulse Width, PRI 150-230 us, 23-29 Pulses per Burst				
Trial	Pulse Width	PRI	Pulses Per Burst	Successful Detection

Unless otherwise stated the results shown in this test report refer only to the sample(s) tested and such sample(s) are retained for 90 days only.

除非另有說明，此報告結果僅對測試之樣品負責，同時此樣品僅保留90天。本報告未經本公司書面許可，不可部份複製。

This document is issued by the Company subject to its General Conditions of Service printed overleaf, available on request or accessible at www.sgs.com/terms_and_conditions.htm and, for electronic format documents, subject to Terms and Conditions for Electronic Documents at www.sgs.com/terms_e-document.htm. Attention is drawn to the limitation of liability, indemnification and jurisdiction issues defined therein. Any holder of this document is advised that information contained hereon reflects the Company's findings at the time of its intervention only and within the limits of Client's instructions, if any. The Company's sole responsibility is to its Client and this document does not exonerate parties to a transaction from exercising all their rights and obligations under the transaction documents. This document cannot be reproduced except in full, without prior written approval of the Company. Any unauthorized alteration, forgery or falsification of the content or appearance of this document is unlawful and offenders may be prosecuted to the fullest extent of the law.

SGS Taiwan Ltd.

No.134,WuKungRoad,NewTaipeiIndustrialPark,WukuDistrict,NewTaipeiCity,Taiwan24803/新北市五股區新北產業園區五工路 134 號

台灣檢驗科技股份有限公司

t (886-2) 2299-3279

f (886-2) 2298-0488

www.tw.sgs.com

Member of SGS Group

Radar Type 3 for 802.11ac80 5290 MHz:

Data Sheet for FCC Variable Radar Type 3				
6-10 us Pulse Width, PRI 200-500 us, 16-18 Pulses per Burst				
Trial	Pulse Width	PRI	Pulses Per Burst	Successful Detection

Unless otherwise stated the results shown in this test report refer only to the sample(s) tested and such sample(s) are retained for 90 days only.

除非另有說明，此報告結果僅對測試之樣品負責，同時此樣品僅保留90天。本報告未經本公司書面許可，不可部份複製。

This document is issued by the Company subject to its General Conditions of Service printed overleaf, available on request or accessible at www.sgs.com/terms_and_conditions.htm and, for electronic format documents, subject to Terms and Conditions for Electronic Documents at www.sgs.com/terms_e-document.htm. Attention is drawn to the limitation of liability, indemnification and jurisdiction issues defined therein. Any holder of this document is advised that information contained hereon reflects the Company's findings at the time of its intervention only and within the limits of Client's instructions, if any. The Company's sole responsibility is to its Client and this document does not exonerate parties to a transaction from exercising all their rights and obligations under the transaction documents. This document cannot be reproduced except in full, without prior written approval of the Company. Any unauthorized alteration, forgery or falsification of the content or appearance of this document is unlawful and offenders may be prosecuted to the fullest extent of the law.

SGS Taiwan Ltd.

No.134,WuKungRoad,NewTaipeiIndustrialPark,WukuDistrict,NewTaipeiCity,Taiwan24803/新北市五股區新北產業園區五工路 134 號

台灣檢驗科技股份有限公司

t (886-2) 2299-3279

f (886-2) 2298-0488

www.tw.sgs.com

Member of SGS Group

Radar Type 4 for 802.11ac80 5290 MHz:

Data Sheet for FCC Variable Radar Type 4				
11-20 us Pulse Width, PRI 200-500 us, 12-16 Pulses per Burst				
Trial	Pulse Width	PRI	Pulses Per Burst	Successful Detection

Unless otherwise stated the results shown in this test report refer only to the sample(s) tested and such sample(s) are retained for 90 days only.

除非另有說明，此報告結果僅對測試之樣品負責，同時此樣品僅保留90天。本報告未經本公司書面許可，不可部份複製。

This document is issued by the Company subject to its General Conditions of Service printed overleaf, available on request or accessible at www.sgs.com/terms_and_conditions.htm and, for electronic format documents, subject to Terms and Conditions for Electronic Documents at www.sgs.com/terms_e-document.htm. Attention is drawn to the limitation of liability, indemnification and jurisdiction issues defined therein. Any holder of this document is advised that information contained hereon reflects the Company's findings at the time of its intervention only and within the limits of Client's instructions, if any. The Company's sole responsibility is to its Client and this document does not exonerate parties to a transaction from exercising all their rights and obligations under the transaction documents. This document cannot be reproduced except in full, without prior written approval of the Company. Any unauthorized alteration, forgery or falsification of the content or appearance of this document is unlawful and offenders may be prosecuted to the fullest extent of the law.

SGS Taiwan Ltd.

No.134,WuKungRoad,NewTaipeiIndustrialPark,WukuDistrict,NewTaipeiCity,Taiwan24803/新北市五股區新北產業園區五工路 134 號

台灣檢驗科技股份有限公司

t (886-2) 2299-3279

f (886-2) 2298-0488

www.tw.sgs.com

Member of SGS Group

Radar Type 5 for 802.11ac80 5290 MHz

Waveform Num =	1
Num of Bursts =	8
Burst Interval (us) =	1500000

Burst #	OffTime (us)	# Pulses	Chirp (MHz)	PW (us)	Pulse1 Pri(us)	Pulse2 Pri(us)	Pulse3 Pri(us)	StartLoc (us)	StartBurst Interval(us)	EndBurst Interval(us)
1	1283609	3	17	70	1214	1336	1249	1283609	0	1499999
2	1290146	2	8	55	1412	1053	0	2577554	1500000	2999999
3	1686469	3	5	100	1826	1536	1484	4266488	3000000	4499999
4	1038336	3	15	55	1246	1862	1055	5309670	4500000	5999999
5	1039992	1	20	50	1935	0	0	6353825	6000000	7499999
6	1283361	1	17	50	1655	0	0	7639121	7500000	8999999
7	2829729	3	6	75	1491	1970	1392	10470505	9000000	10499999
8	1386886	1	19	80	1845	0	0	11862244	10500000	11999999
Total	number	of	pulses	in	waveform	=	17			

Radar Type 5 for 802.11ac80 5290 MHz

Waveform Num =	2
Num of Bursts =	9
Burst Interval (us) =	1333333

Burst #	OffTime (us)	# Pulses	Chirp (MHz)	PW (us)	Pulse1 Pri(us)	Pulse2 Pri(us)	Pulse3 Pri(us)	StartLoc (us)	StartBurst Interval(us)	EndBurst Interval(us)
1	984346	2	17	80	1916	1974	0	984346	0	1333332
2	383513	1	20	55	1574	0	0	1371749	1333333	2666665
3	2426729	2	13	55	1797	1184	0	3800052	2666666	3999998
4	754081	3	18	55	1170	1474	1125	4557114	3999999	5333331
5	2047726	3	11	80	1811	1929	1448	6608609	5333332	6666664
6	1297722	1	14	90	1585	0	0	7911519	6666665	7999997
7	398407	2	10	95	1201	1671	0	8311511	7999998	9333330
8	2058812	1	15	100	1672	0	0	10373195	9333331	10666663
9	710323	1	18	85	1845	0	0	11085190	10666664	11999996
Total	number	of	pulses	in	waveform	=	16			

Unless otherwise stated the results shown in this test report refer only to the sample(s) tested and such sample(s) are retained for 90 days only.

除非另有說明，此報告結果僅對測試之樣品負責，同時此樣品僅保留90天。本報告未經本公司書面許可，不可部份複製。

This document is issued by the Company subject to its General Conditions of Service printed overleaf, available on request or accessible at www.sgs.com/terms_and_conditions.htm and, for electronic format documents, subject to Terms and Conditions for Electronic Documents at www.sgs.com/terms_e-document.htm. Attention is drawn to the limitation of liability, indemnification and jurisdiction issues defined therein. Any holder of this document is advised that information contained hereon reflects the Company's findings at the time of its intervention only and within the limits of Client's instructions, if any. The Company's sole responsibility is to its Client and this document does not exonerate parties to a transaction from exercising all their rights and obligations under the transaction documents. This document cannot be reproduced except in full, without prior written approval of the Company. Any unauthorized alteration, forgery or falsification of the content or appearance of this document is unlawful and offenders may be prosecuted to the fullest extent of the law.

SGS Taiwan Ltd.

No.134,WuKungRoad,NewTaipeiIndustrialPark,WukuDistrict,NewTaipeiCity,Taiwan24803/新北市五股區新北產業園區五工路 134 號

台灣檢驗科技股份有限公司

t (886-2) 2299-3279

f (886-2) 2298-0488

www.tw.sgs.com

Member of SGS Group

Radar Type 5 for 802.11ac80 5290 MHz

Waveform Num =	3
Num of Bursts =	12
Burst Interval (us) =	1000000

Burst #	OffTime (us)	# Pulses	Chirp (MHz)	PW (us)	Pulse1 Pri(us)	Pulse2 Pri(us)	Pulse3 Pri(us)	StartLoc (us)	StartBurst Interval(us)	EndBurst Interval(us)
1	976888	3	15	90	1022	1801	1751	976888	0	999999
2	998316	1	6	65	1007	0	0	1979778	1000000	1999999
3	929767	2	16	65	1930	1205	0	2910552	2000000	2999999
4	394214	1	16	90	1727	0	0	3307901	3000000	3999999
5	1589366	2	15	95	1080	1823	0	4898994	4000000	4999999
6	280705	2	12	85	1395	1617	0	5182602	5000000	5999999
7	1761931	3	13	80	1909	1733	1743	6947545	6000000	6999999
8	411045	2	10	90	1741	1891	0	7363975	7000000	7999999
9	963036	2	13	80	1046	1501	0	8330643	8000000	8999999
10	1267614	1	16	55	1522	0	0	9600804	9000000	9999999
11	1192959	3	8	80	1686	1748	1163	10795285	10000000	10999999
12	1018289	1	10	60	1937	0	0	11818171	11000000	11999999
Total	number	of	pulses	in	waveform	=	23			

Radar Type 5 for 802.11ac80 5290 MHz

Waveform Num =	4
Num of Bursts =	19
Burst Interval (us) =	631579

Burst #	OffTime (us)	# Pulses	Chirp (MHz)	PW (us)	Pulse1 Pri(us)	Pulse2 Pri(us)	Pulse3 Pri(us)	StartLoc (us)	StartBurst Interval(us)	EndBurst Interval(us)
1	627406	2	12	80	1411	1280	0	627406	0	631578
2	447129	1	15	80	1035	0	0	1077226	631579	1263157
3	539140	1	7	60	1787	0	0	1617401	1263158	1894736
4	712147	2	7	65	1971	1324	0	2331335	1894737	2526315
5	520057	3	19	80	1142	1914	1992	2854687	2526316	3157894
6	394711	3	16	70	1081	1922	1301	3254446	3157895	3789473
7	763427	2	15	50	1805	1503	0	4022177	3789474	4421052
8	472575	1	12	95	1463	0	0	4498060	4421053	5052631
9	993279	1	8	95	1247	0	0	5492802	5052632	5684210
10	382760	3	11	60	1248	1912	1926	5876809	5684211	6315789
11	503926	2	12	95	1717	1563	0	6385821	6315790	6947368
12	991213	2	7	80	1005	1012	0	7380314	6947369	7578947
13	413746	1	15	60	1502	0	0	7796077	7578948	8210526
14	565777	1	7	70	1964	0	0	8363356	8210527	8842105
15	797467	1	10	50	1534	0	0	9162787	8842106	9473684
16	719002	3	7	95	1098	1785	1163	9883323	9473685	10105263
17	392650	2	12	90	1332	1551	0	10280019	10105264	10736842
18	978172	2	19	65	1865	1472	0	11261074	10736843	11368421
19	266252	2	9	85	1272	1435	0	11530663	11368422	12000000
Total	number	of	pulses	in	waveform	=	35			

Unless otherwise stated the results shown in this test report refer only to the sample(s) tested and such sample(s) are retained for 90 days only.

除非另有說明，此報告結果僅對測試之樣品負責，同時此樣品僅保留90天。本報告未經本公司書面許可，不可部份複製。

This document is issued by the Company subject to its General Conditions of Service printed overleaf, available on request or accessible at www.sgs.com/terms_and_conditions.htm and, for electronic format documents, subject to Terms and Conditions for Electronic Documents at www.sgs.com/terms_e-document.htm. Attention is drawn to the limitation of liability, indemnification and jurisdiction issues defined therein. Any holder of this document is advised that information contained hereon reflects the Company's findings at the time of its intervention only and within the limits of Client's instructions, if any. The Company's sole responsibility is to its Client and this document does not exonerate parties to a transaction from exercising all their rights and obligations under the transaction documents. This document cannot be reproduced except in full, without prior written approval of the Company. Any unauthorized alteration, forgery or falsification of the content or appearance of this document is unlawful and offenders may be prosecuted to the fullest extent of the law.

SGS Taiwan Ltd.

No.134,WuKungRoad,NewTaipeiIndustrialPark,WukuDistrict,NewTaipeiCity,Taiwan24803/新北市五股區新北產業園區五工路 134 號

台灣檢驗科技股份有限公司

t (886-2) 2299-3279

f (886-2) 2298-0488

www.tw.sgs.com

Member of SGS Group

Radar Type 5 for 802.11ac80 5290 MHz

Waveform Num =	5
Num of Bursts =	20
Burst Interval (us) =	600000

Burst #	OffTime (us)	# Pulses	Chirp (MHz)	PW (us)	Pulse1 Pri(us)	Pulse2 Pri(us)	Pulse3 Pri(us)	StartLoc (us)	StartBurst Interval(us)	EndBurst Interval(us)
1	131447	1	14	60	1789	0	0	131447	0	599999
2	505841	3	15	50	1233	1955	1422	639077	600000	1199999
3	1123459	1	6	60	1314	0	0	1767146	1200000	1799999
4	595090	2	19	65	1992	1690	0	2363550	1800000	2399999
5	526822	1	8	80	1702	0	0	2894054	2400000	2999999
6	640303	1	16	60	1842	0	0	3536059	3000000	3599999
7	337651	1	5	80	1291	0	0	3875552	3600000	4199999
8	634134	2	5	60	1726	1690	0	4510977	4200000	4799999
9	653248	1	19	95	1384	0	0	5167641	4800000	5399999
10	483519	3	15	60	1137	1151	1860	5652544	5400000	5999999
11	647378	3	15	80	1437	1122	1149	6304070	6000000	6599999
12	462197	1	17	95	1264	0	0	6769975	6600000	7199999
13	1021567	3	20	50	1937	1874	1900	7792806	7200000	7799999
14	92947	1	16	65	1698	0	0	7891464	7800000	8399999
15	691049	2	6	70	1800	1802	0	8584211	8400000	8999999
16	748994	3	13	70	1179	1543	1321	9336807	9000000	9599999
17	767084	2	8	65	1703	1930	0	10107934	9600000	10199999
18	382718	1	19	95	1379	0	0	10494285	10200000	10799999
19	380905	3	13	60	1110	1466	1030	10876569	10800000	11399999
20	603455	2	6	50	1839	1198	0	11483630	11400000	11999999
Total	number	of	pulses	in	waveform	=	37			

Radar Type 5 for 802.11ac80 5290 MHz

Waveform Num =	6
Num of Bursts =	9
Burst Interval (us) =	1333333

Burst #	OffTime (us)	# Pulses	Chirp (MHz)	PW (us)	Pulse1 Pri(us)	Pulse2 Pri(us)	Pulse3 Pri(us)	StartLoc (us)	StartBurst Interval(us)	EndBurst Interval(us)
1	1080589	2	15	55	1551	1570	0	1080589	0	1333332
2	1375973	2	9	80	1497	1124	0	2459683	1333333	2666665
3	882577	2	16	70	1040	1845	0	3344881	2666666	3999998
4	1877505	2	7	50	1370	1594	0	5225271	3999999	5333331
5	388095	2	11	85	1439	1754	0	5616330	5333332	6666664
6	2286460	3	13	85	1585	1870	1082	7905983	6666665	7999997
7	674265	3	18	55	1434	1954	1008	8584785	7999998	9333330
8	2030190	1	12	80	1225	0	0	10619371	9333331	10666663
9	465580	1	15	65	1167	0	0	11086176	10666664	11999996
Total	number	of	pulses	in	waveform	=	18			

Unless otherwise stated the results shown in this test report refer only to the sample(s) tested and such sample(s) are retained for 90 days only.

除非另有說明，此報告結果僅對測試之樣品負責，同時此樣品僅保留90天。本報告未經本公司書面許可，不可部份複製。

This document is issued by the Company subject to its General Conditions of Service printed overleaf, available on request or accessible at www.sgs.com/terms_and_conditions.htm and, for electronic format documents, subject to Terms and Conditions for Electronic Documents at www.sgs.com/terms_e-document.htm. Attention is drawn to the limitation of liability, indemnification and jurisdiction issues defined therein. Any holder of this document is advised that information contained hereon reflects the Company's findings at the time of its intervention only and within the limits of Client's instructions, if any. The Company's sole responsibility is to its Client and this document does not exonerate parties to a transaction from exercising all their rights and obligations under the transaction documents. This document cannot be reproduced except in full, without prior written approval of the Company. Any unauthorized alteration, forgery or falsification of the content or appearance of this document is unlawful and offenders may be prosecuted to the fullest extent of the law.

SGS Taiwan Ltd.

No.134,WuKungRoad,NewTaipeiIndustrialPark,WukuDistrict,NewTaipeiCity,Taiwan24803/新北市五股區新北產業園區五工路 134 號

台灣檢驗科技股份有限公司

t (886-2) 2299-3279

f (886-2) 2298-0488

www.tw.sgs.com

Member of SGS Group

Radar Type 5 for 802.11ac80 5290 MHz

Waveform Num =	7
Num of Bursts =	13
Burst Interval (us) =	923077

Burst #	OffTime (us)	# Pulses	Chirp (MHz)	PW (us)	Pulse1 Pri(us)	Pulse2 Pri(us)	Pulse3 Pri(us)	StartLoc (us)	StartBurst Interval(us)	EndBurst Interval(us)
1	634384	1	13	85	1893	0	0	634384	0	923076
2	740806	2	20	90	1038	1016	0	1377083	923077	1846153
3	807936	1	20	55	1691	0	0	2187073	1846154	2769230
4	724323	2	19	85	1419	1137	0	2913087	2769231	3692307
5	1429355	2	10	75	1634	1285	0	4344998	3692308	4615384
6	723996	3	11	50	1509	1541	1679	5071913	4615385	5538461
7	1035328	2	11	85	1340	1940	0	6111970	5538462	6461538
8	800024	3	12	50	1071	1311	1681	6915274	6461539	7384615
9	1238479	3	16	80	1448	1796	1949	8157816	7384616	8307692
10	512088	1	20	75	1244	0	0	8675097	8307693	9230769
11	1409579	3	17	85	1219	1247	1048	10085920	9230770	10153846
12	580429	2	5	55	1689	1427	0	10669863	10153847	11076923
13	1167194	3	6	65	1728	1049	1351	11840173	11076924	12000000
Total	number	of	pulses	in	waveform	=	28			

Radar Type 5 for 802.11ac80 5290 MHz

Waveform Num =	8
Num of Bursts =	8
Burst Interval (us) =	1500000

Burst #	OffTime (us)	# Pulses	Chirp (MHz)	PW (us)	Pulse1 Pri(us)	Pulse2 Pri(us)	Pulse3 Pri(us)	StartLoc (us)	StartBurst Interval(us)	EndBurst Interval(us)
1	1381456	1	17	95	1670	0	0	1381456	0	1499999
2	1358699	1	17	70	1361	0	0	2741825	1500000	2999999
3	984178	3	15	60	1167	1476	1456	3727364	3000000	4499999
4	1484851	2	16	100	1489	1000	0	5216314	4500000	5999999
5	1992365	2	5	95	1059	1819	0	7211168	6000000	7499999
6	701517	3	9	75	1260	1590	1747	7915563	7500000	8999999
7	1264579	2	5	80	1810	1922	0	9184739	9000000	10499999
8	2713478	1	19	100	1087	0	0	11901949	10500000	11999999
Total	number	of	pulses	in	waveform	=	15			

Unless otherwise stated the results shown in this test report refer only to the sample(s) tested and such sample(s) are retained for 90 days only.

除非另有說明，此報告結果僅對測試之樣品負責，同時此樣品僅保留90天。本報告未經本公司書面許可，不可部份複製。

This document is issued by the Company subject to its General Conditions of Service printed overleaf, available on request or accessible at www.sgs.com/terms_and_conditions.htm and, for electronic format documents, subject to Terms and Conditions for Electronic Documents at www.sgs.com/terms_e-document.htm. Attention is drawn to the limitation of liability, indemnification and jurisdiction issues defined therein. Any holder of this document is advised that information contained hereon reflects the Company's findings at the time of its intervention only and within the limits of Client's instructions, if any. The Company's sole responsibility is to its Client and this document does not exonerate parties to a transaction from exercising all their rights and obligations under the transaction documents. This document cannot be reproduced except in full, without prior written approval of the Company. Any unauthorized alteration, forgery or falsification of the content or appearance of this document is unlawful and offenders may be prosecuted to the fullest extent of the law.

SGS Taiwan Ltd.

No.134,WuKungRoad,NewTaipeiIndustrialPark,WukuDistrict,NewTaipeiCity,Taiwan24803/新北市五股區新北產業園區五工路 134 號

台灣檢驗科技股份有限公司

t (886-2) 2299-3279

f (886-2) 2298-0488

www.tw.sgs.com

Member of SGS Group

Radar Type 5 for 802.11ac80 5290 MHz

Waveform Num =	9
Num of Bursts =	19
Burst Interval (us) =	631579

Burst #	OffTime (us)	# Pulses	Chirp (MHz)	PW (us)	Pulse1 Pri(us)	Pulse2 Pri(us)	Pulse3 Pri(us)	StartLoc (us)	StartBurst Interval(us)	EndBurst Interval(us)
1	147108	3	18	75	1295	1243	1577	147108	0	631578
2	578107	3	14	50	1875	1194	1214	729330	631579	1263157
3	749505	2	10	95	1179	1685	0	1483118	1263158	1894736
4	753901	2	14	100	1303	1445	0	2239883	1894737	2526315
5	872531	3	15	100	1647	1682	1905	3115162	2526316	3157894
6	654694	2	8	95	1708	1755	0	3775090	3157895	3789473
7	234918	2	11	95	1234	1299	0	4013471	3789474	4421052
8	605704	2	20	85	1778	1885	0	4621708	4421053	5052631
9	667561	1	16	75	1037	0	0	5292932	5052632	5684210
10	609822	2	8	70	1205	1332	0	5903791	5684211	6315789
11	699596	1	19	70	1703	0	0	6605924	6315790	6947368
12	361106	3	16	75	1155	1510	1554	6968733	6947369	7578947
13	746868	3	14	55	1881	1781	1209	7719820	7578948	8210526
14	939428	1	10	55	1995	0	0	8664119	8210527	8842105
15	803276	2	8	65	1064	1665	0	9469390	8842106	9473684
16	433255	1	12	95	1397	0	0	9905374	9473685	10105263
17	764500	3	19	85	1184	1219	1908	10671271	10105264	10736842
18	677703	2	9	85	1140	1491	0	11353285	10736843	11368421
19	272234	1	13	80	1939	0	0	11628150	11368422	12000000
Total	number	of	pulses	in	waveform	=	39			

Unless otherwise stated the results shown in this test report refer only to the sample(s) tested and such sample(s) are retained for 90 days only.

除非另有說明，此報告結果僅對測試之樣品負責，同時此樣品僅保留90天。本報告未經本公司書面許可，不可部份複製。

This document is issued by the Company subject to its General Conditions of Service printed overleaf, available on request or accessible at www.sgs.com/terms_and_conditions.htm and, for electronic format documents, subject to Terms and Conditions for Electronic Documents at www.sgs.com/terms_e-document.htm. Attention is drawn to the limitation of liability, indemnification and jurisdiction issues defined therein. Any holder of this document is advised that information contained hereon reflects the Company's findings at the time of its intervention only and within the limits of Client's instructions, if any. The Company's sole responsibility is to its Client and this document does not exonerate parties to a transaction from exercising all their rights and obligations under the transaction documents. This document cannot be reproduced except in full, without prior written approval of the Company. Any unauthorized alteration, forgery or falsification of the content or appearance of this document is unlawful and offenders may be prosecuted to the fullest extent of the law.

SGS Taiwan Ltd.

No.134,WuKungRoad,NewTaipeiIndustrialPark,WukuDistrict,NewTaipeiCity,Taiwan24803/新北市五股區新北產業園區五工路 134 號

台灣檢驗科技股份有限公司

t (886-2) 2299-3279

f (886-2) 2298-0488

www.tw.sgs.com

Member of SGS Group

Radar Type 5 for 802.11ac80 5290 MHz

Waveform Num =	10
Num of Bursts =	17
Burst Interval (us) =	705882

Burst #	OffTime (us)	# Pulses	Chirp (MHz)	PW (us)	Pulse1 Pri(us)	Pulse2 Pri(us)	Pulse3 Pri(us)	StartLoc (us)	StartBurst Interval(us)	EndBurst Interval(us)
1	566228	3	20	60	1760	1048	1815	566228	0	705881
2	690321	2	15	95	1574	1759	0	1261172	705882	1411763
3	229409	3	9	75	1102	1428	1391	1493914	1411764	2117645
4	978176	3	8	100	1320	1112	1644	2476011	2117646	2823527
5	1025637	3	7	100	1810	1966	1672	3505724	2823528	3529409
6	319190	3	14	70	1989	1600	1071	3830362	3529410	4235291
7	545889	3	15	55	1945	1700	1927	4380911	4235292	4941173
8	961134	1	17	80	1702	0	0	5347617	4941174	5647055
9	744687	1	20	70	1326	0	0	6094006	5647056	6352937
10	695644	2	9	100	1824	1839	0	6790976	6352938	7058819
11	930426	2	9	100	1061	1240	0	7725065	7058820	7764701
12	290938	1	9	90	1648	0	0	8018304	7764702	8470583
13	549901	3	10	55	1004	1842	1663	8569853	8470584	9176465
14	747425	1	15	80	1808	0	0	9321787	9176466	9882347
15	737852	1	6	65	1972	0	0	10061447	9882348	10588229
16	617029	1	16	55	1741	0	0	10680448	10588230	11294111
17	943473	1	9	80	1975	0	0	11625662	11294112	11999993
Total	number	of	pulses	in	waveform	=	34			

Radar Type 5 for 802.11ac80 5290 MHz

Waveform Num =	11
Num of Bursts =	11
Burst Interval (us) =	1090909

Burst #	OffTime (us)	# Pulses	Chirp (MHz)	PW (us)	Pulse1 Pri(us)	Pulse2 Pri(us)	Pulse3 Pri(us)	StartLoc (us)	StartBurst Interval(us)	EndBurst Interval(us)
1	232405	3	16	95	1016	1961	1598	232405	0	1090908
2	1115242	3	10	50	1543	1476	1581	1352222	1090909	2181817
3	1900885	1	10	55	1512	0	0	3257707	2181818	3272726
4	414508	3	18	85	1326	1164	1151	3673727	3272727	4363635
5	1524470	1	18	50	1748	0	0	5201838	4363636	5454544
6	1236664	3	20	70	1924	1053	1186	6440250	5454545	6545453
7	1174367	1	13	55	1643	0	0	7618780	6545454	7636362
8	223834	1	10	60	1549	0	0	7844257	7636363	8727271
9	1369800	2	15	100	1789	1493	0	9215606	8727272	9818180
10	666784	1	16	50	1202	0	0	9885672	9818181	10909089
11	1775419	3	15	100	1333	1402	1157	11662293	10909090	11999998
Total	number	of	pulses	in	waveform	=	22			

Unless otherwise stated the results shown in this test report refer only to the sample(s) tested and such sample(s) are retained for 90 days only.

除非另有說明，此報告結果僅對測試之樣品負責，同時此樣品僅保留90天。本報告未經本公司書面許可，不可部份複製。

This document is issued by the Company subject to its General Conditions of Service printed overleaf, available on request or accessible at www.sgs.com/terms_and_conditions.htm and, for electronic format documents, subject to Terms and Conditions for Electronic Documents at www.sgs.com/terms_e-document.htm. Attention is drawn to the limitation of liability, indemnification and jurisdiction issues defined therein. Any holder of this document is advised that information contained hereon reflects the Company's findings at the time of its intervention only and within the limits of Client's instructions, if any. The Company's sole responsibility is to its Client and this document does not exonerate parties to a transaction from exercising all their rights and obligations under the transaction documents. This document cannot be reproduced except in full, without prior written approval of the Company. Any unauthorized alteration, forgery or falsification of the content or appearance of this document is unlawful and offenders may be prosecuted to the fullest extent of the law.

Radar Type 5 for 802.11ac80 5290 MHz

Waveform Num =	12
Num of Bursts =	13
Burst Interval (us) =	923077

Burst #	OffTime (us)	# Pulses	Chirp (MHz)	PW (us)	Pulse1 Pri(us)	Pulse2 Pri(us)	Pulse3 Pri(us)	StartLoc (us)	StartBurst Interval(us)	EndBurst Interval(us)
1	424341	1	7	80	1608	0	0	424341	0	923076
2	1273247	3	14	75	1387	1630	1739	1699196	923077	1846153
3	171742	2	12	85	1916	1925	0	1875694	1846154	2769230
4	1803562	3	8	70	1664	1163	1736	3683097	2769231	3692307
5	67063	3	16	60	1361	1070	1582	3754723	3692308	4615384
6	1333408	3	17	50	1804	1251	1330	5092144	4615385	5538461
7	939313	2	13	80	1711	1533	0	6035842	5538462	6461538
8	546182	2	8	55	1583	1020	0	6585268	6461539	7384615
9	1066851	2	16	85	1050	1022	0	7654722	7384616	8307692
10	695237	2	8	70	1784	1358	0	8352031	8307693	9230769
11	1726268	3	18	75	1757	1510	1759	10081441	9230770	10153846
12	804490	2	7	90	1523	1906	0	10890957	10153847	11076923
13	399585	1	9	95	1459	0	0	11293971	11076924	12000000
Total	number	of	pulses	in	waveform	=	29			

Radar Type 5 for 802.11ac80 5290 MHz

Waveform Num =	13
Num of Bursts =	10
Burst Interval (us) =	1200000

Burst #	OffTime (us)	# Pulses	Chirp (MHz)	PW (us)	Pulse1 Pri(us)	Pulse2 Pri(us)	Pulse3 Pri(us)	StartLoc (us)	StartBurst Interval(us)	EndBurst Interval(us)
1	680133	3	10	75	1957	1118	1374	680133	0	1199999
2	1392504	2	15	60	1054	1339	0	2077086	1200000	2399999
3	1068945	3	9	60	1307	1509	1810	3148424	2400000	3599999
4	1530820	3	17	90	1722	1907	1010	4683870	3600000	4799999
5	271015	1	19	70	1682	0	0	4959524	4800000	5999999
6	1114505	2	18	75	1711	1371	0	6075711	6000000	7199999
7	1227713	1	17	90	1972	0	0	7306506	7200000	8399999
8	1980395	1	16	65	1004	0	0	9288873	8400000	9599999
9	1161875	1	15	70	1341	0	0	10451752	9600000	10799999
10	1164800	2	9	60	1006	1065	0	11617893	10800000	11999999
Total	number	of	pulses	in	waveform	=	19			

Unless otherwise stated the results shown in this test report refer only to the sample(s) tested and such sample(s) are retained for 90 days only.

除非另有說明，此報告結果僅對測試之樣品負責，同時此樣品僅保留90天。本報告未經本公司書面許可，不可部份複製。

This document is issued by the Company subject to its General Conditions of Service printed overleaf, available on request or accessible at www.sgs.com/terms_and_conditions.htm and, for electronic format documents, subject to Terms and Conditions for Electronic Documents at www.sgs.com/terms_e-document.htm. Attention is drawn to the limitation of liability, indemnification and jurisdiction issues defined therein. Any holder of this document is advised that information contained hereon reflects the Company's findings at the time of its intervention only and within the limits of Client's instructions, if any. The Company's sole responsibility is to its Client and this document does not exonerate parties to a transaction from exercising all their rights and obligations under the transaction documents. This document cannot be reproduced except in full, without prior written approval of the Company. Any unauthorized alteration, forgery or falsification of the content or appearance of this document is unlawful and offenders may be prosecuted to the fullest extent of the law.

SGS Taiwan Ltd.

No.134,WuKungRoad,NewTaipeiIndustrialPark,WukuDistrict,NewTaipeiCity,Taiwan24803/新北市五股區新北產業園區五工路 134 號

台灣檢驗科技股份有限公司

t (886-2) 2299-3279

f (886-2) 2298-0488

www.tw.sgs.com

Member of SGS Group

Radar Type 5 for 802.11ac80 5290 MHz

Waveform Num =	14
Num of Bursts =	10
Burst Interval (us) =	1200000

Burst #	OffTime (us)	# Pulses	Chirp (MHz)	PW (us)	Pulse1 Pri(us)	Pulse2 Pri(us)	Pulse3 Pri(us)	StartLoc (us)	StartBurst Interval(us)	EndBurst Interval(us)
1	134656	2	19	90	1181	1783	0	134656	0	1199999
2	1368620	3	14	100	1455	1393	1869	1506240	1200000	2399999
3	1924670	2	9	70	1863	1125	0	3435627	2400000	3599999
4	736857	2	16	80	1665	1048	0	4175472	3600000	4799999
5	852724	2	9	55	1576	1458	0	5030909	4800000	5999999
6	1528939	1	18	90	1629	0	0	6562882	6000000	7199999
7	644611	1	5	55	1928	0	0	7209122	7200000	8399999
8	2247096	1	5	75	1733	0	0	9458146	8400000	9599999
9	645835	1	8	95	1263	0	0	10105714	9600000	10799999
10	1155613	3	8	95	1265	1367	1167	11262590	10800000	11999999
Total	number	of	pulses	in	waveform	=	18			

Radar Type 5 for 802.11ac80 5290 MHz

Waveform Num =	15
Num of Bursts =	18
Burst Interval (us) =	666667

Burst #	OffTime (us)	# Pulses	Chirp (MHz)	PW (us)	Pulse1 Pri(us)	Pulse2 Pri(us)	Pulse3 Pri(us)	StartLoc (us)	StartBurst Interval(us)	EndBurst Interval(us)
1	506218	1	20	75	1771	0	0	506218	0	666666
2	582025	3	18	75	1163	1217	1673	1090014	666667	1333333
3	381158	1	19	75	1389	0	0	1475225	1333334	2000000
4	1021396	1	15	55	1909	0	0	2498010	2000001	2666667
5	190374	2	13	100	1073	1655	0	2690293	2666668	3333334
6	1106593	3	16	95	1211	1978	1240	3799614	3333335	4000001
7	262735	3	17	95	1826	1441	1739	4066778	4000002	4666668
8	616927	1	14	90	1572	0	0	4688711	4666669	5333335
9	1231264	2	17	70	1313	1477	0	5921547	5333336	6000002
10	485127	2	10	80	1414	1850	0	6409464	6000003	6666669
11	845664	1	18	55	1098	0	0	7258392	6666670	7333336
12	721223	1	12	75	1405	0	0	7980713	7333337	8000003
13	207208	3	17	80	1019	1121	1542	8189326	8000004	8666670
14	623092	2	10	75	1033	1580	0	8816100	8666671	9333337
15	759259	2	18	50	1243	1304	0	9577972	9333338	10000004
16	1022399	3	20	90	1079	1314	1159	10602918	10000005	10666671
17	260998	3	8	100	1521	1419	1364	10867468	10666672	11333338
18	804822	1	6	75	1686	0	0	11676594	11333339	12000005
Total	number	of	pulses	in	waveform	=	35			

Unless otherwise stated the results shown in this test report refer only to the sample(s) tested and such sample(s) are retained for 90 days only.

除非另有說明，此報告結果僅對測試之樣品負責，同時此樣品僅保留90天。本報告未經本公司書面許可，不可部份複製。

This document is issued by the Company subject to its General Conditions of Service printed overleaf, available on request or accessible at www.sgs.com/terms_and_conditions.htm and, for electronic format documents, subject to Terms and Conditions for Electronic Documents at www.sgs.com/terms_e-document.htm. Attention is drawn to the limitation of liability, indemnification and jurisdiction issues defined therein. Any holder of this document is advised that information contained hereon reflects the Company's findings at the time of its intervention only and within the limits of Client's instructions, if any. The Company's sole responsibility is to its Client and this document does not exonerate parties to a transaction from exercising all their rights and obligations under the transaction documents. This document cannot be reproduced except in full, without prior written approval of the Company. Any unauthorized alteration, forgery or falsification of the content or appearance of this document is unlawful and offenders may be prosecuted to the fullest extent of the law.

SGS Taiwan Ltd.

No.134,WuKungRoad,NewTaipeiIndustrialPark,WukuDistrict,NewTaipeiCity,Taiwan24803/新北市五股區新北產業園區五工路 134 號

台灣檢驗科技股份有限公司

t (886-2) 2299-3279

f (886-2) 2298-0488

www.tw.sgs.com

Member of SGS Group

Radar Type 5 for 802.11ac80 5290 MHz

Waveform Num =	16
Num of Bursts =	15
Burst Interval (us) =	800000

Burst #	OffTime (us)	# Pulses	Chirp (MHz)	PW (us)	Pulse1 Pri(us)	Pulse2 Pri(us)	Pulse3 Pri(us)	StartLoc (us)	StartBurst Interval(us)	EndBurst Interval(us)
1	562791	1	16	90	1422	0	0	562791	0	799999
2	950322	3	16	100	1460	1291	1310	1514535	800000	1599999
3	592986	2	14	50	1778	1852	0	2111582	1600000	2399999
4	965243	1	5	70	1091	0	0	3080455	2400000	3199999
5	630976	1	16	55	1964	0	0	3712522	3200000	3999999
6	648033	1	20	100	1211	0	0	4362519	4000000	4799999
7	626621	1	18	80	1843	0	0	4990351	4800000	5599999
8	821636	3	11	95	1787	1083	1800	5813830	5600000	6399999
9	710286	3	18	65	1593	1313	1484	6528786	6400000	7199999
10	1426528	3	14	70	1089	1980	1571	7959704	7200000	7999999
11	152174	2	7	50	1895	1813	0	8116518	8000000	8799999
12	782709	2	20	100	1035	1582	0	8902935	8800000	9599999
13	838102	1	16	100	1113	0	0	9743654	9600000	10399999
14	1050704	3	14	70	1643	1244	1499	10795471	10400000	11199999
15	1013753	2	11	95	1942	1553	0	11813610	11200000	11999999
Total	number	of	pulses	in	waveform	=	29			

Unless otherwise stated the results shown in this test report refer only to the sample(s) tested and such sample(s) are retained for 90 days only.

除非另有說明，此報告結果僅對測試之樣品負責，同時此樣品僅保留90天。本報告未經本公司書面許可，不可部份複製。

This document is issued by the Company subject to its General Conditions of Service printed overleaf, available on request or accessible at www.sgs.com/terms_and_conditions.htm and, for electronic format documents, subject to Terms and Conditions for Electronic Documents at www.sgs.com/terms_e-document.htm. Attention is drawn to the limitation of liability, indemnification and jurisdiction issues defined therein. Any holder of this document is advised that information contained hereon reflects the Company's findings at the time of its intervention only and within the limits of Client's instructions, if any. The Company's sole responsibility is to its Client and this document does not exonerate parties to a transaction from exercising all their rights and obligations under the transaction documents. This document cannot be reproduced except in full, without prior written approval of the Company. Any unauthorized alteration, forgery or falsification of the content or appearance of this document is unlawful and offenders may be prosecuted to the fullest extent of the law.

SGS Taiwan Ltd.

No.134,WuKungRoad,NewTaipeiIndustrialPark,WukuDistrict,NewTaipeiCity,Taiwan24803/新北市五股區新北產業園區五工路 134 號

台灣檢驗科技股份有限公司

t (886-2) 2299-3279

f (886-2) 2298-0488

www.tw.sgs.com

Member of SGS Group

Radar Type 5 for 802.11ac80 5290 MHz

Waveform Num =	17
Num of Bursts =	19
Burst Interval (us) =	631579

Burst #	OffTime (us)	# Pulses	Chirp (MHz)	PW (us)	Pulse1 Pri(us)	Pulse2 Pri(us)	Pulse3 Pri(us)	StartLoc (us)	StartBurst Interval(us)	EndBurst Interval(us)
1	257513	1	18	95	1069	0	0	257513	0	631578
2	397249	2	6	65	1049	1639	0	655831	631579	1263157
3	938165	1	11	65	1804	0	0	1596684	1263158	1894736
4	827107	3	19	60	1899	1224	1201	2425595	1894737	2526315
5	353606	3	18	95	1387	1037	1230	2783525	2526316	3157894
6	585993	1	10	95	1307	0	0	3373172	3157895	3789473
7	720292	3	8	60	1173	1052	1820	4094771	3789474	4421052
8	630657	1	13	85	1279	0	0	4729473	4421053	5052631
9	611553	3	20	65	1078	1010	1680	5342305	5052632	5684210
10	575647	1	12	50	1069	0	0	5921720	5684211	6315789
11	823281	1	18	50	1908	0	0	6746070	6315790	6947368
12	362348	3	15	75	1645	1265	1237	7110326	6947369	7578947
13	963251	1	20	70	1150	0	0	8077724	7578948	8210526
14	670757	3	20	65	1960	1759	1188	8749631	8210527	8842105
15	271083	2	17	100	1027	1859	0	9025621	8842106	9473684
16	1019140	2	9	85	1190	1656	0	10047647	9473685	10105263
17	284459	3	16	50	1789	1325	1389	10334952	10105264	10736842
18	573514	2	9	95	1439	1962	0	10912969	10736843	11368421
19	856525	2	20	60	1906	1430	0	11772895	11368422	12000000
Total	number	of	pulses	in	waveform	=	38			

Unless otherwise stated the results shown in this test report refer only to the sample(s) tested and such sample(s) are retained for 90 days only.

除非另有說明，此報告結果僅對測試之樣品負責，同時此樣品僅保留90天。本報告未經本公司書面許可，不可部份複製。

This document is issued by the Company subject to its General Conditions of Service printed overleaf, available on request or accessible at www.sgs.com/terms_and_conditions.htm and, for electronic format documents, subject to Terms and Conditions for Electronic Documents at www.sgs.com/terms_e-document.htm. Attention is drawn to the limitation of liability, indemnification and jurisdiction issues defined therein. Any holder of this document is advised that information contained hereon reflects the Company's findings at the time of its intervention only and within the limits of Client's instructions, if any. The Company's sole responsibility is to its Client and this document does not exonerate parties to a transaction from exercising all their rights and obligations under the transaction documents. This document cannot be reproduced except in full, without prior written approval of the Company. Any unauthorized alteration, forgery or falsification of the content or appearance of this document is unlawful and offenders may be prosecuted to the fullest extent of the law.

SGS Taiwan Ltd.

No.134,WuKungRoad,NewTaipeiIndustrialPark,WukuDistrict,NewTaipeiCity,Taiwan24803/新北市五股區新北產業園區五工路 134 號

台灣檢驗科技股份有限公司

t (886-2) 2299-3279

f (886-2) 2298-0488

www.tw.sgs.com

Member of SGS Group

Radar Type 5 for 802.11ac80 5290 MHz

Waveform Num =	18
Num of Bursts =	15
Burst Interval (us) =	800000

Burst #	OffTime (us)	# Pulses	Chirp (MHz)	PW (us)	Pulse1 Pri(us)	Pulse2 Pri(us)	Pulse3 Pri(us)	StartLoc (us)	StartBurst Interval(us)	EndBurst Interval(us)
1	579802	3	8	85	1997	1972	1902	579802	0	799999
2	334850	3	13	75	1531	1845	1407	920523	800000	1599999
3	690494	3	14	85	1247	1420	1326	1615800	1600000	2399999
4	979500	2	19	60	1435	1994	0	2599293	2400000	3199999
5	1317918	1	9	75	1107	0	0	3920640	3200000	3999999
6	681825	1	14	100	1866	0	0	4603572	4000000	4799999
7	255211	2	18	95	1304	1719	0	4860649	4800000	5599999
8	1120445	2	16	55	1323	1019	0	5984117	5600000	6399999
9	1146374	2	5	75	1543	1011	0	7132833	6400000	7199999
10	502448	3	13	70	1841	1907	1247	7637835	7200000	7999999
11	1148217	3	17	60	1952	1529	1333	8791047	8000000	8799999
12	537526	3	14	65	1824	1014	1627	9333387	8800000	9599999
13	987952	2	14	65	1208	1276	0	10325804	9600000	10399999
14	131358	3	17	100	1919	1606	1412	10459646	10400000	11199999
15	1262432	3	17	100	1733	1353	1663	11727015	11200000	11999999
Total	number	of	pulses	in	waveform	=	36			

Radar Type 5 for 802.11ac80 5290 MHz

Waveform Num =	19
Num of Bursts =	13
Burst Interval (us) =	923077

Burst #	OffTime (us)	# Pulses	Chirp (MHz)	PW (us)	Pulse1 Pri(us)	Pulse2 Pri(us)	Pulse3 Pri(us)	StartLoc (us)	StartBurst Interval(us)	EndBurst Interval(us)
1	134243	2	6	50	1735	1687	0	134243	0	923076
2	1187989	1	7	90	1177	0	0	1325654	923077	1846153
3	1099179	1	5	100	1060	0	0	2426010	1846154	2769230
4	1011852	1	8	85	1807	0	0	3438922	2769231	3692307
5	976659	1	8	70	1603	0	0	4417388	3692308	4615384
6	1021127	2	15	70	1915	1729	0	5440118	4615385	5538461
7	1010320	2	13	60	1433	1165	0	6454082	5538462	6461538
8	223453	3	18	100	1684	1098	1511	6680133	6461539	7384615
9	742924	2	13	50	1336	1333	0	7427350	7384616	8307692
10	1785882	2	11	55	1921	1445	0	9215901	8307693	9230769
11	159683	1	12	75	1558	0	0	9378950	9230770	10153846
12	889879	3	6	75	1986	1806	1052	10270387	10153847	11076923
13	1571141	2	10	65	1249	1915	0	11846372	11076924	12000000
Total	number	of	pulses	in	waveform	=	23			

Unless otherwise stated the results shown in this test report refer only to the sample(s) tested and such sample(s) are retained for 90 days only.

除非另有說明，此報告結果僅對測試之樣品負責，同時此樣品僅保留90天。本報告未經本公司書面許可，不可部份複製。

This document is issued by the Company subject to its General Conditions of Service printed overleaf, available on request or accessible at www.sgs.com/terms_and_conditions.htm and, for electronic format documents, subject to Terms and Conditions for Electronic Documents at www.sgs.com/terms_e-document.htm. Attention is drawn to the limitation of liability, indemnification and jurisdiction issues defined therein. Any holder of this document is advised that information contained hereon reflects the Company's findings at the time of its intervention only and within the limits of Client's instructions, if any. The Company's sole responsibility is to its Client and this document does not exonerate parties to a transaction from exercising all their rights and obligations under the transaction documents. This document cannot be reproduced except in full, without prior written approval of the Company. Any unauthorized alteration, forgery or falsification of the content or appearance of this document is unlawful and offenders may be prosecuted to the fullest extent of the law.

SGS Taiwan Ltd.

No.134,WuKungRoad,NewTaipeiIndustrialPark,WukuDistrict,NewTaipeiCity,Taiwan24803/新北市五股區新北產業園區五工路 134 號

台灣檢驗科技股份有限公司

t (886-2) 2299-3279

f (886-2) 2298-0488

www.tw.sgs.com

Member of SGS Group

Radar Type 5 for 802.11ac80 5290 MHz

Waveform Num =	20
Num of Bursts =	13
Burst Interval (us) =	923077

Burst #	OffTime (us)	# Pulses	Chirp (MHz)	PW (us)	Pulse1 Pri(us)	Pulse2 Pri(us)	Pulse3 Pri(us)	StartLoc (us)	StartBurst Interval(us)	EndBurst Interval(us)
1	185495	1	9	60	1658	0	0	185495	0	923076
2	1476043	2	8	95	1626	1647	0	1663196	923077	1846153
3	325464	2	13	80	1145	1287	0	1991933	1846154	2769230
4	959339	3	10	50	1574	1105	1267	2953704	2769231	3692307
5	1183446	1	14	55	1033	0	0	4141096	3692308	4615384
6	1155074	3	16	80	1743	1297	1347	5297203	4615385	5538461
7	423197	3	17	85	1754	1053	1773	5724787	5538462	6461538
8	1196370	3	6	50	1628	1422	1012	6925737	6461539	7384615
9	633509	3	19	100	1953	1096	1605	7563308	7384616	8307692
10	1153793	1	19	100	1869	0	0	8721755	8307693	9230769
11	1302064	1	19	60	1614	0	0	10025688	9230770	10153846
12	437055	3	18	65	1398	1115	1418	10464357	10153847	11076923
13	1157998	2	17	75	1064	1513	0	11626286	11076924	12000000
Total	number	of	pulses	in	waveform	=	28			

Unless otherwise stated the results shown in this test report refer only to the sample(s) tested and such sample(s) are retained for 90 days only.

除非另有說明，此報告結果僅對測試之樣品負責，同時此樣品僅保留90天。本報告未經本公司書面許可，不可部份複製。

This document is issued by the Company subject to its General Conditions of Service printed overleaf, available on request or accessible at www.sgs.com/terms_and_conditions.htm and, for electronic format documents, subject to Terms and Conditions for Electronic Documents at www.sgs.com/terms_e-document.htm. Attention is drawn to the limitation of liability, indemnification and jurisdiction issues defined therein. Any holder of this document is advised that information contained hereon reflects the Company's findings at the time of its intervention only and within the limits of Client's instructions, if any. The Company's sole responsibility is to its Client and this document does not exonerate parties to a transaction from exercising all their rights and obligations under the transaction documents. This document cannot be reproduced except in full, without prior written approval of the Company. Any unauthorized alteration, forgery or falsification of the content or appearance of this document is unlawful and offenders may be prosecuted to the fullest extent of the law.

SGS Taiwan Ltd.

No.134,WuKungRoad,NewTaipeiIndustrialPark,WukuDistrict,NewTaipeiCity,Taiwan24803/新北市五股區新北產業園區五工路 134 號

台灣檢驗科技股份有限公司

t (886-2) 2299-3279

f (886-2) 2298-0488

www.tw.sgs.com

Member of SGS Group

Radar Type 5 for 802.11ac80 5290 MHz

Waveform Num =	21
Num of Bursts =	19
Burst Interval (us) =	631579

Burst #	OffTime (us)	# Pulses	Chirp (MHz)	PW (us)	Pulse1 Pri(us)	Pulse2 Pri(us)	Pulse3 Pri(us)	StartLoc (us)	StartBurst Interval(us)	EndBurst Interval(us)
1	418753	1	13	100	1040	0	0	418753	0	631578
2	238681	3	12	75	1881	1652	1172	658474	631579	1263157
3	833357	1	9	95	1934	0	0	1496536	1263158	1894736
4	922016	1	5	85	1511	0	0	2420486	1894737	2526315
5	596366	1	9	95	1530	0	0	3018363	2526316	3157894
6	505536	2	7	55	1899	1617	0	3525429	3157895	3789473
7	684576	3	16	65	1267	1782	1664	4213521	3789474	4421052
8	633771	3	7	75	1793	1260	1872	4852005	4421053	5052631
9	810889	1	18	90	1459	0	0	5667819	5052632	5684210
10	469519	2	12	65	1619	1004	0	6138797	5684211	6315789
11	357323	2	15	70	1982	1678	0	6498743	6315790	6947368
12	1036637	2	20	90	1067	1587	0	7539040	6947369	7578947
13	479430	3	9	95	1670	1965	1124	8021124	7578948	8210526
14	539829	1	14	80	1306	0	0	8565712	8210527	8842105
15	901883	2	7	65	1661	1958	0	9468901	8842106	9473684
16	303219	1	16	70	1346	0	0	9775739	9473685	10105263
17	578202	2	12	60	1054	1770	0	10355287	10105264	10736842
18	697405	1	9	60	1853	0	0	11055516	10736843	11368421
19	508319	1	16	55	1818	0	0	11565688	11368422	12000000
Total	number	of	pulses	in	waveform	=	33			

Unless otherwise stated the results shown in this test report refer only to the sample(s) tested and such sample(s) are retained for 90 days only.

除非另有說明，此報告結果僅對測試之樣品負責，同時此樣品僅保留90天。本報告未經本公司書面許可，不可部份複製。

This document is issued by the Company subject to its General Conditions of Service printed overleaf, available on request or accessible at www.sgs.com/terms_and_conditions.htm and, for electronic format documents, subject to Terms and Conditions for Electronic Documents at www.sgs.com/terms_e-document.htm. Attention is drawn to the limitation of liability, indemnification and jurisdiction issues defined therein. Any holder of this document is advised that information contained hereon reflects the Company's findings at the time of its intervention only and within the limits of Client's instructions, if any. The Company's sole responsibility is to its Client and this document does not exonerate parties to a transaction from exercising all their rights and obligations under the transaction documents. This document cannot be reproduced except in full, without prior written approval of the Company. Any unauthorized alteration, forgery or falsification of the content or appearance of this document is unlawful and offenders may be prosecuted to the fullest extent of the law.

Radar Type 5 for 802.11ac80 5290 MHz

Waveform Num =	22
Num of Bursts =	15
Burst Interval (us) =	800000

Burst #	OffTime (us)	# Pulses	Chirp (MHz)	PW (us)	Pulse1 Pri(us)	Pulse2 Pri(us)	Pulse3 Pri(us)	StartLoc (us)	StartBurst Interval(us)	EndBurst Interval(us)
1	734258	3	20	90	1555	1333	1451	734258	0	799999
2	321879	2	14	85	1988	1965	0	1060476	800000	1599999
3	1017675	1	11	80	1418	0	0	2082104	1600000	2399999
4	350302	3	12	100	1757	1474	1407	2433824	2400000	3199999
5	780496	3	18	60	1018	1936	1354	3218958	3200000	3999999
6	933963	3	12	70	1220	1197	1277	4157229	4000000	4799999
7	1092772	2	15	70	1866	1608	0	5253695	4800000	5599999
8	745462	1	16	100	1372	0	0	6002631	5600000	6399999
9	834147	1	8	55	1858	0	0	6838150	6400000	7199999
10	437893	1	12	60	1029	0	0	7277901	7200000	7999999
11	722347	1	6	100	1566	0	0	8001277	8000000	8799999
12	1274348	1	18	100	1979	0	0	9277191	8800000	9599999
13	815739	1	9	50	1192	0	0	10094909	9600000	10399999
14	880523	3	8	95	1057	1406	1301	10976624	10400000	11199999
15	391656	1	10	70	1845	0	0	11372044	11200000	11999999
Total	number	of	pulses	in	waveform	=	27			

Radar Type 5 for 802.11ac80 5290 MHz

Waveform Num =	23
Num of Bursts =	9
Burst Interval (us) =	1333333

Burst #	OffTime (us)	# Pulses	Chirp (MHz)	PW (us)	Pulse1 Pri(us)	Pulse2 Pri(us)	Pulse3 Pri(us)	StartLoc (us)	StartBurst Interval(us)	EndBurst Interval(us)
1	450555	3	10	60	1571	1519	1687	450555	0	1333332
2	1390111	2	6	80	1418	1393	0	1845443	1333333	2666665
3	1497365	2	14	50	1941	1651	0	3345619	2666666	3999998
4	983271	2	5	55	1926	1779	0	4332482	3999999	5333331
5	1083929	3	5	75	1084	1045	1598	5420116	5333332	6666664
6	1879620	3	8	85	1013	1493	1870	7303463	6666665	7999997
7	1340122	3	16	100	1143	1679	1141	8647961	7999998	9333330
8	1504353	2	6	65	1003	1111	0	10156277	9333331	10666663
9	579551	1	14	95	1120	0	0	10737942	10666664	11999996
Total	number	of	pulses	in	waveform	=	21			

Unless otherwise stated the results shown in this test report refer only to the sample(s) tested and such sample(s) are retained for 90 days only.

除非另有說明，此報告結果僅對測試之樣品負責，同時此樣品僅保留90天。本報告未經本公司書面許可，不可部份複製。

This document is issued by the Company subject to its General Conditions of Service printed overleaf, available on request or accessible at www.sgs.com/terms_and_conditions.htm and, for electronic format documents, subject to Terms and Conditions for Electronic Documents at www.sgs.com/terms_e-document.htm. Attention is drawn to the limitation of liability, indemnification and jurisdiction issues defined therein. Any holder of this document is advised that information contained hereon reflects the Company's findings at the time of its intervention only and within the limits of Client's instructions, if any. The Company's sole responsibility is to its Client and this document does not exonerate parties to a transaction from exercising all their rights and obligations under the transaction documents. This document cannot be reproduced except in full, without prior written approval of the Company. Any unauthorized alteration, forgery or falsification of the content or appearance of this document is unlawful and offenders may be prosecuted to the fullest extent of the law.

Radar Type 5 for 802.11ac80 5290 MHz

Waveform Num =	24
Num of Bursts =	19
Burst Interval (us) =	631579

Burst #	OffTime (us)	# Pulses	Chirp (MHz)	PW (us)	Pulse1 Pri(us)	Pulse2 Pri(us)	Pulse3 Pri(us)	StartLoc (us)	StartBurst Interval(us)	EndBurst Interval(us)
1	335529	2	11	90	1130	1894	0	335529	0	631578
2	740443	2	17	70	1504	1116	0	1078996	631579	1263157
3	548803	3	9	65	1078	1436	1500	1630419	1263158	1894736
4	872580	2	17	80	1494	1743	0	2507013	1894737	2526315
5	592143	3	13	90	1700	1053	1632	3102393	2526316	3157894
6	402899	1	12	55	1701	0	0	3509677	3157895	3789473
7	883327	2	9	65	1457	1821	0	4394705	3789474	4421052
8	563747	3	18	85	1702	1683	1969	4961730	4421053	5052631
9	339495	2	5	100	1973	1256	0	5306579	5052632	5684210
10	1003434	1	17	100	1318	0	0	6313242	5684211	6315789
11	492074	3	20	95	1192	1518	1666	6806634	6315790	6947368
12	157182	3	11	50	1197	1565	1147	6968192	6947369	7578947
13	918999	2	10	95	1183	1372	0	7891100	7578948	8210526
14	583983	2	6	75	1700	1005	0	8477638	8210527	8842105
15	548037	1	12	80	1247	0	0	9028380	8842106	9473684
16	932970	1	7	65	1117	0	0	9962597	9473685	10105263
17	444392	1	19	55	1697	0	0	10408106	10105264	10736842
18	593731	2	17	100	1013	1732	0	11003534	10736843	11368421
19	614535	3	17	80	1428	1174	1923	11620814	11368422	12000000
Total	number	of	pulses	in	waveform	=	39			

Unless otherwise stated the results shown in this test report refer only to the sample(s) tested and such sample(s) are retained for 90 days only.

除非另有說明，此報告結果僅對測試之樣品負責，同時此樣品僅保留90天。本報告未經本公司書面許可，不可部份複製。

This document is issued by the Company subject to its General Conditions of Service printed overleaf, available on request or accessible at www.sgs.com/terms_and_conditions.htm and, for electronic format documents, subject to Terms and Conditions for Electronic Documents at www.sgs.com/terms_e-document.htm. Attention is drawn to the limitation of liability, indemnification and jurisdiction issues defined therein. Any holder of this document is advised that information contained hereon reflects the Company's findings at the time of its intervention only and within the limits of Client's instructions, if any. The Company's sole responsibility is to its Client and this document does not exonerate parties to a transaction from exercising all their rights and obligations under the transaction documents. This document cannot be reproduced except in full, without prior written approval of the Company. Any unauthorized alteration, forgery or falsification of the content or appearance of this document is unlawful and offenders may be prosecuted to the fullest extent of the law.

SGS Taiwan Ltd.

No.134,WuKungRoad,NewTaipeiIndustrialPark,WukuDistrict,NewTaipeiCity,Taiwan24803/新北市五股區新北產業園區五工路 134 號

台灣檢驗科技股份有限公司

t (886-2) 2299-3279

f (886-2) 2298-0488

www.tw.sgs.com

Member of SGS Group

Radar Type 5 for 802.11ac80 5290 MHz

Waveform Num =	25
Num of Bursts =	20
Burst Interval (us) =	600000

Burst #	OffTime (us)	# Pulses	Chirp (MHz)	PW (us)	Pulse1 Pri(us)	Pulse2 Pri(us)	Pulse3 Pri(us)	StartLoc (us)	StartBurst Interval(us)	EndBurst Interval(us)
1	86474	3	5	100	1342	1947	1556	86474	0	599999
2	749973	1	11	70	1058	0	0	841292	600000	1199999
3	840956	2	14	55	1364	1997	0	1683306	1200000	1799999
4	450625	3	18	75	1723	1076	1980	2137292	1800000	2399999
5	603249	2	5	95	1019	1958	0	2745320	2400000	2999999
6	302936	2	10	100	1912	1265	0	3051233	3000000	3599999
7	1025773	2	16	90	1944	1160	0	4080183	3600000	4199999
8	255406	3	14	100	1538	1774	1145	4338693	4200000	4799999
9	648927	1	9	85	1574	0	0	4992077	4800000	5399999
10	450582	3	7	50	1644	1882	1302	5444233	5400000	5999999
11	1035999	2	16	55	1401	1712	0	6485060	6000000	6599999
12	428291	2	11	60	1000	1005	0	6916464	6600000	7199999
13	602842	1	9	75	1183	0	0	7521311	7200000	7799999
14	475594	2	11	80	1504	1002	0	7998088	7800000	8399999
15	609685	1	7	55	1606	0	0	8610279	8400000	8999999
16	961959	3	18	100	1332	1927	1887	9573844	9000000	9599999
17	32181	1	9	60	1652	0	0	9611171	9600000	10199999
18	966183	1	14	65	1521	0	0	10579006	10200000	10799999
19	238197	3	11	95	1563	1532	1375	10818724	10800000	11399999
20	582691	1	9	80	1460	0	0	11405885	11400000	11999999
Total	number	of	pulses	in	waveform	=	39			

Unless otherwise stated the results shown in this test report refer only to the sample(s) tested and such sample(s) are retained for 90 days only.

除非另有說明，此報告結果僅對測試之樣品負責，同時此樣品僅保留90天。本報告未經本公司書面許可，不可部份複製。

This document is issued by the Company subject to its General Conditions of Service printed overleaf, available on request or accessible at www.sgs.com/terms_and_conditions.htm and, for electronic format documents, subject to Terms and Conditions for Electronic Documents at www.sgs.com/terms_e-document.htm. Attention is drawn to the limitation of liability, indemnification and jurisdiction issues defined therein. Any holder of this document is advised that information contained hereon reflects the Company's findings at the time of its intervention only and within the limits of Client's instructions, if any. The Company's sole responsibility is to its Client and this document does not exonerate parties to a transaction from exercising all their rights and obligations under the transaction documents. This document cannot be reproduced except in full, without prior written approval of the Company. Any unauthorized alteration, forgery or falsification of the content or appearance of this document is unlawful and offenders may be prosecuted to the fullest extent of the law.

SGS Taiwan Ltd.

No.134,WuKungRoad,NewTaipeiIndustrialPark,WukuDistrict,NewTaipeiCity,Taiwan24803/新北市五股區新北產業園區五工路 134 號

台灣檢驗科技股份有限公司

t (886-2) 2299-3279

f (886-2) 2298-0488

www.tw.sgs.com

Member of SGS Group

Radar Type 5 for 802.11ac80 5290 MHz

Waveform Num =	26
Num of Bursts =	19
Burst Interval (us) =	631579

Burst #	OffTime (us)	# Pulses	Chirp (MHz)	PW (us)	Pulse1 Pri(us)	Pulse2 Pri(us)	Pulse3 Pri(us)	StartLoc (us)	StartBurst Interval(us)	EndBurst Interval(us)
1	589015	1	16	50	1906	0	0	589015	0	631578
2	324472	1	17	65	1563	0	0	915393	631579	1263157
3	474539	3	16	90	1391	1726	1065	1391495	1263158	1894736
4	535680	3	19	100	1466	1536	1093	1931357	1894737	2526315
5	887021	2	19	65	1519	1863	0	2822473	2526316	3157894
6	580564	2	8	55	1722	1383	0	3406419	3157895	3789473
7	943852	2	19	55	1689	1328	0	4353376	3789474	4421052
8	403416	2	6	70	1671	1060	0	4759809	4421053	5052631
9	554479	2	14	70	1299	1117	0	5317019	5052632	5684210
10	684489	3	6	85	1024	1387	1148	6003924	5684211	6315789
11	897484	3	18	80	1323	1697	1163	6904967	6315790	6947368
12	185103	1	16	90	1388	0	0	7094253	6947369	7578947
13	763069	1	14	75	1353	0	0	7858710	7578948	8210526
14	479531	1	20	100	1457	0	0	8339594	8210527	8842105
15	803631	3	11	80	1256	1902	1912	9144682	8842106	9473684
16	779335	2	11	75	1650	1728	0	9929087	9473685	10105263
17	321429	1	15	60	1818	0	0	10253894	10105264	10736842
18	683511	1	7	60	1933	0	0	10939223	10736843	11368421
19	482655	2	8	85	1241	1447	0	11423811	11368422	12000000
Total	number	of	pulses	in	waveform	=	36			

Unless otherwise stated the results shown in this test report refer only to the sample(s) tested and such sample(s) are retained for 90 days only.

除非另有說明，此報告結果僅對測試之樣品負責，同時此樣品僅保留90天。本報告未經本公司書面許可，不可部份複製。

This document is issued by the Company subject to its General Conditions of Service printed overleaf, available on request or accessible at www.sgs.com/terms_and_conditions.htm and, for electronic format documents, subject to Terms and Conditions for Electronic Documents at www.sgs.com/terms_e-document.htm. Attention is drawn to the limitation of liability, indemnification and jurisdiction issues defined therein. Any holder of this document is advised that information contained hereon reflects the Company's findings at the time of its intervention only and within the limits of Client's instructions, if any. The Company's sole responsibility is to its Client and this document does not exonerate parties to a transaction from exercising all their rights and obligations under the transaction documents. This document cannot be reproduced except in full, without prior written approval of the Company. Any unauthorized alteration, forgery or falsification of the content or appearance of this document is unlawful and offenders may be prosecuted to the fullest extent of the law.

SGS Taiwan Ltd.

No.134,WuKungRoad,NewTaipeiIndustrialPark,WukuDistrict,NewTaipeiCity,Taiwan24803/新北市五股區新北產業園區五工路 134 號

台灣檢驗科技股份有限公司

t (886-2) 2299-3279

f (886-2) 2298-0488

www.tw.sgs.com

Member of SGS Group

Radar Type 5 for 802.11ac80 5290 MHz

Waveform Num =	27
Num of Bursts =	18
Burst Interval (us) =	666667

Burst #	OffTime (us)	# Pulses	Chirp (MHz)	PW (us)	Pulse1 Pri(us)	Pulse2 Pri(us)	Pulse3 Pri(us)	StartLoc (us)	StartBurst Interval(us)	EndBurst Interval(us)
1	629111	2	15	90	1942	1513	0	629111	0	666666
2	307028	1	9	50	1603	0	0	939594	666667	1333333
3	850545	3	15	50	1694	1718	1016	1791742	1333334	2000000
4	269620	3	18	95	1840	1573	1635	2065790	2000001	2666667
5	746636	2	7	50	1925	1398	0	2817474	2666668	3333334
6	1079211	1	12	100	1259	0	0	3900008	3333335	4000001
7	528165	2	14	70	1496	1106	0	4429432	4000002	4666668
8	649151	3	20	100	1766	1832	1242	5081185	4666669	5333335
9	284981	1	15	85	1085	0	0	5371006	5333336	6000002
10	1023711	2	6	75	1082	1924	0	6395802	6000003	6666669
11	697482	2	5	90	1235	1582	0	7096290	6666670	7333336
12	305918	1	7	65	1234	0	0	7405025	7333337	8000003
13	889250	3	18	95	1026	1961	1319	8295509	8000004	8666670
14	669252	2	16	80	1219	1825	0	8969067	8666671	9333337
15	593283	2	12	95	1562	1058	0	9565394	9333338	10000004
16	797693	1	10	90	1360	0	0	10365707	10000005	10666671
17	900201	2	6	75	1446	1983	0	11267268	10666672	11333338
18	166946	1	19	55	1282	0	0	11437643	11333339	12000005
Total	number	of	pulses	in	waveform	=	34			

Unless otherwise stated the results shown in this test report refer only to the sample(s) tested and such sample(s) are retained for 90 days only.

除非另有說明，此報告結果僅對測試之樣品負責，同時此樣品僅保留90天。本報告未經本公司書面許可，不可部份複製。

This document is issued by the Company subject to its General Conditions of Service printed overleaf, available on request or accessible at www.sgs.com/terms_and_conditions.htm and, for electronic format documents, subject to Terms and Conditions for Electronic Documents at www.sgs.com/terms_e-document.htm. Attention is drawn to the limitation of liability, indemnification and jurisdiction issues defined therein. Any holder of this document is advised that information contained hereon reflects the Company's findings at the time of its intervention only and within the limits of Client's instructions, if any. The Company's sole responsibility is to its Client and this document does not exonerate parties to a transaction from exercising all their rights and obligations under the transaction documents. This document cannot be reproduced except in full, without prior written approval of the Company. Any unauthorized alteration, forgery or falsification of the content or appearance of this document is unlawful and offenders may be prosecuted to the fullest extent of the law.

SGS Taiwan Ltd.

No.134,WuKungRoad,NewTaipeiIndustrialPark,WukuDistrict,NewTaipeiCity,Taiwan24803/新北市五股區新北產業園區五工路 134 號

台灣檢驗科技股份有限公司

t (886-2) 2299-3279

f (886-2) 2298-0488

www.tw.sgs.com

Member of SGS Group

Radar Type 5 for 802.11ac80 5290 MHz

Waveform Num =	28
Num of Bursts =	18
Burst Interval (us) =	666667

Burst #	OffTime (us)	# Pulses	Chirp (MHz)	PW (us)	Pulse1 Pri(us)	Pulse2 Pri(us)	Pulse3 Pri(us)	StartLoc (us)	StartBurst Interval(us)	EndBurst Interval(us)
1	175226	2	18	100	1294	1609	0	175226	0	666666
2	549298	1	15	85	1940	0	0	727427	666667	1333333
3	684067	2	7	55	1543	1312	0	1413434	1333334	2000000
4	1066443	3	8	80	1717	1123	1058	2482732	2000001	2666667
5	690211	2	10	100	1409	1603	0	3176841	2666668	3333334
6	594975	3	12	75	1869	1270	1505	3774828	3333335	4000001
7	325400	1	6	60	1724	0	0	4104872	4000002	4666668
8	589648	1	16	90	1797	0	0	4696244	4666669	5333335
9	1179639	1	20	65	1548	0	0	5877680	5333336	6000002
10	626188	1	12	95	1793	0	0	6505416	6000003	6666669
11	384121	1	19	90	1620	0	0	6891330	6666670	7333336
12	924884	1	17	100	1565	0	0	7817834	7333337	8000003
13	337989	2	15	60	1048	1118	0	8157388	8000004	8666670
14	1019907	1	11	55	1360	0	0	9179461	8666671	9333337
15	241529	3	11	70	1310	1739	1725	9422350	9333338	10000004
16	637492	1	15	60	1048	0	0	10064616	10000005	10666671
17	1187367	2	15	70	1725	1381	0	11253031	10666672	11333338
18	256903	1	12	90	1013	0	0	11513040	11333339	12000005
Total	number	of	pulses	in	waveform	=	29			

Unless otherwise stated the results shown in this test report refer only to the sample(s) tested and such sample(s) are retained for 90 days only.

除非另有說明，此報告結果僅對測試之樣品負責，同時此樣品僅保留90天。本報告未經本公司書面許可，不可部份複製。

This document is issued by the Company subject to its General Conditions of Service printed overleaf, available on request or accessible at www.sgs.com/terms_and_conditions.htm and, for electronic format documents, subject to Terms and Conditions for Electronic Documents at www.sgs.com/terms_e-document.htm. Attention is drawn to the limitation of liability, indemnification and jurisdiction issues defined therein. Any holder of this document is advised that information contained hereon reflects the Company's findings at the time of its intervention only and within the limits of Client's instructions, if any. The Company's sole responsibility is to its Client and this document does not exonerate parties to a transaction from exercising all their rights and obligations under the transaction documents. This document cannot be reproduced except in full, without prior written approval of the Company. Any unauthorized alteration, forgery or falsification of the content or appearance of this document is unlawful and offenders may be prosecuted to the fullest extent of the law.

SGS Taiwan Ltd.

No.134,WuKungRoad,NewTaipeiIndustrialPark,WukuDistrict,NewTaipeiCity,Taiwan24803/新北市五股區新北產業園區五工路 134 號

台灣檢驗科技股份有限公司

t (886-2) 2299-3279

f (886-2) 2298-0488

www.tw.sgs.com

Member of SGS Group

Radar Type 5 for 802.11ac80 5290 MHz

Waveform Num =	29
Num of Bursts =	20
Burst Interval (us) =	600000

Burst #	OffTime (us)	# Pulses	Chirp (MHz)	PW (us)	Pulse1 Pri(us)	Pulse2 Pri(us)	Pulse3 Pri(us)	StartLoc (us)	StartBurst Interval(us)	EndBurst Interval(us)
1	93526	1	14	100	1743	0	0	93526	0	599999
2	1099179	3	9	100	1575	1886	1392	1194448	600000	1199999
3	99689	2	5	75	1092	1032	0	1298990	1200000	1799999
4	554060	1	16	60	1628	0	0	1855174	1800000	2399999
5	885049	3	17	70	1571	1067	1460	2741851	2400000	2999999
6	733307	2	7	75	1754	1039	0	3479256	3000000	3599999
7	607185	2	8	70	1766	1329	0	4089234	3600000	4199999
8	534687	3	20	65	1635	1799	1057	4627016	4200000	4799999
9	614063	2	16	60	1630	1369	0	5245570	4800000	5399999
10	518607	1	11	90	1689	0	0	5767176	5400000	5999999
11	718963	1	16	95	1111	0	0	6487828	6000000	6599999
12	260344	1	8	85	1374	0	0	6749283	6600000	7199999
13	691813	3	8	70	1065	1917	1224	7442470	7200000	7799999
14	377594	2	14	90	1316	1082	0	7824270	7800000	8399999
15	1160657	3	6	60	1430	1837	1862	8987325	8400000	8999999
16	8039	1	8	90	1965	0	0	9000493	9000000	9599999
17	1054599	3	20	75	1749	1848	1674	10057057	9600000	10199999
18	299873	3	11	85	1905	1308	1327	10362201	10200000	10799999
19	589068	2	12	65	1737	1582	0	10955809	10800000	11399999
20	798530	1	6	95	1800	0	0	11757658	11400000	11999999
Total	number	of	pulses	in	waveform	=	40			

Unless otherwise stated the results shown in this test report refer only to the sample(s) tested and such sample(s) are retained for 90 days only.

除非另有說明，此報告結果僅對測試之樣品負責，同時此樣品僅保留90天。本報告未經本公司書面許可，不可部份複製。

This document is issued by the Company subject to its General Conditions of Service printed overleaf, available on request or accessible at www.sgs.com/terms_and_conditions.htm and, for electronic format documents, subject to Terms and Conditions for Electronic Documents at www.sgs.com/terms_e-document.htm. Attention is drawn to the limitation of liability, indemnification and jurisdiction issues defined therein. Any holder of this document is advised that information contained hereon reflects the Company's findings at the time of its intervention only and within the limits of Client's instructions, if any. The Company's sole responsibility is to its Client and this document does not exonerate parties to a transaction from exercising all their rights and obligations under the transaction documents. This document cannot be reproduced except in full, without prior written approval of the Company. Any unauthorized alteration, forgery or falsification of the content or appearance of this document is unlawful and offenders may be prosecuted to the fullest extent of the law.

SGS Taiwan Ltd.

No.134,WuKungRoad,NewTaipeiIndustrialPark,WukuDistrict,NewTaipeiCity,Taiwan24803/新北市五股區新北產業園區五工路 134 號

台灣檢驗科技股份有限公司

t (886-2) 2299-3279

f (886-2) 2298-0488

www.tw.sgs.com

Member of SGS Group

Radar Type 5 for 802.11ac80 5290 MHz

Waveform Num =	30
Num of Bursts =	14
Burst Interval (us) =	857143

Burst #	OffTime (us)	# Pulses	Chirp (MHz)	PW (us)	Pulse1 Pri(us)	Pulse2 Pri(us)	Pulse3 Pri(us)	StartLoc (us)	StartBurst Interval(us)	EndBurst Interval(us)
1	542876	3	5	55	1784	1946	1403	542876	0	857142
2	788539	3	15	65	1065	1039	1620	1336548	857143	1714285
3	460718	1	20	90	1569	0	0	1800990	1714286	2571428
4	985712	1	10	75	1428	0	0	2788271	2571429	3428571
5	855668	3	7	70	1535	1559	1464	3645367	3428572	4285714
6	828829	1	6	95	1346	0	0	4478754	4285715	5142857
7	755188	2	9	90	1423	1910	0	5235288	5142858	6000000
8	924587	3	15	85	1679	1014	1562	6163208	6000001	6857143
9	947877	3	14	80	1527	1036	1605	7115340	6857144	7714286
10	619637	3	5	55	1473	1785	1662	7739145	7714287	8571429
11	1671581	2	16	50	1714	1422	0	9415646	8571430	9428572
12	277911	2	8	55	1177	1150	0	9696693	9428573	10285715
13	1089482	1	5	55	1178	0	0	10788502	10285716	11142858
14	519508	2	8	100	1273	1579	0	11309188	11142859	12000001
Total	number	of	pulses	in	waveform	=	30			

Unless otherwise stated the results shown in this test report refer only to the sample(s) tested and such sample(s) are retained for 90 days only.

除非另有說明，此報告結果僅對測試之樣品負責，同時此樣品僅保留90天。本報告未經本公司書面許可，不可部份複製。

This document is issued by the Company subject to its General Conditions of Service printed overleaf, available on request or accessible at www.sgs.com/terms_and_conditions.htm and, for electronic format documents, subject to Terms and Conditions for Electronic Documents at www.sgs.com/terms_e-document.htm. Attention is drawn to the limitation of liability, indemnification and jurisdiction issues defined therein. Any holder of this document is advised that information contained hereon reflects the Company's findings at the time of its intervention only and within the limits of Client's instructions, if any. The Company's sole responsibility is to its Client and this document does not exonerate parties to a transaction from exercising all their rights and obligations under the transaction documents. This document cannot be reproduced except in full, without prior written approval of the Company. Any unauthorized alteration, forgery or falsification of the content or appearance of this document is unlawful and offenders may be prosecuted to the fullest extent of the law.

SGS Taiwan Ltd.

No.134,WuKungRoad,NewTaipeiIndustrialPark,WukuDistrict,NewTaipeiCity,Taiwan24803/新北市五股區新北產業園區五工路 134 號

台灣檢驗科技股份有限公司

t (886-2) 2299-3279

f (886-2) 2298-0488

www.tw.sgs.com

Member of SGS Group

802.11ac80 5530 MHz:

FCC13-22 Radar Test Summary

Short Pulse Radar Type	Minimum Number of Trials	Detection(%)	Minimum Percentage of Successful Detection(%)	Pass/Fail
1	30	96.66	60	Pass
2	30	93.33	60	Pass
3	30	93.33	60	Pass
4	30	100.00	60	Pass
Aggregate (Radar Types 1-4)	120	95.83	80	Pass
Long Pulse Radar Test Waveform	Minimum Number of Trials	Detection	Minimum Percentage of Successful Detection(Limit)	Pass/Fail
5 - Variable	30	100.00	80	Pass
Frequency Hopping Radar Test Waveform	Minimum Number of Trials	Detection	Minimum Percentage of Successful Detection(Limit)	Pass/Fail
6	30	100.00	70	Pass

Unless otherwise stated the results shown in this test report refer only to the sample(s) tested and such sample(s) are retained for 90 days only.

除非另有說明，此報告結果僅對測試之樣品負責，同時此樣品僅保留90天。本報告未經本公司書面許可，不可部份複製。

This document is issued by the Company subject to its General Conditions of Service printed overleaf, available on request or accessible at www.sgs.com/terms_and_conditions.htm and, for electronic format documents, subject to Terms and Conditions for Electronic Documents at www.sgs.com/terms_e-document.htm. Attention is drawn to the limitation of liability, indemnification and jurisdiction issues defined therein. Any holder of this document is advised that information contained hereon reflects the Company's findings at the time of its intervention only and within the limits of Client's instructions, if any. The Company's sole responsibility is to its Client and this document does not exonerate parties to a transaction from exercising all their rights and obligations under the transaction documents. This document cannot be reproduced except in full, without prior written approval of the Company. Any unauthorized alteration, forgery or falsification of the content or appearance of this document is unlawful and offenders may be prosecuted to the fullest extent of the law.

SGS Taiwan Ltd.

No.134,WuKungRoad,NewTaipeiIndustrialPark,WukuDistrict,NewTaipeiCity,Taiwan24803/新北市五股區新北產業園區五工路 134 號

台灣檢驗科技股份有限公司

t (886-2) 2299-3279

f (886-2) 2298-0488

www.tw.sgs.com

Member of SGS Group

Radar Type 1 for 802.11ac80 5530 MHz:

Data Sheet for FCC Variable Radar Type 1				
1 us Pulse Width, PRI Test A&Test B				
Trial	PRI	Pulses Per Burst	Test	Successful Detection

Unless otherwise stated the results shown in this test report refer only to the sample(s) tested and such sample(s) are retained for 90 days only.

除非另有說明，此報告結果僅對測試之樣品負責，同時此樣品僅保留90天。本報告未經本公司書面許可，不可部份複製。

This document is issued by the Company subject to its General Conditions of Service printed overleaf, available on request or accessible at www.sgs.com/terms_and_conditions.htm and, for electronic format documents, subject to Terms and Conditions for Electronic Documents at www.sgs.com/terms_e-document.htm. Attention is drawn to the limitation of liability, indemnification and jurisdiction issues defined therein. Any holder of this document is advised that information contained hereon reflects the Company's findings at the time of its intervention only and within the limits of Client's instructions, if any. The Company's sole responsibility is to its Client and this document does not exonerate parties to a transaction from exercising all their rights and obligations under the transaction documents. This document cannot be reproduced except in full, without prior written approval of the Company. Any unauthorized alteration, forgery or falsification of the content or appearance of this document is unlawful and offenders may be prosecuted to the fullest extent of the law.

SGS Taiwan Ltd.

No.134,WuKungRoad,NewTaipeiIndustrialPark,WukuDistrict,NewTaipeiCity,Taiwan24803/新北市五股區新北產業園區五工路 134 號

台灣檢驗科技股份有限公司

t (886-2) 2299-3279

f (886-2) 2298-0488

www.tw.sgs.com

Member of SGS Group

Radar Type 2 for 802.11ac80 5530 MHz:

Data Sheet for FCC Variable Radar Type 2				
1-5 us Pulse Width, PRI 150-230 us, 23-29 Pulses per Burst				
Trial	Pulse Width	PRI	Pulses Per Burst	Successful Detection

Unless otherwise stated the results shown in this test report refer only to the sample(s) tested and such sample(s) are retained for 90 days only.

除非另有說明，此報告結果僅對測試之樣品負責，同時此樣品僅保留90天。本報告未經本公司書面許可，不可部份複製。

This document is issued by the Company subject to its General Conditions of Service printed overleaf, available on request or accessible at www.sgs.com/terms_and_conditions.htm and, for electronic format documents, subject to Terms and Conditions for Electronic Documents at www.sgs.com/terms_e-document.htm. Attention is drawn to the limitation of liability, indemnification and jurisdiction issues defined therein. Any holder of this document is advised that information contained hereon reflects the Company's findings at the time of its intervention only and within the limits of Client's instructions, if any. The Company's sole responsibility is to its Client and this document does not exonerate parties to a transaction from exercising all their rights and obligations under the transaction documents. This document cannot be reproduced except in full, without prior written approval of the Company. Any unauthorized alteration, forgery or falsification of the content or appearance of this document is unlawful and offenders may be prosecuted to the fullest extent of the law.

SGS Taiwan Ltd.

No.134,WuKungRoad,NewTaipeiIndustrialPark,WukuDistrict,NewTaipeiCity,Taiwan24803/新北市五股區新北產業園區五工路 134 號

台灣檢驗科技股份有限公司

t (886-2) 2299-3279

f (886-2) 2298-0488

www.tw.sgs.com

Member of SGS Group

Radar Type 3 for 802.11ac80 5530 MHz:

Data Sheet for FCC Variable Radar Type 3				
6-10 us Pulse Width, PRI 200-500 us, 16-18 Pulses per Burst				
Trial	Pulse Width	PRI	Pulses Per Burst	Successful Detection

Unless otherwise stated the results shown in this test report refer only to the sample(s) tested and such sample(s) are retained for 90 days only.

除非另有說明，此報告結果僅對測試之樣品負責，同時此樣品僅保留90天。本報告未經本公司書面許可，不可部份複製。

This document is issued by the Company subject to its General Conditions of Service printed overleaf, available on request or accessible at www.sgs.com/terms_and_conditions.htm and, for electronic format documents, subject to Terms and Conditions for Electronic Documents at www.sgs.com/terms_e-document.htm. Attention is drawn to the limitation of liability, indemnification and jurisdiction issues defined therein. Any holder of this document is advised that information contained hereon reflects the Company's findings at the time of its intervention only and within the limits of Client's instructions, if any. The Company's sole responsibility is to its Client and this document does not exonerate parties to a transaction from exercising all their rights and obligations under the transaction documents. This document cannot be reproduced except in full, without prior written approval of the Company. Any unauthorized alteration, forgery or falsification of the content or appearance of this document is unlawful and offenders may be prosecuted to the fullest extent of the law.

SGS Taiwan Ltd.

No.134,WuKungRoad,NewTaipeiIndustrialPark,WukuDistrict,NewTaipeiCity,Taiwan24803/新北市五股區新北產業園區五工路 134 號

台灣檢驗科技股份有限公司

t (886-2) 2299-3279

f (886-2) 2298-0488

www.tw.sgs.com

Member of SGS Group

Radar Type 4 for 802.11ac80 5530 MHz:

Data Sheet for FCC Variable Radar Type 4				
11-20 us Pulse Width, PRI 200-500 us, 12-16 Pulses per Burst				
Trial	Pulse Width	PRI	Pulses Per Burst	Successful Detection

Unless otherwise stated the results shown in this test report refer only to the sample(s) tested and such sample(s) are retained for 90 days only.

除非另有說明，此報告結果僅對測試之樣品負責，同時此樣品僅保留90天。本報告未經本公司書面許可，不可部份複製。

This document is issued by the Company subject to its General Conditions of Service printed overleaf, available on request or accessible at www.sgs.com/terms_and_conditions.htm and, for electronic format documents, subject to Terms and Conditions for Electronic Documents at www.sgs.com/terms_e-document.htm. Attention is drawn to the limitation of liability, indemnification and jurisdiction issues defined therein. Any holder of this document is advised that information contained hereon reflects the Company's findings at the time of its intervention only and within the limits of Client's instructions, if any. The Company's sole responsibility is to its Client and this document does not exonerate parties to a transaction from exercising all their rights and obligations under the transaction documents. This document cannot be reproduced except in full, without prior written approval of the Company. Any unauthorized alteration, forgery or falsification of the content or appearance of this document is unlawful and offenders may be prosecuted to the fullest extent of the law.

SGS Taiwan Ltd.

No.134,WuKungRoad,NewTaipeiIndustrialPark,WukuDistrict,NewTaipeiCity,Taiwan24803/新北市五股區新北產業園區五工路 134 號

台灣檢驗科技股份有限公司

t (886-2) 2299-3279

f (886-2) 2298-0488

www.tw.sgs.com

Member of SGS Group

Radar Type 5 for 802.11ac80 5530 MHz

Waveform Num = 1
Num of Bursts = 17
Burst Interval (us) = 705882

Burst #	OffTime (us)	# Pulses	Chirp (MHz)	PW (us)	Pulse1 Pri(us)	Pulse2 Pri(us)	Pulse3 Pri(us)	StartLoc (us)	StartBurst Interval(us)	EndBurst Interval(us)
1	117619	1	5	80	1044	0	0	117619	0	705881
2	590029	1	14	50	1481	0	0	708692	705882	1411763
3	931652	3	18	50	1078	1463	1334	1641825	1411764	2117645
4	945901	2	19	80	1372	1310	0	2591601	2117646	2823527
5	557558	2	5	65	1725	1211	0	3151841	2823528	3529409
6	466925	2	9	100	1723	1832	0	3621702	3529410	4235291
7	616622	3	17	85	1473	1317	1847	4241879	4235292	4941173
8	730497	2	17	75	1054	1379	0	4977013	4941174	5647055
9	861490	3	8	50	1586	1848	1329	5840936	5647056	6352937
10	728419	3	10	90	1788	1079	1695	6574118	6352938	7058819
11	885999	1	13	50	1059	0	0	7464679	7058820	7764701
12	351248	1	6	70	1604	0	0	7816986	7764702	8470583
13	1166567	1	13	90	1862	0	0	8985157	8470584	9176465
14	799932	1	12	75	1388	0	0	9786951	9176466	9882347
15	233595	3	15	70	1315	1225	1130	10021934	9882348	10588229
16	1255510	2	18	55	1617	1306	0	11281114	10588230	11294111
17	667143	1	17	75	1581	0	0	11951180	11294112	11999993
0	number	0	0	0	0	0	0	0	0	0
0	0	0	0	0	0	0	0	0	0	0
0	0	0	0	0	0	0	0	0	0	0
Total	number	of	pulses	in	waveform	=	32			

Radar Type 5 for 802.11ac80 5530 MHz

Waveform Num = 2
Num of Bursts = 9
Burst Interval (us) = 1333333

Burst #	OffTime (us)	# Pulses	Chirp (MHz)	PW (us)	Pulse1 Pri(us)	Pulse2 Pri(us)	Pulse3 Pri(us)	StartLoc (us)	StartBurst Interval(us)	EndBurst Interval(us)
1	805895	3	10	55	1048	1378	1426	805895	0	1333332
2	984878	3	5	50	1211	1110	1882	1794625	1333333	2666665
3	1320173	1	9	65	1961	0	0	3119001	2666666	3999998
4	1190069	1	20	75	1896	0	0	4311031	3999999	5333331
5	1122118	3	19	100	1963	1252	1453	5435045	5333332	6666664
6	2162128	1	16	90	1607	0	0	7601841	6666665	7999997
7	1513928	1	8	100	1564	0	0	9117376	7999998	9333330
8	1249570	1	15	55	1822	0	0	10368510	9333331	10666663
9	1140037	1	16	65	1454	0	0	11510369	10666664	11999996
Total	number	of	pulses	in	waveform	=	15			

Unless otherwise stated the results shown in this test report refer only to the sample(s) tested and such sample(s) are retained for 90 days only.

除非另有說明，此報告結果僅對測試之樣品負責，同時此樣品僅保留90天。本報告未經本公司書面許可，不可部份複製。

This document is issued by the Company subject to its General Conditions of Service printed overleaf, available on request or accessible at www.sgs.com/terms_and_conditions.htm and, for electronic format documents, subject to Terms and Conditions for Electronic Documents at www.sgs.com/terms_e-document.htm. Attention is drawn to the limitation of liability, indemnification and jurisdiction issues defined therein. Any holder of this document is advised that information contained hereon reflects the Company's findings at the time of its intervention only and within the limits of Client's instructions, if any. The Company's sole responsibility is to its Client and this document does not exonerate parties to a transaction from exercising all their rights and obligations under the transaction documents. This document cannot be reproduced except in full, without prior written approval of the Company. Any unauthorized alteration, forgery or falsification of the content or appearance of this document is unlawful and offenders may be prosecuted to the fullest extent of the law.

SGS Taiwan Ltd.

No.134,WuKungRoad,NewTaipeiIndustrialPark,WukuDistrict,NewTaipeiCity,Taiwan24803/新北市五股區新北產業園區五工路 134 號

台灣檢驗科技股份有限公司

t (886-2) 2299-3279

f (886-2) 2298-0488

www.tw.sgs.com

Member of SGS Group

Radar Type 5 for 802.11ac80 5530 MHz

Waveform Num =		3								
Num of Bursts =		8								
Burst Interval (us) =		1500000								
Burst #	OffTime (us)	# Pulses	Chirp (MHz)	PW (us)	Pulse1 Pri(us)	Pulse2 Pri(us)	Pulse3 Pri(us)	StartLoc (us)	StartBurst Interval(us)	EndBurst Interval(us)
1	1485501	3	13	80	1196	1699	1422	1485501	0	1499999
2	493171	3	5	85	1639	1894	1586	1982989	1500000	2999999
3	1417431	1	12	55	1024	0	0	3405539	3000000	4499999
4	1486923	2	9	50	1103	1375	0	4893486	4500000	5999999
5	2506338	3	15	90	1212	1681	1323	7402302	6000000	7499999
6	120119	2	9	70	1602	1991	0	7526637	7500000	8999999
7	2571130	3	14	95	1395	1083	1701	10101360	9000000	10499999
8	791330	1	17	50	1694	0	0	10896869	10500000	11999999
Total	number	of	pulses	in	waveform	=	18			

Radar Type 5 for 802.11ac80 5530 MHz

Waveform Num =		4								
Num of Bursts =		17								
Burst Interval (us) =		705882								
Burst #	OffTime (us)	# Pulses	Chirp (MHz)	PW (us)	Pulse1 Pri(us)	Pulse2 Pri(us)	Pulse3 Pri(us)	StartLoc (us)	StartBurst Interval(us)	EndBurst Interval(us)
1	350463	3	5	65	1456	1960	1582	350463	0	705881
2	674118	3	9	75	1249	1299	1965	1029579	705882	1411763
3	1062080	3	10	60	1079	1002	1084	2096172	1411764	2117645
4	619286	3	18	80	1861	1235	1724	2718623	2117646	2823527
5	449764	2	7	55	1480	1229	0	3173207	2823528	3529409
6	950531	1	10	65	1133	0	0	4126447	3529410	4235291
7	376824	3	12	100	2000	1574	1566	4504404	4235292	4941173
8	839650	3	16	65	1843	1685	1127	5349194	4941174	5647055
9	916588	3	13	75	1673	1872	1597	6270437	5647056	6352937
10	176081	1	7	80	1828	0	0	6451660	6352938	7058819
11	761363	3	16	70	1527	1462	1114	7214851	7058820	7764701
12	1005090	2	10	65	1497	1469	0	8224044	7764702	8470583
13	396014	3	17	90	1707	1314	1577	8623024	8470584	9176465
14	785604	3	5	75	1719	1055	1080	9413226	9176466	9882347
15	737674	1	11	80	1814	0	0	10154754	9882348	10588229
16	1104856	2	15	55	1954	1348	0	11261424	10588230	11294111
17	453269	1	5	95	1257	0	0	11717995	11294112	11999993
Total	number	of	pulses	in	waveform	=	40			

Unless otherwise stated the results shown in this test report refer only to the sample(s) tested and such sample(s) are retained for 90 days only.

除非另有說明，此報告結果僅對測試之樣品負責，同時此樣品僅保留90天。本報告未經本公司書面許可，不可部份複製。

This document is issued by the Company subject to its General Conditions of Service printed overleaf, available on request or accessible at www.sgs.com/terms_and_conditions.htm and, for electronic format documents, subject to Terms and Conditions for Electronic Documents at www.sgs.com/terms_e-document.htm. Attention is drawn to the limitation of liability, indemnification and jurisdiction issues defined therein. Any holder of this document is advised that information contained hereon reflects the Company's findings at the time of its intervention only and within the limits of Client's instructions, if any. The Company's sole responsibility is to its Client and this document does not exonerate parties to a transaction from exercising all their rights and obligations under the transaction documents. This document cannot be reproduced except in full, without prior written approval of the Company. Any unauthorized alteration, forgery or falsification of the content or appearance of this document is unlawful and offenders may be prosecuted to the fullest extent of the law.

SGS Taiwan Ltd.

No.134,WuKungRoad,NewTaipeiIndustrialPark,WukuDistrict,NewTaipeiCity,Taiwan24803/新北市五股區新北產業園區五工路 134 號

台灣檢驗科技股份有限公司

t (886-2) 2299-3279

f (886-2) 2298-0488

www.tw.sgs.com

Member of SGS Group

Radar Type 5 for 802.11ac80 5530 MHz

Waveform Num =	5									
Num of Bursts =	10									
Burst Interval (us) =	1200000									
Burst #	OffTime (us)	# Pulses	Chirp (MHz)	PW (us)	Pulse1 Pri(us)	Pulse2 Pri(us)	Pulse3 Pri(us)	StartLoc (us)	StartBurst Interval(us)	EndBurst Interval(us)
1	1058808	2	15	50	1722	1937	0	1058808	0	1199999
2	395238	1	20	100	1692	0	0	1457705	1200000	2399999
3	1020416	3	16	70	1445	1284	1354	2479813	2400000	3599999
4	1842047	1	15	70	1632	0	0	4325943	3600000	4799999
5	1619053	3	9	70	1225	1971	1969	5946628	4800000	5999999
6	867341	3	7	60	1633	1722	1856	6819134	6000000	7199999
7	423359	1	15	80	1349	0	0	7247704	7200000	8399999
8	1811663	3	7	75	1002	1079	1133	9060716	8400000	9599999
9	1110718	1	9	50	1503	0	0	10174648	9600000	10799999
10	1074387	2	14	65	1447	1997	0	11250538	10800000	11999999
Total	number	of	pulses	in	waveform	=	20			

Radar Type 5 for 802.11ac80 5530 MHz

Waveform Num =	6									
Num of Bursts =	18									
Burst Interval (us) =	666667									

Burst #	OffTime (us)	# Pulses	Chirp (MHz)	PW (us)	Pulse1 Pri(us)	Pulse2 Pri(us)	Pulse3 Pri(us)	StartLoc (us)	StartBurst Interval(us)	EndBurst Interval(us)
1	268270	3	5	95	1574	1248	1039	268270	0	666666
2	827428	2	7	55	1654	1120	0	1099559	666667	1333333
3	796515	1	10	55	1915	0	0	1898848	1333334	2000000
4	275158	1	15	55	1915	0	0	2175921	2000001	2666667
5	781021	2	15	85	1559	1464	0	2958857	2666668	3333334
6	521934	2	8	65	1860	1445	0	3483814	3333335	4000001
7	517992	3	13	65	1320	1437	1501	4005111	4000002	4666668
8	938330	2	5	95	1630	1621	0	4947699	4666669	5333335
9	841969	2	11	100	1045	1265	0	5792919	5333336	6000002
10	743598	2	5	85	1498	1045	0	6538827	6000003	6666669
11	658614	3	5	75	1762	1506	1544	7199984	6666670	7333336
12	298567	1	13	85	1347	0	0	7503363	7333337	8000003
13	1027336	2	14	75	1071	1958	0	8532046	8000004	8666670
14	524010	3	19	80	1995	1612	1442	9059085	8666671	9333337
15	924480	1	14	60	1925	0	0	9988614	9333338	10000004
16	67378	3	9	65	1535	1393	1647	10057917	10000005	10666671
17	821642	1	9	75	1142	0	0	10884134	10666672	11333338
18	637611	2	13	55	1678	1196	0	11522887	11333339	12000005
Total	number	of	pulses	in	waveform	=	36			

Unless otherwise stated the results shown in this test report refer only to the sample(s) tested and such sample(s) are retained for 90 days only.

除非另有說明，此報告結果僅對測試之樣品負責，同時此樣品僅保留90天。本報告未經本公司書面許可，不可部份複製。

This document is issued by the Company subject to its General Conditions of Service printed overleaf, available on request or accessible at www.sgs.com/terms_and_conditions.htm and, for electronic format documents, subject to Terms and Conditions for Electronic Documents at www.sgs.com/terms_e-document.htm. Attention is drawn to the limitation of liability, indemnification and jurisdiction issues defined therein. Any holder of this document is advised that information contained hereon reflects the Company's findings at the time of its intervention only and within the limits of Client's instructions, if any. The Company's sole responsibility is to its Client and this document does not exonerate parties to a transaction from exercising all their rights and obligations under the transaction documents. This document cannot be reproduced except in full, without prior written approval of the Company. Any unauthorized alteration, forgery or falsification of the content or appearance of this document is unlawful and offenders may be prosecuted to the fullest extent of the law.

SGS Taiwan Ltd.

No.134,WuKungRoad,NewTaipeiIndustrialPark,WukuDistrict,NewTaipeiCity,Taiwan24803/新北市五股區新北產業園區五工路 134 號

台灣檢驗科技股份有限公司

t (886-2) 2299-3279

f (886-2) 2298-0488

www.tw.sgs.com

Member of SGS Group

Radar Type 5 for 802.11ac80 5530 MHz

Waveform Num =	7
Num of Bursts =	11
Burst Interval (us) =	1090909

Burst #	OffTime (us)	# Pulses	Chirp (MHz)	PW (us)	Pulse1 Pri(us)	Pulse2 Pri(us)	Pulse3 Pri(us)	StartLoc (us)	StartBurst Interval(us)	EndBurst Interval(us)
1	386353	3	18	100	1574	1671	1446	386353	0	1090908
2	1463749	2	18	60	1064	1444	0	1854793	1090909	2181817
3	391737	3	16	85	1764	1785	1229	2249038	2181818	3272726
4	1986524	1	5	90	1578	0	0	4240340	3272727	4363635
5	390850	2	8	75	1762	1744	0	4632768	4363636	5454544
6	1757218	1	13	80	1533	0	0	6393492	5454545	6545453
7	672439	2	5	80	1039	1507	0	7067464	6545454	7636362
8	1425996	3	11	75	1441	1715	1996	8496006	7636363	8727271
9	881648	3	15	75	1411	1447	1688	9382806	8727272	9818180
10	1373827	3	7	75	1810	1791	1097	10761179	9818181	10909089
11	1068899	1	10	80	1658	0	0	11834776	10909090	11999998
Total	number	of	pulses	in	waveform	=	24			

Radar Type 5 for 802.11ac80 5530 MHz

Waveform Num =	8
Num of Bursts =	20
Burst Interval (us) =	600000

Burst #	OffTime (us)	# Pulses	Chirp (MHz)	PW (us)	Pulse1 Pri(us)	Pulse2 Pri(us)	Pulse3 Pri(us)	StartLoc (us)	StartBurst Interval(us)	EndBurst Interval(us)
1	294521	3	17	70	1091	1868	1283	294521	0	599999
2	331519	2	6	50	1825	1484	0	630282	600000	1199999
3	1144287	1	6	65	1493	0	0	1777878	1200000	1799999
4	50716	2	18	100	1778	1815	0	1830087	1800000	2399999
5	1029210	2	7	95	1662	1848	0	2862890	2400000	2999999
6	305759	1	7	85	1348	0	0	3172159	3000000	3599999
7	803672	3	9	100	1332	1144	1272	3977179	3600000	4199999
8	260293	1	12	85	1917	0	0	4241220	4200000	4799999
9	750855	3	10	50	1296	1122	1481	4993992	4800000	5399999
10	479616	3	15	75	1239	1072	1599	5477507	5400000	5999999
11	763047	2	12	90	1551	1564	0	6244464	6000000	6599999
12	887170	1	8	75	1909	0	0	7134749	6600000	7199999
13	226211	2	20	50	1180	1153	0	7362869	7200000	7799999
14	796509	2	6	95	1404	1742	0	8161711	7800000	8399999
15	318464	2	12	50	1244	1037	0	8483321	8400000	8999999
16	756164	1	12	95	1371	0	0	9241766	9000000	9599999
17	601894	3	19	75	1657	1367	1768	9845031	9600000	10199999
18	942569	2	12	85	1189	1749	0	10792392	10200000	10799999
19	460449	3	17	90	1990	1704	1943	11255779	10800000	11399999
20	544413	2	10	90	1265	1511	0	11805829	11400000	11999999
Total	number	of	pulses	in	waveform	=	41			

Unless otherwise stated the results shown in this test report refer only to the sample(s) tested and such sample(s) are retained for 90 days only.

除非另有說明，此報告結果僅對測試之樣品負責，同時此樣品僅保留90天。本報告未經本公司書面許可，不可部份複製。

This document is issued by the Company subject to its General Conditions of Service printed overleaf, available on request or accessible at www.sgs.com/terms_and_conditions.htm and, for electronic format documents, subject to Terms and Conditions for Electronic Documents at www.sgs.com/terms_e-document.htm. Attention is drawn to the limitation of liability, indemnification and jurisdiction issues defined therein. Any holder of this document is advised that information contained hereon reflects the Company's findings at the time of its intervention only and within the limits of Client's instructions, if any. The Company's sole responsibility is to its Client and this document does not exonerate parties to a transaction from exercising all their rights and obligations under the transaction documents. This document cannot be reproduced except in full, without prior written approval of the Company. Any unauthorized alteration, forgery or falsification of the content or appearance of this document is unlawful and offenders may be prosecuted to the fullest extent of the law.

SGS Taiwan Ltd.

No.134,WuKungRoad,NewTaipeiIndustrialPark,WukuDistrict,NewTaipeiCity,Taiwan24803/新北市五股區新北產業園區五工路 134 號

台灣檢驗科技股份有限公司

t (886-2) 2299-3279

f (886-2) 2298-0488

www.tw.sgs.com

Member of SGS Group

Radar Type 5 for 802.11ac80 5530 MHz

Waveform Num =	9
Num of Bursts =	16
Burst Interval (us) =	750000

Burst #	OffTime (us)	# Pulses	Chirp (MHz)	PW (us)	Pulse1 Pri(us)	Pulse2 Pri(us)	Pulse3 Pri(us)	StartLoc (us)	StartBurst Interval(us)	EndBurst Interval(us)
1	244661	1	6	85	1037	0	0	244661	0	749999
2	1009641	1	18	90	1724	0	0	1255339	750000	1499999
3	540807	1	10	50	1605	0	0	1797870	1500000	2249999
4	678935	3	8	50	1754	1712	1455	2478410	2250000	2999999
5	994594	3	7	80	1834	1759	1255	3477925	3000000	3749999
6	915290	3	14	100	1299	1636	1872	4398063	3750000	4499999
7	620345	2	20	95	1089	1198	0	5023215	4500000	5249999
8	717551	3	15	55	1496	1037	1877	5743053	5250000	5999999
9	550747	2	11	65	1840	1446	0	6298210	6000000	6749999
10	549034	2	8	70	1247	1941	0	6850530	6750000	7499999
11	762463	3	19	60	1071	1954	1013	7616181	7500000	8249999
12	960203	2	10	70	1239	1516	0	8580422	8250000	8999999
13	1126767	2	18	80	1548	1448	0	9709944	9000000	9749999
14	459525	2	13	80	1667	1313	0	10172465	9750000	10499999
15	588359	2	12	55	1389	1910	0	10763804	10500000	11249999
16	665124	3	14	65	1379	1243	1325	11432227	11250000	11999999
Total	number	of	pulses	in	waveform	=	35			

Radar Type 5 for 802.11ac80 5530 MHz

Waveform Num =	10
Num of Bursts =	12
Burst Interval (us) =	1000000

Burst #	OffTime (us)	# Pulses	Chirp (MHz)	PW (us)	Pulse1 Pri(us)	Pulse2 Pri(us)	Pulse3 Pri(us)	StartLoc (us)	StartBurst Interval(us)	EndBurst Interval(us)
1	686873	3	5	80	1288	1793	1343	686873	0	999999
2	639337	1	9	80	1350	0	0	1330634	1000000	1999999
3	685538	1	13	55	1980	0	0	2017522	2000000	2999999
4	1024387	2	10	70	1432	1491	0	3043889	3000000	3999999
5	1003170	2	17	70	1536	1897	0	4049982	4000000	4999999
6	1116926	3	5	70	1200	1965	1035	5170341	5000000	5999999
7	1735933	2	15	50	1688	1140	0	6910474	6000000	6999999
8	907771	2	5	80	1326	1010	0	7821073	7000000	7999999
9	750315	2	8	55	1227	1845	0	8573724	8000000	8999999
10	429968	3	8	70	1631	1486	1980	9006764	9000000	9999999
11	1427489	2	10	100	1134	1330	0	10439350	10000000	10999999
12	659306	2	6	50	1539	1342	0	11101120	11000000	11999999
Total	number	of	pulses	in	waveform	=	25			

Unless otherwise stated the results shown in this test report refer only to the sample(s) tested and such sample(s) are retained for 90 days only.

除非另有說明，此報告結果僅對測試之樣品負責，同時此樣品僅保留90天。本報告未經本公司書面許可，不可部份複製。

This document is issued by the Company subject to its General Conditions of Service printed overleaf, available on request or accessible at www.sgs.com/terms_and_conditions.htm and, for electronic format documents, subject to Terms and Conditions for Electronic Documents at www.sgs.com/terms_e-document.htm. Attention is drawn to the limitation of liability, indemnification and jurisdiction issues defined therein. Any holder of this document is advised that information contained hereon reflects the Company's findings at the time of its intervention only and within the limits of Client's instructions, if any. The Company's sole responsibility is to its Client and this document does not exonerate parties to a transaction from exercising all their rights and obligations under the transaction documents. This document cannot be reproduced except in full, without prior written approval of the Company. Any unauthorized alteration, forgery or falsification of the content or appearance of this document is unlawful and offenders may be prosecuted to the fullest extent of the law.

SGS Taiwan Ltd.

No.134,WuKungRoad,NewTaipeiIndustrialPark,WukuDistrict,NewTaipeiCity,Taiwan24803/新北市五股區新北產業園區五工路 134 號

台灣檢驗科技股份有限公司

t (886-2) 2299-3279

f (886-2) 2298-0488

www.tw.sgs.com

Member of SGS Group

Radar Type 5 for 802.11ac80 5530 MHz

Waveform Num =		11								
Num of Bursts =		15								
Burst Interval (us) =		800000								
Burst #	OffTime (us)	# Pulses	Chirp (MHz)	PW (us)	Pulse1 Pri(us)	Pulse2 Pri(us)	Pulse3 Pri(us)	StartLoc (us)	StartBurst Interval(us)	EndBurst Interval(us)
1	171103	1	10	65	1311	0	0	171103	0	799999
2	878778	1	18	100	1432	0	0	1051192	800000	1599999
3	1316827	3	6	70	1231	1754	1709	2369451	1600000	2399999
4	604945	3	19	75	1465	1078	1732	2979090	2400000	3199999
5	914273	2	13	65	1345	1119	0	3897638	3200000	3999999
6	153774	2	6	75	1420	1453	0	4053876	4000000	4799999
7	1358602	3	19	90	1558	1840	1384	5415351	4800000	5599999
8	427408	3	20	55	1328	1136	1234	5847541	5600000	6399999
9	1115407	1	18	95	1450	0	0	6966646	6400000	7199999
10	898091	2	6	70	1528	1362	0	7866187	7200000	7999999
11	389606	2	18	80	1211	1651	0	8258683	8000000	8799999
12	882813	3	17	85	1316	1888	1336	9144358	8800000	9599999
13	512215	1	7	95	1396	0	0	9661113	9600000	10399999
14	833938	1	14	100	1536	0	0	10496447	10400000	11199999
15	1424817	3	19	90	1270	1903	1600	11922800	11200000	11999999
Total	number	of	pulses	in	waveform	=	31			

Radar Type 5 for 802.11ac80 5530 MHz

Waveform Num =		12								
Num of Bursts =		13								
Burst Interval (us) =		923077								
Burst #	OffTime (us)	# Pulses	Chirp (MHz)	PW (us)	Pulse1 Pri(us)	Pulse2 Pri(us)	Pulse3 Pri(us)	StartLoc (us)	StartBurst Interval(us)	EndBurst Interval(us)
1	560801	1	6	75	1780	0	0	560801	0	923076
2	770295	2	10	55	1377	1831	0	1332876	923077	1846153
3	679045	2	9	85	1228	1909	0	2015129	1846154	2769230
4	1640074	2	6	55	1347	1747	0	3658340	2769231	3692307
5	745521	3	6	65	1173	1386	1563	4406955	3692308	4615384
6	829240	1	17	55	1246	0	0	5240317	4615385	5538461
7	533928	3	13	80	1569	1753	1558	5775491	5538462	6461538
8	1483667	1	15	55	1879	0	0	7264038	6461539	7384615
9	188359	2	6	80	1750	1186	0	7454276	7384616	8307692
10	893330	3	19	100	1637	1224	1741	8350542	8307693	9230769
11	1244829	2	8	60	1355	1547	0	9599973	9230770	10153846
12	862739	3	12	60	1380	1932	1245	10465614	10153847	11076923
13	869745	1	20	75	1593	0	0	11339916	11076924	12000000
Total	number	of	pulses	in	waveform	=	26			

Unless otherwise stated the results shown in this test report refer only to the sample(s) tested and such sample(s) are retained for 90 days only.

除非另有說明，此報告結果僅對測試之樣品負責，同時此樣品僅保留90天。本報告未經本公司書面許可，不可部份複製。

This document is issued by the Company subject to its General Conditions of Service printed overleaf, available on request or accessible at www.sgs.com/terms_and_conditions.htm and, for electronic format documents, subject to Terms and Conditions for Electronic Documents at www.sgs.com/terms_e-document.htm. Attention is drawn to the limitation of liability, indemnification and jurisdiction issues defined therein. Any holder of this document is advised that information contained hereon reflects the Company's findings at the time of its intervention only and within the limits of Client's instructions, if any. The Company's sole responsibility is to its Client and this document does not exonerate parties to a transaction from exercising all their rights and obligations under the transaction documents. This document cannot be reproduced except in full, without prior written approval of the Company. Any unauthorized alteration, forgery or falsification of the content or appearance of this document is unlawful and offenders may be prosecuted to the fullest extent of the law.

SGS Taiwan Ltd.

No.134,WuKungRoad,NewTaipeiIndustrialPark,WukuDistrict,NewTaipeiCity,Taiwan24803/新北市五股區新北產業園區五工路 134 號

台灣檢驗科技股份有限公司

t (886-2) 2299-3279

f (886-2) 2298-0488

www.tw.sgs.com

Member of SGS Group

Radar Type 5 for 802.11ac80 5530 MHz

Waveform Num =		13								
Num of Bursts =		19								
Burst Interval (us) =		631579								
Burst #	OffTime (us)	# Pulses	Chirp (MHz)	PW (us)	Pulse1 Pri(us)	Pulse2 Pri(us)	Pulse3 Pri(us)	StartLoc (us)	StartBurst Interval(us)	EndBurst Interval(us)
1	319496	3	20	85	1811	1082	1146	319496	0	631578
2	471469	1	12	75	1007	0	0	795004	631579	1263157
3	892091	3	17	95	1828	1344	1184	1688102	1263158	1894736
4	399913	2	10	75	1141	1612	0	2092371	1894737	2526315
5	665293	3	17	50	1169	1627	1342	2760417	2526316	3157894
6	822312	2	16	80	1236	1355	0	3586867	3157895	3789473
7	735693	3	11	70	1450	1257	1223	4325151	3789474	4421052
8	718679	1	5	95	1973	0	0	5047760	4421053	5052631
9	595973	1	12	100	1044	0	0	5645706	5052632	5684210
10	656521	2	15	75	1405	1979	0	6303271	5684211	6315789
11	96838	3	12	100	1074	1633	1413	6403493	6315790	6947368
12	667332	2	5	50	1271	1424	0	7074945	6947369	7578947
13	817381	2	19	95	1942	1181	0	7895021	7578948	8210526
14	401194	1	13	80	1530	0	0	8299338	8210527	8842105
15	619917	1	19	55	1129	0	0	8920785	8842106	9473684
16	954286	2	18	50	1325	1249	0	9876200	9473685	10105263
17	671545	3	19	65	1052	1757	1936	10550319	10105264	10736842
18	476429	3	13	50	1427	1889	1329	11031493	10736843	11368421
19	468407	3	16	85	1146	1268	1396	11504545	11368422	12000000
Total	number	of	pulses	in	waveform	=	41			

Unless otherwise stated the results shown in this test report refer only to the sample(s) tested and such sample(s) are retained for 90 days only.

除非另有說明，此報告結果僅對測試之樣品負責，同時此樣品僅保留90天。本報告未經本公司書面許可，不可部份複製。

This document is issued by the Company subject to its General Conditions of Service printed overleaf, available on request or accessible at www.sgs.com/terms_and_conditions.htm and, for electronic format documents, subject to Terms and Conditions for Electronic Documents at www.sgs.com/terms_e-document.htm. Attention is drawn to the limitation of liability, indemnification and jurisdiction issues defined therein. Any holder of this document is advised that information contained hereon reflects the Company's findings at the time of its intervention only and within the limits of Client's instructions, if any. The Company's sole responsibility is to its Client and this document does not exonerate parties to a transaction from exercising all their rights and obligations under the transaction documents. This document cannot be reproduced except in full, without prior written approval of the Company. Any unauthorized alteration, forgery or falsification of the content or appearance of this document is unlawful and offenders may be prosecuted to the fullest extent of the law.

SGS Taiwan Ltd.

No.134,WuKungRoad,NewTaipeiIndustrialPark,WukuDistrict,NewTaipeiCity,Taiwan24803/新北市五股區新北產業園區五工路 134 號

台灣檢驗科技股份有限公司

t (886-2) 2299-3279

f (886-2) 2298-0488

www.tw.sgs.com

Member of SGS Group

Radar Type 5 for 802.11ac80 5530 MHz

Waveform Num =		14								
Num of Bursts =		18								
Burst Interval (us) =		666667								
Burst #	OffTime (us)	# Pulses	Chirp (MHz)	PW (us)	Pulse1 Pri(us)	Pulse2 Pri(us)	Pulse3 Pri(us)	StartLoc (us)	StartBurst Interval(us)	EndBurst Interval(us)
1	74941	3	12	75	1774	1915	1359	74941	0	666666
2	930381	2	12	85	1755	1094	0	1010370	666667	1333333
3	415474	2	7	85	1668	1684	0	1428693	1333334	2000000
4	766667	1	5	100	1228	0	0	2198712	2000001	2666667
5	994392	3	15	85	1492	1561	1527	3194332	2666668	3333334
6	719654	2	11	60	1093	1609	0	3918566	3333335	4000001
7	706521	1	9	65	1222	0	0	4627789	4000002	4666668
8	358198	1	15	55	1775	0	0	4987209	4666669	5333335
9	921321	1	10	95	1124	0	0	5910305	5333336	6000002
10	724491	1	15	50	1159	0	0	6635920	6000003	6666669
11	581400	3	17	50	1896	1800	1152	7218479	6666670	7333336
12	552451	3	13	60	1983	1483	1082	7775778	7333337	8000003
13	577306	3	12	55	1847	1214	1976	8357632	8000004	8666670
14	495507	3	7	60	1576	1628	1239	8858176	8666671	9333337
15	580112	3	10	50	1388	1593	1698	9442731	9333338	10000004
16	850831	2	8	70	1811	1637	0	10298241	10000005	10666671
17	863075	3	7	95	1992	1675	1468	11164764	10666672	11333338
18	219582	2	19	50	1309	1190	0	11389481	11333339	12000005
Total	number	of	pulses	in	waveform	=	39			

Unless otherwise stated the results shown in this test report refer only to the sample(s) tested and such sample(s) are retained for 90 days only.

除非另有說明，此報告結果僅對測試之樣品負責，同時此樣品僅保留90天。本報告未經本公司書面許可，不可部份複製。

This document is issued by the Company subject to its General Conditions of Service printed overleaf, available on request or accessible at www.sgs.com/terms_and_conditions.htm and, for electronic format documents, subject to Terms and Conditions for Electronic Documents at www.sgs.com/terms_e-document.htm. Attention is drawn to the limitation of liability, indemnification and jurisdiction issues defined therein. Any holder of this document is advised that information contained hereon reflects the Company's findings at the time of its intervention only and within the limits of Client's instructions, if any. The Company's sole responsibility is to its Client and this document does not exonerate parties to a transaction from exercising all their rights and obligations under the transaction documents. This document cannot be reproduced except in full, without prior written approval of the Company. Any unauthorized alteration, forgery or falsification of the content or appearance of this document is unlawful and offenders may be prosecuted to the fullest extent of the law.

SGS Taiwan Ltd.

No.134,WuKungRoad,NewTaipeiIndustrialPark,WukuDistrict,NewTaipeiCity,Taiwan24803/新北市五股區新北產業園區五工路 134 號

台灣檢驗科技股份有限公司

t (886-2) 2299-3279

f (886-2) 2298-0488

www.tw.sgs.com

Member of SGS Group

Radar Type 5 for 802.11ac80 5530 MHz

Waveform Num =		15								
Num of Bursts =		15								
Burst Interval (us) =		800000								
Burst #	OffTime (us)	# Pulses	Chirp (MHz)	PW (us)	Pulse1 Pri(us)	Pulse2 Pri(us)	Pulse3 Pri(us)	StartLoc (us)	StartBurst Interval(us)	EndBurst Interval(us)
1	761670	3	9	75	1902	1617	2000	761670	0	799999
2	351626	3	17	100	1982	1607	1409	1118815	800000	1599999
3	1028685	3	18	90	1116	1377	1882	2152498	1600000	2399999
4	880746	3	20	60	1474	1890	1147	3037619	2400000	3199999
5	480681	3	14	80	1972	1188	1693	3522811	3200000	3999999
6	711784	2	14	75	1123	1369	0	4239448	4000000	4799999
7	1082377	3	11	90	1590	1885	1387	5324317	4800000	5599999
8	281413	3	12	50	1350	1760	1109	5610592	5600000	6399999
9	1149137	2	8	60	1385	1660	0	6763948	6400000	7199999
10	489515	2	5	95	1383	1290	0	7256508	7200000	7999999
11	1443457	1	17	85	1425	0	0	8702638	8000000	8799999
12	558203	2	5	100	1893	1116	0	9262266	8800000	9599999
13	1117922	2	19	80	1067	1434	0	10383197	9600000	10399999
14	62501	2	12	70	1725	1580	0	10448199	10400000	11199999
15	1422009	1	7	80	1642	0	0	11873513	11200000	11999999
Total	number	of	pulses	in	waveform	=	35			

Radar Type 5 for 802.11ac80 5530 MHz

Waveform Num =		16								
Num of Bursts =		16								
Burst Interval (us) =		750000								
Burst #	OffTime (us)	# Pulses	Chirp (MHz)	PW (us)	Pulse1 Pri(us)	Pulse2 Pri(us)	Pulse3 Pri(us)	StartLoc (us)	StartBurst Interval(us)	EndBurst Interval(us)
1	52582	1	15	80	1356	0	0	52582	0	749999
2	753527	1	18	80	1763	0	0	807465	750000	1499999
3	1366388	3	5	90	1398	1438	1609	2175616	1500000	2249999
4	242943	2	10	70	1587	1894	0	2423004	2250000	2999999
5	889883	3	14	65	1887	1737	1857	3316368	3000000	3749999
6	559289	1	9	95	1941	0	0	3881138	3750000	4499999
7	625185	2	19	70	1263	1771	0	4508264	4500000	5249999
8	874722	3	11	80	1666	1470	1568	5386020	5250000	5999999
9	855205	1	5	95	1790	0	0	6245929	6000000	6749999
10	677231	2	8	70	1365	1768	0	6924950	6750000	7499999
11	727648	1	15	50	1168	0	0	7655731	7500000	8249999
12	1058342	3	6	65	1215	1530	1582	8715241	8250000	8999999
13	679138	2	10	90	1414	1332	0	9398706	9000000	9749999
14	937564	1	14	70	1012	0	0	10339016	9750000	10499999
15	840849	3	8	65	1746	1242	1151	11180877	10500000	11249999
16	296758	1	9	95	1318	0	0	11481774	11250000	11999999
Total	number	of	pulses	in	waveform	=	30			

Unless otherwise stated the results shown in this test report refer only to the sample(s) tested and such sample(s) are retained for 90 days only.

除非另有說明，此報告結果僅對測試之樣品負責，同時此樣品僅保留90天。本報告未經本公司書面許可，不可部份複製。

This document is issued by the Company subject to its General Conditions of Service printed overleaf, available on request or accessible at www.sgs.com/terms_and_conditions.htm and, for electronic format documents, subject to Terms and Conditions for Electronic Documents at www.sgs.com/terms_e-document.htm. Attention is drawn to the limitation of liability, indemnification and jurisdiction issues defined therein. Any holder of this document is advised that information contained hereon reflects the Company's findings at the time of its intervention only and within the limits of Client's instructions, if any. The Company's sole responsibility is to its Client and this document does not exonerate parties to a transaction from exercising all their rights and obligations under the transaction documents. This document cannot be reproduced except in full, without prior written approval of the Company. Any unauthorized alteration, forgery or falsification of the content or appearance of this document is unlawful and offenders may be prosecuted to the fullest extent of the law.

SGS Taiwan Ltd.

No.134,WuKungRoad,NewTaipeiIndustrialPark,WukuDistrict,NewTaipeiCity,Taiwan24803/新北市五股區新北產業園區五工路 134 號

台灣檢驗科技股份有限公司

t (886-2) 2299-3279

f (886-2) 2298-0488

www.tw.sgs.com

Member of SGS Group

Radar Type 5 for 802.11ac80 5530 MHz

Waveform Num = 17										
Num of Bursts = 15										
Burst Interval (us) = 800000										
Burst #	OffTime (us)	# Pulses	Chirp (MHz)	PW (us)	Pulse1 Pri(us)	Pulse2 Pri(us)	Pulse3 Pri(us)	StartLoc (us)	StartBurst Interval(us)	EndBurst Interval(us)
1	191189	1	18	75	1841	0	0	191189	0	799999
2	1223665	3	10	55	1606	1575	1478	1416695	800000	1599999
3	726312	2	7	85	1543	1520	0	2147666	1600000	2399999
4	428054	1	15	65	1977	0	0	2578783	2400000	3199999
5	1102151	2	15	70	1994	1994	0	3682911	3200000	3999999
6	695423	3	20	65	1865	1658	1153	4382322	4000000	4799999
7	617192	3	7	75	1188	1699	1305	5004190	4800000	5599999
8	1237862	2	5	75	1220	1994	0	6246244	5600000	6399999
9	254819	3	9	90	1129	1458	1218	6504277	6400000	7199999
10	1303319	2	20	100	1446	1610	0	7811401	7200000	7999999
11	301529	2	20	60	1782	1190	0	8115986	8000000	8799999
12	1089573	2	6	90	1264	1050	0	9208531	8800000	9599999
13	557754	3	6	70	1427	1400	1824	9768599	9600000	10399999
14	1067981	1	20	80	1799	0	0	10841231	10400000	11199999
15	1112055	2	18	80	1163	1234	0	11955085	11200000	11999999
Total	number	of	pulses	in	waveform	=	32			

Radar Type 5 for 802.11ac80 5530 MHz

Waveform Num = 18										
Num of Bursts = 11										
Burst Interval (us) = 1090909										
Burst #	OffTime (us)	# Pulses	Chirp (MHz)	PW (us)	Pulse1 Pri(us)	Pulse2 Pri(us)	Pulse3 Pri(us)	StartLoc (us)	StartBurst Interval(us)	EndBurst Interval(us)
1	397815	2	9	50	1627	1312	0	397815	0	1090908
2	1738199	1	18	55	1662	0	0	2138953	1090909	2181817
3	97442	2	11	60	1613	1479	0	2238057	2181818	3272726
4	1172347	1	13	75	1073	0	0	3413496	3272727	4363635
5	986477	3	13	85	1011	1288	1428	4401046	4363636	5454544
6	1411825	1	13	60	1039	0	0	5816598	5454545	6545453
7	1671631	3	11	80	1467	1285	1083	7489268	6545454	7636362
8	1170114	1	17	60	1084	0	0	8663217	7636363	8727271
9	729580	2	14	65	1718	1280	0	9393881	8727272	9818180
10	1192966	2	11	75	1589	1187	0	10589845	9818181	10909089
11	1235534	2	6	95	1257	1724	0	11828155	10909090	11999998
Total	number	of	pulses	in	waveform	=	20			

Unless otherwise stated the results shown in this test report refer only to the sample(s) tested and such sample(s) are retained for 90 days only.

除非另有說明，此報告結果僅對測試之樣品負責，同時此樣品僅保留90天。本報告未經本公司書面許可，不可部份複製。

This document is issued by the Company subject to its General Conditions of Service printed overleaf, available on request or accessible at www.sgs.com/terms_and_conditions.htm and, for electronic format documents, subject to Terms and Conditions for Electronic Documents at www.sgs.com/terms_e-document.htm. Attention is drawn to the limitation of liability, indemnification and jurisdiction issues defined therein. Any holder of this document is advised that information contained hereon reflects the Company's findings at the time of its intervention only and within the limits of Client's instructions, if any. The Company's sole responsibility is to its Client and this document does not exonerate parties to a transaction from exercising all their rights and obligations under the transaction documents. This document cannot be reproduced except in full, without prior written approval of the Company. Any unauthorized alteration, forgery or falsification of the content or appearance of this document is unlawful and offenders may be prosecuted to the fullest extent of the law.

SGS Taiwan Ltd.

No.134,WuKungRoad,NewTaipeiIndustrialPark,WukuDistrict,NewTaipeiCity,Taiwan24803/新北市五股區新北產業園區五工路 134 號

台灣檢驗科技股份有限公司

t (886-2) 2299-3279

f (886-2) 2298-0488

www.tw.sgs.com

Member of SGS Group

Radar Type 5 for 802.11ac80 5530 MHz

Waveform Num =		19								
Num of Bursts =		15								
Burst Interval (us) =		800000								
Burst #	OffTime (us)	# Pulses	Chirp (MHz)	PW (us)	Pulse1 Pri(us)	Pulse2 Pri(us)	Pulse3 Pri(us)	StartLoc (us)	StartBurst Interval(us)	EndBurst Interval(us)
1	293306	3	6	60	1188	1523	1488	293306	0	799999
2	1005541	2	17	90	1471	1418	0	1303046	800000	1599999
3	453554	1	8	95	1899	0	0	1759489	1600000	2399999
4	864902	2	6	50	1937	1706	0	2626290	2400000	3199999
5	838366	1	13	65	1584	0	0	3468299	3200000	3999999
6	622788	2	8	60	1129	1913	0	4092671	4000000	4799999
7	1384896	3	7	65	1418	1166	1369	5480609	4800000	5599999
8	217447	3	15	50	1361	1914	1713	5702009	5600000	6399999
9	1055104	3	10	95	1785	1710	1683	6762101	6400000	7199999
10	1159567	1	20	60	1008	0	0	7926846	7200000	7999999
11	857156	1	14	65	1604	0	0	8785010	8000000	8799999
12	710287	2	9	60	1168	1925	0	9496901	8800000	9599999
13	210421	2	10	55	1086	1317	0	9710415	9600000	10399999
14	696192	3	9	75	1348	1054	1230	10409010	10400000	11199999
15	1408253	1	18	70	1371	0	0	11820895	11200000	11999999
Total	number	of	pulses	in	waveform	=	30			

Radar Type 5 for 802.11ac80 5530 MHz

Waveform Num =		20								
Num of Bursts =		12								
Burst Interval (us) =		1000000								
Burst #	OffTime (us)	# Pulses	Chirp (MHz)	PW (us)	Pulse1 Pri(us)	Pulse2 Pri(us)	Pulse3 Pri(us)	StartLoc (us)	StartBurst Interval(us)	EndBurst Interval(us)
1	78491	3	11	55	1708	1450	1625	78491	0	999999
2	1781387	1	20	50	1108	0	0	1864661	1000000	1999999
3	630043	1	19	55	1578	0	0	2495812	2000000	2999999
4	1173372	1	14	60	1144	0	0	3670762	3000000	3999999
5	960174	2	20	60	1828	1081	0	4632080	4000000	4999999
6	571565	3	7	100	1611	1045	1669	5206554	5000000	5999999
7	1374401	3	5	55	1476	1925	1172	6585280	6000000	6999999
8	1248566	1	20	100	1638	0	0	7838419	7000000	7999999
9	450665	1	16	85	1723	0	0	8290722	8000000	8999999
10	716872	2	5	55	1272	1247	0	9009317	9000000	9999999
11	1101817	3	11	65	1914	1154	1667	10113653	10000000	10999999
12	1334371	3	6	95	1150	1418	1016	11452759	11000000	11999999
Total	number	of	pulses	in	waveform	=	24			

Unless otherwise stated the results shown in this test report refer only to the sample(s) tested and such sample(s) are retained for 90 days only.

除非另有說明，此報告結果僅對測試之樣品負責，同時此樣品僅保留90天。本報告未經本公司書面許可，不可部份複製。

This document is issued by the Company subject to its General Conditions of Service printed overleaf, available on request or accessible at www.sgs.com/terms_and_conditions.htm and, for electronic format documents, subject to Terms and Conditions for Electronic Documents at www.sgs.com/terms_e-document.htm. Attention is drawn to the limitation of liability, indemnification and jurisdiction issues defined therein. Any holder of this document is advised that information contained hereon reflects the Company's findings at the time of its intervention only and within the limits of Client's instructions, if any. The Company's sole responsibility is to its Client and this document does not exonerate parties to a transaction from exercising all their rights and obligations under the transaction documents. This document cannot be reproduced except in full, without prior written approval of the Company. Any unauthorized alteration, forgery or falsification of the content or appearance of this document is unlawful and offenders may be prosecuted to the fullest extent of the law.

SGS Taiwan Ltd.

No.134,WuKungRoad,NewTaipeiIndustrialPark,WukuDistrict,NewTaipeiCity,Taiwan24803/新北市五股區新北產業園區五工路 134 號

台灣檢驗科技股份有限公司

t (886-2) 2299-3279

f (886-2) 2298-0488

www.tw.sgs.com

Member of SGS Group

Radar Type 5 for 802.11ac80 5530 MHz

Waveform Num = 21										
Num of Bursts = 11										
Burst Interval (us) = 1090909										
Burst #	OffTime (us)	# Pulses	Chirp (MHz)	PW (us)	Pulse1 Pri(us)	Pulse2 Pri(us)	Pulse3 Pri(us)	StartLoc (us)	StartBurst Interval(us)	EndBurst Interval(us)
1	984674	1	17	55	1899	0	0	984674	0	1090908
2	721264	3	12	100	1617	1256	1980	1707837	1090909	2181817
3	530189	2	20	65	1370	1791	0	2242879	2181818	3272726
4	1846227	1	5	95	1671	0	0	4092267	3272727	4363635
5	966904	3	20	65	1400	1160	1132	5060842	4363636	5454544
6	564055	1	14	50	1875	0	0	5628589	5454545	6545453
7	1189217	2	8	65	1149	1974	0	6819681	6545454	7636362
8	1710154	2	16	75	1739	1307	0	8532958	7636363	8727271
9	780451	1	16	50	1728	0	0	9316455	8727272	9818180
10	721144	2	7	75	1575	1875	0	10039327	9818181	10909089
11	1858027	3	6	70	1481	1409	1225	11900804	10909090	11999998
Total	number	of	pulses	in	waveform	=	21			

Radar Type 5 for 802.11ac80 5530 MHz

Waveform Num = 22										
Num of Bursts = 14										
Burst Interval (us) = 857143										
Burst #	OffTime (us)	# Pulses	Chirp (MHz)	PW (us)	Pulse1 Pri(us)	Pulse2 Pri(us)	Pulse3 Pri(us)	StartLoc (us)	StartBurst Interval(us)	EndBurst Interval(us)
1	691603	2	16	75	1392	1361	0	691603	0	857142
2	372029	2	10	50	1644	1808	0	1066385	857143	1714285
3	796787	2	9	95	1234	1495	0	1866624	1714286	2571428
4	704057	2	17	55	1584	1562	0	2573410	2571429	3428571
5	1291585	3	17	55	1267	1748	1115	3868141	3428572	4285714
6	651325	3	20	80	1284	1753	1742	4523596	4285715	5142857
7	1407745	1	14	90	1753	0	0	5936120	5142858	6000000
8	405304	2	16	95	1496	1617	0	6343177	6000001	6857143
9	892368	1	18	85	1945	0	0	7238658	6857144	7714286
10	838838	1	5	80	1192	0	0	8079441	7714287	8571429
11	985176	2	19	55	1766	1182	0	9065809	8571430	9428572
12	1117336	1	7	65	1827	0	0	10186093	9428573	10285715
13	146836	3	13	85	1956	1015	1186	10334756	10285716	11142858
14	1147407	3	13	50	1493	1094	1188	11486320	11142859	12000001
Total	number	of	pulses	in	waveform	=	28			

Unless otherwise stated the results shown in this test report refer only to the sample(s) tested and such sample(s) are retained for 90 days only.

除非另有說明，此報告結果僅對測試之樣品負責，同時此樣品僅保留90天。本報告未經本公司書面許可，不可部份複製。

This document is issued by the Company subject to its General Conditions of Service printed overleaf, available on request or accessible at www.sgs.com/terms_and_conditions.htm and, for electronic format documents, subject to Terms and Conditions for Electronic Documents at www.sgs.com/terms_e-document.htm. Attention is drawn to the limitation of liability, indemnification and jurisdiction issues defined therein. Any holder of this document is advised that information contained hereon reflects the Company's findings at the time of its intervention only and within the limits of Client's instructions, if any. The Company's sole responsibility is to its Client and this document does not exonerate parties to a transaction from exercising all their rights and obligations under the transaction documents. This document cannot be reproduced except in full, without prior written approval of the Company. Any unauthorized alteration, forgery or falsification of the content or appearance of this document is unlawful and offenders may be prosecuted to the fullest extent of the law.

SGS Taiwan Ltd.

No.134,WuKungRoad,NewTaipeiIndustrialPark,WukuDistrict,NewTaipeiCity,Taiwan24803/新北市五股區新北產業園區五工路 134 號

台灣檢驗科技股份有限公司

t (886-2) 2299-3279

f (886-2) 2298-0488

www.tw.sgs.com

Member of SGS Group

Radar Type 5 for 802.11ac80 5530 MHz

Waveform Num =		23								
Num of Bursts =		17								
Burst Interval (us) =		705882								
Burst #	OffTime (us)	# Pulses	Chirp (MHz)	PW (us)	Pulse1 Pri(us)	Pulse2 Pri(us)	Pulse3 Pri(us)	StartLoc (us)	StartBurst Interval(us)	EndBurst Interval(us)
1	557402	3	12	85	1962	1857	1896	557402	0	705881
2	203671	2	20	90	1697	1483	0	766788	705882	1411763
3	825293	1	15	100	1714	0	0	1595261	1411764	2117645
4	1221956	2	18	95	1834	1970	0	2818931	2117646	2823527
5	533148	1	9	50	1033	0	0	3355883	2823528	3529409
6	435005	2	12	100	1968	1425	0	3791921	3529410	4235291
7	679556	1	11	70	1058	0	0	4474870	4235292	4941173
8	864225	2	8	85	1146	1050	0	5340153	4941174	5647055
9	880868	2	14	60	1537	1069	0	6223217	5647056	6352937
10	394574	1	5	95	1191	0	0	6620397	6352938	7058819
11	682359	3	5	95	1962	1996	1752	7303947	7058820	7764701
12	687631	2	12	60	1923	1510	0	7997288	7764702	8470583
13	907093	1	12	65	1836	0	0	8907814	8470584	9176465
14	793200	1	16	100	1290	0	0	9702850	9176466	9882347
15	360815	2	8	70	1191	1618	0	10064955	9882348	10588229
16	1104817	3	12	80	1636	1283	1145	11172581	10588230	11294111
17	646848	3	13	80	1123	1289	1786	11823493	11294112	11999993
Total	number	of	pulses	in	waveform	=	32			

Radar Type 5 for 802.11ac80 5530 MHz

Waveform Num =		24								
Num of Bursts =		12								
Burst Interval (us) =		1000000								
Burst #	OffTime (us)	# Pulses	Chirp (MHz)	PW (us)	Pulse1 Pri(us)	Pulse2 Pri(us)	Pulse3 Pri(us)	StartLoc (us)	StartBurst Interval(us)	EndBurst Interval(us)
1	19515	1	19	70	1740	0	0	19515	0	999999
2	1101539	2	9	70	1260	1225	0	1122794	1000000	1999999
3	1526943	3	19	80	1501	1551	1878	2652222	2000000	2999999
4	1328115	2	7	75	1707	1151	0	3985267	3000000	3999999
5	624905	3	5	65	1036	1309	1445	4613030	4000000	4999999
6	1042427	1	17	80	1680	0	0	5659247	5000000	5999999
7	643774	3	5	90	1759	1066	1152	6304701	6000000	6999999
8	905356	1	19	85	1286	0	0	7214034	7000000	7999999
9	1306239	3	20	55	1601	1938	1101	8521559	8000000	8999999
10	559562	1	9	95	1886	0	0	9085761	9000000	9999999
11	1267587	3	7	85	1626	1167	1243	10355234	10000000	10999999
12	1585278	3	15	50	1285	1048	1333	11944548	11000000	11999999
Total	number	of	pulses	in	waveform	=	26			

Unless otherwise stated the results shown in this test report refer only to the sample(s) tested and such sample(s) are retained for 90 days only.

除非另有說明，此報告結果僅對測試之樣品負責，同時此樣品僅保留90天。本報告未經本公司書面許可，不可部份複製。

This document is issued by the Company subject to its General Conditions of Service printed overleaf, available on request or accessible at www.sgs.com/terms_and_conditions.htm and, for electronic format documents, subject to Terms and Conditions for Electronic Documents at www.sgs.com/terms_e-document.htm. Attention is drawn to the limitation of liability, indemnification and jurisdiction issues defined therein. Any holder of this document is advised that information contained hereon reflects the Company's findings at the time of its intervention only and within the limits of Client's instructions, if any. The Company's sole responsibility is to its Client and this document does not exonerate parties to a transaction from exercising all their rights and obligations under the transaction documents. This document cannot be reproduced except in full, without prior written approval of the Company. Any unauthorized alteration, forgery or falsification of the content or appearance of this document is unlawful and offenders may be prosecuted to the fullest extent of the law.

SGS Taiwan Ltd.

No.134,WuKungRoad,NewTaipeiIndustrialPark,WukuDistrict,NewTaipeiCity,Taiwan24803/新北市五股區新北產業園區五工路 134 號

台灣檢驗科技股份有限公司

t (886-2) 2299-3279

f (886-2) 2298-0488

www.tw.sgs.com

Member of SGS Group

Radar Type 5 for 802.11ac80 5530 MHz

Waveform Num =		25								
Num of Bursts =		20								
Burst Interval (us) =		600000								
Burst #	OffTime (us)	# Pulses	Chirp (MHz)	PW (us)	Pulse1 Pri(us)	Pulse2 Pri(us)	Pulse3 Pri(us)	StartLoc (us)	StartBurst Interval(us)	EndBurst Interval(us)
1	182317	1	5	90	1136	0	0	182317	0	599999
2	680269	2	10	85	1096	1304	0	863722	600000	1199999
3	532951	1	7	75	1823	0	0	1399073	1200000	1799999
4	643024	1	17	95	1803	0	0	2043920	1800000	2399999
5	720185	1	6	80	1688	0	0	2765908	2400000	2999999
6	337687	1	12	55	1331	0	0	3105283	3000000	3599999
7	595308	3	8	55	1100	1541	1609	3701922	3600000	4199999
8	1057617	2	13	70	1487	1207	0	4763789	4200000	4799999
9	322347	3	10	90	1100	1039	1298	5088830	4800000	5399999
10	333093	2	13	60	1679	1977	0	5425360	5400000	5999999
11	777374	3	10	70	1676	1346	1226	6206390	6000000	6599999
12	791308	2	20	60	1998	1007	0	7001946	6600000	7199999
13	775616	3	14	70	1078	1996	1887	7780567	7200000	7799999
14	428353	2	12	95	1312	1021	0	8213881	7800000	8399999
15	476213	3	7	55	1687	1352	1714	8692427	8400000	8999999
16	368027	3	14	95	1665	1615	1143	9065207	9000000	9599999
17	936276	2	15	75	1406	1425	0	10005906	9600000	10199999
18	686251	2	11	95	1461	1046	0	10694988	10200000	10799999
19	440077	3	6	50	1331	1755	1117	11137572	10800000	11399999
20	322803	1	18	65	1237	0	0	11464578	11400000	11999999
Total	number	of	pulses	in	waveform	=	41			

Unless otherwise stated the results shown in this test report refer only to the sample(s) tested and such sample(s) are retained for 90 days only.

除非另有說明，此報告結果僅對測試之樣品負責，同時此樣品僅保留90天。本報告未經本公司書面許可，不可部份複製。

This document is issued by the Company subject to its General Conditions of Service printed overleaf, available on request or accessible at www.sgs.com/terms_and_conditions.htm and, for electronic format documents, subject to Terms and Conditions for Electronic Documents at www.sgs.com/terms_e-document.htm. Attention is drawn to the limitation of liability, indemnification and jurisdiction issues defined therein. Any holder of this document is advised that information contained hereon reflects the Company's findings at the time of its intervention only and within the limits of Client's instructions, if any. The Company's sole responsibility is to its Client and this document does not exonerate parties to a transaction from exercising all their rights and obligations under the transaction documents. This document cannot be reproduced except in full, without prior written approval of the Company. Any unauthorized alteration, forgery or falsification of the content or appearance of this document is unlawful and offenders may be prosecuted to the fullest extent of the law.

SGS Taiwan Ltd.

No.134,WuKungRoad,NewTaipeiIndustrialPark,WukuDistrict,NewTaipeiCity,Taiwan24803/新北市五股區新北產業園區五工路 134 號

台灣檢驗科技股份有限公司

t (886-2) 2299-3279

f (886-2) 2298-0488

www.tw.sgs.com

Member of SGS Group

Radar Type 5 for 802.11ac80 5530 MHz

Waveform Num =		26								
Num of Bursts =		13								
Burst Interval (us) =		923077								
Burst #	OffTime (us)	# Pulses	Chirp (MHz)	PW (us)	Pulse1 Pri(us)	Pulse2 Pri(us)	Pulse3 Pri(us)	StartLoc (us)	StartBurst Interval(us)	EndBurst Interval(us)
1	304558	3	17	100	1143	1667	1529	304558	0	923076
2	711516	3	12	50	1521	1478	1318	1020413	923077	1846153
3	1023851	2	19	100	1433	1011	0	2048581	1846154	2769230
4	1343958	3	6	60	1128	1014	1824	3394983	2769231	3692307
5	379083	1	14	100	1650	0	0	3778032	3692308	4615384
6	1725272	3	11	70	1298	1046	1854	5504954	4615385	5538461
7	53109	3	8	65	1156	1019	1353	5562261	5538462	6461538
8	1209150	3	15	50	1175	1617	1914	6774939	6461539	7384615
9	1122165	2	7	75	1970	1578	0	7901810	7384616	8307692
10	977618	1	6	85	1257	0	0	8882976	8307693	9230769
11	791018	1	13	70	1852	0	0	9675251	9230770	10153846
12	499478	1	14	70	1538	0	0	10176581	10153847	11076923
13	960393	3	19	80	1533	1326	1187	11138512	11076924	12000000
Total	number	of	pulses	in	waveform	=	29			

Radar Type 5 for 802.11ac80 5530 MHz

Waveform Num =		27								
Num of Bursts =		10								
Burst Interval (us) =		1200000								
Burst #	OffTime (us)	# Pulses	Chirp (MHz)	PW (us)	Pulse1 Pri(us)	Pulse2 Pri(us)	Pulse3 Pri(us)	StartLoc (us)	StartBurst Interval(us)	EndBurst Interval(us)
1	1181227	2	10	100	1190	1123	0	1181227	0	1199999
2	968201	2	14	95	1374	1025	0	2151741	1200000	2399999
3	567441	1	17	75	1790	0	0	2721581	2400000	3599999
4	1291984	2	6	95	1338	1707	0	4015355	3600000	4799999
5	1700509	2	19	90	1362	1329	0	5718909	4800000	5999999
6	1138064	2	20	65	1471	1404	0	6859664	6000000	7199999
7	551421	3	18	85	1135	1100	1935	7413960	7200000	8399999
8	1684929	2	10	70	1375	1100	0	9103059	8400000	9599999
9	701223	3	19	70	1298	1374	1515	9806757	9600000	10799999
10	2048455	2	18	50	1893	1515	0	11859399	10800000	11999999
Total	number	of	pulses	in	waveform	=	21			

Unless otherwise stated the results shown in this test report refer only to the sample(s) tested and such sample(s) are retained for 90 days only.

除非另有說明，此報告結果僅對測試之樣品負責，同時此樣品僅保留90天。本報告未經本公司書面許可，不可部份複製。

This document is issued by the Company subject to its General Conditions of Service printed overleaf, available on request or accessible at www.sgs.com/terms_and_conditions.htm and, for electronic format documents, subject to Terms and Conditions for Electronic Documents at www.sgs.com/terms_e-document.htm. Attention is drawn to the limitation of liability, indemnification and jurisdiction issues defined therein. Any holder of this document is advised that information contained hereon reflects the Company's findings at the time of its intervention only and within the limits of Client's instructions, if any. The Company's sole responsibility is to its Client and this document does not exonerate parties to a transaction from exercising all their rights and obligations under the transaction documents. This document cannot be reproduced except in full, without prior written approval of the Company. Any unauthorized alteration, forgery or falsification of the content or appearance of this document is unlawful and offenders may be prosecuted to the fullest extent of the law.

SGS Taiwan Ltd.

No.134,WuKungRoad,NewTaipeiIndustrialPark,WukuDistrict,NewTaipeiCity,Taiwan24803/新北市五股區新北產業園區五工路 134 號

台灣檢驗科技股份有限公司

t (886-2) 2299-3279

f (886-2) 2298-0488

www.tw.sgs.com

Member of SGS Group

Radar Type 5 for 802.11ac80 5530 MHz

Waveform Num = 28										
Num of Bursts = 15										
Burst Interval (us) = 800000										
Burst #	OffTime (us)	# Pulses	Chirp (MHz)	PW (us)	Pulse1 Pri(us)	Pulse2 Pri(us)	Pulse3 Pri(us)	StartLoc (us)	StartBurst Interval(us)	EndBurst Interval(us)
1	394750	2	10	50	1082	1763	0	394750	0	799999
2	505869	3	20	85	1895	1930	1064	903464	800000	1599999
3	1201577	3	6	85	1863	1905	1068	2109930	1600000	2399999
4	434555	3	13	100	1689	1765	1280	2549321	2400000	3199999
5	1121130	1	19	65	1528	0	0	3675185	3200000	3999999
6	1065785	3	11	85	1581	1740	1151	4742498	4000000	4799999
7	203676	2	10	80	1095	1139	0	4950646	4800000	5599999
8	1192552	3	16	60	1375	1546	1599	6145432	5600000	6399999
9	658673	3	10	65	1947	1742	1094	6808625	6400000	7199999
10	686747	3	15	70	1637	1748	1910	7500155	7200000	7999999
11	760999	3	20	60	1528	1290	1948	8266449	8000000	8799999
12	866148	2	13	80	1422	1631	0	9137363	8800000	9599999
13	605692	3	20	55	1527	1784	1930	9746108	9600000	10399999
14	1119773	1	14	95	1741	0	0	10871122	10400000	11199999
15	680883	2	15	95	1515	1842	0	11553746	11200000	11999999
Total	number	of	pulses	in	waveform	=	37			

Unless otherwise stated the results shown in this test report refer only to the sample(s) tested and such sample(s) are retained for 90 days only.

除非另有說明，此報告結果僅對測試之樣品負責，同時此樣品僅保留90天。本報告未經本公司書面許可，不可部份複製。

This document is issued by the Company subject to its General Conditions of Service printed overleaf, available on request or accessible at www.sgs.com/terms_and_conditions.htm and, for electronic format documents, subject to Terms and Conditions for Electronic Documents at www.sgs.com/terms_e-document.htm. Attention is drawn to the limitation of liability, indemnification and jurisdiction issues defined therein. Any holder of this document is advised that information contained hereon reflects the Company's findings at the time of its intervention only and within the limits of Client's instructions, if any. The Company's sole responsibility is to its Client and this document does not exonerate parties to a transaction from exercising all their rights and obligations under the transaction documents. This document cannot be reproduced except in full, without prior written approval of the Company. Any unauthorized alteration, forgery or falsification of the content or appearance of this document is unlawful and offenders may be prosecuted to the fullest extent of the law.

SGS Taiwan Ltd.

No.134,WuKungRoad,NewTaipeiIndustrialPark,WukuDistrict,NewTaipeiCity,Taiwan24803/新北市五股區新北產業園區五工路 134 號

台灣檢驗科技股份有限公司

t (886-2) 2299-3279

f (886-2) 2298-0488

www.tw.sgs.com

Member of SGS Group

Radar Type 5 for 802.11ac80 5530 MHz

Waveform Num =		29								
Num of Bursts =		20								
Burst Interval (us) =		600000								
Burst #	OffTime (us)	# Pulses	Chirp (MHz)	PW (us)	Pulse1 Pri(us)	Pulse2 Pri(us)	Pulse3 Pri(us)	StartLoc (us)	StartBurst Interval(us)	EndBurst Interval(us)
1	480091	3	12	100	1750	1050	1395	480091	0	599999
2	578746	3	12	95	1433	1684	1001	1063032	600000	1199999
3	305072	2	18	100	1540	1445	0	1372222	1200000	1799999
4	439277	3	8	65	1943	1941	1566	1814484	1800000	2399999
5	993317	1	9	70	1072	0	0	2813251	2400000	2999999
6	319565	2	8	100	1277	1454	0	3133888	3000000	3599999
7	579529	1	18	90	1317	0	0	3716148	3600000	4199999
8	902314	1	12	80	1818	0	0	4619779	4200000	4799999
9	207626	3	17	80	1281	1403	1492	4829223	4800000	5399999
10	1069544	2	9	50	1212	1543	0	5902943	5400000	5999999
11	534358	1	13	70	1124	0	0	6440056	6000000	6599999
12	199976	3	6	55	1376	1867	1482	6641156	6600000	7199999
13	896647	3	14	60	1173	1719	1254	7542528	7200000	7799999
14	536315	2	19	65	1854	1548	0	8082989	7800000	8399999
15	531733	3	15	50	1389	1120	1092	8618124	8400000	8999999
16	856734	3	10	60	1860	1291	1899	9478459	9000000	9599999
17	148507	2	15	75	1533	1306	0	9632016	9600000	10199999
18	791490	3	5	80	1061	1415	1523	10426345	10200000	10799999
19	939159	1	16	75	1611	0	0	11369503	10800000	11399999
20	184648	2	20	60	1847	1906	0	11555762	11400000	11999999
Total	number	of	pulses	in	waveform	=	44			

Radar Type 5 for 802.11ac80 5530 MHz

Waveform Num =		30								
Num of Bursts =		11								
Burst Interval (us) =		1090909								
Burst #	OffTime (us)	# Pulses	Chirp (MHz)	PW (us)	Pulse1 Pri(us)	Pulse2 Pri(us)	Pulse3 Pri(us)	StartLoc (us)	StartBurst Interval(us)	EndBurst Interval(us)
1	173191	1	5	85	1766	0	0	173191	0	1090908
2	1331189	2	8	80	1378	1380	0	1506146	1090909	2181817
3	849419	1	20	75	1159	0	0	2358323	2181818	3272726
4	1995045	2	11	55	1772	1740	0	4354527	3272727	4363635
5	1035861	1	11	65	1993	0	0	5393900	4363636	5454544
6	1088144	1	10	80	1562	0	0	6484037	5454545	6545453
7	882286	1	10	75	1988	0	0	7367885	6545454	7636362
8	575618	3	8	70	1839	1875	1266	7945491	7636363	8727271
9	1187954	2	17	70	1780	1789	0	9138425	8727272	9818180
10	1643773	1	15	75	1584	0	0	10785767	9818181	10909089
11	361321	3	20	90	1219	1839	1686	11148672	10909090	11999998
Total	number	of	pulses	in	waveform	=	18			

~ End of Report ~

Unless otherwise stated the results shown in this test report refer only to the sample(s) tested and such sample(s) are retained for 90 days only.

除非另有說明，此報告結果僅對測試之樣品負責，同時此樣品僅保留90天。本報告未經本公司書面許可，不可部份複製。

This document is issued by the Company subject to its General Conditions of Service printed overleaf, available on request or accessible at www.sgs.com/terms_and_conditions.htm and, for electronic format documents, subject to Terms and Conditions for Electronic Documents at www.sgs.com/terms_e-document.htm. Attention is drawn to the limitation of liability, indemnification and jurisdiction issues defined therein. Any holder of this document is advised that information contained hereon reflects the Company's findings at the time of its intervention only and within the limits of Client's instructions, if any. The Company's sole responsibility is to its Client and this document does not exonerate parties to a transaction from exercising all their rights and obligations under the transaction documents. This document cannot be reproduced except in full, without prior written approval of the Company. Any unauthorized alteration, forgery or falsification of the content or appearance of this document is unlawful and offenders may be prosecuted to the fullest extent of the law.

SGS Taiwan Ltd.

No.134,WuKungRoad,NewTaipeiIndustrialPark,WukuDistrict,NewTaipeiCity,Taiwan24803/新北市五股區新北產業園區五工路 134 號

台灣檢驗科技股份有限公司

t (886-2) 2299-3279

f (886-2) 2298-0488

www.tw.sgs.com

Member of SGS Group